

**HDMI**<sup>™</sup>  
HIGH-DEFINITION MULTIMEDIA INTERFACE



E14715

Revised Edition V4 / August 2018

# IN SEARCH OF INCREDIBLE

E-Manual

**ASUS**

## COPYRIGHT INFORMATION

No part of this manual, including the products and software described in it, may be reproduced, transmitted, transcribed, stored in a retrieval system, or translated into any language in any form or by any means, except documentation kept by the purchaser for backup purposes, without the express written permission of ASUSTeK COMPUTER INC. ("ASUS").

ASUS PROVIDES THIS MANUAL "AS IS" WITHOUT WARRANTY OF ANY KIND, EITHER EXPRESS OR IMPLIED, INCLUDING BUT NOT LIMITED TO THE IMPLIED WARRANTIES OR CONDITIONS OF MERCHANTABILITY OR FITNESS FOR A PARTICULAR PURPOSE. IN NO EVENT SHALL ASUS, ITS DIRECTORS, OFFICERS, EMPLOYEES OR AGENTS BE LIABLE FOR ANY INDIRECT, SPECIAL, INCIDENTAL, OR CONSEQUENTIAL DAMAGES (INCLUDING DAMAGES FOR LOSS OF PROFITS, LOSS OF BUSINESS, LOSS OF USE OR DATA, INTERRUPTION OF BUSINESS AND THE LIKE), EVEN IF ASUS HAS BEEN ADVISED OF THE POSSIBILITY OF SUCH DAMAGES ARISING FROM ANY DEFECT OR ERROR IN THIS MANUAL OR PRODUCT.

Products and corporate names appearing in this manual may or may not be registered trademarks or copyrights of their respective companies, and are used only for identification or explanation and to the owners' benefit, without intent to infringe.

SPECIFICATIONS AND INFORMATION CONTAINED IN THIS MANUAL ARE FURNISHED FOR INFORMATIONAL USE ONLY, AND ARE SUBJECT TO CHANGE AT ANY TIME WITHOUT NOTICE, AND SHOULD NOT BE CONSTRUED AS A COMMITMENT BY ASUS. ASUS ASSUMES NO RESPONSIBILITY OR LIABILITY FOR ANY ERRORS OR INACCURACIES THAT MAY APPEAR IN THIS MANUAL, INCLUDING THE PRODUCTS AND SOFTWARE DESCRIBED IN IT.

Copyright © 2018 ASUSTeK COMPUTER INC. All Rights Reserved.

## LIMITATION OF LIABILITY

Circumstances may arise where because of a default on ASUS' part or other liability, you are entitled to recover damages from ASUS. In each such instance, regardless of the basis on which you are entitled to claim damages from ASUS, ASUS is liable for no more than damages for bodily injury (including death) and damage to real property and tangible personal property; or any other actual and direct damages resulted from omission or failure of performing legal duties under this Warranty Statement, up to the listed contract price of each product.

ASUS will only be responsible for or indemnify you for loss, damages or claims based in contract, tort or infringement under this Warranty Statement.

This limit also applies to ASUS' suppliers and its reseller. It is the maximum for which ASUS, its suppliers, and your reseller are collectively responsible.

UNDER NO CIRCUMSTANCES IS ASUS LIABLE FOR ANY OF THE FOLLOWING: (1) THIRD-PARTY CLAIMS AGAINST YOU FOR DAMAGES; (2) LOSS OF, OR DAMAGE TO, YOUR RECORDS OR DATA; OR (3) SPECIAL, INCIDENTAL, OR INDIRECT DAMAGES OR FOR ANY ECONOMIC CONSEQUENTIAL DAMAGES (INCLUDING LOST PROFITS OR SAVINGS), EVEN IF ASUS, ITS SUPPLIERS OR YOUR RESELLER IS INFORMED OF THEIR POSSIBILITY.

## SERVICE AND SUPPORT

Visit our multi-language website at <https://www.asus.com/support/>

# Table of Contents

About this manual.....	7
Conventions used in this manual .....	9
Icons .....	9
Typography.....	9
Safety precautions.....	10
Using your Notebook PC.....	10
Caring for your Notebook PC .....	11
Proper disposal.....	12

## Chapter 1: Hardware Setup

Getting to know your Notebook PC .....	14
Top View.....	14
Bottom.....	18
Right Side .....	22
Left Side .....	24
Front Side .....	26

## Chapter 2: Using your Notebook PC

Getting started .....	30
Charge your Notebook PC.....	30
Lift to open the display panel .....	32
Press the power button.....	32
Using the touchpad .....	33
Setting up your Fingerprint account.....	40
Using the keyboard.....	41
Function keys .....	41
Windows® 10 keys .....	42
Multimedia control keys.....	43
Using the numeric keypad .....	44
Using the optical drive.....	45

## **Chapter 3: Working with Windows® 10**

Starting for the first time.....	50
Start menu .....	51
Windows® apps .....	53
Working with Windows® apps.....	54
Customizing Windows® apps .....	54
Task view.....	57
Snap feature .....	58
Snap hotspots.....	58
Action Center .....	60
Other keyboard shortcuts .....	61
Connecting to wireless networks .....	63
Wi-Fi.....	63
Bluetooth.....	64
Airplane mode .....	65
Connecting to wired networks.....	66
Turning your Notebook PC off.....	68
Putting your Notebook PC to sleep .....	69

## **Chapter 4: Power-On Self-Test (POST)**

The Power-On Self-Test (POST).....	72
Using POST to access BIOS and Troubleshoot.....	72
BIOS .....	72
Accessing BIOS .....	72
BIOS Settings.....	73
Recovering your system.....	80
Performing a recovery option.....	81

## Chapter 5: Upgrading your Notebook PC

Removing the compartment cover.....	84
Installing a RAM module.....	88
Installing the Hard Disk Drive.....	91
Installing an M.2 card.....	116

### Tips and FAQs

Useful tips for your Notebook PC.....	120
Hardware FAQs.....	121
Software FAQs.....	124

### Appendices

DVD-ROM Drive Information.....	128
Blu-ray ROM Drive Information.....	130
Federal Communications Commission Interference Statement.....	131
FCC Radio Frequency (RF) Exposure Caution Statement.....	132
Compliance Statement of Innovation, Science and Economic Development Canada (ISED).....	133
Déclaration de conformité de Innovation, Sciences et Développement économique Canada (ISED).....	133
Caution.....	134
Avertissement.....	134
Wireless Operation Channel for Different Domains.....	135
Power Safety Requirement.....	135
TV Notices.....	135
Macrovision Corporation Product Notice.....	135

UL Safety Notices.....	136
Nordic Lithium Cautions (for lithium-ion batteries).....	137
Optical Drive Safety Information .....	138
ENERGY STAR complied product .....	139
Global Environmental Regulation Compliance and Declaration .....	139
ASUS Recycling/Takeback Services.....	140
Rechargeable Battery Recycling Service in North America.....	140
Coating Notice.....	140
Regional notice for California.....	140
Regional notice for Singapore .....	141
REACH.....	141
Prevention of Hearing Loss.....	141
National Telecommunications Commission of the Philippines .....	141
Change of Address Notification .....	142

# About this manual

This manual provides information about the hardware and software features of your Notebook PC, organized through the following chapters:

## **Chapter 1: Hardware Setup**

This chapter details the hardware components of your Notebook PC.

## **Chapter 2: Using your Notebook PC**

This chapter shows you how to use the different parts of your Notebook PC.

## **Chapter 3: Working with Windows® 10**

This chapter provides an overview of using Windows® 10 in your Notebook PC.

## **Chapter 4: Power-On Self-Test (POST)**

This chapter shows you how to use POST to change the settings of your Notebook PC.

## **Chapter 5: Upgrading your Notebook PC**

This chapter guides you through the process of replacing and upgrading parts of your Notebook PC.

### **Tips and FAQs**

This section presents some recommended tips, hardware FAQs, and software FAQs you can refer to for maintaining and fixing common issues with your Notebook PC.

### **Appendices**

This section includes notices and safety statements for your Notebook PC.



## Conventions used in this manual

To highlight key information in this manual, some text are presented as follows:

---

**IMPORTANT!** This message contains vital information that must be followed to complete a task.

---

---

**NOTE:** This message contains additional information and tips that can help complete tasks.

---

---

**WARNING!** This message contains important information that must be followed to keep you safe while performing tasks and prevent damage to your Notebook PC's data and components.

---

## Icons

The icons below indicate the devices you can use for completing a series of tasks or procedures on your Notebook PC.



= Use the touchpad.



= Use the keyboard.

## Typography

**Bold** = This indicates a menu or an item that must be selected.

*Italic* = This indicates sections that you can refer to in this manual.

# Safety precautions

## Using your Notebook PC



This Notebook PC should only be used in environments with ambient temperatures between 5°C (41°F) and 35°C (95°F).



Refer to the rating label on the bottom of your Notebook PC and ensure that your power adapter complies with this rating.



Do not leave your Notebook PC on your lap or near any part of your body to prevent discomfort or injury from heat exposure.



Do not use damaged power cords, accessories, and other peripherals with your Notebook PC.



While powered on, ensure that you do not carry or cover your Notebook PC with any materials that can reduce air circulation.



Do not place your Notebook PC on uneven or unstable work surfaces.



You can send your Notebook PC through x-ray machines (used on items placed on conveyor belts), but do not expose them to magnetic detectors and wands.



Contact your airline provider to learn about related in-flight services that can be used and restrictions that must be followed when using your Notebook PC in-flight.

## Caring for your Notebook PC



Disconnect the AC power and remove the battery pack (if applicable) before cleaning your Notebook PC. Use a clean cellulose sponge or chamois cloth dampened with a solution of nonabrasive detergent and a few drops of warm water. Remove any extra moisture from your Notebook PC using a dry cloth.



Do not use strong solvents such as thinners, benzene, or other chemicals on or near your Notebook PC.



Do not place objects on top of your Notebook PC.



Do not expose your Notebook PC to strong magnetic or electrical fields.



Do not use or expose your Notebook PC near liquids, rain, or moisture.



Do not expose your Notebook PC to dusty environments.



Do not use your Notebook PC near gas leaks.

## Proper disposal



Do not throw your Notebook PC in municipal waste. This product has been designed to enable proper reuse of parts and recycling. The symbol of the crossed out wheeled bin indicates that the product (electrical, electronic equipment and mercury-containing button cell battery) should not be placed in municipal waste. Check local regulations for disposal of electronic products.



Do not throw the battery in municipal waste. The symbol of the crossed out wheeled bin indicates that the battery should not be placed in municipal waste.

# ***Chapter 1:*** ***Hardware Setup***

# Getting to know your Notebook PC

## Top View

**NOTE:** The keyboard's layout may vary per region or country. The Notebook view may also vary in appearance depending on the Notebook PC model.

### 14" model

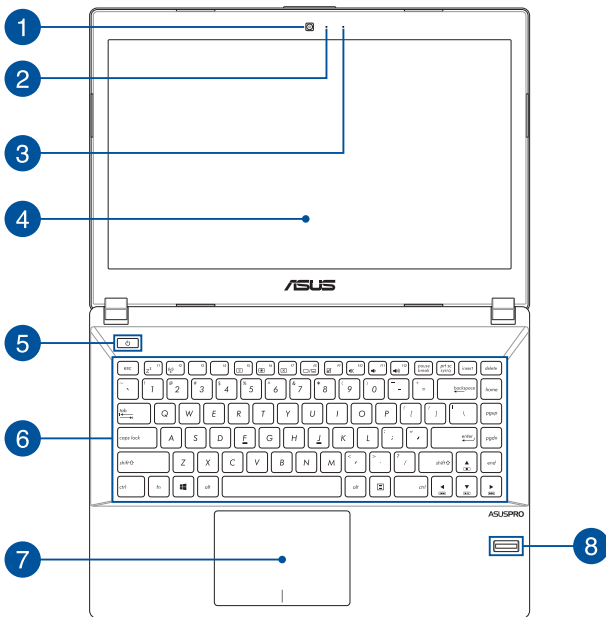

## 15.6" model

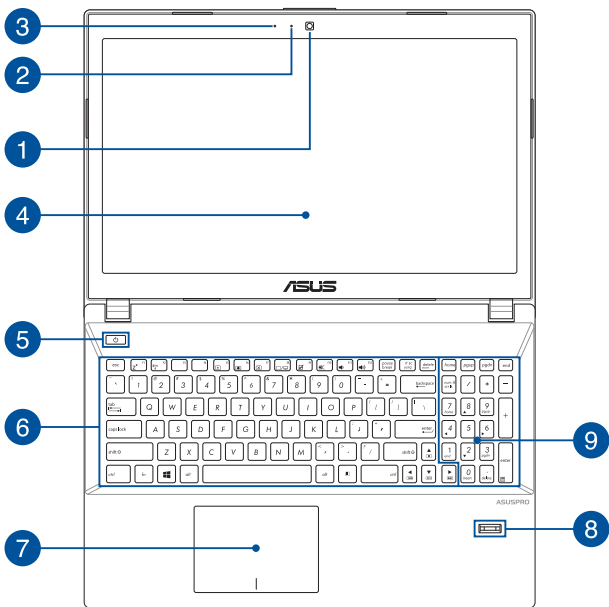

- 1 Camera**

The built-in camera allows you to take pictures or record videos using your Notebook PC.
- 2 Camera indicator**

The camera indicator lights up when the built-in camera is in use.
- 3 Microphone**

The built-in microphone can be used for video conferencing, voice narrations, or simple audio recording.
- 4 Display panel**

This high-definition display panel provides excellent viewing features for photos, videos, and other multimedia files on your Notebook PC.
- 5 Power button**

Press the power button to turn your Notebook PC on or off. You can also use the power button to put your Notebook PC to sleep or hibernate mode and wake it up from sleep or hibernate mode.

In the event that your Notebook PC becomes unresponsive, press and hold the power button for at least four (4) seconds until your Notebook PC shuts down.



## 6 Keyboard

The keyboard provides full-sized QWERTY keys with a comfortable travel depth for typing. It also enables you to use the function keys, allows quick access to Windows®, and controls other multimedia functions.

---

**NOTE:** The keyboard layout differs by model or territory.

---

## 7 Touchpad

The touchpad allows the use of multi-gestures to navigate onscreen, providing an intuitive user experience. It also simulates the functions of a regular mouse.

---

**NOTE:** For more details, refer to the *Using the touchpad* section in this manual.

---

## 8 Fingerprint sensor

This built-in fingerprint sensor captures your fingerprint and uses it as biometric authentication for logging on to your Notebook PC's system.

---

**NOTE:** For more details, refer to the *Setting up your Fingerprint account* section in this manual.

---

## 9 Numeric keypad (on selected models)

The numeric keypad toggles between these two functions: for numeric input and as pointer direction keys.

---

**NOTE:** For more details, refer to the *Using the numeric keypad* section in this manual.

---

## Bottom

---

**NOTE:** The bottom side may vary in appearance depending on model.

---

**WARNING!** The bottom of the Notebook PC can get warm to hot while in use or while charging the battery pack. When working on your Notebook PC, do not place it on surfaces that can block the vents.

---

### **IMPORTANT!**

- Battery time varies by usage and by the specifications for this Notebook PC. The battery pack cannot be disassembled.
  - Purchase components from authorized retailers to ensure maximum compatibility and reliability. Consult an ASUS service center or authorized retailers for product service or assistance on proper disassembly or assembly of the product.
-

## 14" model

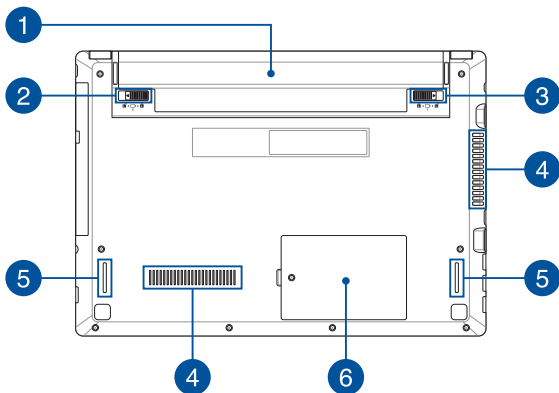

## 15.6" model

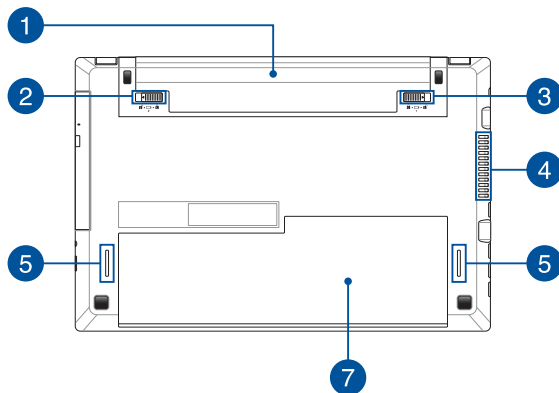

### 1 **Battery pack**

The battery pack is automatically charged when your Notebook PC is connected to a power source. When charged, the battery pack supplies power to your Notebook PC.

### 2 **Spring battery lock**

The spring battery lock automatically locks the battery pack in place once it is inserted into the battery slot.

---

**IMPORTANT!** This lock should be held in an unlocked position when removing the battery pack.

---

### 3 **Manual battery lock**

The manual battery lock is used to keep the battery pack secured. This lock should be manually moved to a locked or unlocked position to insert or remove the battery pack.

### 4 **Air vents**

The air vents allow cool air to enter and warm air to exit the Notebook PC.

---

**WARNING!** Ensure that paper, books, clothing, cables, or other objects do not block any of the air vents or else overheating may occur.

---

## 5 Audio speakers

The built-in audio speakers allow you to hear audio straight from your Notebook PC. Audio features are software-controlled.

## 6 Compartment cover

This cover protects the reserved spaces in your Notebook PC for the removable NVMe SSD (M.2 2280 slot) and RAM (Random Access Memory) modules.

---

**NOTE:**

- For more details, refer to the *Chapter 5: Upgrading your Notebook PC* section in this E-Manual.
  - The M.2 2280 slot does not support M.2 PCIe SSD.
- 

## 7 Compartment cover

This cover protects the reserved spaces in your Notebook PC for the removable HDD (Hard Disk Drive) and RAM (Random Access Memory) modules.

---

**NOTE:** For more details, refer to the *Chapter 5: Upgrading your Notebook PC* section in this E-Manual.

---

## Right Side

---

**NOTE:** The right side may vary in appearance depending on model.

---

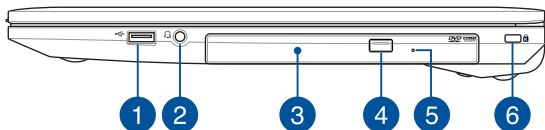

### 1 USB 2.0 port

The USB (Universal Serial Bus) port is compatible with USB 2.0 or USB 1.1 devices such as keyboards, pointing devices, flash disk drives, external HDDs, speakers, cameras and printers.

### 2 Headphone/Headset jack

This port allows you to connect amplified speakers or headphones. You can also use this port to connect your headset.

---

**NOTE:** This port does not support three-conductor 3.5 mm microphones.

---

### 3 Optical drive (on selected models)

Your Notebook PC's optical drive may support several disc formats such as CDs, DVDs, recordable discs, or rewritable discs.

#### 4 Optical disc drive eject button

Press this button to eject the optical drive tray.

#### 5 Optical disc drive manual eject hole

The manual eject hole is used to eject the drive tray in case the electronic eject button does not work.

---

**WARNING!** Use the manual eject hole only when the electronic eject button does not work.

---

---

**NOTE:** For more details, refer to the *Using the optical drive* section in this manual.

---

#### 6 Kensington® security slot

The Kensington® security slot allows you to secure your Notebook PC using Kensington® compatible Notebook PC security products.

## Left Side

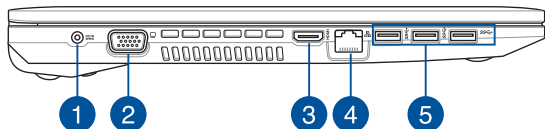

### 1 Power (DC) input port

Insert the bundled power adapter into this port to charge the battery pack and supply power to your Notebook PC.

---

**WARNING!** The adapter may become warm to hot while in use. Do not cover the adapter and keep it away from your body while it is connected to a power source.

---

---

**IMPORTANT!** Use only the bundled power adapter to charge the battery pack and supply power to your Notebook PC.

---

### 2 VGA port

This port allows you to connect your Notebook PC to an external display.



### **3 HDMI port**

This port is for the HDMI (High-Definition Multimedia Interface) connector and is HDCP compliant for HD DVD, Blu-ray, and other protected content playback.

### **4 LAN port**

Insert the network cable into this port to connect to a local area network.

### **5 USB 3.1 Gen 1 port**

The USB 3.1 (Universal Serial Bus 3.1) Gen 1 port provides a transfer rate of up to 5 Gbit/s and is backward compatible to USB 2.0.

## Front Side

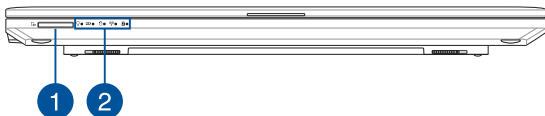

### 1 Memory card reader

This built-in memory card reader supports SD and SDHC card formats.

### 2 Status indicators

The status indicators help identify the current hardware status of your Notebook PC.



#### Power indicator

The power indicator lights up when the Notebook PC is turned on and blinks slowly when the Notebook PC is in sleep mode.

#### Two-color battery charge indicator

The two-color LED provides a visual indication of the battery's charge status. Refer to the following table for details:

Color	Status
<b>Solid Green</b>	The Notebook PC is plugged to a power source and the battery power is between 95% and 100%.
<b>Solid Orange</b>	The Notebook PC is plugged to a power source, charging its battery, and the battery power is less than 95%.
<b>Blinking Orange</b>	The Notebook PC is running on battery mode and the battery power is less than 10%.
<b>Lights off</b>	The Notebook PC is running on battery mode and the battery power is between 10% to 100%.



#### **Drive activity indicator**

This indicator lights up when your Notebook PC is accessing the internal storage drives.



#### **Bluetooth/Wireless indicator**

This indicator lights up when your Notebook PC's wireless function (Bluetooth or Wi-Fi) is enabled.



#### **Capital lock indicator**

This indicator lights up when the capital lock function is activated. Using capital lock allows you to type capitalized letters (such as A, B, C) using your Notebook PC's keyboard.



## ***Chapter 2:*** ***Using your Notebook PC***

# Getting started

## Charge your Notebook PC

- Connect the AC power cord to the AC/DC adapter.
- Connect the DC power connector into your Notebook PC's power (DC) input port.
- Plug the AC power adapter into a 100V~240V power source.



Charge the Notebook PC for **3 hours** before using it in battery mode for the first time.

---

**NOTE:** The power adapter may vary in appearance, depending on models and your region.

---

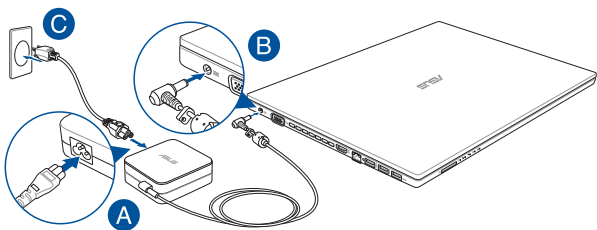

---

### IMPORTANT!

Power adapter information:

- Input voltage: 100-240Vac
  - Input frequency: 50-60Hz
  - Rating output current: 3.42A (65W)
  - Rating output voltage: 19V
-

---

**IMPORTANT!**

- Locate the input/output rating label on your Notebook PC and ensure that it matches the input/output rating information on your power adapter. Some Notebook PC models may have multiple rating output currents based on the available SKU.
  - Ensure that your Notebook PC is connected to the power adapter before turning it on for the first time. We strongly recommend that you use a grounded wall socket while using your Notebook PC on power adapter mode.
  - The socket outlet must be easily accessible and near your Notebook PC.
  - To disconnect your Notebook PC from its main power supply, unplug your Notebook PC from the power socket.
- 

**WARNING!**

Read the following precautions for your Notebook PC's battery:

- Only ASUS-authorized technicians should remove the battery inside the device (for non-removable battery only).
  - The battery used in this device may present a risk of fire or chemical burn if removed or disassembled.
  - Follow the warning labels for your personal safety.
  - Risk of explosion if battery is replaced by an incorrect type.
  - Do not dispose of in fire.
  - Never attempt to short-circuit your Notebook PC's battery.
  - Never attempt to disassemble and reassemble the battery (for non-removable battery only).
  - Discontinue usage if leakage is found.
  - The battery and its components must be recycled or disposed of properly.
  - Keep the battery and other small components away from children.
-

## Lift to open the display panel

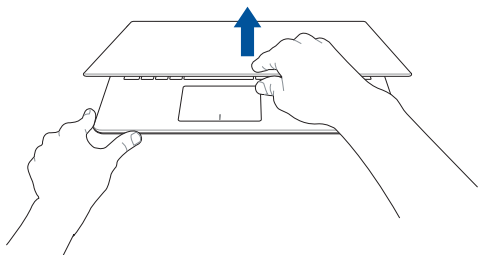

## Press the power button

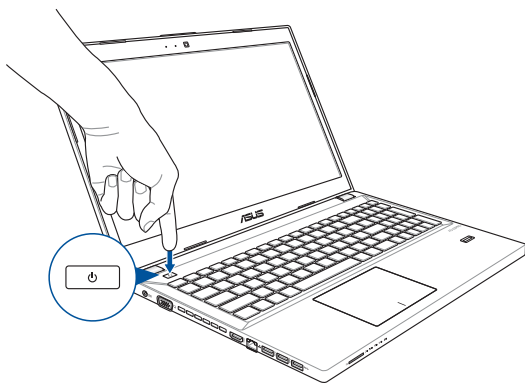



# Using the touchpad

## Moving the pointer

You can tap anywhere on the touchpad to activate its pointer, then slide your finger on the touchpad to move the pointer onscreen.

### Slide horizontally

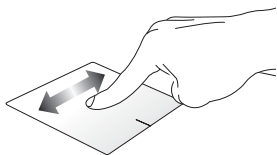

### Slide vertically

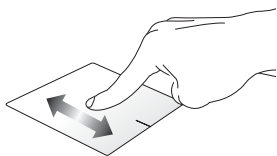

### Slide diagonally

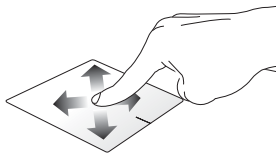

## One-finger gestures

### Tap/Double-tap

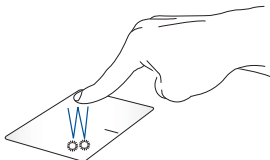

- Tap an app to select it.
- Double-tap an app to launch it.

### Drag and drop

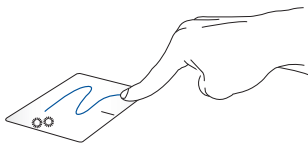

Double-tap an item, then slide the same finger without lifting it off the touchpad. To drop the item to its new location, lift your finger from the touchpad.

## Left-click

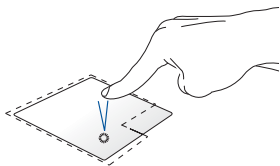

## Right-click

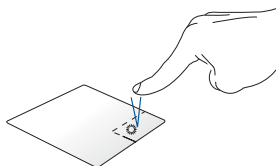

- Click an app to select it.
- Double-click an app to launch it.

Click this button to open the right-click menu.

---

**NOTE:** The areas inside the dotted line represent the locations of the left mouse button and the right mouse button on the touchpad.

---

## Two-finger gestures

### Tap

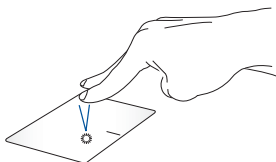

Tap two fingers on the touchpad to simulate the right-click function.

### Two-finger scroll (up/down)

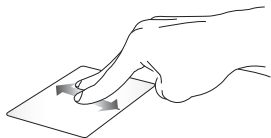

Slide two fingers to scroll up or down.

### Two-finger scroll (left/right)



Slide two fingers to scroll left or right.

### Zoom out



Bring together your two fingers on the touchpad.

### Zoom in

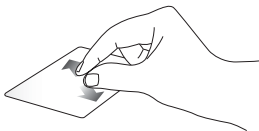

Spread apart your two fingers on the touchpad.

## Drag and drop

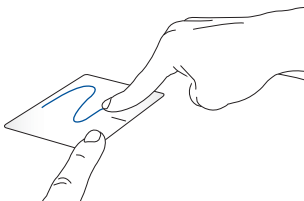

Select an item then press and hold the left button. Using your other finger, slide on the touchpad to drag the item, lift your finger off the button to drop the item.

## Three-finger gestures

### Tap

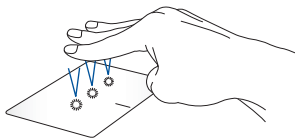

Tap three fingers on the touchpad to invoke Cortana.

## Swipe left/Swipe right



If you opened multiple apps, swipe three fingers left or right to switch between these apps.

## Swipe up



Swipe up to see an overview of all the apps currently opened.

## Swipe down

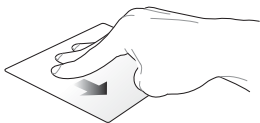

Swipe down to show the desktop.

## Four-finger gestures

### Tap

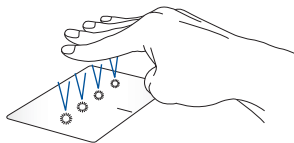

Tap four fingers on the touchpad to invoke Action Center.

## Customizing your touchpad

1. Launch **All settings** from the Action Center.
2. Select **Devices**, then select **Mouse & touchpad**.
3. Adjust the settings to your preference.

## Setting up your Fingerprint account

1. Launch the Start menu.
2. Click/Tap **Settings** and select **Accounts**.
3. Select the **Sign-in options** tab on the left side and click/tap **Set up** under Fingerprint of Windows Hello.

---

### IMPORTANT!

- You must add a password before you can use the other sign-in options.
  - You must set up a PIN before you can enroll in Windows Hello.
- 

4. Click/Tap **Get started** in the prompt screen and enter your PIN for verification.
5. Follow the onscreen instructions to set up your Fingerprint account.

---

**NOTE:** Press and lift the same finger repeatedly, making small adjustments to the position of your finger each time until the scan is complete.

---

6. Click/Tap **Add another** if you wish to add another Fingerprint account.
7. When finished, click/tap **Close**.



# Using the keyboard

## Function keys

The function keys on your Notebook PC's keyboard can trigger the following commands:



Puts the Notebook PC into **Sleep mode**



Turns **Airplane mode** on or off

---

**NOTE:** When enabled, the **Airplane mode** disables all wireless connectivity.

---



Decreases display brightness



Increases display brightness



Turns the display panel on or off







Toggles the display mode



---



**NOTE:** Ensure that the second display is connected to your Notebook PC.

---

 +  Enables or disables the touchpad

 +  Turns the speaker on or off

 +  Turns the speaker volume down

 +  Turns the speaker volume up

## Windows® 10 keys

There are two special Windows® keys on your Notebook PC's keyboard used as below:

 Launches the Start menu

 Displays the drop-down menu

## Multimedia control keys

The multimedia control keys allow you to control multimedia files, such as audios and videos, when played in your Notebook PC.

Press  in combination with the arrow keys on your Notebook PC, illustrated as below.

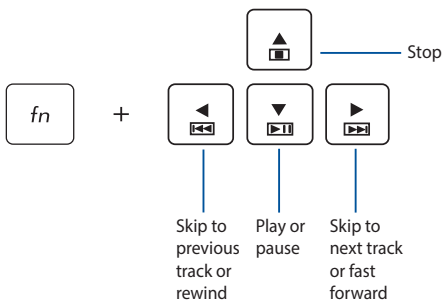

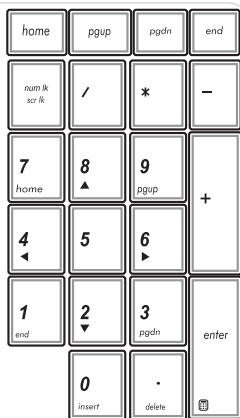

## Using the numeric keypad

**NOTE:** The numeric keypad layout may differ by model or territory but the usage procedures remain the same.



A numeric keypad is available on selected Notebook PC models. You can use this keypad for numeric input or as pointer direction keys.



Press  + 

to toggle between using the keypad as number keys or as pointer direction keys.

# Using the optical drive

---

## NOTE:

- The actual location of the electronic eject button may vary depending on your Notebook PC model.
  - The actual appearance of the Notebook PC optical drive may also vary depending on model but usage procedures remain the same.
- 

## Inserting an optical disc

1. While the Notebook PC is on, press the electronic eject button to partially eject the optical drive tray.

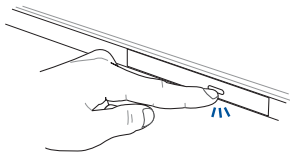

2. Gently pull out the drive tray.

---

**IMPORTANT!** Be careful not to touch the optical drive lens. Ensure that there are no objects that may get jammed under the drive tray.

---

3. Hold the disc by the edge with its printed side up, then gently place it inside the hub.

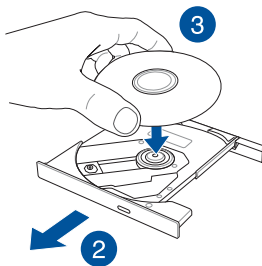

4. Push down the disc's plastic hub until it snaps onto the optical drive hub.

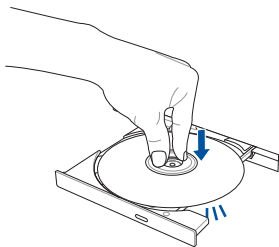

5. Push the drive tray gently to close the optical drive.

---

**NOTE:** While data is being read, it is normal to hear some spinning and vibrating in the optical drive.

---

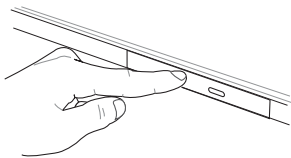

## Using the manual eject hole

The manual eject hole is located on the optical drive door and is used to eject the optical drive tray in case the electronic eject button does not work.

To manually eject the optical drive tray, insert a straightened paper clip into the manual eject hole until the drive tray opens.

---

**WARNING!** Use the manual eject hole only when the electronic eject button does not work.

---





# ***Chapter 3:*** ***Working with Windows® 10***

# Starting for the first time

When you start your Notebook PC for the first time, a series of screens appear to guide you in configuring your Windows® 10 operating system.

To start your Notebook PC for the first time:

1. Press the power button on your Notebook PC. Wait for a few minutes until the setup screen appears.
2. From the setup screen, pick your region and a language to use on your Notebook PC.
3. Carefully read the License Terms. Select **I accept**.
4. Follow the onscreen instructions to configure the following basic items:
  - Personalize
  - Get online
  - Settings
  - Your account
5. After configuring the basic items, Windows® 10 proceeds to install your apps and preferred settings. Ensure that your Notebook PC is kept powered on during the setup process.
6. Once the setup process is complete, the Desktop appears.

---

**NOTE:** The screenshots in this chapter are for reference only.

---

# Start menu

The Start menu is the main gateway to your Notebook PC's programs, Windows® apps, folders, and settings.

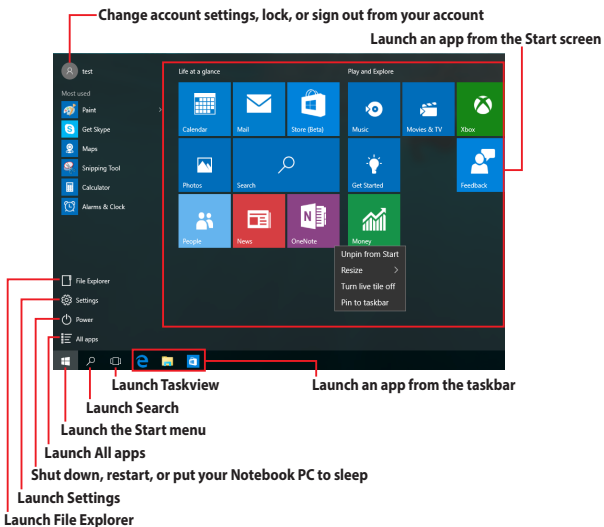

You can use the Start menu to do these common activities:

- Start programs or Windows® apps
- Open commonly used programs or Windows® apps
- Adjust Notebook PC settings
- Get help with the Windows operating system
- Turn off your Notebook PC
- Log off from Windows or switch to a different user account

## Launching the Start menu



Position your mouse pointer over the Start button  in the lower-left corner of your desktop then click it.



Press the Windows logo key  on your keyboard.

## Opening programs from the Start menu

One of the most common uses of the Start menu is opening programs installed on your Notebook PC.



Position your mouse pointer over the program then click to launch it.



Use the arrow keys to browse through the programs.  
Press  to launch it.

---

**NOTE:** Select **All apps** at the bottom of the left pane to display a full list of programs and folders on your Notebook PC in alphabetical order.

---

# Windows® apps

These are apps pinned on the right pane of the Start menu and displayed in tiled-format for easy access.

---

**NOTE:** Some Windows® apps require signing in to your Microsoft account before they are fully launched.

---

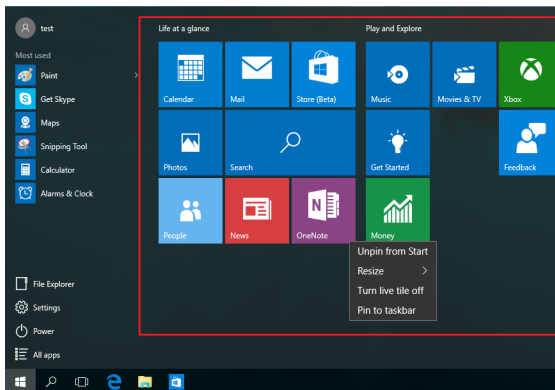

## Working with Windows® apps

Use your Notebook PC's touchpad or keyboard to launch, customize, and close apps.

### Launching Windows® apps from the Start menu



Position your mouse pointer over the app then click to launch it.



Use the arrow keys to browse through the apps. Press



to launch an app.

## Customizing Windows® apps

You can move, resize, unpin, or pin apps to the taskbar from the Start menu using the following steps:

### Moving apps



Position your mouse pointer over the app, then drag and drop the app to a new location.

## Resizing apps



Position your mouse pointer over the app and right-click it, then click **Resize** and select an app tile size.



Use the arrow keys to navigate to the app.

Press  or  +  (on selected models), then select **Resize** and select an app tile size.

## Unpinning apps



Position your mouse pointer over the app and right-click it, then click **Unpin from Start**.



Use the arrow keys to navigate to the app.

Press  or  +  (on selected models), then select **Unpin from Start**.

## Pinning apps to the taskbar



Position your mouse pointer over the app and right-click it, then click **Pin to taskbar**.



Use the arrow keys to navigate to the app.

Press  or  +  (on selected models), then select **Pin to taskbar**.

## Pinning more apps to the Start menu



From **All apps**, position your mouse pointer over the app you want to add to the Start menu and right-click it, then click **Pin to Start**.



From **All apps**, press  or  +  (on selected models) on the app that you want to add to the Start menu, then select **Pin to Start**.



# Task view

Quickly switch between opened apps and programs using the task view feature, you can also use task view to switch between desktops.

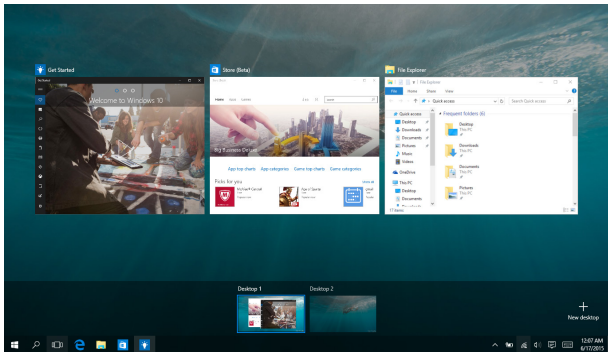

## Launching task view



Position your mouse pointer over the  icon on the taskbar and click it.



Press  +  on your keyboard.

# Snap feature

The Snap feature displays apps side-by-side, allowing you to work or switch between apps.

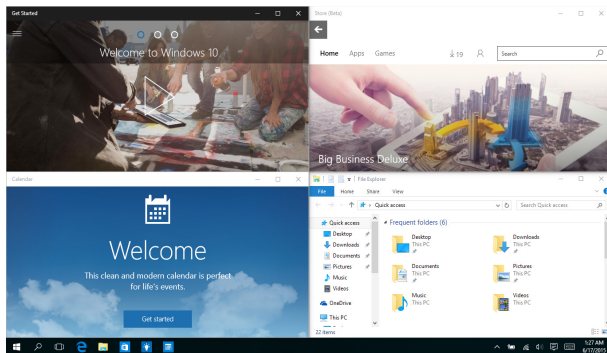

# Snap hotspots

You can drag and drop apps to these hotspots to snap them into place.

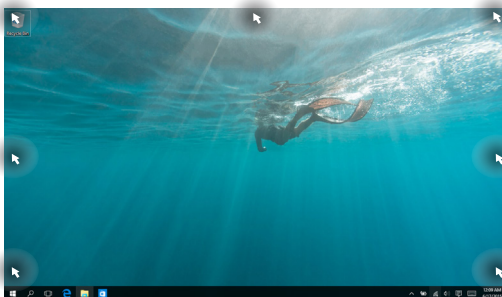

## Using Snap



1. Launch the app you wish to snap.
2. Drag the title bar of your app and drop the app to the edge of the screen to snap.
3. Launch another app and repeat the above steps to snap another app.



1. Launch the app you wish to snap.
2. Press and hold the  key, then use the arrow keys to snap the app.
3. Launch another app and repeat the above steps to snap another app.

# Action Center

Action Center consolidates notifications from apps and presents a single place where you can interact with them. It also has a really useful Quick Actions section at the bottom.

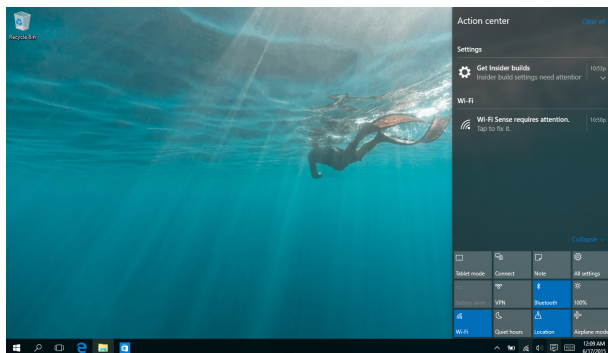

## Launching Action Center



Position your mouse pointer over the  icon on the taskbar and click it.



Press  +  on your keyboard.

## Other keyboard shortcuts

Using the keyboard, you can also use the following shortcuts to help you launch applications and navigate Windows® 10.



Launches **Start menu**



Launches **Action Center**



Launches the desktop



Launches the **File Explorer**



Opens the **Share** panel



Launches **Settings**



Launches **Connect** panel



Activates the Lock screen



Minimizes all currently active windows



Launches **Search**



Launches **Project** panel



Opens the **Run** window



Opens **Ease of Access Center**



Opens the context menu of the Start button



Launches the magnifier icon and zooms in your screen



Zooms out your screen



Opens **Narrator Settings**

# Connecting to wireless networks

## Wi-Fi

Access emails, surf the Internet, and share applications via social networking sites using your Notebook PC's Wi-Fi connection.

---



**IMPORTANT! Airplane mode** disables this feature. Ensure that **Airplane mode** is turned off before enabling the Wi-Fi connection of your Notebook PC.

---

## Connecting Wi-Fi

Connect your Notebook PC to a Wi-Fi network by using the following steps:



1. Select the  icon from the taskbar.
2. Select the  icon to enable Wi-Fi.
3. Select an access point from the list of available Wi-Fi connections.
4. Select **Connect** to start the network connection.

---

**NOTE:** You may be prompted to enter a security key to activate the Wi-Fi connection.

---

## Bluetooth

Use Bluetooth to facilitate wireless data transfers with other Bluetooth-enabled devices.

---

**IMPORTANT! Airplane mode** disables this feature. Ensure that **Airplane mode** is turned off before enabling the Bluetooth connection of your Notebook PC.

---

### Pairing with other Bluetooth-enabled devices

You need to pair your Notebook PC with other Bluetooth-enabled devices to enable data transfers. Connect your devices by using the following steps:



1. Launch **Settings** from the Start menu.
2. Select **Devices**, then select **Bluetooth** to search for Bluetooth-enabled devices.
3. Select a device from the list. Compare the passcode on your Notebook PC with the passcode sent to your chosen device. If they are the same, select **Yes** to successfully pair your Notebook PC with the device.

---

**NOTE:** For some Bluetooth-enabled devices, you may be prompted to key in the passcode of your Notebook PC.

---



## Airplane mode

Airplane mode disables wireless communication, allowing you to use your Notebook PC safely while in-flight.

---

**NOTE:** Contact your airline provider to learn about related in-flight services that can be used and restrictions that must be followed when using your Notebook PC in-flight.



---

### Turning Airplane mode on



1. Launch **Action Center** from the taskbar.
2. Select the  icon to enable Airplane mode.





Press  + .

### Turning Airplane mode off



1. Launch **Action Center** from the taskbar.
2. Select the  icon to disable Airplane mode.



Press  + .

## Connecting to wired networks

You can also connect to wired networks, such as local area networks and broadband Internet connection, using your Notebook PC's LAN port.

---

**NOTE:** Contact your Internet Service Provider (ISP) for details or your network administrator for assistance in setting up your Internet connection.

---

To configure your settings, refer to the following procedures.

---

**IMPORTANT!** Ensure that a network cable is connected between your Notebook PC's LAN port and a local area network before performing the following actions.

---

### Configuring a dynamic IP/PPPoE network connection



1. Launch **Settings**.
2. Select **Network & Internet**.
3. Select **Ethernet > Network and Sharing Center**.
4. Select your LAN then select **Properties**.
5. Select **Internet Protocol Version 4 (TCP/IPv4)** then select **Properties**.
6. Select **Obtain an IP address automatically** then select **OK**.

---

**NOTE:** Proceed to the next steps if you are using PPPoE connection.

---

7. Return to the **Network and Sharing Center** window then select **Set up a new connection or network**.
8. Select **Connect to the Internet** then select **Next**.
9. Select **Broadband (PPPoE)**.
10. Type your User name, Password, and Connection name then select **Connect**.
11. Select **Close** to finish the configuration.
12. Select  on the taskbar then select the connection you just created.
13. Type your user name and password then select **Connect** to start connecting to the Internet.

## Configuring a static IP network connection





1. Repeat steps 1 to 5 under *Configuring a dynamic IP/PPPoE network connection*.
2. Select **Use the following IP address**.
3. Type the IP address, Subnet mask and Default gateway from your service provider.
4. If needed, you can also type the preferred DNS server address and alternate DNS server address then select **OK**.



## Turning your Notebook PC off

You can turn off your Notebook PC by doing either of the following procedures:



- Launch the Start menu, then select  **Power** > **Shut down** to do a normal shutdown.
- From the log-in screen, select  > **Shut down**.





- Press  +  to launch Shut down Windows. Select **Shut down** from the drop-down list then select **OK**.
- If your Notebook PC is unresponsive, press and hold the power button for at least four (4) seconds until your Notebook PC turns off.



## Putting your Notebook PC to sleep

To put your Notebook PC to Sleep mode:



- Launch the Start menu, then select  **Power** > **Sleep** to put your Notebook PC to sleep.
- From the log-in screen, select  > **Sleep**.



Press  +  to launch Shut down Windows.  
Select **Sleep** from the drop-down list then select **OK**.

---

**NOTE:** You can also put your Notebook PC to Sleep mode by pressing the power button once.

---



# ***Chapter 4:***

## ***Power-On Self-Test (POST)***

# The Power-On Self-Test (POST)

The POST (Power-On Self-Test) is a series of software-controlled diagnostic tests that run when you turn on or restart your Notebook PC. The software that controls the POST is installed as a permanent part of the Notebook PC's architecture.

## Using POST to access BIOS and Troubleshoot

During POST, you can access the BIOS settings or run troubleshooting options using the function keys of your Notebook PC. You may refer to the following information for more details.

## BIOS

The BIOS (Basic Input and Output System) stores system hardware settings that are needed for system startup in the Notebook PC.

The default BIOS settings apply to most conditions of your Notebook PC. Do not change the default BIOS settings except in the following circumstances:

- An error message appears onscreen during system bootup and requests you to run the BIOS Setup.
- You have installed a new system component that requires further BIOS settings or updates.

---

**WARNING!** Using inappropriate BIOS settings may result to system instability or boot failure. We strongly recommend that you change the BIOS settings only with the help of a trained service personnel.

---

## Accessing BIOS

Enter the BIOS settings by using any of the following methods:



- Restart your Notebook PC then press  during POST.
- Launch the Start menu, and choose **Settings > Update & security > Recovery**, then select **Restart now** under Advanced startup. When you enter the Advanced startup screen, select **Troubleshoot > Advanced options > UEFI Firmware Settings > Restart**.

## BIOS Settings

**NOTE:** The BIOS screens in this section are for reference only. The actual screens may differ by model and territory.

### EZ Mode

This menu appears when you enter the BIOS setup program and provides you an overview of the basic system information. To access the Advanced Mode for the advanced BIOS settings, select **Advanced Mode (F7)** or press .

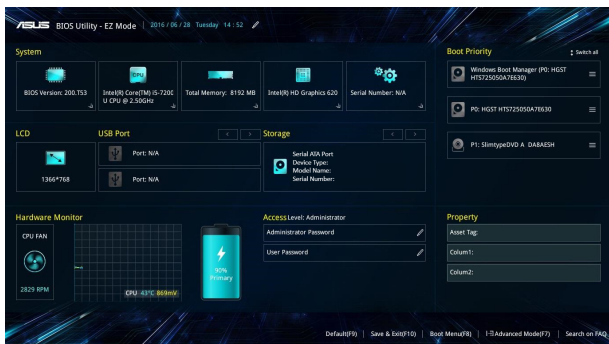

## Boot

This menu allows you to set your boot option priorities. You may refer to the following procedures when setting your boot priority.

1. On the **Boot** screen, select **Boot Option #1**.
2. Press  and select a device as the **Boot Option #1**.

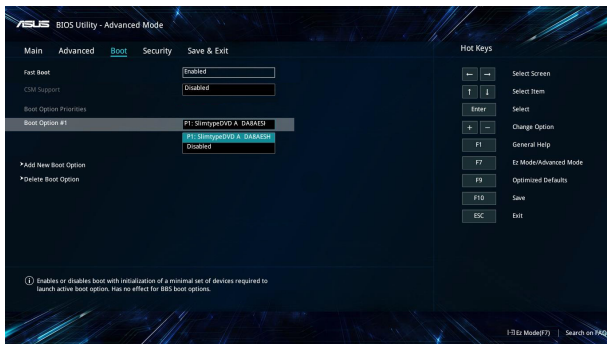

## Security

This menu allows you to set up the administrator and user password of your Notebook PC. It also allows you to control the access to your Notebook PC's hard disk drive, input/output (I/O) interface, and USB interface.

---

### NOTE:

- If you install a **User Password**, you will be prompted to input this before entering the operating system.
  - If you install an **Administrator Password**, you will be prompted to input this before entering BIOS.
- 

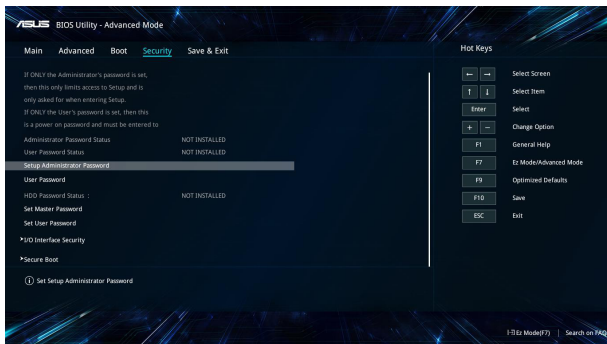

To set the password:

1. On the **Security** screen, select **Setup Administrator Password** or **User Password**.
2. Type in a password then press .
3. Re-type to confirm the password then select **OK**.

To clear the password:

1. On the **Security** screen, select **Setup Administrator Password** or **User Password**.
2. Type in the current password then press .
3. Leave other fields blank then select **OK** to continue.
4. Select **OK** to clear the old password.

---

**NOTE:** A keyboard is required to type in the password.

---

## Save & Exit

To keep your configuration settings, select **Save Changes and Exit** before exiting the BIOS.

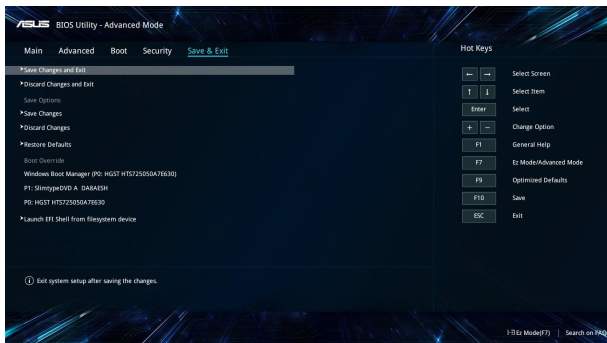

## To update the BIOS:

1. Verify the Notebook PC's exact model then download the latest BIOS file for your model from the ASUS website.
2. Save a copy of the downloaded BIOS file to a flash disk drive.
3. Connect your flash disk drive to your Notebook PC.
4. Restart your Notebook PC then access the BIOS settings.
5. From the BIOS menu, select **Advanced** > **ASUS EZ Flash 3 Utility**, then press .

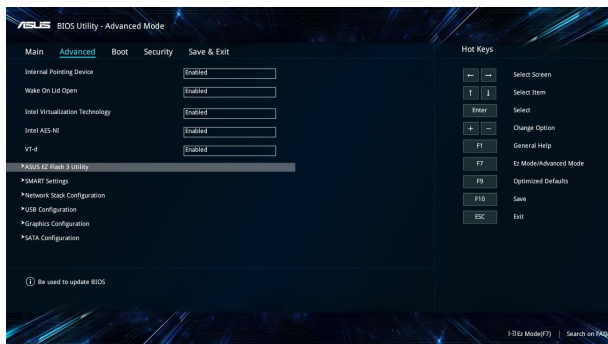

6. Locate your downloaded BIOS file in the flash disk drive then press . Follow the onscreen instructions to complete the update.

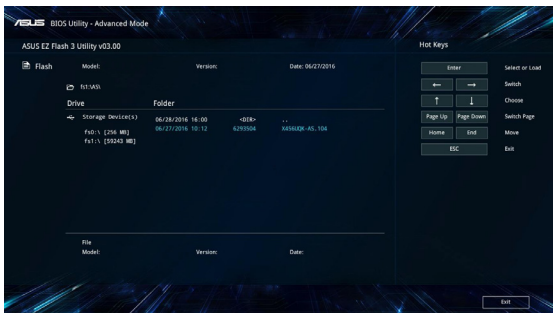

7. After the BIOS update process, select **Save & Exit > Restore Defaults** to restore the system to its default settings.

# Recovering your system

Using recovery options on your Notebook PC allows you to restore the system to its original state or simply refresh its settings to help improve performance.

---

## IMPORTANT!

- Backup all your data files before doing any recovery option on your Notebook PC.
  - Note down important customized settings such as network settings, user names, and passwords to avoid data loss.
  - Ensure that your Notebook PC is plugged in to a power source before resetting your system.
- 

Windows® 10 allows you to do any of the following recovery options:

- **Keep my files** - This option allows you refresh your Notebook PC without affecting personal files (photos, music, videos, documents).

Using this option, you can restore your Notebook PC to its default settings and delete other installed apps.

- **Remove everything** - This option resets your Notebook PC to its factory settings. You must backup your data before doing this option.



- **Go back to an earlier build** - This option allows you to go back to an earlier build. Use this option if this build is not working for you.
- **Advanced startup** - Using this option allows you to perform other advanced recovery options on your Notebook PC such as:
  - Using a USB drive, network connection or Windows recovery DVD to startup your Notebook PC.
  - Using **Troubleshoot** to enable any of these advanced recovery options: System Restore, System Image Recovery, Startup Repair, Command Prompt, UEFI Firmware Settings, and Startup Settings.

## Performing a recovery option

Refer to the following steps if you want to access and use any of the available recovery options for your Notebook PC.

1. Launch **Settings** and select **Update and security**.

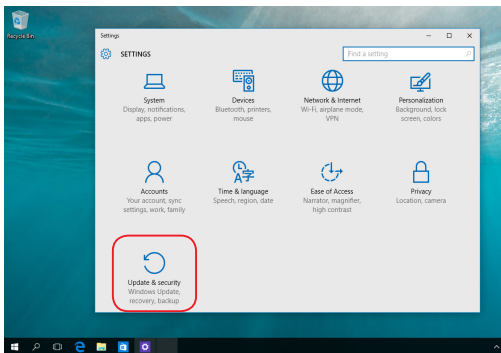

2. Under the **Update and security** option, select **Recovery** then select the recovery option you would like to perform.

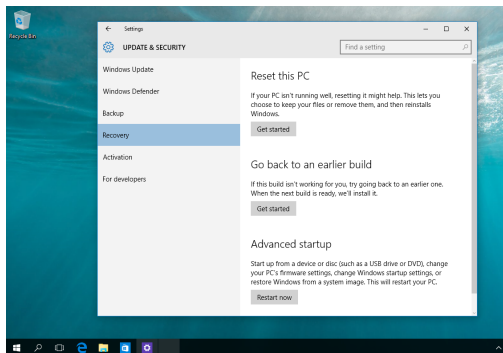

# ***Chapter 5:***

## ***Upgrading your Notebook PC***

# Removing the compartment cover

## 14" model

- A. Remove the screws from the Notebook PC's compartment cover.
- B. Pull out the compartment cover and remove it completely from your Notebook PC.

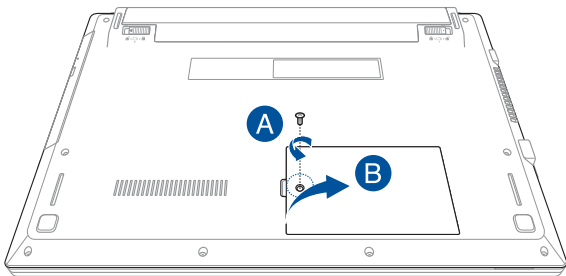

To reattach the compartment cover:

- A. Align and reattach the cover of the compartment.
- B. Secure the cover using the screws you removed earlier.

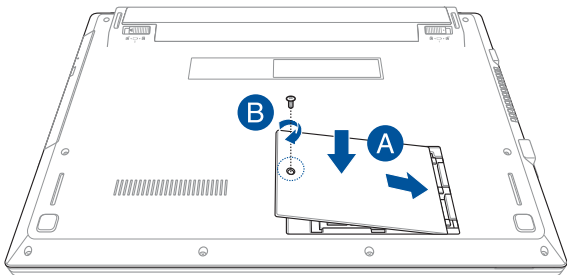

## 15.6" model

- A. Remove the screws from the Notebook PC's compartment cover.
- B. Pull out the compartment cover and remove it completely from your Notebook PC.

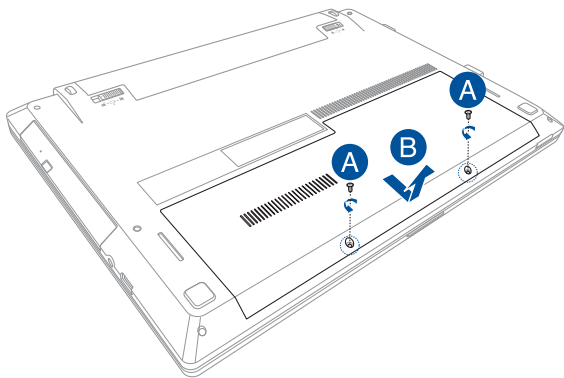

To reattach the compartment cover:

- A. Align and reattach the cover of the compartment.
- B. Secure the cover using the screws you removed earlier.

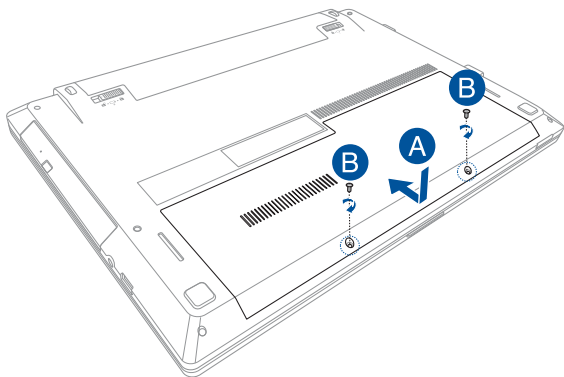

## Installing a RAM module

Upgrade the memory capacity of your Notebook PC by installing a RAM (Random Access Memory) module in the memory module compartment. The following steps show you how to install a RAM module into your Notebook PC:

---

**WARNING!** Disconnect all the connected peripherals, any telephone or telecommunication lines and power connector (such as external power supply, battery pack, etc.) before removing the compartment cover.

---

---

**IMPORTANT!** Visit an authorized service center or retailer for information on RAM module upgrades for your Notebook PC. Purchase RAM modules from authorized retailers of this Notebook PC to ensure maximum compatibility and reliability.

---

**NOTE:**

- The appearance of your Notebook PC's bottom side and RAM module may vary per model but the RAM module installation remains the same.
  - It is recommended that you install the RAM module under professional supervision. You may also visit an authorized service center for further assistance.
-



## 14" model

- A. Remove the compartment cover.
- 

**NOTE:** For more details, refer to the *Removing the compartment cover* section in this manual.

---

- B. Align and insert the RAM module into the RAM module slot.  
C. Push down the RAM module until it clicks in place.

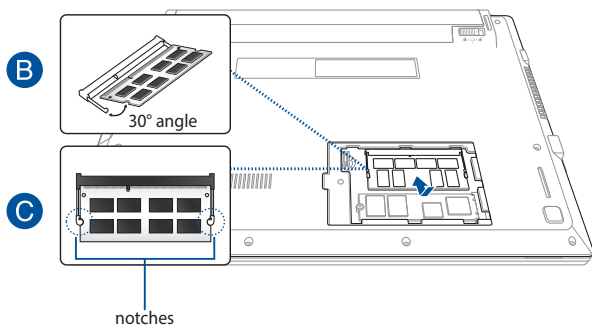

## 15.6" model

- A. Remove the compartment cover.
- 

**NOTE:** For more details, refer to the *Removing the compartment cover* section in this manual.

---

- B. Align and insert the RAM module into the RAM module slot.  
C. Push down the RAM module until it clicks in place.

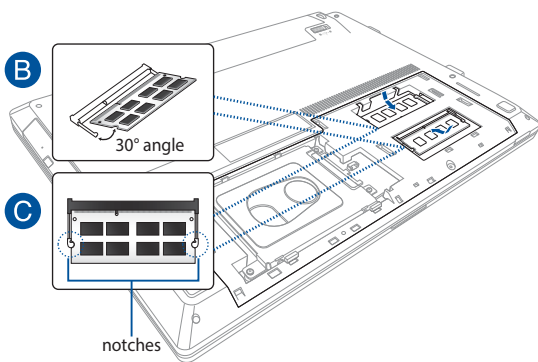

# Installing the Hard Disk Drive

Refer to the following steps if you need to install a new HDD (Hard Disk Drive) to your Notebook PC:

---

**IMPORTANT!** Purchase an HDD from authorized retailers of this Notebook PC to ensure maximum compatibility and reliability.

---

**WARNING!** Disconnect all the connected peripherals, any telephone or telecommunication lines and power connector (such as external power supply, battery pack, etc.) before removing the compartment cover.

---

**NOTE:**

- The appearance of your Notebook PC's bottom side and HDD may vary per model but the HDD installation remains the same.
  - It is recommended that you replace the HDD under professional supervision. You may also visit an authorized service center for further assistance.
-

## 14" model

### Hard disk drive caddy

- A. Remove the compartment cover.

---

**NOTE:** For more details, refer to the *Removing the compartment cover* section in this manual.

---

- B. Move the manual battery lock to the unlocked position.
- C. Move and hold the spring battery lock to an unlocked position.
- D. Pull out the battery pack from the battery slot then release your hold on the spring battery lock.

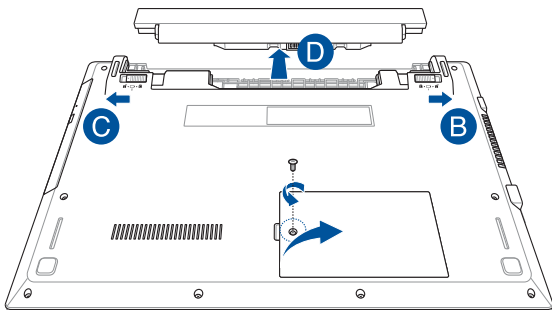

---

**WARNING!** Turn off your Notebook PC and disconnect all connected peripherals, any telephone or telecommunication lines and power connector, before removing the battery pack.

---

E. Remove the screws securing the cover.

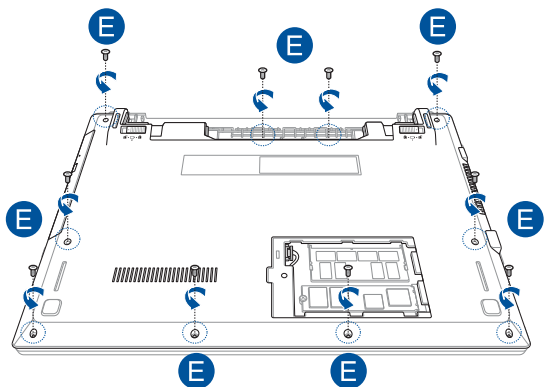

- F. Disconnect the speaker cable from the motherboard.
- G. Remove the cover completely from your Notebook PC.

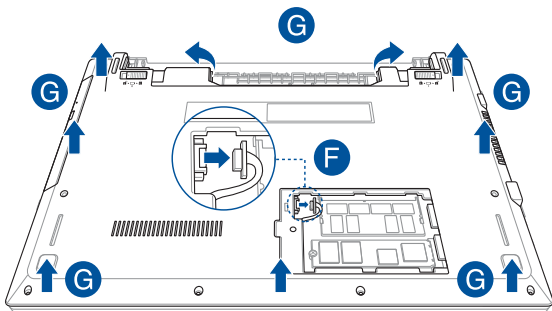

- H. Remove the screws securing the HDD caddy to the Notebook PC.
- I. Remove the HDD caddy.

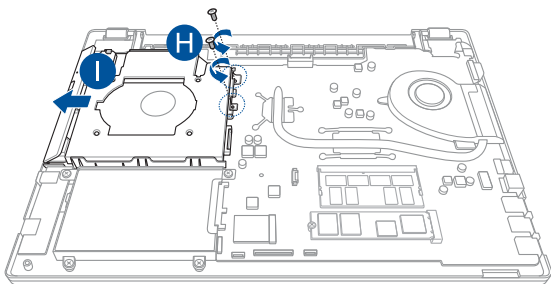

- J. Place the new HDD in the compartment with the HDD connector aligned with the HDD port. Push the HDD until it connects with the HDD caddy.

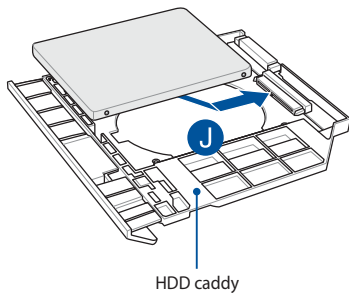



- K. Secure the HDD with the bundled screws.

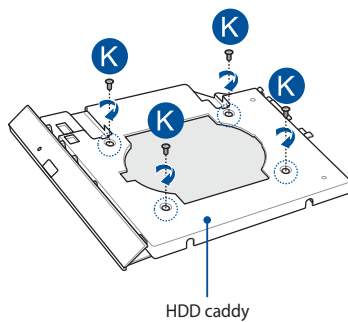

- L. Replace the HDD caddy back in the compartment with the HDD connector aligned with the Notebook PC's HDD port. Push the HDD caddy until it connects with the Notebook PC.
- M. Secure the HDD caddy with the screws you removed earlier.

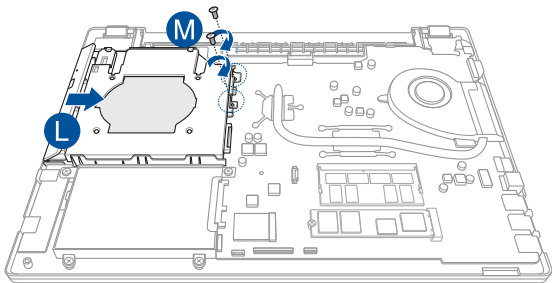

- N. Connect the speaker cable to the motherboard.
- O. Align and reattach the cover of the compartment.

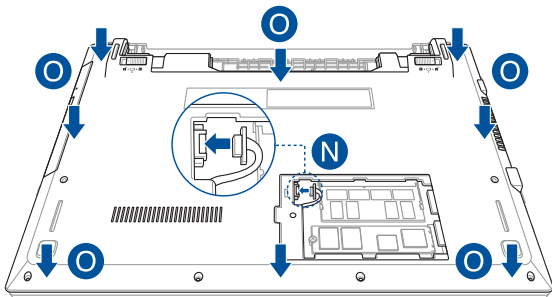

- P. Secure the cover using the screws you removed earlier.

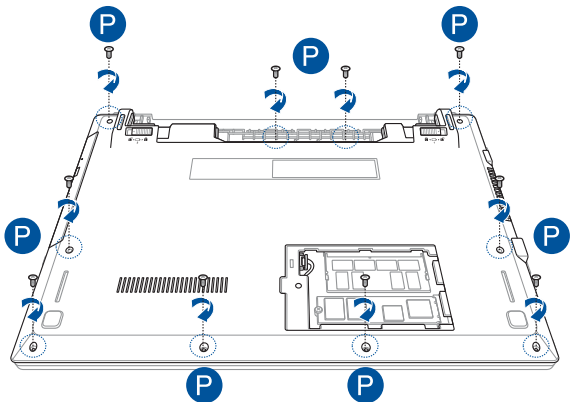

- Q. Move the manual battery lock to the unlocked position.
- R. Align and insert the new battery pack into the Notebook PC's battery slot.
- S. Move the manual battery lock back to the locked position after inserting the battery pack.
- T. Reattach the compartment cover.

---

**NOTE:** For more details, refer to the *Removing the compartment cover* section in this manual.

---

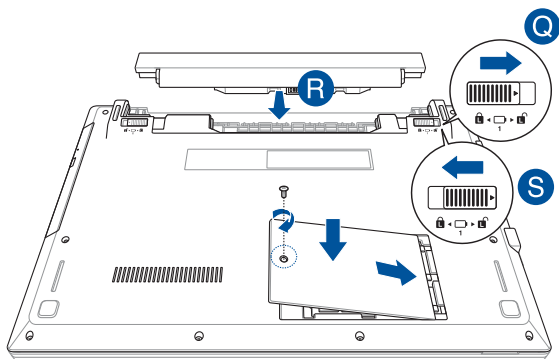

## 15.6" model

### Internal hard disk drive bay

- A. Remove the compartment cover.

---

**NOTE:** For more details, refer to the *Removing the compartment cover* section in this manual.

---

- B. Remove the screws securing the HDD bay to the compartment.
- C. (Optional) If an HDD is currently installed in your Notebook PC, disconnect the HDD bay from the HDD port as shown in the illustration below.

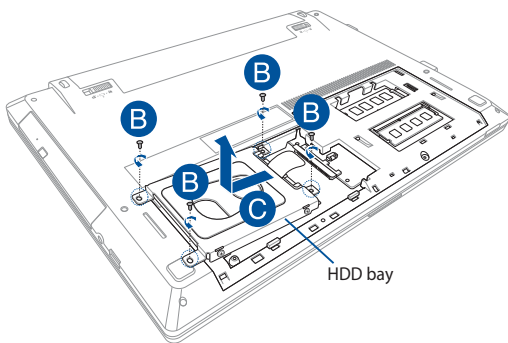

- D. (Optional) If an HDD is currently attached to the HDD bay, refer to the following steps on how to remove the old HDD:
1. Remove all the screws on the sides of the HDD bay.
  2. Remove the old HDD from the HDD bay then place it on a flat dry surface with its PCB (Printed Circuit Board) facing up, as shown in the illustration below.

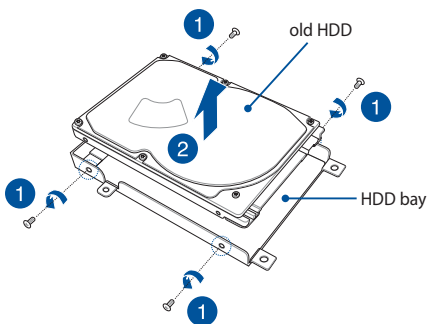

- E. Place the new HDD with its PCB (Printed Circuit Board) facing the HDD bay. Ensure that the port connectors of your HDD are not obstructed by any part of the HDD bay.
- F. Reattach and secure the HDD with the screws you removed earlier.

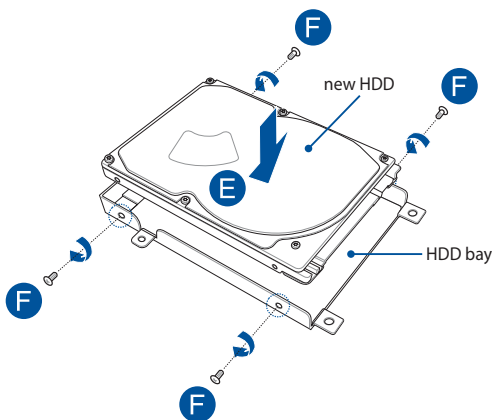



- G. Replace the HDD bay back in the compartment with the HDD connector aligned with the Notebook PC's HDD port. Push the HDD bay until it connects with the Notebook PC.
- H. Secure the HDD bay with the screws you removed earlier.

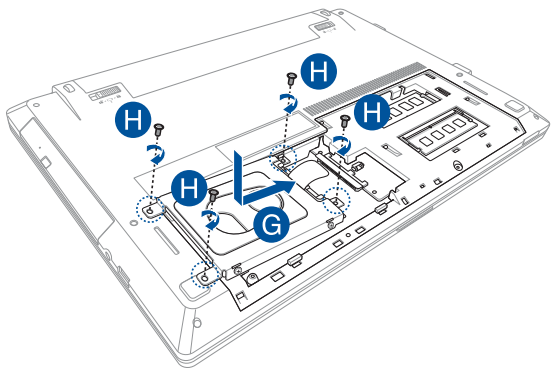

## Hard disk drive caddy

- A. Remove the compartment cover.

---

**NOTE:** For more details, refer to the *Removing the compartment cover* section in this manual.

---

- B. Move the manual battery lock to the unlocked position.
- C. Move and hold the spring battery lock to an unlocked position.
- D. Pull out the battery pack from the battery slot then release your hold on the spring battery lock.

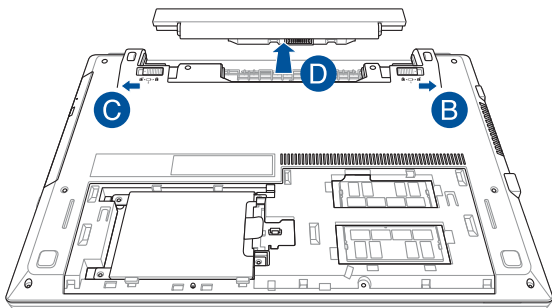

- E. Remove the screws securing the HDD bay to the compartment.
- F. Remove the screws securing the cover.
- G. Remove the HDD bay from your Notebook PC. If an HDD is currently installed in your HDD bay, disconnect the HDD bay from the HDD port as shown in the illustration below.

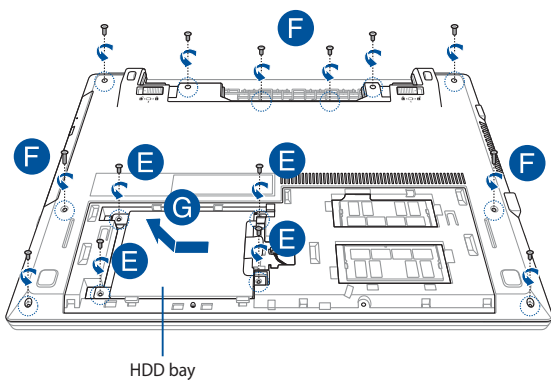

- H. Disconnect the speaker cable from the motherboard.
- I. Remove the cover completely from your Notebook PC.

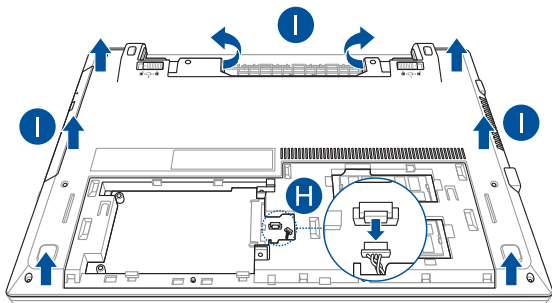

- J. Remove the screws securing the HDD caddy to the Notebook PC.
- K. Remove the HDD caddy.

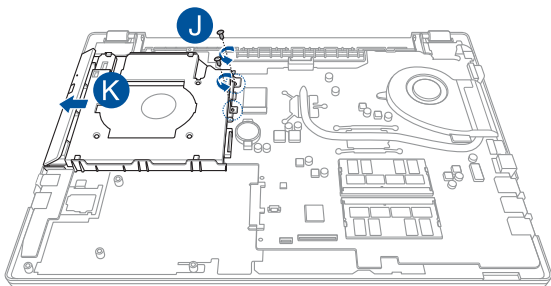

- L. Place the new HDD in the compartment with the HDD connector aligned with the HDD port. Push the HDD until it connects with the HDD caddy.

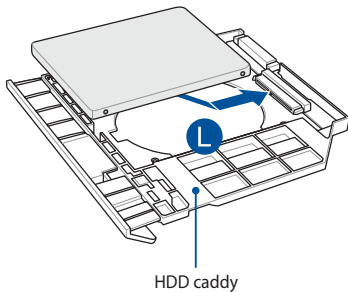

M. Secure the HDD with the bundled screws.

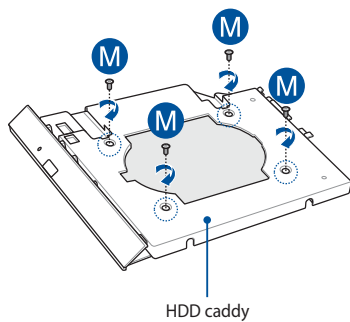

- N. Replace the HDD caddy back in the compartment with the HDD connector aligned with the Notebook PC's HDD port. Push the HDD caddy until it connects with the Notebook PC.
- O. Secure the HDD caddy with the screws you removed earlier.

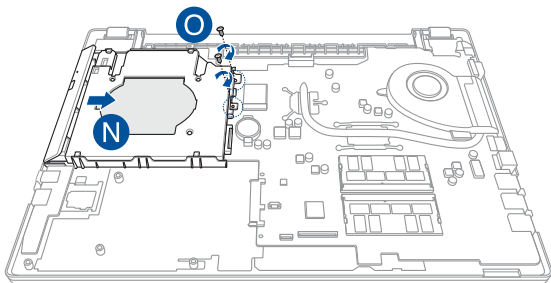



- P. Connect the speaker cable to the motherboard.
- Q. Align and reattach the cover of the compartment.

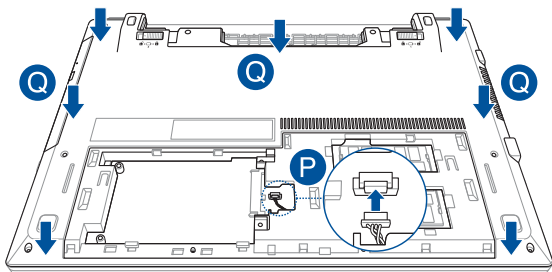

- R. Replace the HDD bay back in the compartment. If an HDD is currently installed in your HDD bay, push the HDD bay with the HDD connector aligned with the Notebook PC's HDD port until it connects with the Notebook PC.
- S. Secure the HDD bay with the screws you removed earlier.
- T. Secure the cover using the screws you removed earlier.

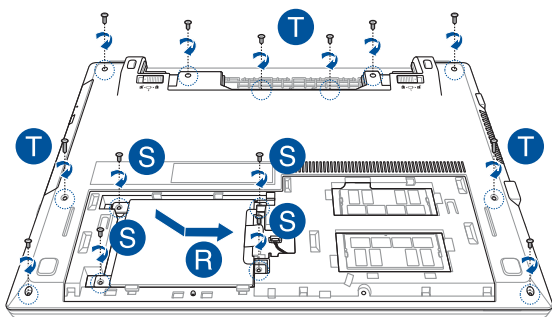

- U. Move the manual battery lock to the unlocked position.
- V. Align and insert the new battery pack into the Notebook PC's battery slot.
- W. Move the manual battery lock back to the locked position after inserting the battery pack.
- X. Reattach the compartment cover.

---

**NOTE:** For more details, refer to the *Removing the compartment cover* section in this manual.

---

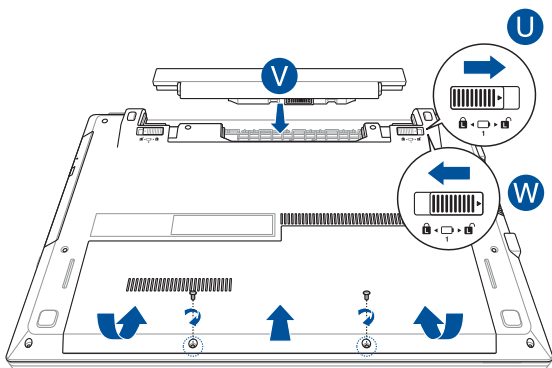

## Installing an M.2 card

Refer to the following steps when installing a compatible M.2 card in your Notebook PC:

---

**IMPORTANT!** Purchase your M.2 card from authorized retailers of this Notebook PC to ensure maximum compatibility and reliability.

---

---

**WARNING!** Disconnect all the connected peripherals, any telephone or telecommunication lines and power connector (such as external power supply, battery pack, etc.) before removing the compartment cover.

---

**NOTE:**

- The appearance of your Notebook PC's bottom side and M.2 card may vary per model but the module installation remains the same.
  - It is recommended that you install the M.2 card under professional supervision. You may also visit an authorized service center for further assistance.
  - The M.2 2280 slot does not support M.2 PCIe SSD.
-

## 14" model

- A. Remove the compartment cover.

---

**NOTE:** For more details, refer to the *Removing the compartment cover* section in this manual.

---

- B. Align and insert the M.2 card into its card module slot.
- C. Secure the M.2 card in place using the bundled screw.

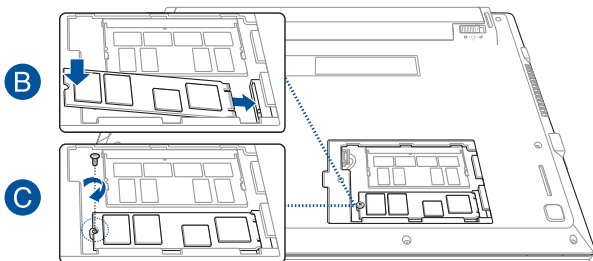



## ***Tips and FAQs***

## Useful tips for your Notebook PC

To help you maximize the use of your Notebook PC, maintain its system performance, and ensure all your data are kept secured, here are some useful tips that you can follow:

- Update Windows® periodically to ensure that your applications have the latest security settings.
- Use an anti-virus software to protect your data and keep this updated too.
- Unless absolutely necessary, refrain from using force shutdown to turn off your Notebook PC.
- Always backup your data and make it a point to create a backup data in an external storage drive.
- Refrain from using the Notebook PC at extremely high temperatures. If you are not going to use your Notebook PC for a long period of time (at least a month), we recommend that you take out the battery if the battery is removable.
- Disconnect all external devices and ensure you have the following items prior to resetting your Notebook PC:
  - Product key for your operating systems and other installed applications
  - Backup data
  - Log in ID and password
  - Internet connection information



## Hardware FAQs

**1. A black dot, or sometimes a colored dot, appears onscreen when I turn on the Notebook PC. What should I do?**

Although these dots normally appear onscreen, they will not affect your system. If the incident continues and subsequently affects system performance, consult an authorized ASUS service center.

**2. My display panel has an uneven color and brightness. How can I fix this?**

The color and brightness of your display panel may be affected by the angle and current position of your Notebook PC. The brightness and color tone of your Notebook PC may also vary per model. You may use the function keys or the display settings in your operating system to adjust the appearance of your display panel.

**3. How can I maximize my Notebook PC's battery life?**



You can try doing any of the following suggestions:

- Use the function keys to adjust the display brightness.
- If you are not using any Wi-Fi connection, switch your system into **Airplane mode**.
- Disconnect unused USB devices.
- Close unused applications, especially those that take up too much system memory.

#### 4. **My battery charge indicator does not light up. What's wrong?**



- Check whether the power adapter or battery pack is attached correctly. You may also disconnect the power adapter or battery pack, wait for a minute, then reconnect them again to the power outlet and Notebook PC.
- If the problem still exists, contact your local ASUS service center for assistance.

#### 5. **Why is my touchpad not working?**

Press  +  to enable your touchpad.

#### 6. **When I play audio and video files, why can't I hear any sound from my Notebook PC's audio speakers?**

You can try doing any of the following suggestions:

- Press  +  to turn up the speaker volume.
- Check if your speakers were set to mute.
- Check if a headphone jack is connected to your Notebook PC and remove it.

#### 7. **What should I do if my Notebook PC's power adapter gets lost or my battery stops working?**

Contact your local ASUS service center for assistance.

**8. My Notebook PC cannot do keystrokes correctly because my cursor keeps on moving. What should I do?**

Make sure that nothing accidentally touches or presses on your touchpad while you type on the keyboard. You can also disable

your touchpad by pressing  + .

**9. Instead of showing letters, pressing the “U”, “I”, and “O” keys on my keyboard displays numbers. How can I change this?**

Press the  key or  +  (on selected models) on your

Notebook PC to turn off this feature and use the said keys for inputting letters.

## Software FAQs

**1. When I turn on my Notebook PC, the power indicator lights up but nothing appears on my screen. What can I do to fix this?**

You can try doing any of the following suggestions:

- Force shutdown your Notebook PC by pressing the power button for at least four (4) seconds. Check if the power adapter and battery pack are inserted correctly then turn on your Notebook PC.
- If the problem still exists, contact your local ASUS service center for assistance.

**2. What should I do when my screen displays this message: "Remove disks or other media. Press any key to restart."?**

You can try doing any of the following suggestions:

- Remove all connected USB devices then restart your Notebook PC.
- Remove any optical discs that are left inside the optical drive then restart.
- If the problem still exists, your Notebook PC might have a memory storage problem. Contact your local ASUS service center for assistance.

**3. My Notebook PC boots slower than usual and my operating system lags. How can I fix this?**

Delete the applications you recently installed or were not included with your operating system package then restart your system.

#### **4. My Notebook PC does not boot up. How can I fix this?**

You can try doing any of the following suggestions:

- Remove all connected devices to your Notebook PC then restart your system.
- If the problem still exists, contact your local ASUS service center for assistance.

#### **5. Why can't my Notebook PC wake up from sleep mode?**

- You need to press the power button to resume your last working state.
- Your system might have completely used up its battery power. Connect the power adapter to your Notebook PC and connect to a power outlet then press the power button.



# ***Appendices***

## DVD-ROM Drive Information

The DVD-ROM drive allows you to view and create your own CDs and DVDs. You can purchase an optional DVD viewer software to view DVD titles.

---

**NOTE:** The DVD-ROM Drive is available on selected models.

---

## Regional Playback Information

Playback of DVD movie titles involves decoding MPEG2 video, digital AC3 audio and decryption of CSS protected content. CSS (sometimes called copy guard) is the name given to the content protection scheme adopted by the motion picture industry to satisfy a need to protect against unlawful content duplication.

Although the design rules imposed on CSS licensors are many, one rule that is most relevant is playback restrictions on regionalized content. In order to facilitate geographically staggered movie releases, DVD video titles are released for specific geographic regions as defined in "Region Definitions" below. Copyright laws require that all DVD movies be limited to a particular region (usually coded to the region at which it is sold). While DVD movie content may be released for multiple regions, CSS design rules require that any system capable of playing CSS encrypted content must only be capable of playing one region.

---

**IMPORTANT!** The region setting may be changed up to five times using the viewer software, then it can only play DVD movies for the last region setting. Changing the region code after that will require factory resetting which is not covered by warranty. If resetting is desired, shipping and resetting costs will be at the expense of the user.

---



## Region Definitions

### Region 1

Canada, US, US Territories

### Region 2

Czech, Egypt, Finland, France, Germany, Gulf States, Hungary, Iceland, Iran, Iraq, Ireland, Italy, Japan, Netherlands, Norway, Poland, Portugal, Saudi Arabia, Scotland, South Africa, Spain, Sweden, Switzerland, Syria, Turkey, UK, Greece, Former Yugoslav Republics, Slovakia

### Region 3

Burma, Indonesia, South Korea, Malaysia, Philippines, Singapore, Taiwan, Thailand, Vietnam

### Region 4

Australia, Caribbean (Except US Territories), Central America, New Zealand, Pacific Islands, South America

### Region 5

CIS, India, Pakistan, Rest of Africa, Russia, North Korea

### Region 6

China

## Blu-ray ROM Drive Information

The Blu-ray ROM Drive allows you to view HD (High-Definition) videos and other disc file formats such as DVDs and CDs.

---

**NOTE:** The Blu-ray ROM Drive is available on selected models.

---

### Region Definitions

#### Region A

North, Central and South American countries, and their territories; Taiwan, Hong Kong, Macao, Japan, Korea (South and North), South East Asian countries and their territories.

#### Region B

European, African, and South West Asian countries and their territories; Australia and New Zealand.

#### Region C

Central, South Asian, Eastern European countries and their territories; China and Mongolia.

---

**NOTE:** Refer to Blu-ray Disc website at [www.blu-raydisc.com/en/Technical/FAQs/Blu-rayDiscforVideo.aspx](http://www.blu-raydisc.com/en/Technical/FAQs/Blu-rayDiscforVideo.aspx) for more details.

---

## Federal Communications Commission Interference Statement

This device complies with FCC Rules Part 15. Operation is subject to the following two conditions:

- This device may not cause harmful interference.
- This device must accept any interference received, including interference that may cause undesired operation.

This equipment has been tested and found to comply with the limits for a class B digital device, pursuant to Part 15 of the Federal Communications Commission (FCC) rules. These limits are designed to provide reasonable protection against harmful interference in a residential installation. This equipment generates, uses, and can radiate radio frequency energy and, if not installed and used in accordance with the instructions, may cause harmful interference to radio communications. However, there is no guarantee that interference will not occur in a particular installation. If this equipment does cause harmful interference to radio or television reception, which can be determined by turning the equipment off and on, the user is encouraged to try to correct the interference by one or more of the following measures:

- Reorient or relocate the receiving antenna.
- Increase the separation between the equipment and receiver.
- Connect the equipment into an outlet on a circuit different from that to which the receiver is connected.
- Consult the dealer or an experienced radio/TV technician for help.

---

**WARNING!** The use of a shielded-type power cord is required in order to meet FCC emission limits and to prevent interference to the nearby radio and television reception. It is essential that only the supplied power cord be used. Use only shielded cables to connect I/O devices to this equipment. You are cautioned that changes or modifications not expressly approved by the party responsible for compliance could void your authority to operate the equipment.

---

(Reprinted from the Code of Federal Regulations #47, part 15.193, 1993.  
Washington DC: Office of the Federal Register, National Archives and Records  
Administration, U.S. Government Printing Office.)

## FCC Radio Frequency (RF) Exposure Caution Statement

---

**WARNING!** Any changes or modifications not expressly approved by the party responsible for compliance could void the user's authority to operate this equipment.

---

This equipment complies with FCC radiation exposure limits set forth for an uncontrolled environment. To maintain compliance with FCC RF exposure compliance requirements, please avoid direct contact to the transmitting antenna during transmitting. End users must follow the specific operating instructions for satisfying RF exposure compliance.

This device operates within a 5.15-5.25 GHz frequency range and is restricted for indoor use only. Outdoor operation within 5150-5250 MHz is prohibited.

## **Compliance Statement of Innovation, Science and Economic Development Canada (ISED)**

This device complies with *Innovation, Science and Economic Development Canada* license exempt RSS standard(s). Operation is subject to the following two conditions: (1) this device may not cause interference, and (2) this device must accept any interference, including interference that may cause undesired operation of the device.

Operation in the band 5150-5250 MHz is only for indoor use to reduce the potential for harmful interference to co-channel mobile satellite systems

CAN ICES-3(B)/NMB-3(B)

## **Déclaration de conformité de Innovation, Sciences et Développement économique Canada (ISED)**

Le présent appareil est conforme aux CNR d'*Innovation, Sciences et Développement économique Canada* applicables aux appareils radio exempts de licence.

L'exploitation est autorisée aux deux conditions suivantes: (1) l'appareil ne doit pas produire de brouillage, et (2) l'utilisateur de l'appareil doit accepter tout brouillage radioélectrique subi, même si le brouillage est susceptible d'en compromettre le fonctionnement.

La bande 5150-5250 MHz est réservée uniquement pour une utilisation à l'intérieur afin de réduire les risques de brouillage préjudiciable aux systèmes de satellites mobiles utilisant les mêmes canaux.

CAN ICES-3(B)/NMB-3(B)

## Caution

- (i) the device for operation in the band 5150-5250 MHz is only for indoor use to reduce the potential for harmful interference to co-channel mobile satellite systems;
- (ii) the maximum antenna gain permitted for devices in the bands 5250-5350 MHz and 5470-5725 MHz shall comply with the e.i.r.p. limit; and
- (iii) the maximum antenna gain permitted for devices in the band 5725-5825 MHz shall comply with the e.i.r.p. limits specified for point-to-point and non point-to-point operation as appropriate.
- (iv) Users should also be advised that high-power radars are allocated as primary users (i.e. priority users) of the bands 5250-5350 MHz and 5650-5850 MHz and that these radars could cause interference and/or damage to LE-LAN devices.

## Avertissement

Le guide d'utilisation des dispositifs pour réseaux locaux doit inclure des instructions précises sur les restrictions susmentionnées, notamment:

- (i) Les dispositifs fonctionnant dans la bande 5150-5250 MHz sont réservés uniquement à une utilisation en intérieur afin de réduire les risques d'interférence préjudiciables aux systèmes de satellites mobiles utilisant les mêmes canaux;
- (ii) Le gain maximal d'antenne permis pour les dispositifs utilisant les bandes 5250-5350 MHz et 5470-5725 MHz doit être conforme à la limite de P.I.R.E; et
- (iii) Le gain maximal d'antenne permis (pour les dispositifs utilisant la bande 5725-5825 MHz) doit être conforme à la limite de P.I.R.E spécifiée pour l'exploitation point à point et non point à point, selon le cas.
- (iv) De plus, les utilisateurs devraient aussi être avisés que les utilisateurs de radars de haute puissance sont désignés utilisateurs principaux (c.-à-d., qu'ils ont la priorité) pour les bandes 5250-5350 MHz et 5650-5850 MHz et que ces radars pourraient créer des interférences et/ou des dommages aux dispositifs LAN-EL.

## Wireless Operation Channel for Different Domains

N. America	2.412-2.462 GHz	Ch01 through Ch11
Japan	2.412-2.484 GHz	Ch01 through Ch14
Europe ETSI	2.412-2.472 GHz	Ch01 through Ch13

## Power Safety Requirement

Products with electrical current ratings up to 6A and weighing more than 3Kg must use approved power cords greater than or equal to: H05VV-F, 3G, 0.75mm<sup>2</sup> or H05VV-F, 2G, 0.75mm<sup>2</sup>.

## TV Notices

Note to CATV System Installer—Cable distribution system should be grounded (earthed) in accordance with ANSI/NFPA 70, the National Electrical Code (NEC), in particular Section 820.93, Grounding of Outer Conductive Shield of a Coaxial Cable – installation should include bonding the screen of the coaxial cable to the earth at the building entrance.

## Macrovision Corporation Product Notice

This product incorporates copyright protection technology that is protected by method claims of certain U.S.A. patents and other intellectual property rights owned by Macrovision Corporation and other rights owners. Use of this copyright protection technology must be authorized by Macrovision Corporation, and is intended for home and other limited viewing uses only *unless otherwise authorized by Macrovision Corporation*. Reverse engineering or disassembly is prohibited.

## UL Safety Notices

Required for UL 1459 covering telecommunications (telephone) equipment intended to be electrically connected to a telecommunication network that has an operating voltage to ground that does not exceed 200V peak, 300V peak-to-peak, and 105V rms, and installed or used in accordance with the National Electrical Code (NFPA 70).

When using the Notebook PC modem, basic safety precautions should always be followed to reduce the risk of fire, electric shock, and injury to persons, including the following:

- DO NOT use the Notebook PC near water, for example, near a bath tub, wash bowl, kitchen sink or laundry tub, in a wet basement or near a swimming pool.
- DO NOT use the Notebook PC during an electrical storm. There may be a remote risk of electric shock from lightning.
- DO NOT use the Notebook PC in the vicinity of a gas leak.

Required for UL 1642 covering primary (non-rechargeable) and secondary (rechargeable) lithium batteries for use as power sources in products. These batteries contain metallic lithium, or a lithium alloy, or a lithium ion, and may consist of a single electrochemical cell or two or more cells connected in series, parallel, or both, that convert chemical energy into electrical energy by an irreversible or reversible chemical reaction.

- DO NOT dispose the Notebook PC battery pack in a fire, as they may explode. Check with local codes for possible special disposal instructions to reduce the risk of injury to persons due to fire or explosion.
- DO NOT use power adapters or batteries from other devices to reduce the risk of injury to persons due to fire or explosion. Use only UL certified power adapters or batteries supplied by the manufacturer or authorized retailers.



## Nordic Lithium Cautions (for lithium-ion batteries)

**CAUTION!** Danger of explosion if battery is incorrectly replaced. Replace only with the same or equivalent type recommended by the manufacturer. Dispose of used batteries according to the manufacturer's instructions. (English)

**ATTENZIONE!** Rischio di esplosione della batteria se sostituita in modo errato. Sostituire la batteria con un una di tipo uguale o equivalente consigliata dalla fabbrica. Non disperdere le batterie nell'ambiente. (Italian)

**VORSICHT!** Explosionsgefahr bei unsachgemäßen Austausch der Batterie. Ersatz nur durch denselben oder einem vom Hersteller empfohlenem ähnlichen Typ. Entsorgung gebrauchter Batterien nach Angaben des Herstellers. (German)

**ADVARSEL!** Lithiumbatteri - Eksplosionsfare ved fejlagtig håndtering. Udskiftning må kun ske med batteri af samme fabrikat og type. Levér det brugte batteri tilbage til leverandøren. (Danish)

**WARNING!** Explosionsfara vid felaktigt batteribyte. Använd samma batterityp eller en ekvivalent typ som rekommenderas av apparattillverkaren. Kassera använt batteri enligt fabrikantens instruktion. (Swedish)

**VAROITUS!** Paristo voi räjähtää, jos se on virheellisesti asennettu. Vaihda paristo ainoastaan laitevalmistajan suosittellemaan tyyppiin. Hävitä käytetty paristo valmistagan ohjeiden mukaisesti. (Finnish)

**ATTENTION!** Danger d'explosion si la batterie n'est pas correctement remplacée. Remplacer uniquement avec une batterie de type semblable ou équivalent, recommandée par le fabricant. Jeter les batteries usagées conformément aux instructions du fabricant. (French)

**ADVARSEL!** Eksplosjonsfare ved feilaktig skifte av batteri. Benytt samme batteritype eller en tilsvarende type anbefalt av apparatfabrikanten. Brukte batterier kasseres i henhold til fabrikantens instruksjoner. (Norwegian)

標準品以外の使用は、危険の元になります。交換品を使用する場合、製造者に指定されるものを使って下さい。製造者の指示に従って処理して下さい。(Japanese)

**ВНИМАНИЕ!** При замене аккумулятора на аккумулятор иного типа возможно его возгорание. Утилизируйте аккумулятор в соответствии с инструкциями производителя. (Russian)

# Optical Drive Safety Information

## Laser Safety Information



---

**WARNING!** To prevent exposure to the optical drive's laser, do not attempt to disassemble or repair the optical drive by yourself. For your safety, contact a professional technician for assistance.

---

## Service warning label

---

**WARNING!** INVISIBLE LASER RADIATION WHEN OPEN. DO NOT STARE INTO BEAM OR VIEW DIRECTLY WITH OPTICAL INSTRUMENTS.

---

## CDRH Regulations

The Center for Devices and Radiological Health (CDRH) of the U.S. Food and Drug Administration implemented regulations for laser products on August 2, 1976. These regulations apply to laser products manufactured from August 1, 1976. Compliance is mandatory for products marketed in the United States.

---

**WARNING!** Use of controls or adjustments or performance of procedures other than those specified herein or in the laser product installation guide may result in hazardous radiation exposure.

---

## ENERGY STAR complied product



ENERGY STAR is a joint program of the U.S. Environmental Protection Agency and the U.S. Department of Energy helping us all save money and protect the environment through energy efficient products and practices.

All ASUS products with the ENERGY STAR logo comply with the ENERGY STAR standard, and the power management feature is enabled by default. The monitor and computer are automatically set to sleep after 10 and 30 minutes of user inactivity. To wake your computer, click the mouse or press any key on the keyboard. Please visit <http://www.energystar.gov/powermanagement> for detail information on power management and its benefits to the environment. In addition, please visit <http://www.energystar.gov> for detail information on the ENERGY STAR joint program.

---

**NOTE:** Energy Star is NOT supported on FreeDOS and Linux-based operating systems.

---

## Global Environmental Regulation Compliance and Declaration

ASUS follows the green design concept to design and manufacture our products, and makes sure that each stage of the product life cycle of ASUS product is in line with global environmental regulations. In addition, ASUS disclose the relevant information based on regulation requirements.

Please refer to <http://csr.asus.com/english/Compliance.htm> for information disclosure based on regulation requirements ASUS is complied with:

### Japan JIS-C-0950 Material Declarations

### EU REACH SVHC

### Korea RoHS

## ASUS Recycling/Takeback Services

ASUS recycling and takeback programs come from our commitment to the highest standards for protecting our environment. We believe in providing solutions for you to be able to responsibly recycle our products, batteries, other components as well as the packaging materials.

Please go to <http://csr.asus.com/english/Takeback.htm> for detailed recycling information in different regions.

## Rechargeable Battery Recycling Service in North America



For US and Canada customers, you can call 1-800-822-8837 (toll-free) for recycling information of your ASUS products' rechargeable batteries.

## Coating Notice

---

**IMPORTANT!** To provide electrical insulation and maintain electrical safety, a coating is applied to insulate the device except on the areas where the I/O ports are located.

---

## Regional notice for California



### WARNING

Cancer and Reproductive Harm -  
[www.P65Warnings.ca.gov](http://www.P65Warnings.ca.gov)

## Regional notice for Singapore

Complies with  
IMDA Standards  
DB103778

This ASUS product complies with IMDA Standards.

## REACH

Complying with the REACH (Registration, Evaluation, Authorization, and Restriction of Chemicals) regulatory framework, we publish the chemical substances in our products at ASUS REACH website at <http://csr.asus.com/english/REACH.htm>.

## Prevention of Hearing Loss

To prevent possible hearing damage, do not listen at high volume levels for long periods.



## National Telecommunications Commission of the Philippines



This ASUS product complies with NTC Standards.

No. ESD-1817296C

## Change of Address Notification

ASUS Computer International will be moving to a new location on August 1st, 2018. The new address and telephone number will be as follows:

Address: 48720 Kato Rd., Fremont, CA 94538, USA

Telephone Number: (510)739-3777

Please note that the address printed on the packaging box, user manual and FCC Compliance information will no longer be available, but the compliance and declaration will still be the same.