



ROG GR8

User Guide

E11581

Revised Edition V3

April 2016

COPYRIGHT INFORMATION

No part of this manual, including the products and software described in it, may be reproduced, transmitted, transcribed, stored in a retrieval system, or translated into any language in any form or by any means, except documentation kept by the purchaser for backup purposes, without the express written permission of ASUSTeK COMPUTER INC. ("ASUS").

ASUS PROVIDES THIS MANUAL "AS IS" WITHOUT WARRANTY OF ANY KIND, EITHER EXPRESS OR IMPLIED, INCLUDING BUT NOT LIMITED TO THE IMPLIED WARRANTIES OR CONDITIONS OF MERCHANTABILITY OR FITNESS FOR A PARTICULAR PURPOSE. IN NO EVENT SHALL ASUS, ITS DIRECTORS, OFFICERS, EMPLOYEES OR AGENTS BE LIABLE FOR ANY INDIRECT, SPECIAL, INCIDENTAL, OR CONSEQUENTIAL DAMAGES (INCLUDING DAMAGES FOR LOSS OF PROFITS, LOSS OF BUSINESS, LOSS OF USE OR DATA, INTERRUPTION OF BUSINESS AND THE LIKE), EVEN IF ASUS HAS BEEN ADVISED OF THE POSSIBILITY OF SUCH DAMAGES ARISING FROM ANY DEFECT OR ERROR IN THIS MANUAL OR PRODUCT.

Products and corporate names appearing in this manual may or may not be registered trademarks or copyrights of their respective companies, and are used only for identification or explanation and to the owners' benefit, without intent to infringe.

SPECIFICATIONS AND INFORMATION CONTAINED IN THIS MANUAL ARE FURNISHED FOR INFORMATIONAL USE ONLY, AND ARE SUBJECT TO CHANGE AT ANY TIME WITHOUT NOTICE, AND SHOULD NOT BE CONSTRUED AS A COMMITMENT BY ASUS. ASUS ASSUMES NO RESPONSIBILITY OR LIABILITY FOR ANY ERRORS OR INACCURACIES THAT MAY APPEAR IN THIS MANUAL, INCLUDING THE PRODUCTS AND SOFTWARE DESCRIBED IN IT.

Copyright © 2016 ASUSTeK COMPUTER INC. All Rights Reserved.

LIMITATION OF LIABILITY

Circumstances may arise where because of a default on ASUS' part or other liability, you are entitled to recover damages from ASUS. In each such instance, regardless of the basis on which you are entitled to claim damages from ASUS, ASUS is liable for no more than damages for bodily injury (including death) and damage to real property and tangible personal property; or any other actual and direct damages resulted from omission or failure of performing legal duties under this Warranty Statement, up to the listed contract price of each product.

ASUS will only be responsible for or indemnify you for loss, damages or claims based in contract, tort or infringement under this Warranty Statement.

This limit also applies to ASUS' suppliers and its reseller. It is the maximum for which ASUS, its suppliers, and your reseller are collectively responsible.

UNDER NO CIRCUMSTANCES IS ASUS LIABLE FOR ANY OF THE FOLLOWING: (1) THIRD-PARTY CLAIMS AGAINST YOU FOR DAMAGES; (2) LOSS OF, OR DAMAGE TO, YOUR RECORDS OR DATA; OR (3) SPECIAL, INCIDENTAL, OR INDIRECT DAMAGES OR FOR ANY ECONOMIC CONSEQUENTIAL DAMAGES (INCLUDING LOST PROFITS OR SAVINGS), EVEN IF ASUS, ITS SUPPLIERS OR YOUR RESELLER IS INFORMED OF THEIR POSSIBILITY.

SERVICE AND SUPPORT

Visit our multi-language web site at <https://www.asus.com/support>

Contents

- About this manual 5
 - Conventions used in this manual 5
 - Typography..... 5
- Package contents 6

Getting to know your ROG GR8

- Features 8
 - Front panel..... 8
 - Bottom view 10
 - Top view 10
 - Rear panel 11

Using your ROG GR8

- Getting started 16
 - Positioning your ROG GR8..... 16
 - Connecting the AC power adapter 17
 - Connecting a display panel 19
 - Connecting the keyboard or mouse..... 20
 - Turning on your ROG GR8 21
- Using the Miracast Receiver 22
- Recovering your system..... 25
 - Resetting your PC 25
 - Recovering from a system image file 26
 - Removing everything and reinstalling Windows..... 27
- Turning off your ROG GR8..... 28
- Putting your ROG GR8 to sleep 28
- Entering the BIOS Setup 28
 - Quickly enter the BIOS..... 29

Contents

Upgrading your ROG GR8

Upgrading memory modules	32
Installing a 2.5-inch storage drive	37

Appendix

Safety information	44
Setting up your system.....	44
Care during use	45
Regulatory notices.....	46
ASUS contact information	52

About this manual

This manual provides information about the hardware and software features of your PC, organized through the following chapters:

Chapter 1: Getting to know your ROG GR8

This chapter details the hardware components of your ROG GR8.

Chapter 2: Using your ROG GR8

This chapter provides you with information on using your ROG GR8.

Chapter 3: Upgrading your ROG GR8

This chapter provides information on how to upgrade the memory modules and the storage drive of your ROG GR8.

Appendix

This section includes notices and safety statements your ROG GR8.

Conventions used in this manual

To highlight key information in this manual, some text are presented as follows:

IMPORTANT! This message contains vital information that must be followed to complete a task.

NOTE: This message contains additional information and tips that can help complete tasks.

WARNING! This message contains important information that must be followed to keep you safe while performing certain tasks and prevent damage to your ROG GR8's data and components.

Typography

Bold text

Indicates a menu or an item to select.

Italic

This indicates sections that you can refer to in this manual.

Package contents

Your ROG GR8 package contains the following items:

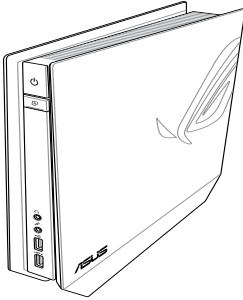

ROG GR8



Technical documentations

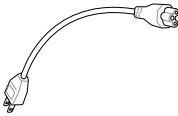

Power cable*

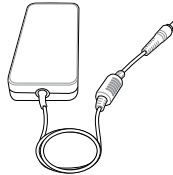

AC power adapter*



set of screws

NOTE: * Actual product specifications and package contents may vary depending on your country or region.

IMPORTANT! Bring the warranty card to the ASUS Service Center for replacement of the defective components if the device or its components fail or malfunction during normal and proper use within the warranty period.

1

Getting to know your ROG GR8

Features

Front panel

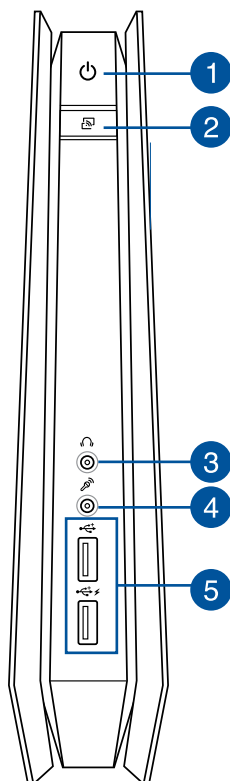



Power button

The power button allows you to turn the ROG GR8 on or off.



Miracast Receiver button

The Miracast Receiver button allows you to mirror the display from other Miracast-enabled devices.



Headphone jack

This port allows you to connect amplified speakers or headphones.



Microphone

The built-in microphone can be used for video conferencing, voice narrations, or simple audio recording.



USB 2.0 port (with USB charger feature)

The USB (Universal Serial Bus) port is compatible with USB 2.0 or USB 1.1 devices such as keyboards, pointing devices, flash disk drives, external HDDs, speakers, cameras and printers.

The USB 2.0 port with the ⚡ icon comes with a **USB Charger** feature that allows charging of mobile devices even while your ROG GR8 is on sleep, hibernate, or S5 mode.

Bottom view

Top view

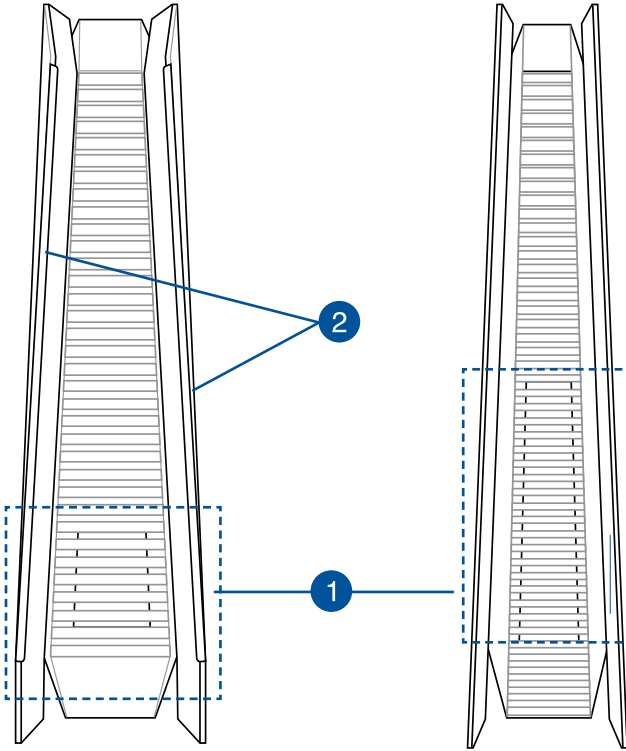

1

Air vents

The air vents allow cooler air to enter your ROG GR8 chassis and expel hot air out.

IMPORTANT! For optimum heat dissipation and air ventilation, ensure that the air vents are free from obstructions.

2

Rubber feet

The rubber feet helps prevent the ROG GR8 from slipping thus providing more stability when the ROG GR8 is in a stand-up position.

Rear panel

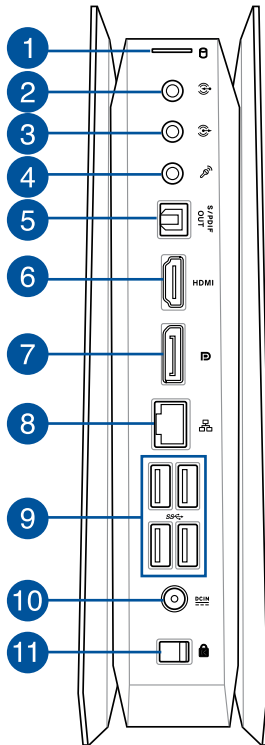

HDD/Drive LED indicator

This indicator lights up when your ROG GR8 is accessing the internal storage drives.



Audio Input Jack

This 1/8-inch stereo input jack can be used to connect a stereo audio source to the ROG GR8. This feature is used mainly to add audio to multimedia applications.



Audio Output Jack

This stereo audio jack is used to connect the system's audio out signal to amplified speakers.



Microphone jack

The microphone jack allows you to connect an external microphone for video conferencing, voice narrations, or simple audio recordings.



Digital audio out port (S/PDIF optical)

The Sony/Philips Digital Interface (S/PDIF) optical out port allows you to transfer digital audio from your ROG GR8 into an amplifier or your TV.



HDMI port

This port is for the HDMI (High-Definition Multimedia Interface) connector and is HDCP compliant for HD DVD, Blu-ray, and other protected content playback.



DisplayPort port

Use this port to connect your ROG GR8 to a DisplayPort external display.



LAN port

The 8-pin RJ-45 LAN port supports a standard Ethernet cable for connection to a local network.



USB 3.0 ports

The USB 3.0 (Universal Serial Bus 3.0) port provides a transfer rate up to 5 Gbit/s and is backward compatible to USB 2.0.

10



Power input (DC 19V)

The supplied power adapter converts AC power to DC power for use with this jack. Power supplied through this jack supplies power to the PC. To prevent damage to the PC, always use the bundled power adapter.

WARNING! The power adapter may become warm to hot when in use. Do not cover the adapter and keep it away from your body.

11



Cover lock latch + Kensington security slot

The cover lock latch fastens the side cover on your ROG GR8.

The Kensington security slot allows you to secure your ROG GR8 using Kensington® security products.

2

Using your ROG GR8

Getting started

Positioning your ROG GR8

The ROG GR8 can be positioned standing up or lying down. When positioning your ROG GR8, ensure that the rubber studs or the rubber feet are in contact with the flat and stable surface of your table or desk.

Standing up

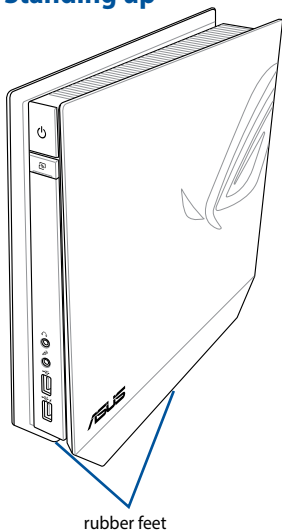

Lying down

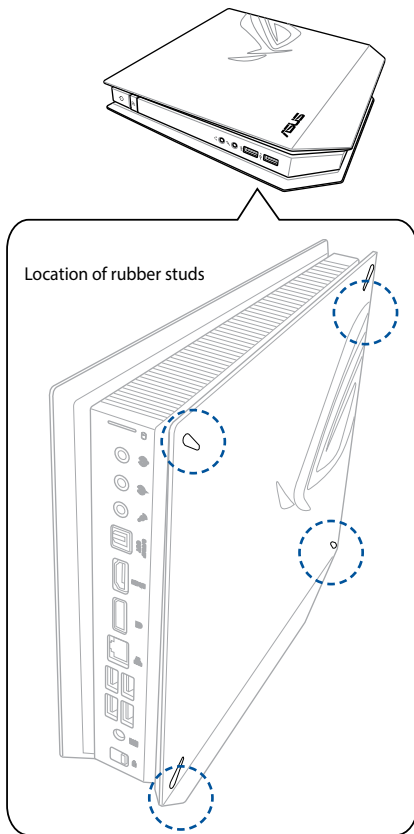

Connecting the AC power adapter

To connect the AC power adapter to your ROG GR8:

- A. Connect the AC power cord to the AC/DC adapter.
- B. Plug the AC power cord into a 100V~240V power source.
- C. Connect the DC power connector into your ROG GR8's power (DC) input port.

NOTE: The power adapter may vary in appearance, depending on your region.

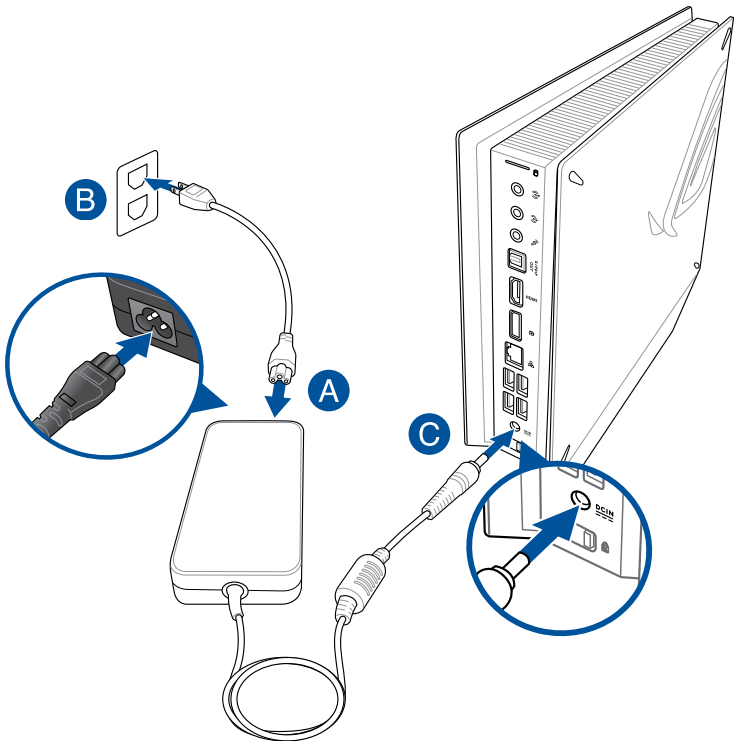

IMPORTANT!

- We strongly recommend that you use only the AC power adapter and cable that came with your ROG GR8.
 - Use a grounded wall socket while using your ROG GR8.
 - The socket outlet must be easily accessible and near your ROG GR8.
 - To disconnect your ROG GR8 from its main power supply, unplug your ROG GR8 from the power socket.
-

Connecting a display panel

You can connect a display panel or projector to your ROG GR8 that has the following connectors:

- HDMI connector
- DisplayPort connector
- VGA connector (use with a DisplayPort to VGA adapter or HDMI to VGA adapter)
- DVI connector (use with an HDMI to DVI adapter)

NOTE: The HDMI to DVI adapter, DisplayPort to VGA adapter, or HDMI to VGA adapter are each sold separately.

To connect a display panel to your ROG GR8:

Connect a display cable either to the HDMI or DisplayPort port.

Connecting display via HDMI port

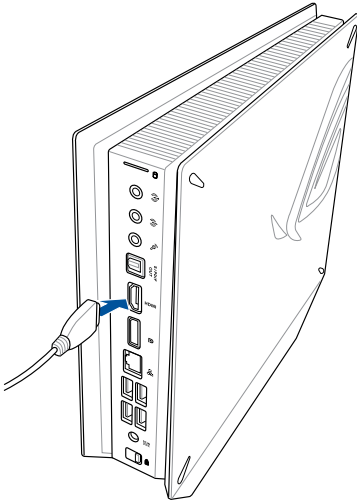

Connecting display via DisplayPort port

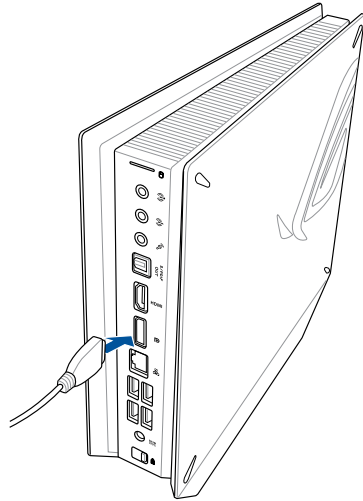

HDMI[™]
HIGH-DEFINITION MULTIMEDIA INTERFACE

Connecting the keyboard or mouse

You can connect generally any USB keyboard and mouse to your ROG GR8. You can also connect a USB dongle for a wireless keyboard and mouse set.

To connect a keyboard and mouse to your ROG GR8:

Connect the USB cable from your keyboard and mouse to any of the USB 2.0/3.0 ports of your ROG GR8.

Connecting a USB keyboard or mouse

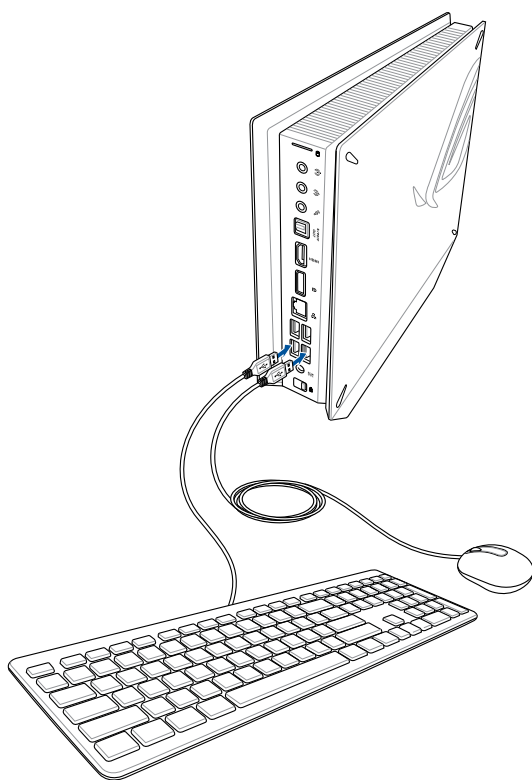

Turning on your ROG GR8

Press the power button to turn on your ROG GR8.

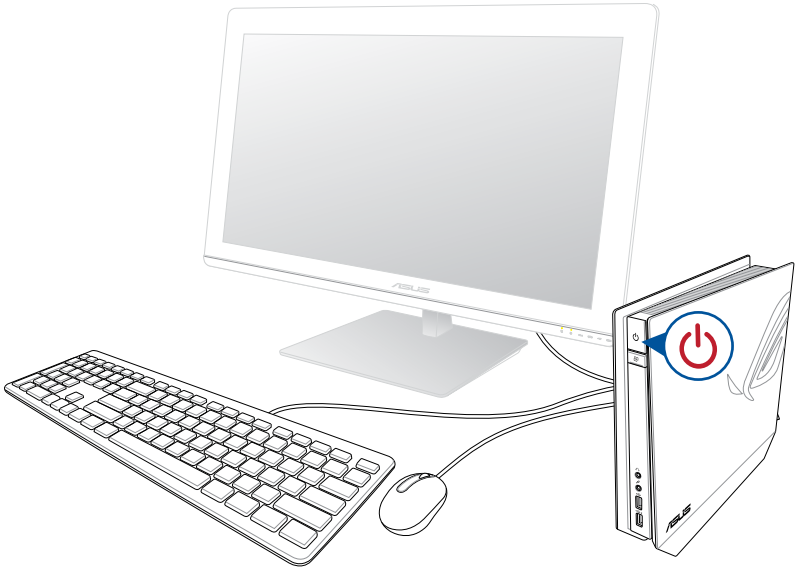

Using the Miracast Receiver

The ROG GR8 allows you to mirror the display from other Miracast-enabled devices or PC via the Miracast Receiver function.

NOTE: The Miracast display is supported only on the HDMI port.

Connecting Miracast-enabled Android device

1. Connect the bundled power adapter to your ROG GR8.
2. Press the Miracast Receiver button.

NOTE: The LED on the Miracast Receiver button lights up and turns to red to indicate that the Miracast Receiver function is enabled.

3. On the Miracast-enabled Android device, ensure that the Wi-Fi options is set to **ON** then locate and open the Miracast app.

NOTE:

- Miracast is also known as Wireless Display, Screen Mirroring, or All Share Cast on some Android™ devices.
 - Miracast is supported on Android™ devices running on 4.2 or later versions.
-

4. Set the Search for display then refer to the SSID shown on your the ROG GR8. Select the SSID of ROG GR8 and pair it with your Miracast-enabled Android device.

Connecting Windows® devices

1. Connect the bundled power adapter to your ROG GR8.
2. Press the Miracast Receiver button.

NOTE: The LED on the Miracast Receiver button lights up and turns to red to indicate that the Miracast Receiver function is enabled.

3. Add your device.

- For Windows® 8.1 /Windows® 8.1 PRO, call out the Charms bar then select **Devices > Project > Add a wireless display**. From the **Add a wireless display** screen, click **Add a device**.

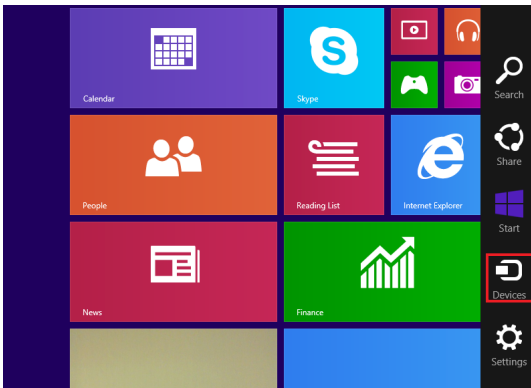

- For Windows® 10, go to **Start > Settings > Devices > Connected devices > Add devices**.

4. Key-in the WPS PIN shown on ROG GR8 to start screencasting from your Windows® device to the ROG GR8.

Connecting Intel® WiDi-supported devices

1. Turn on your ROG GR8.
2. Press the Miracast Receiver button.

NOTE: The LED on the Miracast Receiver button lights up and turns to red to indicate that the Miracast Receiver function is enabled.

3. Launch **Intel WiDi** from your device.
4. From the **Detected Adapters** window, select the ROG GR8's SSID then click **Connect**.
5. Key-in the WPS PIN shown on your TV display then click **Next**.
6. If connection is successfully made, the TV display is mirrored on ROG GR8 display.

Recovering your system

IMPORTANT! This section only applies for models with the bundled operating system installed in your ROG GR8.

Resetting your PC

The **Reset your PC** option restores your ROG GR8 to its factory default settings.

IMPORTANT! Back up all your data before using this option.

To reset your PC:

1. Press <F9> during bootup.

IMPORTANT! To go through POST, follow any of the ways described in the *Quickly enter the BIOS* section.

2. From the screen, click **Troubleshoot**.
3. Select **Reset your PC**.
4. Click **Next**.
5. Select **Only the drive where the Windows is installed**.
6. Select **Just remove my files**.
7. Click **Reset**.

Recovering from a system image file

IMPORTANT! This section only applies for models with the bundled operating system installed in your ROG GR8.

You can create a USB recovery drive and use this to recover your PC's settings.

Creating a USB recovery drive

WARNING! All files on your USB storage device will be permanently deleted during the process. Before you proceed, ensure that you back up all your important data.

To create a USB recovery drive:

1. Launch the Control Panel from the All Apps screen.
2. From the Control Panel's System and Security, click **Action Center**.
3. Click **Recovery > Create a recovery drive**.
4. Click **Next**.
5. Select the USB storage device where you want to copy the recovery files.
6. Click **Next**.
7. Click **Create**. Wait for the process to complete.
8. When done, click **Finish**.

Removing everything and reinstalling Windows

IMPORTANT! This section only applies for models with the bundled operating system installed in your ROG GR8.

Restoring your ROG GR8 to its original factory settings can be done using the **Remove everything and reinstall** option in PC Settings. Refer to the steps below to use this option.

IMPORTANT! Back up all your data before using this option.

NOTE: This process may take a while to complete.

To get started, go to **Settings > Update & security > Reset this PC > Get started** and choose an option.

Turning off your ROG GR8

Click Shutdown in Windows® operating system. If your ROG GR8 is unresponsive, press and hold the power button for at least four (4) seconds until your ROG GR8 turns off.

Putting your ROG GR8 to sleep

To put your ROG GR8 on Sleep mode, press the Power button once.

Entering the BIOS Setup

BIOS (Basic Input and Output System) stores system hardware settings that are needed for system startup in the ROG GR8.

In normal circumstances, the default BIOS settings apply to most conditions to ensure optimal performance. Do not change the default BIOS settings except in the following circumstances:

- An error message appears on the screen during the system bootup and requests you to run the BIOS Setup.
- You have installed a new system component that requires further BIOS settings or update.

WARNING! Inappropriate BIOS settings may result to instability or boot failure. We strongly recommend that you change the BIOS settings only with the help of a trained service personnel.

Quickly enter the BIOS

To quickly enter the BIOS:

- Turn off your ROG GR8, then press the power button to turn your ROG GR8 back on, and then press <F2> or during POST.
- When your ROG GR8 is off, disconnect the power cord from your ROG GR8's power connector. Reconnect the power cable and press the power button to turn on your ROG GR8. Press <F2> or during POST.

NOTE: POST (Power-On Self Test) is a series of software controlled diagnostic tests that run when you turn on your PC.

3

Upgrading your ROG GR8

Upgrading memory modules

Your ROG GR8 comes with two SO-DIMM memory slots that allow you to install up to two 8 GB DDR3L 204-pin SO-DIMMs for a maximum of 16 GB memory.

IMPORTANT! You can only install DDR3L (1.35V Low Voltage) 204-pin SO-DIMM to the ROG GR8's DIMM slots.

NOTE: Refer to <http://www.asus.com> for the list of compatible DIMMs.

To install or upgrade the memory modules:

1. Turn off your ROG GR8.
2. Disconnect all cables and peripherals.
3. Place the ROG GR8 on its side on a stable and flat surface.
4. Move down the latch at the rear panel to unlock the side cover.

NOTE: Before you remove the side cover, ensure that the UNLOCK label on the latch is visible.

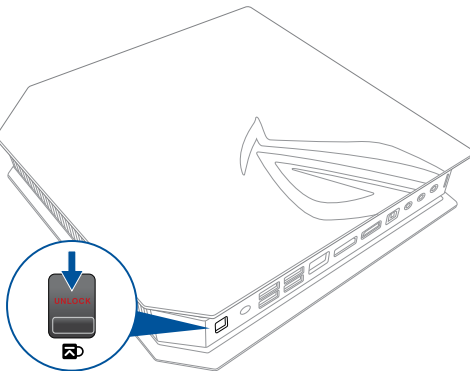

5. Slide the side cover towards the rear to detach it from the chassis then gently lift to remove it from the chassis.



6. Pry open the SO-DIMM slot cover.

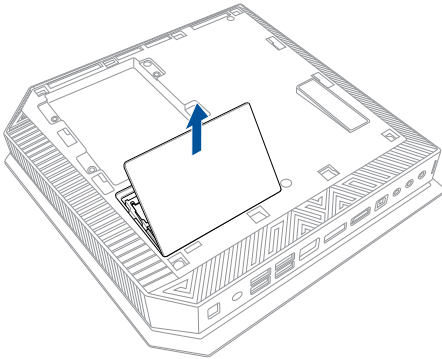

7. Remove the memory modules.

To remove a memory module:

- A. Press the retaining clips on each side to release the memory module.
- B. Carefully remove the memory module.
- C. Repeat steps A and B to remove the other memory module.

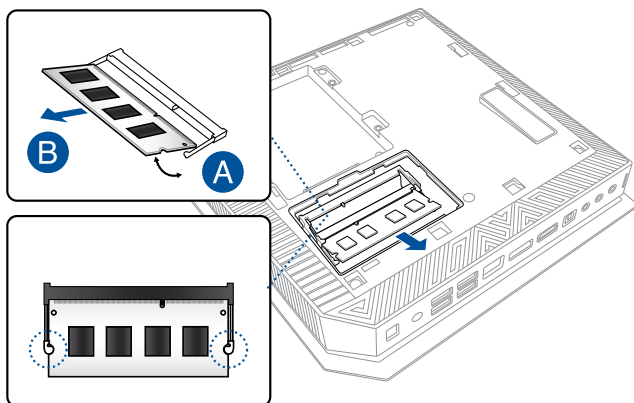

NOTE:

- Use the same model and speed when replacing memory modules.
 - Remove the upper memory module first if you wish to replace the lower memory module.
-

8. Get the replacement memory modules.
9. Install the new memory modules into the slot.

IMPORTANT! Always install on the lower slot first when installing one or two modules.

To install a new memory module:

Align and insert the memory module into the slot (A) then press it down (B) until it is securely seated in place.

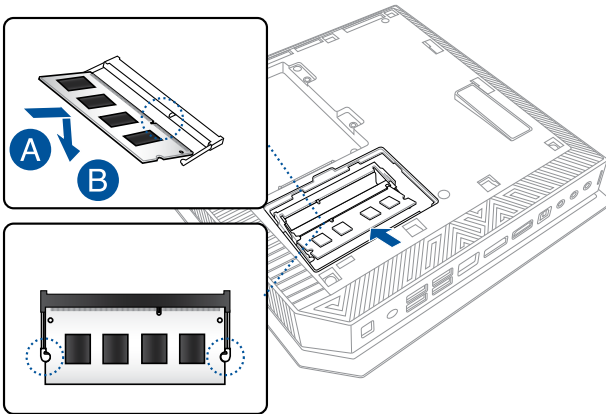

10. Replace the SO-DIMM slot cover. Ensure that it is fitted firmly back into its place.

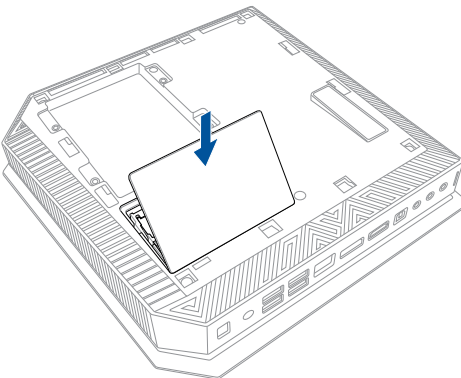

11. Replace the side cover then slide it towards the front of ROG GR8 to re-attach.

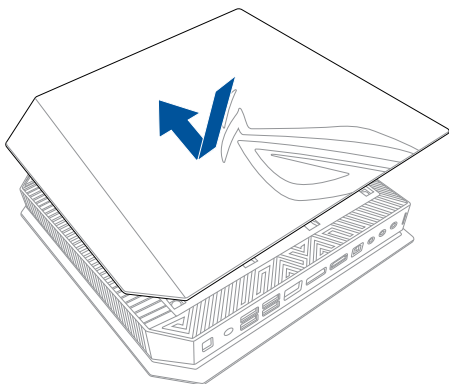

12. Press the latch upward to securely fasten the side cover to the chassis.

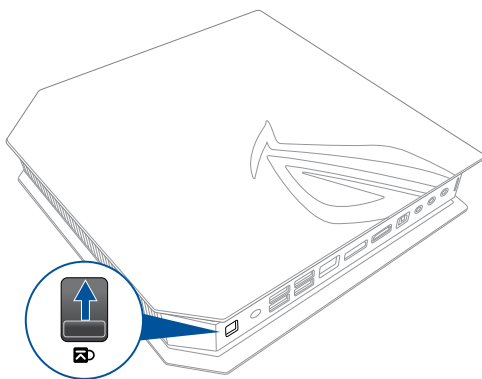

Installing a 2.5-inch storage drive

The ROG GR8 supports one 2.5-inch HDD or one 2.5-inch SSD for additional storage capacity.

To install a 2.5-inch HDD or SSD:

1. Turn off your ROG GR8.
2. Disconnect all cables and peripherals.
3. Place the ROG GR8 on its side on a stable and flat surface.
4. Press down the latch at the rear panel to unlock the side cover.

NOTE: Before you remove the side cover, ensure that the UNLOCK label on the latch is visible.

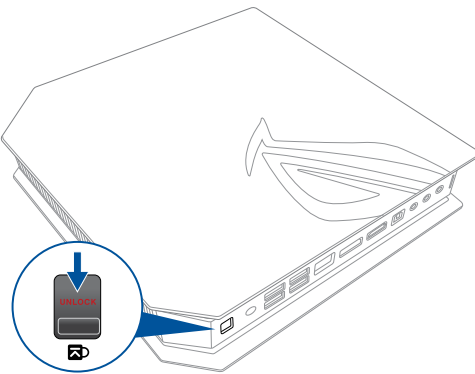

5. Slide the side cover towards the rear to detach it from the chassis then gently lift to remove it from the chassis.



6. Remove the four screws that secures the 2.5-inch HDD/SSD extension bay.
7. Using the flap, pull the extension bay to remove it from the chassis.

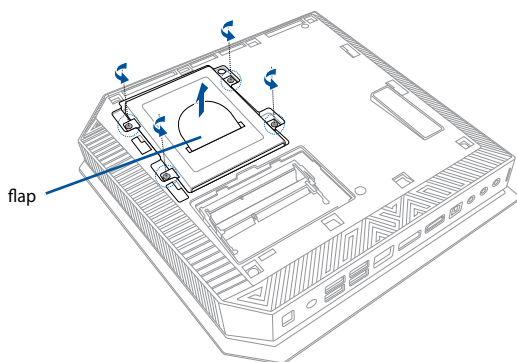

8. Prepare the 2.5-inch HDD/SSD and the bundled set of four screws.
9. Turn the extension bay upside down and place the 2.5-inch HDD/SSD into the extension bay as shown. Ensure that screw holes on the 2.5-inch HDD/SSD matches the screw holes on the extension bay.

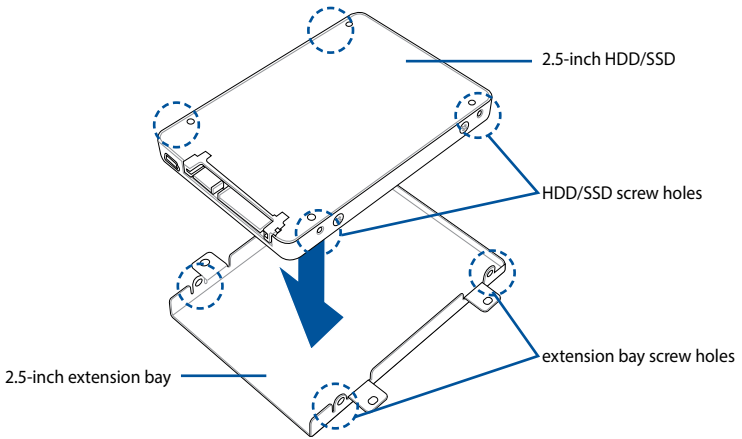

10. Secure the 2.5-inch HDD/SSD to the extension bay using the bundled set of screws.

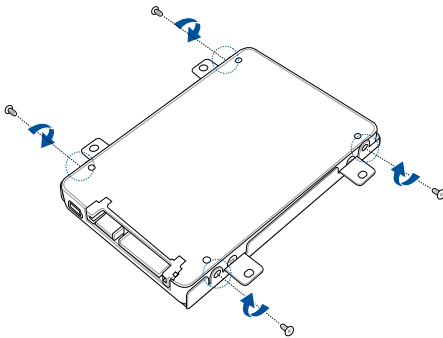

11. Carefully place the 2.5-inch HDD/SSD and extension bay assembly into the drive bay then slide it towards the SATA connector.

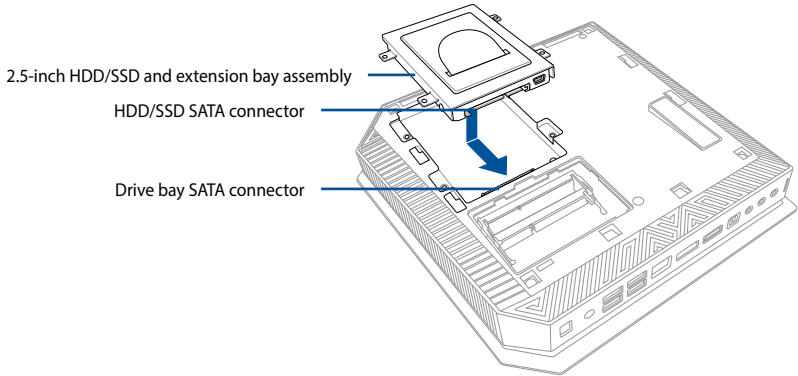

12. Secure the 2.5-inch extension bay with four screws.

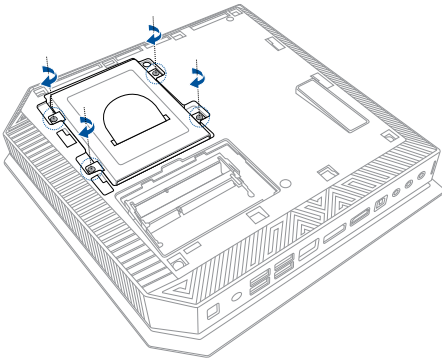

13. Replace the side cover then slide it towards the front of ROG GR8 to re-attach.

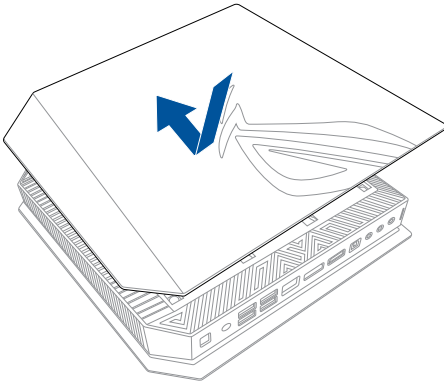

14. Move the latch upward to securely fasten the side cover to the chassis.

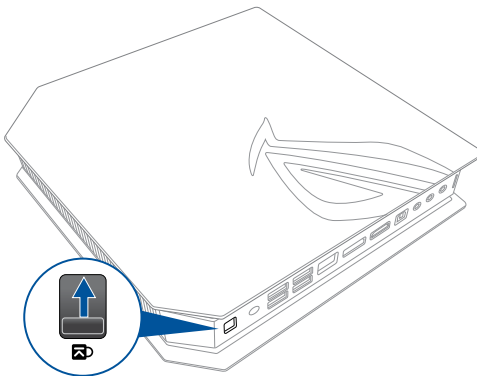



Appendix

Safety information

Your ROG GR8 is designed and tested to meet the latest standards of safety for information technology equipment. However, to ensure your safety, it is important that you read the following safety instructions.

Setting up your system

- Read and follow all instructions in the documentation before you operate your system.
- Do not use this product near water or a heated source.
- Set up the system on a stable surface.
- Openings on the chassis are for ventilation. Do not block or cover these openings. Make sure you leave plenty of space around the system for ventilation. Never insert objects of any kind into the ventilation openings.
- Use this product in environments with ambient temperatures between 0°C and 35°C.
- If you use an extension cord, make sure that the total ampere rating of the devices plugged into the extension cord does not exceed its ampere rating.

Care during use

- Do not walk on the power cord or allow anything to rest on it.
- Do not spill water or any other liquids on your system.
- When the system is turned off, a small amount of electrical current still flows. Always unplug the power cord from the power outlets before cleaning the system.
- If you encounter the following technical problems with the product, unplug the power cord and contact a qualified service technician or your retailer.
 - The power cord or plug is damaged.
 - Liquid has been spilled into the system.
 - The system does not function properly even if you follow the operating instructions.
 - The system was dropped or the cabinet is damaged.
 - The system performance changes.

Lithium-Ion Battery Warning

CAUTION: Danger of explosion if battery is incorrectly replaced. Replace only with the same or equivalent type recommended by the manufacturer. Dispose of used batteries according to the manufacturer's instructions.

NO DISASSEMBLY

The warranty does not apply to the products that have been disassembled by users



DO NOT throw the ROG GR8 in municipal waste. This product has been designed to enable proper reuse of parts and recycling. This symbol of the crossed out wheeled bin indicates that the product (electrical, electronic equipment, and mercury-containing button cell battery) should not be placed in municipal waste. Check local technical support services for product recycling.

Regulatory notices

REACH

Complying with the REACH (Registration, Evaluation, Authorization, and Restriction of Chemicals) regulatory framework, we publish the chemical substances in our products at ASUS REACH website at <http://csr.asus.com/english/REACH.htm>

ASUS Recycling/Takeback Services

ASUS recycling and takeback programs come from our commitment to the highest standards for protecting our environment. We believe in providing solutions for you to be able to responsibly recycle our products, batteries, other components, as well as the packaging materials. Please go to <http://csr.asus.com/english/Takeback.htm> for the detailed recycling information in different regions.

COATING NOTICE

IMPORTANT! To provide electrical insulation and maintain electrical safety, a coating is applied to insulate the device except on the areas where the I/O ports are located.

Federal Communications Commission Statement

This device complies with Part 15 of the FCC Rules. Operation is subject to the following two conditions:

- This device may not cause harmful interference, and
- This device must accept any interference received including interference that may cause undesired operation.

This equipment has been tested and found to comply with the limits for a Class B digital device, pursuant to Part 15 of the FCC Rules.

These limits are designed to provide reasonable protection against harmful interference in a residential installation. This equipment generates, uses and can radiate radio frequency energy and, if not installed and used in accordance with manufacturer's instructions, may cause harmful interference to radio communications. However, there is no guarantee that interference will not occur in a particular installation. If this equipment does cause harmful interference to

radio or television reception, which can be determined by turning the equipment off and on, the user is encouraged to try to correct the interference by one or more of the following measures:

- Reorient or relocate the receiving antenna.
- Increase the separation between the equipment and receiver.
- Connect the equipment to an outlet on a circuit different from that to which the receiver is connected.
- Consult the dealer or an experienced radio/TV technician for help.

CAUTION: Any changes or modifications not expressly approved by the grantee of this device could void the user's authority to operate the equipment.

RF exposure warning

This equipment must be installed and operated in accordance with provided instructions and the antenna(s) used for this transmitter must be installed to provide a separation distance of at least 20 cm from all persons and must not be co-located or operating in conjunction with any other antenna or transmitter. End-users and installers must be provide with antenna installation instructions and transmitter operating conditions for satisfying RF exposure compliance.

Declaration of Conformity (R&TTE directive 1999/5/EC)

The following items were completed and are considered relevant and sufficient:

- Essential requirements as in [Article 3]
- Protection requirements for health and safety as in [Article 3.1a]
- Testing for electric safety according to [EN 60950]
- Protection requirements for electromagnetic compatibility in [Article 3.1b]
- Testing for electromagnetic compatibility according to [EN 301 489-1] & [EN 301 489-17]
- Effective use of the radio spectrum as in [Article 3.2]
- Radio test suites according to [EN 300 328-2]

France Restricted Wireless Frequency Bands

Some areas of France have a restricted frequency band. The worst case maximum authorized power indoors are:

- 10mW for the entire 2.4 GHz band (2400 MHz–2483.5 MHz)
- 100mW for frequencies between 2446.5 MHz and 2483.5 MHz

NOTE: Channels 10 through 13 inclusive operate in the band 2446.6 MHz to 2483.5 MHz.

There are few possibilities for outdoor use: On private property or on the private property of public persons, use is subject to a preliminary authorization procedure by the Ministry of Defense, with maximum authorized power of 100mW in the 2446.5–2483.5 MHz band. Use outdoors on public property is not permitted.

In the departments listed below, for the entire 2.4 GHz band:

- Maximum authorized power indoors is 100mW
- Maximum authorized power outdoors is 10mW

Departments in which the use of the 2400–2483.5 MHz band is permitted with an EIRP of less than 100mW indoors and less than 10mW outdoors:

01	Ain	02	Aisne	03	Allier
05	Hautes Alpes	08	Ardennes	09	Ariège
11	Aude	12	Aveyron	16	Charente
24	Dordogne	25	Doubs	26	Drôme
32	Gers	36	Indre	37	Indre et Loire
41	Loir et Cher	45	Loiret	50	Manche
55	Meuse	58	Nièvre	59	Nord
60	Oise	61	Orne	63	Puy du Dôme
64	Pyrénées Atlantique	66	Pyrénées Orientales	67	Bas Rhin
70	Haute Saône	71	Saône et Loire	75	Paris
82	Tarn et Garonne	84	Vaucluse	88	Vosges
89	Yonne	90	Territoire de Belfort	94	Val de Marne

This requirement is likely to change over time, allowing you to use your wireless LAN card in more areas within France. Please check with ART for the latest information (www.art-telecom.fr)

NOTE: Your WLAN Card transmits less than 100mW, but more than 10mW.

Canadian Department of Communications Statement

This digital apparatus does not exceed the Class B limits for radio noise emissions from digital apparatus set out in the Radio Interference Regulations of the Canadian Department of Communications.

This class B digital apparatus complies with Canadian ICES-003.

IC Radiation Exposure Statement for Canada

This equipment complies with IC radiation exposure limits set forth for an uncontrolled environment. To maintain compliance with IC RF exposure compliance requirements, please avoid direct contact to the transmitting antenna during transmitting. End users must follow the specific operating instructions for satisfying RF exposure compliance.

Operation is subject to the following two conditions:

- This device may not cause interference and
- This device must accept any interference, including interference that may cause undesired operation of the device.

CE Mark Warning



CE marking for devices without wireless LAN/Bluetooth

The shipped version of this device complies with the requirements of the EEC directives 2004/108/EC “Electromagnetic compatibility” and 2006/95/EC “Low voltage directive”.



CE marking for devices with wireless LAN/ Bluetooth

This equipment complies with the requirements of Directive 1999/5/EC of the European Parliament and Commission from 9 March, 1999 governing Radio and Telecommunications Equipment and mutual recognition of conformity.

Wireless Operation Channel for Different Domains

N. America	2.412-2.462 GHz	Ch01 through CH11
Japan	2.412-2.484 GHz	Ch01 through Ch14
Europe ETSI	2.412-2.472 GHz	Ch01 through Ch13

ENERGY STAR complied product



ENERGY STAR is a joint program of the U.S. Environmental Protection Agency and the U.S. Department of Energy helping us all save money and protect the environment through energy efficient products and practices.

All ASUS products with the ENERGY STAR logo comply with the ENERGY STAR standard, and the power management feature is enabled by default. The monitor and computer are automatically set to sleep after 10 and 30 minutes of user inactivity. To wake your computer, click the mouse or press any key on the keyboard.

Please visit <http://www.energystar.gov/powermanagement> for detail information on power management and its benefits to the environment. In addition, please visit <http://www.energystar.gov> for detail information on the ENERGY STAR joint program.

NOTE: Energy Star is NOT supported on FreeDOS and Linux-based products.

ASUS contact information

ASUSTeK COMPUTER INC.

Address 4F, No. 150, Li-Te Rd., Peitou, Taipei 112, Taiwan
Telephone +886-2-2894-3447
Fax +886-2-2890-7798
Web site www.asus.com/

Technical Support

Telephone +86-21-38429911
Fax +86-21-5866-8722, ext. 9101#
Online support <http://qr.asus.com/techserv>

ASUS COMPUTER INTERNATIONAL (America)

Address 800 Corporate Way, Fremont, CA 94539, USA
Telephone +1-510-739-3777
Fax +1-510-608-4555
Web site <http://www.asus.com/us/>

Technical Support

Support fax +1-812-284-0883
Telephone +1-812-282-2787
Online support <http://qr.asus.com/techserv>

ASUS COMPUTER GmbH (Germany and Austria)

Address Harkort Str. 21-23, D-40880 Ratingen, Germany
Fax +49-2102-959911
Web site <http://www.asus.com/de>
Online contact <http://eu-rma.asus.com/sales>

Technical Support

Telephone +49-1805-010923*
Support Fax +49-2102-9599-11
Online support <http://qr.asus.com/techserv>

Manufacturer	ASUSTeK Computer Inc.	
	Tel:	+886-2-2894-3447
	Address:	4F, No. 150, LI-TE RD., PEITOU, TAIPEI 112, TAIWAN
Authorised representative in Europe	ASUSTeK Computer GmbH	
	Address:	HARKORT STR. 21-23, 40880 RATINGEN, GERMANY

EU Declaration of Conformity



We, the undersigned,

Manufacturer:	ASUSTeK COMPUTER INC.
Address:	4F, No. 150, LI-TE Rd., PEITOU, TAIPEI 112, TAIWAN
Authorized representative in Europe:	ASUS COMPUTER GmbH
Address, City:	HARKORT STR. 21-23, 40880 RATINGEN
Country:	GERMANY

declare the following apparatus:

Product name :	Desktop PC
Model name :	GR8,GR6

The object of the declaration described above is in conformity with the relevant Union harmonisation legislation:

<input checked="" type="checkbox"/> EMC – Directive 2004/108/EC (until April 19th, 2016) and Directive 2014/30/EU (from April 20th, 2016)	
<input checked="" type="checkbox"/> EN 55022:2010+AC:2011	<input checked="" type="checkbox"/> EN 55024:2010
<input checked="" type="checkbox"/> EN 61000-3-2:2006+A2:2009	<input checked="" type="checkbox"/> EN 61000-3-3:2013
<input type="checkbox"/> EN 55013:2001+A1:2003+A2:2006	<input type="checkbox"/> EN 55020:2007+A11:2011
<input checked="" type="checkbox"/> R&TTE – Directive 1999/5/EC	
<input checked="" type="checkbox"/> EN 300 328 V1.8.1(2012-06)	<input checked="" type="checkbox"/> EN 301 489-1 V1.9.2(2011-09)
<input type="checkbox"/> EN 300 440-1 V1.6.1(2010-08)	<input type="checkbox"/> EN 301 489-3 V1.6.1(2013-12)
<input type="checkbox"/> EN 300 440-2 V1.4.1(2010-08)	<input type="checkbox"/> EN 301 489-4 V2.1.1(2013-12)
<input type="checkbox"/> EN 301 511 V9.0.2(2003-03)	<input type="checkbox"/> EN 301 489-7 V1.3.1(2005-11)
<input type="checkbox"/> EN 301 908-1 V6.2.1(2013-04)	<input type="checkbox"/> EN 301 489-9 V1.4.1(2007-11)
<input type="checkbox"/> EN 301 908-2 V6.2.1(2013-10)	<input checked="" type="checkbox"/> EN 301 489-17 V2.2.1(2012-09)
<input type="checkbox"/> EN 301 908-13 V6.2.1(2014-02)	<input type="checkbox"/> EN 301 489-24 V1.5.1(2010-09)
<input checked="" type="checkbox"/> EN 301 893 V1.7.1(2012-06)	<input type="checkbox"/> EN 301 357-2 V1.4.1(2008-11)
<input type="checkbox"/> EN 300 330-2 V1.5.1(2010-02)	<input type="checkbox"/> EN 302 291-2 V1.1.1(2005-07)
<input type="checkbox"/> EN 50360:2001/A1:2012	<input type="checkbox"/> EN 302 623 V1.1.1(2009-01)
<input type="checkbox"/> EN 62479:2010	<input type="checkbox"/> EN 50566:2013/AC:2014
<input type="checkbox"/> EN 62311:2008	<input type="checkbox"/> EN 50385:2002
<input checked="" type="checkbox"/> LVD – Directive 2006/95/EC (until April 19th, 2016) and Directive 2014/35/EU (from April 20th, 2016)	
<input checked="" type="checkbox"/> EN 60950-1: 2006 / A12: 2011	<input type="checkbox"/> EN 60065:2002 / A12: 2011
<input checked="" type="checkbox"/> Ecodesign – Directive 2009/125/EC	
<input checked="" type="checkbox"/> Regulation (EC) No. 1275/2008	<input checked="" type="checkbox"/> Regulation (EC) No. 278/2009
<input type="checkbox"/> Regulation (EC) No. 642/2009	<input checked="" type="checkbox"/> Regulation (EU) No. 617/2013
<input checked="" type="checkbox"/> RoHS – Directive 2011/65/EU	
<input checked="" type="checkbox"/> CE marking	
<input checked="" type="checkbox"/> Equipment Class 2	

Ver. 160217



(EU conformity marking)

Signature	Taipei, Taiwan Place of issue
Jerry Shen	09/03/2015
Printed Name	Original Declaration Date
CEO	24/2/2016
Position	Corrected Declaration Date
	2016
	Year to begin affixing CE marking

DECLARATION OF CONFORMITY

Per FCC Part 2 Section 2. 1077(a)



Responsible Party Name: Asus Computer International

Address: 800 Corporate Way, Fremont, CA 94539.

Phone/Fax No: (510)739-3777/(510)608-4555

hereby declares that the product

Product Name : Desktop PC

Model Number : GR8

Conforms to the following specifications:

FCC Part 15, Subpart B, Unintentional Radiators

Supplementary Information:

This device complies with part 15 of the FCC Rules. Operation is subject to the following two conditions: (1) This device may not cause harmful interference, and (2) this device must accept any interference received, including interference that may cause undesired operation.

Representative Person's Name : Steve Chang / President

A handwritten signature in blue ink that reads "Steve Chang".

Signature :

Date : Aug. 29, 2014

Ver. 140331