

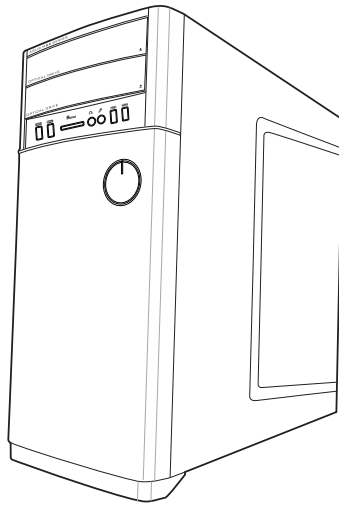

Desktop PC M52BC User Guide



E9584

First Edition

July 2014

Copyright © 2014 ASUSTeK Computer Inc. All Rights Reserved.

No part of this manual, including the products and software described in it, may be reproduced, transmitted, transcribed, stored in a retrieval system, or translated into any language in any form or by any means, except documentation kept by the purchaser for backup purposes, without the express written permission of ASUSTeK Computer Inc. ("ASUS").

Product warranty or service will not be extended if: (1) the product is repaired, modified or altered, unless such repair, modification or alteration is authorized in writing by ASUS; or (2) the serial number of the product is defaced or missing.

ASUS PROVIDES THIS MANUAL "AS IS" WITHOUT WARRANTY OF ANY KIND, EITHER EXPRESS OR IMPLIED, INCLUDING BUT NOT LIMITED TO THE IMPLIED WARRANTIES OR CONDITIONS OF MERCHANTABILITY OR FITNESS FOR A PARTICULAR PURPOSE. IN NO EVENT SHALL ASUS, ITS DIRECTORS, OFFICERS, EMPLOYEES OR AGENTS BE LIABLE FOR ANY INDIRECT, SPECIAL, INCIDENTAL, OR CONSEQUENTIAL DAMAGES (INCLUDING DAMAGES FOR LOSS OF PROFITS, LOSS OF BUSINESS, LOSS OF USE OR DATA, INTERRUPTION OF BUSINESS AND THE LIKE), EVEN IF ASUS HAS BEEN ADVISED OF THE POSSIBILITY OF SUCH DAMAGES ARISING FROM ANY DEFECT OR ERROR IN THIS MANUAL OR PRODUCT.

SPECIFICATIONS AND INFORMATION CONTAINED IN THIS MANUAL ARE FURNISHED FOR INFORMATIONAL USE ONLY, AND ARE SUBJECT TO CHANGE AT ANY TIME WITHOUT NOTICE, AND SHOULD NOT BE CONSTRUED AS A COMMITMENT BY ASUS. ASUS ASSUMES NO RESPONSIBILITY OR LIABILITY FOR ANY ERRORS OR INACCURACIES THAT MAY APPEAR IN THIS MANUAL, INCLUDING THE PRODUCTS AND SOFTWARE DESCRIBED IN IT.

Products and corporate names appearing in this manual may or may not be registered trademarks or copyrights of their respective companies, and are used only for identification or explanation and to the owners' benefit, without intent to infringe.

Contents

Notices	5
Safety information	8
Conventions used in this guide.....	9
Where to find more information.....	9
Package contents	10
Chapter 1 Getting started	
Welcome!.....	11
Getting to know your computer.....	11
Setting up your computer.....	16
Turning your computer ON/OFF.....	18
Chapter 2 Connecting devices to your computer	
Connecting a USB storage device	19
Connecting microphone and speakers.....	20
Connecting multiple external displays	23
Connecting an HDTV	24
Chapter 3 Using your computer	
Proper posture when using your Desktop PC.....	25
Using the memory card reader	26
Using the optical drive	27
Chapter 4 Connecting to the Internet	
Wired connection.....	29
Wi-Fi connection (on selected models only).....	31
Chapter 5 Troubleshooting	
Troubleshooting	33
Appendix Windows® 8.1 User Manual	
Starting for the first time	49
Windows® 8.1 lock screen.....	49
Using the Windows® UI	50
Working with Windows® apps.....	53
Other keyboard shortcuts.....	58

Contents

Turning your Desktop PC OFF59
Putting your Desktop PC to sleep59
Entering the BIOS Setup60
Recovering your system.....61

ASUS contact information

ASUS contact information.....64

Notices

ASUS Recycling/Takeback Services

ASUS recycling and takeback programs come from our commitment to the highest standards for protecting our environment. We believe in providing solutions for you to be able to responsibly recycle our products, batteries, other components, as well as the packaging materials. Please go to <http://csr.asus.com/english/Takeback.htm> for the detailed recycling information in different regions.

REACH

Complying with the REACH (Registration, Evaluation, Authorisation, and Restriction of Chemicals) regulatory framework, we published the chemical substances in our products at ASUS REACH website at <http://csr.asus.com/english/REACH.htm>

Federal Communications Commission Statement

This device complies with Part 15 of the FCC Rules. Operation is subject to the following two conditions:

- This device may not cause harmful interference; and
- This device must accept any interference received including interference that may cause undesired operation.

This equipment has been tested and found to comply with the limits for a Class B digital device, pursuant to Part 15 of the FCC Rules. These limits are designed to provide reasonable protection against harmful interference in a residential installation. This equipment generates, uses and can radiate radio frequency energy and, if not installed and used in accordance with manufacturer's instructions, may cause harmful interference to radio communications. However, there is no guarantee that interference will not occur in a particular installation. If this equipment does cause harmful interference to radio or television reception, which can be determined by turning the equipment off and on, the user is encouraged to try to correct the interference by one or more of the following measures:

- Reorient or relocate the receiving antenna.
- Increase the separation between the equipment and receiver.
- Connect the equipment to an outlet on a circuit different from that to which the receiver is connected.
- Consult the dealer or an experienced radio/TV technician for help.



The use of shielded cables for connection of the monitor to the graphics card is required to assure compliance with FCC regulations. Changes or modifications to this unit not expressly approved by the party responsible for compliance could void the user's authority to operate this equipment.

Lithium Battery Warning

CAUTION: Danger of explosion if battery is incorrectly replaced. Replace only with the same or equivalent type recommended by the manufacturer. Dispose of used batteries according to the manufacturer's instructions.

MISE EN GARDE: Danger d'explosion si la pile n'est pas remplacée correctement. Remplacer uniquement avec une pile de type semblable ou équivalent, recommandée par le fabricant. Mettez au rebut les batteries usagées conformément aux instructions du fabricant.

IC: Canadian Compliance Statement

Complies with the Canadian ICES-003 Class B specifications. This device complies with RSS 210 of Industry Canada. This Class B device meets all the requirements of the Canadian interference-causing equipment regulations.

This device complies with Industry Canada license exempt RSS standard(s). Operation is subject to the following two conditions: this device may not cause interference, and (2) this device must accept any interference, including interference that may cause undesired operation of the device.

Cet appareil numérique de la Classe B est conforme à la norme NMB-003 du Canada. Cet appareil numérique de la Classe B respecte toutes les exigences du Règlement sur le matériel brouilleur du Canada.

Cet appareil est conforme aux normes CNR exemptes de licence d'Industrie Canada. Le fonctionnement est soumis aux deux conditions suivantes.

- (1) cet appareil ne doit pas provoquer d'interférences et
- (2) cet appareil doit accepter toute interférence, y compris celles susceptibles de provoquer un fonctionnement non souhaité de l'appareil.

Canadian Department of Communications Statement

This digital apparatus does not exceed the Class B limits for radio noise emissions from digital apparatus set out in the Radio Interference Regulations of the Canadian Department of Communications.

This class B digital apparatus complies with Canadian ICES-003.

VCCI: Japan Compliance Statement

VCCI Class B Statement

情報処理装置等電波障害自主規制について

この装置は、情報処理装置等電波障害自主規制協議会（VCCI）の基準に基づくクラスB情報技術装置です。この装置は家庭環境で使用されることを目的としていますが、この装置がラジオやテレビジョン受信機に近接して使用されると、受信障害を引き起こすことがあります。

取扱説明書に従って正しい取り扱いをして下さい。

KC: Korea Warning Statement

B급 기기 (가정용 방송통신기자재)

이 기기는 가정용(B급) 전자파적합기기로서 주로 가정에서 사용하는 것을 목적으로 하며, 모든 지역에서 사용할 수 있습니다.

*당해 무선설비는 전파혼신 가능성이 있으므로 인명안전과 관련된 서비스는 할 수 없습니다.

RF Equipment Notices

CE: European Community Compliance Statement

The equipment complies with the RF Exposure Requirement 1999/519/EC, Council Recommendation of 12 July 1999 on the limitation of exposure of the general public to electromagnetic fields (0–300 GHz). This wireless device complies with the R&TTE Directive.

Wireless Radio Use

This device is restricted to indoor use when operating in the 5.15 to 5.25 GHz frequency band.

Exposure to Radio Frequency Energy

The radiated output power of the Wi-Fi technology is below the FCC radio frequency exposure limits. Nevertheless, it is advised to use the wireless equipment in such a manner that the potential for human contact during normal operation is minimized.

FCC Bluetooth Wireless Compliance

The antenna used with this transmitter must not be colocated or operated in conjunction with any other antenna or transmitter subject to the conditions of the FCC Grant.

Bluetooth Industry Canada Statement

This Class B device meets all requirements of the Canadian interference-causing equipment regulations.

Cet appareil numérique de la Class B respecte toutes les exigences du Règlement sur le matériel brouilleur du Canada.

BSMI: Taiwan Wireless Statement

無線設備的警告聲明

經型式認證合格之低功率射頻電機，非經許可，公司、商號或使用者均不得擅自變更射頻、加大功率或變更原設計之特性及功能。低功率射頻電機之使用不得影響飛航安全及干擾合法通信；經發現有干擾現象時，應立即停用，並改善至無干擾時方得繼續使用。前項合法通信指依電信法規定作業之無線通信。低功率射頻電機須忍受合法通信或工業、科學及醫療用電波輻射性電機設備之干擾。

於 5.25GHz 至 5.35GHz 區域內操作之
無線設備的警告聲明

工作頻率 5.250 ~ 5.350GHz 該頻段限於室內使用。

Japan RF Equipment Statement

この製品は、周波数帯域5.15～5.35GHzで動作しているときは、屋内においてのみ使用可能です。

KC (RF Equipment)

대한민국 규정 및 준수

방통위 고시에 따른 고지사항

해당 무선설비는 운용 중 전파혼신 가능성이 있음,

이 기기는 인명안전과 관련된 서비스에 사용할 수 없습니다.

Safety information



Disconnect the AC power and peripherals before cleaning. Wipe the Desktop PC using a clean cellulose sponge or chamois cloth dampened with solution of nonabrasive detergent and a few drops of warm water then remove any extra moisture with a dry cloth.

- **DO NOT** place on uneven or unstable work surfaces. Seek servicing if the casing has been damaged.
- **DO NOT** expose to dirty or dusty environments. **DO NOT** operate during a gas leak.
- **DO NOT** place or drop objects on top and do not shove any foreign objects into the Desktop PC.
- **DO NOT** expose to strong magnetic or electrical fields.
- **DO NOT** expose to or use near liquids, rain, or moisture. **DO NOT** use the modem during electrical storms.
- Battery safety warning: **DO NOT** throw the battery in fire. **DO NOT** short circuit the contacts. **DO NOT** disassemble the battery.
- Use this product in environments with ambient temperatures between 0°C (32°F) and 40°C (104°F).
- **DO NOT** cover the vents on the Desktop PC to prevent the system from getting overheated.
- **DO NOT** use damaged power cords, accessories, or other peripherals.
- To prevent electrical shock hazard, disconnect the power cable from the electrical outlet before relocating the system.
- Seek professional assistance before using an adapter or extension cord. These devices could interrupt the grounding circuit.
- Ensure that your power supply is set to the correct voltage in your area. If you are not sure about the voltage of the electrical outlet you are using, contact your local power company.
- If the power supply is broken, do not try to fix it by yourself. Contact a qualified service technician or your retailer.



Hazardous moving parts. Desktop should be completely shutdown before servicing product. Replacing fan components should only be attempted by qualified service personnel.

Hazardous Moving Parts Warning

WARNING: Keep fingers and other body parts away from any moving parts.

Conventions used in this guide

To ensure that you perform certain tasks properly, take note of the following symbols used throughout this manual.



DANGER/WARNING: Information to prevent injury to yourself when trying to complete a task.



CAUTION: Information to prevent damage to the components when trying to complete a task.



IMPORTANT: Instructions that you **MUST** follow to complete a task.



NOTE: Tips and additional information to help you complete a task.

Where to find more information

Refer to the following sources for additional information and for product and software updates.

ASUS websites

The ASUS website provides updated information on ASUS hardware and software products. Refer to the ASUS website www.asus.com.

ASUS Local Technical Support







Visit ASUS website at <http://support.asus.com/contact> for the contact information of local Technical Support Engineer.

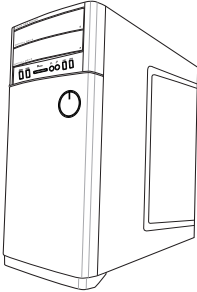

The User Guide is located in the following folder in your Desktop PC:

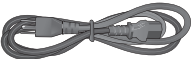
C:\Program Files(X86)\ASUS\eManual

Package contents

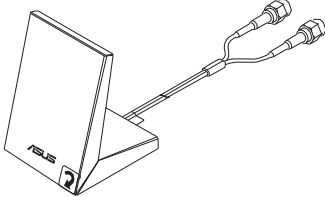
		
<p>ASUS Desktop PC</p>	<p>Keyboard x1</p>	<p>Mouse x1</p>
		
<p>Power cord x1</p>	<p>Installation Guide x1</p>	<p>Warranty Card x1</p>
		
<p>DVD/SDVD/RDVD (Optional)</p>	<p>Dipole antenna x1 (optional)</p>	



- If any of the above items is damaged or missing, contact your retailer.
- The illustrated items above are for reference only. Actual product specifications may vary with different models.

Chapter 1

Getting started

Welcome!

Thank you for purchasing the ASUS Desktop PC!

The ASUS Desktop PC provides cutting-edge performance, uncompromised reliability, and user-centric utilities. All these values are encapsulated in a stunningly futuristic and stylish system casing.



Read the ASUS Warranty Card before setting up your ASUS Desktop PC.

Getting to know your computer



Illustrations are for reference only. The ports, their locations and the chassis color vary with different models.

Front panel

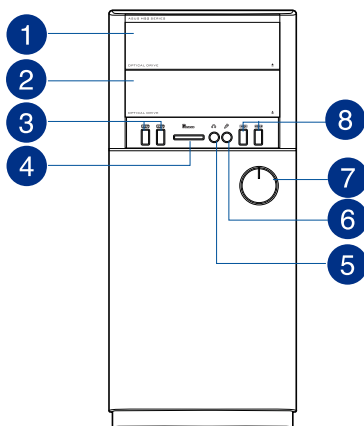

- 1 **Optical disk drive bay.** There is an optical disk drive in this bay.
- 2 **Optical disk drive bay (empty).** Allows you to install an additional optical disk drive in this bay.
- 3 **USB 3.0 ports.** These Universal Serial Bus 3.0 (USB 3.0) ports connect to USB 3.0 devices such as a mouse, printer, scanner, camera, PDA, and others.



- DO NOT connect a keyboard / mouse to any USB 3.0 port when installing Windows® operating system.
- Due to USB 3.0 controller limitation, USB 3.0 devices can only be used under Windows® OS environment and after the USB 3.0 driver installation.
- USB 3.0 devices can only be used as data storage only.
- We strongly recommend that you connect USB 3.0 devices to USB 3.0 ports for faster and better performance for your USB 3.0 devices.

- 4 **8-in-1 card slot.** Supports Secure Digital™ (SD) / Secure Digital™ High Capacity (SDHC) / Secure Digital™ Extended Capacity (SDXC) / MultiMediaCard (MMC) / Multimedia Card Plus (MMC-Plus) / Memory Stick™ (MS) / Memory Stick Pro™ (MS-Pro) / xD format card.
- 5 **Headphone port.** This port connects to a headphone or speaker. Supported by ASUS Audio Wizard.
- 6 **Microphone port.** This port connects to a microphone.

- 7 **Power button.** Press this button to turn on your computer.
- 8 **USB 2.0 ports.** These Universal Serial Bus 2.0 (USB 2.0) ports connect to USB 2.0 devices such as a mouse, printer, scanner, camera, PDA, and others.

Rear panel

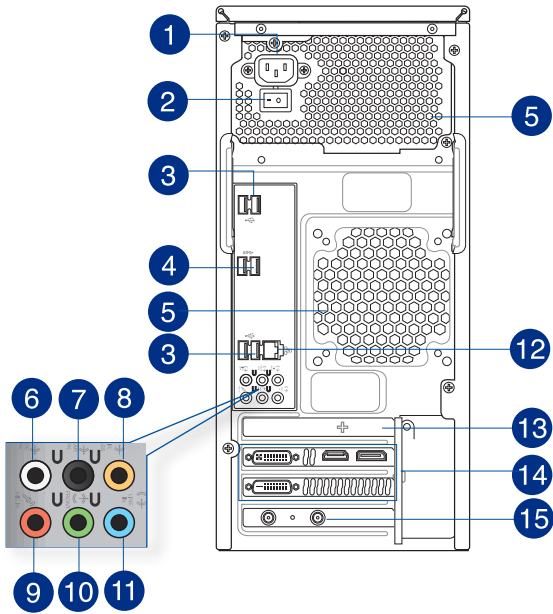

- 1 **Power connector.** Plug the power cord to this connector.



RATING: 115Vac/220-230Vac, 7A/4A, 60/50Hz.

2 Power switch. Switch to turn ON/OFF the power supply to your computer.

3 USB 2.0 ports. These Universal Serial Bus 2.0 (USB 2.0) ports connect to USB 2.0 devices such as a mouse, printer, scanner, camera, PDA, and others.

4 USB 3.0 ports. These Universal Serial Bus 3.0 (USB 3.0) ports connect to USB 3.0 devices such as a mouse, printer, scanner, camera, PDA, and others.



- DO NOT connect a keyboard / mouse to any USB 3.0 port when installing Windows® operating system.
- Due to USB 3.0 controller limitation, USB 3.0 devices can only be used under Windows® OS environment and after the USB 3.0 driver installation.
- USB 3.0 devices can only be used as data storage only.
- We strongly recommend that you connect USB 3.0 devices to USB 3.0 ports for faster and better performance for your USB 3.0 devices.

5 Air vents. These vents allow air ventilation.



DO NOT block the air vents on the chassis. Always provide proper ventilation for your computer.

6 Side Speaker Out port (gray). This port connects to the side speakers in a 7.1-channel audio configuration.

7 Rear Speaker Out port (black). This port connects to the rear speakers in a 4.1, 5.1, and 7.1-channel audio configuration.

8 Center/Subwoofer port (orange). This port connects to the center/subwoofer speakers.

9 Microphone port (pink). This port connects to a microphone.

10 Line Out port (lime). This port connects to a headphone or speaker. In a 4.1, 5.1, and 7.1-channel configuration, the function of this port becomes Front Speaker Out.

11 Line In port (light blue). This port connects to a tape, CD, DVD player, or other audio sources.



Refer to the audio configuration table for the function of the audio ports in a 2.1, 4.1, 5.1, or 7.1-channel configuration.

Audio 2.1, 4.1, 5.1, or 7.1-channel configuration

Port	Headset 2.1-channel	4.1-channel	5.1-channel	7.1-channel
Light Blue	Line In	Line In	Line In	Line In
Lime	Line Out	Front Speaker Out	Front Speaker Out	Front Speaker Out
Pink	Mic In	Mic In	Mic In	Mic In
Orange	–	–	Center/Subwoofer	Center/Subwoofer
Black	–	Rear Speaker Out	Rear Speaker Out	Rear Speaker Out
Gray	–	–	–	Side Speaker Out

- 12 LAN (RJ-45) port.** This port allows Gigabit connection to a Local Area Network (LAN) through a network hub.

LAN port LED indications

Activity/Link LED		Speed LED	
Status	Description	Status	Description
OFF	No link	OFF	10Mbps connection
ORANGE	Linked	ORANGE	100Mbps connection
BLINKING	Data activity	GREEN	1Gbps connection

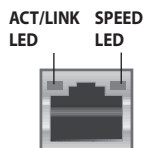

LAN port

- 13 Expansion slot bracket.** Remove the expansion slot bracket when installing an expansion card.
- 14 ASUS Graphics Cards (on selected models only).** The display output ports on these optional ASUS Graphics Cards may vary with different models.
- 15 ASUS WLAN Card (on selected models only).** This optional WLAN card allows your computer to connect to a wireless network.

Setting up your computer

This section guides you through connecting the main hardware devices, such as the external monitor, keyboard, mouse, and power cord, to your computer.

Connecting an external monitor

Using the ASUS Graphics Card (on selected models only)

Connect your monitor to the display output port on the discrete ASUS Graphics Card.

To connect an external monitor using the ASUS Graphics Card:

1. Connect a monitor to a display output port on the ASUS Graphics Card.
2. Plug the monitor to a power source.



The display output ports on the ASUS Graphics Card may vary with different models.

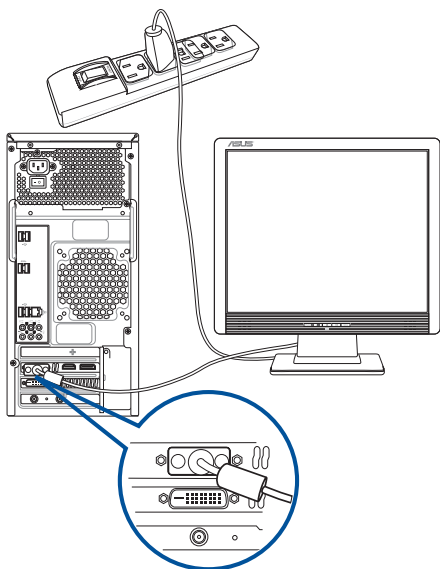

- If your computer comes with an ASUS Graphics Card, the graphics card is set as the primary display device in the BIOS. Hence, connect your monitor to a display output port on the graphics card.
 - To connect multiple external monitors to your computer, refer to **Connecting multiple external displays** of this user guide for details.
-

Connecting a USB keyboard and a USB mouse

Connect a USB keyboard and a USB mouse to the USB ports on the rear panel of your computer.

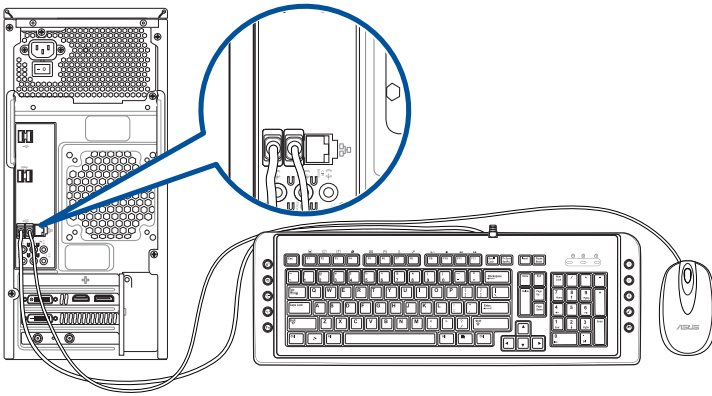

Connect your USB keyboard and USB mouse to the USB 2.0 ports.

Connecting the power cord

Connect one end of the power cord to the power connector on the rear panel of your computer and the other end to a power source.

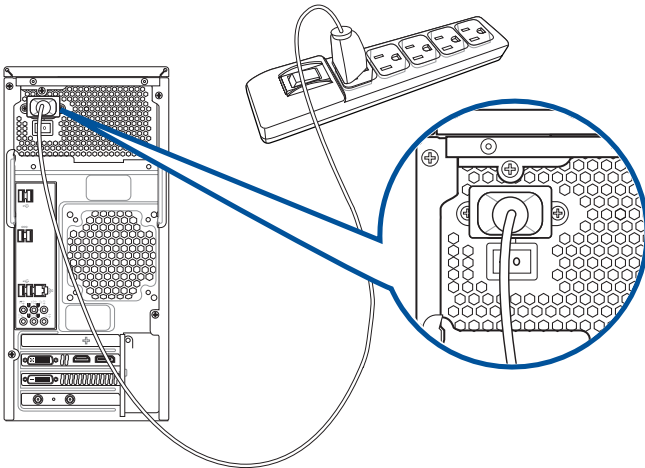

Turning your computer ON/OFF

This section describes how to turn on/off your computer after setting up your computer.

Turning your computer ON

To turn your computer ON:

1. Turn on the power switch.
2. Turn your monitor ON.
3. Press the power button on your computer.

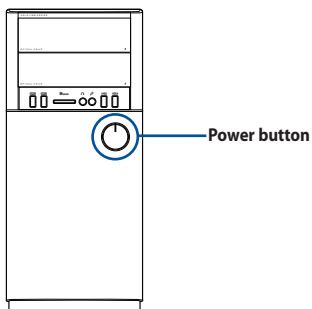

3. Wait until the operating system loads automatically.



For details on shutting down your Desktop PC, refer to the **Windows® 8.1 User Manual**, which can be found in this manual.

Chapter 2

Connecting devices to your computer

Connecting a USB storage device

This desktop PC provides USB 2.0/1.1 and USB 3.0 ports on both the front and rear panels. The USB ports allow you to connect USB devices such as storage devices.

To connect a USB storage device:

- Insert the USB storage device to your computer.

Front panel

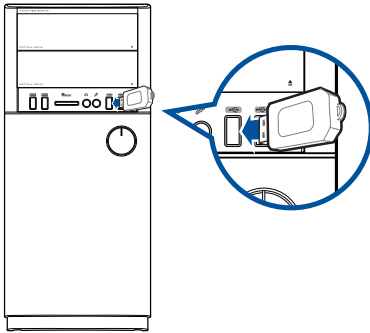

Rear panel

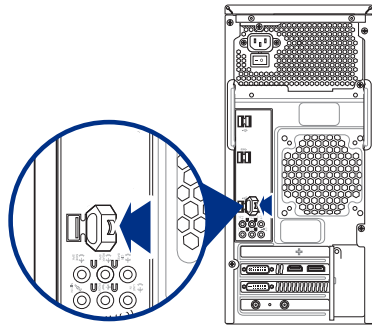

For details, refer to the section **Removing a USB storage device** in the **Windows® 8.1 User Manual**, which can be found in this manual.

Connecting microphone and speakers

This desktop PC comes with microphone ports and speaker ports on both the front and rear panels. The audio I/O ports located on the rear panel allow you to connect 2.1-channel, 4.1-channel, 5.1-channel and 7.1-channel stereo speakers.

Connecting Headphone and Mic

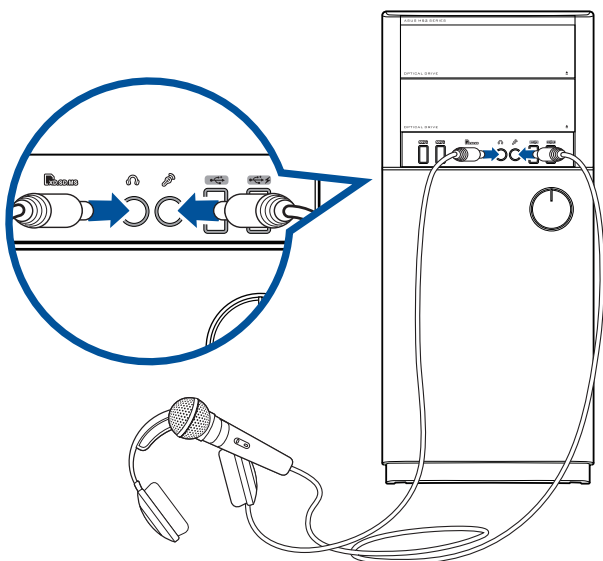

Connecting 2.1-channel Speakers

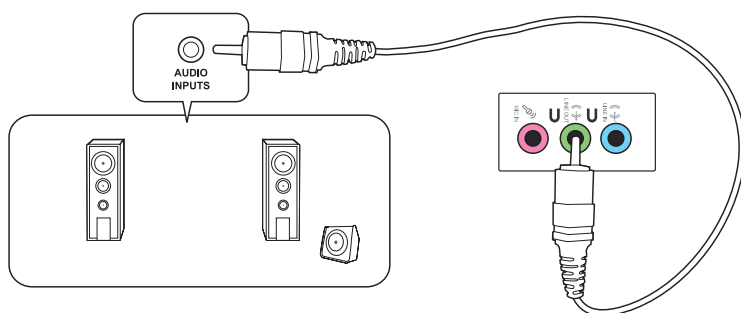

Connecting 4.1-channel Speakers

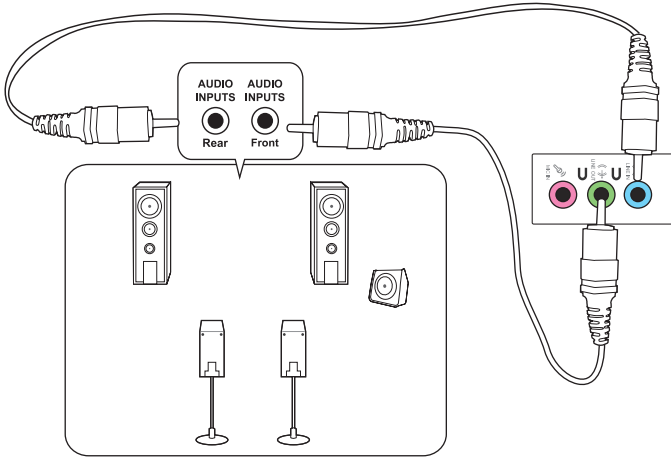

Connecting 5.1-channel Speakers

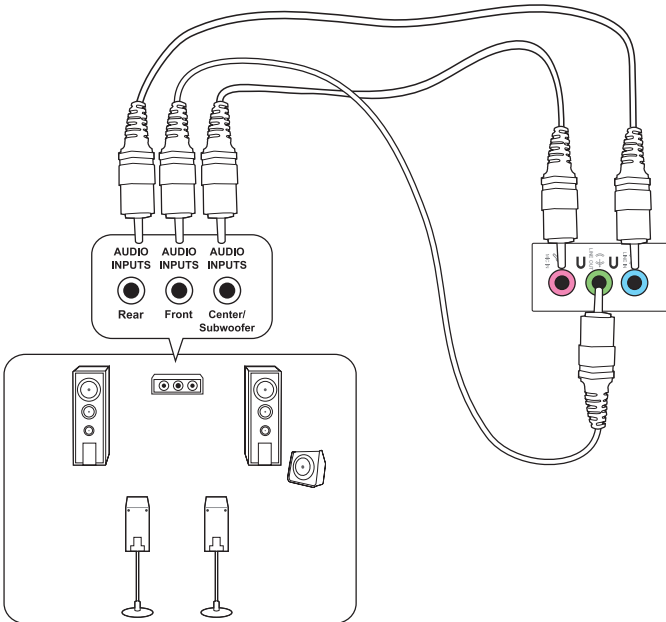

Connecting 7.1-channel Speakers

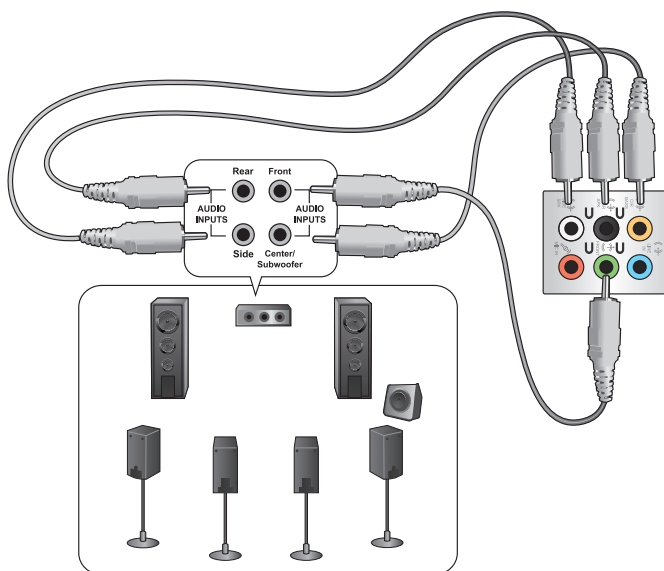

Connecting multiple external displays

Your desktop PC may come with VGA, HDMI, or DVI ports and allows you to connect multiple external displays.



When a graphics card is installed in your computer, connect the monitors on the output ports of the graphics card.

Setting up multiple displays

When using multiple monitors, you are allowed to set display modes. You can use the additional monitor as a duplicate of your main display, or as an extension to enlarge your Windows desktop.

To set up multiple displays:

1. Turn off your computer.
2. Connect the two monitors to your computer and connect the power cords to the monitors. Refer to Setting up your computer section in Chapter 1 for details on how to connect a monitor to your computer.

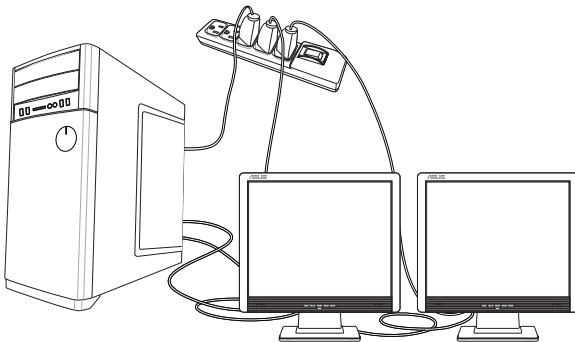

For some graphic cards, only the monitor that is set to be the primary display has display during POST. The dual display function works only under Windows.

3. Turn on your computer.
4. Configure the Screen Resolution settings.



For details, refer to the section **Configuring the Screen Resolution settings** in the **Windows® 8.1 User Manual**, which can be found in this guide.

Connecting an HDTV

Connect a High Definition TV (HDTV) to the HDMI port of your computer.



- You need an HDMI cable to connect the HDTV and the computer. The HDMI cable is purchased separately.
- To get the best display performance, ensure that your HDMI cable is less than 15 meters.

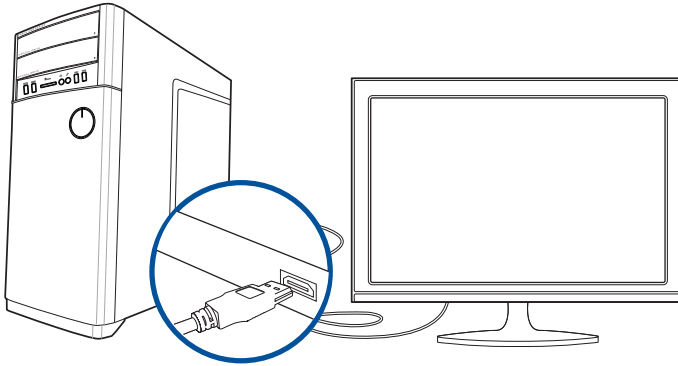

Chapter 3

Using your computer

Proper posture when using your Desktop PC

When using your Desktop PC, maintaining the proper posture is necessary to prevent strain to your wrists, hands, and other joints or muscles. This section provides you with tips on avoiding physical discomfort and possible injury while using and fully enjoying your Desktop PC.



To maintain the proper posture:

- Position your computer chair to make sure that your elbows are at or slightly above the keyboard to get a comfortable typing position.
- Adjust the height of your chair to make sure that your knees are slightly higher than your hips to relax the backs of your thighs. If necessary, use a footrest to raise the level of your knees.
- Adjust the back of your chair so that the base of your spine is firmly supported and angled slightly backward.
- Sit upright with your knees, elbows and hips at an approximately 90° angle when you are at the PC.
- Place the monitor directly in front of you, and turn the top of the monitor screen even with your eye level so that your eyes look slightly downward.
- Keep the mouse close to the keyboard, and if necessary, use a wrist rest for support to reduce the pressure on your wrists while typing.
- Use your Desktop PC in a comfortably-lit area, and keep it away from sources of glare such as windows and straight sunlight.
- Take regular mini-breaks from using your Desktop PC.

Using the memory card reader

Digital cameras and other digital imaging devices use memory cards to store digital picture or media files. The built-in memory card reader on the front panel of your system allows you to read from and write to different memory card drives.

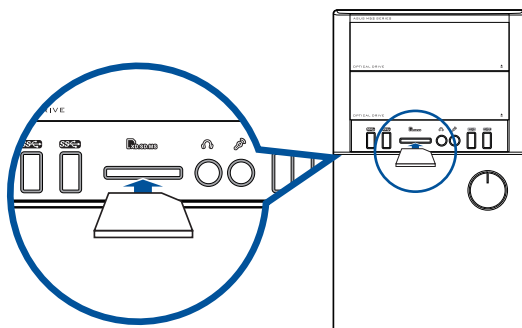

To use the memory card:

1. Insert the memory card into the card slot.



- A memory card is keyed so that it fits in only one direction. DO NOT force a card into a slot to avoid damaging the card.
- You can place media in one or more of the card slots and use each media independently. Place only one memory card in a slot at one time.

2. Select a program from the AutoPlay window to access your files.



- If AutoPlay is NOT enabled in your computer, hover your mouse pointer over the lower left corner of Windows® desktop then right-click on the Start screen's thumbnail. From the popup menu, click File Explorer, and then double-click the memory card icon to access the data on it.
- Each card slot has its own drive icon which is displayed on the Computer screen.

3. When finished, right-click the memory card drive icon on the Computer screen, click **Eject**, and then remove the card.



Hover your mouse pointer over the lower left corner of Windows® desktop then right-click on the Start screen's thumbnail. From the popup menu, click File Explorer to open the Computer screen.



Never remove cards while or immediately after reading, copying, formatting, or deleting data on the card or else data loss may occur.



To prevent data loss, use "Safely Remove Hardware and Eject Media" in the Windows® notification area before removing the memory card.

Using the optical drive

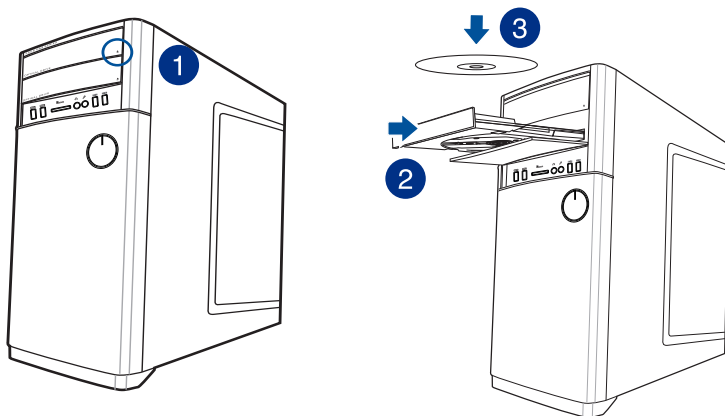

Inserting an optical disc

To insert an optical disc:

1. While your system is on, press the eject button to open the tray.
2. Place the disc on the optical drive with the label side outward if the desktop is positioned vertically and the label side up if the desktop is positioned horizontally.
3. Push the tray gently to close it.
4. Select a program from the AutoPlay window to access your files.



If AutoPlay is NOT enabled in your computer, to access the data on an optical disc:

- On Windows® 8.1, hover your mouse pointer over the lower left corner of Windows® desktop then right-click on the Start screen's thumbnail. From the popup menu, click **File Explorer**, and then double-click the CD/DVD drive icon.

Removing an optical disc

To remove an optical disc:

1. While the system is on, do either of the following to eject the tray:
 - Press the eject button below the drive bay cover.
 - Right-click the CD/DVD drive icon on the **Computer** screen, and click **Eject**.



To open the **Computer** screen on Windows® 8.1, hover your mouse pointer over the lower left corner of Windows® desktop then right-click on the Start screen's thumbnail. From the popup menu, click **File Explorer** to open the **Computer** screen.

2. Remove the disc from the disc tray.

Chapter 4

Connecting to the Internet

Wired connection

Use an RJ-45 cable to connect your computer to a DSL/cable modem or a local area network (LAN).

Connecting via a DSL/cable modem

To connect via a DSL/cable modem:

1. Set up your DSL/cable modem.



Refer to the documentation that came with your DSL/cable modem.

2. Connect one end of an RJ-45 cable to the LAN (RJ-45) port on the rear panel of your computer and the other end to a DSL/cable modem.

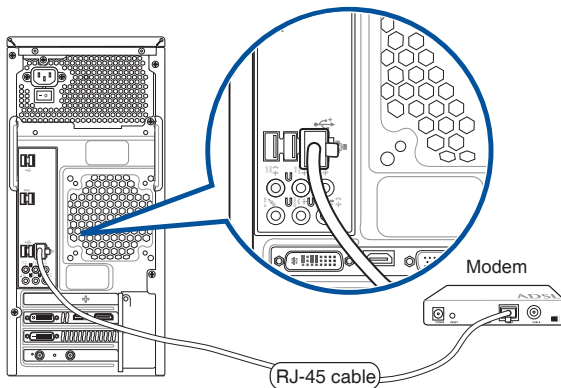

3. Turn on the DSL/cable modem and your computer.
4. Configure the necessary Internet connection settings.



-
- Contact your network administrator for details or assistance in setting up your Internet connection.
 - For details, refer to the section **Configuring the Internet connection settings** in the **Windows® 8.1 User Manual**, which can be found in this manual.
-

Connecting via a local area network (LAN)

To connect via a LAN:

1. Connect one end of an RJ-45 cable to the LAN (RJ-45) port on the rear panel of your computer and the other end to your LAN.

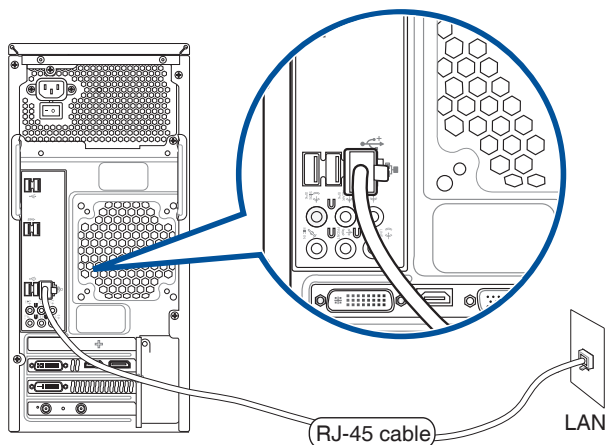

2. Turn on your computer.
3. Configure the necessary Internet connection settings.



- Contact your network administrator for details or assistance in setting up your Internet connection.
- For details, refer to the section **Configuring the Internet connection settings** in the **Windows® 8.1 User Manual**, which can be found in this manual.

Wi-Fi connection (on selected models only)

Connect your computer to the Internet through a wireless connection.



To establish a Wi-Fi connection, you need to connect to a wireless access point (AP).

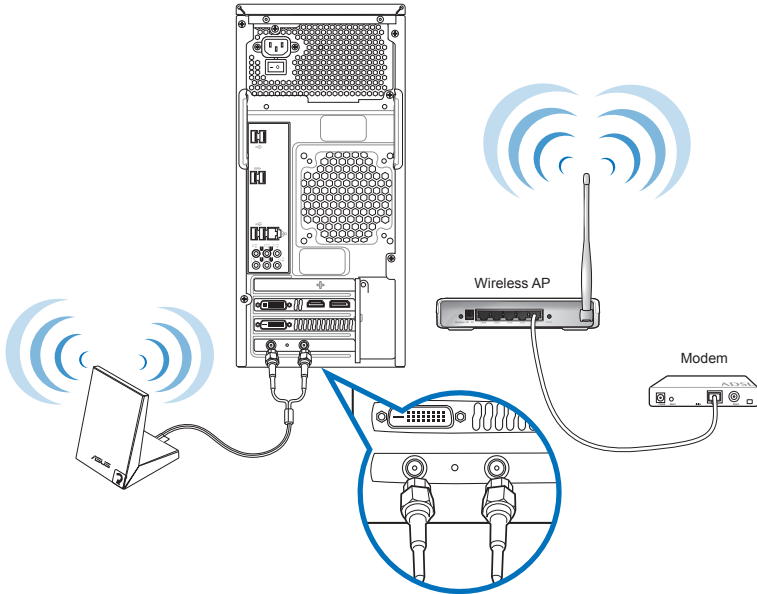

- To increase the range and sensitivity of the wireless radio signal, connect the external antennas to the antenna connectors on the ASUS WLAN Card.
- Place the antennas on the top of your computer for the best wireless performance.
- The external antennas are optional items.

Chapter 5

Troubleshooting

Troubleshooting

This chapter presents some problems you might encounter and the possible solutions.

? *My computer cannot be powered on and the power LED on the front panel does not light up.*

- Check if your computer is properly connected.
- Check if the wall outlet is functioning.
- Check if the Power Supply Unit is switched on. Refer to the section **Turning your computer ON** in Chapter 1.

? *My computer hangs.*

- Do the following to close the programs that are not responding:
 1. Simultaneously press <Alt> + <Ctrl> + <Delete> keys on the keyboard, then click **Task Manager**.
 2. Do the following based on the operating system:
On Windows® 8.1:
Under **Task Manager** in the **Processes** tab, select the program that is not responding, then click **End Task**.
- If the keyboard is not responding, press and hold the Power button on the top of your chassis until the computer shuts down. Then press the Power button to turn it on.

? *I cannot connect to a wireless network using the ASUS WLAN Card (on selected models only)?*

- Ensure that you enter the correct network security key for the wireless network you want to connect to.
- Connect the external antennas (optional) to the antenna connectors on the ASUS WLAN Card and place the antennas on the top of your computer chassis for the best wireless performance.

? *The arrow keys on the number key pad are not working.*

Check if the Number Lock LED is off. When the Number Lock LED is on, the keys on the number key pad are used to input numbers only. Press the Number Lock key to turn the LED off if you want to use the arrow keys on the number key pad.

? *No display on the monitor.*

- Check if the monitor is powered on.
- Ensure that your monitor is properly connected to the video output port on your computer.
- If your computer comes with a discrete graphics card, ensure that you connect your monitor to a video output port on the discrete graphics card.
- Check if any of the pins on the monitor video connector is bent. If you discover bent pins, replace the monitor video connector cable.
- Check if your monitor is plugged to a power source properly.
- Refer to the documentation that came with your monitor for more troubleshooting information.

? *When using multiple monitors, only one monitor has display.*

- Ensure that the both monitors are powered on.
- During POST, only the monitor connected to the VGA port has display. The dual display function works only under Windows.
- When a graphics card is installed on your computer, ensure that you connect the monitors to the output port on the graphics card.
- Check if the multiple displays settings are correct.

? *My computer cannot detect my USB storage device.*

- The first time you connect your USB storage device to your computer, Windows automatically installs a driver for it. Wait for a while and go to My Computer to check if the USB storage device is detected.
- Connect your USB storage device to another computer to test if the USB storage device is broken or malfunctions.

? ***I want to restore or undo changes to my computer's system settings without affecting my personal files or data.***

On Windows® 8.1:

You can use Windows® 8.1 **Refresh everything without affecting your files** recovery option to restore or undo changes to your computer's system settings without affecting your personal data such as documents or photos. To use this recovery option, click **Settings > PC Settings > Update and recovery > Recovery** from the Charms bar, select **Refresh everything without affecting your files**, and click **Get Started**.

? ***The picture on the HDTV is distorted.***

- It is caused by the different resolutions of your monitor and your HDTV. Adjust the screen resolution to fit your HDTV. To change the screen resolution:

On Windows® 8.1:

Do any of the following to open the **Screen Resolution** setting screen:

From the Start screen

- a) Launch the All Apps screen and pin Control Panel on the Start screen.







For details, refer to **Pinning an app on the Start screen** from the section **Working with Windows® apps**.

- b) From the Control Panel, click **Adjust screen resolution** under **Appearance and Personalization**.

From the Desktop Mode screen

- a) Launch the Desktop Mode from the Start screen.
- b) Right click anywhere on your Desktop Mode screen. When the pop-up menu appears, click **Personalize > Display > Change display settings**.

? *My speakers produce no sound.*

- Ensure that you connect your speakers to the Line out port (lime) on the front panel or the rear panel.
- Check if your speak is connected to an electrical source and turned on.
- Adjust your speakers' volume.
- Ensure that your computer's system sounds are not Muted.
 - If it is muted, the volume icon is displayed as . To enable the system sounds, click  from the Windows notification area, then click .
 - If it is not muted, click  and drag the slider to adjust the volume.
- Connect your speakers to another computer to test if the speakers arer working properly.

? *The DVD drive cannot read a disc.*

- Check if the disc is placed with the label side facing up.
- Check if the disc is centered in the tray, especially for the discs with non-standard size or shape.
- Check if the disc is scratched or damaged.

? *The DVD drive eject button is not responding.*

1. On Windows® 8.1, hover your mouse pointer over the lower left corner of Windows® desktop then right-click on the Start Screen's thumbnail. From the popup menu, click **File Explorer** to open the **Computer** screen.

2. Right-click  **DVD RW Drive**, then click **Eject** from the menu.

Power

Problem	Possible Cause	Action
No power (The power indicator is off)	Incorrect power voltage	<ul style="list-style-type: none"> • Set your computer's power voltage switch to your area's power requirements. • Adjust the voltage settings. Ensure that the power cord is unplugged from the power outlet.
	Your computer is not turned on.	Press the power key on the front panel to ensure that your computer is turned on.
	Your computer's power cord is not properly connected.	<ul style="list-style-type: none"> • Ensure that the power cord is properly connected. • Use other compatible power cord.
	PSU (Power supply unit) problems	Contact the ASUS Service Center about installing another PSU on your computer.

Display

Problem	Possible Cause	Action
No display output after turning the computer on (Black screen)	The signal cable is not connected to the correct VGA port on your computer.	<ul style="list-style-type: none"> Connect the signal cable to the correct display port (onboard VGA or discrete VGA port). If you are using a discrete VGA card, connect the signal cable to the discrete VGA port.
	Signal cable problems	Try connecting to another monitor.

LAN

Problem	Possible Cause	Action
Cannot access the Internet	The LAN cable is not connected.	Connect the LAN cable to your computer.
	LAN cable problems	Ensure the LAN LED is on. If not, try another LAN cable. If it still does not work, contact the ASUS service center.
	Your computer is not properly connected to a router or hub.	Ensure that your computer is properly connected to a router or hub.
	Network settings	Contact your Internet Service Provider (ISP) for the correct LAN settings.
	Problems caused by the anti-virus software	Close the anti-virus software.
	Driver problems	Reinstall the LAN driver

Audio

Problem	Possible Cause	Action
No Audio	Speaker or headphone is connected to the wrong port.	<ul style="list-style-type: none"> Refer to your computer's user manual for the correct port. Disconnect and reconnect the speaker to your computer.
	Speaker or headphone does not work.	Try using another speaker or headphone.
	The front and back audio ports do not work.	Try both the front and back audio ports. If one port failed, check if the port is set to multi-channel.
	Driver problems	Reinstall the audio driver

System

Problem	Possible Cause	Action
System speed is too slow	Too many programs are running.	Close some of the programs.
	Computer virus attack	<ul style="list-style-type: none"> Use an anti-virus software to scan for viruses and repair your computer. Reinstall the operating system.
The system often hangs or freezes.	Hard disk drive failure	<ul style="list-style-type: none"> Send the damaged hard disk drive to ASUS Service Center for servicing. Replace with a new hard disk drive.
	Memory module problems	<ul style="list-style-type: none"> Replace with compatible memory modules. Remove the extra memory modules that you have installed, then try again. Contact the ASUS Service Center for assistance.
	There is not enough air ventilation for your computer.	Move your computer to an area with better air flow.
	Incompatible softwares are installed.	Reinstall the OS and reinstall compatible softwares.

CPU

Problem	Possible Cause	Action
Too noisy right after turning on the computer.	Your computer is booting up.	It is normal. The fan runs on its full speed when the computer is powering on. The fan slows down after entering the OS.
	The BIOS settings have been changed.	Restore the BIOS to its default settings.
	Old BIOS version	Update the BIOS to the latest version. Visit the ASUS Support site at http://support.asus.com to download the latest BIOS versions.
Computer is too noisy when in use.	The CPU fan has been replaced.	Ensure that you are using a compatible or ASUS-recommended CPU fan.
	There is not enough air ventilation for the computer.	Ensure that your computer is working in an area with good air flow.
	The system temperature is too high.	<ul style="list-style-type: none"> • Update the BIOS. • If you know how to reinstall the motherboard, try to clean the inner space of the chassis. • Contact the ASUS Service Center for assistance.



If the problem still persists, refer to your Desktop PC's warranty card and contact the ASUS Service Center. Visit the ASUS Support site at <http://support.asus.com> for the service center information.



ASUS Desktop PC Windows® 8.1 User Manual

E8607
First Edition
August 2013
Copyright © ASUSTeK Computer Inc.
All Rights Reserved

Starting for the first time

When you start your computer for the first time, a series of screens appear to guide you in configuring the basic settings of your Windows® 8.1 operating system.

To start your Desktop PC for the first time:

1. Press the power button on your Desktop PC. Wait for a few minutes until the setup screen appears.
2. From the setup screen, pick a language to use on your Desktop PC. As other settings appear, select your country or region, app language, keyboard layout, and time zone then tap **Next**.
3. Carefully read the License Terms, then tap **I Accept**.
4. Follow the onscreen instructions to configure the following basic items:
 - Personalize
 - Connect
 - Settings
 - Your account
5. After configuring the basic items, the Windows®8.1 tutorial appears. Watch this to learn more about Windows®8.1 functionalities.

Windows® 8.1 lock screen

The Windows®8.1 lock screen may appear when your Desktop PC enters the Windows®8.1 operating system. To proceed, tap on the lock screen or press any key on your Desktop PC's keyboard.

Using the Windows® UI

The Windows® User Interface (UI) is the tile-based display used in Windows® 8.1. It includes the following features you can use while working on your Desktop PC.

Start screen

The Start screen appears after successfully signing in to your user account. It helps organize all the programs and applications you need in just one place.

You can press the Windows key  to launch the Start screen from any apps.

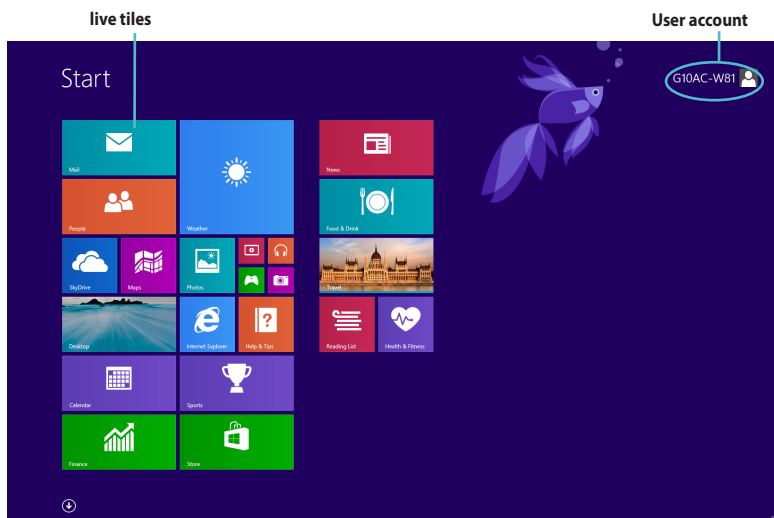

Windows® apps

These are apps pinned on the Start screen and displayed on tiled-format for easy access.



Some apps require signing in to your Microsoft account before they are fully launched.

Hotspots

Onscreen hotspots allow you to launch programs and access the settings of your Desktop PC. The functions in these hotspots can be activated using your mouse.

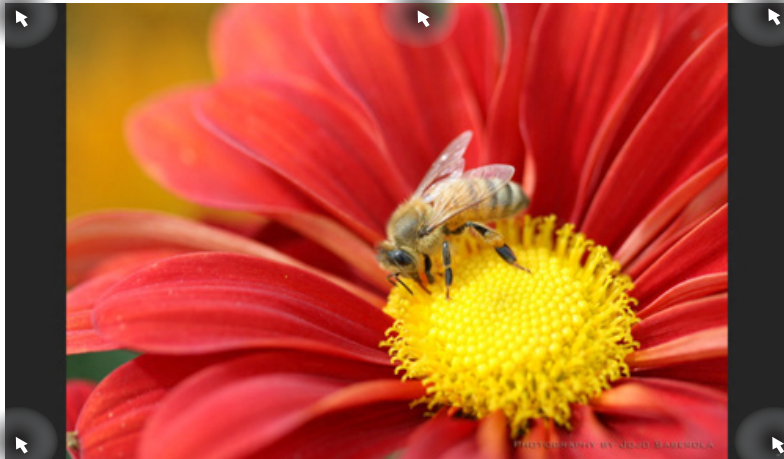

Hotspots on a running app

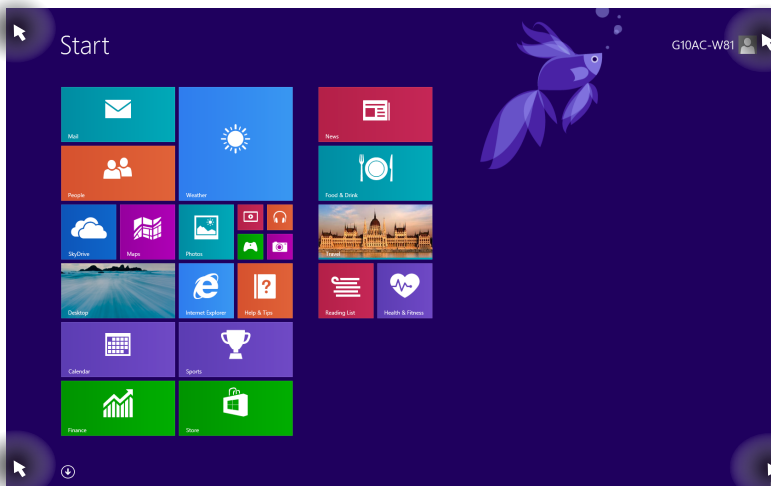

Hotspots on the Start screen



Refer to the next page for the Hotspots' functions.

Hotspot	Action
upper left corner	Hover your mouse pointer then click on the recent app's thumbnail to go back to that app.
lower left corner	Move your mouse pointer down to display all the running apps.
lower left corner	<p>From a running app screen: Hover your mouse pointer on the lower left corner then tap  to go back to the Start screen.</p> <p>NOTE: You can also press the Windows key  on your keyboard to go back to the Start screen.</p> <p>From the Start screen: Hover your mouse pointer on the lower left corner then tap  to go back to that app.</p>
top	Hover your mouse pointer until it changes to a hand icon. Drag then drop the app to a new location. NOTE: This hotspot function only works on a running app or when you want to use the Snap feature. For more details, refer to Snap feature under Working with Windows® apps .
upper and lower right corner	Hover your mouse pointer to launch the Charms bar.

Working with Windows® apps

Use your Desktop PC's keyboard or mouse to launch and customize your apps.

Launching apps

- Position your mouse pointer on an app then left-click once to launch it.
- Press <Tab> twice then use the arrow keys to browse through the apps. Press <Enter> to launch your selected app.

Customizing apps

You can move, resize, or unpin apps from the Start screen using the following steps.

- To move an app, drag and drop the app to a new location.

Resizing apps

Right-click the app to activate its settings bar, then tap  and select an app tile size.

Unpinning apps

To unpin an app from the Start screen, right-click on the app to activate its settings bar then click **Unpin from Start**.

Closing apps

- Move your mouse pointer on the top side of the launched app then wait for the pointer to change to a hand icon.
- Drag then drop the app to the bottom of the screen to close it.
- From the running app's screen, press <Alt> + <F4>.

Accessing the All Apps screen

From the All Apps screen, you can configure an apps settings or pin an app to the Start screen or to the Desktop mode taskbar.

Launching the All Apps screen

- On the Start screen, click .
- From the Start screen, press <Tab>, then press <Enter> on your keyboard.

Pinning an app on the Start screen

1. Launch the All Apps screen.
2. From the All Apps screen, right-click an app to display its settings bar.
3. From the settings bar, click **Pin to Start**.

Charms bar

The Charms bar is a toolbar that can be triggered on the right side of your screen. It consists of several tools that allow you to share applications and provide quick access for customizing the settings of your Desktop PC.

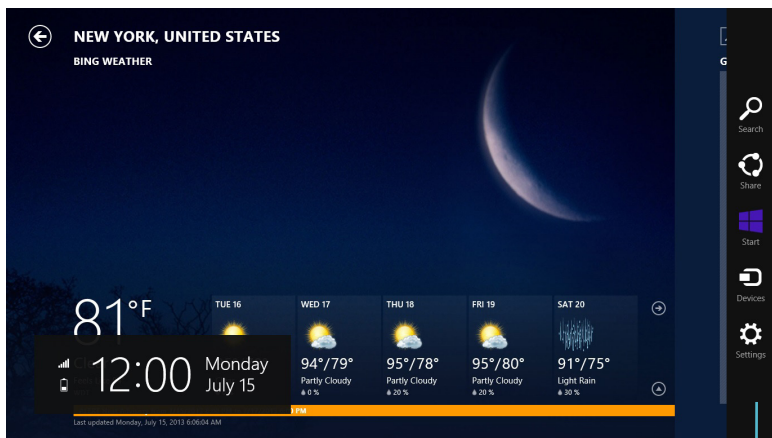

Charms bar

Launching the Charms bar



When called out, the Charms bar initially appears as a set of white icons. The image above shows how the Charms bar looks like once activated.

Use your Desktop PC's mouse or keyboard to launch the Charms bar.

- Move your mouse pointer on the upper or lower right corner of the screen.
- Press  + <C>.

Inside the Charms bar



Search

This charm allows you to look for files, applications, or programs in your Desktop PC.



Share

This charm allows you to share applications via social networking sites or email.



Start

This charm reverts the display back to the Start screen. From the Start screen, you can also use this to revert back to a recently opened app.



Devices

This charm allows you to access and share files with the devices attached to your Desktop PC such as an external display or printer.



Settings

This charm allows you to access the PC settings of your Desktop PC.

Snap feature

The Snap feature displays two apps side-by-side, allowing you to work or switch between apps.



Ensure that your Desktop PC's screen resolution is set to 1366 x 768 pixels or higher before using the Snap feature.

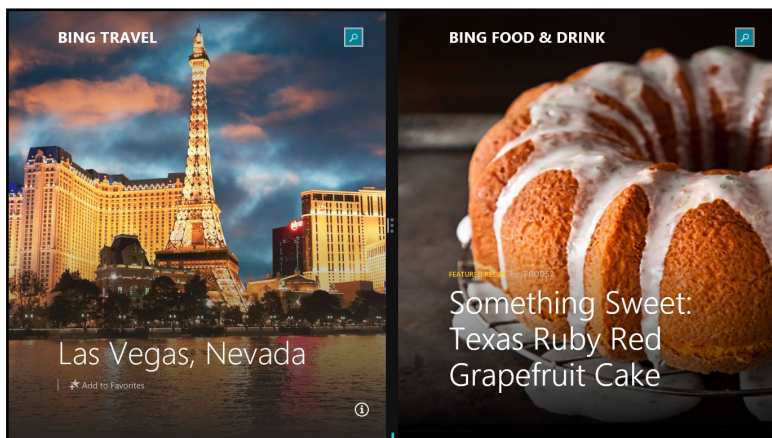

Snap bar

Using Snap

To use Snap:

1. Use your Desktop PC's mouse or keyboard to activate Snap onscreen.

Using your mouse













- a) Click on an app to launch it.
- b) Hover the mouse pointer on the top side of your screen.
- c) Once the pointer changes to a hand icon, drag and drop the app to the right or left side of the display panel.



Using your keyboard

- Launch an app then press  + < . > + left or right key to place the first app on the left or right side of the display panel.

Other keyboard shortcuts

Using your keyboard, you can also use the following shortcuts to help you launch applications and navigate Windows® 8.1.

	Switches between the Start screen and the last running app.
 + <D>	Launches the desktop.
 + <E>	Launches the Computer window on the desktop.
 + <F>	Opens the File search pane.
 + <H>	Opens the Share pane.
 + <I>	Opens the Settings pane.
 + <K>	Opens the Devices pane.
 + <L>	Activates the Lock screen.
 + <M>	Minimizes all currently active screens.
 + <P>	Opens the Second screen pane.
 + <Q>	Opens the Everywhere search pane.
 + <R>	Opens the Run window.
 + <U>	Opens Ease of Access Center.
 + <W>	Opens the Settings search pane.
 + <X>	Opens a menu box of Windows tools

 + <+>	Launches the magnifier and zooms in your screen.
 + <->	Zooms out your screen.
 + <Enter>	Opens the Narrator Settings.

Turning your Desktop PC OFF

To turn your Desktop PC OFF:

Do any of the following to shut down your Desktop PC:

- From the Charms bar, click **Settings** > **Power** > **Shut down** to do a normal shutdown.
- From the login screen, click **Power** > **Shutdown**.
- If your Desktop PC is unresponsive, press and hold the power button for at least four (4) seconds until your Desktop PC turns off.

Putting your Desktop PC to sleep

To put your Desktop PC on Sleep mode, press the Power button once.

Entering the BIOS Setup

BIOS (Basic Input and Output System) stores system hardware settings that are needed for system startup in the Desktop PC.

In normal circumstances, the default BIOS settings apply to most conditions to ensure optimal performance. Do not change the default BIOS settings except in the following circumstances:

- An error message appears on the screen during the system bootup and requests you to run the BIOS Setup.
- You have installed a new system component that requires further BIOS settings or update.



Inappropriate BIOS settings may result in instability or boot failure. We strongly recommend that you change the BIOS settings only with the help of a trained service personnel.

Quickly enter the BIOS

Windows® 8.1 boot time is quite fast, so we developed the following ways for you to quickly access the BIOS:

- Press the power button for at least four seconds to shut down your Desktop PC, then press the power button again to turn your Desktop PC back on, and press during POST.
- When your Desktop PC is off, disconnect the power cord from your Desktop PC's power connector. Reconnect the power cord and press the power button to turn on your Desktop PC. Press during POST.



POST (Power-On Self Test) is a series of software controlled diagnostic tests that run when you turn on your Desktop PC.

Recovering your system

Resetting your PC

The Reset your PC option restores your PC to its factory default settings.



Back up all your data before using this option.

To reset your PC:

1. Press <F9> during bootup.
2. From the screen, click Troubleshoot.
3. Select Reset your PC.
4. Click Next.
5. Select Only the drive where the Windows is installed.
6. Select Just remove my files.
7. Click Reset.

Recovering from a system image file

You can create a USB recovery drive and use this to recover your PC's settings.

Creating a USB recovery drive



The USB storage device must have at least 16 GB available space.



All files on your USB storage device will be permanently deleted during the process. Before you proceed, ensure that you back up all your important data.

To create a USB recovery drive:

1. Launch the Control Panel from the All Apps screen.



For details, refer to Launching the All Apps screen under Working with Windows® apps.

2. From the Control Panel's System and Security, click Find and fix problems.

3. Click Recovery > Create a recovery drive.
4. Click Copy the recovery partition from the PC to the recovery drive and then click Next.

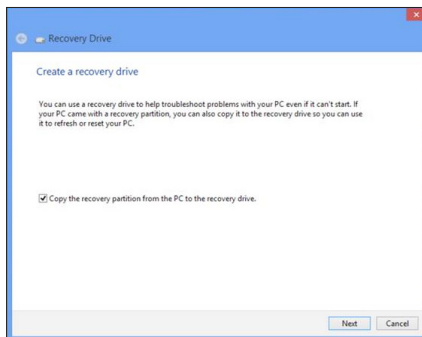

5. Select the USB storage device where you want to copy the recovery files.
6. Click Next.

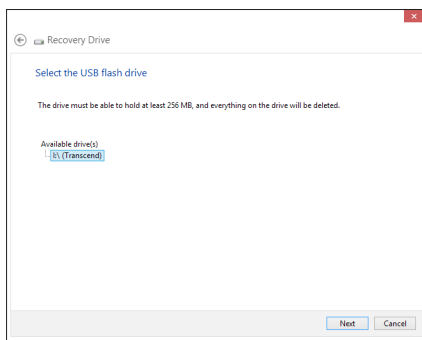

7. Click Create. Wait for a while for the process to complete.
8. When the process is completed, click Finish.

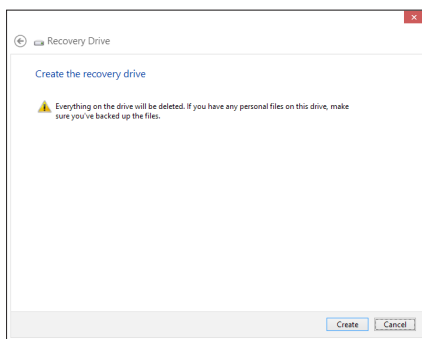

Removing everything and reinstalling Windows

Restoring your PC to its original factory settings can be done using the Remove everything and reinstall options in PC Settings. Refer to the steps below to use this option.



Back up all your data before using this option.



This process may take a while to complete.

1. Launch the Charm bar.
2. Click Settings > PC Settings > Update and recovery > Recovery.
3. Scroll down to view the Remove everything and reinstall Windows option. Under this option, click Get Started.

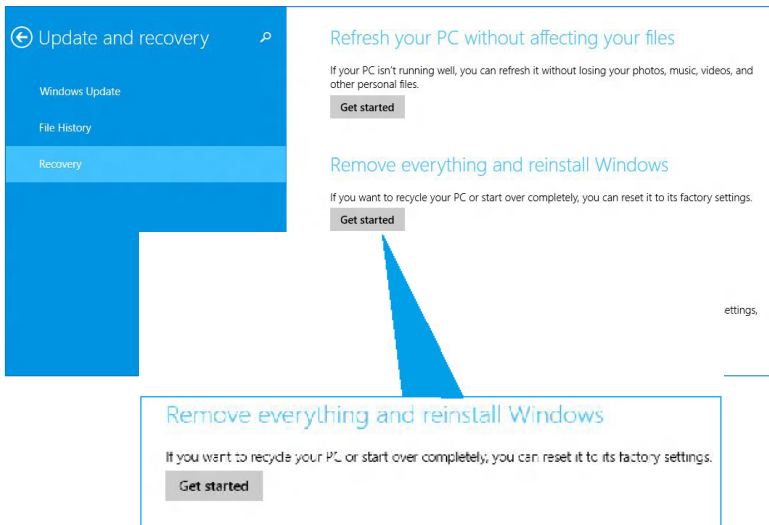

4. Follow the onscreen instructions to complete the reinstallation and reset process.

ASUS contact information

ASUSTeK COMPUTER INC.

Address	15 Li-Te Road, Peitou, Taipei, Taiwan 11259
Telephone	+886-2-2894-3447
Fax	+886-2-2890-7798
E-mail	info@asus.com.tw
Web site	www.asus.com.tw

Technical Support

Telephone	+86-21-38429911
Online support	support.asus.com

ASUS COMPUTER INTERNATIONAL (America)

Address	800 Corporate Way, Fremont, CA 94539, USA
Telephone	+1-510-739-3777
Fax	+1-510-608-4555
Web site	usa.asus.com

Technical Support

Telephone	+1-812-282-2787
Support fax	+1-812-284-0883
Online support	support.asus.com

ASUS COMPUTER GmbH (Germany and Austria)

Address	Harkort Str. 21-23, D-40880 Ratingen, Germany
Fax	+49-2102-959931
Web site	asus.com/de
Online contact	eu-rma.asus.com/sales

Technical Support

Telephone (Component)	+49-2102-5789555
Telephone Germany (System/Notebook/Eee/LCD)	+49-2102-5789557
Telephone Austria (System/Notebook/Eee/LCD)	+43-820-240513
Support Fax	+49-2102-959911
Online support	support.asus.com