



NUC 14 Essential

NUC14MNK

NUC14MNK-B

User Guide

Regulatory Model: NUC14MNK (Mini PC, Kit)

COPYRIGHT INFORMATION

No part of this manual, including the products and software described in it, may be reproduced, transmitted, transcribed, stored in a retrieval system, or translated into any language in any form or by any means, except documentation kept by the purchaser for backup purposes, without the express written permission of ASUSTeK COMPUTER INC. ("ASUS").

ASUS PROVIDES THIS MANUAL "AS IS" WITHOUT WARRANTY OF ANY KIND, EITHER EXPRESS OR IMPLIED, INCLUDING BUT NOT LIMITED TO THE IMPLIED WARRANTIES OR CONDITIONS OF MERCHANTABILITY OR FITNESS FOR A PARTICULAR PURPOSE. IN NO EVENT SHALL ASUS, ITS DIRECTORS, OFFICERS, EMPLOYEES OR AGENTS BE LIABLE FOR ANY INDIRECT, SPECIAL, INCIDENTAL, OR CONSEQUENTIAL DAMAGES (INCLUDING DAMAGES FOR LOSS OF PROFITS, LOSS OF BUSINESS, LOSS OF USE OR DATA, INTERRUPTION OF BUSINESS AND THE LIKE), EVEN IF ASUS HAS BEEN ADVISED OF THE POSSIBILITY OF SUCH DAMAGES ARISING FROM ANY DEFECT OR ERROR IN THIS MANUAL OR PRODUCT.

Products and corporate names appearing in this manual may or may not be registered trademarks or copyrights of their respective companies, and are used only for identification or explanation and to the owners' benefit, without intent to infringe.

SPECIFICATIONS AND INFORMATION CONTAINED IN THIS MANUAL ARE FURNISHED FOR INFORMATIONAL USE ONLY, AND ARE SUBJECT TO CHANGE AT ANY TIME WITHOUT NOTICE, AND SHOULD NOT BE CONSTRUED AS A COMMITMENT BY ASUS. ASUS ASSUMES NO RESPONSIBILITY OR LIABILITY FOR ANY ERRORS OR INACCURACIES THAT MAY APPEAR IN THIS MANUAL, INCLUDING THE PRODUCTS AND SOFTWARE DESCRIBED IN IT.

Copyright © 2024 ASUSTeK COMPUTER INC. All Rights Reserved.

LIMITATION OF LIABILITY

Circumstances may arise where because of a default on ASUS' part or other liability, you are entitled to recover damages from ASUS. In each such instance, regardless of the basis on which you are entitled to claim damages from ASUS, ASUS is liable for no more than damages for bodily injury (including death) and damage to real property and tangible personal property; or any other actual and direct damages resulted from omission or failure of performing legal duties under this Warranty Statement, up to the listed contract price of each product.

ASUS will only be responsible for or indemnify you for loss, damages or claims based in contract, tort or infringement under this Warranty Statement.

This limit also applies to ASUS' suppliers and its reseller. It is the maximum for which ASUS, its suppliers, and your reseller are collectively responsible.

UNDER NO CIRCUMSTANCES IS ASUS LIABLE FOR ANY OF THE FOLLOWING: (1) THIRD-PARTY CLAIMS AGAINST YOU FOR DAMAGES; (2) LOSS OF, OR DAMAGE TO, YOUR RECORDS OR DATA; OR (3) SPECIAL, INCIDENTAL, OR INDIRECT DAMAGES OR FOR ANY ECONOMIC CONSEQUENTIAL DAMAGES (INCLUDING LOST PROFITS OR SAVINGS), EVEN IF ASUS, ITS SUPPLIERS OR YOUR RESELLER IS INFORMED OF THEIR POSSIBILITY.

SERVICE AND SUPPORT

Visit our multi-language website at <https://www.asus.com/support/>.

Contents

About this guide	4
Safety and Caution information	6
Package contents	7
Front view	8
Rear view	8
NUC Mini PC Setup Guide.....	9
Connecting the display	9
Connecting the keyboard and mouse	11
Connecting the LAN cable.....	12
Connecting the power adapter.....	13
Powering on the system	15
NUC Component Integration Guide	17
Safety precautions	17
Care during use	18
Before you begin	19
Opening system	20
DDR5 SO-DIMM Installation	21
M.2 Installation	22
Closing system.....	25
VESA Mount Installation.....	26

About this guide

This user guide includes information on the following NUC SKUs:

- **NUC Mini PC**
(Memory and M.2 solid state drive(s) already included in the NUC system; Windows 11 Home Operating System included):
Specifications and steps to set up your NUC Mini PC.
- **NUC Kit (barebones)**
(Memory and M.2 solid state drive not included; Operating system not included):
Specifications and steps to set up your NUC Kit.

NOTE: Memory and M.2 solid state drive are purchased separately for this SKU.

Audience

This user guide is intended to provide basic setup information about the NUC Mini PC, NUC Kit and components to vendors, system integrators, and other engineers and technicians who need this level of information.

Conventions used in this guide

To highlight key information in this manual, some text are presented as follows:

IMPORTANT! This message contains vital information that must be followed to complete a task.

NOTE: This message contains additional information and tips that can help complete tasks.

WARNING! This message contains important information that must be followed to keep you safe while performing certain tasks and prevent damage to your NUC system's data and components.

Other Common Notation

#	Used after a signal name to identify an active-low signal (such as USBP0#)
GB	Gigabyte (1,073,741,824 bytes)
GB/s	Gigabytes per second
Gb/s	Gigabits per second
KB	Kilobyte (1024 bytes)
Kb	Kilobit (1024 bits)
kb/s	1000 bits per second
MB	Megabyte (1,048,576 bytes)
MB/s	Megabytes per second
Mb	Megabit (1,048,576 bits)
Mb/s	Megabits per second
TDP	Thermal Design Power
xxh	An address or data value ending with a lowercase h indicates a hexadecimal value.
x.x V	Volts. Voltages are DC unless otherwise specified.
x.x A	Amperes.

Production Identification Information

ASUSTeK NUC Product NUC 14 Essential Identification Information

Product Name	NUC 14 Essential
NUC14MNK-B	Kit
NUC14MNK	Mini PC

Where to find more information

Refer to the following sources for additional information and for product and software updates.

1. ASUS website

The ASUS website (www.asus.com) provides updated information on ASUS hardware and software products.

Safety and Caution information

- Accessories that came with this product have been designed and verified for the use in connection with this product. Never use accessories from other products to prevent the risk of electric shock or fire.
- This device may interfere with the operation of some pacemakers, hearing aids or other medical devices. To reduce the risk, maintain a separation distance of 20cm (8 inches) between the device and the medical device. Refer to the medical device for additional information.
- Modification of the wireless solution, thermal solution, device components or enclosure shall violate regulatory compliance requirements and may induce safety hazards.



Risk of explosion if the battery is replaced with an incorrect type. Batteries should be recycled where possible. Disposal of used batteries must be in accordance with local environmental regulations.

Korea MEPS Notice

컴퓨터 유형 - 데스크탑 컴퓨터 (유형 D)

연간소비전력량: 96.0 kWh/year

슬립모드 소비전력: ≤ 5.0 W

오프모드 소비전력: ≤ 1.0 W

Package contents

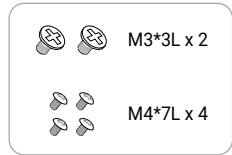
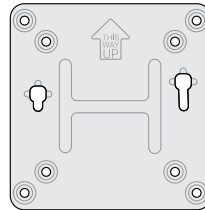
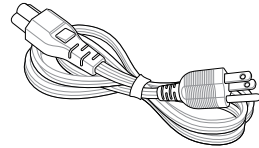
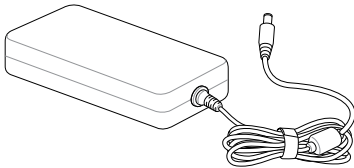
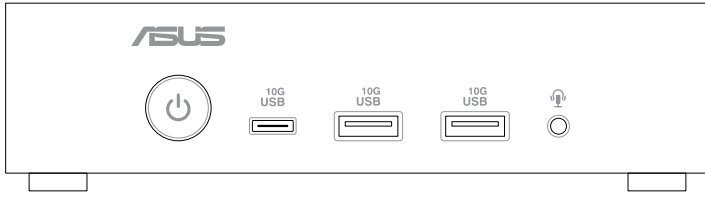

NOTE:





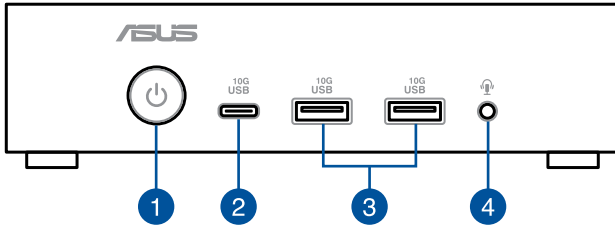

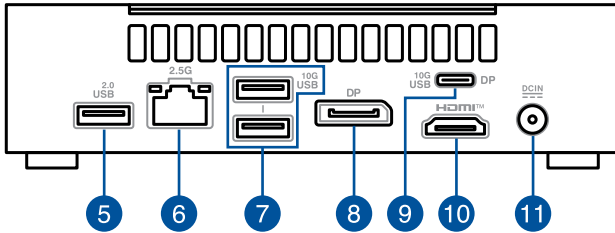

- The most up-to-date and accurate product specifications are available on www.asus.com for download.
- Product and accessory images are for illustrative purposes only. The actual appearance and specifications may vary depending on the model.
- *The bundled power adapter may vary depending on the model and the country (or region) of sale.
- Some bundled accessories may vary depending on the model. For details on these accessories, refer to their respective user manuals.
- If the device or its components fail or malfunction during normal and proper use within the warranty period, bring the warranty card to the ASUS Service Center for replacement of the defective components.

Front view



Rear view



- | | | | |
|---|---|----|--|
| 1 |  Power button | 7 |  USB 10Gbps port |
| 2 |  USB 10Gbps Type-C® port | 8 | DP DisplayPort |
| 3 |  USB 10Gbps port | 9 |  USB 10Gbps Type-C® port with DisplayPort |
| 4 |  Headphone/Headset/
Microphone jack | 10 |  HDMI™ HDMI™ port |
| 5 |  USB 2.0 port | 11 |  Power input |
| 6 | 2.5G LAN Port | | |

NOTE: Type-C® port power profiles:

- 5V @ 3A (primary)
- 5V @ 1.5A (secondary)

NUC Mini PC Setup Guide

Connecting the display

HDMI™ port

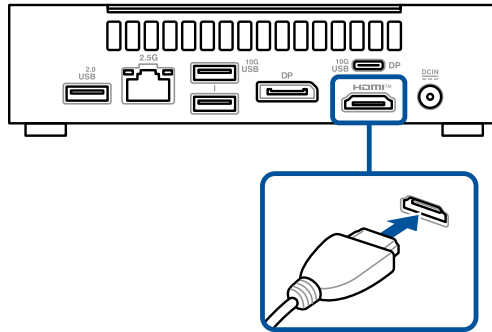

DisplayPort

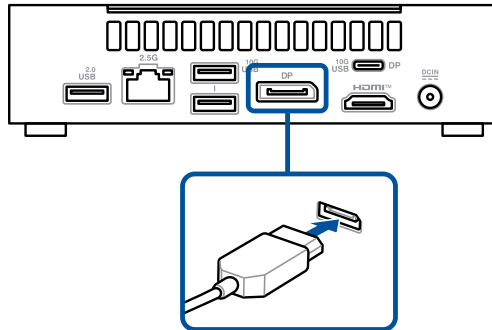

Type-C® DisplayPort

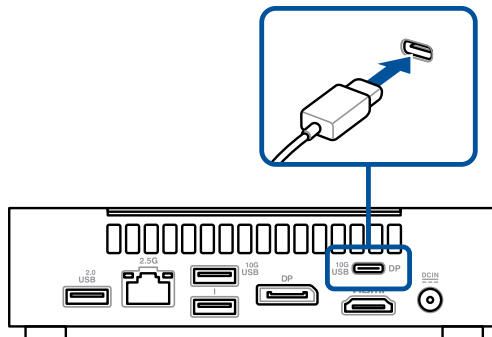

Display resolution table:

Port	HDMI	DisplayPort	DisplayPort over USB-C®
Video Output	HDMI 2.1 TMDS Compatible	DisplayPort 1.4 (HBR2)	DisplayPort 1.4 (HBR3)
Resolution/Refresh 1080P	1080P (1920 x 1080) @ 120Hz	1080P (1920 x 1080) @ 120Hz	1080P (1920 x 1080) @ 120Hz
Resolution/Refresh 4K	4K (3840 x 2160) @ 60Hz	4K (3840 x 2160) @ 60Hz	4K (3840 x 2160) @ 60Hz

Connecting the keyboard and mouse

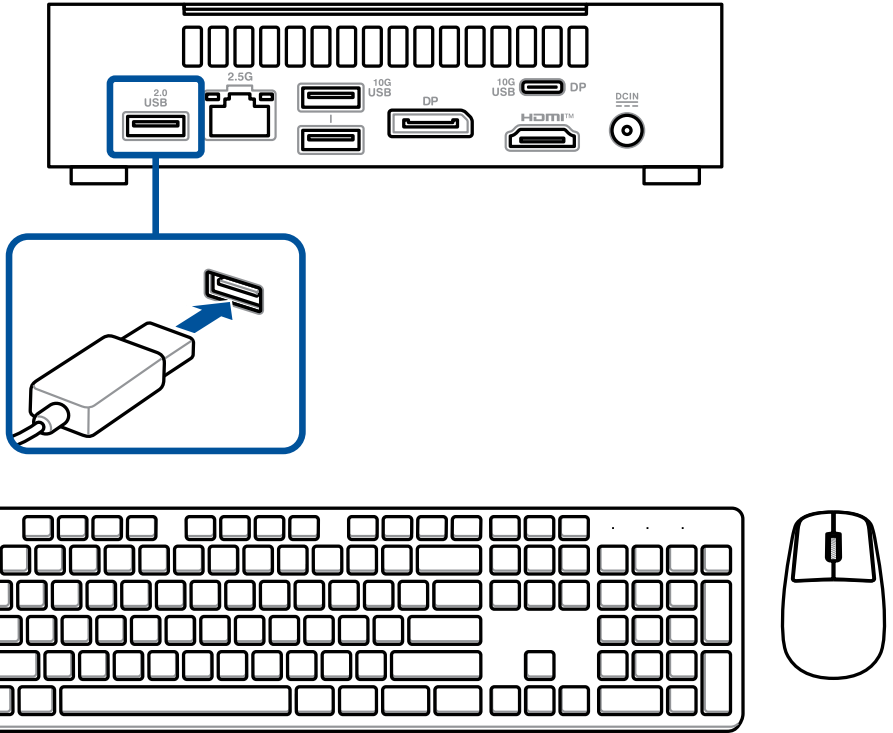

Connecting the LAN cable

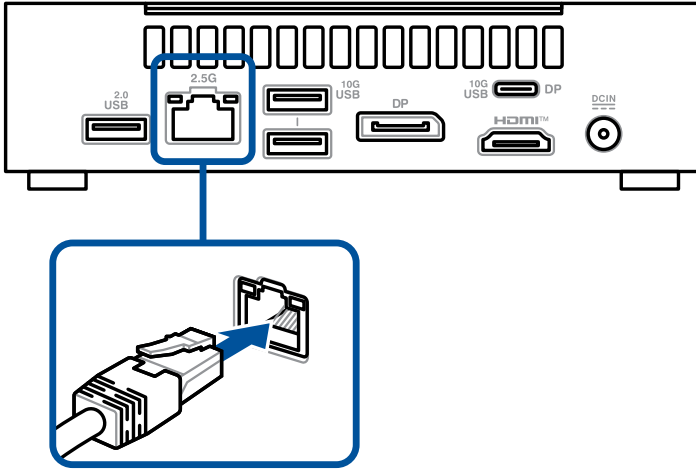

LAN port LED indications:



Link LED	
Status	Description
OFF	No link
GREEN	Linked
BLINKING	Data activity

Speed LED	
Status	Description
OFF	100 Mbps / 10 Mbps connection
YELLOW	1 Gbps connection
GREEN	2.5 Gbps connection

Connecting the power adapter

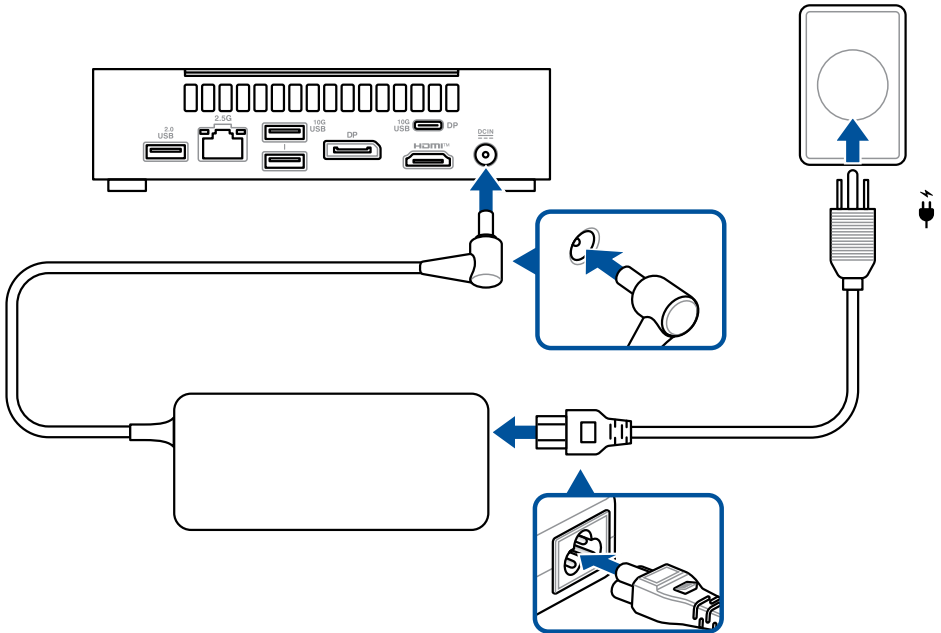



NOTE: Please refer to the following for more information on the adapter and the system:

65W Power adapter

- Input voltage: 100-240 Vac
- Input frequency: 50-60 Hz
- Output current: 3.42A (65.0 W)
- Output voltage: 19 Vdc
- Rated for use between 0°C and 35°C (32°F and 95°F)

System

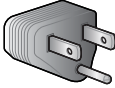
- Rated input current: 3.42A (65.0 W)
- Rated input voltage: 19 Vdc
- Operating temperature: 0°C to 35°C (32°F and 95°F)

Plug			
Code	US	CN	EU
Country	United States	China	European Union

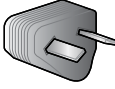
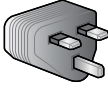
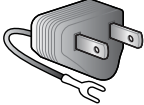
Plug			
Code	AU	UK	JP
Country	Australia	United Kingdom	Japan (Type-A)

Plug	
Code	IN
Country	India

Powering on the system

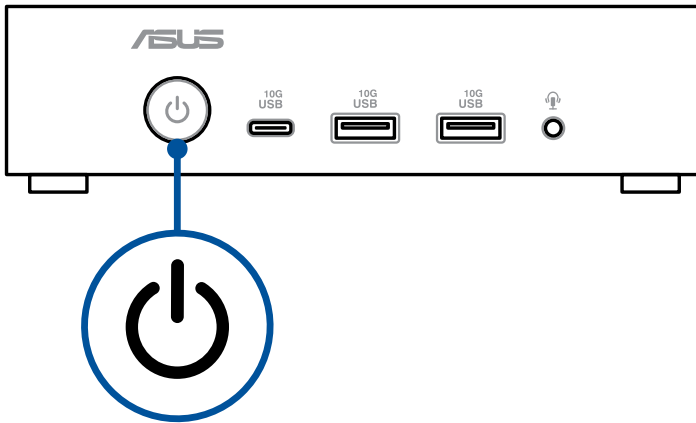

NOTE: To view the current power management settings in Windows® 11, click the **Start Button**. Type *Power Management*, then press **<Enter>**.

Default settings on a new system, as received, has the recommended settings (below) applied.

NOTE: This section only applies to the NUC Mini PC, and is not applicable to the NUC Kit or NUC Board.

BIOS settings

NOTE: Enter BIOS Setup by pressing **F2** during startup. If you're using this system at home, it is unlikely you will need to alter these settings.

- CPU Fan Detection and Speed - Set to automatic.
- After Power Failure - System stays off; press the power button to restart.
- S3 State Indicator - Power light on the front of the system will blink on and off. (This is sleep mode)
- Wake-on-LAN S4/S5 - System will power up to a normal boot. (This is for IT departments)

Operating System Settings (Windows® 11)

- Turn Off the Display - 5 Minutes. (Your monitor will go blank)
- Put the Computer to Sleep - Within 5 minutes of user inactivity.

To Wake Your Computer

- To wake your system up from display sleep or HDD power off
- Put the Computer to Sleep - Within 5 minutes of user inactivity.

NUC Component Integration Guide

IMPORTANT! ASUS is not responsible for direct, indirect, intentional or unintentional damages resulting from improper installation and operation.

Safety precautions

- This device is intended for use in ambient temperatures between 0°C and 35°C (32°F and 95°F). Avoid using or storing next to heat sources, in direct sunlight, or outside the intended temperature ranges.
- Do not use this product near water or a heated source.
- Openings on the chassis are for ventilation. Do not block or cover these openings. Make sure you leave plenty of space around the system for ventilation. Never insert objects of any kind into the ventilation openings.
- Use this product in environments with ambient temperatures between 0°C and 35°C.
- Failure to use the included power adapter shall violate regulatory compliance requirements and may expose the user to safety hazards.
- Risk of electric shock, fire, or burn if using an AC adapter other than the one provided with this device. Indoor use only and in dry locations. The adapter is rated for use between 0°C and 35°C (32°F and 95°F).
- If you use an extension cord, make sure that the total ampere rating of the devices plugged into the extension cord does not exceed its ampere rating.
- The power supply cord must be plugged into a socket or outlet that is provided with a suitable earth ground.
- This equipment should be installed and operated with a minimum distance of 20cm between the radiator and your body.
- Do not install this equipment at a height exceeding 2 meters

Care during use

- Do not walk on the power cord or allow anything to rest on it.
- Do not spill water or any other liquids on your system.
- When the system is turned off, a small amount of electrical current still flows. Always unplug the power cord from the power outlets before cleaning the system.
- If you encounter the following technical problems with the product, unplug the power cord and contact a qualified service technician or your retailer.
 - The power cord or plug is damaged.
 - Liquid has spilled into the system.
 - The system does not function properly even if you follow the operating instructions.
 - The system was dropped, or the cabinet is damaged.
 - The system performance changes.
- Avoid contact with hot components inside the Mini PC. During operation, some components become hot enough to burn the skin. Before you open the computer cover, turn off the computer, disconnect the power, and wait approximately 30 minutes for the components to cool.
- Disposal of a battery into fire or a hot oven, or mechanically crushing or cutting of a battery, that can result in an explosion.
- Leaving a battery in an extremely high temperature surrounding environment that can result in an explosion or the leakage of flammable liquid or gas.
- A battery subjected to extremely low air pressure that may result in an explosion or the leakage of flammable liquid or gas.

Before you begin

1. Read the entire manual before starting any service procedures and follow all instructions.
 2. Back up your NUC system.
 3. Turn off your NUC system.
 4. Place your NUC system on a stable surface.
 5. Disconnect all connected peripherals and cables.
-

IMPORTANT!

- Purchase replacement components from an authorized retailer of this NUC system to ensure maximum compatibility and reliability.
 - Refer to <https://www.asus.com> for a list of compatible components.
-

NOTE:

- The illustrations are for reference only.
 - Product and component images are for illustrative purposes only. The actual appearance and specifications may vary depending on the model.
 - Keep all adhesive tape, insulating materials, screws, and other removable items in a safe place until the service procedure is completed, as they may be needed during installation.
-

Opening system

1. Loosen the four (4) screws on the bottom of the system.

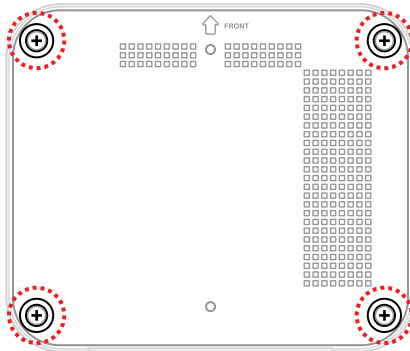

2. Remove the bottom cover.

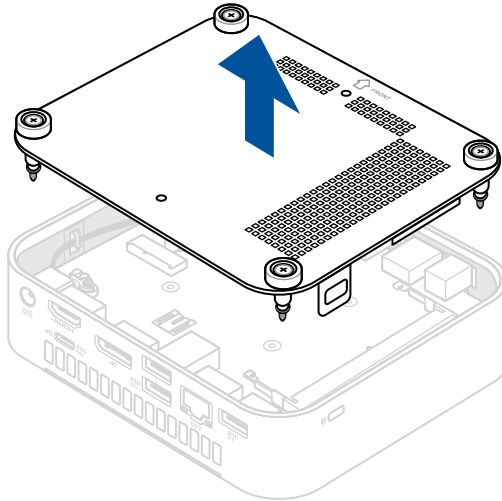

DDR5 SO-DIMM Installation

To install memory, be sure to select memory modules that meet these requirements:

- 1.1V low voltage memory
- DDR5 4800 MHz SO-DIMMs
- Non-ECC
- Up to 16 GB of system memory with one SO-DIMM using 16 GB memory modules

Find compatible and validated memory modules in the ASUS Qualified Vendor List at www.asus.com/support.

NOTE: 2 Gb, 4 Gb, and 8 Gb memory technology (SDRAM Density) is not supported.

1. Align the small space at the bottom edge of the DDR5 SO-DIMM with the key on the SO-DIMM slot, then insert the DDR5 SO-DIMM into the SO-DIMM slot.
2. Push the DDR5 SO-DIMM down until the retaining clips clicks into place.

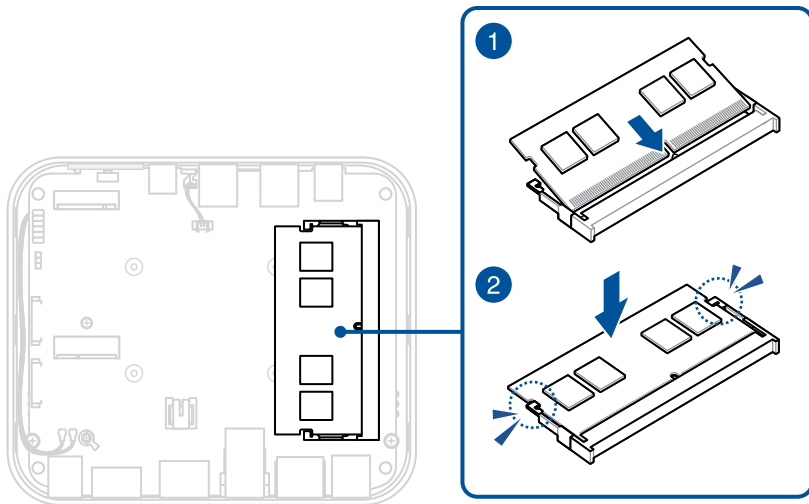

M.2 Installation

This system supports the following:

- One M.2 PCIe Gen3x4 connector supporting M.2 22x80 or 22x42 (key type M) for NVMe or SATA SSD

Find compatible and validated M.2 modules in the ASUS Qualified Vendor List at www.asus.com/support.

2280 M.2

1. Insert the M.2 module into the M.2 slot on the system board.
2. Rotate the Q-Latch counterclockwise to secure the M.2 module in place.

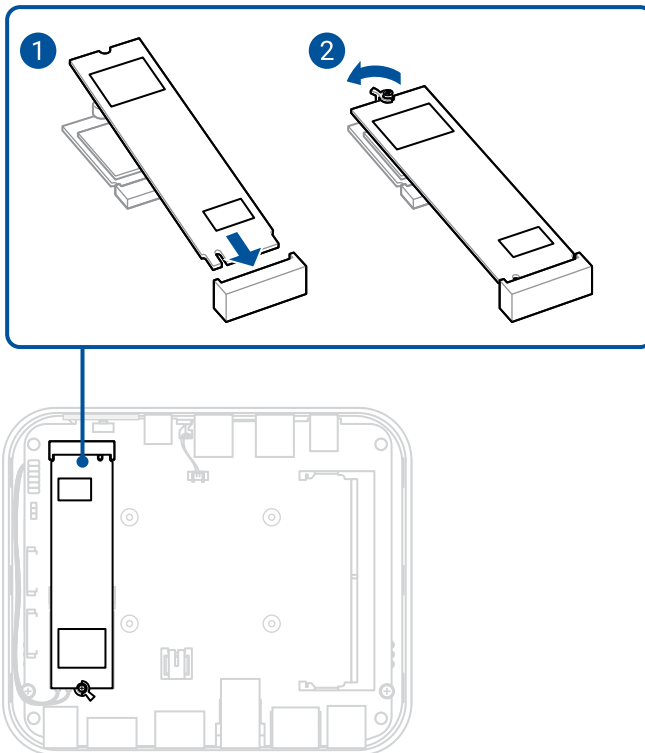

2242 M.2

1. Remove the screw from the 2242 length position screw stand.
2. Remove the latch screw from the 2280 length position screw stand.
3. Install the screw removed in step 1 to the 2280 length position screw stand.
4. Install the latch screw removed in step 2 to the 2242 length position screw stand.

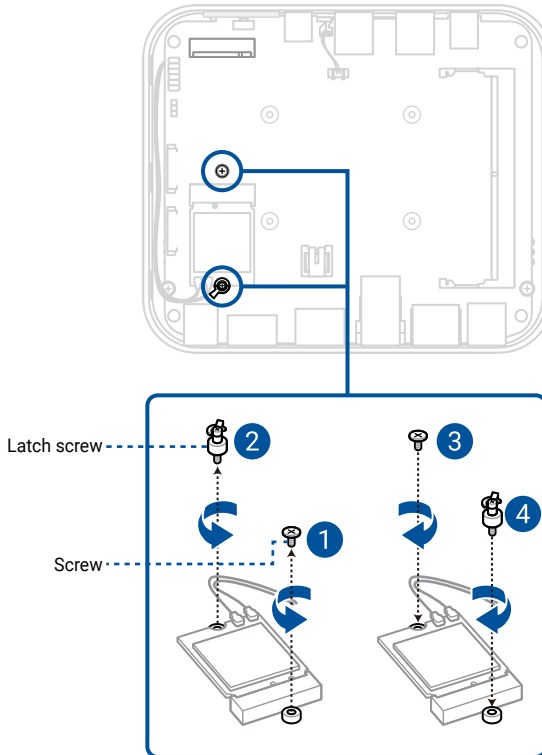

5. Insert the M.2 module into the M.2 slot on the system board.
6. Rotate the Q-Latch counterclockwise to secure the M.2 module in place.

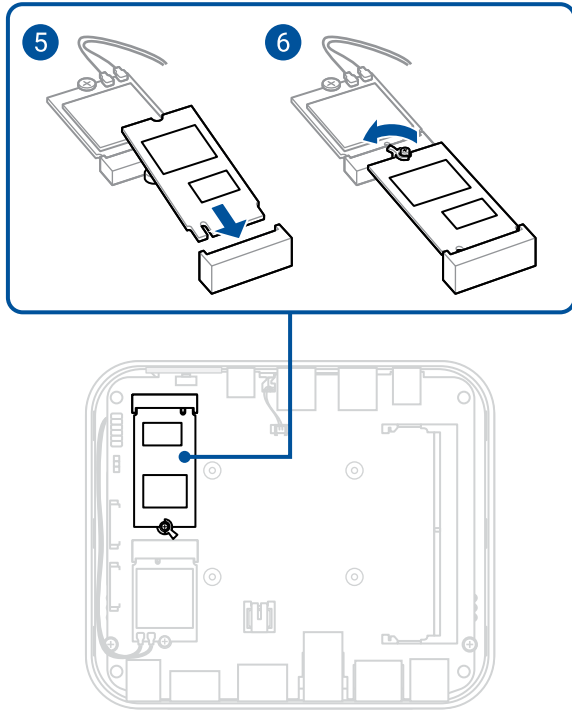

Closing system

1. Place and align the bottom cover to the chassis.

NOTE: Ensure the FRONT indication on the bottom cover is aligned to the front of the system.

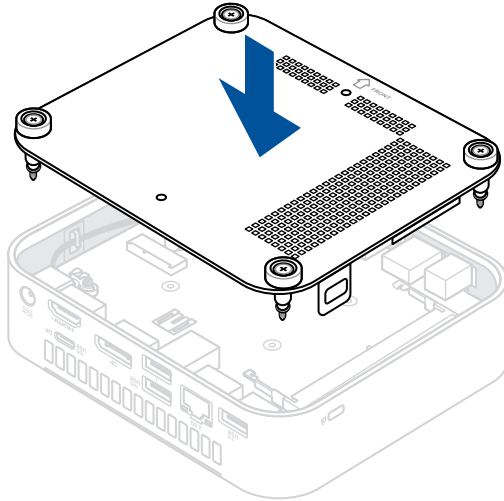

2. Secure the bottom cover by tightening the four (4) screws.

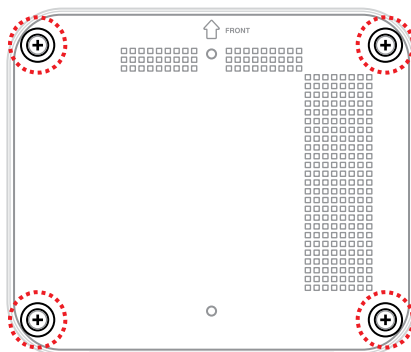

VESA Mount Installation

1. Attach the VESA bracket to the back of the monitor or TV using the four (4) bundled screws with the THIS WAY UP arrow indicator pointing upwards.

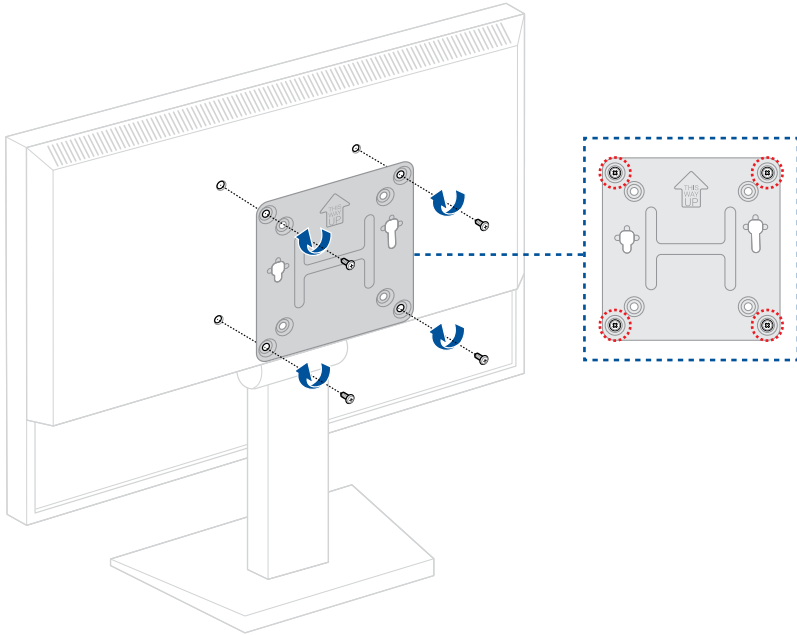

2. Attach the two (2) bundled slightly larger black screws to the bottom chassis cover of the NUC system.

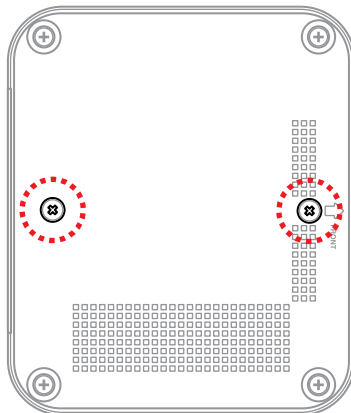

- Align the screws on the NUC system to the notches on the VESA mount.

NOTE: Your NUC system will be tilted slightly when properly aligned.

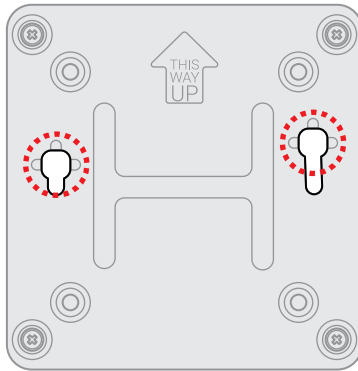

- Slide the NUC system downwards so that the screws are attached and secured to the VESA mount.

