

LED projector

User Manual

ZenBeam Latte

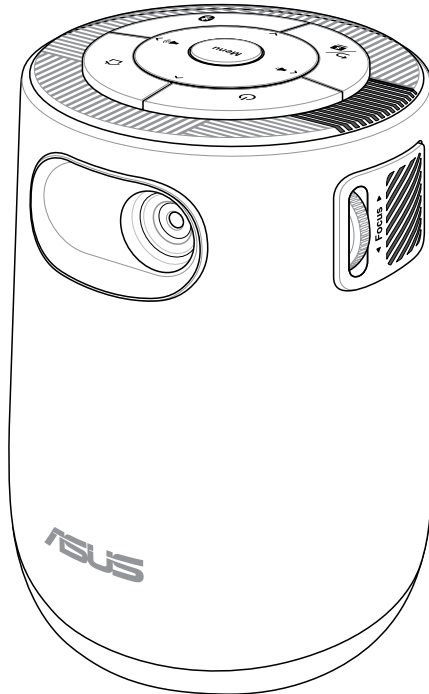

COPYRIGHT AND WARRANTY INFORMATION

No part of this manual, including the products and software described in it, may be reproduced, transmitted, transcribed, stored in a retrieval system, or translated into any language in any form or by any means, except documentation kept by the purchaser for backup purposes, without the express written permission of ASUSTeK COMPUTER INC. ("ASUS").

Product warranty or service will not be extended if: (1) the product is repaired, modified or altered, unless such repair, modification or alteration is authorized in writing by ASUS; or (2) the serial number of the is defaced or missing.

ASUS PROVIDES THIS MANUAL "AS IS" WITHOUT WARRANTY OF ANY KIND, EITHER EXPRESS OR IMPLIED, INCLUDING BUT NOT LIMITED TO THE IMPLIED WARRANTIES OR CONDITIONS OF MERCHANTABILITY OR FITNESS FOR A PARTICULAR PURPOSE. IN NO EVENT SHALL ASUS, ITS DIRECTORS, OFFICERS, EMPLOYEES OR AGENTS BE LIABLE FOR ANY INDIRECT, SPECIAL, INCIDENTAL, OR CONSEQUENTIAL DAMAGES (INCLUDING DAMAGES FOR LOSS OF PROFITS, LOSS OF BUSINESS, LOSS OF USE OR DATA, INTERRUPTION OF BUSINESS AND THE LIKE), EVEN IF ASUS HAS BEEN ADVISED OF THE POSSIBILITY OF SUCH DAMAGES ARISING FROM ANY DEFECT OR ERROR IN THIS MANUAL OR PRODUCT.

Products and corporate names appearing in this manual may or may not be registered trademarks or copyrights of their respective companies, and are used only for identification or explanation and to the owners' benefit, without intent to infringe.

SPECIFICATIONS AND INFORMATION CONTAINED IN THIS MANUAL ARE FURNISHED FOR INFORMATIONAL USE ONLY, AND ARE SUBJECT TO CHANGE AT ANY TIME WITHOUT NOTICE, AND SHOULD NOT BE CONSTRUED AS A COMMITMENT BY ASUS. ASUS ASSUMES NO RESPONSIBILITY OR LIABILITY FOR ANY ERRORS OR INACCURACIES THAT MAY APPEAR IN THIS MANUAL, INCLUDING THE PRODUCTS AND SOFTWARE DESCRIBED IN IT.

Copyright © 2024 ASUSTeK COMPUTER INC. All Rights Reserved.

LIMITATION OF LIABILITY

Circumstances may arise where because of a default on ASUS' part or other liability, you are entitled to recover damages from ASUS. In each such instance, regardless of the basis on which you are entitled to claim damages from ASUS, ASUS is liable for no more than damages for bodily injury (including death) and damage to real property and tangible personal property; or any other actual and direct damages resulted from omission or failure of performing legal duties under this Warranty Statement, up to the listed contract price of each product.

ASUS will only be responsible for or indemnify you for loss, damages or claims based in contract, tort or infringement under this Warranty Statement.

This limit also applies to ASUS' suppliers and its reseller. It is the maximum for which ASUS, its suppliers, and your reseller are collectively responsible.

UNDER NO CIRCUMSTANCES IS ASUS LIABLE FOR ANY OF THE FOLLOWING: (1) THIRD-PARTY CLAIMS AGAINST YOU FOR DAMAGES; (2) LOSS OF, OR DAMAGE TO, YOUR RECORDS OR DATA; OR (3) SPECIAL, INCIDENTAL, OR INDIRECT DAMAGES OR FOR ANY ECONOMIC CONSEQUENTIAL DAMAGES (INCLUDING LOST PROFITS OR SAVINGS), EVEN IF ASUS, ITS SUPPLIERS OR YOUR RESELLER IS INFORMED OF THEIR POSSIBILITY.

SERVICE AND SUPPORT

Visit our multi-language web site at <https://www.asus.com/support>.

Table of Contents

About this manual	5
Conventions used in this manual	6
Typography	6
Multi-language versions	6
Safety precautions	7
Using your LED projector	7
Servicing and replacement of parts	7
Caring for your LED projector	8
Battery precautions	8
Proper disposal	9

Chapter 1: Knowing your LED projector

Features	12
Top view	12
Front view	14
Right view	15
Left view	16
Rear view	17
Bottom view	20
LED projector remote control	21
Replacing the battery	23

Chapter 2: Setting up

Operating your LED projector	26
Connect the LED projector to the power adapter	26
Connect the LED projector to your device	29
Adjust the height of the LED projector	31
Press the power button	33
Adjust the image focus	34

Chapter 3: Using the onscreen display menu

Using your LED projector for the first time	36
Home page summary	37
Using the Mirror function.....	39
Using the ZenBeam Latte as a Bluetooth speaker	41
Sending YouTube links to the LED projector.....	42
Using the Aptoide TV.....	43
Navigating in Aptoide TV.....	43
Downloading and installing an app.....	44
Putting your LED projector in Standby mode.....	46
Powering off your LED projector	47

Appendices

Specifications for ZenBeam Latte LED projector.....	56
Support PC Timings	59

About this manual

This manual provides information about the hardware and software features of your LED projector through the following chapters:

Chapter 1: Knowing your LED Projector

This chapter details the parts of your LED projector and its accompanying remote control.

Chapter 2: Setting up

This chapter shows you how to set up your LED projector and use its parts for input device connection.

Chapter 3: Using the onscreen display menu

This chapter talks about the features of your LED projector's onscreen display menu and how to navigate it using the control panel.

Appendices

This section includes safety notices for your LED projector.

Conventions used in this manual

To highlight key information in this manual, some text are presented as follows:

IMPORTANT! This message contains vital information that must be followed to complete a task.

NOTE: This message contains additional information and tips that can help complete tasks.

WARNING! This message contains important information that must be followed to keep you safe while performing tasks and prevent damage to your LED projector's data and components.

Typography

Bold = This indicates a menu or an item that must be selected.

Italic = This indicates sections that you can refer to in this manual.

Multi-language versions

Download other language versions of this User Manual via this website:
<https://www.asus.com/support>

Safety precautions

Using your LED projector

- Refer to the manual and take note of the safety instructions before operating your LED projector.
- Follow the notes and warnings stated in the user manual.
- Do not place your LED projector on uneven or unstable surfaces.
- Do not use your LED projector in smoky environments. Smoke residue may cause build-up on critical parts and damage the LED projector or decrease its performance.
- Keep the LED projector's plastic packages out of the reach of children.
- Do not block or place anything near the LED projector's ventilation holes. Doing so may cause internal heat build-up that can degrade picture quality and damage the projector.
- Ensure that the operating voltage of your LED projector matches the voltage of your power source.

Servicing and replacement of parts

- Do not disassemble or attempt to service this LED projector by yourself. Contact your local ASUS service center for assistance.
- When replacing parts of your LED projector, purchase items as specified by ASUS and contact your local service center for assistance.

Caring for your LED projector

- Switch off then unplug the LED projector from the power outlet before cleaning it.
- When cleaning the LED projector's housing, use a clean soft cloth dampened with water or a mix of water and neutral detergent. Wipe it dry using a soft dry cloth.
- Ensure that the lens is cool before cleaning it. Gently wipe the lens using a lens cleaning paper. Do not touch the lens with your hands.
- Do not use liquid or aerosol cleaners, benzene, or thinners on your LED projector.
- Never operate this LED projector immediately after moving it from a cold location. When the LED projector is exposed to a drastic change in temperature, moisture may condense on the lens and its other internal parts. To prevent this, use the unit two (2) hours after an extreme or sudden change in temperature occurs.

Battery precautions

- When replacing the battery, do not replace it with an incorrect type that can defeat the safeguard.
- Do not dispose the battery into fire or a hot oven, or mechanically crushing or cutting the battery, as doing so may lead to an explosion.
- Leaving the battery in an environment with extremely high temperature may lead to an explosion, or the leakage of flammable liquid or gas.
- A battery subjected to extremely low air pressure may lead to an explosion, or the leakage of flammable liquid or gas.
- When the main power input is disconnected from the device, the disconnected device should still remain readily operable.

Proper disposal



Do not throw your LED projector in municipal waste. This product has been designed to enable proper reuse of parts and recycling. The symbol of the crossed out wheeled bin indicates that the product (electrical, electronic equipment and mercury-containing button cell battery) should not be placed in municipal waste. Check local regulations for disposal of electronic products.



Do not throw the battery in municipal waste. The symbol of the crossed out wheeled bin indicates that the battery should not be placed in municipal waste.

Chapter 1:
***Knowing your LED
projector***

Features

Top view

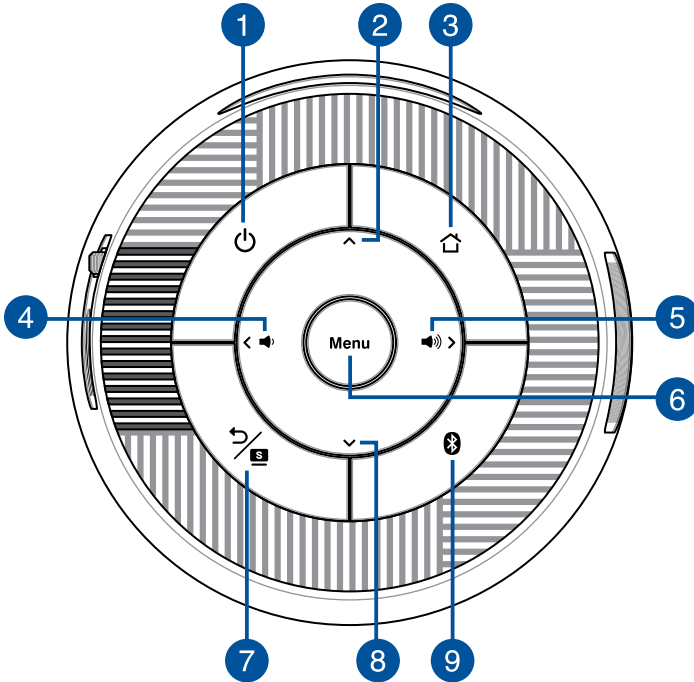

1 Power button

Press this power button to turn on or turn off your LED projector. This LED indicator on this button indicates the following scenarios for your LED projector:

LED Color	Status
White	The LED projector is powered on and the battery power is more than 25%.
White (blinking)	The LED projector is in standby mode and the battery power is more than 25%, or when the LED projector is in Bluetooth speaker mode.
Orange Red	The LED projector is running on battery mode only and the battery power is less than 25%.
Orange Red (blinking)	The LED projector is in standby mode whilst on battery mode only, and the battery power is less than 25%.

2 Menu Up button

This button is used to navigate the different menus.

3 Home button

Press this Home button to return to the home page or to switch back to projector mode when the LED projector is in Bluetooth speaker mode.

4 Menu Left / Volume Down button

This button is used to navigate the different menus, and can also be used to turn the volume down when audio is playing.

5 Menu Right / Volume Up button

This button is used to navigate the different menus, and can also be used to turn the volume up when audio is playing.

6 Menu / OK button

Press this button to open the main menu or as the OK button.

7 Back / Splendid button

This button is used to return to the previous menu or page, or is used to toggle Splendid mode.

8 Menu Down button

This button is used to navigate the different menus.

9 Bluetooth button

This button is used to toggle between Bluetooth speaker mode and projector mode. The LED indicator on this button indicates the following scenarios for your LED projector:

LED Color	Status
Blue	Bluetooth successfully paired (Bluetooth speaker mode)
Blue (blinking)	Ready to pair / Bluetooth is pairing / Bluetooth disconnected (Bluetooth speaker mode)
Off	Projector mode

Front view



1 Lens

The lens projects video or image files onscreen from your input device.

WARNING! Do not touch the lens using your hands or any sharp object.

Right view

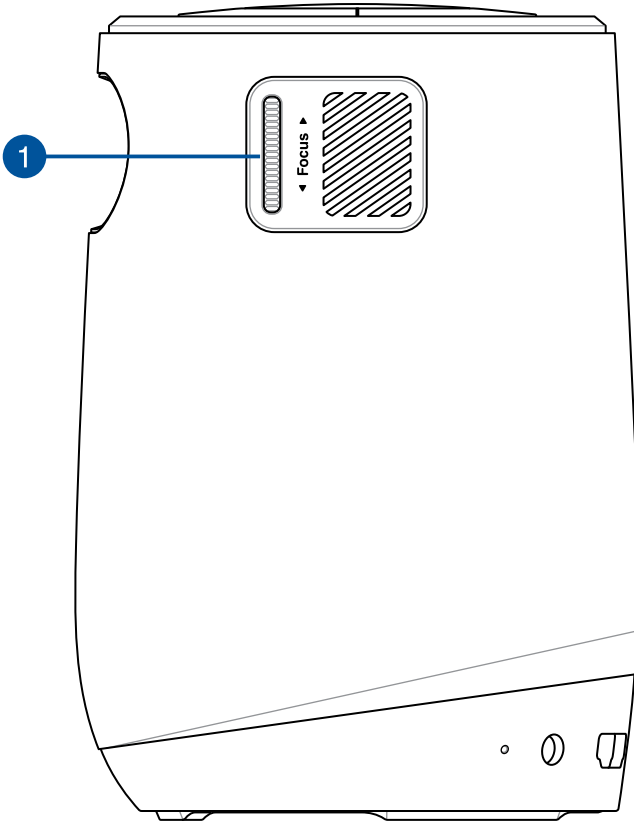

1 Focus dial

The focus dial allows you to adjust the focus of the projector lens.

Left view

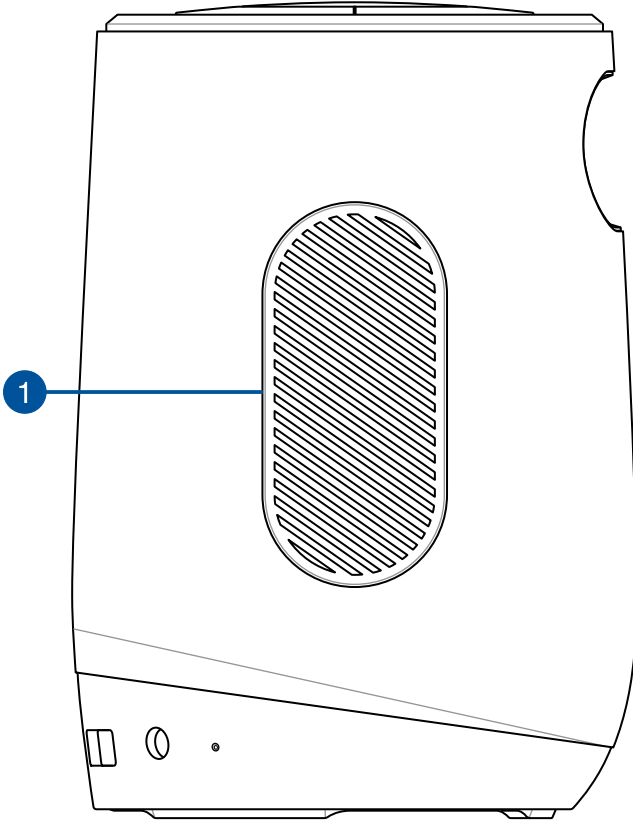

1 Air vents (exhaust vent)

The air vents allow your LED projector to expel hot air out.

IMPORTANT! For optimum heat dissipation and air ventilation, ensure that the air vents are free from obstructions.

CAUTION! Be careful of the hot air expelled at the air vents as it may cause discomfort or injuries.

Rear view

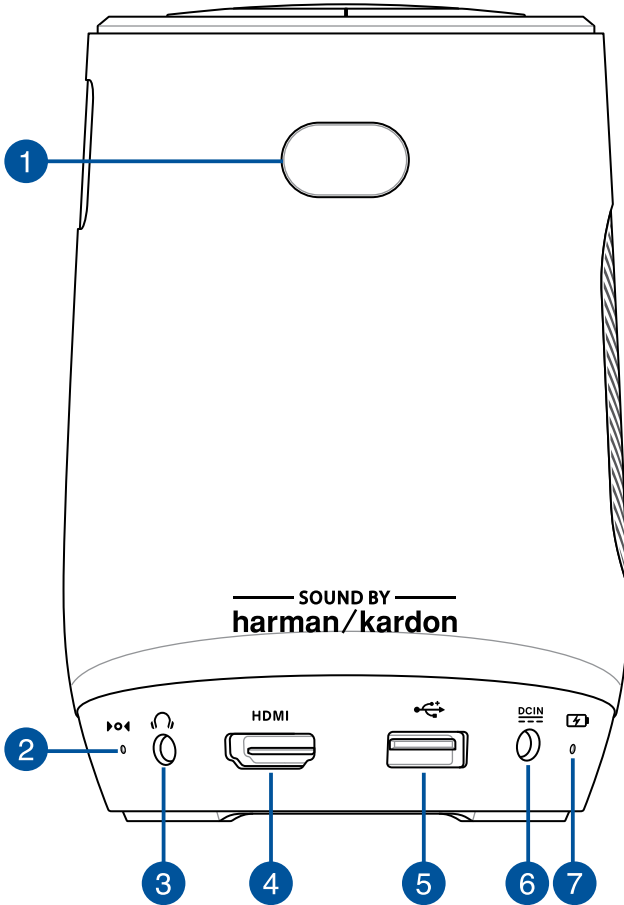

1 Remote sensor

The remote sensor detects signal from your LED projector's remote control, allowing you to access the LED projector's control panel from a distance of up to 8 meters and a receiving angle of ± 30 degrees when the remote is directly behind the remote sensor.

2 Manual reset hole

If your LED projector is unresponsive, insert a straightened paper clip into this hole to turn off your LED projector, then press the power button to turn on your LED projector again.

3 Audio output jack port

The audio output jack port allows you to connect your LED projector to amplified speakers or headphones.

4 HDMI™ port

This port is for the HDMI™ (High-Definition Multimedia Interface) connectors. This port is HDCP compliant for HD DVD, Blu-ray, and other protected content playback.

5 USB 2.0 port

The USB (Universal Serial Bus) port is compatible with USB 2.0 or USB 1.1 devices such as a mouse or keyboard.

6 Power (DC) input port

Insert the bundled power adapter into this port to charge the battery pack and supply power to your LED projector.

IMPORTANT! Use only the bundled power adapter to charge the battery pack and supply power to your LED projector.

WARNING! The adapter may become warm to hot while in use. DO NOT cover the adapter and keep it away from your body while it is connected to a power source.

7 Battery charge indicator

This LED indicator lights up when the LED projector is plugged to a power source using its power adapter.

IMPORTANT! Use only the bundled power adapter to charge the battery pack and supply power to your LED projector.

LED Color	Status
Orange	Battery charging
Green	Battery fully charged

Bottom view

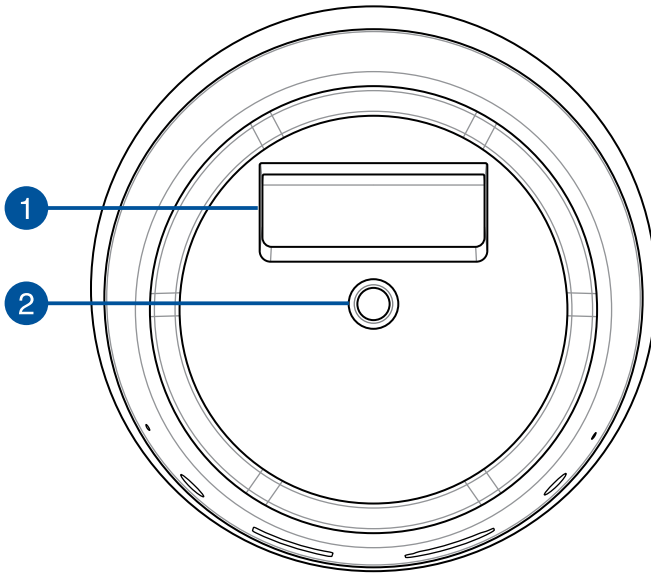

1 Built-in stand

This LED projector comes with a built-in stand that allows you to adjust the height of the projector by ± 5 degrees.

2 Tripod socket

Connect the LED projector to a tripod using this socket.

NOTE: The tripod is limited to a maximum height of 1m, and fits a 1/4-20UNC screw.

LED projector remote control

NOTE: Actual appearance may vary depending on model.

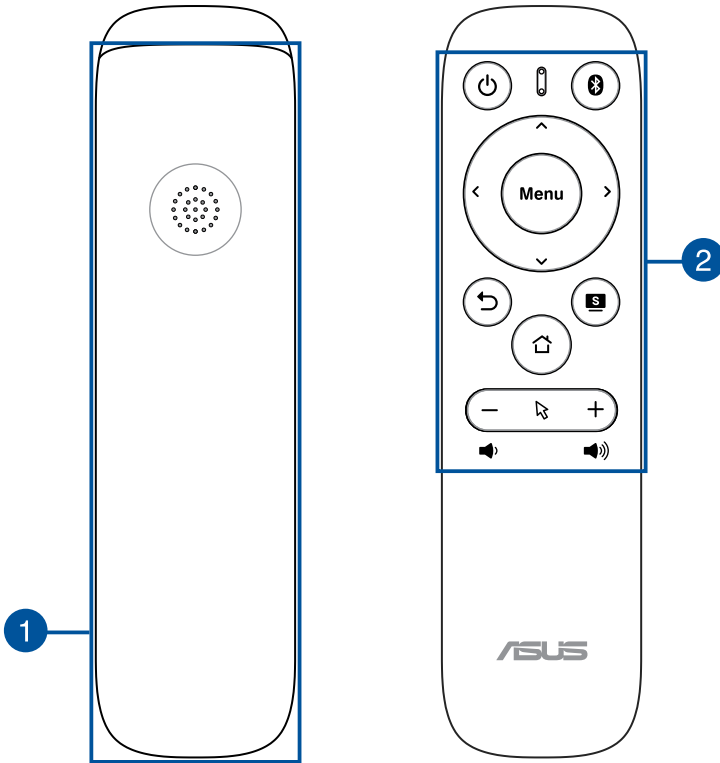

1 Battery compartment

The battery compartment allows you to install two (2) 3A batteries to power your LED projector's remote control.

NOTE: For more details on using the battery compartment, refer to the *Replacing the battery* section in this manual.

2 Remote control buttons

These additional buttons allow you to navigate the LED projector's onscreen display menu from a distance of up to 8 meters.

	Power - Press this button to turn your LED projector on or off.
---	--

	Bluetooth - Press this button to toggle between Bluetooth Speaker mode and Projector mode.
---	---

	Up - Press this button to move up.
---	---

	Down - Press this button to move down.
---	---

	Left - Press this button to move left.
---	---

	Right - Press this button to move right.
---	---

Menu	Menu/OK - Press this button to launch the menu or confirm a menu selection.
-------------	--

	Back - Press this button to go back to the previous screen.
---	--

	Home - Press this button to return to the home page.
---	---

	Splendid - Press this button to toggle splendid mode.
---	--

	Volume down - Press this button to decrease the volume.
---	--

	Volume up - Press this button to increase the volume.
---	--

	Cursor - Press this button to toggle the mouse cursor. You can move the mouse cursor using the Up , Down , Left , and Right buttons.
---	---

NOTE:

- You may use the remote control or toggle the cursor function to navigate through the onscreen display. For more details on the onscreen display menu, refer to the *Using the onscreen display menu* section.
 - When using Aptiode TV, please use the remote control to adjust the volume.
-

Replacing the battery

- A. Push the battery compartment downwards to remove the battery compartment cover.

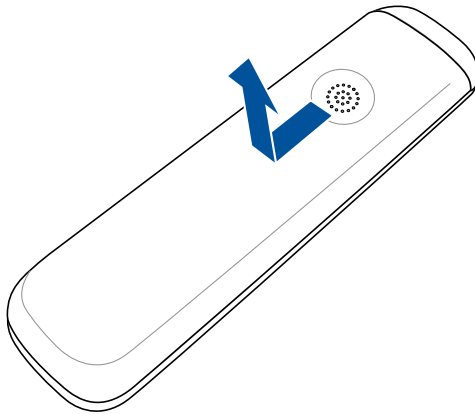

- B. Remove the old batteries, then insert two (2) new 3A batteries into the battery compartment.

NOTE: Take note of the direction of the batteries when installing them.

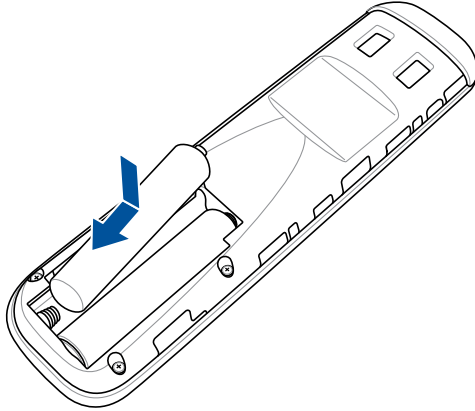

- C. Slide the battery compartment cover back onto the remote control, then push upwards to secure the battery compartment cover.

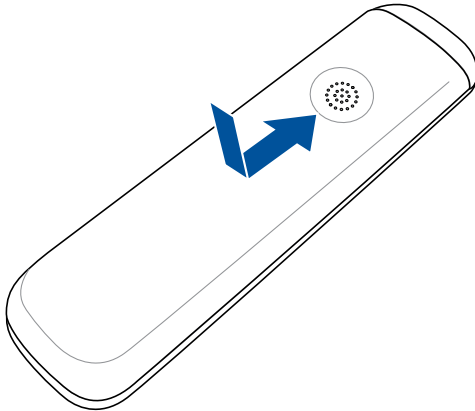

Chapter 2:
Setting up

Operating your LED projector

This portable LED projector allows you to plug and play your devices so you can easily open multimedia files and hear audio straight from its built-in Harman Kardon speakers. You may also use it as a portable Bluetooth speaker, providing you with high quality audio whenever you might need it.

For your safety and to maintain the quality of this unit, refer to the following steps when operating your LED projector.

Connect the LED projector to the power adapter

- A. Connect the AC/DC power cord to the power adapter.
- B. Connect the DC power connector to your LED projector.
- C. Connect the AC power cord to a power source.

Power adapter information:

- Input voltage: 100-240Vac
- Input frequency: 50-60Hz
- Rating output current: 3A max. (36W)
- Rating output voltage: 12V

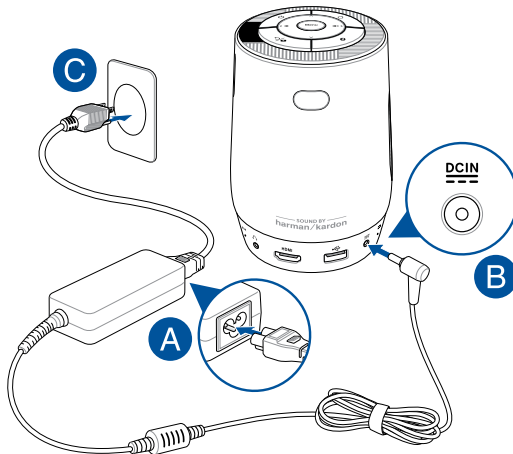

IMPORTANT!

- Use only the bundled power adapter to charge the battery pack and supply power to your LED projector.
 - Ensure that your LED projector is connected to the power adapter before turning it on for the first time. We strongly recommend that you use a grounded wall socket while using your LED projector on power adapter mode.
 - The socket outlet must be easily accessible and near your LED projector.
 - To disconnect your LED projector from its main power supply, unplug your LED projector from the power socket.
-

WARNING!

Read the following precautions for your LED projector's battery.

- The battery used in this device may present a risk of fire or chemical burn if removed or disassembled.
 - Follow the warning labels for your personal safety.
 - Risk of explosion if battery is replaced by an incorrect type.
 - Do not dispose of in fire.
 - Never attempt to short-circuit your LED projector's battery.
 - Never attempt to disassemble and reassemble the battery.
 - Discontinue usage if leakage is found.
 - The battery and its components must be recycled or disposed of properly.
 - Keep the battery and other small components away from children.
-

AC power cord requirements

Use the correct AC plug type according to your current location.

IMPORTANT! Contact your sales dealer if the AC power cord bundled with your LED projector does not match your local power source.

NOTE: We highly recommend that you use a video source device that also uses a grounding type plug to prevent signal interference due to voltage fluctuations.

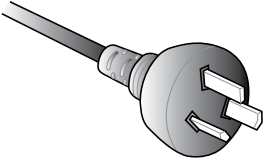

For Australia and Mainland China

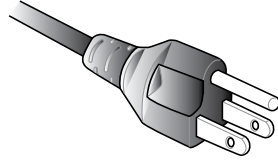

For U.S.A., Canada, and Taiwan

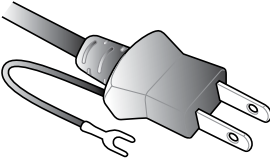

For Japan

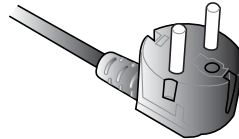

For Continental Europe

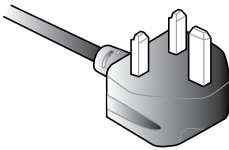

For U.K.

Connect the LED projector to your device

A. Audio output jack

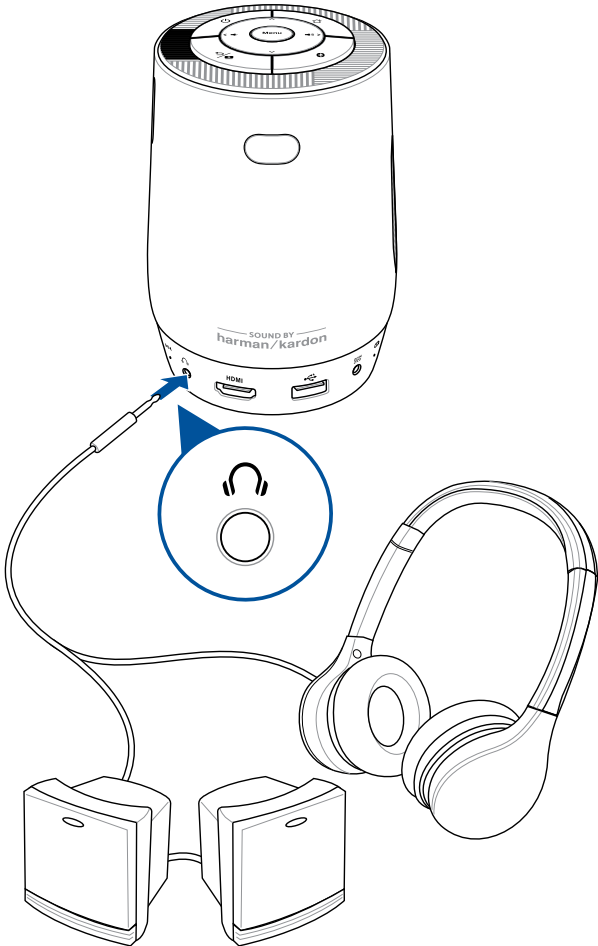

B. HDMI™ input

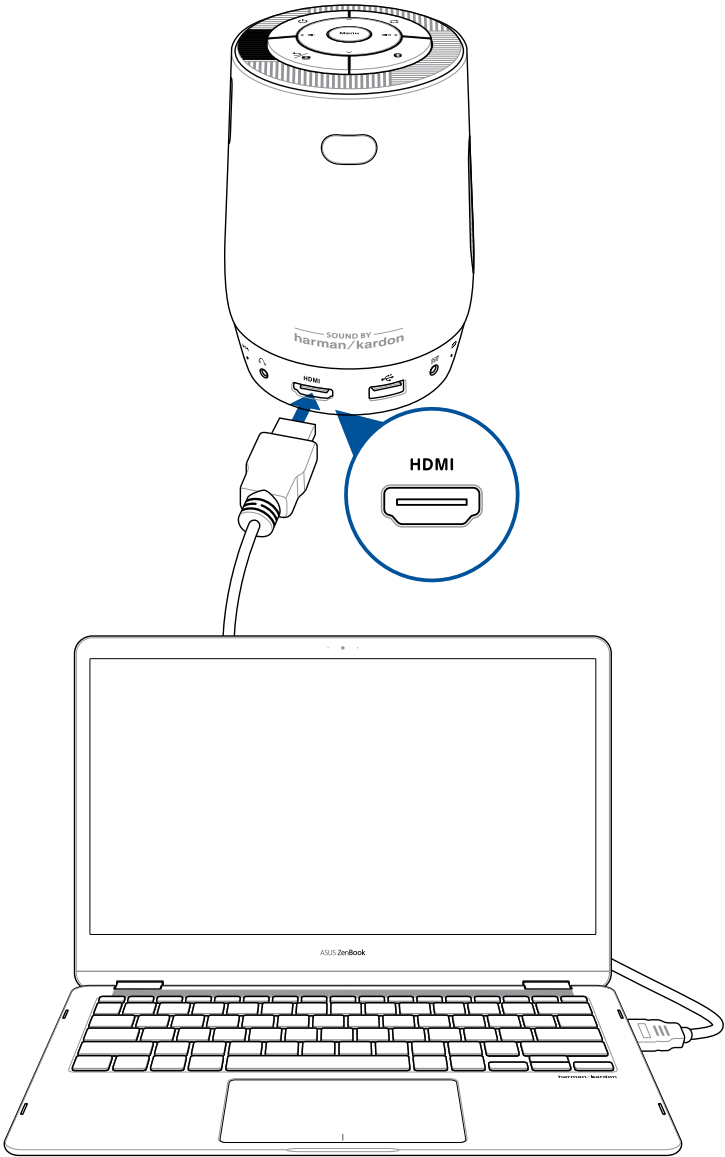

Adjust the height of the LED projector

Your LED projector comes with a built-in stand that helps adjust the image height onscreen.

WARNING! Ensure that the built-in stand is fully retracted before placing the LED projector inside the projector bag.

NOTE:

- Place the LED projector on a stable flat surface.
 - Keep a space of 30 cm or more between the sides of the LED projector.
 - Consult your dealer for special installation procedures like suspending the LED projector from the ceiling.
-

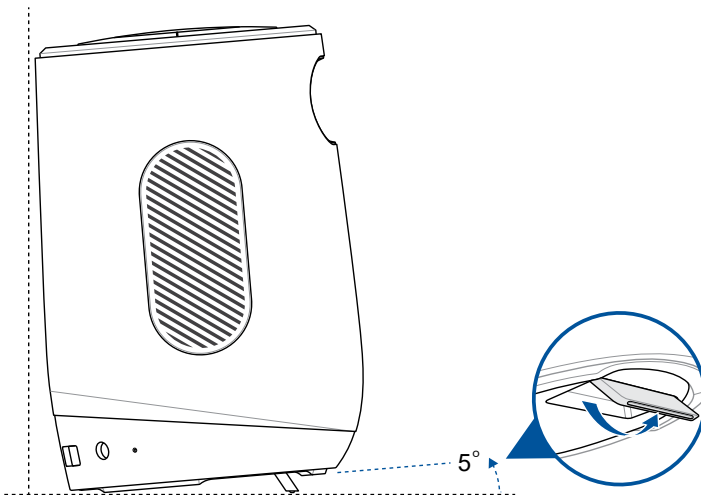

Screen size and projection distance table

Adjust the LED projector's distance from the screen using the table below.

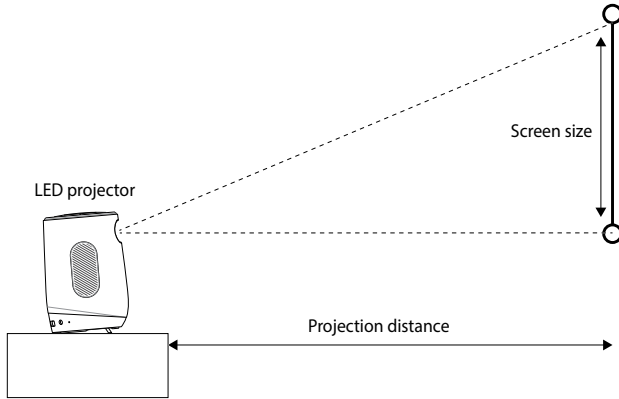

Screen Size						Projection Distance	
Diagonal		Horizontal		Vertical			
inch	mm	inch	mm	inch	mm	inch	mm
30	762	26.14	664	14.72	374	31.29	795
40	1016	34.88	886	19.60	498	41.77	1061
50	1270	43.58	1107	24.52	623	52.24	1327
60	1524	52.28	1328	29.40	747	62.71	1593
70	1778	61	1550	34.33	872	73.07	1856
80	2032	69.72	1771	39.21	996	83.54	2122
90	2286	78.42	1992	44.13	1121	94.05	2389
100	2540	87.12	2213	49.05	1246	104.48	2654
110	2794	95.86	2435	53.93	1370	114.96	2920
120	3048	104.56	2656	58.85	1495	125.39	3185

Press the power button

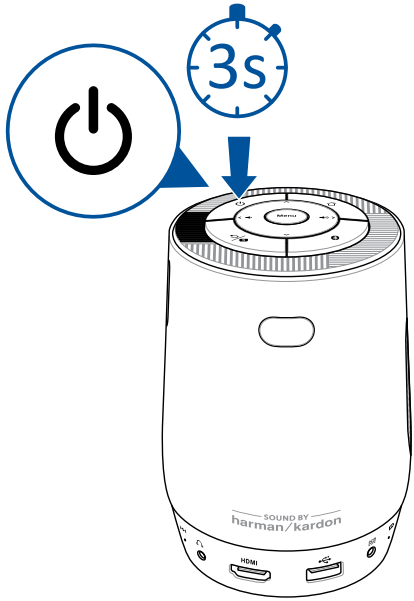

Adjust the image focus

Slide the focus dial on the LED projector up or down to adjust the image focus.

NOTE: Use a still image when adjusting the onscreen display.

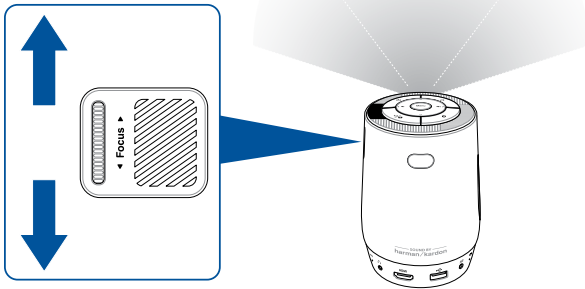

Chapter 3:
***Using the onscreen display
menu***

NOTE: The following screenshots are for reference only and may be updated without prior notice. Screenshots may also vary depending on the LED projector model.

Using your LED projector for the first time

Refer to the following steps when using your LED projector for the first time.

NOTE: Ensure that your LED projector is connected to the power adapter before turning it on for the first time. We strongly recommend that you use a grounded wall socket while using your LED projector on power adapter mode.

1. Set up your LED projector then press the power button.
2. Press the **Left** or **Right** buttons on your LED projector or on your remote control to browse through the available language options. You may also press the **Cursor** (⤴) icon on the remote control to enable the cursor and use the directional buttons to move to the language you wish to use.
3. After you have chosen your preferred language, press the **Menu** button on your LED projector or on your remote control to set this language for use on your LED projector.
4. Next select an available network for the LED projector to connect to. You may skip this step for the time being and choose to set up a network connection at a later time.
5. (optional) If you selected an available network to connect to, enter the password for the network connection if required.
6. You may now start using your LED projector to display files from your input device, watch media using the Aptiode TV app, as a Bluetooth speaker, or to mirror the screen of your phone.

Home page summary

The home page of your LED projector allows you to access all the different functions of the LED projector. You can use the remote control or buttons on your LED projector to navigate through the home page.

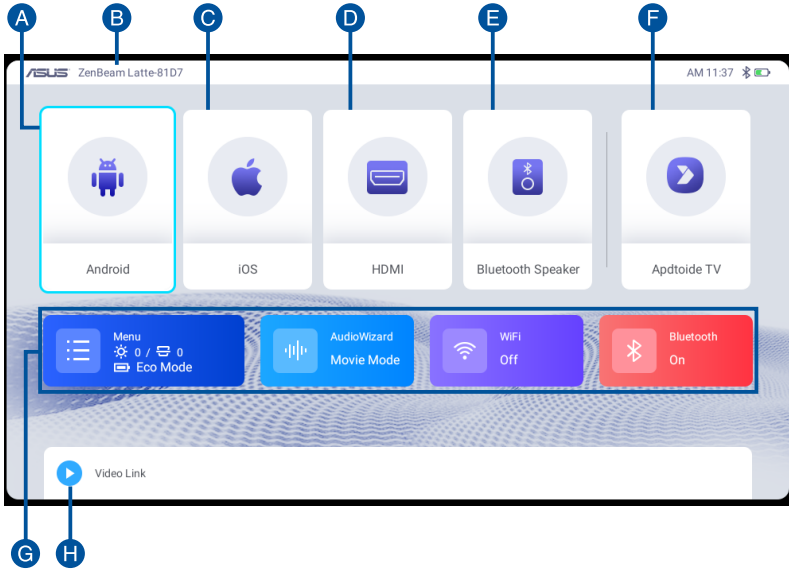

- A. **Android:** View a quick guide on setting up your Android mobile device and projector for mirroring.
- B. **Device name:** This is the ID of your LED projector. When using wireless functions, ensure to select this Device name in the Device's list.
- C. **iOS:** View a quick guide on setting up your iOS mobile device and projector for mirroring.
- D. **HDMI:** Toggle to input from an HDMI source.
- E. **Bluetooth Speaker:** Toggle to Bluetooth Speaker mode.

F. **Aptoide TV:** This item allows you to access Aptoide TV.

IMPORTANT! Not all apps are supported by this LED projector; some apps may require functions not supported by this LED projector, or may be limited to selected firmware versions.

NOTE:

- Some apps may require Google Services permissions and may also require use of a mouse and cursor.
 - Installing an app requires permissions from the user.
-

G. **Menu:** Opens up the menu and allows you to configure settings for your LED Projector.

H. **Video Link:** Allows you to share and save YouTube links for watching at a later time when connected to a network connection.

Using the Mirror function

The mirror function allows you to project your mobile device's screen to the projector. The setup process may differ slightly between Android and iOS mobile devices.

NOTE: You may consider installing a third-party app such as Eshare to improve your connection.

1. Ensure both the LED projector and your mobile device is connected to the same WiFi network.
2. The next steps may differ between Android and iOS devices.

For Android devices:

- A. Swipe down from the top of your mobile device's screen to open the Shortcut list, or navigate to **Settings** > **More connections** to select Wireless projection.

NOTE: The gesture for opening the Shortcut list and location for Wireless projection settings may differ between mobile device models. Please refer to your mobile device's user guide for more information.

- B. When the device list appears, select the Device name to begin projecting your mobile device's screen to the LED projector.

For iOS devices:

- A. Swipe down from the right upper corner or swipe up from the bottom of your mobile device's screen to open the Control Center, or navigate to **Settings** > **Connect** to select Screen Mirroring.
- B. When the device list appears, select Device name to begin projecting your mobile device's screen to the LED projector.

NOTE:

- The Device name you select should match the Device name shown at the top left of the home page. For more information on the location of the Device name, please refer to *Home page summary*.
 - In addition to using an Android mobile device's Screen cast, or an iOS mobile device's Screen mirroring function, you may also use YouTube's YouTube cast  function to project a YouTube video to the LED projector, doing so will allow you to continue using your mobile device for other things, whilst projecting a YouTube video to your LED projector at the same time.
-

Using the ZenBeam Latte as a Bluetooth speaker

The ZenBeam Latte can be used as Bluetooth speaker, featuring Harmon/Kardon speakers.

1. Ensure Bluetooth is enabled and turned on for your mobile device and the LED projector. You can turn on Bluetooth by clicking on the **Bluetooth** option on the home page, or clicking on **Menu > Bluetooth**, then turning on Bluetooth.

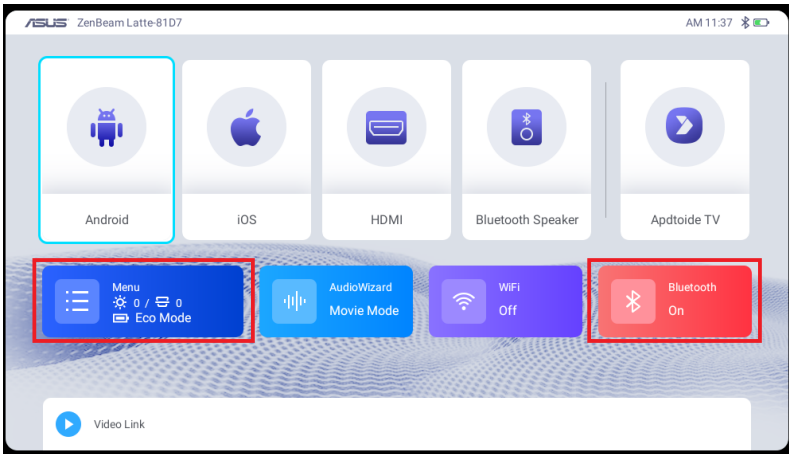

2. On your mobile device, search for ZenBeam Latte under your Bluetooth devices list then select it to pair your mobile device with the LED projector.

NOTE: If your device cannot find ZenBeam Latte, you may also pair your LED projector with your mobile device through your LED projector by navigating to **Menu > Bluetooth**, then selecting your mobile device in the **Available Devices** list.

3. After successfully pairing your mobile device with the LED projector, you can toggle to Bluetooth speaker mode by:
 - Pressing the Bluetooth button (📶) on the remote control or the LED projector.
 - Selecting the Bluetooth Speaker option on the home page.

Sending YouTube links to the LED projector

NOTE: This function is only available for Android devices.

You may send YouTube links to be watched when you are connected to a WiFi network. This allows you to customize your own playlist and also allow you to control the media content you wish to use on your LED projector.

1. Pair your LED projector and your mobile device through Bluetooth, for more information about pairing Bluetooth you may refer to steps 1 and 2 of the **Using the ZenBeam Latte as a Bluetooth speaker** section.
2. Launch YouTube on your mobile device, then on the video you wish to share, click on **Share** and share the video link to the LED projector through Bluetooth.
3. Click **OK** to store the video link(s) to the list on the LED projector. You can watch the videos on the list directly whenever you are connected to a WiFi connection.

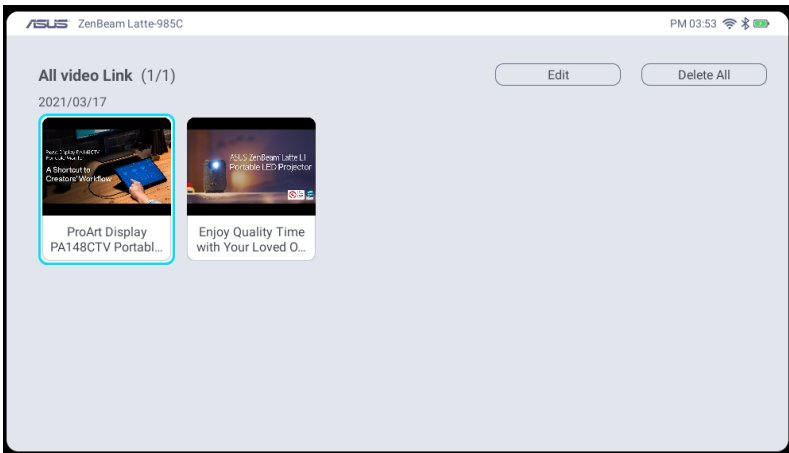

Using the Aptoide TV

Aptoide TV is an alternative app store providing you with various apps for use with your LED projector.

IMPORTANT! Not all apps are supported by this LED projector; some apps may require functions not supported by this LED projector, or may be limited to selected firmware versions.

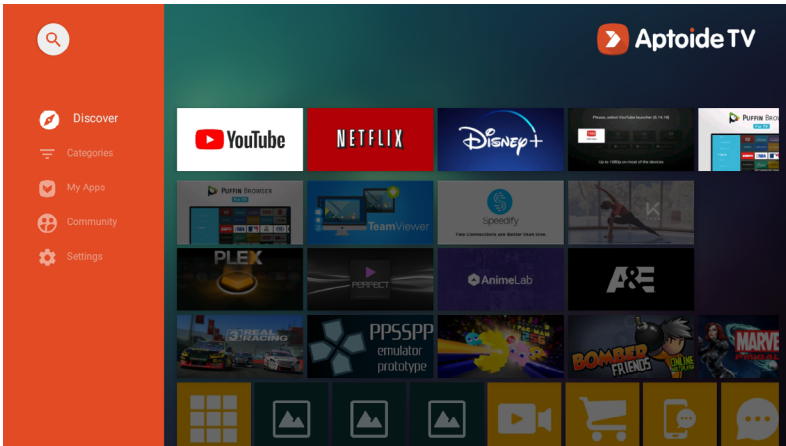

Navigating in Aptoide TV

Use the directional buttons on your remote control or LED projector to navigate through the app, or you can also press the **Cursor** (🖱️) icon on the remote control to enable the cursor and use the directional buttons to move the cursor around.

NOTE:

- We recommend using the remote control when navigating in Aptoide TV for a smoother experience.
 - If an App in Aptoide TV does not support the directional buttons on your LED projector or remote control, please press the **Cursor** (🖱️) icon on the remote control and switch to cursor mode.
 - We recommend connecting and using a mouse when using the cursor mode for a better usage experience.
-

Downloading and installing an app

You may browse through the **Discover** and **Categories** tabs to browse through apps to download, you may also use the **Search** (🔍) function to search for a specific app to download and install.

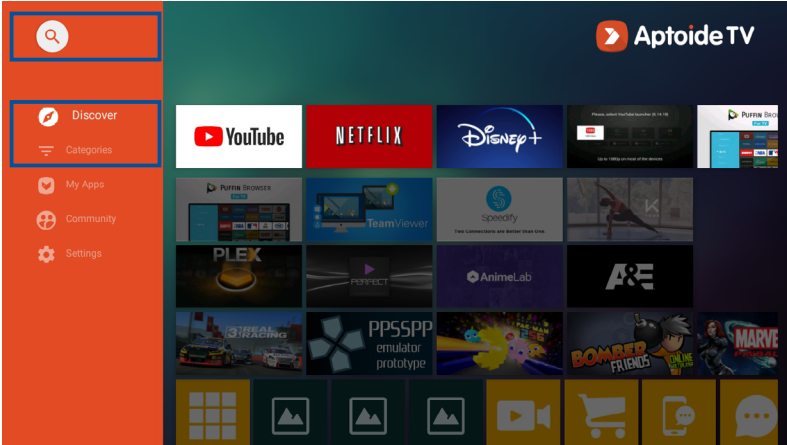

NOTE:

- Some apps may require Google Services permissions and may also require use of a mouse and cursor.

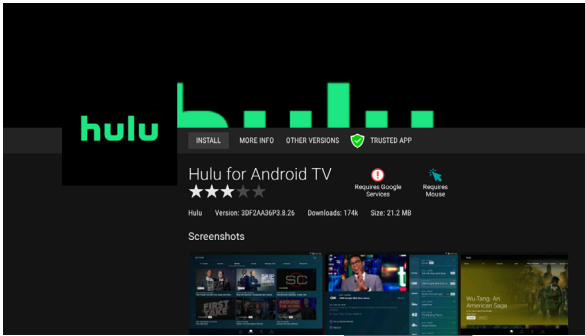

- Installing an unknown app requires permissions from the user.

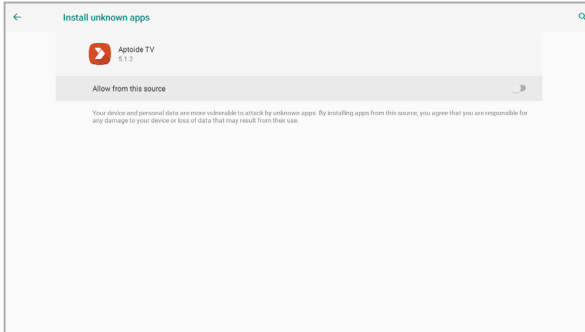

Putting your LED projector in Standby mode

To put your LED projector into Standby mode, press the power button on your LED projector or remote control, then select the **Standby** option.

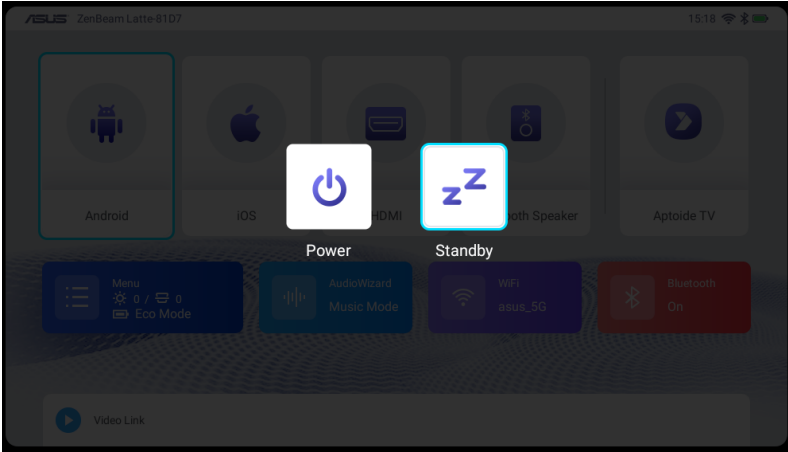

Powering off your LED projector

Powering off by a short press on the power button

You can power off the LED projector by pressing the power button on your LED projector or remote control, then selecting the **Power off** option.

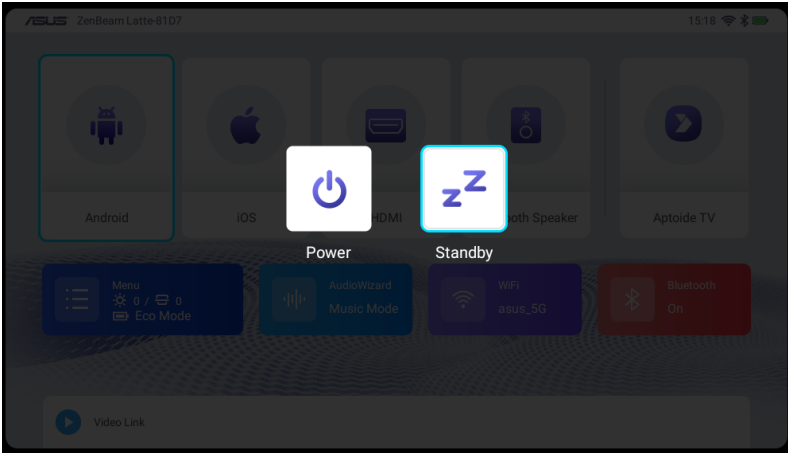

Powering off by long pressing the power button

Long press on the power button on your LED projector or remote control to prompt a pop-up. To power off the LED projector, press the power button again, or click on **OK**.

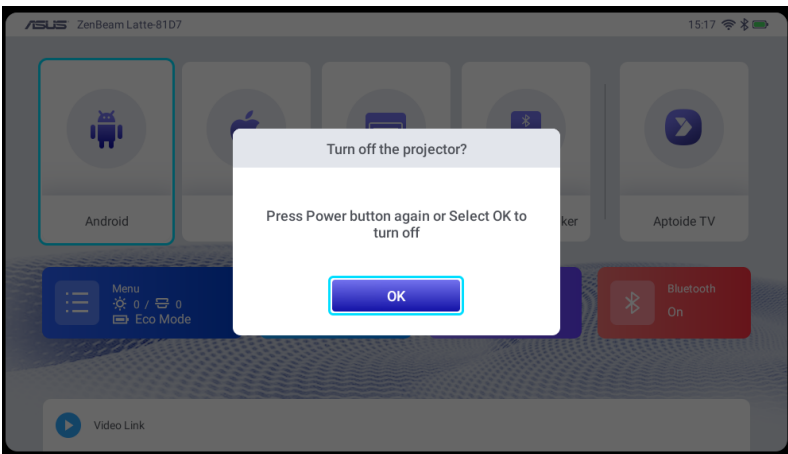

Appendices

Federal Communications Commission Statement

This device complies with part 15 of the FCC Rules. Operation is subject to the following two conditions: (1) This device may not cause harmful interference, and (2) this device must accept any interference received, including interference that may cause undesired operation.

NOTE: This equipment has been tested and found to comply with the limits for a Class B digital device, pursuant to part 15 of the FCC Rules. These limits are designed to provide reasonable protection against harmful interference in a residential installation. This equipment generates, uses and can radiate radio frequency energy and, if not installed and used in accordance with the instructions, may cause harmful interference to radio communications.

The device should be installed and operated with a minimum distance of 20 cm between the radiator and your body.

RF Exposure Statement of Statement for Canada

The radiated output power of the Wireless Device is below the Industry Canada (IC) radio frequency exposure limits. The Wireless Device should be used in such a manner such that the potential for human contact during normal operation is minimized.

The device should be installed and operated with a minimum distance of 20 cm between the radiator and your body.

La puissance de sortie émise par l'appareil de sans fil Dell est inférieure à la limite d'exposition aux fréquences radio d'Industry Canada (IC). Utilisez l'appareil de sans fil Dell de façon à minimiser les contacts humains lors du fonctionnement normal.

L'appareil doit être installé et actionné avec une distance de 20 cm entre le radiateur et votre corps.

Compliance Statement of Innovation, Science and Economic Development Canada (ISED)

This device complies with Innovation, Science and Economic Development Canada licence exempt RSS standard(s). Operation is subject to the following two conditions: (1) this device may not cause interference, and (2) this device must accept any interference, including interference that may cause undesired operation of the device.

This Class B digital apparatus complies with Canadian ICES-003. Canada: 5.150-5.250 GHz, indoor use only.

Déclaration de conformité de Innovation, Sciences et Développement économique Canada (ISED)

Le présent appareil est conforme aux CNR d'Innovation, Sciences et Développement économique Canada applicables aux appareils radio exempts de licence. L'exploitation est autorisée aux deux conditions suivantes : (1) l'appareil ne doit pas produire de brouillage, et (2) l'utilisateur de l'appareil doit accepter tout brouillage radioélectrique subi, même si le brouillage est susceptible d'en compromettre le fonctionnement.

Cet appareil numérique de la classe B est conforme à la norme ICES-003 du Canada. Canada: 5,150 GHz - 5,250 GHz, utilisation en intérieur uniquement.

HDMI Trademark Notice

The terms HDMI, HDMI High-Definition Multimedia Interface, HDMI trade dress and the HDMI Logos are trademarks or registered trademarks of HDMI Licensing Administrator, Inc.

Global Environmental Regulation Compliance and Declaration

ASUS follows the green design concept to design and manufacture our products, and makes sure that each stage of the product life cycle of ASUS product is in line with global environmental regulations. In addition, ASUS disclose the relevant information based on regulation requirements.

Please refer to <https://esg.asus.com/Compliance.htm> for information disclosure based on regulation requirements ASUS is complied with:

Japan JIS-C-0950 Material Declarations

EU REACH SVHC

Korea RoHS

ASUS Recycling/Takeback Services

ASUS recycling and takeback programs come from our commitment to the highest standards for protecting our environment. We believe in providing solutions for you to be able to responsibly recycle our products, batteries, other components as well as the packaging materials. Please go to <https://esg.asus.com/en/Takeback.htm> for detailed recycling information in different regions.

Simplified EU Declaration of Conformity

ASUSTek Computer Inc. hereby declares that this device is in compliance with the essential requirements and other relevant provisions of Directive 2014/53/EU. Full text of EU declaration of conformity is available at <https://www.asus.com/support>.

The WiFi operating in the band 5150-5350 MHz shall be restricted to indoor use for countries listed in the table below:

AT	BE	BG	CZ	DK	EE	FR
DE	IS	IE	IT	EL	ES	CY
LV	LI	LT	LU	HU	MT	NL
NO	PL	PT	RO	SI	SK	TR
FI	SE	CH	HR	UK(NI)		

Simplified UKCA Declaration of Conformity

ASUSTek Computer Inc. hereby declares that this device is in compliance with the essential requirements and other relevant provisions of The Radio Equipment Regulations 2017 (S.I. 2017/1206). Full text of UKCA declaration of conformity is available at <https://www.asus.com/support/>.

The WiFi operating in the band 5150-5350MHz shall be restricted to indoor use for the country listed below:

UK

CE RED RF Output table (Directive 2014/53/EU)

Function	Frequency	Maximum Output Power (EIRP)
WiFi	2412 - 2472 MHz	< 20 dBm
	5150 - 5250 MHz	< 20 dBm
	5250 - 5350 MHz	< 20 dBm
	5470 - 5725 MHz	< 20 dBm
Bluetooth LE	2402 - 2480 MHz	< 10 dBm
Bluetooth BR+EDR	2402 - 2480 MHz	< 10 dBm

UKCA RF Output table (The Radio Equipment Regulations 2017)

Function	Frequency	Maximum Output Power (EIRP)
WiFi	2412 - 2472 MHz	< 20 dBm
	5150 - 5250 MHz	< 20 dBm
	5250 - 5350 MHz	< 20 dBm
	5470 - 5725 MHz	< 20 dBm
Bluetooth LE	2402 - 2480 MHz	< 10 dBm
Bluetooth BR+EDR	2402 - 2480 MHz	< 10 dBm



电子电气产品有害物质限制使用标识：图中之数字为产品之环保使用期限。仅指电子电气产品中含有的有害物质不致发生外泄或突变，从而对环境造成污染或对人身、财产造成严重损害的期限。

设备名称 Equipment name : LED 投影机，型号：Latte L1						
部件名称	有害物质的名称及含量					
	铅 Lead (Pb)	汞 Mercury (Hg)	镉 Cadmium (Cd)	六价铬 Hexavalent chromium (Cr+6)	多溴联苯 Polybrominated biphenyls (PBB)	多溴二苯醚 Polybrominated diphenyl ethers (PBDE)
塑胶外框	○	○	○	○	○	○
五金件	×	○	○	○	○	○
光机	×	○	○	○	○	○
风扇	○	○	○	○	○	○
线路板组件	×	○	○	○	○	○
电线	○	○	○	○	○	○
扬声器	○	○	○	○	○	○
散热模组	○	○	○	○	○	○
适配器	×	○	○	○	○	○
遥控器	×	○	○	○	○	○
包装材料	○	○	○	○	○	○

备注 1. 线路板组件包括印刷线路板及其构成的零部件，如电阻、电容、集成电路、连接器等。
本表格依据 SJ/T 11364 的规定编制。

备注 2. ○：指该项有害物质在该部件所有均质材料中的含量均在 GB/T 26572 规定的限量要求下。

备注 3. ×：指该有害物质至少在该部件的某一均质材料汇总的含量超过 GB/T 26572 规定的限量要求，但符合欧盟 RoHS 法规要求（属于豁免部分）

「產品之限用物質含有情況」之相關資訊，請參考下表。

設備名稱 Equipment name：微型投影儀 LED PROJECTOR， 型號（型式）Type designation (Type)：L1, L1C, L1E, L1M, L1Z						
單元 Unit	限用物質及其化學符號 Restricted substances and its chemical symbols					
	鉛 Lead (Pb)	汞 Mercury (Hg)	鎘 Cadmium (Cd)	六價鉻 Hexavalent chromium (Cr+6)	多溴聯苯 Polybrominated biphenyls (PBB)	多溴二苯醚 Polybrominated diphenyl ethers (PBDE)
塑膠外框 Plastic Frame	○	○	○	○	○	○
金屬機構 Hardware	—	○	○	○	○	○
光機 Optical engine	—	○	○	○	○	○
風扇 Fan	○	○	○	○	○	○
印刷電路板 PCB	○	○	○	○	○	○
電纜 Wire	○	○	○	○	○	○
揚聲器 Speaker	○	○	○	○	○	○
散熱模組 Heat dissipation module	○	○	○	○	○	○
電源供應器 Adapter	○	○	○	○	○	○
遙控器 Remote control	○	○	○	○	○	○
包裝材料 Packing material	○	○	○	○	○	○
備考 1. “超出 0.1 wt %”及“超出 0.01 wt %”係指限用物質之百分比含量超出百分比含量基準值。 Note 1: “Exceeding 0.1 wt %” and “exceeding 0.01 wt %” indicate that the percentage content of the restricted substance exceeds the reference percentage value of presence condition.						
備考 2. “○”係指該項限用物質之百分比含量未超出百分比含量基準值。 Note 2: “○” indicates that the percentage content of the restricted substance does not exceed the percentage of reference value of presence.						
備考 3. “—”係指該項限用物質為排除項目。 Note 3: The “—” indicates that the restricted substance corresponds to the exemption.						

Specifications for ZenBeam Latte LED projector

		ZenBeam Latte L1
Display	Display Technology	0.23" DLP®
	Light Source	R/G/B LED
	Light Source Life	30,000 hours
	True Resolution (native)	HD 720p (1280 x 720)
	Light Output (Max)	300 LED Lumen
	Contrast Ratio	400:1 (typical)
	Display Colors	16.7 Million Colors
Projection Lens	Throw Ratio	1.2:1 (38" @ 1m)(@16:9)
	Projection Distance / Size	0.8m~3.2m
	Projection Offset	100%+-5%
	Zoom Ratio	NA
	Focus	Manual Focus
Video Features	Picture Modes	4 modes (Presentation / Standard / Theater / Eco)
	Keystone adjustment	+/- 40 degree Vertical keystone correction
	Auto Keystone	Yes (Vertical)
	Aspect Ratio	16:9 / 4:3
	Projector Placement	Front Table, Rear Table, Rear ceiling, Front ceiling
	Wireless Projection	Yes, Android, iOS, and MAC OS
	Bluetooth	Yes, Bluetooth V 5.0 (EDR + A2DP)
Audio Features	Built-in speakers	2 x 5W speakers / sound by Harman/kardon

(continued on the next page)

		ZenBeam Latte L1
Power	Power On Mode	<36W
	Standby Mode	<0.5 W
	Battery	6,000 mAh (22W/hr) up to 3 hrs (Eco mode)
Noise	Acoustic Noise (Standard/Eco)	(30dB/28dB)
Interface	Signal Input	HDMI
	Audio Output	Earphone out (3.5mm Mini-jack)
	USB Port	1 x Type-A 2.0
	WiFi	Yes, Wi-Fi 802.11 a/b/g/n/ac, 5G/2.4G dual-band
	Bluetooth	Yes, Bluetooth V 5.0 (EDR + A2DP)
Mechanical Design	Tripod Socket	Yes
	Stand	Yes, 1 step
	Ceiling Mount	No
Dimension	Physical Dimension (WxDxH)	90 x 90 x 131mm (Widest Waist: 90.90x 90.90mm)
	Box Dimension (WxDxH)	296 x 109 x 147mm
Weight	Net Weight (Esti.)	585g
	Gross Weight (Esti.)	1300g
Operating Temperature		0 ~ 40° C
Operating Humidity		20 ~ 90%
Accessories		Pouch, HDMI Cable, Power Adapter, Power Cord, Remote Control, 2 x AAA batteries, QSG, Warranty Card

NOTE:

- Specifications are subject to change without prior notice.
 - Product availability may vary by region.
 - All brand and product names mentioned are trademarks of their respective companies.
-

Support PC Timings

HDMI (PC)

Resolution	Mode	Refresh rate (Hz)	H-frequency (kHz)	Clock (MHz)
800 x 600	SVGA_60	60.317	37.879	40
	SVGA_75	75	46.875	49.5
1024 x 768	XGA_60	60.004	48.363	65
	XGA_75	75.029	60.023	78.75
1280 x 768	1280 x 768_60	59.87	47.776	79.5
1280 x 800	WXGA_60	59.81	49.702	83.5
1280 x 1024	SXGA_60	60.02	63.981	108
	SXGA_75	75.025	79.976	135
1280 x 960	1280 x 960_60	60	60	108
1440 x 900	WXGA+_60	59.887	55.935	106.5
1400x1050	SXGA+_60	59.978	65.317	121.75
1024x768@75Hz	MAC19	74.93	60.241	80
1366x768	HD_60	59.79	47.71	85.50
1680x1050	WSXGA+_60	59.95	62.29	148.50

HDMI (Video)

Timing	Resolution	Vertical frequency (Hz)	H-frequency (kHz)	Dot Clock frequency (MHz)
720/50p	1280 x 720	50	37.5	74.25
720/60p	1280 x 720	60	45	74.25
1080/50P	1920 x 1080	50	56.25	148.5
1080/60P	1920 x 1080	60	67.5	148.5
1080/24P	1920 x 1080	24		

For more information on this product, please refer to the label located on the bottom of the device.

Access Advance Patent Notice



