

H310A-EM-A

ATX, LGA1151 socket for the 9th/8th Gen CPU, H310 chipset, 2*DIMM.
1*PCIe x16, 1*DP, 1*HDMI, 1*VGA, 1*M.2 slot, 4*SATA connectors

Features

- Two DIMM up to 64GB DDR4 2666/2400/2133 MHz SDRAM.
- Supports 3 displays (2 displays simultaneous): 1 x DP, 1 x HDMI, 1 x VGA
- 7-year longevity supply
- Wide temperature Range: 0~60°C

Specifications



Processor System	CPU	LGA1151 socket for the 9th/8th Generation Intel® Core™ i7/ i5/ i3/ Pentium® / Celeron® processors supports 14nm CPU, Max. 65W TDP
	CHIPSET	Intel® H310 chipset
Memory	Technology	DDR4 2666/2400/2133 MHz, non-ECC, un-buffered memory *DDR4 2666MHz and higher memory modules will run at max. 2666MHz on Intel® 8th Gen. 6-core or higher processors.
	Max.	64GB
	Socket	2 x U-DIMM
Display	Controller	Intel UHD Graphics
	DP	1, Supports 4096 x 2160 @60 Hz
	HDMI	1, Supports 4096 x 2160 @60 Hz
	VGA	1, Supports 4096 x 2160 @60 Hz
Multi Display	DP+HDMI+VGA (*Supports up to 2 displays simultaneous under OS)	
Expansion Slot	PCIe	1x PCIe x16 3x PCIe 2.0 (1 run @ x4 speed max, or 2 run @ x1 speed+1 run @ x2 speed) 3 x PCI slots From top to down:X16; X4 (run at x1), X4 (run at x1), X4 ,3*PCI *PCIe 2.0 : when 1 run at x4, 2X1 unavailable; when 1 run at x2 , 2X1 available.
	M.2	1 x M.2 socket 3 with M key, type 2242/ 2260/2280 storage devices(SATA)
Ethernet	Speed	10/100/1000Mbps
	Controller	1x Realtek® RTL8111H Gb Lan , 1xIntel® i219V
	Connector	2 x RJ-45
Audio	Codec	Realtek ALC897(VA2& VB0), High Definition Audio CODEC
	Connector	Line-Out, Mic-In
Storage	SATA port	4x SATA Gen 3.0, up to 6Gb/s(*No. 4 SATA port shared with M.2)
Rear I/O	DP	1
	HDMI	1
	VGA	1
	USB 3.2 Gen1	4
	USB 2.0	2
	Ethernet	2
	Serial Port	2(RS232/422/485)
	Audio jack	2
Internal Connector	Serial Port	4(RS-232 header)
	PS/2(KBMS)	1(2*4Pin)
	USB2.0	1, support additional 2 x USB2.0 connectors 1xsingle port, 1 x stick socket
	CPU Fan Connector	1 (PWM Mode)
	Chassis Fan Header	1
	Chassis Intrusion Header	1
	Front Panel Audio Header (AAFP)	1
	System Panel Header	1
	Buzzer	1
	Clear CMOS Jumper	1
	Speaker Connector	1
	Parallel connector	1
	COM Debug header	1
	SPI TPM header	1
	GPIO Header	1 (2*5pin ,4pin GPIO)
Power Connector	1 x 24-pin EATX Power connector,1 x 4-pin EATX 12V Power connector	

Specifications

Watchdog Timer	S/W	YES
Security	TPM	1 x SPI TPM header
Power	Power Type	both AT/ATX mode
Operating System	Microsoft Windows	Windows® 10 (64bit) / Win10 IoT Enterprise
	Linux	Ubuntu, RedHat Enterprise, Fedora Workstation
Environment	Operating Temperature	0~60 °C
	Non-Operating Temperature	-40~85 °C
	Relative Humidity	10%~95% non-coagulation
Dimension	Form Factor	ATX (305 x 244 mm)
Certification	Safety	CE

Block Diagram

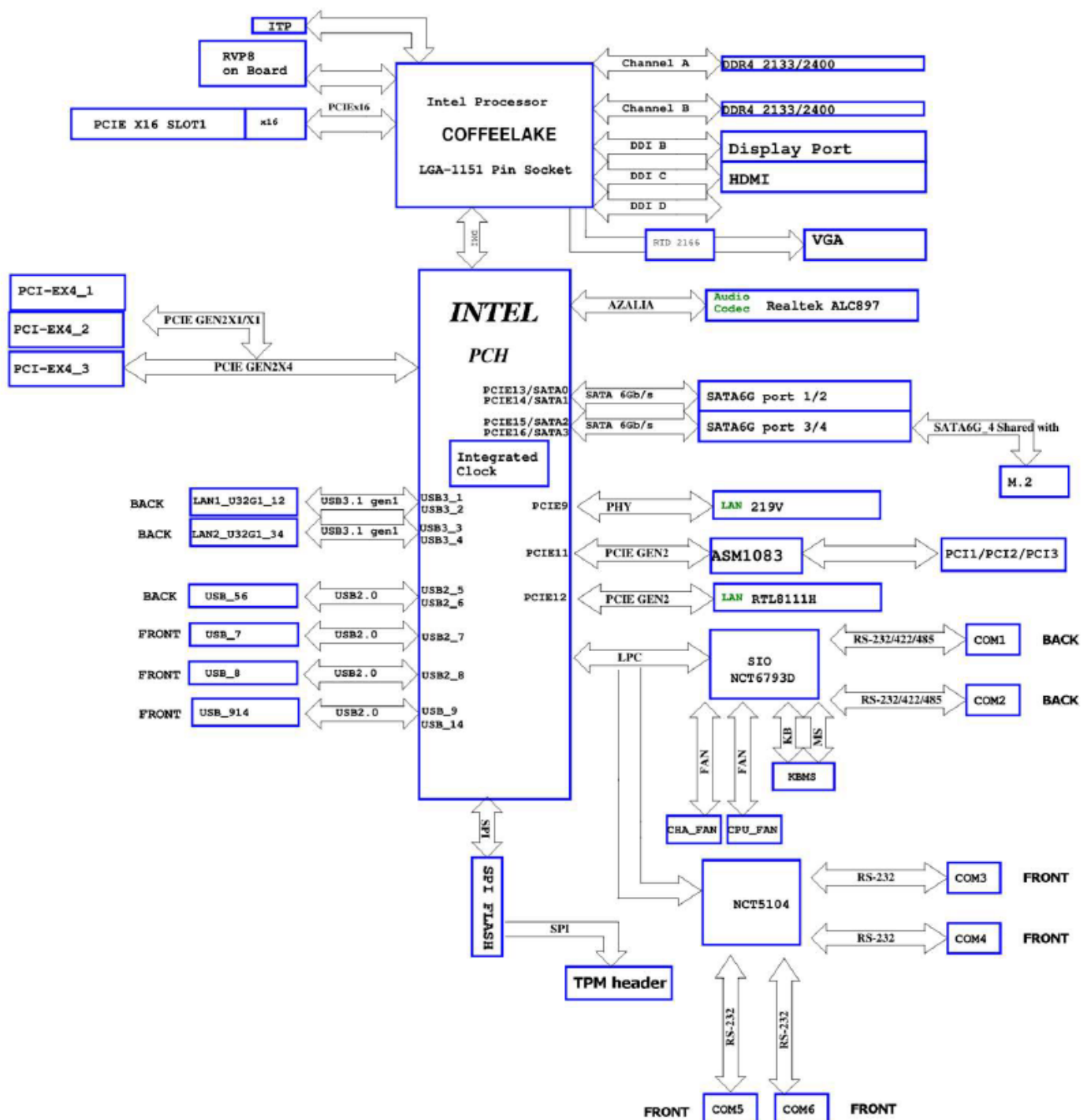

Order Information

Model name	Part number	Description
H310A-EM-A	90ME0840*	LGA1151,H310,DP,HDMI,VGA,COM,MB

* The part number might vary for different regulations and package. Please consult the TPM in your region for exact 90PN.

Packing List

Part number	Description	Quantity
13020*	IO shield	1
14013*	SATA 6G CABLE	1
13020*	M.2 screw pack	1

* The part number might vary due to part number revision.