



X621EP-IM-AA

X641EP-IM-AA

X642EP-IM-AA

X6425REP-IM-AA

User Manual



E22082

First Edition

November 2023

COPYRIGHT INFORMATION

No part of this manual, including the products and software described in it, may be reproduced, transmitted, transcribed, stored in a retrieval system, or translated into any language in any form or by any means, except documentation kept by the purchaser for backup purposes, without the express written permission of ASUSTeK COMPUTER INC. ("ASUS").

ASUS PROVIDES THIS MANUAL "AS IS" WITHOUT WARRANTY OF ANY KIND, EITHER EXPRESS OR IMPLIED, INCLUDING BUT NOT LIMITED TO THE IMPLIED WARRANTIES OR CONDITIONS OF MERCHANTABILITY OR FITNESS FOR A PARTICULAR PURPOSE. IN NO EVENT SHALL ASUS, ITS DIRECTORS, OFFICERS, EMPLOYEES OR AGENTS BE LIABLE FOR ANY INDIRECT, SPECIAL, INCIDENTAL, OR CONSEQUENTIAL DAMAGES (INCLUDING DAMAGES FOR LOSS OF PROFITS, LOSS OF BUSINESS, LOSS OF USE OR DATA, INTERRUPTION OF BUSINESS AND THE LIKE), EVEN IF ASUS HAS BEEN ADVISED OF THE POSSIBILITY OF SUCH DAMAGES ARISING FROM ANY DEFECT OR ERROR IN THIS MANUAL OR PRODUCT.

Products and corporate names appearing in this manual may or may not be registered trademarks or copyrights of their respective companies, and are used only for identification or explanation and to the owners' benefit, without intent to infringe.

SPECIFICATIONS AND INFORMATION CONTAINED IN THIS MANUAL ARE FURNISHED FOR INFORMATIONAL USE ONLY, AND ARE SUBJECT TO CHANGE AT ANY TIME WITHOUT NOTICE, AND SHOULD NOT BE CONSTRUED AS A COMMITMENT BY ASUS. ASUS ASSUMES NO RESPONSIBILITY OR LIABILITY FOR ANY ERRORS OR INACCURACIES THAT MAY APPEAR IN THIS MANUAL, INCLUDING THE PRODUCTS AND SOFTWARE DESCRIBED IN IT.

Copyright © 2023 ASUSTeK COMPUTER INC. All Rights Reserved.

LIMITATION OF LIABILITY

Circumstances may arise where because of a default on ASUS' part or other liability, you are entitled to recover damages from ASUS. In each such instance, regardless of the basis on which you are entitled to claim damages from ASUS, ASUS is liable for no more than damages for bodily injury (including death) and damage to real property and tangible personal property; or any other actual and direct damages resulted from omission or failure of performing legal duties under this Warranty Statement, up to the listed contract price of each product.

ASUS will only be responsible for or indemnify you for loss, damages or claims based in contract, tort or infringement under this Warranty Statement.

This limit also applies to ASUS' suppliers and its reseller. It is the maximum for which ASUS, its suppliers, and your reseller are collectively responsible.

UNDER NO CIRCUMSTANCES IS ASUS LIABLE FOR ANY OF THE FOLLOWING: (1) THIRD-PARTY CLAIMS AGAINST YOU FOR DAMAGES; (2) LOSS OF, OR DAMAGE TO, YOUR RECORDS OR DATA; OR (3) SPECIAL, INCIDENTAL, OR INDIRECT DAMAGES OR FOR ANY ECONOMIC CONSEQUENTIAL DAMAGES (INCLUDING LOST PROFITS OR SAVINGS), EVEN IF ASUS, ITS SUPPLIERS OR YOUR RESELLER IS INFORMED OF THEIR POSSIBILITY.

SERVICE AND SUPPORT

Visit our multi-language website at <https://www.asus.com/support/>

Contents

About this manual.....	5
Conventions used in this manual.....	6
Package contents	7
Chapter 1: Specifications Summary	
Specifications Summary.....	10
Chapter 2: Product Introduction	
2.1 Before you proceed	14
2.2 Motherboard layout.....	15
2.3 Onboard jumpers & switches.....	17
2.4 Internal connectors	18
2.5 I/O connectors.....	25
Chapter 3: Upgrading your Single Board Computer	
3.1 Installing an M.2 SSD.....	29
3.2 Installing the wireless card	30
3.3 Installing a heatsink.....	31
3.4 Installing a heat spreader.....	33
Chapter 4: BIOS Setup	
4.1 Getting to know your BIOS.....	36
4.2 BIOS setup program	37
4.3 Main Menu.....	39
4.3.1 System Date [Day xx/xx/xxxx].....	39
4.3.2 System Time [xx:xx:xx].....	39
4.4 Advanced menu	40
4.4.1 LVDS Configuration	41
4.4.2 PCH-FW Configuration.....	44
4.4.3 Trusted Computing	45
4.4.4 CPU Configuration.....	47
4.4.5 Graphics Configuration.....	49
4.4.6 Super IO Configuration	50

4.4.7	Serial Console Redirection.....	51
4.4.8	SATA Configuration	54
4.4.9	Network Stack Configuration	55
4.4.10	USB Configuration	56
4.4.11	NVMe Configuration	57
4.4.12	SDIO Configuration	58
4.4.13	Onboard Devices Configuration.....	59
4.4.14	APM Configuration.....	61
4.4.15	EZ-Flash.....	62
4.4.16	Watchdog Timer	63
4.5	Hardware Monitor menu	64
4.6	Security menu	65
4.7	Boot menu	69
4.8	Exit menu	71
4.9	Updating your BIOS.....	73
4.9.1	ASUS CrashFree BIOS utility.....	73
4.9.2	ASUS EZ-Flash Utility.....	74

Appendix

Safety information.....	78
Setting up your system	78
Care during use.....	79
Safety precautions.....	80
Regulatory notices	81
Service and Support	86

About this manual

This manual provides information about the hardware and software features of your Single Board Computer, organized through the following chapters:

Chapter 1: Specifications Summary

This chapter details the hardware and software features of your Single Board Computer.

Chapter 2: Product Introduction

This chapter describes the features of the motherboard. It includes description of the connectors, and I/O ports on the motherboard.

Chapter 3: Upgrading your Single Board Computer

This chapter provides you with information on how to upgrade the memory modules, wireless modules, and hard disk drive / solid state drive of your Single Board Computer.

Chapter 4: BIOS Setup

This chapter tells how to change system settings through the BIOS Setup menus. Detailed descriptions of the BIOS parameters are also provided.

Appendix

This section includes notices and safety statements for your Single Board Computer.

Conventions used in this manual

To highlight key information in this manual, some text are presented as follows:

IMPORTANT! This message contains vital information that must be followed to complete a task.

NOTE: This message contains additional information and tips that can help complete tasks.

WARNING! This message contains important information that must be followed to keep you safe while performing certain tasks and prevent damage to your Single Board Computer's data and components.

Package contents

Your Single Board Computer package contains the following items:

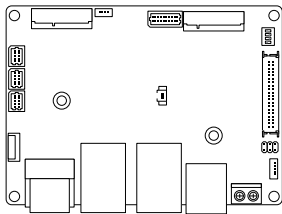

X621EP-IM-AA / X641EP-IM-AA / X642EP-IM-AA /
X6425REP-IM-AA

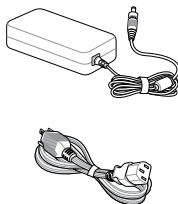

Power adapter and cord*

NOTE:

- *The bundled power adapter and power cord may vary depending on model and country (or region) of sale.
 - Some bundled accessories may vary with different models. For details on these accessories, refer to their respective user manuals.
 - The device illustration is for reference only. Actual product specifications may vary with models.
 - If the device or its components fail or malfunction during normal and proper use within the warranty period, bring the warranty card to the ASUS Service Center for replacement of the defective components.
-

1

Specifications Summary

Specifications Summary

Product Name	CPU Intel® Atom®	Processor Base Frequency	Memory	eMMC
X621EP-IM-AA	x6211E	1.3 GHz Dual-core	LPDDR4 x3200	64 GB
X641EP-IM-AA	x6413E	1.5 GHz Quad-core	4 GB	64 GB
X642EP-IM-AA	x6425E	2.0 GHz Quad-core	LPDDR4 x3733	64 GB
X6425REP-IM-AA	x6425RE	1.9 GHz Quad-core	8 GB	128 GB

Form factor		2.5", 100 x 72 mm
Display	HDMI	1 x HDMI 2.0 up to 4096 x 2160 @ 60 Hz 1 x HDMI 1.4 up to 4096 x 2160 @ 30 Hz
	LVDS	1 x LVDS supports 1920 x 1080 @ 60 Hz (co-lay with eDP)
	Multi Display	HDMI+HDMI+LVDS HDMI+HDMI+eDP Supports up to 3 displays simultaneous under OS
Expansion slot	M.2	1 x M.2 Socket with E-key, type 2230 for Wi-Fi/BT device 1 x M.2 Socket with B-key, type 2242 (SATA/PCIe mode)
Storage	eMMC	64 GB / 128 GB
	M.2	1 x M.2 Socket with B-key, type 2242 (SATA/PCIe mode)
Ethernet		1 x Intel® I226-IT, RJ-45 LAN port supports 10/100/1000/2500 Mbps 1 x Intel® I210-IT, RJ-45 LAN port supports 10/100/1000 Mbps
Rear I/O		2 x HDMI ports 2 x USB 10G ports (Type A) 2 x RJ-45 LAN ports 1 x DC-in Power connector (terminal block type) 1 x LED indicator

(continued on the next page)

Internal connectors	1 x Serial connector supports 2 x RS-232/422/485 ports 1 x USB 2.0 connector supports additional 2 USB 2.0 ports 1 x GPIO connector (8-bit) 1 x System panel connector 1 x Display Panel VCC Power Selection jumper 1 x I2C connector
Watchdog Timer (H/W)	Yes
Security	TPM 2.0, TPM on board (optional)
Power Supply	DC input 12-24 V
Operating System	Windows® 10 (64bit) Windows® 10 IoT Enterprise Ubuntu RedHat Enterprise Fedora Workstation OpenSUSE
Environment	Operating Temperature (Standard): 0°C ~ 60°C Operating Temperature (Extended): -40°C ~ 85°C Non-operating Temperature: -40°C ~ 85°C Operating Humidity: 40°C @ 10~95%

NOTE: Specifications are subject to change without notice.



2

Product Introduction

2.1 Before you proceed

Take note of the following precautions before you install motherboard components or change any motherboard settings.

NOTE: The diagrams in this chapter are for reference only. The motherboard layout may vary with models.

IMPORTANT! Components shown in this section may require additional purchase. Refer to **Package contents** section for more information about the contents of your Single Board Computer package.

WARNING!

- Unplug the power cord from the wall socket before touching any component.
 - Before handling components, use a grounded wrist strap or touch a safely grounded object or a metal object, such as the power supply case, to avoid damaging them due to static electricity.
 - Hold components by the edges to avoid touching the ICs on them.
 - Whenever you uninstall any component, place it on a grounded antistatic pad or in the bag that came with the component.
 - Before you install or remove any component, ensure that the ATX power supply is switched off or the power cord is detached from the power supply. Failure to do so may cause severe damage to the motherboard, peripherals, or components.
-

2.2 Motherboard layout

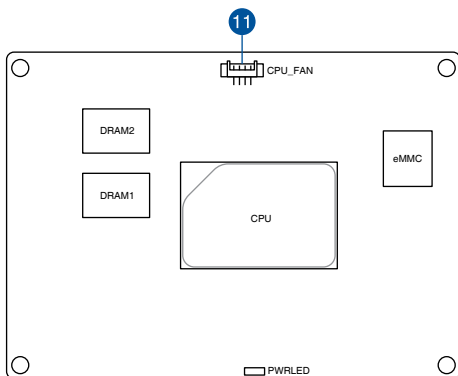
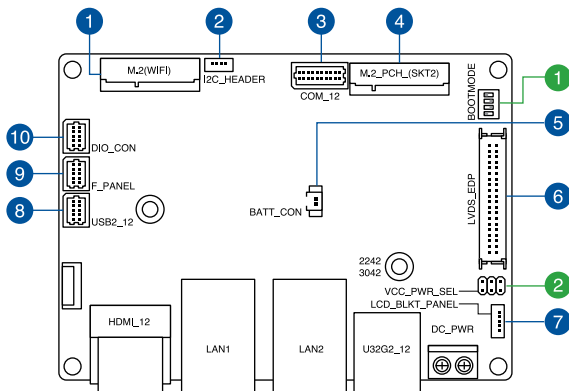

Jumpers/switches		Page
1.	Boot Mode switch	17
2.	Display Panel VCC Power Selection jumper	17

Connectors/slots		Page
1.	M.2 (E-key) slot	18
2.	I2C connector	18
3.	Serial Port connector	19
4.	M.2 (B-key) slot	20
5.	Battery connector	20
6.	LVDS connector	21
7.	Backlight Inverter Power connector	21
8.	USB 2.0 connector	22
9.	Front Panel connector	23
10.	GPIO connector	24
11.	Fan connector	24

2.3 Onboard jumpers & switches

1. Boot Mode switch

The Boot Mode switch allows you to configure between different boot modes. Please refer to the table below for the different boot modes.

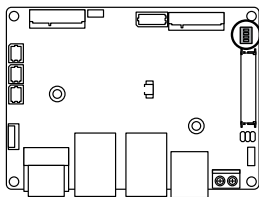

BOOTMODE

BOOTMODE

Clear CMOS setting

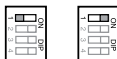

Disabled
(default)



Enabled

Auto power on setting



Disabled
(default)



Enabled

LVDS backlight setting

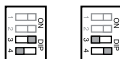

LVDS
backlight high
enabled
(default)



LVDS
backlight low
enabled

2. Display Panel VCC Power Selection jumper (on selected models)

The Display Panel VCC Power jumper allows you to select the voltage for the LVDS panel.

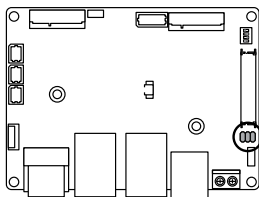

VCC_PWR_SEL

VCC_PWR_SEL



3.3V
(Default)



5V



12V

2.4 Internal connectors

1. M.2 (E-key) slot

The M.2 (E-key) slot allows you to install an E-key, type 2230 M.2 Wi-Fi module.

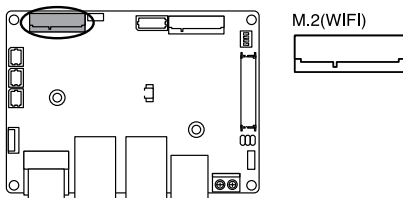

M.2(WIFI)

NOTE: The M.2 Wi-Fi module is purchased separately.

2. I2C connector

The I2C (Inter-Integrated Circuit) connector allows you to connect an I2C-compatible IoT security module.

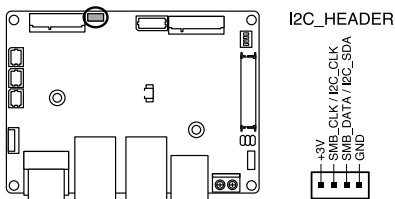

I2C_HEADER

Connector type

Header 1x4p, K6, 1.0mm pitch

3. Serial Port connector

The Serial (COM) Port connector allows you to connect a serial port cable. Connect the serial port cable to this connector, then install the serial port to a slot opening on the system chassis.

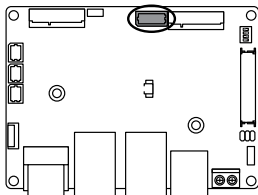

COM_12

COM_12

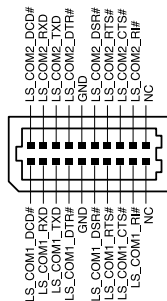

Connector type

BOX header 2x10p, K10, 1.0mm pitch

NOTE:

- The serial port cable is purchased separately.
- **COM1** and **COM2** support RS-232/422/485.

4. M.2 (B-key) slot

The M.2 (B-key) slot allows you to install a B-key (SATA, USB 2.0, and PCIe) type 2242 M.2 device, such as an M.2 SSD module.

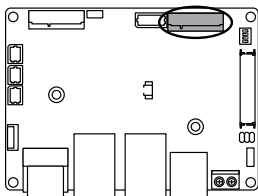

M.2_PCH_(SKT2)

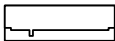

M.2_PCH_(SKT2)

NOTE: The M.2 SSD module is purchased separately.

5. Battery connector

The Battery connector allows you to connect a lithium CMOS battery.

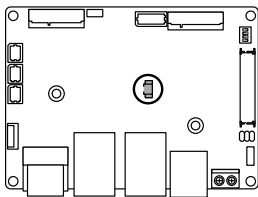

BATT_CON



BATT_CON

6. LVDS connector

The LVDS connector allows you to connect an LCD monitor that supports a Low-voltage Differential Signaling (LVDS) interface.

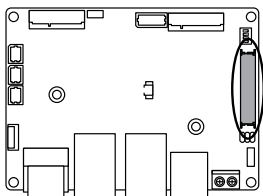

LVDS_EDP

LVDS_EDP

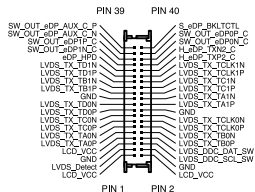

Connector type

WtoB 2x20p, 1.25mm pitch

7. Backlight Inverter Power connector

The Backlight Inverter Power connector allows you to power the backlight inverter on a display panel via a backlight inverter module.

IMPORTANT! The Backlight Inverter Power connector supports a maximum current of 3A.

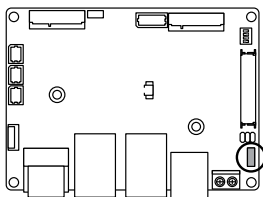

LCD_BKLT_PANEL

LCD_BKLT_PANEL

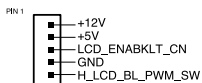

Connector type

Header 1x5p, K6, 1.0mm pitch

8. USB 2.0 connector

The USB 2.0 connector allows you to connect a USB cable for additional USB 2.0 ports. The USB 2.0 connector provides data transfer speeds of up to 480 MB/s connection speed.

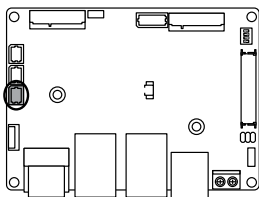

USB2_12

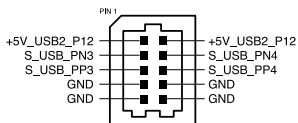

USB2_12

Connector type

BOX header 2x5p, K9, 1.0mm pitch

WARNING! DO NOT connect a 1394 cable to the USB connectors. Doing so will damage the motherboard!

NOTE: The USB 2.0 cable is purchased separately.

9. Front Panel connector

The Front Panel connector supports several chassis-mounted functions.

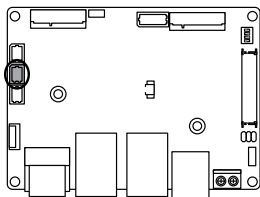

F_PANEL

F_PANEL

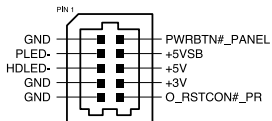

Connector type

BOX header 2x5p, K9, 1.0mm pitch

- **System Power LED connector (PLED)**

The 2-pin connector allow you to connect the System Power LED. System Power LED lights up when the system is connected to a power source or when you turn on the system power, blinks when the system is in S3 state, and turns off when in S4 or S5 state.

- **Power Button/Soft-off Button connector (PWRBTN)**

The 2-pin connector allows you to connect the system power button. Press the power button to power up the system, or put the system into sleep or soft-off mode (depending on the operating system settings).

- **Reset button connector (O_RSTCON)**

The 2-pin connector allows you to connect the chassis-mounted reset button. Press the reset button to reboot the system.

10. GPIO connector

The GPIO connector allows you to connect a general purpose input/output module to customize digital signal input/output.

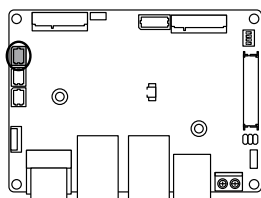

DIO_CON

DIO_CON

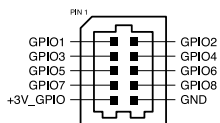

Connector type

BOX header 2x5p, K9, 1.0mm pitch

11. Fan connector

The fan connector allows you to connect a fan to actively cool the system.

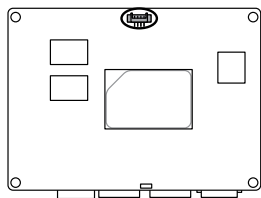

CPU_FAN

CPU_FAN

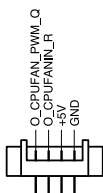

Connector type

WtoB 1x4p, 1.25mm pitch

2.5 I/O connectors

Front panel

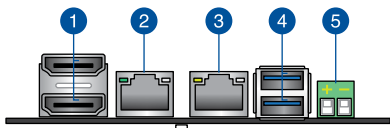

Front panel connectors

1. HDMI ports
2. LAN (RJ-45) 2.5 Gbe port
3. LAN (RJ-45) 1 Gbe port
4. USB 3.2 Gen 2 ports
5. DC-in Power connector (terminal block type)

IMPORTANT! The positive (+) and negative (-) terminals should be clearly marked on the terminal block. If they are not, please contact ASUS customer service.

3

Upgrading your Single Board Computer

IMPORTANT!

- Ensure that your hands are dry before proceeding with the rest of the installation process. Before installing any of the features in this guide, use a grounded wrist strap or touch a safely grounded object or metal object to avoid damaging them due to static electricity.
 - Turn off the power of your Single Board Computer, and allow it to cool for at least 10 minutes before performing any installation/uninstallation process.
-

NOTE: The illustrations in this section are for reference only. The slots may vary depending on model.

3.1 Installing an M.2 SSD

1. Align and insert the M.2 SSD into its slot inside the Single Board Computer.
2. Gently push down the M.2 SSD on top of the standoff, and then fasten it using a screw.

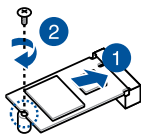
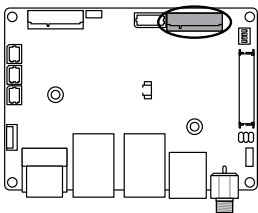

3.2 Installing the wireless card

1. Remove the M.2 stand screw.
2. Align and insert the wireless card into its slot on the motherboard, then gently push down the wireless card on top of the screw hole and fasten it using the previously removed stand screw.
3. (Optional) Connect the antennas to your wireless card.

NOTE:

- Connecting antennas to your wireless card may strengthen the wireless signal.
 - A soft clicking sound indicates that the antenna has been securely attached on the wireless card.
 - The antennas are purchased separately.
-

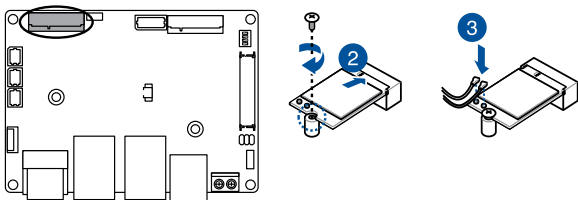

3.3 Installing a heatsink

1. Place the heatsink with its fins faced down on a flat surface.
2. Remove the plastic film on the thermal pads.
3. Orient the motherboard so that the CPU, chipset, and eMMC on its backside are in direct contact with the copper pad on the heatsink, and the four (4) screw holes on the motherboard are aligned to the four (4) standoffs on the heatsink as shown below.
4. Secure the motherboard to the heatsink using the four (4) spring screws bundled with the heatsink in the sequence shown below.

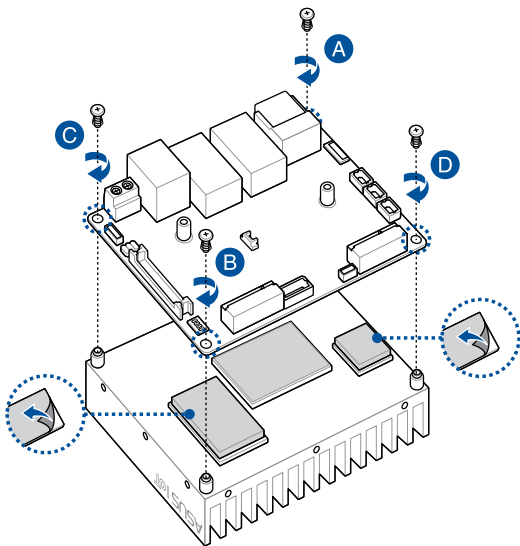

4. (optional) Attach the heatsink and motherboard assembly to your chassis using the M3 mounting holes along the four sides of the heatsink together with the bundled M3 screws.

NOTE: A total of twelve (12) mounting holes are provided for more flexibility in attaching the assembly to your chassis.

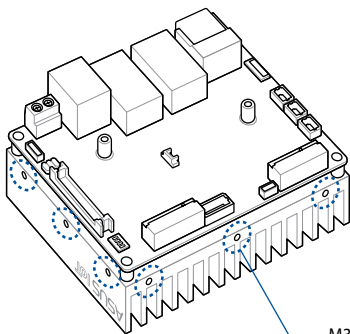

M3 mounting holes

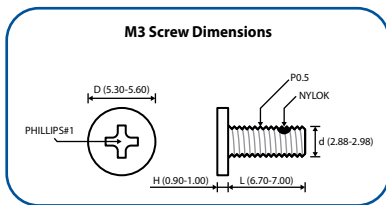

3.4 Installing a heat spreader

1. Place the heat spreader with its copper pad and thermal interface material facing up on a flat surface.
2. Remove the plastic protective film from the copper pad and thermal interface material on the heat spreader, if there is one.

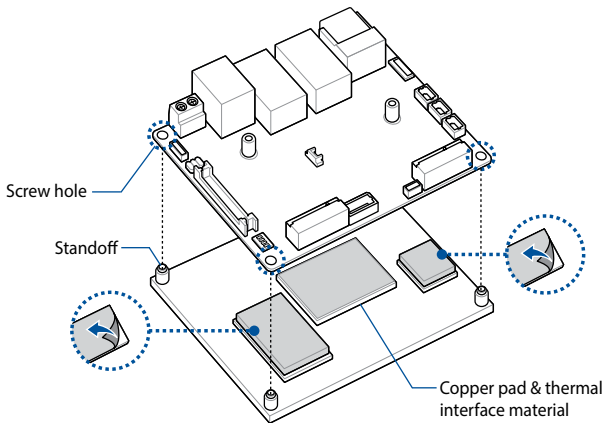

3. Orient the motherboard so that the CPU, chipset, and EMMC on its backside are in direct contact with the copper pad on the heat spreader, and the four (4) screw holes on the motherboard are aligned to the four (4) standoffs on the heat spreader.

4. Secure the motherboard to the heat spreader using the five (5) M2.5 spring screws bundled with the heat spreader in the sequence shown below.

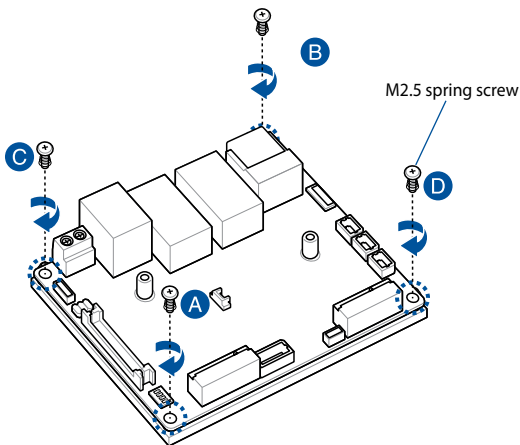

M2.5 Spring Screw Dimensions

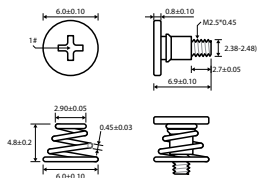

4

BIOS Setup

4.1 Getting to know your BIOS

The BIOS (Basic Input and Output System) stores system hardware settings such as Storage Device Configuration, Advanced Power Management, and Boot Device Configuration that are needed for system startup. Under normal circumstances, the default BIOS settings apply to most conditions to ensure optimal performance. DO NOT change the default BIOS settings except in the following circumstances:

- An error message appears on the screen during the system bootup and requests you to run the BIOS setup.
- You have installed a new system component that requires further BIOS settings or update.

WARNING! Inappropriate BIOS settings may result to instability or boot failure. We strongly recommend that you change the BIOS settings only with the help of a trained service personnel.

4.2 BIOS setup program

Use the BIOS Setup program to update the BIOS or configure its parameters. The BIOS screens include navigation keys and brief online help to guide you in using the BIOS Setup program.

Entering BIOS Setup at startup

To enter BIOS Setup at startup:

- Press <Delete> or <ESC> during the Power-On Self Test (POST). If you do not press <Delete> or <ESC>, POST continues with its routines.

Entering BIOS Setup after POST

To enter BIOS Setup after POST:

- Press <Ctrl>+<Alt>+<Delete> simultaneously.
- Press the power button to turn the system off then back on. Do this option only if you failed to enter BIOS Setup using the first option.

BIOS menu screen

This section provides a brief introduction of the BIOS Interface of your Single Board Computer.

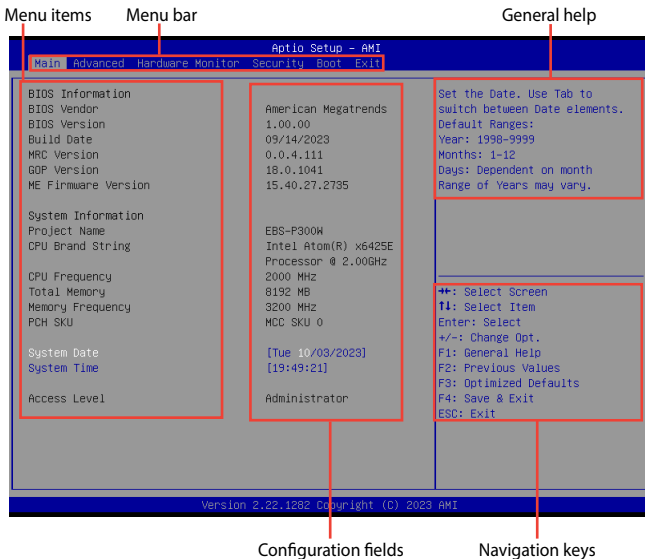

Menu bar

The menu bar on top of the screen has the following main items:

Main	For changing the basic system configuration
Advanced	For changing the advanced system settings
Hardware Monitor	For viewing system temperature/power status and changing the fan mode
Security	For changing the security settings
Boot	For changing the system boot configuration
Exit	For selecting the save and exit options or loading default settings

4.3 Main Menu

When you enter the BIOS Setup program, the Main menu screen appears. The Main menu provides you an overview of the basic system information, and allows you to set the system date and time. Scroll down to display the other BIOS items.



4.3.1 System Date [Day xx/xx/xxxx]

Allows you to set the system date.

4.3.2 System Time [xx:xx:xx]

Allows you to set the system time.

4.4 Advanced menu

The Advanced menu items allow you to change the settings for the CPU and other system devices.

WARNING! Be cautious when changing the settings of the Advanced menu items. Incorrect field values can cause the system to malfunction.

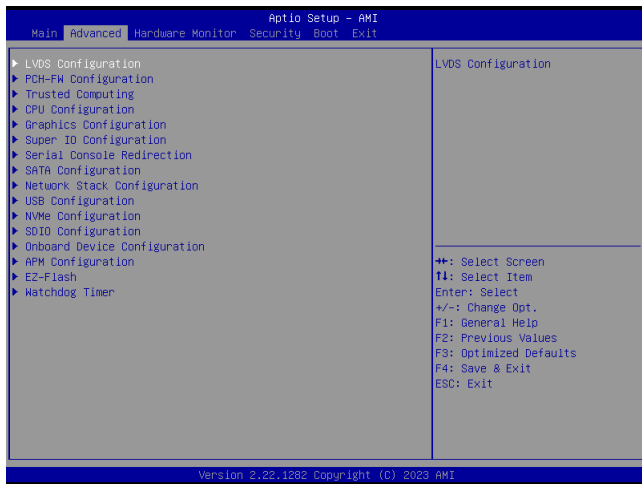

4.4.1 LVDS Configuration

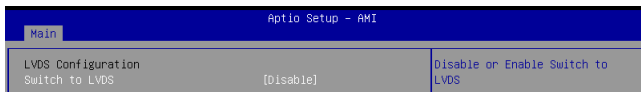

Switch to LVDS

Allows you to enable or disable Switch to LVDS.

Configuration options: [Disable] [Enable]

NOTE: The following items appear only when you set **Switch to LVDS** to **[Enabled]**.

All-in-One Chassis

Allows you to select All-in-One (AiO) chassis (if applicable) for simplified AiO configuration.

Configuration options: [None] [1920*1080 LVDS1] [1920*1080 LVDS2]
[1920*1080 LVDS3] [1600*900 LVDS4]

NOTE: Be cautious when selecting AiO chassis. Incorrect selection of AiO chassis can cause incorrect operation or potential damage to AiO chassis hardware.

Min Backlight

Allows you to set the minimum backlight brightness for the LVDS panel.

Configuration options: [10] [20] [30] [40] [50]

Max Backlight

Allows you to set the maximum brightness for the LVDS panel.

Configuration options: [60] [70] [80] [90] [100]

NOTE: The following items appear only when you set **All-in-One Chassis** to **[None]**.

EDID Data Source

Configuration options: [Pre-defined] [Flat Panel Display]

NOTE: The following item appears when you set **EDID Data Source** to **[Pre-defined]**.

LFP Panel Type

Allows you to select LFP panel used by Internal Graphics Device.

Configuration options: [VBIOS Default] [640x480] [800x600] [1024x768] [1280x1024] [1400x1050 LVDS1] [1400x1050 LVDS2] [1600x1200] [1366x768] [1680x1050] [1920x1200] [1440x900] [1600x900] [1024x768] [1280x800] [1920x1080] [2048x1536]

Inverter Polarity

Allows you to set the inverter board polarity.

Configuration options: [Inverted] [Normal]

NOTE:

- Normal: PWM = 0% (Dim)
Inverted: PWM = 0% (Bright)
 - Consult inverter board specifications for proper value.
-

Channel Select

Configuration options: [Dual Channel] [Single Channel]

Mode Select

Configuration options: [JEIDA] [VESA 6bit] [VESA 8bit] [VESA 10bit]

DIGON enable to LVDS_ON enable (T2)

Use the <+> or <-> to adjust the value. The values range from 0 to 50.

LVDS_ON enable to BLON enable (T3)

Use the <+> or <-> to adjust the value. The values range from 0 to 1023.

BLON disable to LVDS_ON disable (T4)

Use the <+> or <-> to adjust the value. The values range from 0 to 1023.

LVDS_ON disable to DIGON disable (T5)

Use the <+> or <-> to adjust the value. The values range from 0 to 50.

Completion of power down to power up (T7)

Use the <+> or <-> to adjust the value. The values range from 0 to 1023.

VARY_BL enable to BL_EN enable (T9)

Use the <+> or <-> to adjust the value. The values range from 0 to 1023.

BL_EN enable to enable VARY_BL disable (T10)

Use the <+> or <-> to adjust the value. The values range from 0 to 1023.

4.4.2 PCH-FW Configuration

The items in this menu allow you to configure Management Engine Technology Parameters.

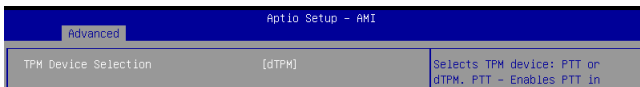

TPM Device Selection

This item allows you to select the TPM device.

[dTPM] Discrete TPM

[PTT] Intel Platform Trust Technology firmware TPM

NOTE:

- When **[dTPM]** is selected, PTT (firmware TPM) will be disabled, and the TPM device connected to the SPI TPM connector on the motherboard will be enabled. If no TPM device is connected, the TPM feature will be disabled.
- When **[PTT]** is selected, PTT (firmware TPM) is enabled.

WARNING! When **[dTPM]** is selected, PTT (firmware TPM) will be disabled and all data saved on it will be lost.

4.4.3 Trusted Computing

Aptio Setup - AMI		
Advanced		
TPM 2.0 Device Found		Enables or Disables BIOS support for security device. O.S. will not show Security Device. TCG EFI protocol and INT1A interface will not be available.
Firmware Version:	15.21	
Vendor:	IFX	
Security Device Support	[Enable]	
Active PCR banks	SHA256	
Available PCR banks	SHA256,SHA384	
SHA256 PCR Bank	[Enabled]	
SHA384 PCR Bank	[Disabled]	
Pending operation	[None]	
Platform Hierarchy	[Enabled]	
Storage Hierarchy	[Enabled]	
Endorsement Hierarchy	[Enabled]	
Physical Presence Spec Version	[1,3]	
		←+: Select Screen ↑↓: Select Item Enter: Select /+: Change Opt

NOTE: Changes here do not take effect until computer is restarted.

Security Device Support

Allows you to enable or disable the BIOS support for security device.

Configuration options: [Disable] [Enable]

NOTE: The following items appear only when **Security Device Support** is set to **[Enabled]**.

SHA256 PCR Bank

Allows you to enable or disable SHA256 PCR Bank.

Configuration options: [Disable] [Enable]

SHA384 PCR Bank

Allows you to enable or disable SHA384 PCR Bank.

Configuration options: [Disable] [Enable]

Pending operation

Allows you to schedule an operation for the Security Device.

Configuration options: [None] [TPM Clear]

NOTE: Your computer will reboot during restart in order to change the state of Security Device.

Platform Hierarchy

Allows you enable or disable the Platform Hierarchy.

Configuration options: [Disabled] [Enabled]

Storage Hierarchy

Allows you enable or disable the Storage Hierarchy.

Configuration options: [Disabled] [Enabled]

Endorsement Hierarchy

Allows you enable or disable the Endorsement Hierarchy.

Configuration options: [Disabled] [Enabled]

TPM2.0 UEFI Spec Version

Allows you to select the TCG2 spec version support.

[TCG_1_2] Compatible mode for Windows 8® / Windows® 10.

[TCG_2] Supports new TCG2 protocol and event format for Windows® 10 or later.

Physical Presence Spec Version

Select to tell the OS to support PPI Spec Version 1.2 or 1.3.

Configuration options: [1.2] [1.3]

NOTE: Some HCK tests might not support version 1.3.

4.4.4 CPU Configuration

The items in this menu show the CPU-related information that the BIOS automatically detects. Scroll down to display other BIOS items.

Advanced		Aptio Setup - AMI	
CPU Configuration		When enabled, a VMM can utilize the additional hardware capabilities provided by Vanderpool Technology.	
Type	Intel Atom(R) x6425E Processor @ 2.00GHz		
ID	0x90661		
L1 Data Cache	32 KB x 4		
L1 Instruction Cache	32 KB x 4		
L2 Cache	1536 KB x 4		
L3 Cache	4 MB		
VMX	Supported		
SMX/TXT	Not Supported		
Intel (VMX) Virtualization Technology	[Enabled]	+/: Select Screen	
VT-d	[Enabled]	F1: Select Item	
▶ CPU - Power Management Control		Enter: Select	
		+/-: Change Opt.	
		F1: Power Mgmt	

Intel (VMX) Virtualization Technology

When set to **[Enabled]**, a VMM can utilize the additional hardware capabilities provided by Vanderpool Technology.

Configuration options: [Disabled] [Enabled]

VT-d

Allows you to enable or disable VT-d capability.

Configuration options: [Disabled] [Enabled]

CPU - Power Management Control

Intel(R) SpeedStep(tm)

Allows more than two frequency to be supported.

Configuration options: [Disabled] [Enabled]

Intel(R) Speed Shift Technology

Allows you to enable or disable Intel(R) Speed Shift Technology support. When enabled, CPPC v2 interface allows hardware controlled P-states.

Configuration options: [Disabled] [Enabled]

Turbo Mode

Allows you to enable or disable processor Turbo Mode (requires Intel Speed Step or Intel Speed Shift to be available when enabled).

Configuration options: [Disabled] [Enabled]

C states

Allows you to enable or disable CPU Power Management. Allows CPU to go to C states when it's not 100% utilized.

Configuration options: [Disabled] [Enabled]

NOTE: The following item appears only when **C states** is set to **[Enabled]**.

Enhanced C-States

Allows you to enable or disable C1E. When enabled, CPU will switch to minimum speed when all cores enter C-State.

Configuration options: [Disabled] [Enabled]

Power Limit 1 Override

Allows you to enable or disable Power Limit 1 override. If this option is disabled, BIOS will program the default values for Power Limit 1 and Power Limit 1 Time Window.

Power Limit 2 Override

Allows you to enable or disable Power Limit 2 override. If this option is disabled, BIOS will program the default values for Power Limit 2.

Power Limit 2

Allows you to configure Power Limit 2 value in milliwatts (e.g., enter 12500 for 12.5 W).

4.4.5 Graphics Configuration

The items in this menu allow you to configure settings related to graphics.

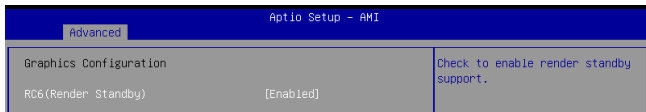

RC6(Render Standby)

Allows you to enable or disable render standby support.

Configuration options: [Disabled] [Enabled]

4.4.6 Super IO Configuration

The items in this menu allow you to configure system super IO chip parameters.

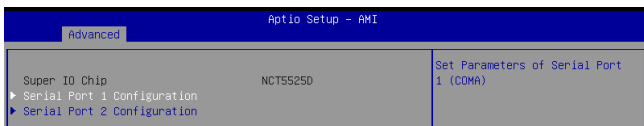

Super IO Chip

Serial Port 1-2 Configuration

Allows you to set the parameters of Serial Port 1-2.

Serial Port

Allows you to enable or disable Serial Port.

Configuration options: [Disabled] [Enabled]

NOTE: The following items appear only when **Serial Port** is set to **[Enabled]**.

COM1-2 Control

Configuration options: [RS232] [RS422] [RS485]

4.4.7 Serial Console Redirection

The items in this menu allow you to configure serial console redirection parameters.

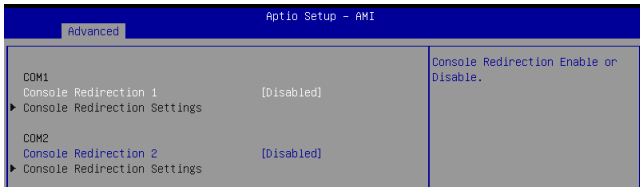

COM1-2

Console Redirection

Allows you to enable or disable the console redirection feature.

Configuration options: [Disabled] [Enabled]

NOTE: The following item appears only when **Console Redirection** is set to **[Enabled]**.

Console Redirection Settings

This item becomes configurable only when you enable the **Console Redirection** item. The settings specify how the host computer and the remote computer (which the user is using) will exchange data. Both computers should have the same or compatible settings.

Terminal Type

Allows you to set the terminal type.

[VT100] ASCII char set.

[VT100+] Extends VT100 to support color, function keys, etc.

[VT-UTF8] Uses UTF8 encoding to map Unicode chars onto 1 or more bytes.

[ANSI] Extended ASCII char set.

Bits per second

Selects serial port transmission speed. The speed must be matched on the other side. Long or noisy lines may require lower speeds.

Configuration options: [9600] [19200] [38400] [57600] [115200]

Data Bits

Configuration options: [7] [8]

Parity

A parity bit can be sent with the data bits to detect some transmission errors. **[Mark]** and **[Space]** parity do not allow for error detection.

[None] None.

[Even] parity bit is 0 if the num of 1's in the data bits is even.

[Odd] parity bit is 0 if num of 1's in the data bits is odd.

[Mark] parity bit is always 1.

[Space] parity bit is always 0.

Stop Bits

Stop bits indicate the end of a serial data packet. (A start bit indicates the beginning.) The standard setting is 1 stop bit. Communication with slow devices may require more than 1 stop bit.

Configuration options: [1] [2]

Flow Control

Flow control can prevent data loss from buffer overflow. When sending data, if the receiving buffers are full, a “stop” signal can be sent to stop the data flow. Once the buffers are empty, a “start” signal can be sent to re-start the flow. Hardware flow control uses two wires to send start/stop signals.

Configuration options: [None] [Hardware RTS/CTS]

VT-UTF8 Combo Key Support

Allows you to enable the VT-UTF8 Combo Key Support for ANSI/VT100 terminals.

Configuration options: [Disabled] [Enabled]

Recorder Mode

With this mode enabled only text will be sent. This is to capture Terminal data.

Configuration options: [Disabled] [Enabled]

Resolution 100x31

Allows you to enable or disable extended terminal resolution.

Configuration options: [Disabled] [Enabled]

Putty KeyPad

Allows you to select the FunctionKey and Keypad on Putty.

Configuration options: [VT100] [LINUX] [XTERM6] [SCO] [ESCN] [VT400]

4.4.8 SATA Configuration

The items in this menu allow you to configure SATA device options.

While entering Setup, the BIOS automatically detects the presence of SATA devices. The SATA Port items show **[Empty]** if no SATA device is installed to the corresponding SATA port.

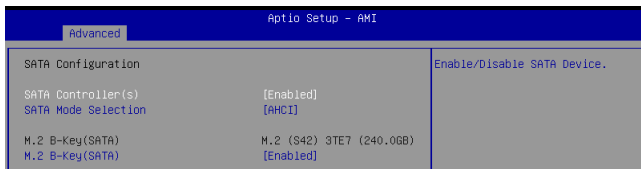

SATA Controller(s)

Allows you to enable or disable the SATA Controller.

Configuration options: [Enabled] [Disabled]

NOTE: The following items appear only when **SATA Controller(s)** is set to **[Enabled]**.

SATA Mode Selection

Allows you to determine how SATA controller(s) operate.

Configuration options: [AHCI]

M.2 B-Key(SATA)

Allows you to enable or disable the SATA port.

Configuration options: [Disabled] [Enabled]

4.4.9 Network Stack Configuration

Allows you to configure network stack settings.

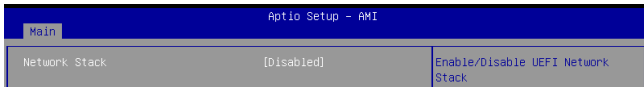

Network Stack

Allows you to enable or disable UEFI Network Stack.

Configuration options: [Disabled] [Enabled]

NOTE: The following items appear only when **Network Stack** is set to **[Enabled]**.

IPv4 PXE Support

Enables or disables the IPv4 PXE Boot Support. If disabled, IPv4 PXE boot option will not be created.

Configuration options: [Disabled] [Enabled]

IPv6 PXE Support

Enables or disables the IPv6 PXE Boot Support. If disabled, IPv6 PXE boot option will not be created.

Configuration options: [Disabled] [Enabled]

4.4.10 USB Configuration

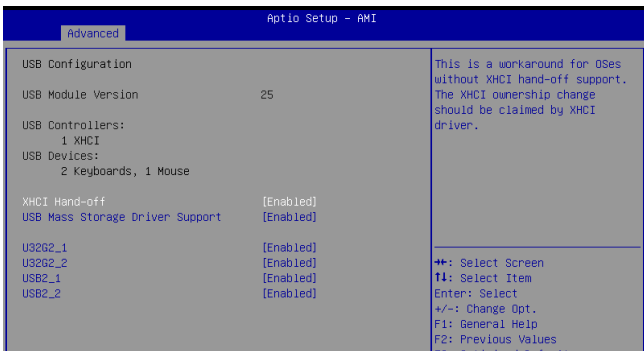

NOTE: The **USB Devices** item shows the auto-detected values. If no USB device is detected, the item shows **None**.

XHCI Hand-off

Allows you to enable or disable workaround for Oses without XHCI hand-off support. The XHCI ownership change should be claimed by XHCI driver.

Configuration options: [Disabled] [Enabled]

NOTE: This item is set to **[Disabled]** by default for the EHCI (enhanced host controller interface) support by XHCI drivers in operating systems.

USB Mass Storage Driver Support

Allows you to enable or disable the USB Mass Storage driver support.

Configuration options: [Disabled] [Enabled]

USB32G2_1-2

Allows you to enable or disable each USB port. When set to [Disabled], any USB devices plugged into the connector will not be detected by the BIOS or OS.

Configuration options: [Disabled] [Enabled]

USB2_1-2

Allows you to enable or disable each USB port. When set to [Disabled], any USB devices plugged into the connector will not be detected by the BIOS or OS.

Configuration options: [Disabled] [Enabled]

4.4.11 NVMe Configuration

This menu displays the controller and drive information for NVMe devices connected and allows you to configure NVMe device options.

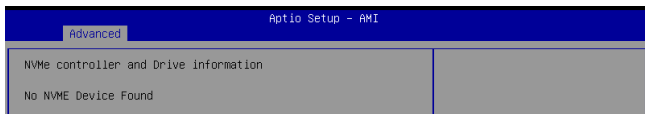

4.4.12 SDIO Configuration

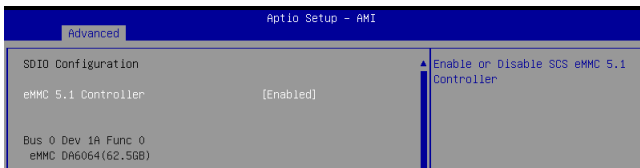

eMMC 5.1 Controller

Allows you to enable to disable the SCS eMMC 5.1 controller.

Configuration options: [Disabled] [Enabled]

4.4.13 Onboard Devices Configuration

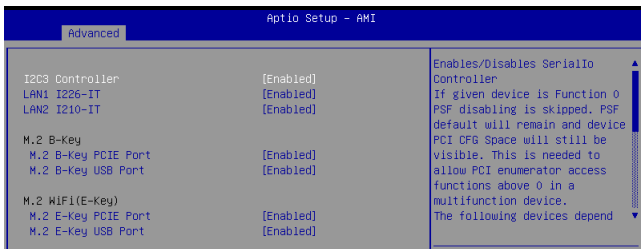

I2C3 Controller

Allows you to enable or disable I2C controller support.

Configuration options: [Disabled] [Enabled]

LAN1 I226-IT

Allows you to enable or disable LAN1.

Configuration options: [Enabled] [Disabled]

LAN2 I210-IT

Allows you to enable or disable LAN 2.

Configuration options: [Disabled] [Enabled]

M.2 B-Key

M.2 B-Key PCIE Port

Allows you to enable or disable the M.2 B-Key (PCIe) controller.

Configuration options: [Disabled] [Enabled]

M.2 B-Key USB Port

Allows you to enable or disable the M.2 B-Key (USB) controller.

Configuration options: [Disabled] [Enabled]

M.2 WiFi(E-Key)

M.2 E-Key PCIE Port

Allows you to enable or disable the M.2 WiFi (E-Key) PCIe controller.
Configuration options: [Disabled] [Enabled]

M.2 E-Key USB Port

Allows you to enable or disable the M.2 WiFi (E-Key) USB controller.
Configuration options: [Disabled] [Enabled]

4.4.14 APM Configuration

Allows you to configure the Advance Power Management (APM) settings.

Advanced		ApMio Setup - AMI
APM Configuration		Allow BIOS to switch off some power
ErP Ready	[Disabled]	at S4/S5 to get the system ready for ErP requirement. When set to Enabled, all other PME options will be switched
Restore AC Power Loss	[S5 State]	
Power On By PCIE	[Disabled]	
Power On By Ring	[Disabled]	
Power On By RTC	[Disabled]	

ErP Ready

Allows the BIOS to switch off some power at S4/S5 to get the system ready for ErP requirement.

Configuration options: [Disabled] [Enabled]

NOTE: When set to **[Enabled]**, all other PME options will be switched off.

Restore AC Power Loss

[S5] The system goes into OFF state after an AC power loss.

[S0] The system goes into ON state after an AC power loss.

Power On By PCIE

Allows you to enable or disable the wake-on-LAN function for the onboard LAN controller or other installed PCIe/PCI LAN cards.

Configuration options: [Disabled] [Enabled]

Power On By Ring

Allows the computer to be powered on or awakened from a low-power state in response to ring events, such as network activity.

Configuration options: [Disabled] [Enabled]

Power On By RTC

Allows you to disable the real-time clock (RTC) or enable it to schedule a wake event.

Configuration options: [Disabled] [Single event] [Daily event] [Weekly event] [Monthly event]

4.4.15 EZ-Flash

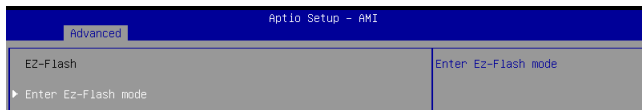

Enter Ez-Flash mode

Allows you to enter Ez-Flash mode to run the ASUS Ez-Flash BIOS ROM utility.

WARNING! Make sure to back up your Bitlocker recovery key and suspend Bitlocker encryption in the operating system before updating your BIOS.

4.4.16 Watchdog Timer

The items in this menu allow you to configure settings related to Watchdog Timer.

Advanced		Aptio Setup - AMI	
Watchdog Timer		Enable/Disable Watchdog Support	
Watchdog Support	[Enabled]		
Watchdog Count mode	[Second Mode]		
Watchdog Timer	120		

Watchdog Support

Allows you to enable or disable Watchdog Support.

Configuration options: [Disabled] [Enabled]

NOTE: The following items appear only when **Watchdog Support** is set to **[Enabled]**.

Watchdog Count Mode

Allows you to select the Watchdog Timer count mode.

Configuration options: [Second Mode] [Minute Mode]

Watchdog Timer

Allows you to input the Watchdog time-out interval.

4.5 Hardware Monitor menu

The Hardware Monitor menu displays the system temperature/power status, and allows you to change the fan mode.

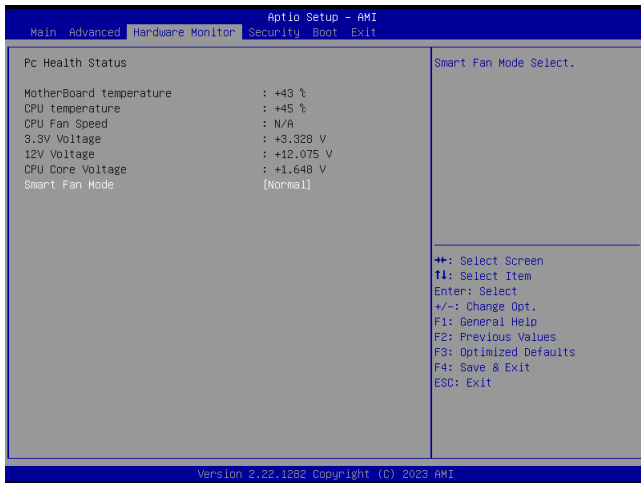

Smart Fan Mode

Allows you to select a smart fan mode.

Configuration options: [Disabled] [Normal] [Manual Mode]

4.6 Security menu

This menu allows a new password to be created or a current password to be changed. The menu also enables or disables the Secure Boot state and lets the user configure the System Mode state.

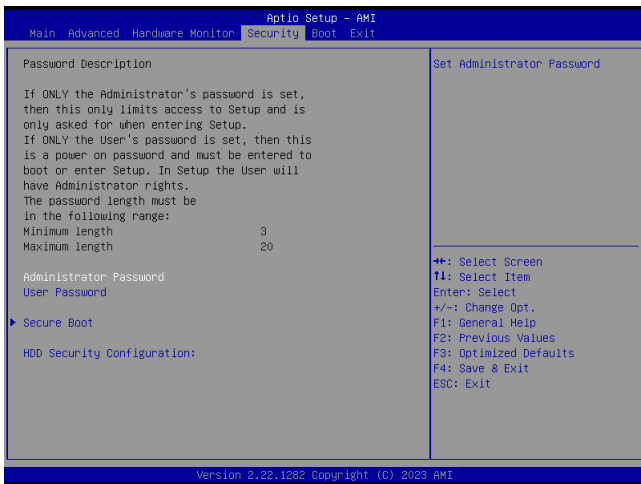

Administrator Password

To set an administrator password:

1. Select the Administrator Password item and press <Enter>.
2. From the Create New Password box, key in a password, then press <Enter>.
3. Confirm the password when prompted.

To change an administrator password:

1. Select the Administrator Password item and press <Enter>.
2. From the Enter Current Password box, key in the current password, then press <Enter>.

3. From the Create New Password box, key in a new password, then press <Enter>.
4. Confirm the password when prompted. **NOTE:** To clear the administrator password, follow the same steps as in changing an administrator password, but press <Enter> when prompted to create/confirm the password.

User Password

To set a user password:

1. Select the User Password item and press <Enter>.
2. From the Create New Password box, key in a password, then press <Enter>.
3. Confirm the password when prompted.

To change a user password:

1. Select the User Password item and press <Enter>.
2. From the Enter Current Password box, key in the current password, then press <Enter>.
3. From the Create New Password box, key in a new password, then press <Enter>.
4. Confirm the password when prompted.

To clear a user password:

1. Follow the same steps as in changing a user password, but press <Enter> when prompted to create a new password.
2. Select Yes from the Warning message window, then press <Enter>.

Secure Boot

Secure Boot can be enabled if the system is running in User mode with enrolled platform Key (EPK) or if the CSM function is disabled.

Configuration options: [Disabled] [Enabled]

Secure Boot Mode

In Custom Mode, the secure boot policy variables can be configured by a physically present user without full authentication.

Configuration options: [Standard] [Custom]

Key Management

The Key Management item allows you to modify Secure Boot variables and set Key Management page.

Platform Key (PK)

Configuration options: [Details] [Export] [Update] [Delete]

Key Exchange Keys / Authorized Signatures / Forbidden Signatures

Configuration options: [Details] [Export] [Update] [Append] [Delete]

HDD Security Configuration

The HDD Security Configuration item allows you to set up passwords to protect your HDD.

NOTE: This item is only available when you have a SATA HDD connected.

To set a password for your HDD:

1. Select the HDD Security Configuration item and press <Enter>.
2. Select the Set Master Password item and press <Enter>.
3. From the Create New Password box, key in a password, then press <Enter>.
4. Confirm the password when prompted.
5. Select the User Password item and press <Enter>.
6. From the Create New Password box, key in a password, then press <Enter>.
7. Confirm the password when prompted.

To change the password for your HDD:

1. Select the HDD Security Configuration item and press <Enter>.
2. Select the Set User Password item and press <Enter>.
3. From the Enter Current Password box, key in a password, then press <Enter>.
4. From the Create New Password box, key in a password, then press <Enter>.
5. Confirm the password when prompted.

NOTE: To clear the user password, follow the same steps as in changing a user password, but press <Enter> when prompted to create/confirm the password.

4.7 Boot menu

The Boot menu items allow you to change the system boot options.

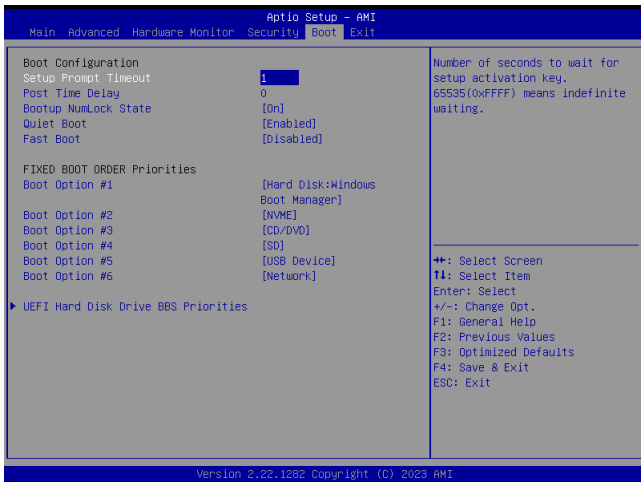

Boot Configuration

Setup Prompt Timeout

Allows you to set the number of seconds that the firmware waits before initiating the original default boot selection. 65535(0xFFFF) means indefinite waiting. Use <+> or <-> to adjust the value.

Bootup NumLock State

Allows you to select the power-on state for the NumLock.
Configuration options: [On] [Off]

Quiet Boot

Allows you to enable or disable the Quiet Boot option.

Configuration options: [Disabled] [Enabled]

Fast Boot

[Disabled] Allows your system to go back to its normal boot speed.

[Enabled] Allows your system to accelerate the boot speed.

FIXED BOOT ORDER Priorities

These items specify the boot device priority sequence from the available devices. The number of device items that appears on the screen depends on the number of devices installed in the system.

NOTE:

- To access Windows® OS in Safe Mode, press <F8> after POST (Windows® 8 not supported).
 - To select the boot device during system startup, press <F8> when the ASUS Logo appears.
-

UEFI Hard Disk Drive BBS Priorities

Allows you to specify the Boot Device Priority sequence from available UEFI Hard Disk Drives.

Boot Option #1

Allows you to set the system boot order.

Configuration options: [Windows Boot Manager] [Disabled]

4.8 Exit menu

The Save & Exit menu items allow you to save or discard your changes to the BIOS items.

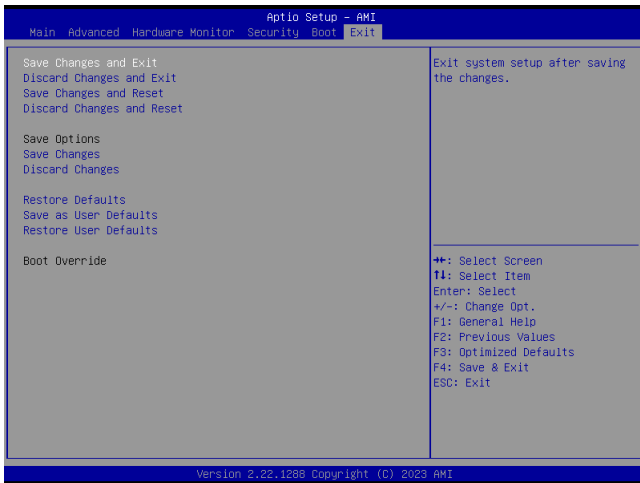

NOTE: Pressing <Esc> does not immediately exit this menu. Select one of the options from this menu or <F10> from the legend bar to exit.

Save Changes and Exit

Exit system setup after saving changes.

Discard Changes and Exit

Exit system setup without saving changes.

Save Changes and Reset

Exit system setup after saving changes.

Discard Changes and Reset

Reset the system without saving any changes.

Save Option

Save Changes

Save changes done so far to any of the setup options.

Discard Changes

Discard changes done so far to any of the setup options.

Restore Defaults

Restore/load default values for all the setup options.

Save as User Defaults

Save the changes done so far as User Defaults.

Restore User Defaults

Restore/load default values for all the setup options.

Boot Override

Windows Boot Manager

Use to override the Fixed Boot Order with the boot environment set up through Windows Boot Manager.

4.9 Updating your BIOS

The following utilities allow you to manage and update the motherboard Basic Input/Output System (BIOS) setup:

1. **ASUS CrashFree BIOS**

To recover the BIOS using a bootable USB flash disk drive when the BIOS file fails or is corrupt.

2. **ASUS EzFlash**

Updates the BIOS using a USB flash disk.

Refer to the corresponding sections for details on these utilities.

4.9.1 **ASUS CrashFree BIOS utility**

The ASUS CrashFree BIOS is an auto recovery tool that allows you to restore the BIOS file when it fails or gets corrupted during the updating process. You can update a corrupted BIOS file using a USB flash drive that contains the updated BIOS file.

IMPORTANT! Prepare a USB flash drive containing the updated motherboard BIOS before using this utility.

Recovering the BIOS from a USB flash drive

To recover the BIOS from a USB flash drive:

1. Insert the USB flash drive with the original or updated BIOS file to one of the USB ports on the system.
2. The utility will automatically recover the BIOS. It resets the system when the BIOS recovery finished.

WARNING! DO NOT shut down or reset the system while recovering the BIOS! Doing so will cause system boot failure!

NOTE: The recovered BIOS may not be the latest BIOS version for this motherboard. Visit the ASUS website at www.asus.com to download the latest BIOS file.

4.9.2 ASUS EZ-Flash Utility

The ASUS EZ-Flash Utility feature allows you to update the BIOS using a USB flash disk without having to use a DOS-based utility.

IMPORTANT! Download the latest BIOS from the ASUS website at www.asus.com before using this utility.

NOTE: The succeeding BIOS screens are for reference only. The actual BIOS screen displayed may not be the same as shown.

To update the BIOS using EzFlash Utility:

1. Insert the USB flash disk that contains the latest BIOS file to a USB port.
2. Enter the BIOS setup program. Go to the **Advanced** menu > **EZ-Flash** > **Enter Ez-Flash mode**. Select Yes and then OK to auto reboot and enter EZ-Flash mode.

WARNING! Make sure to back up your Bitlocker recovery key and suspend Bitlocker encryption in the operating system before updating your BIOS.

3. Use the Up/Down arrow keys to find the USB flash disk that contains the latest BIOS, and then press <Enter>.
4. Use the Up/Down arrow keys to find the BIOS file then press <Enter>.



5. Reboot the system when the update process is done.

WARNING!

- This function can support devices, such as a USB flash disk with FAT 32/16 format and single partition only.
 - DO NOT shut down or reset the system while updating the BIOS to prevent system boot failure!
-

IMPORTANT! Make sure to load the BIOS default settings to ensure system compatibility and stability. Press <F3> and select Yes to load the BIOS default settings.

Appendix

Safety information

Your Single Board Computer is designed and tested to meet the latest standards of safety for information technology equipment. However, to ensure your safety, it is important that you read the following safety instructions.

Setting up your system

- Read and follow all instructions in the documentation before you operate your system.
- Do not use this product near water or a heated source.
- Set up the system on a stable surface.
- Peripherals with extended temperature tolerance (such as industrial grade DRAM, SSD, etc.) will allow this product to be used in environments with ambient temperatures between -20°C and 60°C , with a 0.1m/s air flow.
- The product should be used in environments with ambient temperatures between -40°C and 60°C when using the 90 W power adapter.
- If you use an extension cord, make sure that the total ampere rating of the devices plugged into the extension cord does not exceed its ampere rating.
- This equipment should be installed and operated with a minimum distance of 20 cm between the radiator and your body.
- This device shall not be connected to an Ethernet network with outside plant routing.

Care during use

- Do not walk on the power cord or allow anything to rest on it.
- Do not spill water or any other liquids on your system.
- When the system is turned off, a small amount of electrical current still flows. Always unplug the power cord from the power outlets before cleaning the system.
- If you encounter the following technical problems with the product, unplug the power cord and contact a qualified service technician or your retailer.
 - The power cord or plug is damaged.
 - Liquid has been spilled into the system.
 - The system does not function properly even if you follow the operating instructions.
 - The system was dropped or the cabinet is damaged.
 - The system performance changes.

Lithium-Ion Battery Warning

CAUTION: Danger of explosion if battery is incorrectly replaced. Replace only with the same or equivalent type recommended by the manufacturer. Dispose of used batteries according to the manufacturer's instructions.

NO DISASSEMBLY

The warranty does not apply to the products that have been disassembled by users



DO NOT throw the Single Board Computer in municipal waste. This product has been designed to enable proper reuse of parts and recycling. This symbol of the crossed out wheeled bin indicates that the product (electrical, electronic equipment, and mercury-containing button cell battery) should not be placed in municipal waste. Check local technical support services for product recycling.

Safety precautions

Accessories that came with this product have been designed and verified for the use in connection with this product. Never use accessories for other products to prevent the risk of electric shock or fire.

Regulatory notices

REACH

Complying with the REACH (Registration, Evaluation, Authorization, and Restriction of Chemicals) regulatory framework, we publish the chemical substances in our products at ASUS REACH website at <https://csr.asus.com/english/REACH.htm>

ASUS Recycling/Takeback Services

ASUS recycling and takeback programs come from our commitment to the highest standards for protecting our environment. We believe in providing solutions for you to be able to responsibly recycle our products, batteries, other components, as well as the packaging materials. Please go to <https://csr.asus.com/english/Takeback.htm> for the detailed recycling information in different regions.

COATING NOTICE

IMPORTANT! To provide electrical insulation and maintain electrical safety, a coating is applied to insulate the device except on the areas where the I/O ports are located.

FCC RF Exposure Information

This device meets the government's requirements for exposure to radio waves. This device is designed and manufactured not to exceed the emission limits for exposure to radio frequency (RF) energy set by the Federal Communications Commission of the U.S. Government. The exposure standard employs a unit of measurement known as the Specific Absorption Rate, or SAR. The SAR limit set by the FCC is 1.6 W/kg. Tests for SAR are conducted using standard operating positions accepted by the FCC with the EUT transmitting at the specified power level in different channels. The FCC has granted an Equipment Authorization for this device with all reported SAR levels evaluated as in compliance with the FCC RF exposure guidelines. SAR information on this device is on file with the FCC and can be found under the Display Grant section of www.fcc.gov/oet/ea/fccid.

Federal Communications Commission Statement

This device complies with Part 15 of the FCC Rules. Operation is subject to the following two conditions:

- This device may not cause harmful interference, and
- This device must accept any interference received including interference that may cause undesired operation.

This equipment has been tested and found to comply with the limits for a Class A digital device, pursuant to part 15 of the FCC Rules. These limits are designed to provide reasonable protection against harmful interference when the equipment is operated in a commercial environment.

This equipment generates, uses, and can radiate radio frequency energy and, if not installed and used in accordance with the instruction manual, may cause harmful interference to radio communications. Operation of this equipment in a residential area is likely to cause harmful interference in which case the user will be required to correct the interference at his own expense.

IMPORTANT! Outdoor operations in the 5.15~5.25 GHz band is prohibited. This device has no Ad-hoc capability for 5250~5350 and 5470~5725 MHz.

CAUTION! Any changes or modifications not expressly approved by the party responsible for compliance could void the user's authority to operate the equipment.

ISED Radiation Exposure Statement for Canada

This equipment complies with ISED radiation exposure limits set forth for an uncontrolled environment. To maintain compliance with ISED RF exposure compliance requirements, please avoid direct contact to the transmitting antenna during transmitting. End users must follow the specific operating instructions for satisfying RF exposure compliance.

Operation is subject to the following two conditions:

- This device may not cause interference and
- This device must accept any interference, including interference that may cause undesired operation of the device.

Compliance Statement of Innovation, Science and Economic Development Canada (ISED)

This device complies with Innovation, Science and Economic Development Canada licence exempt RSS standard(s). Operation is subject to the following two conditions: (1) this device may not cause interference, and (2) this device must accept any interference, including interference that may cause undesired operation of the device.

CAN ICES-003(A)/NMB-003(A)

Déclaration de conformité de Innovation, Sciences et Développement économique Canada (ISED)

Le présent appareil est conforme aux CNR d'Innovation, Sciences et Développement économique Canada applicables aux appareils radio exempts de licence. L'exploitation est autorisée aux deux conditions suivantes : (1) l'appareil ne doit pas produire de brouillage, et (2) l'utilisateur de l'appareil doit accepter tout brouillage radioélectrique subi, même si le brouillage est susceptible d'en compromettre le fonctionnement.

CAN ICES-003(A)/NMB-003(A)

Wireless Operation Channel for Different Domains

N. America	2.412-2.462 GHz	Ch01 through CH11
Japan	2.412-2.484 GHz	Ch01 through Ch14
Europe ETSI	2.412-2.472 GHz	Ch01 through Ch13

Regional notice for Singapore

Complies with
IMDA Standards
DB103778

This ASUS product complies with IMDA Standards.

Regional notice for Malaysia



HDMI Trademark Notice

The terms HDMI, HDMI High-Definition Multimedia Interface, and the HDMI Logo are trademarks or registered trademarks of HDMI Licensing Administrator, Inc.

ENERGY STAR® Qualified Product

ENERGY STAR® is a joint program of the U.S. Environmental Protection Agency and the U.S. Department of Energy helping us all save money and protect the environment through energy efficient products and practices.



All ASUS products with the ENERGY STAR® logo comply with the ENERGY STAR® standard, and the power management feature is enabled by default. The monitor is automatically set to sleep after 10 minutes of user inactivity; the computer is

automatically set to sleep after 30 minutes of user inactivity. To wake your computer, click the mouse, press any key on the keyboard, or press the power button.

Please visit <http://www.energystar.gov/powermanagement> for detail information on power management and its benefits to the environment. In addition, please visit <http://www.energystar.gov> for detail information on the ENERGY STAR® joint program.

NOTE: ENERGY STAR® is NOT supported on FreeDOS and Linux-based products.

Service and Support

Visit our multi-language website at <https://www.asus.com/support>.

