

**H170 PRO
GAMING**



Motherboard

Copyright © 2015 ASUSTeK COMPUTER INC. All Rights Reserved.

No part of this manual, including the products and software described in it, may be reproduced, transmitted, transcribed, stored in a retrieval system, or translated into any language in any form or by any means, except documentation kept by the purchaser for backup purposes, without the express written permission of ASUSTeK COMPUTER INC. ("ASUS").

Product warranty or service will not be extended if: (1) the product is repaired, modified or altered, unless such repair, modification or alteration is authorized in writing by ASUS; or (2) the serial number of the product is defaced or missing.

ASUS PROVIDES THIS MANUAL "AS IS" WITHOUT WARRANTY OF ANY KIND, EITHER EXPRESS OR IMPLIED, INCLUDING BUT NOT LIMITED TO THE IMPLIED WARRANTIES OR CONDITIONS OF MERCHANTABILITY OR FITNESS FOR A PARTICULAR PURPOSE. IN NO EVENT SHALL ASUS, ITS DIRECTORS, OFFICERS, EMPLOYEES OR AGENTS BE LIABLE FOR ANY INDIRECT, SPECIAL, INCIDENTAL, OR CONSEQUENTIAL DAMAGES (INCLUDING DAMAGES FOR LOSS OF PROFITS, LOSS OF BUSINESS, LOSS OF USE OR DATA, INTERRUPTION OF BUSINESS AND THE LIKE), EVEN IF ASUS HAS BEEN ADVISED OF THE POSSIBILITY OF SUCH DAMAGES ARISING FROM ANY DEFECT OR ERROR IN THIS MANUAL OR PRODUCT.

SPECIFICATIONS AND INFORMATION CONTAINED IN THIS MANUAL ARE FURNISHED FOR INFORMATIONAL USE ONLY, AND ARE SUBJECT TO CHANGE AT ANY TIME WITHOUT NOTICE, AND SHOULD NOT BE CONSTRUED AS A COMMITMENT BY ASUS. ASUS ASSUMES NO RESPONSIBILITY OR LIABILITY FOR ANY ERRORS OR INACCURACIES THAT MAY APPEAR IN THIS MANUAL, INCLUDING THE PRODUCTS AND SOFTWARE DESCRIBED IN IT.

Products and corporate names appearing in this manual may or may not be registered trademarks or copyrights of their respective companies, and are used only for identification or explanation and to the owners' benefit, without intent to infringe.

Offer to Provide Source Code of Certain Software

This product contains copyrighted software that is licensed under the General Public License ("GPL"), under the Lesser General Public License Version ("LGPL") and/or other Free Open Source Software Licenses. Such software in this product is distributed without any warranty to the extent permitted by the applicable law. Copies of these licenses are included in this product.

Where the applicable license entitles you to the source code of such software and/or other additional data, you may obtain it for a period of three years after our last shipment of the product, either

(1) for free by downloading it from <http://support.asus.com/download>
or

(2) for the cost of reproduction and shipment, which is dependent on the preferred carrier and the location where you want to have it shipped to, by sending a request to:

ASUSTeK Computer Inc.
Legal Compliance Dept.
15 Li Te Rd.,
Beitou, Taipei 112
Taiwan

In your request please provide the name, model number and version, as stated in the About Box of the product for which you wish to obtain the corresponding source code and your contact details so that we can coordinate the terms and cost of shipment with you.

The source code will be distributed WITHOUT ANY WARRANTY and licensed under the same license as the corresponding binary/object code.

This offer is valid to anyone in receipt of this information.

ASUSTeK is eager to duly provide complete source code as required under various Free Open Source Software licenses. If however you encounter any problems in obtaining the full corresponding source code we would be much obliged if you give us a notification to the email address gpl@asus.com, stating the product and describing the problem (please DO NOT send large attachments such as source code archives, etc. to this email address).

Contents

| | |
|---|----|
| Safety information | iv |
| About this guide | iv |
| Package contents | vi |
| H170 PRO GAMING specifications summary..... | vi |

Chapter 1 Product introduction

| | |
|---|------|
| 1.1 Before you proceed | 1-1 |
| 1.2 Motherboard overview | 1-1 |
| 1.3 Central Processing Unit (CPU) | 1-3 |
| 1.4 System memory | 1-7 |
| 1.5 Expansion slots..... | 1-9 |
| 1.6 Headers and Jumpers..... | 1-11 |
| 1.7 Connectors | 1-13 |
| 1.8 Onboard LED | 1-24 |
| 1.9 Software support..... | 1-26 |

Chapter 2 BIOS information

| | |
|---|------|
| 2.1 Managing and updating your BIOS | 2-1 |
| 2.2 BIOS setup program | 2-6 |
| 2.3 My Favorites | 2-15 |
| 2.4 Main menu | 2-17 |
| 2.5 Ai Tweaker menu..... | 2-19 |
| 2.6 Advanced menu | 2-26 |
| 2.7 Monitor menu | 2-34 |
| 2.8 Boot menu | 2-39 |
| 2.9 Tool menu | 2-44 |
| 2.10 Exit menu | 2-45 |
| 2.11 Installing an operating system | 2-46 |

Appendices

| | |
|--------------------------------|-----|
| Notices..... | A-1 |
| ASUS contact information | A-4 |

Safety information

Electrical safety

- To prevent electrical shock hazard, disconnect the power cable from the electrical outlet before relocating the system.
- When adding or removing devices to or from the system, ensure that the power cables for the devices are unplugged before the signal cables are connected. If possible, disconnect all power cables from the existing system before you add a device.
- Before connecting or removing signal cables from the motherboard, ensure that all power cables are unplugged.
- Seek professional assistance before using an adapter or extension cord. These devices could interrupt the grounding circuit.
- Ensure that your power supply is set to the correct voltage in your area. If you are not sure about the voltage of the electrical outlet you are using, contact your local power company.
- If the power supply is broken, do not try to fix it by yourself. Contact a qualified service technician or your retailer.

Operation safety

- Before installing the motherboard and adding components, carefully read all the manuals that came with the package.
- Before using the product, ensure all cables are correctly connected and the power cables are not damaged. If you detect any damage, contact your dealer immediately.
- To avoid short circuits, keep paper clips, screws, and staples away from connectors, slots, sockets and circuitry.
- Avoid dust, humidity, and temperature extremes. Do not place the product in any area where it may be exposed to moisture.
- Place the product on a stable surface.
- If you encounter technical problems with the product, contact a qualified service technician or your retailer.

About this guide

This user guide contains the information you need when installing and configuring the motherboard.

How this guide is organized

This guide contains the following parts:

- **Chapter 1: Product introduction**
This chapter describes the features of the motherboard and the new technology it supports. It includes descriptions of the switches, jumpers, and connectors on the motherboard.
- **Chapter 2: BIOS information**
This chapter discusses changing system settings through the BIOS Setup menus. Detailed descriptions for the BIOS parameters are also provided.

Where to find more information

Refer to the following sources for additional information and for product and software updates.

1. ASUS websites

The ASUS website provides updated information on ASUS hardware and software products. Refer to the ASUS contact information.

2. Optional documentation

Your product package may include optional documentation, such as warranty flyers, that may have been added by your dealer. These documents are not part of the standard package.

Conventions used in this guide

To ensure that you perform certain tasks properly, take note of the following symbols used throughout this manual.



DANGER/WARNING: Information to prevent injury to yourself when completing a task.



CAUTION: Information to prevent damage to the components when completing a task.



IMPORTANT: Instructions that you **MUST** follow to complete a task.



NOTE: Tips and additional information to help you complete a task.

Typography

Bold text

Indicates a menu or an item to select.

Italics

Used to emphasize a word or a phrase.

<Key>

Keys enclosed in the less-than and greater-than sign means that you must press the enclosed key.

Example: <Enter> means that you must press the Enter or Return key.

<Key1> + <Key2> + <Key3>

If you must press two or more keys simultaneously, the key names are linked with a plus sign (+).

Package contents

Check your motherboard package for the following items.

| | |
|------------------------|--|
| Motherboard | ASUS H170 PRO GAMING motherboard |
| Cables | 4 x Serial ATA 6.0 Gb/s Cables |
| Accessories | 1 x I/O Shield 1 x M.2 Screw Package 1 x PRO GAMING Cable Labels |
| Application DVD | Support DVD |
| Documentation | User Guide |



If any of the above items is damaged or missing, contact your retailer.

H170 PRO GAMING specifications summary

| | |
|------------------------|---|
| CPU | LGA1151 socket for Intel® 6th Generation Core™ i7 / i5 / i3, Pentium®, and Celeron® processors Supports Intel® 14nm CPU Supports Intel® Turbo Boost Technology 2.0 * The Intel® Turbo Boost Technology 2.0 support depends on the CPU types. ** Refer to www.asus.com for Intel® CPU support list. |
| Chipset | Intel® H170 Express Chipset |
| Memory | 4 x DIMM, max. 64GB DDR4 2133 MHz, non-ECC, un-buffered memory Dual-channel memory architecture Supports Intel® Extreme Memory Profile (XMP) * Hyper DIMM support is subject to the physical characteristics of individual CPUs. Please refer to Memory QVL (Qualified Vendors List) for details. ** Refer to www.asus.com for the latest Memory QVL (Qualified Vendors List). |
| Graphics | Integrated graphics processor - Intel® HD Graphics support Multi-VGA output support: DisplayPort, HDMI, DVI, D-Sub ports - Supports DisplayPort with max. resolution 4096 x 2304 @60Hz - Supports HDMI 1.4b with maximum resolution of 4096 x 2160 @24MHz - Supports DVI with maximum resolution of 1920 x 1200 @60Hz - Supports D-Sub with maximum resolution of 1920 x 1200 @60Hz - Supports up to three displays simultaneously Supports Intel® InTru™ 3D, Quick Sync Video, Clear Video HD Technology, Insider™ Maximum shared memory of 512 MB |
| Expansion slots | 1 x PCI Express 3.0 x16 slot (at x16 mode) 1 x PCI Express 3.0 x16 slot (max. at x4 mode, compatible with PCIe x1 and x4 devices. When PCIEX1_2 or PCIEX1_3 is occupied by x1 device, PCIEX16_2 will be at x2 mode) 4 x PCI Express 3.0 x1 slots |

(continued on the next page)

H170 PRO GAMING specifications summary

| | |
|----------------------|--|
| Multi-GPU Support | Supports AMD® 2-Way / Quad-GPU CrossFireX™ Technology |
| Audio | <p>SupremeFX 8-Channel High Definition Audio CODEC</p> <ul style="list-style-type: none"> - Supports Jack-detection, Multi-streaming, Front Panel MIC Jack-retasking - High quality 115dB SNR stereo playback output <p>Audio Features</p> <ul style="list-style-type: none"> - SupremeFX Shielding™ Technology - Premium audio capacitors - Headphone AMP - Optical S/PDIF out port at back panel - Sonic Radar II |
| Storage | <p>Intel® H170 Express Chipset with RAID 0, 1, 5, 10 and Intel® Rapid Storage Technology 14 support</p> <ul style="list-style-type: none"> - 1 x SATA Express port (gray, compatible with 2 x SATA 6.0 Gb/s ports) - 1 x M.2 Socket 3 with M key, type 2242/2260/2280/22110 storage devices support (both SATA & PCIe3.0 x4 mode)* - 4 x SATA 6.0 Gb/s ports (gray) - Supports Intel® Smart Response Technology, Intel® Rapid Start Technology** <p>* When the M.2 Socket 3 is operating in SATA mode, SATA port 1 will be disabled. ** These functions will work depending on the CPU installed.</p> |
| LAN | <p>Intel® Gigabit LAN</p> <p>Anti-surge LANGuard</p> <p>GameFirst technology</p> |
| USB | <p>ASMedia USB3.1 Controller - supports ASUS USB 3.1 Boost</p> <ul style="list-style-type: none"> - 2 x USB 3.1 ports at rear (1 Type-A, red; 1 Type-C, black) <p>Intel® H170 Express Chipset - supports ASUS USB 3.1 Boost</p> <ul style="list-style-type: none"> - 6 x USB 3.0/2.0 ports (4 ports at mid-board; 2 ports at back panel, blue) - 8 x USB 2.0/1.1 ports (6 ports at mid-board; 2 ports at back panel, black)* <p>* 2 x USB2.0 port at mid-board share with ROG extension (ROG_EXT) port.</p> |
| ASUS unique features | <p>Gamer's Guardian</p> <ul style="list-style-type: none"> - DIGI+ VRM - DRAM Overcurrent Protection - ESD Guards on VGA, LAN, Audio, KBMS and USB3.0/2.0 Ports - Highly Durable Components - Stainless Steel Back I/O - Q-Design (Q-DIMM, Q-Slot, Q-Shield, Q-LED) <p>Performance Level Up</p> <ul style="list-style-type: none"> - DIGI+ VRM - AI Suite 3 - Fan Xpert 3 featuring Fan Auto Tuning function and multiple thermistors selection for optimized system cooling control - UEFI BIOS (CrashFree BIOS 3, EZ Flash 3) - RAMCache: Speed your game loads |

(continued on the next page)

H170 PRO GAMING specifications summary

| | |
|-----------------------------|--|
| ASUS unique features | ASUS Exclusive Features <ul style="list-style-type: none"> - USB3.1 Boost featuring speedy USB3.1 transmission - Media Streamer - Push Notice - Disk Unlocker - AI Charger+ - ASUS CPU-Z |
| Rear panel I/O ports | <ul style="list-style-type: none"> 1 x PS/2 keyboard/mouse combo port 1 x Optical S/PDIF out 1 x HDMI 1 x DisplayPort 1 x DVI 1 x D-sub 1 x LAN (RJ-45) port 2 x USB 3.1 ports (1 Type-A, red; 1 Type-C, black) 2 x USB 3.0/2.0 ports 2 x USB 2.0 ports 8-channel audio I/O ports |
| Internal connectors | <ul style="list-style-type: none"> 2 x USB 3.0 connectors supports additional 4 USB 3.0 ports 3 x USB 2.0 connectors support additional 6 USB 2.0 ports (one connector via ROG_EXT header) 1 x System panel header 1 x Front panel audio connector (AAFP) 4 x SATA 6.0 Gb/s connectors (gray) 1 x M.2 Socket 3 for M Key 1 x SATA Express connector: gray, compatible with 2 x SATA 6.0 Gb/s ports 1 x CPU fan connector (4-pin) 1 x CPU optional fan connector (4-pin) 3 x Chassis Fan connectors (4-pin) for both 3-pin(DC mode) and 4-pin(PWM mode) coolers control 1 x Thermal sensor connector 1 x EXT_FAN header 1 x COM connector 1 x TPM header 1 x 24-pin EATX power connector 1 x 8-pin EATX 12V power connector 1 x ROG extension (ROG_EXT) header 1 x CPU_OV 1 x Standby Power LED (red) 1 x Clear CMOS jumper |

(continued on the next page)

H170 PRO GAMING specifications summary

| | |
|----------------------|---|
| BIOS features | 128 Mb Flash ROM, UEFI AMI BIOS, PnP, DMI 3.0, WfM 2.0, SM BIOS 3.0, ACPI 5.0, Multi-language BIOS, ASUS EZ Flash 3, CrashFree BIOS 3, F11 EZ Tuning Wizard, F6 Qfan Control, F3 My Favorites, F9 Quick Note, F12 Print Screen function and ASUS DRAM SPD (Serial Presence Detect) memory information |
| Manageability | WfM 2.0, DMI 3.0, WOL by PME, PXE |
| Support DVD | Drivers ASUS utilities EZ Update Anti-virus software (OEM version) |
| OS support | Windows® 10 (64-bit) Windows® 8.1 (64-bit) Windows® 7 |
| Form factor | ATX Form Factor, 12"x 9.6" (30.5cm x 24.4cm) |



Specifications are subject to change without notice.

Product introduction

1

1.1 Before you proceed

Take note of the following precautions before you install motherboard components or change any motherboard settings.



-
- Unplug the power cord from the wall socket before touching any component.
 - Before handling components, use a grounded wrist strap or touch a safely grounded object or a metal object, such as the power supply case, to avoid damaging them due to static electricity.
 - Hold components by the edges to avoid touching the ICs on them.
 - Whenever you uninstall any component, place it on a grounded antistatic pad or in the bag that came with the component.
 - Before you install or remove any component, ensure that the ATX power supply is switched off or the power cord is detached from the power supply. Failure to do so may cause severe damage to the motherboard, peripherals, or components.
-

1.2 Motherboard overview

Before you install the motherboard, study the configuration of your chassis to ensure that the motherboard fits.



Unplug the power cord before installing or removing the motherboard. Failure to do so can cause you physical injury and damage to motherboard components.

1.2.1 Placement direction

When installing the motherboard, place it into the chassis in the correct orientation. The edge with external ports goes to the rear part of the chassis as indicated in the image.

1.2.2 Screw holes

Place eight screws into the holes indicated by circles to secure the motherboard to the chassis.



Do not overtighten the screws! Doing so can damage the motherboard.

1.2.4 Layout contents

| Connectors/Jumpers/Slots/LED | Page |
|---|------|
| 1. LED light connector (3-pin LED_LIGHT) | 1-22 |
| 2. ATX power connectors (24-pin EATXPWR, 8-pin EATX12V) | 1-17 |
| 3. CPU, CPU optional, extension, and chassis fan connectors (4-pin CPU_FAN, 4-pin CPU_OPT, 5-pin EXT_FAN, 4-pin CHA_FAN1~3) | 1-19 |
| 4. Intel® LGA1151 CPU socket | 1-3 |
| 5. DDR4 DIMM slots | 1-7 |
| 6. USB 3.0 connectors (20-1 pin USB3_12, USB3_34) | 1-16 |
| 7. Model Name LEDs | 1-24 |
| 8. Intel® H170 Serial ATA 6.0 Gb/s connectors (7-pin SATA6G_1~6, SATAEXPRESS) | 1-20 |
| 9. M.2 Socket 3 | 1-18 |
| 10. Standby Power LED (SB_PWR) | 1-24 |
| 11. Thermal sensor connector (2-pin T_SENSOR) | 1-16 |
| 12. System panel connector (20-5 pin PANEL) | 1-21 |
| 13. CPU Over Voltage jumper (3-pin CPU_OV) | 1-12 |
| 14. Clear RTC RAM (2-pin CLRTC) | 1-11 |
| 15. USB 2.0 connectors (10-1 pin USB910, USB1112, USB1314) | 1-15 |
| 16. ROG Extension connector (18-1 pin ROG_EXT) | 1-23 |
| 17. TPM connector (14-1 pin TPM) | 1-22 |
| 18. Serial port connector (10-1 pin COM) | 1-15 |
| 19. Front panel audio connector (10-1 pin AAFP) | 1-18 |
| 20. SupremeFX LED | 1-25 |

1.3 Central Processing Unit (CPU)

This motherboard comes with a surface mount LGA1151 socket designed for the 6th Generation Intel® Core™ i7 / Core™ i5 / Core™ i3, Pentium® and Celeron® processors.

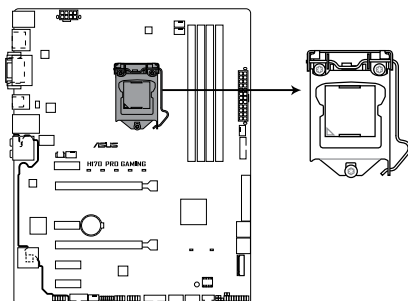

H170 PRO GAMING CPU socket LGA1151



Unplug all power cables before installing the CPU.



- Ensure that you install the correct CPU designed for the LGA1151 socket only. DO NOT install a CPU designed for LGA1150, LGA1155 and LGA1156 sockets on the LGA1151 socket.
- Upon purchase of the motherboard, ensure that the PnP cap is on the socket and the socket contacts are not bent. Contact your retailer immediately if the PnP cap is missing, or if you see any damage to the PnP cap/socket contacts/motherboard components.
- Keep the cap after installing the motherboard. ASUS will process Return Merchandise Authorization (RMA) requests only if the motherboard comes with the cap on the LGA1151 socket.
- The product warranty does not cover damage to the socket contacts resulting from incorrect CPU installation/removal, or misplacement/loss/incorrect removal of the PnP cap.

1.3.1 Installing the CPU

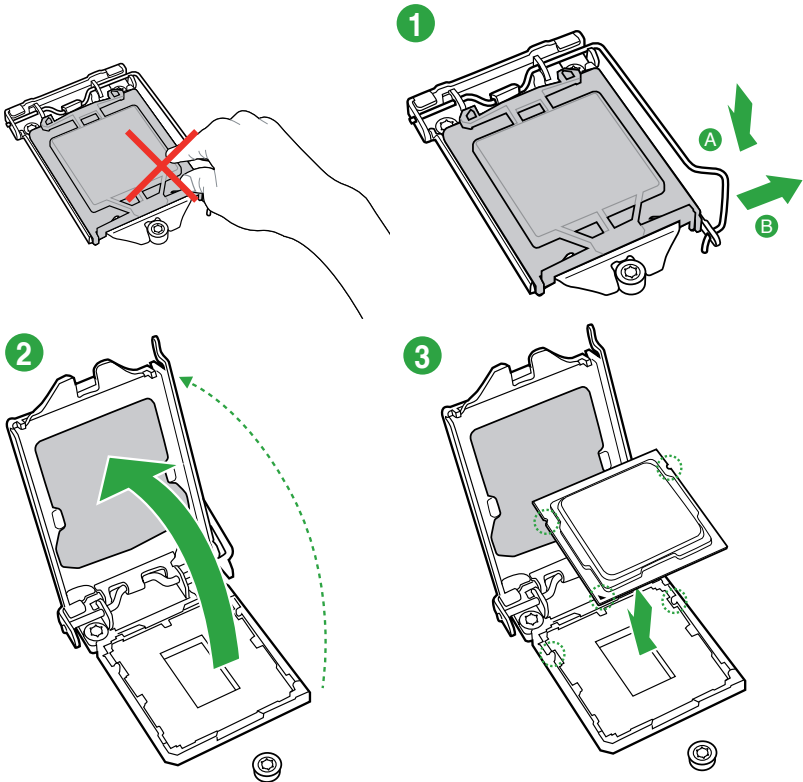

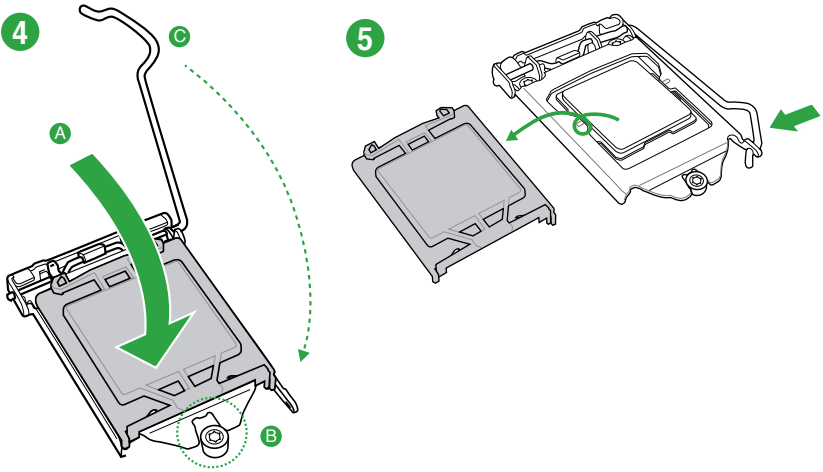

1.3.2 CPU heatsink and fan assembly installation

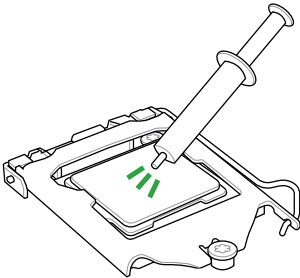

Apply the Thermal Interface Material to the CPU heatsink and CPU before you install the heatsink and fan if necessary.

To install the CPU heatsink and fan assembly

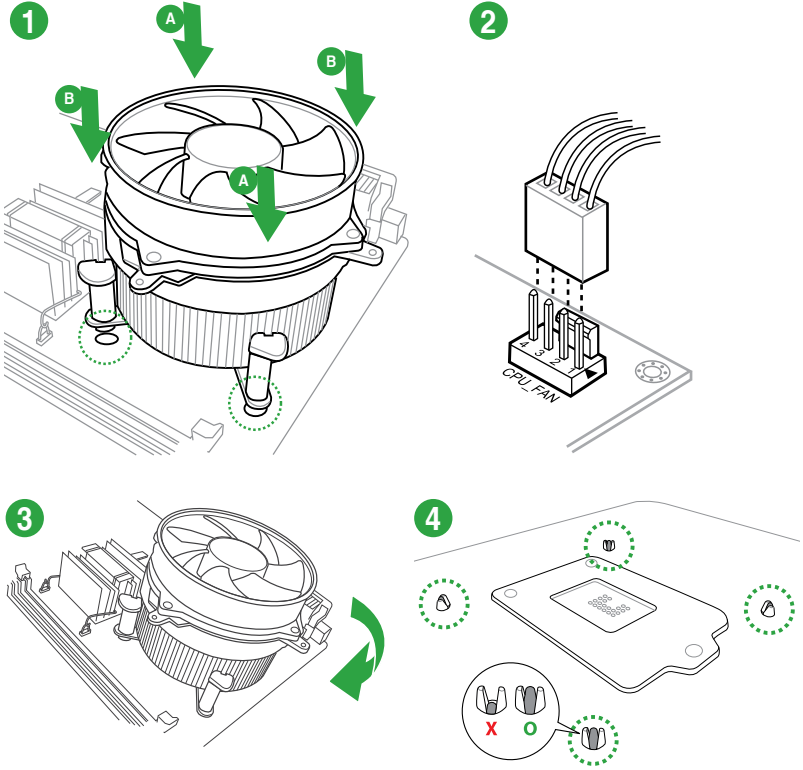

To uninstall the CPU heatsink and fan assembly

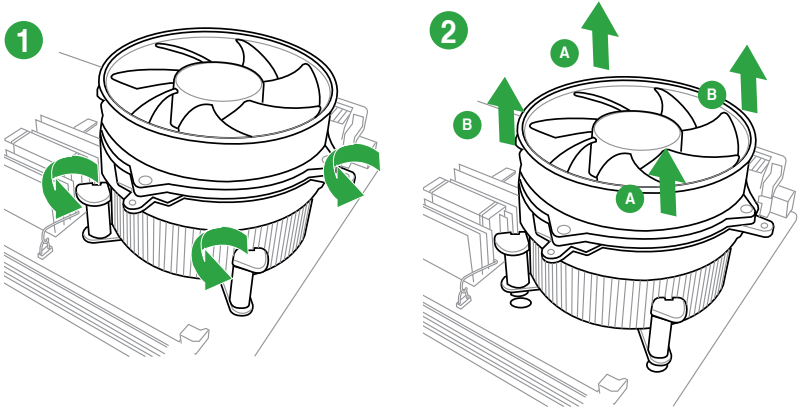

1.4 System memory

1.4.1 Overview

This motherboard comes with four Double Data Rate 4 (DDR4) Dual Inline Memory Module (DIMM) sockets. A DDR4 module is notched differently from a DDR, DDR2, or DDR3 module. DO NOT install a DDR, DDR2, or DDR3 memory module to the DDR4 slot.



According to Intel® CPU spec, DIMM voltage below 1.5V is recommended to protect the CPU.

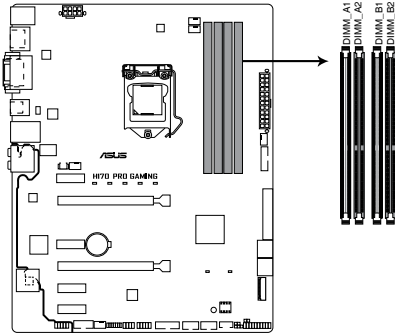

H170 PRO GAMING 288-pin DDR4 DIMM sockets

1.4.2 Memory configurations

You may install 2 GB, 4 GB, 8 GB and 16 GB unbuffered non-ECC DDR4 DIMMs into the DIMM sockets. You can refer to the recommended memory population below.

Recommended memory configurations

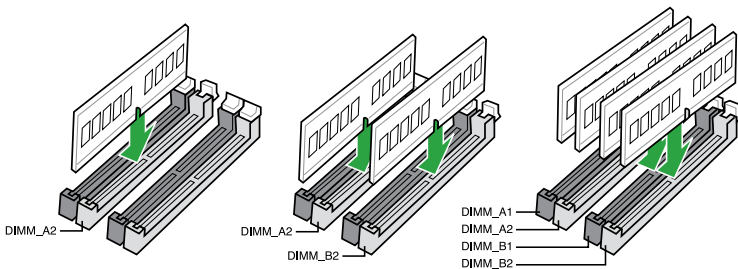



- You may install varying memory sizes in Channel A and Channel B. The system maps the total size of the lower-sized channel for the dual-channel configuration. Any excess memory from the higher-sized channel is then mapped for single-channel operation.
- According to Intel® CPU spec, DIMM voltage below 1.65V is recommended to protect the CPU.
- Due to the memory address limitation on 32-bit Windows® OS, when you install 4GB or more memory on the motherboard, the actual usable memory for the OS can be about 3GB or less. For effective use of memory, we recommend that you do any of the following:
 - Use a maximum of 3 GB system memory if you are using a 32-bit Windows® OS.
 - Install a 64-bit Windows® OS if you want to install 4GB or more on the motherboard.
 - For more details, refer to the Microsoft® support site at <http://support.microsoft.com/kb/929605/en-us>.



- The default memory operation frequency is dependent on its Serial Presence Detect (SPD), which is the standard way of accessing information from a memory module. Under the default state, some memory modules for overclocking may operate at a lower frequency than the vendor-marked value. To operate at the vendor-marked or at a higher frequency, refer to section **2.5 Ai Tweaker menu** for manual memory frequency adjustment.
- Always install the DIMMS with the same CAS Latency. For an optimum compatibility, we recommend that you install memory modules of the same version or data code (D/C) from the same vendor. Check with the vendor to get the correct memory modules.
- For system stability, use a more efficient memory cooling system to support a full memory load (4 DIMMs) or overclocking condition.



Visit the ASUS website at www.asus.com for the latest QVL.

1.4.3 Installing a DIMM

1

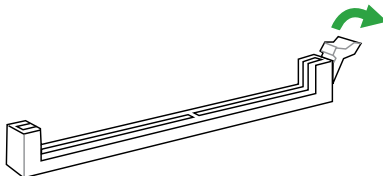

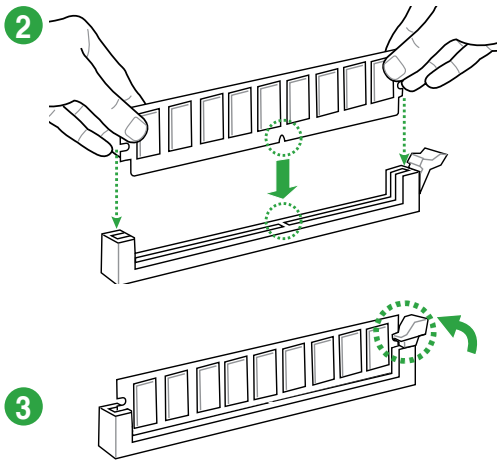

To remove a DIMM

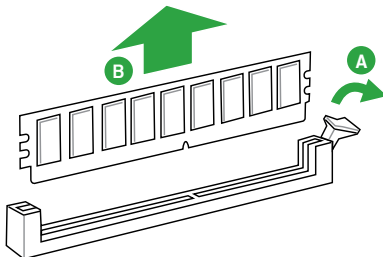

1.5 Expansion slots

In the future, you may need to install expansion cards. The following sub-sections describe the slots and the expansion cards that they support.



Unplug the power cord before adding or removing expansion cards. Failure to do so may cause you physical injury and damage motherboard components.

1.5.1 Installing an expansion card

To install an expansion card:

1. Before installing the expansion card, read the documentation that came with it and make the necessary hardware settings for the card.
2. Remove the system unit cover (if your motherboard is already installed in a chassis).
3. Remove the bracket opposite the slot that you intend to use. Keep the screw for later use.

4. Align the card connector with the slot and press firmly until the card is completely seated on the slot.
5. Secure the card to the chassis with the screw you removed earlier.
6. Replace the system cover.

1.5.2 Configuring an expansion card

After installing the expansion card, configure it by adjusting the software settings.

1. Turn on the system and change the necessary BIOS settings, if any. See Chapter 2 for information on BIOS setup.
2. Assign an IRQ to the card.
3. Install the software drivers for the expansion card.



When using PCI cards on shared slots, ensure that the drivers support "Share IRQ" or that the cards do not need IRQ assignments. Otherwise, conflicts will arise between the two PCI groups, making the system unstable and the card inoperable.

1.5.3 PCI Express 3.0 x1 slots

This motherboard supports PCI Express x1 network cards, SCSI cards, and other cards that comply with the PCI Express specifications.

1.5.4 PCI Express 3.0 x16 slots

This motherboard has two PCI Express 3.0 x16 slots that support PCI Express 3.0 x16 graphic cards complying with the PCI Express specifications.

| VGA configuration | PCI Express operating mode | |
|----------------------|----------------------------|------------------------|
| | PCIe 3.0 x16_1 (gray) | PCIe 3.0 x16_2 (black) |
| Single VGA/PCIe card | x16 | N/A |
| Dual VGA/PCIe cards | x16 | x4 |

| | PCIe Auto mode | | | |
|-----------|----------------|-----|-----|----|
| PCIEX1_2 | N/A | x1 | N/A | x1 |
| PCIEX1_3 | N/A | N/A | x1 | x1 |
| PCIEX16_2 | x4 | x2 | x2 | x2 |



-
- In single VGA card mode, use the PCIe 3.0 x16_1 slot (gray) for a PCI Express x16 graphics card to get better performance.
 - We recommend that you provide sufficient power when running CrossFireX™ mode.
 - Connect a chassis fan to the motherboard connector labeled CHA_FAN1/2/3 when using multiple graphics cards for better thermal environment.
-

IRQ assignments for this motherboard

| | A | B | C | D | E | F | G | H |
|---------------------------|--------|---|--------|--------|---|---|---|---|
| PCIEx16_1 | shared | - | - | - | - | - | - | - |
| PCIEx16_2 | shared | - | - | - | - | - | - | - |
| PCIEx1_1 | - | - | shared | - | - | - | - | - |
| PCIEx1_2 | - | - | shared | - | - | - | - | - |
| PCIEx1_3 | - | - | - | shared | - | - | - | - |
| PCIEx1_4 | - | - | shared | - | - | - | - | - |
| Gbe Controller | shared | - | - | - | - | - | - | - |
| HD Audio | shared | - | - | - | - | - | - | - |
| SATA Controller | shared | - | - | - | - | - | - | - |
| ASMedia USB3.1 Controller | - | - | shared | - | - | - | - | - |
| XHCI Controller | shared | - | - | - | - | - | - | - |

1.6 Headers and Jumpers

1. Clear RTC RAM (2-pin CLRRTC)

This header allows you to clear the Real Time Clock (RTC) RAM in CMOS. You can clear the CMOS memory of date, time, and system setup parameters by erasing the CMOS RTC RAM data. The onboard button cell battery powers the RAM data in CMOS, which include system setup information such as system passwords.

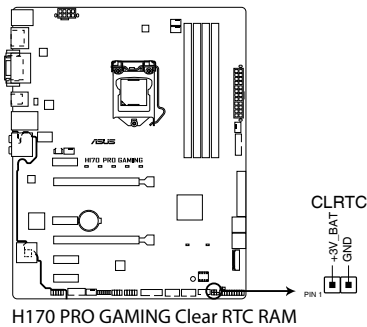

To erase the RTC RAM:

1. Turn OFF the computer and unplug the power cord.
2. Use a metal object such as a screwdriver to short the two pins.
3. Plug the power cord and turn ON the computer.
4. Hold down the key during the boot process and enter BIOS setup to re-enter data.



- If the steps above do not help, remove the onboard battery and short the two pins again to clear the CMOS RTC RAM data. After clearing the CMOS, reinstall the battery.
- You do not need to clear the RTC when the system hangs due to overclocking. For system failure due to overclocking, use the CPU Parameter Recall (C.P.R.) feature. Shut down and reboot the system, then the BIOS automatically resets parameter settings to default values.

2. CPU Over Voltage jumper (3-pin CPU_OV)

The CPU Over Voltage jumper allows you to set a higher CPU voltage for a flexible overclocking system, depending on the type of the installed CPU. To gain more CPU voltage setting, insert the jumper to pins 2-3. To go back to its default CPU voltage setting, insert the jumper to pins 1-2.

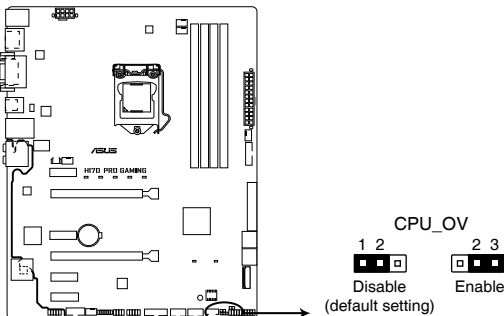

H170 PRO GAMING CPU_OV setting

1.7 Connectors

1.7.1 Rear panel connectors

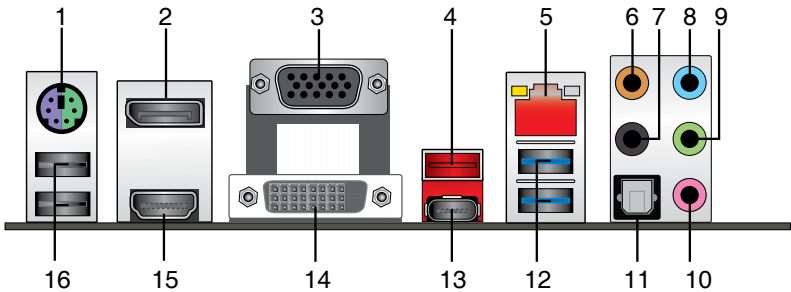

1. **PS/2 mouse/keyboard combo port.** This port is for a PS/2 mouse or keyboard.
2. **DisplayPort.** This port is for a DisplayPort-compatible devices.
3. **Video Graphics Adapter (VGA) port.** This 15-pin port is for a VGA monitor or other VGA-compatible devices.
4. **USB 3.1 port (Type A).** This Universal Serial Bus 3.1 (USB 3.1) port is for USB 3.1 device.
5. **LAN (RJ-45) port.** This port allows Gigabit connection to a Local Area Network (LAN) through a network hub.

LAN port LED indications

| Activity/Link LED | | Speed LED | |
|-------------------------------|-------------------------------|-----------|--------------------|
| Status | Description | Status | Description |
| Off | No link | OFF | 10Mbps connection |
| Orange | Linked | ORANGE | 100Mbps connection |
| Orange (Blinking) | Data activity | GREEN | 1Gbps connection |
| Orange (Blinking then steady) | Ready to wake up from S5 mode | — | — |

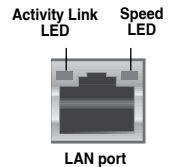

6. **Center / Subwoofer port (orange).** This port connects the center/subwoofer speakers.
7. **Rear Speaker Out port (black).** This port connects the rear speakers in a 4.1 channel, 5.1 channel, or 7.1 channel audio configuration.
8. **Line In port (light blue).** This port connects to the tape, CD, DVD player, or other audio sources.
9. **Line Out port (lime).** This port connects to a headphone or a speaker. In the 4.1, 5.1 and 7.1-channel configurations, the function of this port becomes Front Speaker Out.

10. **Microphone port (pink).** This port connects to a microphone.



Refer to the audio configuration table for the function of the audio ports in 2.1, 4.1, 5.1, or 7.1-channel configuration.

11. **Optical S/PDIF out port.** This port allows you to connect your PC to amplified speakers, headphones, or Sony/Phillips Digital Interconnect Format (S/PDIF) compliant devices.

Audio 2.1, 4.1, 5.1, or 7.1-channel configuration

| Port | Headset 2-channel | 4.1-channel | 5.1-channel | 7.1-channel |
|--------------------|-------------------|-------------------|-------------------|-------------------|
| Light Blue | Line In | Line In | Line In | Line In |
| Lime | Line Out | Front Speaker Out | Front Speaker Out | Front Speaker Out |
| Pink | Mic In | Mic In | Mic In | Mic In |
| Orange | – | – | Center/Subwoofer | Center/Subwoofer |
| Optical S/PDIF out | – | – | – | Side Speaker Out |
| Black | – | Rear Speaker Out | Rear Speaker Out | Rear Speaker Out |

12. **USB 3.0 ports 3 and 4.** These 9-pin Universal Serial Bus (USB) ports are for USB 3.0 devices.



- The plugged USB 3.0 device may run on xHCI or EHCI mode, depending on the operating system's setting.
- Due to the limitation of USB 3.0 controller, USB 3.0 devices can only be used under Windows® OS environment and after the USB 3.0 driver installation.
- These connectors are based on xHCI specification. We recommend you to install the related driver to fully use the USB3.0 ports under Windows® 7.
- We strongly recommend that you connect USB 3.0 devices to USB 3.0 ports for faster and better performance from your USB 3.0 devices.

13. **USB 3.1 ports (Type C).** These 9-pin Universal Serial Bus (USB) ports are for USB 3.1 (Type C) devices.

14. **DVI-D port.** This port is for any DVI-D compatible device.



DVI-D can not be converted to output from RGB Signal to CRT and is not compatible with DVI-I.

15. **HDMI port.** This port is for a High-Definition Multimedia Interface (HDMI) connector, and is HDCP compliant allowing playback of HD DVD, Blu-ray, and other protected content.

16. **USB 2.0 ports 7 and 8.** These two 4-pin Universal Serial Bus (USB) ports are for USB 2.0/1.1 devices.

1.7.2 Internal connectors

1. Serial port connector (10-1 pin COM)

This connector is for a serial (COM) port. Connect the serial port module cable to this connector, then install the module to a slot opening at the back of the system chassis.

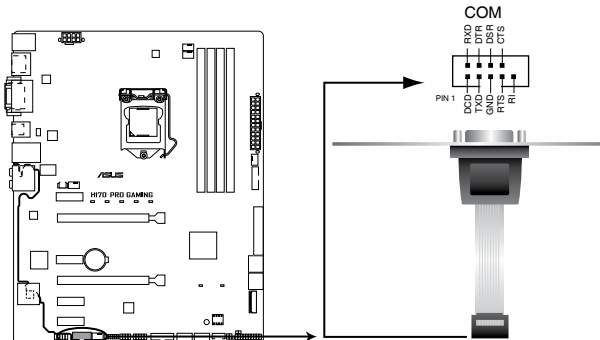

H170 PRO GAMING Serial port (COM) connector



The COM module is purchased separately.

2. USB 2.0 connectors (10-1 pin USB910, USB1112, USB1314)

These connectors are for USB 2.0 ports. Connect the USB module cable to any of these connectors, then install the module to a slot opening at the back of the system chassis. These USB connectors comply with USB 2.0 specifications and supports up to 480Mbps connection speed.

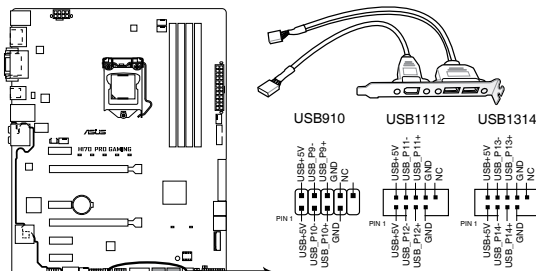

H170 PRO GAMING USB2.0 connectors



Never connect a 1394 cable to the USB connectors. Doing so will damage the motherboard!



The USB 2.0 module is purchased separately.

3. USB 3.0 connectors (20-1 pin USB3_12, USB3_34)

These connectors allow you to connect a USB 3.0 module for additional USB 3.0 front or rear panel ports. With an installed USB 3.0 module, you can enjoy all the benefits of USB 3.0 including faster data transfer speeds of up to 5 Gbps, faster charging time for USB-chargeable devices, optimized power efficiency, and backward compatibility with USB 2.0.

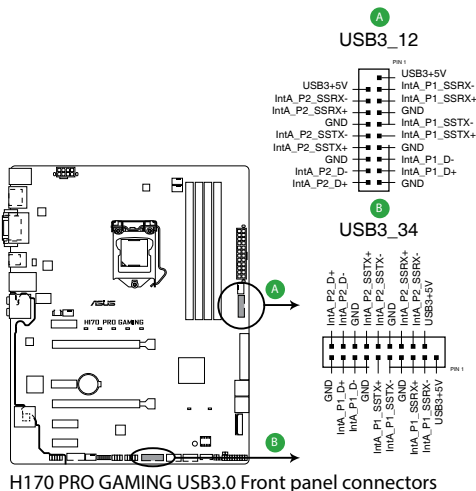

- These connectors are based on xHCI specification. We recommend you to install the related driver to fully use the USB3.0 ports under Windows® 7.
- The plugged USB 3.0 device will run on xHCI mode.

4. Thermal sensor connector (2-pin T_SENSOR)

This connector is for the thermistor cable that allows you to monitor the temperature of your motherboard's critical components and connected devices.

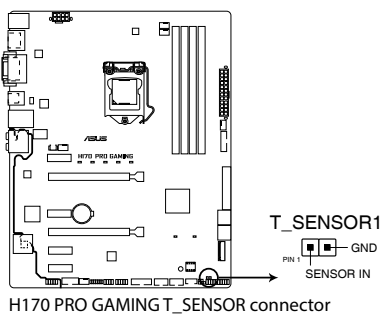

5. ATX power connectors (24-pin EATXPWR, 8-pin EATX12V)

These connectors are for ATX power supply plugs. The power supply plugs are designed to fit these connectors in only one orientation. Find the proper orientation and push down firmly until the connectors completely fit.

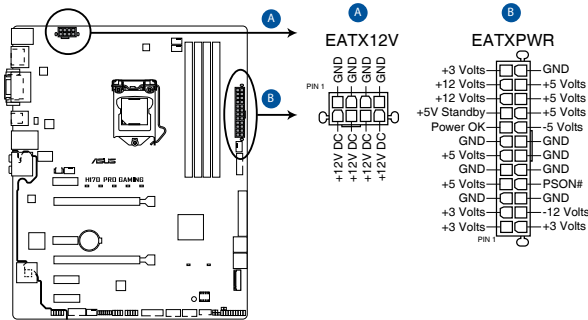

H170 PRO GAMING ATX power connectors



- For a fully configured system, we recommend that you use a power supply unit (PSU) that complies with ATX 12V Specification 2.0 (or later version) and provides a minimum power of 350 W.
- DO NOT forget to connect the 4-pin/8-pin EATX +12V power plug. Otherwise, the system will not boot up.
- We recommend that you use a PSU with higher power output when configuring a system with more power-consuming devices or when you intend to install additional devices. The system may become unstable or may not boot up if the power is inadequate.
- If you are uncertain about the minimum power supply requirement for your system, refer to the Recommended Power Supply Wattage Calculator at <http://support.asus.com/PowerSupplyCalculator/PSCalculator.aspx?SLanguage=en-us> for details.

6. Front panel audio connector (10-1 pin AAFP)

This connector is for a chassis-mounted front panel audio I/O module that supports either HD Audio or legacy AC'97 audio standard. Connect one end of the front panel audio I/O module cable to this connector.

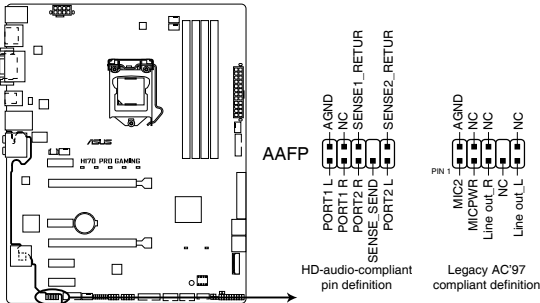

H170 PRO GAMING Front panel audio connector



- We recommend that you connect a high-definition front panel audio module to this connector to avail of the motherboard's high-definition audio capability.
- If you want to connect a high-definition front panel audio module to this connector, set the Front Panel Type item in the BIOS setup to [HD Audio]. If you want to connect an AC'97 front panel audio module to this connector, set the item to [AC97]. By default, this connector is set to [HD Audio]. See section **2.6.7 Onboard Devices Configuration** for details.

7. M.2 socket 3

This socket allows you to install an M.2 (NGFF) SSD module.

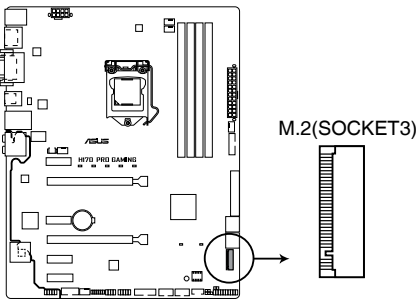

H170 PRO GAMING M.2(SOCKET3)



- This socket supports M Key and 2242/2260/2280/22110 storage devices.
- When the M.2 Socket 3 is operating in SATA mode, SATA port 1 will be disabled.



The M.2 (NGFF) SSD module is purchased separately

8. CPU, CPU optional, extension, and chassis fan connectors (4-pin CPU_FAN; 4-pin CPU_OPT; 5-pin EXT_FAN, 4-pin CHA_FAN1~3)

Connect the fan cables to the fan connectors on the motherboard, ensuring that the black wire of each cable matches the ground pin of the connector.

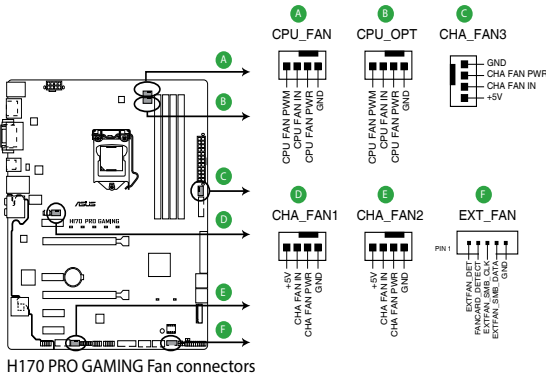

H170 PRO GAMING Fan connectors



- Do not forget to connect the fan cables to the fan connectors. Insufficient air flow inside the system may damage the motherboard components. These are not jumpers! Do not place jumper caps on the fan connectors!
- Ensure that the CPU fan cable is securely installed to the CPU fan connector.



- The CPU_FAN connector supports a CPU fan of maximum 1 A (12 W) fan power.
- The CPU_FAN connector and CHA_FAN connectors support the ASUS FAN Xpert 3 feature.
- The EXT_FAN connector supports 2 of 5 thermal sensor sources.
- The CPU fan connector detects the type of CPU fan installed and automatically switches the control modes. To configure the CPU fan's control mode, go to **Advanced > Monitor > Q-Fan Configuration > CPU Q-Fan Control** item in BIOS.
- The chassis fan connectors support DC and PWM modes. To set these fans to DC or PWM, go to **Advanced > Monitor > Q-Fan Configuration > Chassis Fan 1/2/3 Q-Fan Control** items in BIOS.
- The extension fan connectors support DC and PWM modes. To set these fans to DC or PWM, go to **Advanced > Monitor > Q-Fan Configuration > Extension Fan 1/2/3 Q-Fan Control** items in BIOS.



The FAN EXTENSION CARD is purchased separately.

9. Intel® H170 Serial ATA 6.0Gb/s connectors (7-pin SATA6G_1~6, SATAEXPRESS)

This connector connects to Serial ATA 6.0 Gb/s hard disk drives via Serial ATA 6.0 Gb/s signal cables.

If you installed Serial ATA hard disk drives, you can create a RAID 0, 1, 5, and 10 configuration with the Intel® Rapid Storage Technology through the onboard Intel® H170 chipset.

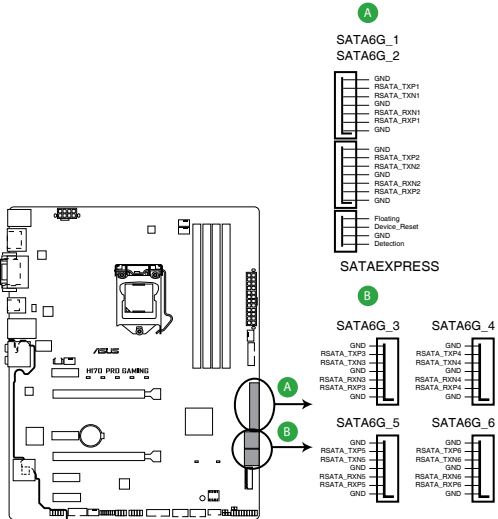

H170 PRO GAMING Intel® SATA 6.0Gb/s connectors

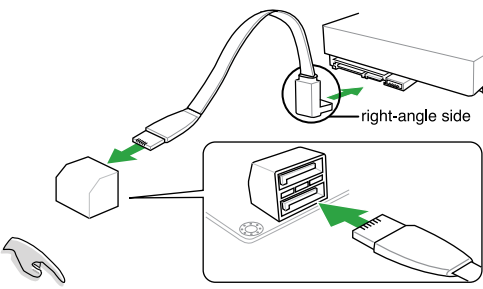

NOTE: Connect the right-angle side of SATA signal cable to SATA device. You may also connect the right-angle side of SATA cable to the onboard SATA port to avoid mechanical conflict with huge graphics cards.

- You must install Windows. XP Service Pack 3 or later version before using Serial ATA hard disk drives.
- When using hot-plug and NCQ, set the **SATA Mode Selection** item in the BIOS to [AHCI]. See section 2.6.5 **SATA Configuration** for details.

10. System panel connector (20-5 pin PANEL)

This connector supports several chassis-mounted functions.

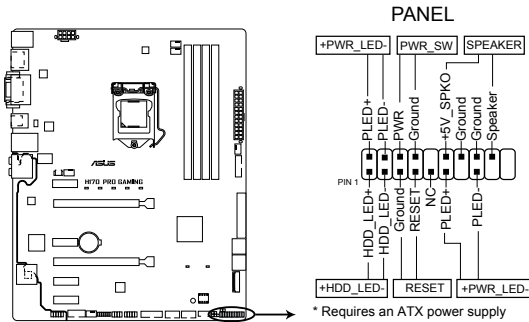

H170 PRO GAMING System panel connector

- **System power LED (4-pin +PWR_LED-)**

This 2-pin connector is for the system power LED. Connect the chassis power LED cable to this connector. The system power LED lights up when you turn on the system power, and blinks when the system is in sleep mode.

- **Hard disk drive activity LED (2-pin +HDD_LED-)**

This 2-pin connector is for the HDD Activity LED. Connect the HDD Activity LED cable to this connector. The HDD LED lights up or flashes when data is read from or written to the HDD.

- **System warning speaker (4-pin SPEAKER)**

This 4-pin connector is for the chassis-mounted system warning speaker. The speaker allows you to hear system beeps and warnings.

- **ATX power button/soft-off button (2-pin PWR_SW)**

This connector is for the system power button. Pressing the power button turns the system on or puts the system in sleep or soft-off mode depending on the operating system settings. Pressing the power switch for more than four seconds while the system is ON turns the system OFF.

- **Reset button (2-pin RESET)**

This 2-pin connector is for the chassis-mounted reset button for system reboot without turning off the system power.

11. TPM connector (14-1 pin TPM)

This connector supports a Trusted Platform Module (TPM) system, which can securely store keys, digital certificates, passwords, and data. A TPM system also helps enhance network security, protects digital identities, and ensures platform integrity.

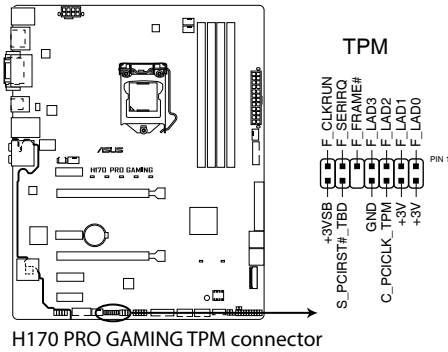

The TPM module is purchased separately.

12. LED Light connector (3-pin LED_LIGHT)

This connector is for the LED light.

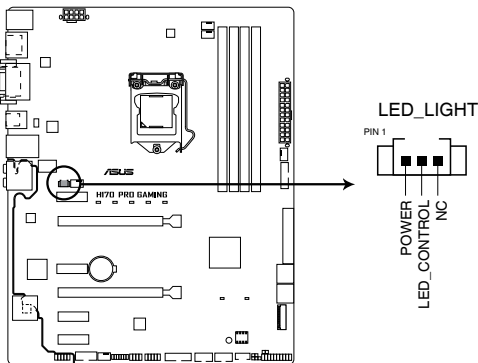

13. ROG Extension - ROG_EXT connector (18-1 pin ROG_EXT)

This connector is for the Front Base.

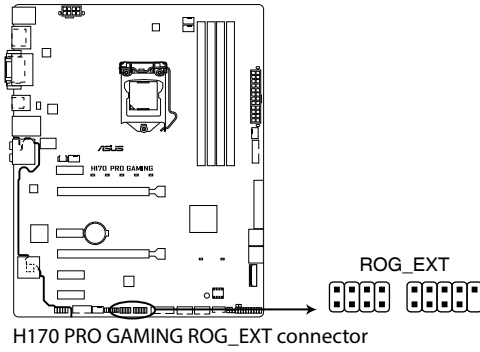

- The Front Base is purchased separately.
- Visit www.asus.com for more information about the Front Base.

1.8 Onboard LED

1. Standby Power LED (SB_PWR)

The motherboard comes with a standby power LED that lights up to indicate that the system is ON, in sleep mode, or in soft-off mode. This is a reminder that you should shut down the system and unplug the power cable before removing or plugging in any motherboard component. The illustration below shows the location of the onboard LED.

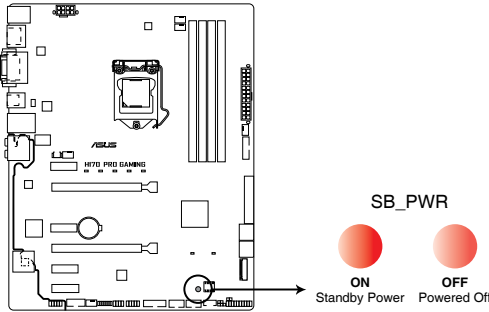

H170 PRO GAMING Onboard LED

2. Model Name LEDs

The Model Name LEDs are a group of five small LEDs, located right below the printed model name. The LEDs light up in the following two modes to highlight the model name.

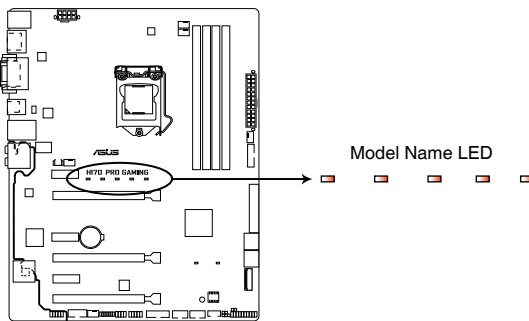

H170 PRO GAMING Model Name LED Lighting

| Lighting mode | Description |
|----------------|--------------------------------|
| Breathing mode | The LEDs blink intermittently. |
| Still mode | The LEDs become solid red. |



You can turn off the model name LEDs or change the lit modes from the BIOS or the LED Control app in AI Suite 3. To change the setting in BIOS, go to **Advanced > Onboard Devices Configuration > Model Name LED Lighting** item. See section 2.6.7 **Onboard Devices Configuration** for details.

3. SupremeFX LED

The SupremeFX LED lights up in the following three ways to bring you an ultimate lighting effect. This LED also outlines the separation of the audio components from the rest of your motherboard.

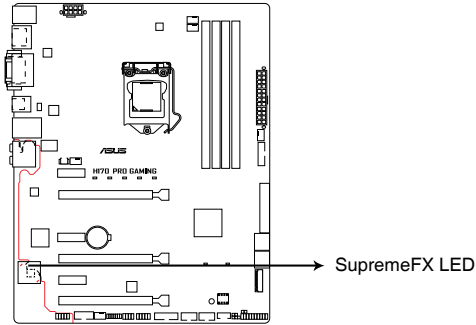

H170 PRO GAMING SupremeFX LED Lighting

| Lighting mode | Description |
|----------------|--|
| Breathing mode | The LED blinks intermittently. |
| Flowing mode | The LED lights up and dims like flowing water. |
| Still mode | The LED becomes solid red. |



You can turn off the SupremeFX LED or change the lit modes from the BIOS or the LED Control app in AI Suite 3. To change the setting in BIOS, go to **Advanced > Onboard Devices Configuration > Audio LED Lighting** item. See section 2.6.7 **Onboard Devices Configuration** for details.

1.9 Software support

1.9.1 Installing an operating system

This motherboard supports Windows® 7 (32-bit / 64-bit), Windows® 8 (32-bit /64-bit), Windows® 8.1 (64-bit) and Windows® 10 (64-bit) Operating Systems (OS). Always install the latest OS version and corresponding updates to maximize the features of your hardware.



Motherboard settings and hardware options vary. Refer to your OS documentation for detailed information.

1.9.2 Support DVD information

The Support DVD that comes with the motherboard package contains the drivers, software applications, and utilities that you can install to avail all motherboard features.



The contents of the Support DVD are subject to change at any time without notice. Visit the ASUS website at www.asus.com for updates.

To run the Support DVD

Place the Support DVD into the optical drive. If Autorun is enabled in your computer, the DVD automatically displays the lists of the unique features of your ASUS motherboard. Click the **Drivers**, **Utilities**, **Manual**, or **Specials** tabs to display their respective menus.



The following screen is for reference only.

| Name | Status | Available version | Installed version | Enabled |
|---|---------------|-------------------|-------------------|---------|
| Google Chrome Browser | Not installed | 48.0.2526.92 | None | No |
| Google Toolbar | Not installed | 7.8.499.1392 | None | No |
| Office | | | | |
| Microsoft .NET Framework | Outdated | 4.5.14073 | 4.5.14042 | No |
| Intel Chipset Driver | Not installed | 9E.0.2.7 | None | No |
| Realtek Audio Driver | Not installed | 6.0.2.7542 | None | No |
| Intel Graphics Acceleration Driver | Not installed | 9.18 (2.0.06) | None | No |
| Intel LAN Driver | Not installed | 19.2.000.9 | None | No |
| ASUS Fast Boot WOL Driver | Not installed | 5.0 | None | No |
| Management Engine Firmware | Not installed | 1.16.0.1108 | None | No |
| Intel Rapid Storage Technology Control v... | Not installed | 14.5.0.2362 | None | No |
| Intel USB 3.0 Host Controller Adaptation... | Not installed | 1.0.0.42 | None | No |
| Realtek USB 2.0 Host Controller Adaptation... | Installed | 1.00.00.0 | 1.00.00.0 | No |
| ASUS Utility | Not installed | 1.0.0.0 | None | No |

Click a tab to display Support DVD information

Select an item/ subitem that you want to install

Click to install



If Autorun is NOT enabled in your computer, browse the contents of the Support DVD to locate the file ASSETUP.EXE from the BIN folder. Double-click the ASSETUP.EXE to run the DVD.

BIOS information

2

2.1 Managing and updating your BIOS



Save a copy of the original motherboard BIOS file to a USB flash disk in case you need to restore the BIOS in the future. Copy the original motherboard BIOS using the ASUS Update utility.

2.1.1 EZ Update

EZ Update is a utility that allows you to automatically update your motherboard's softwares, drivers and the BIOS version easily. With this utility, you can also manually update the saved BIOS and select a boot logo when the system goes into POST.

To launch EZ Update, click **EZ Update** on the AI Suite 3 main menu bar.

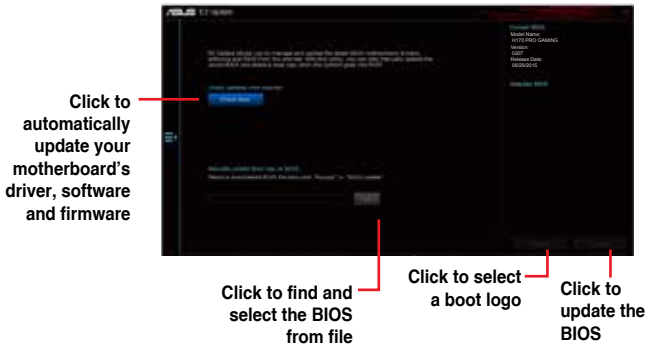

EZ Update requires an Internet connection either through a network or an ISP (Internet Service Provider).

2.1.2 ASUS EZ Flash 3

The ASUS EZ Flash 3 feature allows you to update the BIOS without using an OS-based utility.



- Ensure to load the BIOS default settings to ensure system compatibility and stability. Select the Load Optimized Defaults item under the Exit menu. See section **2.10 Exit Menu** for details.
- Check your local Internet connection before updating through the Internet.

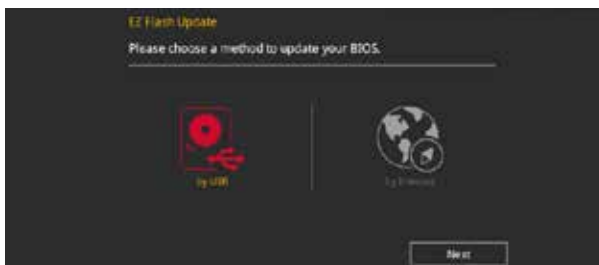

To update the BIOS using EZ Flash 3:

1. Enter the **Advanced Mode** of the BIOS setup program. Go to the **Tool** menu to select ASUS EZ Flash 3 and press <Enter> to enable it.
2. Follow the steps below to update the BIOS via USB or Internet.

Via USB

- a) Insert the USB flash disk that contains the latest BIOS file to the USB port, then select **by USB**.
- b) Press <Tab> to switch to the **Drive** field.
- c) Press the Up/Down arrow keys to find the USB flash disk that contains the latest BIOS, and then press <Enter>.
- d) Press <Tab> to switch to the **Folder Info** field.
- e) Press the Up/Down arrow keys to find the BIOS file, and then press <Enter> to perform the BIOS update process.

Via the Internet

- a) Select **by Internet**.
 - b) Press the Left/Right arrow keys to select an Internet connection method, and then press <Enter>.
 - c) Follow the onscreen instructions to complete the update.
3. Reboot the system when the update process is done.



-
- ASUS EZ Flash 3 supports USB devices, such as a USB flash disk, with FAT 32/16 format and single partition only.
 - DO NOT shut down or reset the system while updating the BIOS to prevent system boot failure!.
-

2.1.3 ASUS CrashFree BIOS 3 utility

The ASUS CrashFree BIOS 3 is an auto recovery tool that allows you to restore the BIOS file when it fails or gets corrupted during the updating process. You can restore a corrupted BIOS file using the motherboard support DVD or a USB flash drive that contains the updated BIOS file.



-
- Before using this utility, rename the BIOS file in the removable device into **H170PG.CAP**.
 - The BIOS file in the support DVD may not be the latest version. Download the latest BIOS file from the ASUS website at www.asus.com.
-

Recovering the BIOS

To recover the BIOS:

1. Turn on the system.
2. Insert the support DVD to the optical drive or the USB flash drive that contains the BIOS file to the USB port.
3. The utility automatically checks the devices for the BIOS file. When found, the utility reads the BIOS file and enters ASUS EZ Flash 3 utility automatically.
4. The system requires you to enter BIOS Setup to recover BIOS settings. To ensure system compatibility and stability, we recommend that you press <F5> to load default BIOS values.



DO NOT shut down or reset the system while updating the BIOS! Doing so can cause system boot failure!

2.1.4 ASUS BIOS Updater

ASUS BIOS Updater allows you to update the BIOS in DOS environment.



The screen captures used in this section are for reference only and may not be exactly the same as actually shown on your computer screen.

Before updating BIOS

- Prepare the motherboard support DVD and a USB flash drive.
- Download the latest BIOS file and BIOS Updater from <http://support.asus.com> and save them in your USB flash drive.



NTFS is not supported under FreeDOS environment. Ensure that your USB flash drive is in single partition and in FAT32/16 format.

- Turn off the computer.
- Ensure that your computer has a DVD optical drive.

Booting the system in DOS environment

To boot the system in DOS:

1. Insert the USB flash drive with the latest BIOS file and BIOS Updater to the USB port.
2. Boot your computer then press <F8> to launch the select boot device screen.
3. When the select boot device screen appears, insert the Support DVD into the optical drive then select the optical drive as the boot device.

```

Please select boot device:
↑ and ↓ to move selection
ENTER to select boot device
ESC to boot using defaults
-----
P2: ST3808110AS (76319MB)
aigo miniking (250MB)
UEFI: (FAT) ASUS DRW-2014L1T(4458MB)
P1: ASUS DRW-2014L1T(4458MB)
UEFI: (FAT) aigo miniking (250MB)
Enter Setup

```

4. When the booting message appears, press <Enter> within five (5) seconds to enter FreeDOS prompt.

```

ISOLINUX 3.20 2006-08-26 Copyright (C) 1994-2005 H. Peter Anvin
A Bootable DVD/CD is detected. Press ENTER to boot from the DVD/CD.
If no key is pressed within 5 seconds, the system will boot next priority
device automatically. boot:

```

5. On the FreeDOS prompt, type **d:** then press <Enter> to switch the disk from Drive C (optical drive) to Drive D (USB flash drive).

```

Welcome to FreeDOS (http://www.freedos.org) !
C: /> d:
D: />

```

Updating the BIOS file

To update the BIOS file:

1. On the FreeDOS prompt, type **bupdater /pc /g** and press <Enter>.

```

D: /> bupdater /pc /g

```

2. On the BIOS Updater screen, press <Tab> to switch from Files panel to Drives panel then select **D:**.

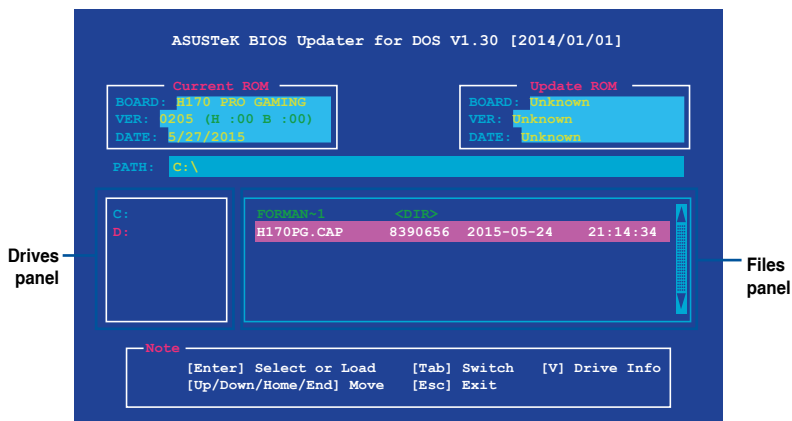

3. Press <Tab> to switch from Drives panel to Files panel then press <Up/Down or Home/End> keys to select the BIOS file and press <Enter>.
4. After the BIOS Updater checks the selected BIOS file, select **Yes** to confirm the BIOS update.

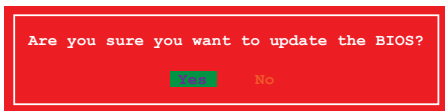

The BIOS Backup feature is not supported due to security regulations.

5. Select **Yes** then press <Enter>. When BIOS update is done, press <ESC> to exit BIOS Updater.
6. Restart your computer.



DO NOT shut down or reset the system while updating the BIOS to prevent system boot failure.



Ensure to load the BIOS default settings to ensure system compatibility and stability. Select the **Load Optimized Defaults** item under the **Exit BIOS menu**. See section **2.10 Exit Menu** for details.

2.2 BIOS setup program

Use the BIOS Setup program to update the BIOS or configure its parameters. The BIOS screens include navigation keys and brief online help to guide you in using the BIOS Setup program.

Entering BIOS Setup at startup

To enter BIOS Setup at startup:

Press <Delete> or <F2> during the Power-On Self Test (POST). If you do not press <Delete> or <F2>, POST continues with its routines.

Entering BIOS Setup after POST

To enter BIOS Setup after POST:

Press <Ctrl>+<Alt>+ simultaneously.

Press the reset button on the system chassis.

Press the power button to turn the system off then back on. Do this option only if you failed to enter BIOS Setup using the first two options.



Using the power button, reset button, or the <Ctrl>+<Alt>+ keys to force reset from a running operating system can cause damage to your data or system. We recommend you always shut down the system properly from the operating system.



- The BIOS setup screens shown in this section are for reference purposes only, and may not exactly match what you see on your screen.
 - Visit the ASUS website at www.asus.com to download the latest BIOS file for this motherboard.
 - Ensure that a USB mouse is connected to your motherboard if you want to use the mouse to control the BIOS setup program.
 - If the system becomes unstable after changing any BIOS setting, load the default settings to ensure system compatibility and stability. Select the **Load Optimized Defaults** item under the Exit menu or press hotkey F5. See section 2.10 Exit Menu for details.
 - If the system fails to boot after changing any BIOS setting, try to clear the CMOS and reset the motherboard to the default value. See section 1.6 Headers and Jumpers for information on how to erase the RTC RAM.
-

BIOS menu screen

The BIOS setup program can be used under two modes: **EZ Mode** and **Advanced Mode**. Press <F7> to change between the two modes.

2.2.1 EZ Mode

By default, the EZ Mode screen appears when you enter the BIOS setup program. The EZ Mode provides you an overview of the basic system information, and allows you to select the display language, system performance mode, fan profile and boot device priority. To access the Advanced Mode, click **Advanced Mode(F7)** or press <F7>.



The default screen for entering the BIOS setup program can be changed. Refer to the **Setup Mode** item in section 2.8 **Boot menu** for details.

Displays the CPU/motherboard temperature, CPU voltage output, CPU/chassis fan speed, and SATA information

Selects the display language of the BIOS setup program

Displays the system properties of the selected mode. Click <Enter> to switch EZ System Tuning modes

Creates storage RAID and configures system overclocking

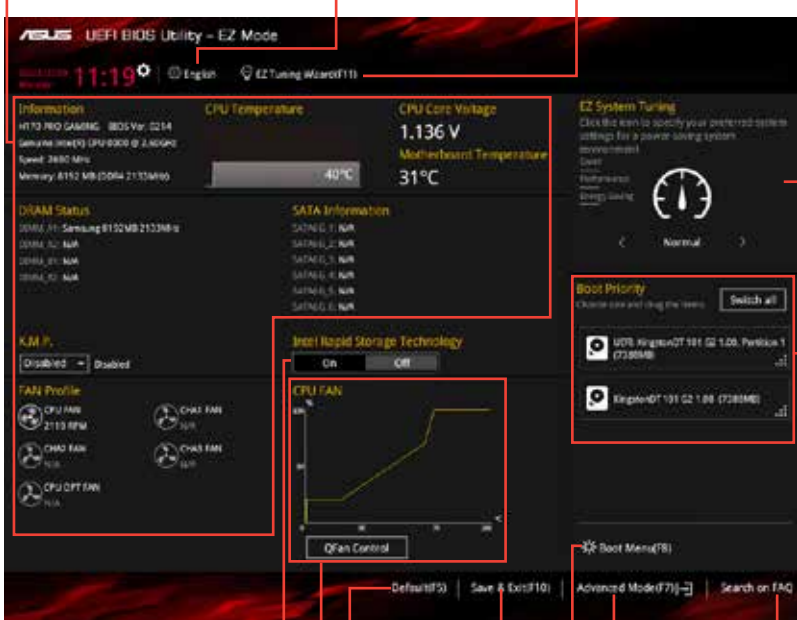

Enables or disables the Intel Rapid Storage Technology

Displays the CPU Fan's speed. Click the button to manually tune the fans

Loads optimized default settings

Saves the changes and resets the system

Shows the bootable devices

Searches FAQ
Selects the boot device priority

Displays the Advanced mode menus



The boot device options vary depending on the devices you installed to the system.

2.2.2 Advanced Mode

The Advanced Mode provides advanced options for experienced end-users to configure the BIOS settings. The figure below shows an example of the **Advanced Mode**. Refer to the following sections for the detailed configurations.



To access the EZ Mode, click **EzMode(F7)** or press <F7>.

The screenshot shows the ASUS UEFI BIOS Utility in Advanced Mode. The interface is dark-themed with red accents. At the top, there is a menu bar with options like 'My Favorites', 'Main', 'AI Tweaker', 'Advanced', 'Monitor', 'Boot', 'Tool', and 'Exit'. A 'Language' dropdown is set to 'English'. A 'MyFavorite' button is visible. The main area is divided into several sections: 'Q-Fan control', 'EZ Tuning Wizard', 'Quick Note', and 'Hot Keys'. The 'EZ Tuning Wizard' section has a dropdown menu with options: 'Auto', 'Enabled', 'Auto', 'Keep Current Settings', 'Disabled', and 'Auto'. The 'Hardware Monitor' section on the right displays CPU and Memory information. The CPU section shows Frequency (2600 MHz), Temperature (42°C), BCLK (1800 MHz), Core Voltage (1.150 V), and Fan (24x). The Memory section shows Frequency (2133 MHz), Voltage (1.200 V), and Capacity (8192 MB). The Voltage section shows +1.2V (+1a), +1.50V (+1b), and +3.3V (+3.3a, 3.290 V). At the bottom, there is a 'Last Modified' field and an 'EzMode(F7)' button. The version number 'Version 2.17.12.46' and copyright information 'Copyright (C) 2015 American Megatrends, Inc.' are also visible.

Labels in the image include:

- Menu bar
- Language
- MyFavorite
- Q-Fan control
- EZ Tuning Wizard
- Quick Note
- Hot Keys
- Sub-menu item
- General help
- Popup Window
- Scroll bar
- Last modified settings
- Goes back to EZ Mode
- Configuration fields
- Displays the CPU/motherboard temperature, CPU and memory voltage output

Menu bar

The menu bar on top of the screen has the following main items:

| | |
|---------------------|--|
| My Favorites | For saving the frequently-used system settings and configuration |
| Main | For changing the basic system configuration |
| Ai Tweaker | For changing the overclocking settings |
| Advanced | For changing the advanced system settings |
| Monitor | For displaying the system temperature, power status, and changing the fan settings |
| Boot | For changing the system boot configuration |
| Tool | For configuring options for special functions |
| Exit | For selecting the exit options and loading default settings |

Menu items

The highlighted item on the menu bar displays the specific items for that menu. For example, selecting **Main** shows the Main menu items.

The other items (My Favorites, Ai Tweaker, Advanced, Monitor, Boot, Tool, and Exit) on the menu bar have their respective menu items.

Submenu items

A greater than sign (>) before each item on any menu screen means that the item has a submenu. To display the submenu, select the item and press <Enter>.

Language

This button above the menu bar contains the languages that you can select for your BIOS. Click this button to select the language that you want to display in your BIOS screen.

MyFavorites (F3)

This button above the menu bar shows all BIOS items in a Tree Map setup. Select frequently-used BIOS settings and save it to MyFavorites menu.



Refer to section **2.3 My Favorites** for more information.

Q-Fan Control (F6)

This button above the menu bar displays the current settings of your fans. Use this button to manually tweak the fans to your desired settings.



Refer to section **2.2.3 QFan Control** for more information.

EZ Tuning Wizard (F11)

This button above the menu bar allows you to view and tweak the overclocking settings of your system. It also allows you to change the motherboard's SATA mode from AHCI to RAID mode.



Refer to section **2.2.4 EZ Tuning Wizard** for more information.

Quick Note (F9)

This button above the menu bar allows you to key in notes of the activities that you have done in BIOS.



- The Quick Note function does not support the following keyboard functions: delete, cut, copy and paste.
- You can only use the alphanumeric characters to enter your notes.

Hot keys

This button above the menu bar contains the navigation keys for the BIOS setup program. Use the navigation keys to select items in the menu and change the settings.

Scroll bar

A scroll bar appears on the right side of a menu screen when there are items that do not fit on the screen. Press the Up/Down arrow keys or <Page Up> / <Page Down> keys to display the other items on the screen.

General help

At the top right corner of the menu screen is a brief description of the selected item. Use <F12> key to capture the BIOS screen and save it to the removable storage device.

Configuration fields

These fields show the values for the menu items. If an item is user-configurable, you can change the value of the field opposite the item. You cannot select an item that is not user-configurable.

A configurable field is highlighted when selected. To change the value of a field, select it and press <Enter> to display a list of options.

Last Modified button

This button shows the items that you last modified and saved in BIOS Setup.

2.2.3 QFan Control

The QFan Control allows you to set a fan profile or manually configure the operating speed of your CPU and chassis fans.

Click to select a fan to be configured

Q-Fan Control

Select your target fan and then move the slider to select any of these profiles (Standard, Silent, Turbo and Full Speed). You can also move the slider to Manual and manually configure the fan's operating speed.

Optimize All
CPU FAN
CHA1 FAN
CHA2 FAN

Standard Silent Turbo Full Speed Manual

Undo Apply Exit (ESC)

Select a profile to apply to your fans

Click to undo the changes

Click to apply the fan setting

Click to go back to main menu

Configuring fans manually

Select **Manual** from the list of profiles to manually configure your fans' operating speed.

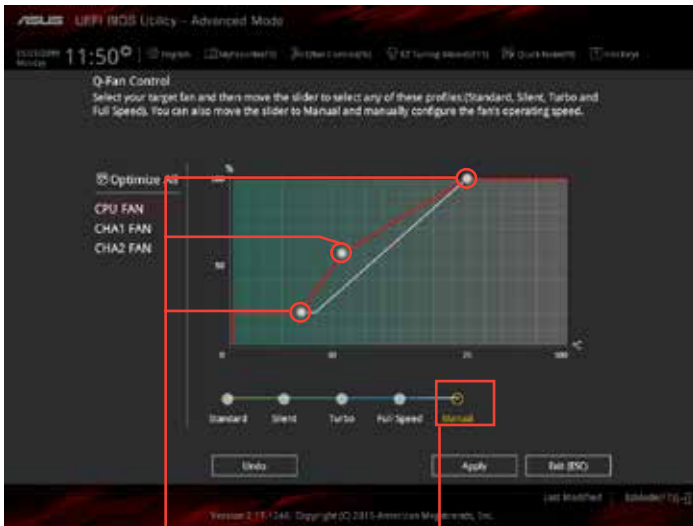

Speed points

Click to manually
configure your fans

To configure your fans:

1. Select the fan that you want to configure and to view its current status.
2. Click and drag the speed points to adjust the fans' operating speed.
3. Click **Apply** to save the changes then click **Exit (ESC)**.

2.2.4 EZ Tuning Wizard

EZ Tuning Wizard allows you to overclock your CPU and DRAM, computer usage, and CPU fan to their best settings. You can also easily set RAID in your system using this feature.

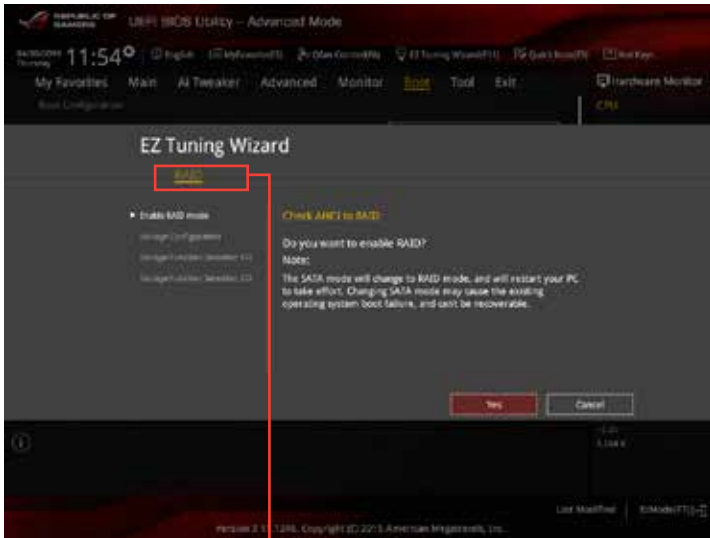

RAID setup

Tuning your system settings

To tune your settings:

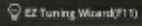
1. Press <F11> on your keyboard or click  from the BIOS screen to open EZ Tuning Wizard screen, then click **Next**.
2. Select a PC scenario **Daily Computing** or **Gaming/Media Editing**, then click **Next**.
3. Select the CPU fan type (**Box cooler**, **Tower cooler**, or **Water cooler**) that you installed then click **Next**.



If you are not sure of the CPU fan type, click **I'm not sure**. The system automatically detects the CPU fan type.

4. Click **Next** then click **Yes** to confirm auto-tuning.

Creating RAID

To create RAID:

1. Press <F11> on your keyboard or click  from the BIOS screen to open EZ Tuning Wizard screen.
2. Click **RAID** then click **Next**.



- Ensure that your HDDs have no existing RAID volumes.
- Ensure to connect your HDDs to Intel® SATA connectors.

3. Select the type of storage for your RAID **Easy Backup** or **Super Speed**, then click **Next**.

- a. For Easy Backup, click **Next** then select from **Easy Backup (RAID1)** or **Easy Backup (RAID10)**.



You can only select Easy Backup (RAID 10) if you connect four (4) HDDs.



- b. For Easy Backup, click **Next** then select from **Super Speed (RAID0)** or **Super Speed (RAID5)**.



4. After selecting the type of RAID, click **Next** then click **Yes** to continue the RAID setup.
5. After the RAID setup is done, click **Yes** to exit the setup then click **OK** to reset your system.

2.3 My Favorites

MyFavorites is your personal space where you can easily save and access your favorite BIOS items.



Adding items to My Favorites

To add BIOS items:

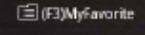
1. Press <F3> on your keyboard or click  from the BIOS screen to open Setup Tree Map screen.
2. On the Setup Tree Map screen, select the BIOS items that you want to save in MyFavorites screen.

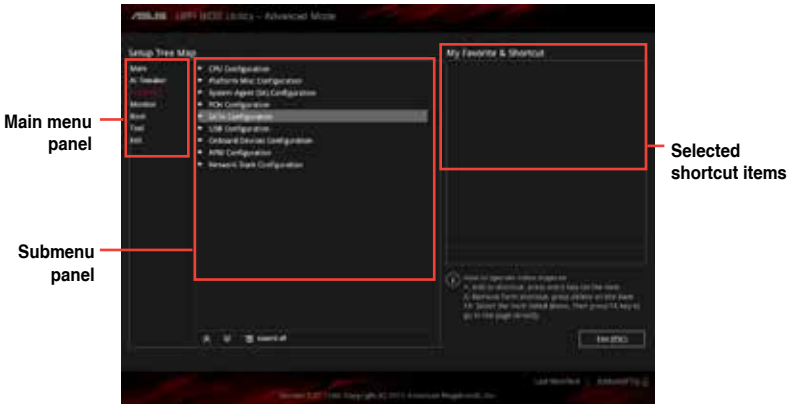

3. Select an item from main menu panel, then click the submenu that you want to save as favorite from the submenu panel and click .



You cannot add the following items to My Favorite items:

- User-managed items such as language and boot order

4. Click **Exit (ESC)** or press <esc> key to close Setup Tree Map screen.
5. Go to My Favorites menu to view the saved BIOS items.

2.4 Main menu

The Main menu screen appears when you enter the Advanced Mode of the BIOS Setup program. The Main menu provides you an overview of the basic system information, and allows you to set the system date, time, language, and security settings.

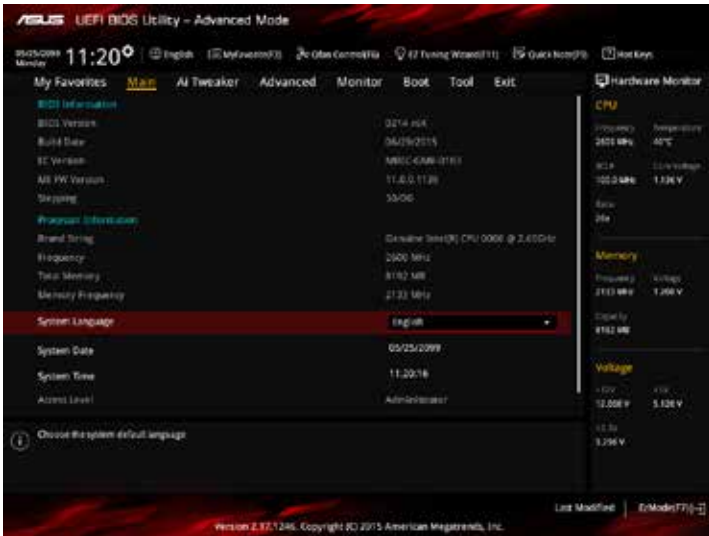

2.4.1 Language [English]

Allows you to choose the BIOS language version from the options. Configuration options: [English] [Français] [Deutsch] [简体中文] [繁體中文] [日本語] [Español] [Русский] [Korean]

2.4.2 Security

The Security menu items allow you to change the system security settings.



- If you have forgotten your BIOS password, erase the CMOS Real Time Clock (RTC) RAM to clear the BIOS password. See section 1.6 Headers and Jumpers for information on how to erase the RTC RAM.
- The **Administrator** or **User Password** items on top of the screen show the default **Not Installed**. After you set a password, these items show **Installed**.

Administrator Password

If you have set an administrator password, we recommend that you enter the administrator password for accessing the system.

To set an administrator password:

1. Select the **Administrator Password** item and press <Enter>.
2. From the **Create New Password** box, key in a password, then press <Enter>.
3. Confirm the password when prompted.

To change an administrator password:

1. Select the **Administrator Password** item and press <Enter>.
2. From the **Enter Current Password** box, key in the current password, then press <Enter>.
3. From the **Create New Password** box, key in a new password, then press <Enter>.
4. Confirm the password when prompted.

To clear the administrator password, follow the same steps as in changing an administrator password, but press <Enter> when prompted to create/confirm the password. After you clear the password, the **Administrator Password** item on top of the screen shows **Not Installed**.

User Password

If you have set a user password, you must enter the user password for accessing the system. The **User Password** item on top of the screen shows the default **Not Installed**. After you set a password, this item shows **Installed**.

To set a user password:

1. Select the **User Password** item and press <Enter>.
2. From the **Create New Password** box, key in a password, then press <Enter>.
3. Confirm the password when prompted.

To change a user password:

1. Select the **User Password** item and press <Enter>.
2. From the **Enter Current Password** box, key in the current password, then press <Enter>.
3. From the **Create New Password** box, key in a new password, then press <Enter>.
4. Confirm the password when prompted.

To clear the user password, follow the same steps as in changing a user password, but press <Enter> when prompted to create/confirm the password. After you clear the password, the **User Password** item on top of the screen shows **Not Installed**.

2.5 Ai Tweaker menu

The Ai Tweaker menu items allow you to configure overclocking-related items.



Be cautious when changing the settings of the Ai Tweaker menu items. Incorrect field values can cause the system to malfunction.



The configuration options for this section vary depending on the CPU and DIMM model you installed on the motherboard.

Scroll down to display other BIOS items.



2.5.3 CPU Core Ratio [Auto]

This item allows you to set the CPU core ratio limit per core or synchronize automatically to all cores. Configuration options: [Auto] [Sync All Cores] [Per Core]



When the CPU Core Ratio is set to **[Sync All Cores]** or **[Per Core]**, the following items appear.

1-Core Ratio Limit [Auto]

Select **[Auto]** to apply the CPU default Turbo Ratio setting or manually assign a 1-Core Limit value that must be higher than or equal to the 2-Core Ratio Limit.

2-Core Ratio Limit [Auto]

Select **[Auto]** to apply the CPU default Turbo Ratio setting or manually assign a 2-Core Limit value that must be higher than or equal to the 3-Core Ratio Limit.



If you assign a value for 2-Core Ratio Limit, do not set the 1-Core Ratio Limit to **[Auto]**.

3-Core Ratio Limit [Auto]

Select **[Auto]** to apply the CPU default Turbo Ratio setting or manually assign a 3-Core Limit value that must be higher than or equal to the 4-Core Ratio Limit.



If you assign a value for 3-Core Ratio Limit, do not set the 1-Core Ratio Limit and 2-Core Ratio Limit to **[Auto]**.

4-Core Ratio Limit [Auto]

Select **[Auto]** to apply the CPU default Turbo Ratio setting or manually assign a 4-Core Limit value that must be higher than or equal to the 3-Core Ratio Limit.



If you assign a value for 4-Core Ratio Limit, do not set the 1-Core Ratio Limit, 2-Core Ratio Limit, and 3-Core Ratio to **[Auto]**.

2.5.2 BCLK Frequency: DRAM Frequency Ratio [Auto]

Allows you to set the CPU bus speed to DRAM speed ratio mode.

[Auto] DRAM speed is set to the optimized settings.

[100:133] The BCLK frequency to DRAM speed ratio is set to 100:133.

[100:100] The BCLK frequency to DRAM speed ratio is set to 100:100.

2.5.3 DRAM Odd Ratio Mode [Enabled]

Allows you to enable or disable the Odd Ratio Mode, which provides better granularity.

Configuration options: **[Disabled]** **[Enabled]**

2.5.4 DRAM Frequency [Auto]

This item allows you to set the memory operating frequency. The configurable options vary with the BCLK (base clock) frequency setting. Select the auto mode to apply the optimized setting. Configuration options: **[DDR4-800MHz]** **[DDR4-933MHz]** **[DDR4-1066MHz]** **[DDR4-1200MHz]** **[DDR4-1333MHz]** **[DDR4-1400MHz]** **[DDR4-1500MHz]** **[DDR4-1600MHz]** **[DDR4-1700MHz]** ~ **[DDR4-2133MHz]**



Selecting a very high memory frequency may cause the system to become unstable! If this happens, revert to the default setting.

2.5.5 GPU Boost [Keep Current Settings]

GPU Boost accelerates the integrated GPU for extreme graphics performance. Configuration options: **[Keep Current Settings]** **[Enabled]**

2.5.6 EPU Power Saving Mode [Disabled]

ASUS EPU (Energy Processing Unit) sets the CPU in its minimum power consumption settings. Enable this item to set lower CPU VCCIN and Vcore voltages and achieve the best energy saving condition. Configuration options: **[Disabled]** **[Enabled]**

2.5.7 CPU SVID Support [Auto]

Disabling SVID Support stops the processor from communicating with the external voltage regulator. Configuration options: [Auto] [Disabled] [Enabled]

2.5.8 DRAM Timing Control

The subitems in this menu allow you to set the DRAM timing control features. Use the <+> and <-> keys to adjust the value. To restore the default setting, type [auto] using the keyboard and press the <Enter> key.



Changing the values in this menu may cause the system to become unstable! If this happens, revert to the default settings.

2.5.9 DIGI+ VRM

CPU Load-Line Calibration [Auto]

Load-line is defined by Intel VRM specification and affects the CPU power voltage. The CPU working voltage will decrease proportionally depending on the CPU loading. Higher levels of the load-line calibration can get a higher voltage and a better overclocking performance but increases the CPU and VRM thermal. Configuration options: [Auto] [Level 1] [Level 2] [Level 3] [Level 4] [Level 5] [Level 6] [Level 7]



The boosted performance may vary depending on the CPU specification. Do not remove the thermal module.

CPU Current Capability [Auto]

Allows you to configure the total power range, and extends the overclocking frequency range simultaneously. Configuration options: [Auto] [100%] [110%] [120%] [130%] [140%]



Choose a higher value when overclocking, or under a high CPU loading for extra power support.

CPU VRM Switching Frequency [Auto]

This item affects the VRM transient response speed and the component thermal production. Select [Manual] to configure a higher frequency for a quicker transient response speed. Configuration options: [Auto] [Manual]



DO NOT remove the thermal module. The thermal conditions should be monitored.



The following item appears only when you set the CPU VRM Switching Frequency to [Manual].

Fixed CPU VRM Switching Frequency (KHz) [300]

This item allows you to set a higher frequency for a quicker transient response speed. Use the <+> and <-> keys to adjust the value. The values range from 250KHz to 500KHz with a 50KHz interval.

VRM Spread Spectrum [Disabled]

This item allows you to enable the spread spectrum to enhance system stability.
Configuration options: [Enabled] [Disabled]

CPU Power Duty Control [T.Probe]

DIGI + VRM Duty control adjusts the current and thermal conditions of every component's phase.

[T. Probe] Select to maintain the VRM thermal balance.

[Extreme] Select to maintain the current VRM balance.

CPU Power Phase Control [Auto]

This item allows you to set the power phase control of the CPU. Configuration options: [Auto] [Standard] [Optimized] [Extreme]



DO NOT remove the thermal module when setting this item to **[Extreme]**. The thermal conditions should be monitored.

CPU Graphics Load-Line Calibration [Auto]

Load-line is defined by Intel VRM specification and affects the CPU Graphics power voltage. The CPU Graphics working voltage will decrease proportionally depending on the CPU Graphics loading. Higher levels of the load-line calibration can get a higher voltage and a better overclocking performance but increases the GT and VRM thermal. Configuration options: [Auto] [Level 1] [Level 2] [Level 3] [Level 4] [Level 5] [Level 6] [Level 7]



The boosted performance may vary depending on the CPU Graphics specification. Do not remove the thermal module.

CPU Graphics Current Capability [Auto]

Allows you to configure the total power range, and extends the overclocking frequency range simultaneously. Configuration options: [Auto] [100%] [110%] [120%] [130%] [140%]



Choose a higher value when overclocking, or under a high GT loading for extra power support.

CPU Graphics Switching Frequency [Auto]

This item affects the CPU Graphics transient response speed and the component thermal production. Select [Manual] to configure a higher frequency for a quicker transient response speed. Configuration options: [Auto] [Manual]



DO NOT remove the thermal module. The thermal conditions should be monitored.



The following item appears only when you set the CPU Graphics to **[Manual]**.

Fixed CPU Graphics Switching Frequency (KHz) [300]

This item allows you to set a higher frequency for a quicker transient response speed. Use the <+> and <-> keys to adjust the value. The values range from 250KHz to 500KHz with a 50KHz interval.

CPU Graphics Power Phase Control [Auto]

This item allows you to set the GT power phase control. Configuration options: [Auto] [Standard] [Optimized] [Extreme]



DO NOT remove the thermal module when setting this item to **[Extreme]**. The thermal conditions should be monitored.

2.5.10 Internal CPU Power Management

The subitems in this menu allow you to set the CPU ratio and features.

Intel(R) SpeedStep(tm) [Enabled]

Allows you to enable or disable the Intel® SpeedStep Technology (EIST).

[Disabled] Disables this function.

[Enabled] The operating system dynamically adjusts the processor voltage and core frequency which may result in decreased average consumption and decreased average heat production.

Turbo Mode [Enabled]

This item allows you to automatically set the CPU cores to run faster than the base operating frequency when it is below the operating power, current and temperature specification limit. Configuration options: [Enabled] [Disabled]



- Turbo Mode is only available on selected CPU models only.
- The following three items appear only when you set **Turbo Mode** to [enabled].

Turbo Mode Parameters

Long Duration Package Power Limit [Auto]

Allows you to limit the turbo ratio's long duration package power. Use the <+> and <-> keys to adjust the value.

Package Power Time Window [Auto]

Allows you to set the package power time window. Use the <+> and <-> keys to adjust the value.

Short Duration Package Power Limit [Auto]

Allows you to limit the turbo ratio's long duration power. Use the <+> and <-> keys to adjust the value.

IA/AC Load Line [Auto]

Allows you to limit the AC Loadline in 1/100 mOhms. Use <+> and <-> key to adjust the value.

IA/DC Load Line [Auto]

Allows you to limit the DC Loadline in 1/100 mOhms. Use <+> and <-> key to adjust the value.

2.5.11 CPU Core/Cache Current Limit Max. [Auto]

Allows you to configure a higher current limit to prevent a frequency or power throttling when overclocking. The values range from 0.00A to 255.50A with a 0.25A interval.

2.5.12 CPU Graphics Current Limit Max. [Auto]

Allows you to configure a higher current limit to prevent a frequency or power throttling when overclocking. The values range from 0.00A to 255.50A with a 0.25A interval.

2.5.13 Min. CPU Cache Ratio [Auto]

Allows you to configure the minimum possible CPU cache ratio. Use the <+> or <-> keys to adjust the value. The values range from 0 to 83 with a 1 interval.

2.5.14 Max. CPU Cache Ratio [Auto]

Allows you to configure the maximum possible CPU cache ratio. Use the <+> or <-> keys to adjust the value. The values range from 0 to 83 with a 1 interval.

2.5.15 Max. CPU Graphics Ratio [Auto]

Allows you to configure the maximum CPU graphics ratio. Use the <+> or <-> keys to adjust the value. The values range from 0 to 63 with a 1 interval.

2.5.16 CPU Core/Cache Voltage [Auto]

This item allows you to configure the mode of voltage fed to the CPU cores. Increase the voltage when setting a high Core Frequency value. Configuration options: [Auto] [Manual Mode] [Offset Mode] [Adaptive Mode]



- The following item appears only when you set the CPU Core Voltage to **[Manual Mode]**.
- **[Adaptive Mode]** is available for some specific CPU types.

CPU Core Voltage Override [Auto]

Allows you to set the CPU Core Voltage. Use the <+> or <-> keys to adjust the value. The values range from 0.600V to 1.700V with a 0.005V interval.



The following items appear only when you set the CPU Core/Cache Voltage to **[Offset Mode]** or **[Adaptive Mode]**.

Offset Mode Sign [+]

- [+] To offset the voltage by a positive value.
- [-] To offset the voltage by a negative value.

CPU Core Voltage Offset [Auto]

This item appears only when you set the CPU Core Voltage to [Offset Mode]. Use the <+> or <-> keys to adjust the value. The values range from -0.635V to +0.635V with a 0.005V interval.



The following items appear only when you set the CPU Core/Cache Voltage to **[Adaptive Mode]**.

Additional Turbo Mode CPU Core Voltage [Auto]

This item allows you to set the amount of voltage fed to the CPU cores when running in turbo mode. Increase the voltage when configuring a high CPU core frequency. The voltage you set is affected by the offset value. Use the <+> or <-> keys to adjust the value. The values range from 0.001V to 1.920 V with a 0.001 V interval.

Total Adaptive Mode CPU Core Voltage [Auto]

This item sums up the voltages of the CPU Core Voltage offset and Additional Turbo Mode CPU Core Voltage options.

2.5.17 DRAM Voltage [Auto]

This item allows you to set the voltage for the DRAM. Use the <+> and <-> keys to adjust the value. The values range from 1.000V to 1.800V with a 0.005V interval.

2.5.18 CPU System Agent Voltage [Auto]

This item allows you to set the voltage for the CPU System Agent. Use the <+> and <-> keys to adjust the value. The values range from 0.700V to 1.685V with a 0.005V interval.

2.5.19 CPU Graphics Voltage Mode [Auto]

This item allows you to configure the mode of voltage fed to the CPU Graphics. Increase the voltage when setting a high Core Frequency value. Configuration options: [Auto] [Manual Mode] [Offset Mode]



The following item appears only when you set the CPU Core Voltage to **[Manual Mode]**.

CPU Graphics Voltage Override [Auto]

Allows you to set the CPU Graphics Voltage. Use the <+> or <-> keys to adjust the value. The values range from 0.600V to 1.700V with a 0.005V interval.



The following items appear only when you set the CPU Graphics Voltage Mode to **[Offset Mode]**.

Offset Mode Sign [+]

- [+] To offset the voltage by a positive value.
- [-] To offset the voltage by a negative value.

CPU Graphics Voltage Offset [Auto]

Use the <+> or <-> keys to adjust the value. The values range from 0.001V to 0.635V with a 0.005V interval.

2.5.20 PCH Core Voltage [Auto]

This item allows you to set the voltage for the PCH Core. Use the <+> and <-> keys to adjust the value. The values range from 0.800V to 1.635V with a 0.005V interval.

2.5.20 CPU Standby Voltage [Auto]

This item allows you to set the voltage for the CPU Standby. Use the <+> and <-> keys to adjust the value. The values range from 0.800V to 1.635V with a 0.005V interval.

2.5.21 DRAM REF Voltage Control

The subitems in this menu allows you to set the DRAM reference voltage on the control lines from the memory bus. You can use the <+> or <-> keys to adjust the value.

2.6 Advanced menu

The Advanced menu items allow you to change the settings for the CPU and other system devices.



Be cautious when changing the settings of the Advanced menu items. Incorrect field values can cause the system to malfunction.



2.6.1 CPU Configuration

The items in this menu show the CPU-related information that the BIOS automatically detects.



The items shown in submenu may be different due to the CPU you installed.

Hyper-threading [Enabled]

The Intel Hyper-Threading Technology allows a hyper-threading processor to appear as two logical processors to the operating system, allowing the operating system to schedule two threads or processes simultaneously.

[Enabled] Two threads per activated core are enabled.

[Disabled] Only one thread per activated core is enabled.

Active Processor Cores [All]

This item allows you to select the number of CPU cores to activate in each processor package. Configuration options: [All] [1] [2] [3]



For some CPU types, only [All] and [1] appear.

Intel Virtualization Technology [Enabled]

When set to **[Enabled]**, a VMM can utilize the additional hardware capabilities provided by Vanderpool Technology. Configuration options: [Disabled] [Enabled]

Hardware Prefetcher [Enabled]

This item allows the CPU to prefetch commands and data in the L2 cache, reduces the DRAM loading time and improves the system performance. Configuration options: [Disabled] [Enabled]

Adjacent Cache Line Prefetcher [Enabled]

This item allows the mid level cache (L2) to prefetch adjacent cache lines, reducing the DRAM loading time and improves the system performance. Configuration options: [Disabled] [Enabled]

Boot Performance mode [Auto]

This item allows you to select the CPU performance state during system boot before the operating system takes control. The CPU runs at a selected performance ratio based on CPU configuration. Configuration options: [Max Battery] [Max Non-Turbo Performance] [Turbo Performance] [Auto]

CPU Power Management Configuration

This item allows you to manage and configure the CPU's power.

Intel(R) SpeedStep(tm) [Enabled]

Allows you to enable or disable the Intel® SpeedStep technology.
[Disabled] The CPU runs at its default speed.
[Enabled] The operating system controls the CPU speed.

Turbo Mode [Enabled]

This item allows you to automatically set the CPU cores to run faster than the base operating frequency when it is below the operating power, current and temperature specification limit. Configuration options: [Enabled] [Disabled]



Turbo Mode is only available on selected CPU models only.

CPU C states [Auto]

[Auto] Automatic configuration.
[Enabled] Enables the CPU C states.
[Disabled] Disables the CPU C states.



The following items appear only when you set the CPU C states to **[Enabled]**.

Enhanced C-states [Enabled]

[Enabled] Enables enhanced C1 state.
[Disabled] Disables enhanced C1 state.

CPU C3 Report [Enabled]

Allows you to disable or enable the CPU C3 report to OS. Configuration options: [Enabled] [Disabled]

CPU C6 report [Enabled]

Allows you to disable or enable the CPU C6 report to OS. Configuration options: [Enabled] [Disabled]

CPU C7 report [CPU C7s]

Allows you to disable or enable the CPU C7 report to OS. Configuration options: [Disabled] [CPU C7] [CPU C7s]

Package C State limit [Auto]

Allows you to disable or enable the whole C-State package support. Configuration options: [C0/C1] [C2] [C3] [C6] [C7] [C7s] [Auto]

CFG lock [Disabled]

This item allows you to configure the MSR 0xD2[15], CFG lock bit. Configuration options: [Disabled] [Enabled]

2.6.2 Platform Misc Configuration

The items in this menu allow you to configure the platform-related features.

PCI Express Native Power Management [Disabled]

This item allows you to enhance the power saving feature of PCI Express and perform ASPM operations in the operating system. Configuration options: [Disabled] [Enabled]



The following item appears only when you set the PCI Express Native Power Management to **[Enabled]**.

Native ASPM [Disabled]

- [Enabled] Windows® Vista OS controls the ASPM (active state power management) support for devices.
- [Disabled] BIOS controls the ASPM support for the device.

PCH - PCI Express options**DMI Link ASPM Control [Disabled]**

This item allows you to control the Active State Power Management on both NB (NorthBridge) side and SB (SouthBridge) side of the DMI Link. Configuration options: [Disabled] [Enabled]

ASPM Support [Disabled]

This item allows you to select the ASPM state for energy-saving conditions. Configuration options: [Disabled] [L0s] [L1] [L0sL1] [Auto]

SA - PCI Express options**DMI Link ASPM Control [Disabled]**

This item allows you to control the Active State Power Management on both CPU and PCH (platform controller hub) Both DMI link ASPM control items of the CPU and PCH sides must be enabled for the ASPM to take effect. Configuration options: [Disabled] [L1]

PEG - ASPM [Disabled]

This item allows you to select the ASPM state for energy-saving conditions, or use the ASUS optimized energy saving profile. Configuration options: [Disabled] [Auto] [ASPM L0s] [ASPM L1] [ASPM L0sL1]

2.6.3 System Agent (SA) Configuration

Graphics Configuration

Allows you to select a primary display from CPU, PCIE and PCI graphical devices.

Primary Display [Auto]

Allows you to select the primary display from CPU, PCIE and PCI graphics devices.

Configuration options: [Auto] [CPU Graphics] [PCIE]

iGPU Multi-Monitor [Disabled]

This item allows you to empower both integrated and discrete graphics devices for the multi-monitor output. The CPU graphics shared system memory size is fixed at 64 MB.

Configuration options: [Disabled] [Enabled]

RC6(Render Standby) [Enabled]

Allows you to enable or disable render standby support. Configuration options:

[Disabled] [Enabled]

DVMT Pre-Allocated [32M]

Allows you to select DVMT 5.0 Pre_Allocated (Fixed) Graphics Memory size used by the Internal Graphics Device. Configuration options: [32M] [64M] [96M] ~ [512M]

DMI/OPI Configuration

This item allows you to control various DMI (direct media interface) to run at PCI-E 2.0 speed.

DMI Max Link Speed [Auto]

Allows you to configure the DMI speed. Configuration options: [Auto] [Gen1] [Gen2] [Gen3]

PEG Port Configuration

Allows you to configure the PEG Port settings.

PCIEX16_1 Link Speed [Auto]

Allows you to configure the PCIEx16 speed for slot 1. Configuration options: [Auto]

[Gen1] [Gen2] [Gen3]

PCIEX16_2 Link Speed [Auto]

Allows you to configure the PCIEx16 speed for slot 2. Configuration options: [Auto]

[Gen1] [Gen2] [Gen3]

Memory Configuration

Allows you to configure the memory configuration parameters.

Memory Remap [Enabled]

Allows you to enable or disable memory remap above 4GB. Configuration options:

[Enabled] [Disabled]

2.6.4 PCH Configuration

This item allows you to configure the PCI Express configuration settings.

PCI Express Configuration

PCIe Speed [Auto]

Allows you to configure the PCIe speed. Configuration options: [Auto] [Gen1] [Gen2] [Gen3]

2.6.5 SATA Configuration

While entering Setup, the BIOS automatically detects the presence of SATA devices. The SATA Port items show **Not Present** if no SATA device is installed to the corresponding SATA port.

Hyper kit Mode [Disabled]

[Enabled] Enables this option for ASUS Hyper kit card.

[Disabled] Disables this option for M.2 devices.

SATA Controller(s) [Enabled]

Enables or disables onboard the SATA device. Configuration options: [Disabled] [Enabled]



The following items appear only when you set SATA Controller(s) to **[Enabled]**.

SATA Mode Selection [AHCI]

Allows you to set the SATA configuration.

[AHCI] Set to [AHCI] when you want the SATA hard disk drives to use the AHCI (Advanced Host Controller Interface). The AHCI allows the onboard storage driver to enable advanced Serial ATA features that increases storage performance on random workloads by allowing the drive to internally optimize the order of commands.

[RAID] Set to [RAID Mode] when you want to create a RAID configuration from the SATA hard disk drives.



The following items appear only when you set the SATA Mode Selection to **[RAID]**.

CR#1/2/3 RST PCIe Storage Remapping [Disabled]

This item allows you to enable or disable the RST PCIe Storage Remapping feature. Configuration options: [Auto] [Disabled] [Enabled]

Alternate ID [Disabled]

This item allows you to enable or disable the report for the alternate device ID. Configuration options: [Auto] [Disabled] [Enabled]

Aggressive LPM Support [Disabled]

This item is designed for LPM (link power management) support with a better energy saving conditions. When disabled, the hot plug function of SATA ports are disabled. Configuration options: [Disabled] [Enabled]

Smart Self Test [On]

This item allows you to enable or disable the SMART Self Test on all HDDs during POST. Configuration options: [On] [Off]

SATA6G_1~6(Gray) [Enabled]

Allow you to enable/disable the SATA6G_1~6 port. Configuration options: [Enabled] [Disabled]

Hot Plug [Disabled]

These items allow you to enable/disable SATA Hot Plug Support. Configuration options: [Disabled] [Enabled]

2.6.6 USB Configuration

The items in this menu allow you to change the USB-related features.



The **USB Devices** item shows the auto-detected values. If no USB device is detected, the item shows None.

Legacy USB Support [Enabled]

- [Enabled] Your system supports the USB devices in legacy operating systems.
- [Disabled] Your USB devices can be used for BIOS setup only and cannot be recognized in the boot devices list.
- [Auto] Your system automatically detects the presence of USB devices at startup. If any USB devices are detected, the legacy USB support is enabled.

XHCI Hand-off [Disabled]

- [Enabled] Enables the support for operating systems without an XHCI hand-off feature.
- [Disabled] Disables the XHCI Hand-off support.

USB Single Port Control

Allow you to enable or disable the USB Port.

USB Port #1~14 [Enabled]

Allows you to enable or disable the USB Port 1~14 individually. Configuration options: [Enabled] [Disabled]

2.6.7 Onboard Devices Configuration

Model Name LED Lighting [Breathing Mode]

Allow you to set the model name LED mode. Configuration options: [Disabled] [Still Mode] [Breathing Mode]

HD Audio Controller [Enabled]

- [Enabled] Enables the HD Audio Device.
- [Disabled] Disables the HD Audio Device.



The following item appears only when you set the **HD Audio Controller** item to [Enabled].

Front Panel Type [HD Audio]

Allows you to set the front panel audio connector (AAFP) mode to legacy AC'97 or high-definition audio depending on the audio standard that the front panel audio module supports.

[HD Audio] Sets the front panel audio connector (AAFP) mode to high definition audio.

[AC97] Sets the front panel audio connector (AAFP) mode to legacy AC'97

Audio LED Lighting [Breathing Mode]

Allow you to configure the Audio LED Lighting. Configuration options: [Disabled] [Still Mode] [Breathing Mode] [Flowing Mode]

M.2/SATA Express Detect Mode [Auto]

Allow you to configure the M.2 and SATA Express detect mode. Configuration options: [Auto] [manual]



The following item appears only when you set **M.2/SATA Express Detect Mode** to item to [Manual].

M.2 and SATA Express SATA Mode Configuration [SATA Express]

M.2 shares SATA mode with SATA Express. Configure this item before installing M.2 SATA devices.

[M.2] SATA mode will be switched to M.2. SATA Express can only support PCIe devices.

[SATA EXpress] SATA mode will be switched to SATA Express. M.2 can only support PCIe devices.

Asmedia USB 3.1 Controller [Enabled]

Allows you to enable or disable the Asmedia USB 3.1 controller. Configuration options: [Enabled] [Disabled]



The following item appears only when you set **Asmedia USB 3.1 Controller** to [Enabled].

Asmedia USB 3.1 Battery Charging Support [Disabled]

Allows you to enable or disable Asmedia USB 3.1 battery charging support. Configuration options: [Enabled] [Disabled]

Intel LAN Controller [Enabled]

Allows you to enable or disable the GbE controller. Configuration options: [Enabled] [Disabled]



The following item appears only when you set **Intel LAN Controller** to [Enabled].

Intel PXE Option ROM [Off]

Allows you to enable or disable Intel PXE Option ROM. Configuration options: [On] [Off]

Serial Port Configuration

The sub-items in this menu allow you to set the serial port configuration.

Serial Port [On]

Allows you to enable or disable the serial port (COM). Configuration options: [On] [Off]

Change Settings [IO=3F8h; IRQ=4]

This item appears only when you set the **Serial Port** to [On] and allows you to select the Serial Port base address. Configuration options: [IO=3F8h; IRQ=4] [IO=2F8h; IRQ=3] [IO=3E8h; IRQ=4] [IO=2E8h; IRQ=3]

2.6.8 APM Configuration

ErP Ready [Disabled]

Allows BIOS to switch off some power at S5 to get the system ready for ErP requirement. When set to [Enabled (S4+S5)], all other PME options will be switched off. Configuration options: [Disabled] [Enabled (S4+S5)] [Enabled (S5)]

Deep S4 [Disabled]

When the system enters the S4 state and this item is set to [Enabled], the system will be put to deep S4 sleep state to reduce power consumption. The system in deep S4 state can only be woken up via the power button. Configuration options: [Disabled] [Enabled]

Restore AC Power Loss [Power Off]

- [Power On] The system goes into on state after an AC power loss.
- [Power Off] The system goes into off state after an AC power loss.
- [Last State] The system goes into either off or on state, whatever the system state was before the AC power loss.

Power On By PS/2 Keyboard [Disabled]

- [Disabled] Disables the Power On by a PS/2 keyboard.
- [Space Bar] Sets the Space Bar on the PS/2 keyboard to turn on the system.
- [Ctrl-Esc] Sets the Ctrl+Esc key on the PS/2 keyboard to turn on the system.
- [Power Key] Sets Power key on the PS/2 keyboard to turn on the system. This feature requires an ATX power supply that provides at least 1A on the +5VSB lead.

Power On By PCI-E [Disabled]

This item allows you to enable or disable the Wake-on-LAN function of the onboard LAN controller or other installed PCI-E LAN cards. Configuration options: [Disabled] [Enabled]

Power On By Ring [Disabled]

- [Disabled] Disables Ring to generate a wake event.
- [Enabled] Enables Ring to generate a wake event.

Power On By RTC [Disabled]

- [Disabled] Disables RTC to generate a wake event.
- [Enabled] When set to [Enabled], the items **RTC Alarm Date (Days)** and **Hour/Minute/Second** will become user-configurable with set values.

2.6.9 Network Stack Configuration

Network Stack [Disabled]

This item allows user to disable or enable the UEFI network stack. Configuration options: [Disabled] [Enabled]



The following items appear only when you set the previous item to [Enabled].

Ipv4 / Ipv6 PXE Support [Enabled]

This item allows you to enable or disable the Ipv4/Ipv6 PXE wake event. Configuration options: [Disabled] [Enabled]

2.7 Monitor menu

The Monitor menu displays the system temperature/power status, and allows you to change the fan settings.

Scroll down to display the other BIOS items.



2.7.1 CPU / Motherboard / VRM / PCH / T_Sensor / EXT_Sensor1 / EXT_Sensor2 / EXT_Sensor3 Temperature [xxx°C/xxx°F] / [Ignore]

The onboard hardware monitor automatically detects and displays the CPU, motherboard and other temperatures. Select [Ignore] if you do not wish to display the detected temperatures.

2.7.2 CPU Fan/ CPU Optional Fan / Chassis Fan 1/2/3 / Extension Fan 1/2/3 Speed [xxxx RPM]/ [Ignore]/ [N/A]

The onboard hardware monitor automatically detects and displays the CPU and chassis fan 1/2/3 speeds in rotations per minute (RPM). If the fan is not connected to the motherboard, the field shows N/A. Select **[Ignore]** if you do not wish to display the detected speed.

2.7.3 CPU Core / CPU Graphics / 3.3V / 5V / 12V / PCH Core / CPU System Agent / CPU VCCIO / DRAM / CPU Standby Voltage

The onboard hardware monitor automatically detects the voltage output through the onboard voltage regulators. Select **[Ignore]** if you do not want to detect this item.

2.7.4 Qfan Configuration

Qfan Tuning

Click **[OK]** button to detect the lowest speed and configure the minimum duty circle for each fan. Do not shut down or reset your system during the tuning progress. Configuration options: **[Ok]** **[Cancel]**

CPU Q-Fan Control **[PWM Mode]**

[Disabled] Disables the CPU Q-Fan control feature.

[PWM Mode] Enable the CPU Q-Fan control in PWM mode for 4-pin CPU fan.

CPU Fan Speed Lower Limit **[300 RPM]**

This item appears only when you enable the CPU Q-Fan Control feature and allows you to disable or set the CPU fan warning speed. Configuration options: **[Ignore]** **[200RPM]** **[300 RPM]** **[400 RPM]** **[500 RPM]** **[600RPM]**

CPU Fan Profile **[Standard]**

This item appears only when you enable the CPU Q-Fan Control feature and allows you to set the appropriate performance level of the CPU fan.

[Standard] Sets to **[Standard]** to make the CPU fan automatically adjust depending on the CPU temperature.

[Silent] Sets to **[Silent]** to minimize the fan speed for quiet CPU fan operation.

[Turbo] Sets to **[Turbo]** to achieve maximum CPU fan speed.

[Manual] Sets to **[Manual]** to assign detailed fan speed control parameters.



The following four items appear only when you set **CPU Fan Profile** to **[Manual]**.

CPU Upper Temperature **[70]**

Use the **<+>** and **<->** keys to adjust the upper limit of the CPU temperature. The values range from 25°C to 75°C.

CPU Fan Max. Duty Cycle(%) **[100]**

Use the **<+>** and **<->** keys to adjust the maximum CPU fan duty cycle. The values range from 20% to 100%. When the CPU temperature reaches the upper limit, the CPU fan will operate at the maximum duty cycle.

CPU Middle Temperature [25]

Use the <+> or <-> keys to set the value for CPU Middle Temperature. The range of the values depends on the CPU installed.

CPU Fan Middle Duty Cycle(%) [20]

Use the <+> or <-> keys to adjust the CPU fan middle duty cycle. The values range from 20% to 100%. When the CPU temperature reaches the upper limit, the CPU fan operates at the maximum duty cycle.

CPU Lower Temperature [20]

Use the <+> or <-> keys to adjust the CPU fan's lower temperature. The values range from 20°C to 75°C.

CPU Fan Min. Duty Cycle(%) [20]

Use the <+> and <-> keys to adjust the minimum CPU fan duty cycle. The values range from 20% to 100%. When the CPU temperature is under the lower limit, the CPU fan will operate at the minimum duty cycle.

2.7.5 Chassis Fan 1/2/3 Q-Fan Control [DC Mode]

| | |
|------------|--|
| [PWM mode] | Enables the chassis Q-Fan control in PWM mode for 4-pin chassis fan. |
| [DC mode] | Enables the chassis Q-Fan control in DC mode for 3-pin chassis fan. |
| [Disabled] | Disables the chassis Q-Fan control feature. |



The following items appear only when you set the **Chassis Fan 1/2/3 Q-Fan Control** to [PWM Mode] or [DC Mode].

Chassis Fan 1/2/3 Q-Fan Source [CPU]

This item controls the assigned fan according to the selected temperature source.

Configuration options: [CPU] [Motherboard] [VRM] [PCH] [T_Sensor] [EXT_Sensor1] [EXT_Sensor2] [EXT_Sensor3]

Chassis Fan 1/2/3 Speed Low Limit [300 RPM]

This item allows you to disable or set the chassis fan warning speed. Configuration options: [Ignore] [200RPM] [300 RPM] [400 RPM] [500 RPM] [600 RPM]

Chassis Fan 1/2/3 Profile [Standard]

This item allows you to set the appropriate performance level of the chassis fan.

| | |
|------------|---|
| [Standard] | Sets to [Standard] to make the chassis fan automatically adjust depending on the chassis temperature. |
| [Silent] | Sets to [Silent] to minimize the fan speed for quiet chassis fan operation. |
| [Turbo] | Sets to [Turbo] to achieve maximum chassis fan speed. |
| [Manual] | Sets to [Manual] to assign detailed fan speed control parameters. |



The following four items appear only when you set **Chassis Fan 1/2/3 Profile** to [Manual].

Chassis Fan 1/2/3 Upper Temperature [70]

Use the <+> or <-> keys to adjust the upper limit of the chassis temperature. The values range from 40°C to 75°C.

Chassis Fan 1/2/3 Max. Duty Cycle(%) [100]

Use the <+> or <-> keys to adjust the maximum chassis fan duty cycle. The values range from 60% to 100%. When the chassis temperature reaches the upper limit, the chassis fan will operate at the maximum duty cycle.

Chassis Fan 1/2/3 Middle Temperature [45]

Use the <+> or <-> keys to set the value for chassis fan middle temperature.

Chassis Fan 1/2/3 Middle Duty Cycle(%) [60]

Use the <+> or <-> keys to adjust the chassis fan middle duty cycle. The values range from 60% to 100%.

Chassis Fan 1/2/3 Lower Temperature [40]

Use the <+> or <-> keys to adjust the chassis fans' lower temperature. The values range from 40°C to 75°C.

Chassis Fan 1/2/3 Min. Duty Cycle(%) [60]

Use the <+> or <-> keys to adjust the minimum chassis fan duty cycle. The values range from 60% to 100%. When the CPU temperature is under the lower limit, the chassis fan operates at the minimum duty cycle.

Allow Fan Stop [Disabled]

This function allows the fan to run at 0% duty cycle when the temperature of the source is dropped below the lower temperature. Configuration options: [Disabled] [Enabled]

2.7.6 Extension Fan 1/2/3 Q-Fan Control [DC Mode]

- [PWM mode] Enables the extension Q-Fan control in PWM mode for 4-pin chassis fan.
- [DC mode] Enables the extension Q-Fan control in DC mode for 3-pin chassis fan.
- [Disabled] Disables the extension Q-Fan control feature.



The following items appear only when you set the Extension Fan 1/2/3 Q-Fan Control to **[PWM Mode]** or **[DC Mode]**.

Extension Fan 1/2/3 Q-Fan Source [CPU]

This item controls the assigned fan according to the selected temperature source. Configuration options: [CPU] [MotherBoard] [VRM] [PCH] [T_Sensor] [EXT_Sensor1] [EXT_Sensor2] [EXT_Sensor3]

Extension Fan 1/2/3 Speed Low Limit [300 RPM]

This item allows you to disable or set the extension fan warning speed. Configuration options: [Ignore] [200RPM] [300 RPM] [400 RPM] [500 RPM] [600 RPM]

Extension Fan 1/2/3 Profile [Standard]

This item allows you to set the appropriate performance level of the extension fan.

- [Standard] Sets to [Standard] to make the extension fan automatically adjust depending on the chassis temperature.
- [Silent] Sets to [Silent] to minimize the fan speed for quiet extension fan operation.
- [Turbo] Sets to [Turbo] to achieve maximum extension fan speed.
- [Manual] Sets to [Manual] to assign detailed fan speed control parameters.



The following items appear only when you set **Extension Fan 1/2/3 Profile** to [Manual].

Extension Fan 1/2/3 Upper Temperature [70]

Use the <+> or <-> keys to adjust the upper limit of the extension fan temperature. The values range from 20°C to 75°C.

Extension Fan 1/2/3 Max. Duty Cycle(%) [100]

Use the <+> or <-> keys to adjust the maximum extension fan duty cycle. The values range from 60% to 100%. When the chassis temperature reaches the upper limit, the extension fan will operate at the maximum duty cycle.

Extension Fan 1/2/3 Middle Temperature [45]

Use the <+> or <-> keys to set the value for Extension Fan Middle Temperature.

Extension Fan 1/2/3 Middle Duty Cycle(%) [60]

Use the <+> or <-> keys to adjust the extension fan middle duty cycle. The values range from 60% to 100%.

Extension Fan 1/2/3 Lower Temperature [40]

Use the <+> or <-> keys to adjust the extension fans' lower temperature. The values range from 0°C to 75°C.

Extension Fan 1/2/3 Min. Duty Cycle(%) [60]

Use the <+> or <-> keys to adjust the minimum extension fan duty cycle. The values range from 60% to 100%. When the CPU temperature is under the lower limit, the extension fan operates at the minimum duty cycle.

Allow Fan Stop [Disabled]

This function allows the fan to run at 0% duty cycle when the temperature of the source is dropped below the lower temperature. Configuration options: [Disabled] [Enabled]

2.7.6 Anti Surge Support [On]

This item allows you to enable or disable the Anti Surge function.

Configuration options: [On] [Off]

2.8 Boot menu

The Boot menu items allow you to change the system boot options. Scroll down to display the other BIOS items.

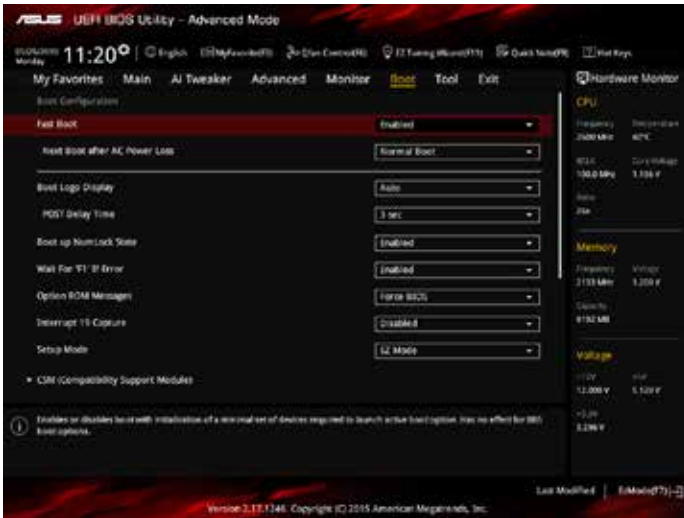

Fast Boot [Enabled]

- [Enabled] Select to accelerate the boot speed.
- [Disabled] Select to go back to normal boot speed.

Next Boot after AC Power Loss [Normal Boot]

- [Normal Boot] Returns to normal boot on the next boot after AC power loss.
- [Fast Boot] Accelerates the boot speed on the next boot after AC power loss.

Boot Logo Display [Auto]

- [Auto] Adjusts logo automatically based on Windows® display requirements.
- [Full Screen] Maximize the boot logo size.
- [Disabled] Hide the logo during POST.

POST Delay Time [3 sec]

This item appears only when you set Boot Logo Display to [Auto] and [Full Screen]. This item allows you to select the desired additional POST waiting time to easily enter the BIOS setup. You can only execute the POST delay time during Normal Boot. The values range from 0 to 10 seconds.



This feature will only work under normal boot.

Post Report [5 sec]

This item appears only when you set Boot Logo Display to [Disabled]. This item allows you to select a desired post report waiting time. Configuration options: [1 sec] ~ [10 sec] [Until Press ESC].

Bootup NumLock State [Enabled]

This item allows you to enable or disable power-on state of the NumLock. Configuration options: [Disabled] [Enabled]

Wait for 'F1' If Error [Enabled]

When this item is set to [Enabled], the system waits for the F1 key to be pressed when error occurs. Configuration options: [Disabled] [Enabled]

Option ROM Messages [Force BIOS]

- [Force BIOS] The third-party ROM messages will be displayed during POST.
- [Keep Current] Disables the ROM messages and displays only the ASUS logo during POST.

Interrupt 19 Capture [Disabled]

This item allows you to trap Interrupt 19 by the option ROMs. Configuration options: [Disabled] [Enabled]

Setup Mode [EZ Mode]

- [Advanced Mode] This item allows you to go to Advanced Mode of the BIOS after POST.
- [EZ Mode] This item allows you to go to EZ Mode of the BIOS after POST.

CSM (Compatibility Support Module)

Allows you to configure the CSM (Compatibility Support Module) items to fully support the various VGA, bootable devices and add-on devices for better compatibility.

Launch CSM [Enabled]

- [Auto] The system automatically detects the bootable devices and the add-on devices.
- [Enabled] For better compatibility, enable the CSM to fully support the non-UEFI driver add-on devices or the Windows® UEFI mode.
- [Disabled] Disable the CSM to fully support the Windows® Security Update and Security Boot.



The following four items appear when you set Launch CSM to [Enabled].

Boot Device Control [UEFI and Legacy OPROM]

Allows you to select the type of devices that you want to boot up. Configuration options: [UEFI and Legacy OPROM] [Legacy OPROM only] [UEFI only]

Boot from Network Devices [Ignore]

Allows you to select the type of network devices that you want to launch. Configuration options: [Ignore] [Legacy only] [UEFI driver first]

Boot from Storage Devices [Legacy only]

Allows you to select the type of storage devices that you want to launch. Configuration options: [Ignore] [Legacy only] [UEFI driver first]

Boot from PCIe/PCI Expansion Devices [Legacy only]

Allows you to select the type of PCIe/PCI expansion devices that you want to launch. Configuration options: [Legacy only] [UEFI driver first]

Secure Boot

Allows you to configure the Windows® Secure Boot settings and manage its keys to protect the system from unauthorized access and malwares during POST.

OS Type [Windows UEFI mode]

Allows you to select your installed operating system.

[Windows UEFI mode] This item allows you to select your installed operating system. Execute the Microsoft® Secure Boot check. Only select this option when booting on Windows® UEFI mode or other Microsoft® Secure Boot compliant OS.

[Other OS] Get the optimized function when booting on Windows® non-UEFI mode. Microsoft® Secure Boot only supports Windows® UEFI mode.

Key Management

This allows you to manage the Secure Boot keys.

Key Management

This allows you to manage the Secure Boot keys.

Install Default Secure Boot keys

This item allows you to clear all default Secure Boot keys.

Save Secure Boot Keys

This item allows you to save the PK (Platform Keys) to a USB storage device.

PK Management

The Platform Key (PK) locks and secures the firmware from any non-permissible changes. The system verifies the PK before your system enters the OS.

Set New Key

This item allows you to load the downloaded PK from a USB storage device.



The PK file must be formatted as a UEFI variable structure with time-based authenticated variable.

Delete Key

This item allows you to delete the PK from your system. Once the PK is deleted, all the system's Secure Boot keys will not be active.



The PK file must be formatted as a public key certificate or UEFI variable structure with time-based authenticated variable.

KEK Management

The KEK (Key-exchange Key or Key Enrollment Key) manages the Signature database (db) and Revoked Signature database (dbx).



Key-exchange Key (KEK) refers to Microsoft® Secure Boot Key-Enrollment Key (KEK).

Set New Key

Allows you to load the downloaded KEK from a USB storage device.

Append Key

Allows you to load the additional KEK from a storage device for an additional db and dbx loaded management.



The KEK file must be formatted as a public key certificate or UEFI variable structure with time-based authenticated variable.

Delete key

Allows you to delete the Key from your system. Configuration options: [Yes] [No]

DB Management

The db (Authorized Signature database) lists the signers or images of UEFI applications, operating system loaders, and UEFI drivers that you can load on the single computer.

Set New Key

Allows you to load the downloaded db from a USB storage device.

Append Key

Allows you to load the additional DB from a storage device for an additional db and dbx loaded management.



The KEK file must be formatted as a public key certificate or UEFI variable structure with time-based authenticated variable.

Delete key

Allows you to delete the Key from your system. Configuration options: [Yes] [No]

DBX Management

The DBX (Revoked Signature database) lists the forbidden images of db items that are no longer trusted and cannot be loaded.

Set New Key

Allows you to load the downloaded dbx from a USB storage device.

Append Key

Allows you to load the additional DBX from a storage device for an additional db and dbx loaded management.



The KEK file must be formatted as a public key certificate or UEFI variable structure with time-based authenticated variable.

Delete key

Allows you to delete the Key from your system. Configuration options: [Yes] [No]

2.8.11 Boot Option Priorities

These items specify the boot device priority sequence from the available devices. The number of device items that appears on the screen depends on the number of devices installed in the system.



-
- To access Windows® OS in Safe Mode, press <F8 > after POST (Windows® 8 not supported).
 - To select the boot device during system startup, press <F8> when ASUS Logo appears.
-

2.8.12 Boot Override

These items displays the available devices. The number of device items that appears on the screen depends on the number of devices installed in the system. Click an item to start booting from the selected device.

2.9 Tool menu

The Tool menu items allow you to configure options for special functions. Select an item then press <Enter> to display the submenu.

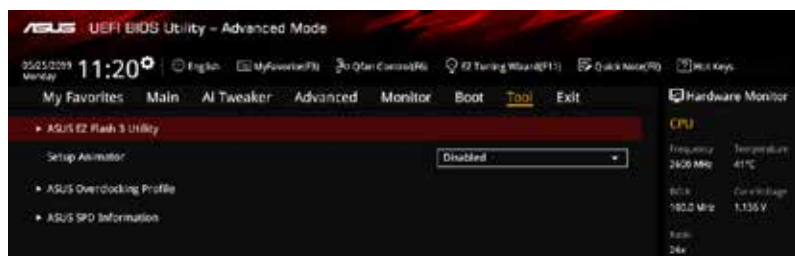

2.9.1 ASUS EZ Flash 3 Utility

Allows you to run ASUS EZ Flash 3. Press [Enter] to launch the ASUS EZ Flash 3 screen.



For more details, see section 2.1.2 **ASUS EZ Flash 3**.

2.9.2 Setup Animator [Disabled]

Enables or disables the Setup animator. Configuration options: [Disabled] [Enabled]

2.9.3 ASUS Overclocking Profile

This item allows you to store or load multiple BIOS settings.



The **Overclocking Profile** items show **Not assigned** if no profile is created.

Load from Profile

Allows you to load the previous BIOS settings saved in the BIOS Flash. Key in the profile number that saved your CMOS settings, press <Enter>, and then select Yes.



- DO NOT shut down or reset the system while updating the BIOS to prevent the system boot failure!
 - We recommend that you update the BIOS file only coming from the same memory/CPU configuration and BIOS version.
-

Profile Name

Allows you to create a name for the profile you want to save.

Save to Profile

Allows you to save the current BIOS settings to the BIOS Flash, and create a profile. Key in a profile number from one to eight, press <Enter>, and then select Yes.

Load/Save Profile from/to USB Drive

This item allows you to load or save profile from your USB drive, load and save profile to your USB drive.

2.9.4 ASUS SPD Information

DIMM Slot number [DIMM_A1]

Displays the Serial Presence Detect (SPD) information of the DIMM module installed on the selected slot. Configuration options: [DIMM_A1] [DIMM_A2] [DIMM_B1] [DIMM_B2]

2.10 Exit menu

The Exit menu items allow you to load the optimal default values for the BIOS items, and save or discard your changes to the BIOS items.

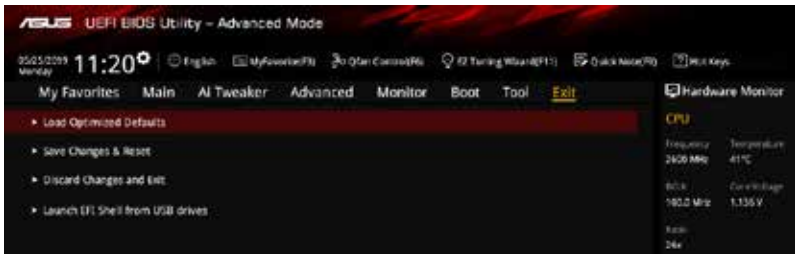

Load Optimized Defaults

This option allows you to load the default values for each of the parameters on the Setup menus. When you select this option or if you press <F5>, a confirmation window appears. Select OK to load the default values.

Save Changes & Reset

Once you are finished making your selections, choose this option from the Exit menu to ensure the values you selected are saved. When you select this option or if you press <F10>, a confirmation window appears. Select OK to save changes and exit.

Discard Changes & Exit

This option allows you to exit the Setup program without saving your changes. When you select this option or if you press <Esc>, a confirmation window appears. Select OK to discard changes and exit.

Launch EFI Shell from USB drives

This option allows you to attempt to launch the EFI Shell application (shellx64.efi) from one of the available USB devices.

2.11 Installing an operating system



Motherboard settings and hardware options vary. The setup procedures presented in this chapter are for reference only. Refer to Windows® operating system documentation for detailed information.

2.11.1 Windows® 7 and USB 3.0 driver for 100 Series

Based on the chipset specification, the 100 series requires USB 3.0 drivers to be preloaded in order to use USB keyboard/mouse during Windows® 7 installation. This section is a guide on preloading USB 3.0 drivers and installing Windows® 7.

Method 1: Using SATA ODD & USB devices

Load USB 3.0 drivers using the ASUS support DVD and install Windows® 7 using a USB device.

Requirement:

- 1 x ASUS support DVD
- 1 x Windows® 7 installation source
- 1 x SATA ODD
- 1 x USB device (ODD or storage)



The USB storage device requires 8 GB or more capacity. It is recommended to format the storage device before use.

1. Insert the Windows® 7 installation DVD into a USB ODD, or copy all files on the Windows® 7 installation DVD to a USB storage device on a working system.
2. Connect the USB ODD or USB storage device to your 100 series platform.
3. Insert the ASUS support DVD into a SATA ODD on your 100 series platform.
4. Power on your system and press F8 during POST (Power-On Self Test) to enter the boot screen.

5. Select the USB ODD or USB storage device as the boot device.

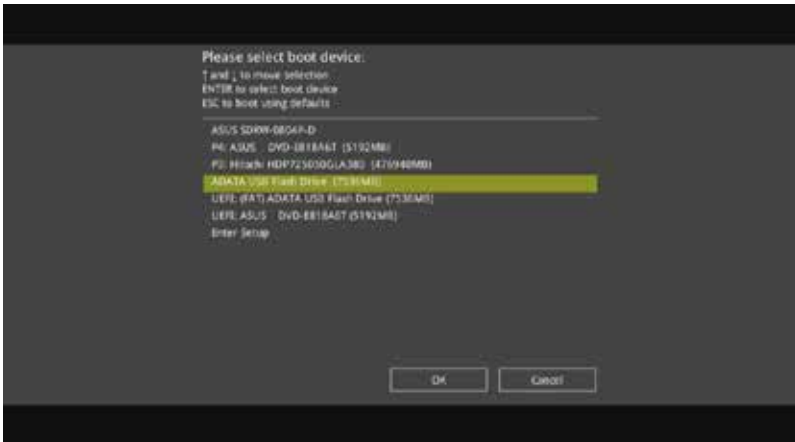

6. The USB 3.0 driver will be loaded automatically during installation startup.



The "Setup is starting..." screen will show up if the USB 3.0 driver is loaded correctly.

7. Follow the onscreen instructions to complete the Windows® 7 installation.

Method 2: Using a modified Windows® 7 ISO

Load USB 3.0 drivers and install Windows® 7 using a modified Windows® 7 installation DVD.

Requirement:

- 1 x ASUS support DVD
- 1 x Windows® 7 installation source
- 1 x Working system (PC or notebook)
- 1 x SATA ODD

1. On your working system, create an ISO image file of the Windows® 7 installation source using a third-party ISO software.
2. Copy both “Auto_Unattend.xml” and “Auto_Unattend” folder from the root directory of the ASUS supporting DVD to your system.
3. Edit the ISO file and add both “Auto_Unattend.xml” and “Auto_Unattend” folder into the ISO file.
4. Burn this ISO file onto an empty DVD to create a modified Windows® 7 installation DVD.
5. Insert the modified Windows® 7 installation DVD into an ODD on your 100 series platform.
6. Power on your system and press F8 during POST (Power-On Self Test) to enter the boot screen.
7. Select the ODD as the boot device.
8. The USB 3.0 driver will be loaded automatically during installation startup.



The “Setup is starting...” screen will show up if the USB 3.0 driver is loaded correctly.

9. Follow the onscreen instructions to complete the Windows® 7 installation.

Method 3: Using ASUS EZ Installer

Use the ASUS EZ Installer to create a modified Windows® 7 installation source.

Requirement:

- 1 x ASUS support DVD
 - 1 x Windows® 7 installation DVD
 - 1 x Working system (PC or notebook)
 - 1 x SATA ODD
 - 1 x USB storage device (8 GB or more)
1. Insert the Windows® 7 installation DVD.
 2. Launch the ASUS EZ Installer located on the ASUS support DVD.
 3. Select a method of creating a modified Windows® 7 installation file:
 - Windows® 7 OS disk to USB storage device
 - Select **Windows 7 OS disk to USB storage device** then click **Next**.



- Check **I agree** and then click **Next**.



- Select the source of the Windows® 7 installation disk then click **Next**.



- Select the USB storage device and click **next**.



Click the refresh icon  if the USB storage device is not displayed.

- Click **Yes** to clear the contents on the USB storage device and create a bootable USB device.



Make sure to backup contents on the USB storage device, as it will be formatted.

- Once completed, click **OK** to finish.

- Windows® 7 OS disk to ISO file
 - Select **Windows 7 OS disk to ISO file** then click **Next**.



- Check **I agree** and then click **Next**.

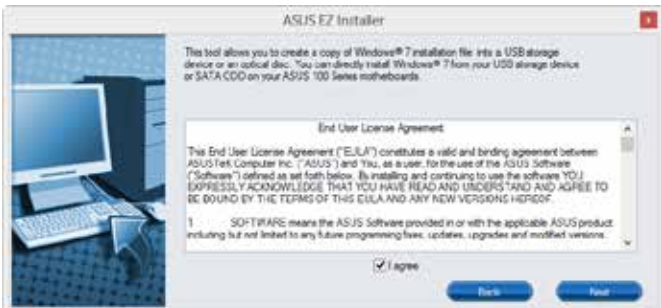

- Select the source of the Windows® 7 installation disk then click **Next**.



- Select the folder to save the modified Windows® 7 installation ISO file and click **Next**.



- Once completed, click OK to finish.
 - Burn this ISO file onto an empty DVD to create a modified Windows® 7 installation DVD.
4. Insert the modified Windows® 7 installation DVD into an ODD or connect the USB storage device with modified Windows® 7 installation files onto your 100 series platform.
 5. Power on your system and press F8 during POST (Power-On Self Test) to enter the boot screen.
 6. Select the ODD or USB storage device as the boot device.
 7. The USB 3.0 driver will be loaded automatically during installation startup.



The "Setup is starting..." screen will show up if the USB 3.0 driver is loaded correctly.

8. Follow the onscreen instructions to complete the Windows® 7 installation.

Appendices

Notices

Federal Communications Commission Statement

This device complies with Part 15 of the FCC Rules. Operation is subject to the following two conditions:

- This device may not cause harmful interference.
- This device must accept any interference received including interference that may cause undesired operation.

This equipment has been tested and found to comply with the limits for a Class B digital device, pursuant to Part 15 of the FCC Rules. These limits are designed to provide reasonable protection against harmful interference in a residential installation. This equipment generates, uses and can radiate radio frequency energy and, if not installed and used in accordance with manufacturer's instructions, may cause harmful interference to radio communications. However, there is no guarantee that interference will not occur in a particular installation. If this equipment does cause harmful interference to radio or television reception, which can be determined by turning the equipment off and on, the user is encouraged to try to correct the interference by one or more of the following measures:

- Reorient or relocate the receiving antenna.
- Increase the separation between the equipment and receiver.
- Connect the equipment to an outlet on a circuit different from that to which the receiver is connected.
- Consult the dealer or an experienced radio/TV technician for help.



The use of shielded cables for connection of the monitor to the graphics card is required to assure compliance with FCC regulations. Changes or modifications to this unit not expressly approved by the party responsible for compliance could void the user's authority to operate this equipment.

IC: Canadian Compliance Statement

Complies with the Canadian ICES-003 Class B specifications. This device complies with RSS 210 of Industry Canada. This Class B device meets all the requirements of the Canadian interference-causing equipment regulations.

This device complies with Industry Canada license exempt RSS standard(s). Operation is subject to the following two conditions: (1) this device may not cause interference, and (2) this device must accept any interference, including interference that may cause undesired operation of the device.

Cet appareil numérique de la Classe B est conforme à la norme NMB-003 du Canada.

Cet appareil numérique de la Classe B respecte toutes les exigences du Règlement sur le matériel brouilleur du Canada.

Cet appareil est conforme aux normes CNR exemptes de licence d'Industrie Canada. Le fonctionnement est soumis aux deux conditions suivantes :

- (1) cet appareil ne doit pas provoquer d'interférences et
- (2) cet appareil doit accepter toute interférence, y compris celles susceptibles de provoquer un fonctionnement non souhaité de l'appareil.

Canadian Department of Communications Statement

This digital apparatus does not exceed the Class B limits for radio noise emissions from digital apparatus set out in the Radio Interference Regulations of the Canadian Department of Communications.

This class B digital apparatus complies with Canadian ICES-003.

VCCI: Japan Compliance Statement

VCCI Class B Statement

この装置は、クラスB 情報技術装置です。この装置は、家庭環境で使用することを目的としていますが、この装置がラジオやテレビジョン受信機に近接して使用されると、受信障害を引き起こすことがあります。

取扱説明書に従って正しい取り扱いをして下さい。

V C C I - B

This is a Class B product based on the standard of the VCCI Council. If this is used near a radio or television receiver in a domestic environment, it may cause radio interference. Install and use the equipment according to the instruction manual.

KC: Korea Warning Statement

B급 기기 (가정용 방송통신기자재)

이 기기는 가정용(B급) 전자파적합기기로서 주로 가정에서 사용하는 것을 목적으로 하며, 모든 지역에서 사용할 수 있습니다.

*당해 무선설비는 전파혼신 가능성이 있으므로 인명안전과 관련된 서비스는 할 수 없습니다.

REACH

Complying with the REACH (Registration, Evaluation, Authorisation, and Restriction of Chemicals) regulatory framework, we published the chemical substances in our products at ASUS REACH website at <http://csr.asus.com/english/REACH.htm>.



DO NOT throw the motherboard in municipal waste. This product has been designed to enable proper reuse of parts and recycling. This symbol of the crossed out wheeled bin indicates that the product (electrical and electronic equipment) should not be placed in municipal waste. Check local regulations for disposal of electronic products.



DO NOT throw the mercury-containing button cell battery in municipal waste. This symbol of the crossed out wheeled bin indicates that the battery should not be placed in municipal waste.

ASUS Recycling/Takeback Services

ASUS recycling and takeback programs come from our commitment to the highest standards for protecting our environment. We believe in providing solutions for you to be able to responsibly recycle our products, batteries, other components as well as the packaging materials. Please go to <http://csr.asus.com/english/Takeback.htm> for detailed recycling information in different regions.

Google™ License Terms

Copyright© 2014 Google Inc. All Rights Reserved.

Licensed under the Apache License, Version 2.0 (the "License"); you may not use this file except in compliance with the License. You may obtain a copy of the License at:

<http://www.apache.org/licenses/LICENSE-2.0>

Unless required by applicable law or agreed to in writing, software distributed under the License is distributed on an "AS IS" BASIS, WITHOUT WARRANTIES OR CONDITIONS OF ANY KIND, either express or implied.

See the License for the specific language governing permissions and limitations under the License.

English AsusTek Inc. hereby declares that this device is in compliance with the essential requirements and other relevant provisions of CE Directives. Please see the CE Declaration of Conformity for more details.

Français AsusTek Inc. déclare par la présente que cet appareil est conforme aux critères essentiels et autres clauses pertinentes des directives européennes. Veuillez consulter la déclaration de conformité CE pour plus d'informations.

Deutsch AsusTek Inc. erklärt hiermit, dass dieses Gerät mit den wesentlichen Anforderungen und anderen relevanten Bestimmungen der CE-Richtlinien übereinstimmt. Weitere Einzelheiten entnehmen Sie bitte der CE-Konformitätserklärung.

Italiano AsusTek Inc. con la presente dichiara che questo dispositivo è conforme ai requisiti essenziali e alle altre disposizioni pertinenti alle direttive CE. Per maggiori informazioni fate riferimento alla dichiarazione di conformità CE.

Компания ASUS заявляет, что это устройство соответствует основным требованиям и другим соответствующим условиям европейских директив. Подробную информацию, пожалуйста, смотрите в декларации соответствия.

Български Настоящото AsusTek Inc. декларира, че това устройство е в съответствие със съществениите изисквания и другите приложения на постановленията на директивите CE. Вижте CE декларацията за съвместимост за повече информация.

Hrvatski AsusTek Inc. ovim izjavljuje da je ovaj uređaj skladan s bitnim zahtjevima i ostalim odgovarajućim odredbama CE direktiva. Više pojedinosti potražite u CE izjavi o skladnosti.

Čeština Společnost AsusTek Inc. tímto prohlašuje, že toto zařízení splňuje základní požadavky a další příslušná ustanovení směrnice CE. Další podrobnosti viz Prohlášení o shodě CE.

Dansk AsusTek Inc. Erklærer hermed, at denne enhed er i overensstemmelse med hovedkravene and andre relevante bestemmelser i CE-direktiverne. Du kan læse mere i CE-overensstemmelseserklæring.

Nederlands AsusTek Inc. verklaart hierbij dat dit apparaat compatibel is met de essentiële vereisten en andere relevante bepalingen van CE-richtlijnen. Raadpleeg de CE-verklaring van conformiteit voor meer details.

Eesti Käesolevaga kinnitab AsusTek Inc., et see seade vastab CE direktiivide olulistele nõuetele ja teistele asjakohastele sätetele. Vt üksikasju CE vastavusdeklaratsioonis.

Suomi AsusTek Inc. vakuuttaa täten, että tämä laite on CE-direktiivien olennaisten vaatimusten ja muiden asiaan kuuluvien lisäysten mukainen. Katso lisätietoja CE-vaatimustenmukaisuusvakuutuksesta.

Ελληνικά Με το παρόν, η AsusTek Inc. δηλώνει ότι αυτή η συσκευή συμμορφώνεται με τις θεμελιώδεις απαιτήσεις και άλλες ουσιαστικές διατάξεις των Οδηγιών της ΕΕ. Για περισσότερες λεπτομέρειες ανατρέξτε στην Δήλωση Συμμόρφωσης ΕΕ.

Magyar Az AsusTek Inc. ezennel kijelenti, hogy a készülék megfelel a CE-irányelvek alapvető követelményeinek és ide vonatkozó egyéb rendelkezéseinek. További részletekért tekintse meg a CE-megfelelőségi nyilatkozatot.

Latviski Līdz ar šo AsusTek Inc. paziņo, ka šī ierīce atbilst būtiskajām prasībām un citiem saistošajiem nosacījumiem, kas norādīti CE direktīvā. Lai uzzinātu vairāk, skatiet CE Atbilstības deklarāciju.

Lietuvių Šiuo dokumentu bendrovė „AsusTek Inc.“ pareiškia, kad šis įrenginys atitinka pagrindinius CE direktyvų reikalavimus ir kitas susijusias nuostatas. Daugiau informacijos rasite CE atitikties deklaracijoje.

Norsk AsusTek Inc. erklærer herved at denne enheten er i samsvar med hovedsaklige krav og andre relevante forskrifter i CE-direktiver. Du finner mer informasjon i CE-samsvarserklæringen.

Polski Niniejszym AsusTek Inc. deklaruje, że urządzenie jest zgodne z istotnymi wymaganiami oraz innymi powiązanymi zaleceniami Dyrektywy CE. W celu uzyskania szczegółów, sprawdź Deklarację zgodności CE.

Português A AsusTek Inc. declara que este dispositivo está em conformidade com os requisitos essenciais e outras disposições relevantes das Diretivas da CE. Para mais detalhes, consulte a Declaração de Conformidade CE.

Română Prin prezenta, AsusTek Inc. declară faptul că acest dispozitiv respectă cerințele esențiale și alte prevederi relevante ale directivelor CE. Pentru mai multe detalii, consultați declarația de conformitate CE.

Srpski AsusTek Inc. ovim izjavljuje da je ovaj uređaj u saglasnosti sa ključnim zahtjevima i drugim relevantnim odredbama CE Direktiva. Molimo vas, pogledajte CE Deklaraciju u skladnosti za više detalja.

Slovensky Spoločnosť AsusTek Inc. týmto prehlasuje, že toto zariadenie vyhovuje príslušným požiadavkám a ďalším súvisiacim ustanoveniam smerníc ES. Viac podrobností si pozrite v prehlásení o zhode ES.

Slovenščina AsusTek Inc. tukaj izjavlja, da je ta naprava skladna s temeljnimi zahtevami in drugimi relevantnimi določili direktiv CE. Za več informacij glejte izjavo CE o skladnosti.

Español Por la presente, AsusTek Inc. declara que este dispositivo cumple los requisitos básicos y otras disposiciones relevantes de las directivas de la CE. Consulte la Declaración de conformidad de la CE para obtener más detalles.

Svenska AsusTek Inc. förklarar härmed att denna enhet är i överensstämmelse med de grundläggande kraven och andra relevanta bestämmelser i CE-direktiven. Se CE-försäkran om överensstämmelse för mer information.

Українська AsusTek Inc. заявляє, що цей пристрій відповідає основним вимогам відповідних Директив ЄС. Будь ласка, див. більше подробиць у Декларації відповідності нормам ЄС.

Türkçe AsusTek Inc., bu aygıtın temel gereksinimlerle ve CE Yönergelerinin diğer ilgili koşullarıyla uyumlu olduğunu beyan eder. Daha fazla ayrıntı için lütfen CE Uygunluk Beyanına bakın.

Bosanski AsusTek Inc. ovim potvrđuje da je ovaj uređaj uskladen s osnovnim zahtjevima i drugim relevantnim propisima Direktiva EK. Za više informacija molimo pogledajte Deklaraciju o uskladenosti EK.

ASUS contact information

ASUSTeK COMPUTER INC.

Address 15 Li-Te Road, Peitou, Taipei, Taiwan 11259
Telephone +886-2-2894-3447
Fax +886-2-2890-7798
E-mail info@asus.com.tw
Web site <http://www.asus.com>

Technical Support

Telephone +86-21-3842-9911
Fax +86-21-5866-8722 ext. 9101#
Online support <http://support.asus.com/techserv/techserv.aspx>

ASUS COMPUTER INTERNATIONAL (America)

Address 800 Corporate Way, Fremont, CA 94539, USA
Telephone +1-510-739-3777
Fax +1-510-608-4555
Web site <http://www.asus.com/us/>

Technical Support

Support fax +1-812-284-0883
General support +1-812-282-2787
Online support <http://www.service.asus.com/>

ASUS COMPUTER GmbH (Germany and Austria)

Address Harkort Str. 21-23, D-40880 Ratingen, Germany
Fax +49-2102-959931
Web site <http://www.asus.com/de>
Online contact <http://eu-rma.asus.com/sales>

Technical Support

Telephone +49-2102-5789555
Support Fax +49-2102-959911
Online support <http://www.asus.com/de/support/>

DECLARATION OF CONFORMITY

Per FCC part 2 Section 2.1077(a)



Responsible Party Name: Asus Computer International

Address: 800 Corporate Way, Fremont, CA 94539.

Phone/Fax No: (510)739-3777/(510)608-4555

hereby declares that the product

Product Name : Motherboard

Model Number : H170 PRO GAMING

Conforms to the following specifications:

- FCC Part 15, Subpart B, Unintentional Radiators

Supplementary Information:

This device complies with part 15 of the FCC Rules. Operation is subject to the following two conditions: (1) This device may not cause harmful interference, and (2) this device must accept any interference received, including interference that may cause undesired operation.

Representative Person's Name : Steve Chang / President

Signature :

Date : Jul. 17, 2015

Ver: 140331



EC Declaration of Conformity

We, the undersigned,

Manufacturer: ASUSTeK COMPUTER INC.
Address: 4F, No. 150, LI-TIE RD., PEITOU, TAIPEI 112, TAIWAN
Authorized representative in Europe: ASUS COMPUTER GmbH
Address, City: HARKORT STR. 21-23, 40880 RATINGEN
Country: GERMANY

declare the following apparatus:

Product name : Motherboard
Model name : H170 PRO GAMING

conform with the essential requirements of the following directives:

2004/108/EC-EMC Directive
 EN 55022:2010/A2:2011
 EN 55024:2010
 EN 55013:2001/A1:2003/A2:2006
 EN 55020:2007/A1:2011

1989/5/EEC-RATE Directive
 EN 300 328 V1.8.1 (2012-06)
 EN 300 440-1 V1.6.1 (2010-08)
 EN 300 440-2 V1.6.1 (2010-08)
 EN 301 851 V1.9.0.2 (2010-03)
 EN 301 908-1 V1.2.1 (2011-05)
 EN 301 908-2 V1.2.1 (2011-05)
 EN 301 853 V1.7 (2012-07)
 EN 302 544-2 V1.1 (2009-01)
 EN 305 662-3 V1.1.1 (2009-01)
 EN 62479:2010
 EN 55085:2002
 EN 55085:2002
 EN 301 484-1 V1.3.2 (2011-09)
 EN 301 484-3 V1.4.1 (2010-08)
 EN 301 484-4 V1.4.1 (2010-08)
 EN 301 484-5 V1.4.1 (2010-08)
 EN 301 484-6 V1.3.1 (2008-11)
 EN 301 484-7 V1.3.1 (2008-11)
 EN 301 489-9 V1.4.1 (2007-11)
 EN 301 489-10 V1.4.1 (2007-11)
 EN 301 489-11 V1.4.1 (2007-11)
 EN 301 489-12 V1.5.1 (2010-09)
 EN 301 489-13 V1.5.1 (2010-09)
 EN 301 489-14 V1.5.1 (2010-09)
 EN 301 489-15 V1.5.1 (2010-09)
 EN 301 489-16 V1.5.1 (2010-09)
 EN 301 489-17 V1.5.1 (2010-09)
 EN 301 489-18 V1.5.1 (2010-09)
 EN 301 489-19 V1.5.1 (2010-09)
 EN 301 489-20 V1.5.1 (2010-09)
 EN 301 489-21 V1.1 (2005-07)
 EN 301 489-22 V1.1 (2005-07)

2006/95/EC-LVD Directive
 EN 60950-1:2006/A12:2011
 EN 60950-1:2006/A2:2013

2009/125/EC-EP Directive
 Regulation (EC) No. 1275/2008
 Regulation (EC) No. 642/2009

2011/65/EU-RoHS Directive
 CE marking



(EC conformity marking)

Position : CEO
Name : Jerry Shen

Signature : _____

Declaration Date: 17/07/2015
Year to begin affixing CE marking: 2015

Ver: 150268