

**MAXIMUS
VIII GENE**

ASUS®

Motherboard

E10484
First Edition
July 2015

Copyright © 2015 ASUSTeK COMPUTER INC. All Rights Reserved.

No part of this manual, including the products and software described in it, may be reproduced, transmitted, transcribed, stored in a retrieval system, or translated into any language in any form or by any means, except documentation kept by the purchaser for backup purposes, without the express written permission of ASUSTeK COMPUTER INC. ("ASUS").

Product warranty or service will not be extended if: (1) the product is repaired, modified or altered, unless such repair, modification of alteration is authorized in writing by ASUS; or (2) the serial number of the product is defaced or missing.

ASUS PROVIDES THIS MANUAL "AS IS" WITHOUT WARRANTY OF ANY KIND, EITHER EXPRESS OR IMPLIED, INCLUDING BUT NOT LIMITED TO THE IMPLIED WARRANTIES OR CONDITIONS OF MERCHANTABILITY OR FITNESS FOR A PARTICULAR PURPOSE. IN NO EVENT SHALL ASUS, ITS DIRECTORS, OFFICERS, EMPLOYEES OR AGENTS BE LIABLE FOR ANY INDIRECT, SPECIAL, INCIDENTAL, OR CONSEQUENTIAL DAMAGES (INCLUDING DAMAGES FOR LOSS OF PROFITS, LOSS OF BUSINESS, LOSS OF USE OR DATA, INTERRUPTION OF BUSINESS AND THE LIKE), EVEN IF ASUS HAS BEEN ADVISED OF THE POSSIBILITY OF SUCH DAMAGES ARISING FROM ANY DEFECT OR ERROR IN THIS MANUAL OR PRODUCT.

SPECIFICATIONS AND INFORMATION CONTAINED IN THIS MANUAL ARE FURNISHED FOR INFORMATIONAL USE ONLY, AND ARE SUBJECT TO CHANGE AT ANY TIME WITHOUT NOTICE, AND SHOULD NOT BE CONSTRUED AS A COMMITMENT BY ASUS. ASUS ASSUMES NO RESPONSIBILITY OR LIABILITY FOR ANY ERRORS OR INACCURACIES THAT MAY APPEAR IN THIS MANUAL, INCLUDING THE PRODUCTS AND SOFTWARE DESCRIBED IN IT.

Products and corporate names appearing in this manual may or may not be registered trademarks or copyrights of their respective companies, and are used only for identification or explanation and to the owners' benefit, without intent to infringe.

Offer to Provide Source Code of Certain Software

This product contains copyrighted software that is licensed under the General Public License ("GPL"), under the Lesser General Public License Version ("LGPL") and/or other Free Open Source Software Licenses. Such software in this product is distributed without any warranty to the extent permitted by the applicable law. Copies of these licenses are included in this product.

Where the applicable license entitles you to the source code of such software and/or other additional data, you may obtain it for a period of three years after our last shipment of the product, either

(1) for free by downloading it from <http://support.asus.com/download>

or

(2) for the cost of reproduction and shipment, which is dependent on the preferred carrier and the location where you want to have it shipped to, by sending a request to:

ASUSTeK Computer Inc.
Legal Compliance Dept.
15 Li Te Rd.,
Beitou, Taipei 112
Taiwan

In your request please provide the name, model number and version, as stated in the About Box of the product for which you wish to obtain the corresponding source code and your contact details so that we can coordinate the terms and cost of shipment with you.

The source code will be distributed WITHOUT ANY WARRANTY and licensed under the same license as the corresponding binary/object code.

This offer is valid to anyone in receipt of this information.

ASUSTeK is eager to duly provide complete source code as required under various Free Open Source Software licenses. If however you encounter any problems in obtaining the full corresponding source code we would be much obliged if you give us a notification to the email address gpl@asus.com, stating the product and describing the problem (please DO NOT send large attachments such as source code archives, etc. to this email address).

Contents

Safety information.....	vi
About this guide.....	vii
MAXIMUS VIII GENE specifications summary.....	ix
Package contents.....	xiii
Installation tools and components.....	xiv

Chapter 1: Product Introduction

1.1 Special features.....	1-1
1.1.1 Product highlights.....	1-1
1.1.2 ROG Gaming Features.....	1-3
1.1.3 ROG Exclusive Features.....	1-4
1.1.4 ASUS Special Features.....	1-4
1.1.5 ROG rich bundled software.....	1-5
1.2 Motherboard overview.....	1-6
1.2.1 Before you proceed.....	1-6
1.2.2 Motherboard layout.....	1-7
1.2.3 Central Processing Unit (CPU).....	1-9
1.2.4 System memory.....	1-10
1.2.5 Expansion slots.....	1-18
1.2.6 Onboard buttons.....	1-20
1.2.7 Onboard LEDs.....	1-23
1.2.8 Jumper.....	1-30
1.2.9 Internal connectors.....	1-31
1.2.10 Probelt.....	1-39

Chapter 2: Basic Installation

2.1 Building your PC system.....	2-1
2.1.1 Motherboard installation.....	2-1
2.1.2 CPU installation.....	2-3
2.1.3 CPU heatsink and fan assembly installation.....	2-5
2.1.4 DIMM installation.....	2-7
2.1.5 ATX Power connection.....	2-8
2.1.6 SATA device connection.....	2-9
2.1.7 Front I/O Connector.....	2-10
2.1.8 Expansion Card installation.....	2-11
2.2 BIOS update utility.....	2-12
2.3 Motherboard rear and audio connections.....	2-13
2.3.1 Rear I/O connection.....	2-13
2.3.2 Audio I/O connections.....	2-14

2.4	Starting up for the first time.....	2-17
2.5	Turning off the computer	2-17

Chapter 3: BIOS Setup

3.1	Knowing BIOS	3-1
3.2	BIOS setup program	3-2
3.2.1	EZ Mode.....	3-3
3.2.2	Advanced Mode	3-4
3.3	My Favorites	3-7
3.4	Main menu	3-8
3.5	Extreme Tweaker menu	3-11
3.6	Advanced menu	3-21
3.6.1	CPU Configuration	3-22
3.6.2	Platform Misc Configuration.....	3-24
3.6.3	System Agent (SA) Configuration	3-26
3.6.4	ROG Effects.....	3-27
3.6.5	PCH Configuration	3-28
3.6.6	PCH Storage Configuration.....	3-28
3.6.7	USB Configuration	3-30
3.6.8	Network Stack Configuration.....	3-31
3.6.9	Onboard Devices Configuration.....	3-32
3.6.10	APM Configuration.....	3-34
3.6.11	HDD/SSD SMART Information	3-35
3.7	Monitor menu	3-36
3.8	Boot menu	3-41
3.9	Tool menu	3-46
3.9.1	ASUS EZ Flash 3 Utility	3-46
3.9.2	Secure Erase	3-46
3.9.3	ASUS Overclocking Profile	3-48
3.9.4	ROG OC Panel H-Key Configure.....	3-49
3.9.5	ASUS SPD Information	3-50
3.9.6	Graphics Card Information	3-50
3.10	Exit menu.....	3-51
3.11	Updating BIOS.....	3-52

Chapter 4: Software Support

4.1	Installing an operating system	4-1
4.1.1	Windows® 7 and USB 3.0 driver installation for 100 Series	4-1
4.2	Support DVD information	4-8
4.2.1	Running the support DVD	4-8
4.2.2	Obtaining the software manuals	4-9
4.3	Software information	4-10
4.4	AI Suite 3	4-10
4.5	Dual Intelligent Processors 5	4-13
4.6	ROG Audio features	4-29
4.7	Sonic Radar II	4-36
4.8	GameFirst III	4-38
4.9	KeyBot II	4-41
4.10	ASUS Media Streamer	4-43
4.11	RAMDisk	4-45
4.12	MemTweakIt	4-48
4.13	ROG CPU-Z	4-50
4.14	RAMCache	4-51

Chapter 5: RAID Support

5.1	RAID configurations	5-1
5.1.1	RAID definitions	5-1
5.1.2	Installing Serial ATA hard disks	5-2
5.1.3	Setting the RAID item in BIOS	5-2
5.1.4	Intel® Rapid Storage Technology Option ROM utility	5-3
5.2	Creating a RAID driver disk	5-7
5.2.1	Creating a RAID driver disk without entering the OS	5-7
5.2.2	Creating a RAID driver disk in Windows®	5-8
5.2.3	Installing the RAID driver during Windows® OS installation	5-8

Appendix

Notices	A-1
ASUS contact information	A-5

Safety information

Electrical safety

- To prevent electrical shock hazard, disconnect the power cable from the electrical outlet before relocating the system.
- When adding or removing devices to or from the system, ensure that the power cables for the devices are unplugged before the signal cables are connected. If possible, disconnect all power cables from the existing system before you add a device.
- Before connecting or removing signal cables from the motherboard, ensure that all power cables are unplugged.
- Seek professional assistance before using an adapter or extension cord. These devices could interrupt the grounding circuit.
- Ensure that your power supply is set to the correct voltage in your area. If you are not sure about the voltage of the electrical outlet you are using, contact your local power company.
- If the power supply is broken, do not try to fix it by yourself. Contact a qualified service technician or your retailer.

Operation safety

- Before installing the motherboard and adding devices on it, carefully read all the manuals that came with the package.
- Before using the product, ensure all cables are correctly connected and the power cables are not damaged. If you detect any damage, contact your dealer immediately.
- To avoid short circuits, keep paper clips, screws, and staples away from connectors, slots, sockets and circuitry.
- Avoid dust, humidity, and temperature extremes. Do not place the product in any area where it may become wet.
- Place the product on a stable surface.
- If you encounter technical problems with the product, contact a qualified service technician or your retailer.

About this guide

This user guide contains the information you need when installing and configuring the motherboard.

How this guide is organized

This guide contains the following parts:

- **Chapter 1: Product Introduction**
This chapter describes the features of the motherboard and the new technology it supports. It includes description of the switches, jumpers, and connectors on the motherboard.
- **Chapter 2: Basic Installation**
This chapter lists the hardware setup procedures that you have to perform when installing system components.
- **Chapter 3: BIOS Setup**
This chapter tells how to change system settings through the BIOS Setup menus. Detailed descriptions of the BIOS parameters are also provided.
- **Chapter 4: Software Support**
This chapter describes the contents of the support DVD that comes with the motherboard package and the software.
- **Chapter 5: RAID Support**
This chapter describes the RAID configurations.

Where to find more information

Refer to the following sources for additional information and for product and software updates.

1. **ASUS website**
The ASUS website (www.asus.com) provides updated information on ASUS hardware and software products.
2. **Optional documentation**
Your product package may include optional documentation, such as warranty flyers, that may have been added by your dealer. These documents are not part of the standard package.

Conventions used in this guide

To ensure that you perform certain tasks properly, take note of the following symbols used throughout this manual.



DANGER/WARNING: Information to prevent injury to yourself when trying to complete a task.



CAUTION: Information to prevent damage to the components when trying to complete a task



IMPORTANT: Instructions that you **MUST** follow to complete a task.



NOTE: Tips and additional information to help you complete a task.

Typography

Bold text

Indicates a menu or an item to select.

Italics

Used to emphasize a word or a phrase.

<Key>

Keys enclosed in the less-than and greater-than sign means that you must press the enclosed key.

Example: <Enter> means that you must press the Enter or Return key.

<Key1> + <Key2> + <Key3>

If you must press two or more keys simultaneously, the key names are linked with a plus sign (+).

MAXIMUS VIII GENE specifications summary

CPU	LGA1151 socket for 6th Generation Intel® Core™ i7 / i5 / i3 / Pentium® / Celeron® Processors Supports 14nm CPU Supports Intel® Turbo Boost Technology 2.0* * The support of these features depends on the CPU types.
Chipset	Intel® Z170 Express Chipset
Memory	4 x DIMM, max. 64GB DDR4 3600+ (OC)* / 3466 (OC)* / 3400 (OC)* / 3333 (OC)* / 3300 (OC)* / 3200 (OC)* / 3000 (OC)* / 2800 (OC)* / 2666 (OC)* / 2400 (OC)* / 2133 MHz, non-ECC, un-buffered memory Dual channel memory architecture Supports Intel® Extreme Memory Profile (XMP) * Hyper DIMM support is subject to the physical characteristics of individual CPUs. Please refer to Memory QVL (Qualified Vendors List) for details.
Expansion slots	New 6th Gen Intel® Core™ Processors 2 x PCIe 3.0 x16 slots (supports x16, x8/x8) Intel® Z170 Express Chipset 1 x PCIe 3.0 x4 slot
Graphic	Integrated Graphics Processor- Intel® HD Graphics support - Multi-VGA output support : HDMI/DisplayPort - Supports DisplayPort 1.2 with max. resolution 4096 x 2160 @ 60 Hz - Supports HDMI 1.4b with max. resolution 4096 x 2160 @ 24 Hz Supports Intel® InTru™ 3D/Quick Sync Video/Clear Video HD Technology/Insider™
Multi-GPU support	Supports NVIDIA® Quad-GPU SLI™ Technology Supports AMD® Quad-GPU CrossFireX™ Technology
Storage	Intel® Z170 Express Chipset with RAID 0, 1, 5, 10, and Intel Rapid Storage Technology 14 support: - 1 x M.2 Socket 3 with M Key, type 2242/2260/2280/22110 storage devices support (PCIe 3.0 x4 and SATA Modes)* - 2 x SATA Express ports - 6 x SATA 6Gb/s ports (4 ports from 2 x SATA Express)* - Supports Intel® Smart Response Technology** * When the M.2 Socket 3 is operating in SATA mode, SATA port 1 will be disabled. ** This function will work depending on the CPU installed.
LAN	Intel® I219-V Gigabit LAN - Dual interconnect between the integrated Media Access Controller (MAC) and physical layer (PHY) Anti-surge LANGuard ROG GameFirst technology

(continued on the next page)

MAXIMUS VIII GENE specifications summary

<p>Audio</p>	<p>ROG SupremeFX 2015 8 - Channel High Definition Audio CODEC</p> <ul style="list-style-type: none"> - ES9023P High Definition Codec - 2V_{RMS} Headphone Amp into (32-600 Ohms) - SupremeFX Shielding Technology - Jack-detection, Multi-streaming, and Front Panel Jack - retasking - Optical S/PDIF out port at back panel <p>Audio Feature:</p> <ul style="list-style-type: none"> - Sonic Studio II - Sonic Radar II - DTS Connect
<p>USB</p>	<p>Intel® Z170 Express Chipset - Supports ASUS USB 3.1 Boost:</p> <ul style="list-style-type: none"> - 8 x USB 3.0 ports (2 ports at mid-board; 6 ports at back panel) - 4 x USB 2.0 ports at mid-board* <p>ASMedia® USB 3.1 controller - Supports ASUS USB 3.1 Boost:</p> <ul style="list-style-type: none"> - 2 x USB 3.1 ports (1 Type-A [red] and 1 Type-C [black] at back panel) <p>* 2 x USB2.0 port at mid-board shares with ROG extension (ROG_EXT) port.</p>
<p>ROG Exclusive Features</p>	<p>Retry Button</p> <p>Safe boot</p> <p>Start button</p> <p>Reset button</p> <p>Probelt</p> <p>LN2 Mode</p> <p>ROG RAMDisk</p> <p>ROG RAMCache</p> <p>Overwolf</p> <p>KeyBot II</p> <ul style="list-style-type: none"> - One-click Overclocking - X.M.P. - DirectKey - Clr CMOS - Power On <p>UEFI BIOS features :</p> <ul style="list-style-type: none"> - Extreme Tweaker - Tweakers' Paradise - ROG SSD Secure Erase - GPU.DIMM Post - O.C. Profile - Graphics Card Information Preview

(continued on the next page)

MAXIMUS VIII GENE specifications summary

<p>Special Features</p>	<p>ASUS Dual Intelligent Processors 5 - 5-Way Optimization tuning key perfectly consolidates TPU, EPU, DIGI+ Power Control, Fan Xpert 3, and Turbo App</p> <p>ASUS Exclusive Features - AI Suite 3 - USB 3.1 Boost - AI Charger+ - Push Notice - Disk Unlocker - PC Cleaner - HyStream - Media Streamer - Mobo Connect</p> <p>ASUS EZ DIY - USB BIOS Flashback - ASUS CrashFree BIOS 3 - ASUS EZ Flash 3 - ASUS C.P.R.(CPU Parameter Recall) - MemOK!</p> <p>ASUS Q-Design - Q-Code - Q-Shield - Q-Connector - Q-LED (CPU, DRAM, VGA, Boot Device LED) - Q-Slot - Q-DIMM</p>
<p>Back I/O Ports</p>	<p>1 x BIOS Flashback Button 1 x Clr CMOS Button 1 x PS/2 keyboard/mouse combo port 6 x USB 3.0 ports [blue] 2 x USB 3.1 ports (1 x Type-A [red] and 1 x Type-C [black]) 1 x HDMI 1.4b port 1 x DisplayPort 1.2 1 x Anti-surge LAN (RJ45) port 1 x Optical S/PDIF out 5 x Gold-plated audio jacks</p>

(continued on the next page)

MAXIMUS VIII GENE specifications summary

<p>Internal Connectors</p>	<p>1 x USB 3.0 header support additional 2 USB 3.0 ports 2 x USB 2.0 connectors support additional 4 USB 2.0 ports [one connector via ROG_EXT header] 2 x SATA Express connectors 2 x SATA 6Gb/s connectors (4 ports from 2 x SATA Express) 1 x M.2 Socket 3 with M Key, type 2242 / 2260 / 2280 / 22110 storage devices support (PCIe 3.0 x4 and SATA Modes) 1 x ROG extension (ROG_EXT) header 1 x 4-Pin CPU fan connector 1 x 4-Pin CPU_OPT fan connector 4 x 4-Pin Chassis fan connectors 1 x 4-Pin Water pump connector 1 x Ext_fan header 1 x Thermal sensor connector 1 x 24-pin EATX power connector 1 x 8-pin EATX 12V power connector 1 x Safe Boot button 1 x ReTry button 1 x Start button 1 x Reset button 1 x LN2 mode jumper 1 x MemOK! button 1 x Front panel audio connector (AAFP) 1 x System panel connector</p>
<p>BIOS Features</p>	<p>128 Mb Flash ROM, UEFI AMI BIOS, PnP, DMI3.0, WfM2.0, SM BIOS 3.0, ACPI 5.0, Multi-language BIOS, ASUS EZ Flash 3, CrashFree BIOS 3, F11 EZ Tuning Wizard, F6 Qfan Control, F3 My Favorites, F9 Quick Note, Last Modified log, F12 PrintScreen, and ASUS DRAM SPD (Serial Presence Detect) memory information.</p>
<p>Manageability</p>	<p>WfM2.0, DMI3.0, WOL by PME, PXE</p>
<p>Software</p>	<p>Drivers ROG GameFirst technology ROG RAMCache ROG RAMDisk Overwolf KeyBot II ROG CPU-Z ROG Mem TweakIt Kaspersky® Anti-Virus DAEMON Tools Pro Standard ASUS WebStorage ASUS Utilities</p>

(continued on the next page)

MAXIMUS VIII GENE specifications summary

Operating System Support	Windows® 10* Windows® 8.1* Windows® 7 *64-bit supported only
Form Factor	mATX Form Factor, 9.6" x 9.6" (24.4cm x 24.4cm)



Specifications are subject to change without notice.

Package contents



Check your motherboard package for the following items.

Motherboard	ROG MAXIMUS VIII GENE
Cables	2 x 2-in-1 SATA 6 Gb/s cables 1 x SLI™ bridge
Accessories	1 x I/O Shield 1 x Q-Connector kit 1 x ROG Door Hanger 1 x 12-in-1 ROG cable label 1 x CPU Installation Tool 1x Fan Label 1 x M.2 Screw
Application DVD	ROG motherboard support DVD
Documentation	User guide

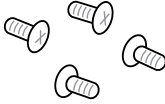

If any of the above items is damaged or missing, contact your retailer.

Installation tools and components

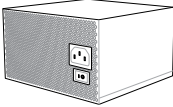
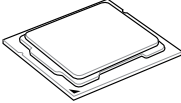
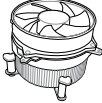
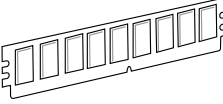
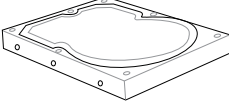
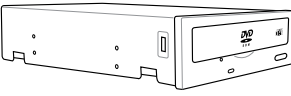
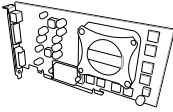
	
<p>1 Bag of screws</p>	<p>Phillips (cross) screwdriver</p>
	
<p>PC chassis</p>	<p>Power supply unit</p>
	
<p>Intel LGA 1151 CPU</p>	<p>Intel LGA 1151 compatible CPU Fan</p>
	
<p>DDR4 DIMM</p>	<p>SATA hard disk drive</p>
	
<p>SATA optical disc drive (optional)</p>	<p>Graphics card (optional)</p>



The tools and components in the table above are not included in the motherboard package.

Product Introduction

1

1.1 Special features

1.1.1 Product highlights

Republic of Gamers

The Republic of Gamers offers you the best of the best. We offer the best hardware engineering, the fastest performance, the most innovative ideas, and we welcome the best gamers to join in. In the Republic of Gamers, mercy rules are only for the weak, and bragging rights means everything. We believe in making statements and we excel in competitions. If your character matches our trait, then join the elite Republic of Gamers and make your presence felt.

LGA1151 socket for New 6th generation Intel Core processors

This motherboard supports the New 6th Gen Intel® Core™ processors on the LGA1151 package, with memory and PCI Express controllers integrated to support dual-channel (4 DIMM) DDR4 memory and 16 PCI Express 3.0/2.0 lanes.

Intel® Z170 Express Chipset

The Intel® Z170 Express Chipset is a single-chipset design that supports socket LGA1151 6th Gen Intel® Core™ processors. It provides improved performance by utilizing serial point-to-point links, allowing increased bandwidth and stability. Additionally, Z170 provides a maximum 10 USB 3.0 ports, 6 SATA 6Gbit/s ports for faster data retrieval.

PCIe® 3.0

PCIe® 3.0 (PCIe 3.0) is the PCIe bus standard that provides twice the performance and speed of PCIe 2.0. It provides an optimal graphics performance, unprecedented data speed and seamless transition with its complete backward compatibility to PCIe 1.0/2.0 devices.

SLI®/CrossFire™ On-Demand

This motherboard supports multi-GPU SLI®/CrossFireX™ graphics cards for an unrivalled gaming performance. With the Intel® Z170 platform to optimize the PCIe allocation of multiple GPUs, it supports up to 2-WAY GPU SLI® or CrossFireX™ configuration.

M.2 Support

This motherboard features an M.2 slot, which supports both PCIe and SATA modes. The PCIe mode operates at full PCI Gen. 3.0 x4 speeds. The SATA mode shares bandwidth with SATA ports 1 and 2 and will automatically disable those ports when an M.2 card is inserted.



Supports 2242 (22 mm x 42 mm), 2260 (22 mm x 60 mm), 2280 (22 mm x 80 mm), and 22110 (22 mm x 110 mm) SSD cards.

Complete USB 3.0 integration

This motherboard offers you the strategic USB 3.0 accessibility for both the front and rear panels, allowing you to experience the convenience of the latest plug and play connectivity solution at speed up to ten times faster than USB 2.0.

1.1.2 ROG Gaming Features

SupremeFX 2015

The re-engineered ROG-exclusive SupremeFX 2015 audio technology features an onboard 8-channel high-definition sound of true audiophile-grade performance that is equal in power, clarity, and range to dedicated sound cards. Its unique Red Line Shielding and special metallic cover provides pristine sound and a highly attractive look for the motherboard that is in keeping with the ROG style. The Japan-made premium Nichicon capacitor ensures warm natural sound with exceptional clarity for all your gaming and multimedia activities. SupremeFX 2015 revolutionizes the way you hear games, movies, music, and even other people via chat - letting you rule and discover a totally whole new dimension of superior audio.

Sonic Radar II

Sonic Radar II features the exclusive audio enhancement that enhances in-game sound for better hearing awareness. It has a customizable user interface with a stealthy overlay display that shows what opponents and teammates are up to including information on the precise direction and origin of gunshots, footsteps, and call-outs when playing first person shooting (FPS) games.

Sonic Studio II

Sonic Studio II is an audio tuning software that simulates 7.1 channels even through a stereo (2.0-channel) headset with its virtual surround-sound function. It comes with six superb audio controls including Reverb, Bass Boost, Equalizer, Voice Clarity, Smart EQ (Smart Volume), and Virtual Surround.

Sonic SenseAmp

Sonic SenseAmp is an exclusive ROG invention that automatically detects your headset's impedance and adjusts the built-in amp accordingly. Sonic SenseAmp makes tuning your high-quality headphones as simple as plugging them in.

GameFirst technology

ASUS GameFirst technology is a network management software that features four preset packet prioritized profiles facilitating user's need. Users can also manually allocate bandwidth and adjust priority settings of each application to run faster and smoother.

Intel® Ethernet

This LAN solution from Intel features high TCP and UDP throughput with lower CPU utilization for a smooth networking experience. It has advanced features including advanced interrupt-handling, low-power consumption, and Intel Stable Image Platform Program (SIPP) support thanks to its compatibility with the Intel CPU and chipset.

1.1.3 ROG Exclusive Features

Extreme Engine Digi+

Extreme Engine Digi+ offers you a hardcore power delivery for a challenging and extreme gaming enjoyment. It utilizes the best components such as NexFET™ Power Block MOSFETs, MicroFine alloy chokes, and super-premium 10K black metallic solid state capacitors. The NexFET™ Power Block MOSFETs combine great durability and up to 90% efficiency under normal operation. Super-premium 10K Black Metallic solid state capacitors are forged for overclocking and the most extreme demands, lasting up to five times longer than generic capacitors with 20% wider temperature tolerance.

RAMCache

ROG's unique technology caches either whole data files or their most frequently-used fragments, depending on your available memory — getting to work from the moment it's activated. RAMCache turns milliseconds into microseconds to boost game-load times to stratospheric speeds, and minimize risk of data loss!

RAMDisk

RAMDisk reserves part of system memory and turns it into actual storage, so you can place favorite app and game cache files in it to enjoy high-speed RAM performance while accessing them. Plus, this extends SSD lifespan and keeps your main storage optimized for really important tasks, and you get auto data backup and restore.



RAMDisk only supports 64-bit operating systems.

KeyBot II

KeyBot II is a built-in microprocessor that provides instant upgrade to your keyboard. You can configure and assign macros to specific keys on your keyboard to perform specific or several task at the same time. You can also configure your PC to wake up in CPU Level UP, XMP, or directly to BIOS mode.



This feature supports USB keyboards only.

1.1.4 ASUS Special Features

AI Suite 3

With its user-friendly interface, ASUS AI Suite 3 consolidates all the exclusive ASUS features into one simple-to-use software package. It allows you to supervise fan speed control, voltage and sensor readings. This all-in-one software offers diverse and ease to use functions, with no need to switch back and forth between different utilities.

USB 3.1 Boost

ASUS USB 3.1 Boost, which supports USB 3.0 and USB 3.1 standard UASP (USB Attached SCSI Protocol), significantly increases a USB device's transfer speed up to 170% faster than the already impressive USB 3.1 transfer speed. It automatically accelerates data speeds for compatible USB 3.1 peripherals without the need for any user interaction.

USB BIOS Flashback

USB BIOS Flashback offers a hassle-free updating solution for your ultimate convenience. Install a USB storage device containing the BIOS file, press the BIOS Flashback button for about three seconds, and the UEFI BIOS is automatically updated even without entering the existing BIOS or operating system. It also allows you to regularly check for UEFI BIOS updates, and download the latest BIOS automatically.

1.1.5 ROG rich bundled software

Kaspersky® Anti-Virus

Kaspersky® Anti-Virus Personal offers premium anti virus protection for individual users and home offices. It is based on advanced anti virus technologies. The product incorporates the Kaspersky® Anti-Virus engine, which is renowned for malicious program detection rates that are among the industry's highest.

Overwolf

The clever unobtrusive overlay that keeps you in the game, so you can browse, email, IM, stream or record while you play — and all dressed up in downloadable color-matched ROG skins to show you're part of an elite pack. Plus, download awesome Overwolf apps to make your gaming experiences even more epic!

DAEMON Tools Pro Standard

DAEMON Tools Pro offers essential functionality to backup CD, DVD and Blu-ray discs. It converts optical media into virtual discs and emulates devices to work with the virtual copies. DAEMON Tools Pro organizes data, music, video, and photo collections on a PC, notebook, or netbook.

ROG CPU-Z

ROG CPU-Z is a customized ROG version utility authorized by Intel's CPU Identification (CPUID) that allows you to gather information of the main devices of your system. It gives you the information and status of your CPU, motherboard, memory, and the whole component. Use the ROG look of reporting your system's current information with ROG CPU-Z.

MemTweaktl

MemTweaktl is a DRAM efficiency tool that allows you to read DRAM timings and allows you to post and share your DRAM configuration scores to the ROG website.

DTS Connect

To get the most out of your audio entertainment across all formats and quality levels, DTS Connect combines two enabling technologies, DTS Neo:PC™ up mixes stereo sources (CDs, MP3s, WMAs, internet radio) into as many as 7.1 channels of incredible surround sound. Consumers can connect their PC to a home theatre system. DTS Interactive is capable of performing multichannel encoding of DTS bitstreams on personal computers, and sending encoded bitstreams out of a digital audio connection (such as S/PDIF or HDMI) designed to deliver audio to an external decoder.

1.2 Motherboard overview

1.2.1 Before you proceed

Take note of the following precautions before you install motherboard components or change any motherboard settings.



-
- Unplug the power cord from the wall socket before touching any component.
 - Before handling components, use a grounded wrist strap or touch a safely grounded object or a metal object, such as the power supply case, to avoid damaging them due to static electricity.
 - Hold components by the edges to avoid touching the ICs on them.
 - Whenever you uninstall any component, place it on a grounded antistatic pad or in the bag that came with the component.
 - Before you install or remove any component, ensure that the ATX power supply is switched off or the power cord is detached from the power supply. Failure to do so may cause severe damage to the motherboard, peripherals, or components.
-

1.2.2 Motherboard layout

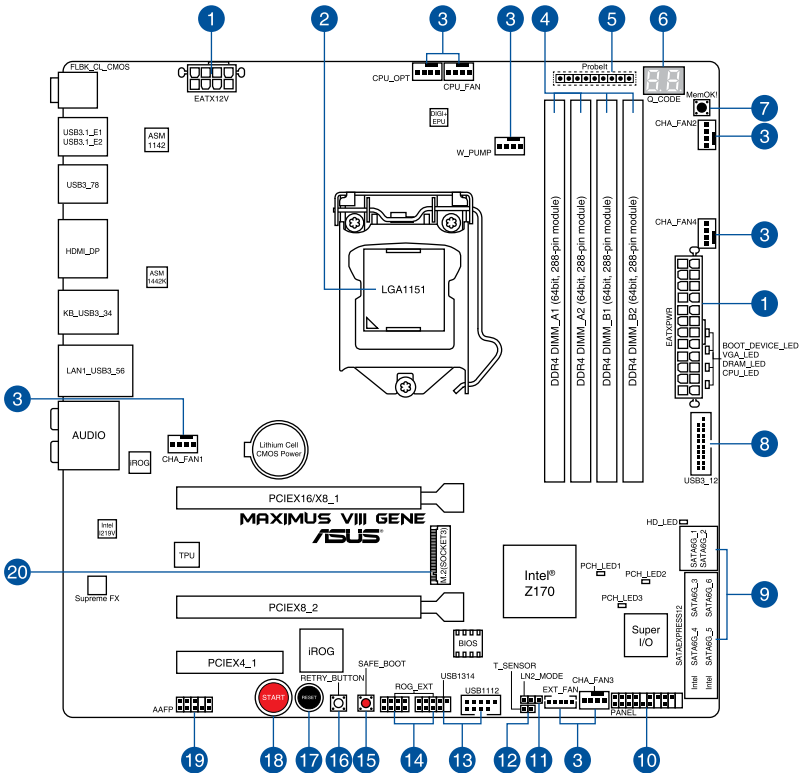

Refer to **Internal connectors** and **Rear I/O connection** for more information about rear panel connectors and internal connectors.

Layout contents

Connectors/Jumpers/Buttons and switches/Slots	Page
1. ATX power connectors (24-pin EATXPWR; 8-pin EATX12V)	1-37
2. LGA1151 CPU Socket	1-9
3. CPU, water pump, CPU optional, extension, and chassis fan connectors (4-pin CPU_FAN; 4-pin W_PUMP; 4-pin CPU_OPT; 5-pin EXT_FAN; 4-pin CHA_FAN1-4)	1-36
4. DDR4 DIMM slots	1-10
5. Probelt	1-40
6. Q_Code LEDs	1-25
7. MemOK! button	1-23
8. USB 3.0 connectors (20-1 pin USB3_12)	1-33
9. Intel® Z170 Serial ATA 6 Gb/s connectors (7-pin SATA6G_12; SATAEXPRESS12)	1-32
10. System panel connector (20-5 pin PANEL)	1-38
11. LN2 Mode jumper (3-pin LN2_MODE)	1-31
12. T_Sensor connector (2-pin T_SENSOR)	1-39
13. USB 2.0 connectors (10-1 pin USB1314, USB1112)	1-34
14. ROG Extension connector (18-1 pin ROG_EXT)	1-39
15. SAFE_BOOT button	1-22
16. RETRY_BUTTON button	1-22
17. RESET button	1-21
18. START (Power-on) button	1-21
19. Front panel audio connector (10-1 pin AAFP)	1-35
20. M.2 (Socket 3)	1-40

1.2.3 Central Processing Unit (CPU)

This motherboard supports the New 6th Gen Intel® Core™ processors on the LGA1151 package, with memory and PCI Express controllers integrated to support dual-channel (4 DIMM) DDR4 memory and 16 PCI Express 3.0/2.0 lanes.

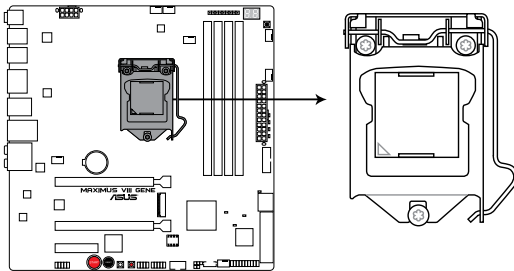

MAXIMUS VIII GENE CPU LGA1151



Ensure that you install the correct CPU designed for LGA1151 socket only. **DO NOT** install a CPU designed for LGA155 and LGA1156 sockets in the LGA1151 socket.



- Ensure that all power cables are unplugged before installing the CPU.
 - Upon purchase of the motherboard, ensure that the PnP cap is on the socket and the socket contacts are not bent. Contact your retailer immediately if the PnP cap is missing, or if you see any damage to the PnP cap/socket contacts/motherboard components. ASUS will shoulder the cost of repair only if the damage is shipment/transit-related.
 - Keep the cap after installing the motherboard. ASUS will process Return Merchandise Authorization (RMA) requests only if the motherboard comes with the cap on the LGA1151 socket.
 - The product warranty does not cover damage to the socket contacts resulting from incorrect CPU installation/removal, or misplacement/loss/incorrect removal of the PnP cap.
-

1.2.4 System memory

The motherboard comes with four Double Data Rate 4 (DDR4) Dual Inline Memory Modules (DIMM) slots.



A DDR4 module is notched differently from a DDR, DDR2, or DDR3 module. DO NOT install a DDR, DDR2, or DDR3 memory module to the DDR4 slot.

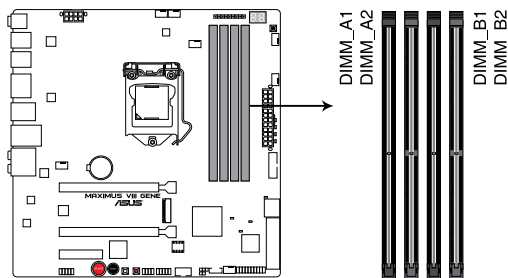

MAXIMUS VIII GENE 288-pin DDR4 DIMM socket

Recommended memory configurations

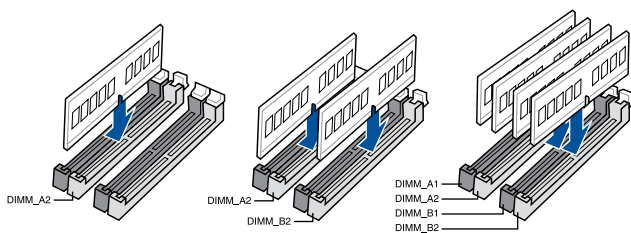

Memory configurations

You may install 1 GB, 2 GB, 4 GB and 8 GB unbuffered and non-ECC DDR4 DIMMs into the DIMM sockets.



-
- Memory module with memory frequency higher than 2133 MHz and its corresponding timing or the loaded XMP profile is not the JEDEC memory standard. The stability and compatibility of these memory modules depend on the CPU's capabilities and other installed devices.
 - You may install varying memory sizes in Channel A and Channel B. The system maps the total size of the lower-sized channel for the dual-channel configuration. Any excess memory from the higher-sized channel is then mapped for single-channel operation.
 - Due to the memory address limitation on 32-bit Windows OS, when you install 4GB or more memory on the motherboard, the actual usable memory for the OS can be about 3GB or less. For effective use of memory, we recommend that you do any of the following:
 - a) Use a maximum of 3GB system memory if you are using a 32-bit Windows OS.
 - b) Install a 64-bit Windows OS when you want to install 4GB or more on the motherboard.
 - c) For more details, refer to the Microsoft® support site at <http://support.microsoft.com/kb/929605/en-us>.
 - Always install DIMMs with the same CAS latency. For optimal compatibility, we recommend that you install memory modules of the same version or date code (D/C) from the same vendor. Check with the retailer to get the correct memory modules.
-



-
- The default memory operation frequency is dependent on its Serial Presence Detect (SPD), which is the standard way of accessing information from a memory module. Under the default state, some memory modules for overclocking may operate at a lower frequency than the vendor-marked value. To operate at the vendor-marked or at a higher frequency, refer to section **3.5 Extreme Tweaker menu** for manual memory frequency adjustment.
 - For system stability, use a more efficient memory cooling system to support a full memory load (4 DIMMs) or overclocking condition.
-

MAXIMUS VIII GENE Motherboard Qualified Vendors Lists (QVL)

DDR4 3600+ MHz capability

Vendors	Part No.	Size	SS/DS	Chip Brand	Chip NO.	Timing	Voltage	DIMM socket support (Optional)	
								2	4
CORSAIR	CMD16GX4M4B3600C18	16GB (4 x 4GB)	SS	-	-	18-19-19-39	1.35V	•	•
G.SKILL	F4-3600C17-8GVK	16GB (4 x 4GB)	SS	-	-	17-18-18-38	1.35V	•	
G.SKILL	F4-3600C17-8GTZ	16GB (4 x 4GB)	SS	-	-	17-18-18-38	1.35V	•	
G.SKILL	F4-3600C17-16GVK	16GB (4 x 4GB)	SS	-	-	17-18-18-38	1.35V	•	•
G.SKILL	F4-3600C17-16GTZ	16GB (4 x 4GB)	SS	-	-	17-18-18-38	1.35V	•	•

DDR4 3466 MHz capability

Vendors	Part No.	Size	SS/DS	Chip Brand	Chip NO.	Timing	Voltage	DIMM socket support (Optional)	
								2	4
CORSAIR	CMD16GX4M4B3466C18	16GB (4 x 4GB)	SS	-	-	18-19-19-38	1.35V	•	•
G.SKILL	F4-3466C16Q-16GRRD	16GB (4 x 4GB)	SS	-	-	16-18-18-38	1.35V	•	•

DDR4 3400 MHz capability

Vendors	Part No.	Size	SS/DS	Chip Brand	Chip NO.	Timing	Voltage	DIMM socket support (Optional)	
								2	4
CORSAIR	CMK16GX4M4B3400C16	16GB (4 x 4GB)	SS	-	-	16-18-18-40	1.35V	•	•
G.SKILL	F4-3400C16Q-16GRKD	16GB (4 x 4GB)	SS	-	-	16-16-16-36	1.35V	•	•
G.SKILL	F4-3400C16Q-16GRBD	16GB (4 x 4GB)	SS	-	-	16-18-18-38	1.35V	•	•

DDR4 3333 MHz capability

Vendors	Part No.	Size	SS/DS	Chip Brand	Chip NO.	Timing	Voltage	DIMM socket support (Optional)	
								2	4
ADATA	AX4U3333W4G16-QRZ	16GB (4 x 4GB)	SS	-	-	16-16-16-36	1.35V	•	•
ADATA	AX4U3333W4G16-DRZ	16GB (4 x 4GB)	SS	-	-	16-16-16-36	1.35V	•	
CORSAIR	CMD16GX4M4B3333C16	16GB (4 x 4GB)	SS	-	-	16-18-18-36	1.35V	•	•
G.SKILL	F4-3333C16Q-16GRRD	16GB (4 x 4GB)	SS	-	-	16-18-18-38	1.35V	•	•

DDR4 3300 MHz capability

Vendors	Part No.	Size	SS/DS	Chip Brand	Chip NO.	Timing	Voltage	DIMM socket support (Optional)	
								2	4
AVEXIR	AVD4U33001604G-4CIR	16GB (4 x 4GB)	SS	-	-	16-18-18-36	1.35V	•	•
ADATA	AX4U3300W4G16-QRZ	16GB (4 x 4GB)	SS	-	-	16-16-16-36	1.35V	•	•
ADATA	AX4U3300W4G16-DRZ	16GB (4 x 4GB)	SS	-	-	16-16-16-36	1.35V	•	
CORSAIR	CMD16GX4M4B3300C16	16GB (4 x 4GB)	SS	-	-	16-18-18-36	1.35V	•	•
CORSAIR	CMK16GX4M4B3300C16	16GB (4 x 4GB)	SS	-	-	16-18-18-36	1.35V	•	•
G.SKILL	F4-3300C16Q-16GRKD	16GB (4 x 4GB)	SS	-	-	16-16-16-36	1.35V	•	•
G.SKILL	F4-3300C16Q-16GRK	16GB (4 x 4GB)	SS	-	-	16-16-16-36	1.35V	•	•

DDR4 3200 MHz capability

Vendors	Part No.	Size	SS/DS	Chip Brand	Chip NO.	Timing	Voltage	DIMM socket support (Optional)	
								2	4
AVEXIR	AVD4U32001604G-4CIR	16GB (4 x 4GB)	SS	-	-	16-18-18-36	1.35V	•	•
ADATA	AX4U3200W4G16-QRZ	16GB (4 x 4GB)	SS	-	-	16-16-16-36	1.35V	•	•
ADATA	AX4U3200W4G16-DRZ	16GB (4 x 4GB)	SS	-	-	16-16-16-36	1.35V	•	
CORSAIR	CMD16GX4M4B3200C16	16GB (4 x 4GB)	SS	-	-	16-18-18-36	1.35V	•	•
CORSAIR	CMK16GX4M4B3200C15	16GB (4 x 4GB)	SS	-	-	15-17-17-35	1.35V	•	•
Kingston	HX432C16PBK4/16	16GB (4 x 4GB)	SS	-	-	16-16-16-39	1.35V	•	•
G.SKILL	F4-3200C16Q-16GRKD	16GB (4 x 4GB)	SS	-	-	16-16-16-36	1.35V	•	•

DDR4 3000 MHz capability

Vendors	Part No.	Size	SS/DS	Chip Brand	Chip NO.	Timing	Voltage	DIMM socket support (Optional)	
								2	4
AVEXIR	AVD4U30001504G-4CIR	16GB (4 x 4GB)	SS	-	-	15-15-15-35	1.35V	•	•
ADATA	AX4U3000W4G16-QRZ	16GB (4 x 4GB)	SS	-	-	16-16-16-36	1.35V	•	•
ADATA	AX4U3000W4G16-DRZ	16GB (4 x 4GB)	SS	-	-	16-16-16-36	1.35V	•	
CORSAIR	CMD16GX4M4B3000C14	16GB (4 x 4GB)	SS	-	-	14-16-16-35	1.35V	•	•
CORSAIR	CMD16GX4M4B3000C15	16GB (4 x 4GB)	SS	-	-	15-17-17-35	1.35V	•	•
Kingston	HX430C15PB2k4/16	16GB (4 x 4GB)	SS	-	-	15-16-16-39	1.35V	•	•
G.SKILL	F4-3000C15Q-16GRRR	16GB (4 x 4GB)	SS	-	-	15-15-15-35	1.35V	•	•
G.SKILL	F4-3000C15Q-16GRK	16GB (4 x 4GB)	SS	-	-	15-15-15-35	1.35V	•	•

DDR4 2800 MHz capability

Vendors	Part No.	Size	SS/DS	Chip Brand	Chip NO.	Timing	Voltage	DIMM socket support (Optional)		
								1	2	4
ADATA	AX4U2800W4G17	32GB (8x 4GB)	DS	-	-	17-17-17-36	1.2	*	*	*
ADATA	AX4U2800W8G17	8GB	DS	-	-	15-15-15-36	1.2	*	*	*
Apacer	78.BAGM8.AF20B (XMP)	4GB	SS	-	-	17-17-17-36	-	*	*	*
Apacer	78.CAGM8.AF30B (XMP)	8GB	DS	-	-	17-17-17-36	-	*	*	*
AVEXIR	AVD4U28001504G-4CIR (XMP)	4GB	SS	-	-	15-15-15-35	1.35	*	*	*
AVEXIR	AVD4U28001608G-4CIR (XMP)	32GB (8x 4GB)	DS	-	-	16-16-16-36	1.2	*	*	*
CORSAIR	CMD16GX4M4A2800C16 (Ver4.23)(XMP)	16GB (4x 4GB)	SS	-	-	16-18-18-36	1.2	*	*	*
CORSAIR	CMD16GX4M4A2800C16 (Ver5.29)	16GB (4x 4GB)	SS	-	-	16-18-18-36	1.2	*	*	*
CORSAIR	CMD32GX4M4A2800C16 (Ver5.29)(XMP)	32GB (4x 8GB)	DS	-	-	18-18-18-36	1.2	*	*	*
CORSAIR	CMK16GX4M4A2800C16 (Ver4.23)(XMP)	16GB (4x 4GB)	SS	-	-	16-16-18-36	1.2	*	*	*
CORSAIR	CMK16GX4M4A2800C16 (Ver5.29)	16GB (4x 4GB)	SS	-	-	16-18-18-36	1.2	*	*	*
CORSAIR	CMK32GX4M4A2800C16 (Ver5.29)(XMP)	32GB (4x 8GB)	DS	-	-	16-18-18-36	1.2	*	*	*
G.SKILL	F4-2800C15Q2-64GRK (XMP)	64GB (8x 8GB)	DS	-	-	15-16-16-35	1.25	*	*	*
G.SKILL	F4-2800C16Q-16GRR (XMP)	16GB (4x 4GB)	SS	-	-	16-16-16-36	1.2	*	*	*
G.SKILL	F4-2800C16Q-32GRR (XMP)	32GB (4x 8GB)	DS	-	-	16-16-16-36	1.2	*	*	*
Kingston	HX428C14PBK4/16 (XMP)	16GB (4x 4GB)	SS	-	-	14-15-15-40-2	1.35	*	*	*
Panram	PUD42800C164G4NJW (XMP)	16GB (4x 4GB)	SS	-	-	2800-16-18-18-36	1.25	*	*	*

DDR4 2666 MHz capability

Vendors	Part No.	Size	SS/DS	Chip Brand	Chip NO.	Timing	Voltage	DIMM socket support (Optional)		
								1	2	4
AVEXIR	AVD4U26661504G-4CIR (XMP)	4GB	SS	-	-	15-15-15-35	1.2	•	•	•
AVEXIR	AVD4U26661608G-4CIR (XMP)	32GB (8x 4GB)	DS	-	-	16-16-16-36	1.2	•	•	•
CORSAIR	CMD16GX4M4A2666C15 (Ver4.23)(XMP)	16GB (4x 4GB)	SS	-	-	15-17-17-35	1.2	•	•	•
CORSAIR	CMD16GX4M4A2666C16 (Ver4.23)(XMP)	16GB (4x 4GB)	SS	-	-	16-18-18-35	1.2	•	•	•
CORSAIR	CMD16GX4M4A2666C16 (Ver5.29)(XMP)	16GB (4x 4GB)	SS	-	-	16-18-18-35	1.2	•	•	•
CORSAIR	CMD32GX4M4A2666C15 (Ver4.23)(XMP)	32GB (4x 8GB)	DS	-	-	15-17-17-35	1.2	•	•	•
CORSAIR	CMD32GX4M4A2666C15 (Ver5.29)	32GB (4x 8GB)	DS	-	-	15-17-17-35	1.2	•	•	•
CORSAIR	CMD32GX4M4A2666C16 (Ver4.23)(XMP)	32GB (4x 8GB)	DS	-	-	16-18-18-35	1.2	•	•	•
CORSAIR	CMK16GX4M4A2666C15 (Ver4.23)(XMP)	16GB (4x 4GB)	SS	-	-	15-17-17-35	1.2	•	•	•
CORSAIR	CMK16GX4M4A2666C15 (Ver5.29)	16GB (4x 4GB)	SS	-	-	15-17-17-35	1.2	•	•	•
CORSAIR	CMK16GX4M4A2666C16 (Ver4.23)(XMP)	16GB (4x 4GB)	SS	-	-	16-18-18-35	1.2	•	•	•
CORSAIR	CMK16GX4M4A2666C16 (Ver5.29)(XMP)	16GB (4x 4GB)	SS	-	-	16-18-18-35	1.2	•	•	•
CORSAIR	CMK32GX4M4A2666C15 (Ver4.23)(XMP)	32GB (4x 8GB)	DS	-	-	15-17-17-35	1.2	•	•	•
CORSAIR	CMK32GX4M4A2666C15 (Ver5.29)(XMP)	32GB (4x 8GB)	DS	-	-	15-17-17-35	1.2	•	•	•
CORSAIR	CMK32GX4M4A2666C16 (Ver5.29)(XMP)	32GB (4x 8GB)	DS	-	-	16-16-18-35	1.2	•	•	•
CORSAIR	CMK32GX4M4A2666C16R (Ver4.23)(XMP)	32GB (4x 8GB)	DS	-	-	16-18-18-35	1.2	•	•	•
G.SKILL	F4-2666C15Q-16GRR (XMP)	16GB (4x 4GB)	SS	-	-	15-15-15-35	1.2	•	•	•
G.SKILL	F4-2666C15Q-32GRR (XMP)	32GB (4x 8GB)	DS	-	-	15-15-15-35	1.2	•	•	•
G.SKILL	F4-2666C16Q2-64GRB (XMP)	64GB (8x 8GB)	DS	-	-	16-16-16-36	1.2	•	•	•
ISDT	IMA41GU6MFR8N-CF0 (XMP)	8GB	DS	ISDT	I5AN4G8NMFR	15-15-15-35	1.2	•	•	•
ISDT	IMA451U6MFR8N-CF0 (XMP)	4GB	SS	ISDT	I5AN4G8NMFR	15-15-15-35	1.2	•	•	•
Team	TCD44G2666C15ABK (XMP)	4GB	SS	Samsung	K4A4G085WD	15-15-15-35	1.2	•	•	•
Team	TCD48G2666C15ABK (XMP)	32GB(4x 8GB)	DS	Team	TCD48G2666C15ABK	15-15-15-35	1.2	•	•	•

DDR4 2400 MHz capability

Vendors	Part No.	Size	SS/DS	Chip Brand	Chip NO.	Timing	Voltage	DIMM socket support (Optional)		
								1	2	4
AVEXIR	AVD4U24001608G-4M	32GB (8x 4GB)	DS	SK Hynix	H5AN4G8NMFRTFC	16-16-16-39	1.2	*	*	*
CORSAIR	CMD16GX4M4A2400C14 (Ver4.23)(XMP)	16GB (4x 4GB)	SS	-	-	14-16-16-31	1.2	*	*	*
CORSAIR	CMK16GX4M4A2400C14 (Ver4.23)(XMP)	16GB (4x 4GB)	SS	-	-	14-16-16-31	1.2	*	*	*
Crucial	BLS4G4D240FSA.8FAD	4GB	SS	-	-	16-16-16-40	1.2	*	*	*
crucial	BLS4G4D240FSA.8FAR (XMP)	4GB	SS	-	-	17-16-16-39-2	1.2	*	*	*
Crucial	BLS8G4D240FSA.16FAD	8GB	DS	-	-	16-16-16-40	1.2	*	*	*
Panram	PUD42400C154G4NJW	16GB (4x 4GB)	SS	-	-	2400-15-15-15-35	1.2	*	*	*
Panram	PUD42400C158G4NJW	32GB (4x 8GB)	DS	-	-	2400-15-15-15-35	1.2	*	*	*
Team	TED44GM2400C16BK	4GB	SS	Samsung	K4A4G085WD	16-16-16-39	1.2	*	*	*
Team	TED48GM2400C16BK	8GB	DS	Samsung	K4A4G085WD	16-16-16-39	1.2	*	*	*
V-color	TD4G8C17-UH	4GB	SS	V-color	DW3J0460HM	2400-15-15-15-36	1.2	*	*	*

DDR4 2133 MHz capability

Vendors	Part No.	Size	SS/DS	Chip Brand	Chip NO.	Timing	Voltage	DIMM socket support (Optional)		
								1	2	4
ADATA	AD4U2133W4G15-B	4GB	SS	SK Hynix	H5AN4G8NMFRTFC	15-15-15-36	-	*	*	*
ADATA	AD4U2133W8G15	8GB	DS	SK Hynix	H5AN4G8NMFRTFC	15-15-15-36	1.2	*	*	*
Apacer	78.B1GM3.AF00B	4GB	SS	SK Hynix	H5AN4G8NMFRTFC	15-15-15-36	1.2	*	*	*
Apacer	78.C1GM3.AF10B	8GB	DS	SK Hynix	H5AN4G8NMFRTFC	15-15-15-36	1.2	*	*	*
AVEXIR	AVD4U21331504G-4M	4GB	SS	AVEXIR	512X8DDR4	15-15-15-35	1.2	*	*	*
Century	CD8G-D4U2133	8GB	DS	SK Hynix	H5AN4G8NMFRTFC	15-15-15-36	-	*	*	*
CORSAIR	CMK16GX4M4A2133C13 (Ver4.23)(XMP)	16GB (4x 4GB)	SS	-	-	13-15-15-28	1.2	*	*	*
CORSAIR	CMK32GX4M4A2133C13 (Ver4.23)(XMP)	32GB (4x 8GB)	DS	-	-	13-15-15-28	1.2	*	*	*
CORSAIR	CMK64GX4M8A2133C13 (Ver4.23)(XMP)	64GB (8x 8GB)	DS	-	-	13-15-15-28	1.2	*	*	*
CORSAIR	CMV4GX4M1A2133C15	4GB	SS	-	-	15-15-15-36	1.2	*	*	*
CORSAIR	CMV8GX4M1A2133C15	8GB	DS	-	-	15-15-15-36	1.2	*	*	*
G.SKILL	F4-2133C15Q-16GRR	16GB (4x 4GB)	SS	-	-	15-15-15-35	1.2	*	*	*
G.SKILL	F4-2133C15Q-32GRR	32GB (4x 8GB)	DS	-	-	15-15-15-35	-	*	*	*
ISDT	IMA41GU6MFR8N-TF0	8GB	DS	ISDT	I5AN4G8NMFR	15-15-15-35	1.2	*	*	*
ISDT	IMA451U6MFR8N-TF0	4GB	SS	ISDT	I5AN4G8NMFR	15-15-15-35	1.2	*	*	*
Panram	PUD42133C134G4NJW	16GB (4x 4GB)	SS	-	-	2133-13-13-13-35	1.2	*	*	*
Panram	PUD42133C138G4NJW	32GB (4x 8GB)	DS	-	-	2133-13-13-13-35	1.2	*	*	*
Panram	PUD42133C154G2VS	8GB (2x 4GB)	SS	SK Hynix	H5AN4G8NMFRTFC	2133-15-15-15-36	1.2	*	*	*
Panram	PUD42133C154GNJK	4GB	SS	-	-	15-15-15-36	1.2	*	*	*

(continued on the next page)

DDR4 2133 MHz capability

Vendors	Part No.	Size	SS/DS	Chip Brand	Chip NO.	Timing	Voltage	DIMM socket support (Optional)		
								1	2	4
Panram	PUD42133C158G2VS	16GB (2x 8GB)	DS	SK Hynix	H5AN4GBNMFRTFC	2133-15-15-15-36	1.2	*	*	*
Panram	PUD42133C158GNJK	8GB	DS	-	-	15-15-15-36	1.2	*	*	*
SanMax	SMD-4G28HP-21P	4GB	SS	SK Hynix	H5AN4G8NMFRTFC	15-15-37-2	-	*	*	*
SanMax	SMD-8G28HP-21P	8GB	DS	SK Hynix	H5AN4G8NMFRTFC	15-15-37-2	-	*	*	*
SUPER TALENT	FBU2B008GM	8GB	DS	Micron	D9RGQ	15-15-15-36	1.2	*	*	*
Team	TED44GM2133C15ABK	4GB	SS	SK Hynix	H5AN4G8NMFRTFC	15-15-15-36	1.2	*	*	*
Transcend	TS1GLH64V1H	8GB	DS	Samsung	K4A4G085WD	2133-15-15-15-37	-	*	*	*
Transcend	TSS12MLH64V1H	4GB	SS	Samsung	K4A4G085WD	2133-15-15-15-37	-	*	*	*
UMAX	84G44G93MC-21OMCALGF15	4GB	SS	Micron	D9RGQ	15-15-15-36	-	*	*	*
UMAX	84G48G93MC-21OMCGNGF15	8GB	DS	Micron	D9RGQ	15-15-15-36	-	*	*	*



Side(s): SS - Single-sided DS - Double-sided DIMM support:

- (1) Supports one (1) module inserted into any slot as Single-channel memory configuration. We suggest that you install the module into A2 slot.
- (2) Supports two (2) modules inserted into either the grey slots or the black slots as one pair of Dual-channel memory configuration. We suggest that you install the modules into slots A2 and B2 for better compatibility.
- (4) Supports four (4) modules inserted into both the grey and black slots as two pairs of Dual-channel memory configuration.



- ASUS exclusively provides hyper DIMM support function.
- Hyper DIMM support is subject to the physical characteristics of individual CPUs. Load the X.M.P. settings in the BIOS for the hyper DIMM support.
- Visit the ASUS website for the latest QVL.

1.2.5 Expansion slots



Unplug the power cord before adding or removing expansion cards. Failure to do so may cause you physical injury and damage motherboard components.

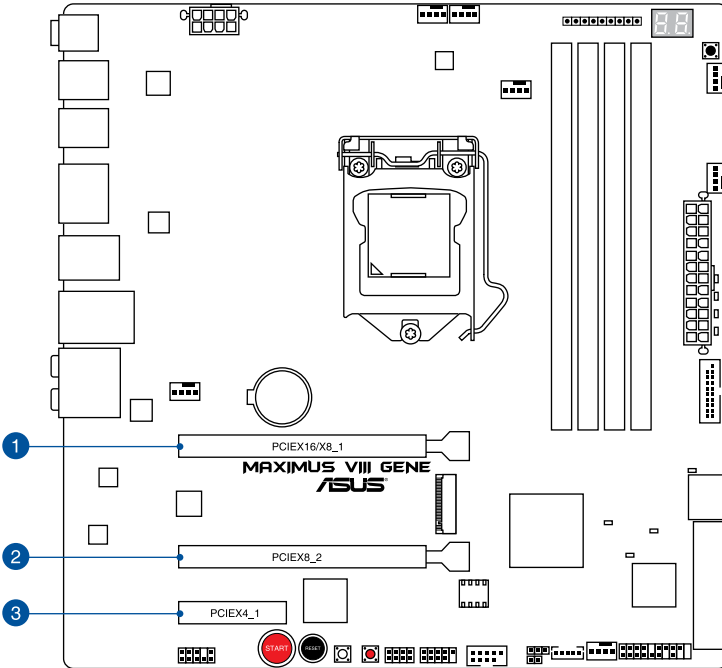

Slot No.	Slot Description
1	PCIe 3.0 x16/x8_1 slot
2	PCIe 3.0 x8_2 slot
3	PCIe 3.0 x4_1 slot

IRQ assignments for this motherboard

	A	B	C	D	E	F	G	H
PCIEX16/X8_1	shared	-	-	-	-	-	-	-
PCIEX8_2	-	shared	-	-	-	-	-	-
PCIEX4_1	shared	-	-	-	-	-	-	-
Intel Lan Controller	shared	-	-	-	-	-	-	-
M.2 (SATA Controller)	-	-	-	-	-	-	-	shared
High Definition Audio	shared	-	-	-	-	-	-	-
XHCI (USB 3.0)	shared	-	-	-	-	-	-	-
Asmedia 1142 USB3.1 Controller	shared	-	-	-	-	-	-	-
I.G.F.X	shared	-	-	-	-	-	-	-

VGA Configuration	PCIe operating mode	
	PCIEX16/X8_1	PCIEX8_2
Single VGA/PCIe card	x16 (Recommend for single VGA)	N/A
Dual VGA/PCIe card	x8	x8



- We recommend that you provide sufficient power when running CrossFireX™ or SLI® mode.
- Connect a chassis fan to the motherboard connector labeled CHA_FAN1-4 when using multiple graphics cards for better thermal environment.
- New 6th generation Intel® Core™ processors support PCIe 3.0 speed rate.



PCIe_x16/x8_1 slot switches to x8 mode when PCIe_x8_2 slot is occupied.

1.2.6 Onboard buttons

Onboard buttons allow you to fine-tune performance when working on a bare or open-case system. This is ideal for overclockers and gamers who continually change settings to enhance system performance.

1. Power-on button (START)

The motherboard comes with a power-on button that allows you to power up or wake up the system. The button also lights up when the system is plugged to a power source indicating that you should shut down the system and unplug the power cable before removing or installing any motherboard component.

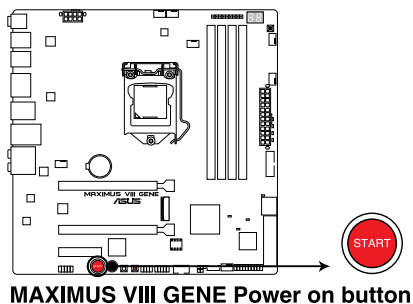

2. RESET button (RESET)

Press the reset button to reboot the system.

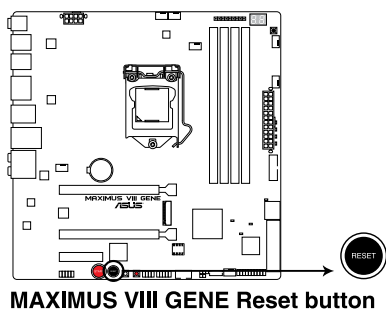

3. ReTry button (RETRY_BUTTON)

The ReTry button is specially designed for overclockers and is most useful during the booting process where the Reset button is rendered useless. When pressed, it forces the system to reboot while retaining the same settings to be retried in quick succession to achieve a successful POST.

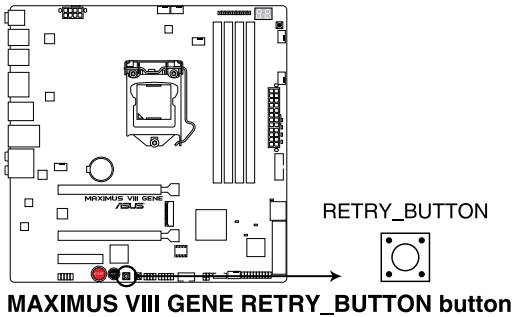

4. Safe Boot button (SAFE_BOOT)

The Safe Boot button can be pressed anytime to force the system to reboot into the BIOS safe mode. This button temporarily applies safe settings to the BIOS while retaining any overclocked settings allowing you to modify the settings causing boot failure. Use this button when overclocking or tweaking the settings of your system.

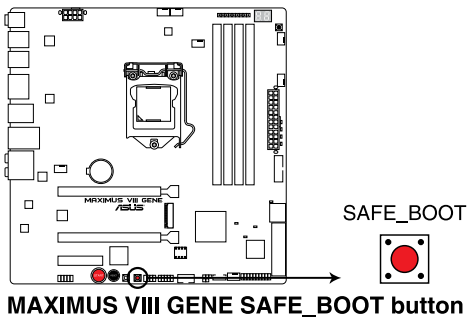

5. MemOK! button (MemOK!)

Installing DIMMs that are not compatible with the motherboard may cause system boot failure, and the DRAM_LED near the MemOK! button lights continuously. Press and hold the MemOK! button until the DRAM_LED starts blinking to begin automatic memory compatibility tuning for successful boot.

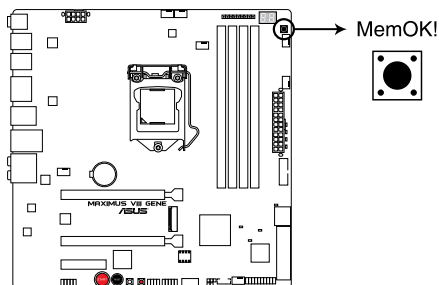

MAXIMUS VIII GENE MemOK! button



- Refer to section **Onboard LEDs** for the exact location of the DRAM_LED.
- The DRAM_LED also lights up when the DIMM is not properly installed. Turn off the system and reinstall the DIMM before using the MemOK! function.
- The MemOK! button does not function under Windows® OS environment.
- During the tuning process, the system loads and tests failsafe memory settings. It takes about 30 seconds for the system to test one set of failsafe settings. If the test fails, the system reboots and test the next set of failsafe settings. The blinking speed of the DRAM_LED increases, indicating different test processes.
- Due to memory tuning requirement, the system automatically reboots when each timing set is tested. If the installed DIMMs still fail to boot after the whole tuning process, the DRAM_LED lights continuously. Replace the DIMMs with ones recommended in the Memory QVL (Qualified Vendors Lists) in this user manual or at www.asus.com.
- If you turn off the computer and replace DIMMs during the tuning process, the system continues memory tuning after turning on the computer. To stop memory tuning, turn off the computer and unplug the power cord for about 5–10 seconds.
- If your system fails to boot up due to BIOS overclocking, press the MemOK! button to boot and load the BIOS default settings. A message will appear during POST reminding you that the BIOS has been restored to its default settings.
- We recommend that you download and update to the latest BIOS version from www.asus.com after using the MemOK! function.

1.2.7 Onboard LEDs

1. Hard Disk LED (HD_LED)

The Hard Disk LED is designed to indicate the hard disk activity. It blinks when data is being written into or read from the hard disk drive. The LED does not light up when there is no hard disk drive connected to the motherboard or when the hard disk drive does not function.

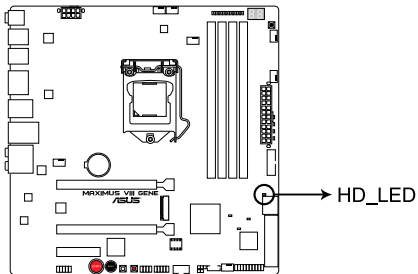

MAXIMUS VIII GENE Hard Disk LED

2. Q LEDs (BOOT_DEVICE_LED, VGA_LED, DRAM_LED, CPU_LED)

Q LEDs check key components (CPU, DRAM, VGA card, and booting devices) in sequence during motherboard booting process. If an error is found, the corresponding LED flashes until the problem is solved. This user-friendly design provides an intuitive way to locate the root problem within seconds.

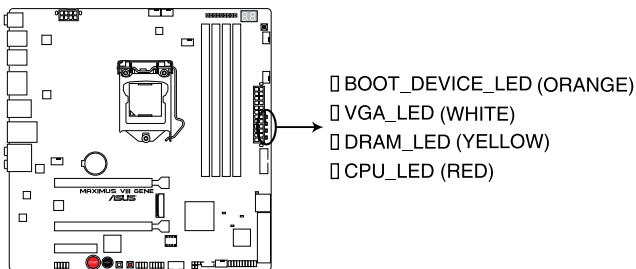

**MAXIMUS VIII GENE CPU/ DRAM/
BOOT_DEVICE/ VGA LED**

3. PCH_LED (PCH_LED1-3)

The PCH_LED is designed to indicate the PCH voltage and PCH PLL voltage.

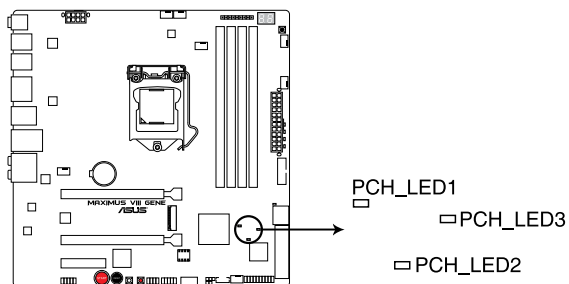

MAXIMUS VIII GENE PCH_LED

4. Q-Code LED

The Q-Code LED design provides you with a 2-digit error code that displays the system status. Refer to the Q-Code table on the following page for details.

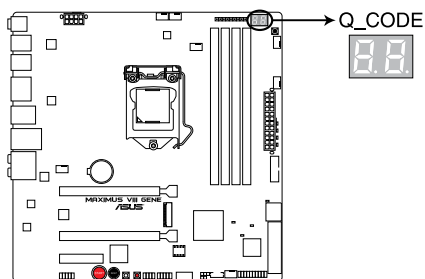

MAXIMUS VIII GENE Q-Code LED

Q-Code table

Code	Description
00	Not used
01	Power on. Reset type detection (soft/hard).
02	AP initialization before microcode loading
03	System Agent initialization before microcode loading
04	PCH initialization before microcode loading
06	Microcode loading
07	AP initialization after microcode loading
08	System Agent initialization after microcode loading
09	PCH initialization after microcode loading
0B	Cache initialization
0C – 0D	Reserved for future AMI SEC error codes
0E	Microcode not found
0F	Microcode not loaded
10	PEI Core is started
11 – 14	Pre-memory CPU initialization is started
15 – 18	Pre-memory System Agent initialization is started
19 – 1C	Pre-memory PCH initialization is started
2B – 2F	Memory initialization
30	Reserved for ASL (see ASL Status Codes section below)
31	Memory Installed
32 – 36	CPU post-memory initialization
37 – 3A	Post-Memory System Agent initialization is started
3B – 3E	Post-Memory PCH initialization is started
4F	DXE IPL is started
50 – 53	Memory initialization error. Invalid memory type or incompatible memory speed
54	Unspecified memory initialization error
55	Memory not installed
56	Invalid CPU type or Speed
57	CPU mismatch
58	CPU self test failed or possible CPU cache error
59	CPU micro-code is not found or micro-code update is failed

(continued on the next page)

Q-Code table

Code	Description
10	PEI Core is started
11 – 14	Pre-memory CPU initialization is started
15 – 18	Pre-memory System Agent initialization is started
19 – 1C	Pre-memory PCH initialization is started
2B – 2F	Memory initialization
30	Reserved for ASL (see ASL Status Codes section below)
31	Memory Installed
32 – 36	CPU post-memory initialization
37 – 3A	Post-Memory System Agent initialization is started
3B – 3E	Post-Memory PCH initialization is started
4F	DXE IPL is started
50 – 53	Memory initialization error. Invalid memory type or incompatible memory speed
54	Unspecified memory initialization error
55	Memory not installed
56	Invalid CPU type or Speed
57	CPU mismatch
58	CPU self test failed or possible CPU cache error
59	CPU micro-code is not found or micro-code update is failed
5A	Internal CPU error
5B	Reset PPI is not available
5C – 5F	Reserved for future AMI error codes
E0	S3 Resume is started (S3 Resume PPI is called by the DXE IPL)
E1	S3 Boot Script execution
E2	Video repost
E3	OS S3 wake vector call
E4 – E7	Reserved for future AMI progress codes
E8	S3 Resume Failed
E9	S3 Resume PPI not Found
EA	S3 Resume Boot Script Error
EB	S3 OS Wake Error
EC – EF	Reserved for future AMI error codes

(continued on the next page)

Q-Code table

Code	Description
F0	Recovery condition triggered by firmware (Auto recovery)
F1	Recovery condition triggered by user (Forced recovery)
F2	Recovery process started
F3	Recovery firmware image is found
F4	Recovery firmware image is loaded
F5 – F7	Reserved for future AMI progress codes
F8	Recovery PPI is not available
F9	Recovery capsule is not found
FA	Invalid recovery capsule
FB – FF	Reserved for future AMI error codes
60	DXE Core is started
61	NVRAM initialization
62	Installation of the PCH Runtime Services
63 – 67	CPU DXE initialization is started
68	PCI host bridge initialization
69	System Agent DXE initialization is started
6A	System Agent DXE SMM initialization is started
6B – 6F	System Agent DXE initialization (System Agent module specific)
70	PCH DXE initialization is started
71	PCH DXE SMM initialization is started
72	PCH devices initialization
73 – 77	PCH DXE Initialization (PCH module specific)
78	ACPI module initialization
79	CSM initialization
7A – 7F	Reserved for future AMI DXE codes
90	Boot Device Selection (BDS) phase is started
91	Driver connecting is started
92	PCI Bus initialization is started
93	PCI Bus Hot Plug Controller Initialization
94	PCI Bus Enumeration
95	PCI Bus Request Resources

(continued on the next page)

Q-Code table

Code	Description
96	PCI Bus Assign Resources
97	Console Output devices connect
98	Console input devices connect
99	Super IO Initialization
9A	USB initialization is started
9B	USB Reset
9C	USB Detect
9D	USB Enable
9E – 9F	Reserved for future AMI codes
A0	IDE initialization is started
A1	IDE Reset
A2	IDE Detect
A3	IDE Enable
A4	SCSI initialization is started
A5	SCSI Reset
A6	SCSI Detect
A7	SCSI Enable
A8	Setup Verifying Password
A9	Start of Setup
AA	Reserved for ASL (see ASL Status Codes section below)
AB	Setup Input Wait
AC	Reserved for ASL (see ASL Status Codes section below)
AD	Ready To Boot event
AE	Legacy Boot event
AF	Exit Boot Services event
B0	Runtime Set Virtual Address MAP Begin
B1	Runtime Set Virtual Address MAP End
B2	Legacy Option ROM Initialization
B3	System Reset
B4	USB hot plug
B5	PCI bus hot plug

(continued on the next page)

Q-Code table

Code	Description
B6	Clean-up of NVRAM
B7	Configuration Reset (reset of NVRAM settings)
B8– BF	Reserved for future AMI codes
D0	CPU initialization error
D1	System Agent initialization error
D2	PCH initialization error
D3	Some of the Architectural Protocols are not available
D4	PCI resource allocation error. Out of Resources
D5	No Space for Legacy Option ROM
D6	No Console Output Devices are found
D7	No Console Input Devices are found
D8	Invalid password
D9	Error loading Boot Option (LoadImage returned error)
DA	Boot Option is failed (StartImage returned error)
DB	Flash update is failed
DC	Reset protocol is not available

ACPI/ASL Checkpoints

Code	Description
0x01	System is entering S1 sleep state
0x02	System is entering S2 sleep state
0x03	System is entering S3 sleep state
0x04	System is entering S4 sleep state
0x05	System is entering S5 sleep state
0x10	System is waking up from the S1 sleep state
0x20	System is waking up from the S2 sleep state
0x30	System is waking up from the S3 sleep state
0x40	System is waking up from the S4 sleep state
0xAC	System has transitioned into ACPI mode. Interrupt controller is in PIC mode.
0xAA	System has transitioned into ACPI mode. Interrupt controller is in APIC mode.

1.2.8 Jumper

1. LN2 Mode jumper (3-pin LN2_MODE)

With LN2 mode activated, the ROG motherboard is optimized to remedy the cold-boot bug during POST and help the system boot successfully.

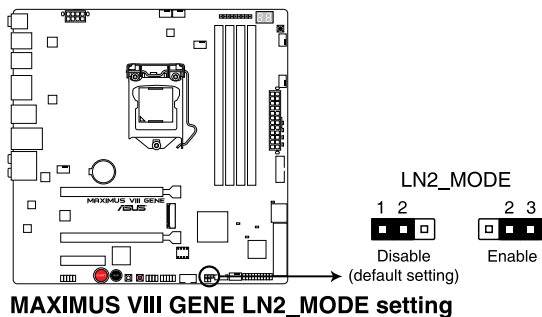

1.2.9 Internal connectors

1. Intel® Z170 Serial ATA 6 Gb/s connectors (7-pin SATA6G_12; SATAEXPRESS12)

These connectors connect to Serial ATA 6 Gb/s hard disk drives via Serial ATA 6 Gb/s signal cables.

If you installed Serial ATA hard disk drives, you can create a RAID 0, 1, 5, and 10 configuration with the Intel® Rapid Storage Technology through the onboard Intel® Z170 chipset.

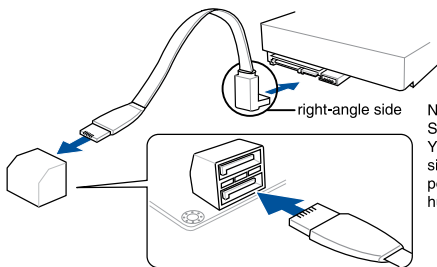
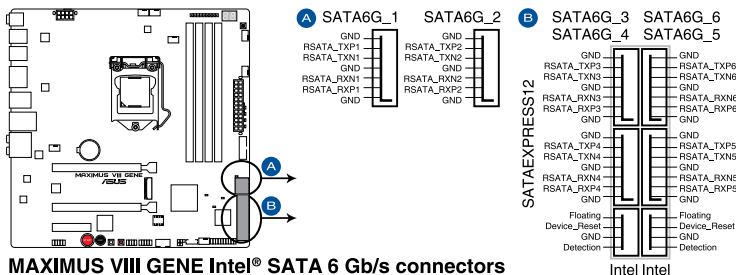

NOTE: Connect the right-angle side of SATA signal cable to SATA device. You may also connect the right-angle side of SATA cable to the onboard SATA port to avoid mechanical conflict with huge graphics cards.



- These connectors are set to **[AHCI Mode]** by default. If you intend to create a Serial ATA RAID set using these connectors, set the SATA Mode item in the BIOS to **[RAID Mode]**. Refer to section **PCH Storage Configuration** for details.
- Before creating a RAID set, refer to section **RAID configurations** or the manual bundled in the motherboard support DVD.
- When using NCQ, set the SATA Mode in the BIOS to **[AHCI Mode]**. Refer to section **PCH Storage Configuration** for details.

2. USB 3.0 connector (20-1 pin USB3_12)

This connector allows you to connect a USB 3.0 module for additional USB 3.0 front or rear panel ports. With an installed USB 3.0 module, you can enjoy all the benefits of USB 3.0 including faster data transfer speeds of up to 5 Gbps, faster charging time for USB-chargeable devices, optimized power efficiency, and backward compatibility with USB 2.0.

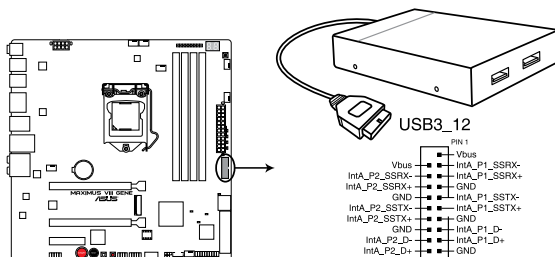

MAXIMUS VIII GENE USB3.0 connector



The USB 3.0 module is purchased separately.



- These connectors are based on xHCI specification. We recommend you to install the related driver to fully use the USB 3.0 ports under Windows® 7, Windows® 8, and Windows® 8.1.
 - The plugged USB 3.0 device may run on xHCI or EHCI mode depending on the operating system's setting.
-

3. USB 2.0 connectors (10-1 pin USB1314, USB1112)

These connectors are for USB 2.0 ports. Connect the USB module cable to any of these connectors, then install the module to a slot opening at the back of the system chassis. These USB connectors comply with USB 2.0 specification that supports up to 480 MBps connection speed.

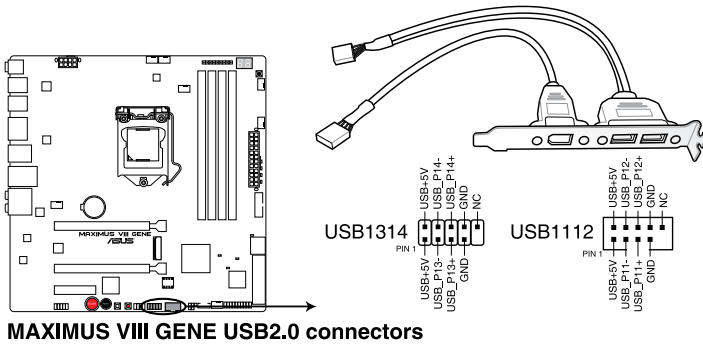

Never connect a 1394 cable to the USB connectors. Doing so will damage the motherboard!



You can connect the front panel USB cable to the ASUS Q-Connector (USB) first, and then install the Q-Connector (USB) to the USB connector onboard if your chassis supports front panel USB ports.



1 x USB 2.0 ports (USB1314) at mid-board shares with ROG extension (ROG_EXT) port.

4. Front panel audio connector (10-1 pin AAFP)

This connector is for a chassis-mounted front panel audio I/O module that supports HD Audio standard. Connect one end of the front panel audio I/O module cable to this connector.

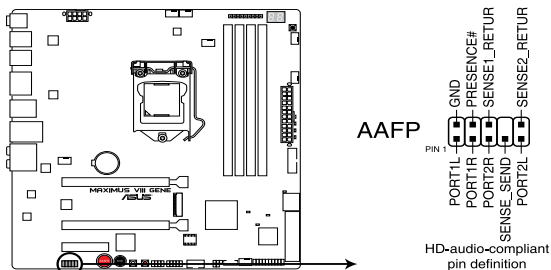

MAXIMUS VIII GENE Analog front panel connector



We recommend that you connect a high-definition front panel audio module to this connector to avail of the motherboard's high-definition audio capability.

5. CPU, water pump, CPU optional, extension, and chassis fan connectors (4-pin CPU_FAN; 4-pin W_PUMP; 4-pin CPU_OPT; 5-pin EXT_FAN; 4-pin CHA_FAN1-4)

Connect the fan cables to the fan connectors on the motherboard, ensuring that the black wire of each cable matches the ground pin of the connector.

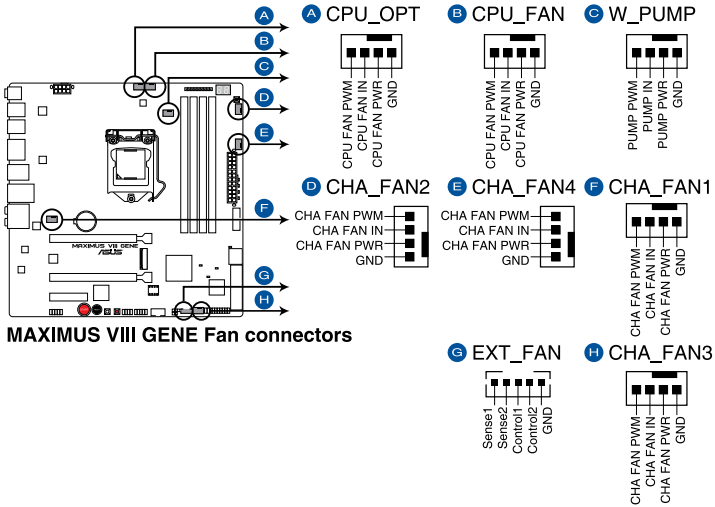

- DO NOT forget to connect the fan cables to the fan connectors. Insufficient air flow inside the system may damage the motherboard components. These are not jumpers! Do not place jumper caps on the fan connectors!
- Ensure to fully insert the 4-pin CPU fan cable to the CPU fan connector.



The CPU_FAN connector supports the CPU fan of maximum 1A (12 W) fan power.

6. ATX power connectors (24-pin EATXPWR; 8-pin EATX12V)

These connectors are for ATX power supply plugs. The power supply plugs are designed to fit these connectors in only one orientation. Find the proper orientation and push down firmly until the connectors completely fit.

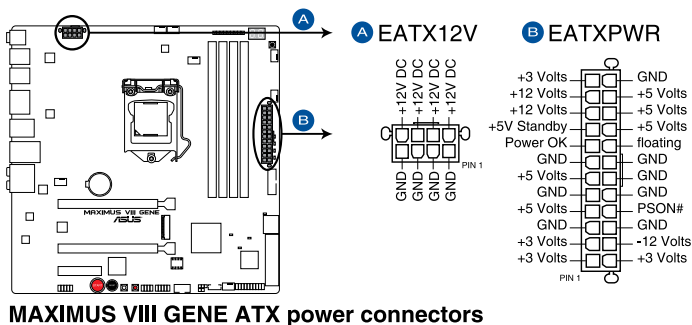

- For a fully configured system, we recommend that you use a power supply unit (PSU) that complies with ATX 12 V Specification 2.0 (or later version) and provides a minimum power of 350 W.
- Do not forget to connect the 4-pin/8-pin EATX12 V power plug. Otherwise, the system will not boot.
- We recommend that you use a PSU with a higher power output when configuring a system with more power-consuming devices. The system may become unstable or may not boot up if the power is inadequate.
- If you want to use two or more high-end PCIe x16 cards, use a PSU with 1000W power or above to ensure the system stability.
- If you are uncertain about the minimum power supply requirement for your system, refer to the Recommended Power Supply Wattage Calculator at <http://support.asus.com/PowerSupplyCalculator/PSCalculator.aspx?SLanguage=en-us> for details.

7. System panel connector (20-5 pin PANEL)

This connector supports several chassis-mounted functions.

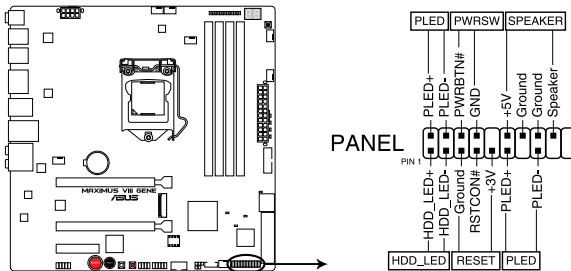

MAXIMUS VIII GENE System panel connector

- **System power LED (3-1 pin or 2-pin PLED)**

This 3-1 pin or 2-pin connector is for the system power LED. Connect the chassis power LED cable to this connector. The system power LED lights up when you turn on the system power, and blinks when the system is in sleep mode.

- **Hard disk drive activity LED (2-pin HDD_LED)**

This 2-pin connector is for the HDD Activity LED. Connect the HDD Activity LED cable to this connector. The HDD LED lights up or flashes when data is read from or written to the HDD.

- **System warning speaker (4-pin SPEAKER)**

This 4-pin connector is for the chassis-mounted system warning speaker. The speaker allows you to hear system beeps and warnings.

- **ATX power button/soft-off button (2-pin PWRSW)**

This connector is for the system power button. Pressing the power button turns the system on or puts the system in sleep or soft-off mode depending on the BIOS settings. Pressing the power button for more than four seconds while the system is ON turns the system OFF.

- **Reset button (3-pin RESET)**

This 3-pin connector is for the chassis-mounted reset button for system reboot without turning off the system power.

8. ROG Extension - ROG_EXT connector (18-1 pin ROG_EXT)

This connector is for the OC Panel, Front Base, and the other ROG device.

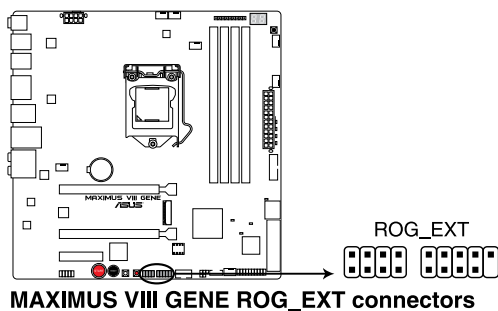

- The OC Panel and Front Base are purchased separately.
- Visit www.asus.com for more information about the OC Panel and Front Base.

9. T_Sensor connector (2-pin T_SENSOR1)

This connector is for the thermistor cable that allows you to monitor the temperature of your motherboard's critical components and connected devices.

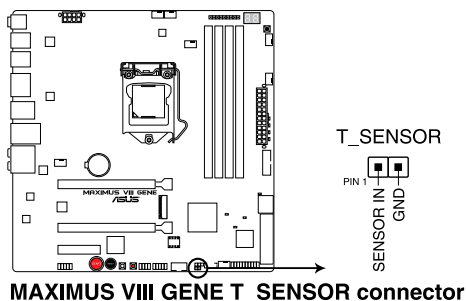

10. M.2 (Socket 3)

The M.2 (Socket 3) with M Key supports type 2242 (22mm x 42mm), 2260 (22mm x 60mm), 2280 (22mm x 80mm), and 22110 (22mm x 110mm) PCIe/SATA interface storage devices.

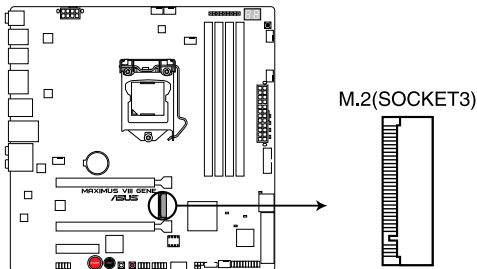

MAXIMUS VIII GENE M.2(SOCKET3)



When the M.2 (Socket 3) is operating in SATA mode, SATA port 1 (SATA6G_12) will be disabled.

1.2.10 ProbelT

The ROG ProbelT allows you to detect your system's current voltage and OC settings. Use a multimeter to measure the ProbelT points even during overclocking.

See the illustration below to locate the respective ProbelT points.

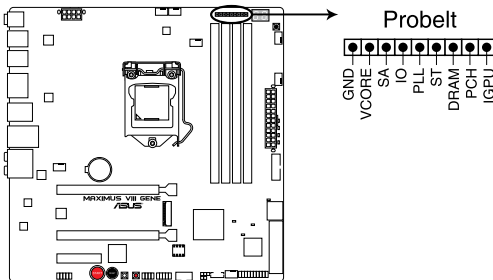

MAXIMUS VIII GENE ProbelT

Basic Installation

2

2.1 Building your PC system

2.1.1 Motherboard installation



The diagrams in this section are for reference only. The motherboard layout may vary with models, but the installation steps are the same for all models.

1. Install the ASUS Q-Shield to the chassis rear I/O panel.

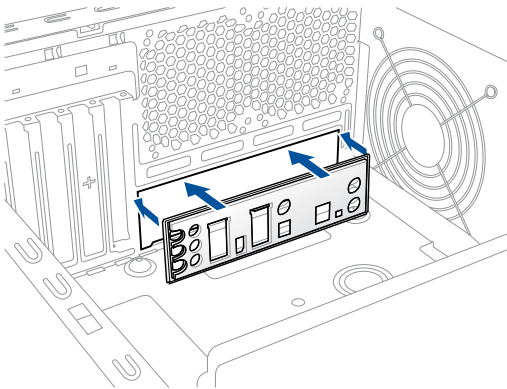

2. Place the motherboard into the chassis, ensuring that its rear I/O ports are aligned to the chassis' rear I/O panel.

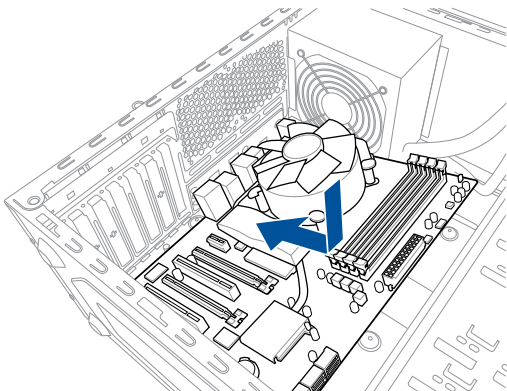

3. Place nine screws into the holes indicated by circles to secure the motherboard to the chassis.

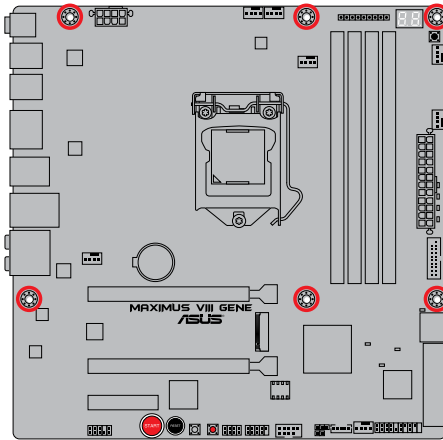
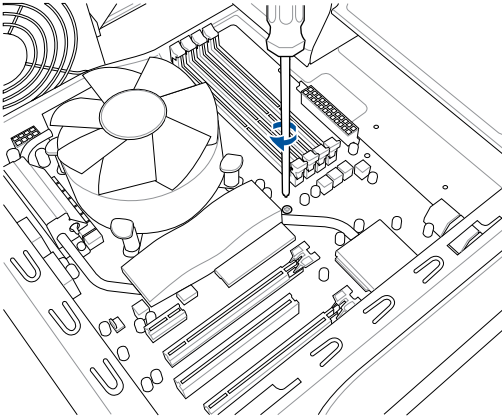

DO NOT over tighten the screws! Doing so can damage the motherboard.

2.1.2 CPU installation



Ensure that you install the correct CPU designed for LGA1151 socket only. DO NOT install a CPU designed for LGA1155 and LGA1156 sockets on the LGA1151 socket.

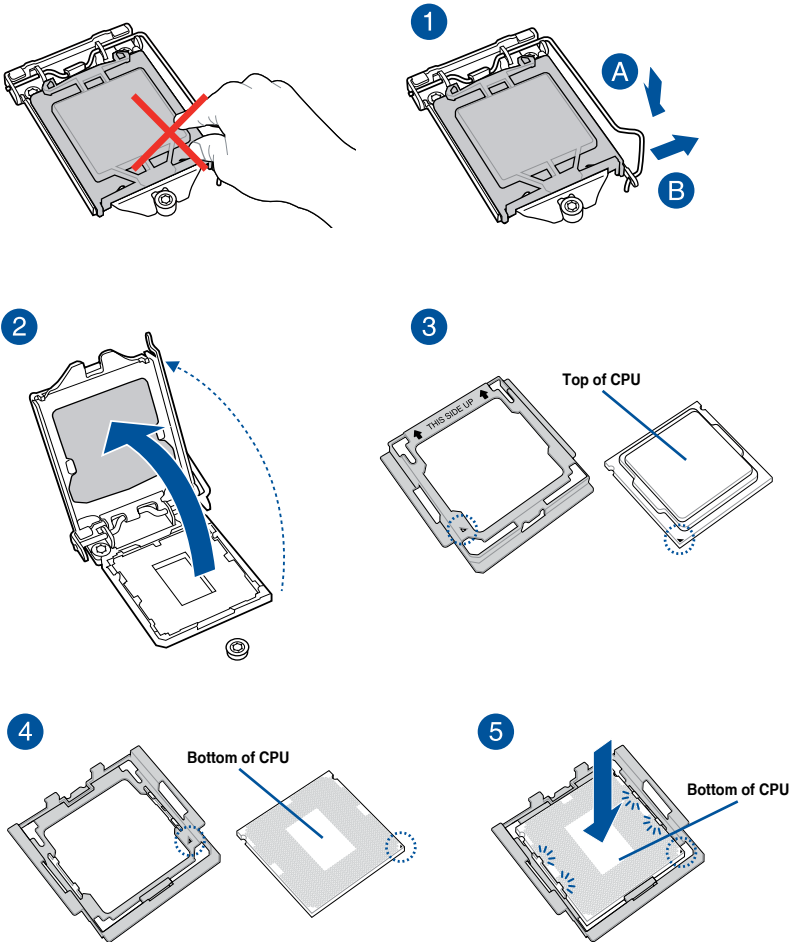

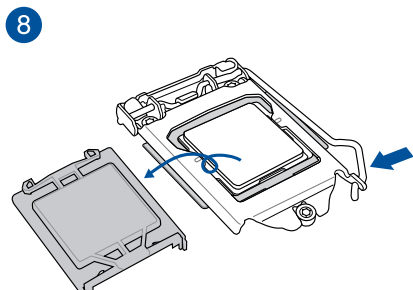
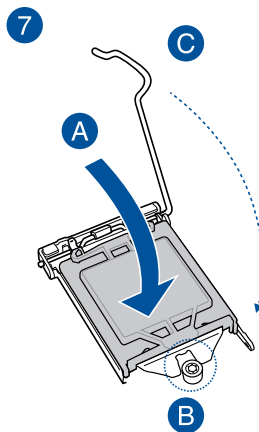
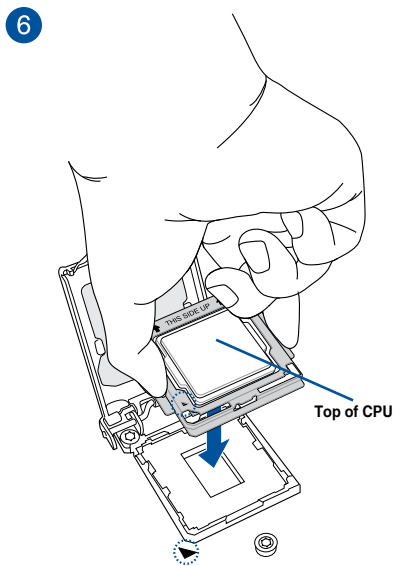

WARNING!

- Ensure that the CPU is firmly clicked into place before installing it onto the CPU socket on the motherboard.
- Use the CPU Installation Tool for installing the CPU only. DO NOT damage or bend the CPU Installation Tool.
- Always firmly hold both sides of the CPU Installation Tool when installing, removing, or picking up the CPU Installation Tool.
- ASUS will not cover damages resulting from incorrect CPU installation/removal, incorrect CPU orientation/placement, or other damages resulting from negligence by the user.

2.1.3 CPU heatsink and fan assembly installation

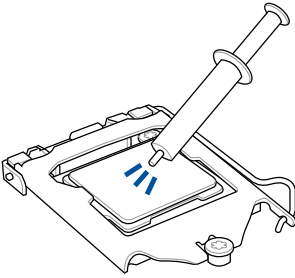

Apply the Thermal Interface Material to the CPU heatsink and CPU before you install the heatsink and fan, if necessary.

To install the CPU heatsink and fan assembly

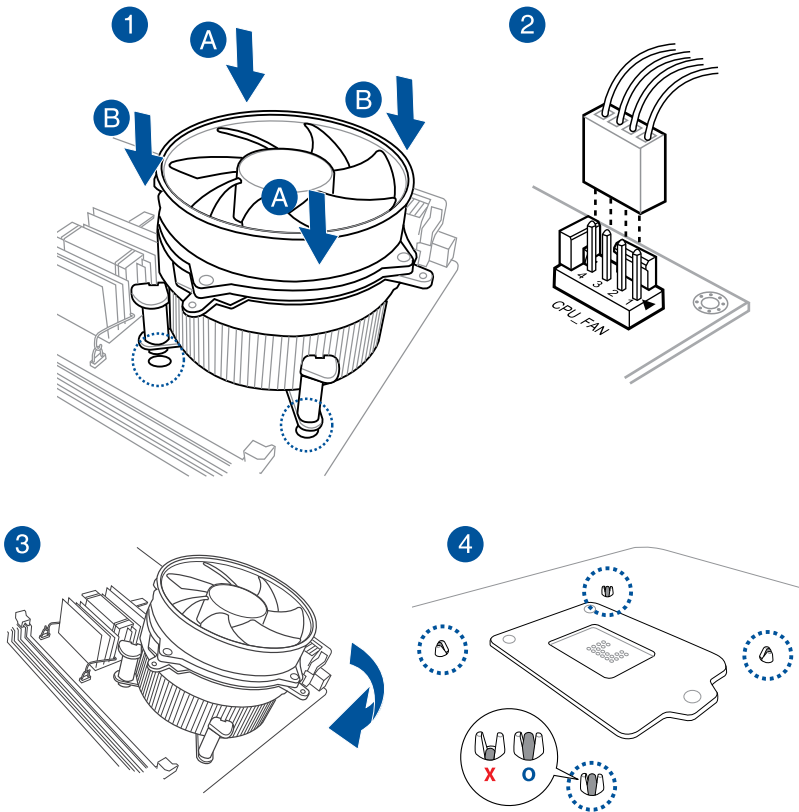

To uninstall the CPU heatsink and fan assembly

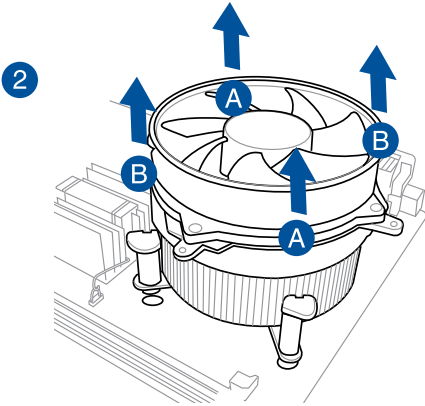
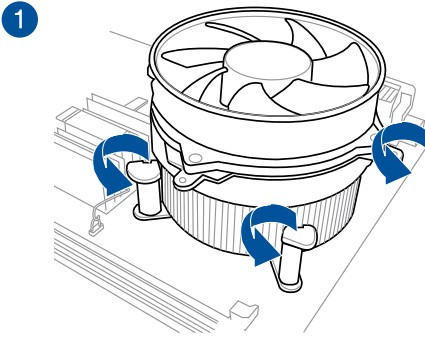

2.1.4 DIMM installation

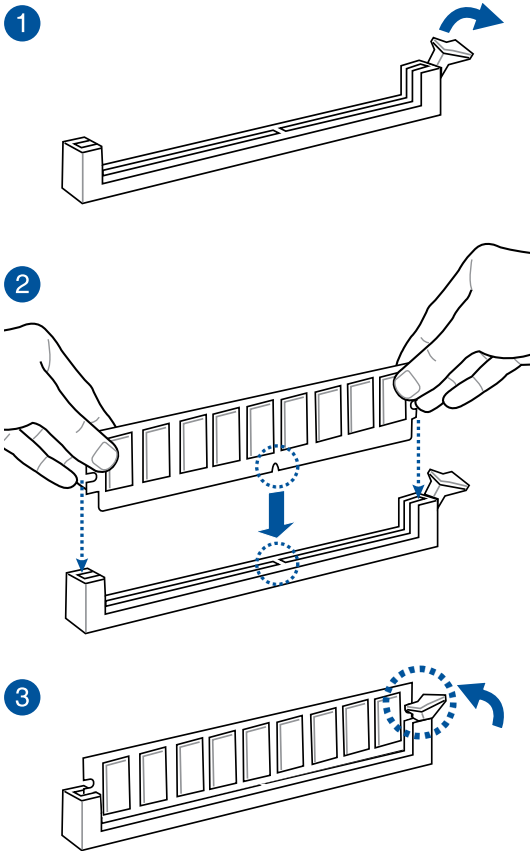

To remove a DIMM

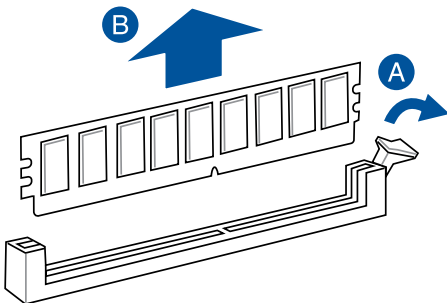

2.1.5 ATX Power connection

1

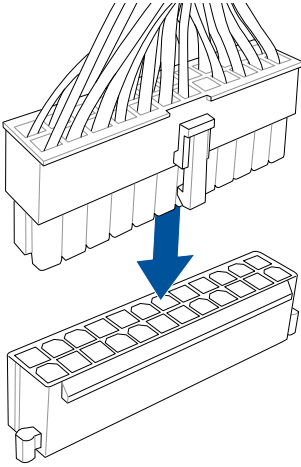

2

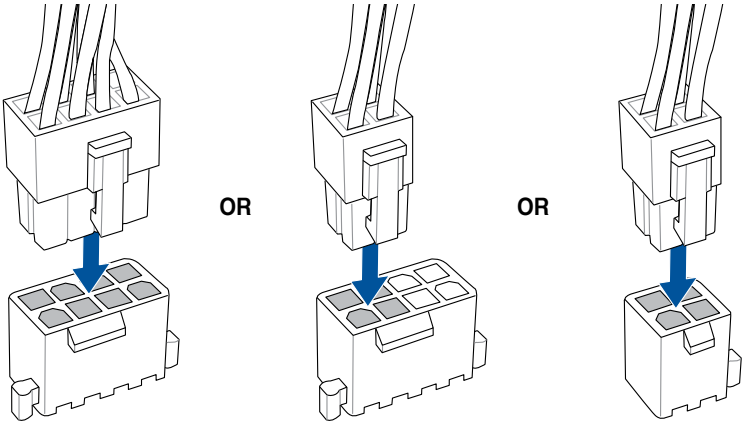

2.1.6 SATA device connection

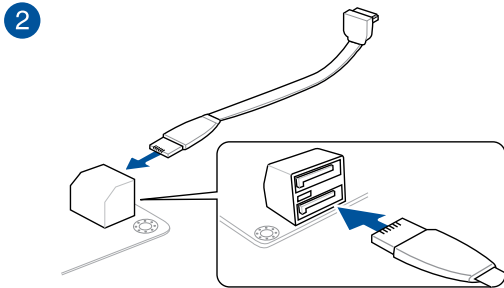
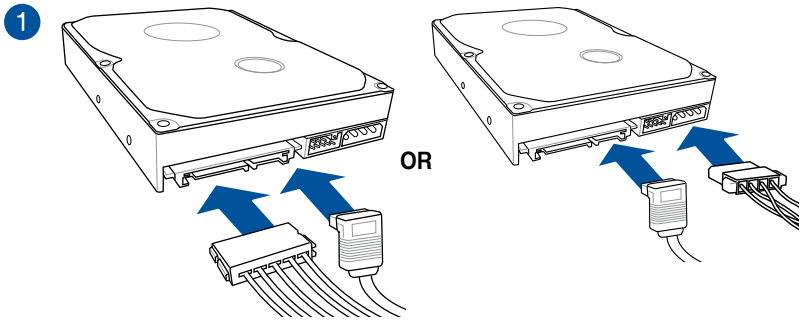

OR

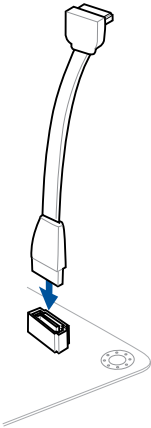

2.1.7 Front I/O Connector

To install ASUS Q-Connector

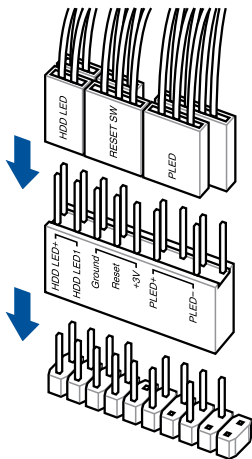

To install USB 2.0 connector

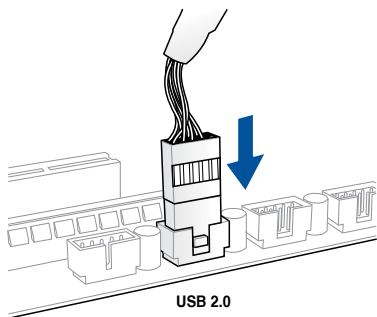

To install front panel audio connector

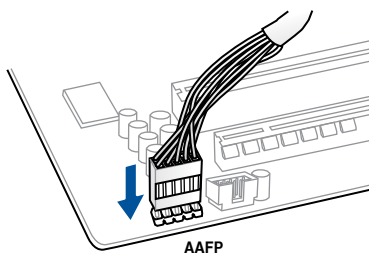

To install USB 3.0 connector

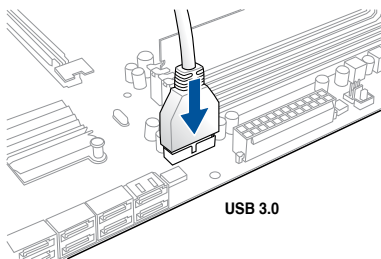

2.1.8 Expansion Card installation

To install PCIe x16 cards

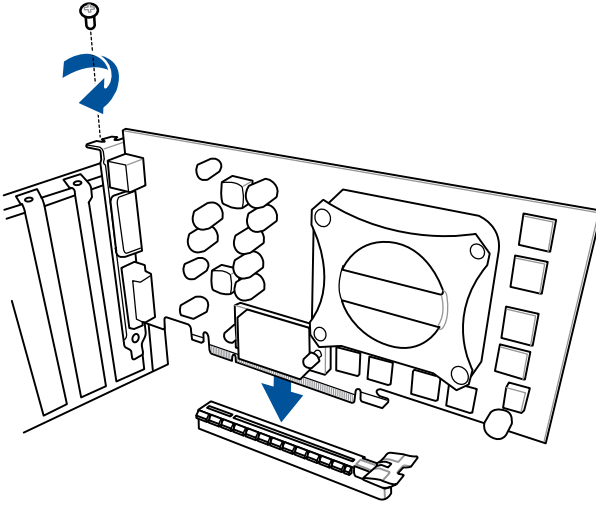

2.2 BIOS update utility

USB BIOS Flashback

USB BIOS Flashback allows you to easily update the BIOS without entering the existing BIOS or operating system. Simply insert a USB storage device to the USB port, press the USB BIOS Flashback button for three seconds, and the BIOS is updated automatically.

To use USB BIOS Flashback:

1. Download the latest BIOS file from the ASUS website.
2. Extract and rename the BIOS image file to **M8G.CAP**.
3. Copy **M8G.CAP** to the root directory of your USB storage device.
4. Turn off the system and connect the USB storage device to the USB BIOS Flashback port.
5. Press the USB BIOS Flashback button.



A flashing light indicates that the BIOS Flashback function is enabled. The light goes out when the process of updating the BIOS is complete.

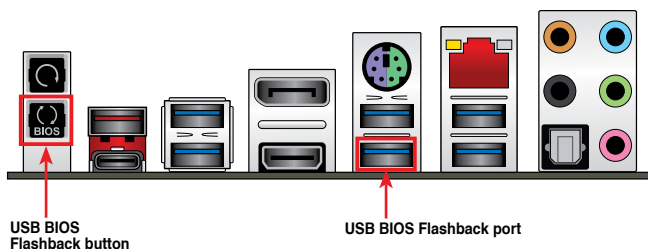

For more BIOS update utilities in BIOS setup, refer to the section **Updating BIOS** in Chapter 3.



Updating BIOS may have risks. If the BIOS program is damaged during the process and results to the system's failure to boot up, please contact your local ASUS Service Center.

2.3 Motherboard rear and audio connections

2.3.1 Rear I/O connection

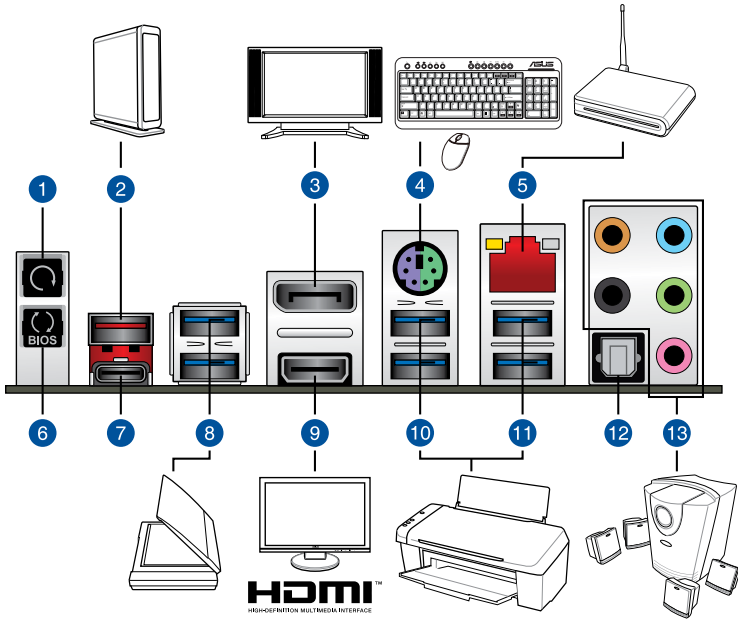

Rear panel connectors

1. Clear CMOS button
2. USB 3.1 Type-A port EA1
3. DisplayPort
4. PS/2 Keyboard/Mouse combo port
5. LAN (RJ-45) port*
6. USB BIOS Flashback button
7. USB 3.1 Type-C port EC1.
8. Intel® USB 3.0 ports 7 and 8
9. HDMI port
10. Intel® USB 3.0 ports 5 and 6
11. Intel® USB 3.0 ports 3 and 4. Lower port supports the KeyBot II feature, and upper port support USB BIOS Flashback function.
12. Optical S/PDIF OUT port
13. Audio I/O ports**

* and **: Refer to the tables on the next page for LAN port LEDs, and audio port definitions.



- Due to USB 3.0 controller limitation, USB 3.0 devices can only be used under Windows® 7 and after the USB 3.0 driver installation.
- USB 3.0 devices can only be used as data storage only.
- We strongly recommend that you connect USB 3.0 devices to USB 3.0 ports for faster and better performance for your USB 3.0 devices.
- Due to the design of the Intel chipset, all USB devices connected to the USB 2.0 and USB 3.0 ports are controlled by the xHCI controller. Some legacy USB devices must update their firmware for better compatibility.

* LAN ports LED indications

Activity Link LED		Speed LED	
Status	Description	Status	Description
OFF	No link	OFF	10 Mbps connection
ORANGE	Linked	ORANGE	100 Mbps connection
BLINKING	Data activity	GREEN	1 Gbps connection

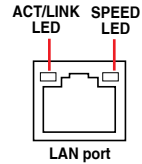

** Audio 2.1, 4.1, 5.1 or 7.1-channel configuration

Port	Headset 2.1-channel	4.1-channel	5.1-channel	7.1-channel
Light Blue	Line In	Line In	Line In	Side Speaker Out
Lime	Line Out	Front Speaker Out	Front Speaker Out	Front Speaker Out
Pink	Mic In	Mic In	Mic In	Mic In
Orange	–	–	Center/Sub woofer	Center/Sub woofer
Black	–	Rear Speaker Out	Rear Speaker Out	Rear Speaker Out

2.3.2 Audio I/O connections

Audio I/O ports

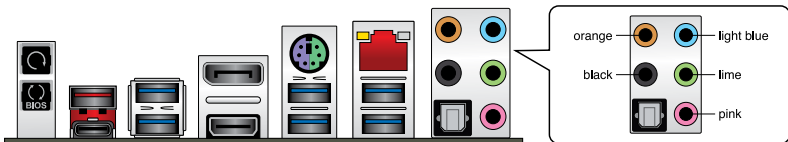

Connect to Headphone and Mic

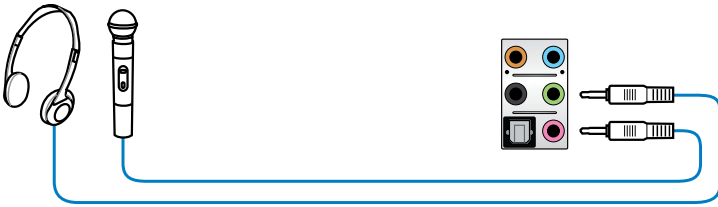

Connect to Stereo Speakers

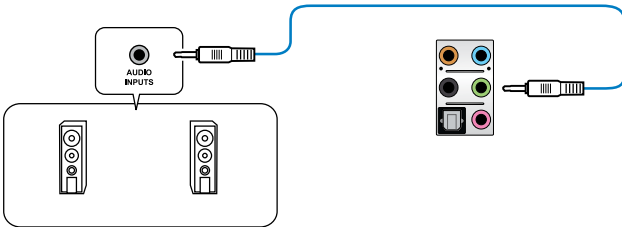

Connect to 2.1 channel Speakers

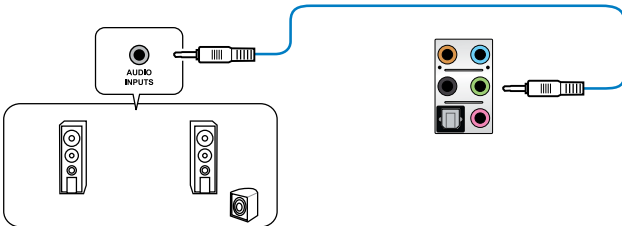

Connect to 4.1 channel Speakers

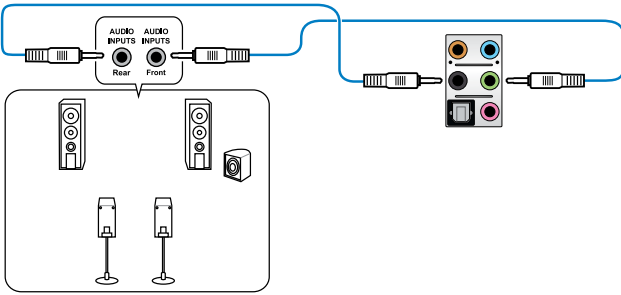

Connect to 5.1 channel Speakers

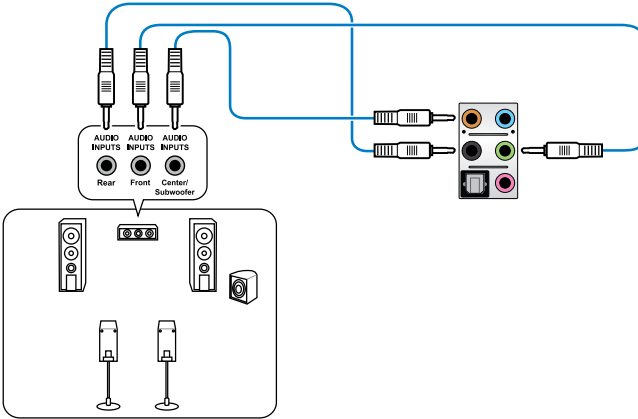

Connect to 7.1 channel Speakers

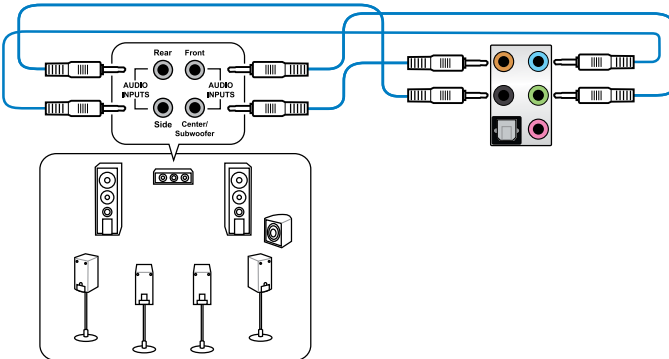

2.4 Starting up for the first time

1. After making all the connections, replace the system case cover.
2. Ensure that all switches are off.
3. Connect the power cord to the power connector at the back of the system chassis.
4. Connect the power cord to a power outlet that is equipped with a surge protector.
5. Turn on the devices in the following order:
 - a. Monitor
 - b. External SCSI devices (starting with the last device on the chain)
 - c. System power
6. After applying power, the system power LED on the system front panel case lights up. For systems with ATX power supplies, the system LED lights up when you press the ATX power button. If your monitor complies with the “green” standards or if it has a “power standby” feature, the monitor LED may light up or change from orange to green after the system LED turns on.

The system then runs the power-on self tests (POST). While the tests are running, the BIOS beeps (refer to the BIOS beep codes table) or additional messages appear on the screen. If you do not see anything within 30 seconds from the time you turned on the power, the system may have failed a power-on test. Check the jumper settings and connections or call your retailer for assistance.

BIOS Beep	Description
One short beep	VGA detected Quick boot set to disabled No keyboard detected
One continuous beep followed by two short beeps then a pause (repeated)	No memory detected
One continuous beep followed by three short beeps	No VGA detected
One continuous beep followed by four short beeps	Hardware component failure

7. At power on, hold down the <Delete> key to enter the BIOS Setup. Follow the instructions in Chapter 3.

2.5 Turning off the computer

While the system is ON, press the power button for less than four seconds to put the system on sleep mode or soft-off mode, depending on the BIOS setting. Press the power button for more than four seconds to let the system enter the soft-off mode regardless of the BIOS setting.

BIOS Setup

3

3.1 Knowing BIOS



The new ASUS UEFI BIOS is a Unified Extensible Interface that complies with UEFI architecture, offering a user-friendly interface that goes beyond the traditional keyboard-only BIOS controls to enable a more flexible and convenient mouse input. You can easily navigate the new UEFI BIOS with the same smoothness as your operating system. The term “BIOS” in this user manual refers to “UEFI BIOS” unless otherwise specified.

BIOS (Basic Input and Output System) stores system hardware settings such as storage device configuration, overclocking settings, advanced power management, and boot device configuration that are needed for system startup in the motherboard CMOS. In normal circumstances, the default BIOS settings apply to most conditions to ensure optimal performance. **DO NOT change the default BIOS settings** except in the following circumstances:

- An error message appears on the screen during the system bootup and requests you to run the BIOS Setup.
- You have installed a new system component that requires further BIOS settings or update.



Inappropriate BIOS settings may result to instability or boot failure. **We strongly recommend that you change the BIOS settings only with the help of a trained service personnel.**



When downloading or updating the BIOS file, rename it as **M8G.CAP** for this motherboard.

3.2 BIOS setup program

Use the BIOS Setup to update the BIOS or configure its parameters. The BIOS screen include navigation keys and brief onscreen help to guide you in using the BIOS Setup program.

Entering BIOS at startup

To enter BIOS Setup at startup, press <Delete> during the Power-On Self Test (POST). If you do not press <Delete>, POST continues with its routines.

Entering BIOS Setup after POST

To enter BIOS Setup after POST:

- Press <Ctrl>+<Alt>+<Delete> simultaneously.
- Press the reset button on the system chassis.
- Press the power button to turn the system off then back on. Do this option only if you failed to enter BIOS Setup using the first two options.



-
- The BIOS setup screens shown in this section are for reference purposes only, and may not exactly match what you see on your screen.
 - Ensure that a USB mouse is connected to your motherboard if you want to use the mouse to control the BIOS setup program.
 - If the system becomes unstable after changing any BIOS setting, load the default settings to ensure system compatibility and stability. Select the **Load Optimized Defaults** item under the **Exit** menu or press the <F5>. If the system fails to boot after changing any BIOS setting, try to clear the CMOS and reset the motherboard to the default value. See section **Rear I/O connection** for location of the Clear CMOS button to erase RTC RAM.
 - The BIOS setup program does not support the bluetooth devices.
-

BIOS menu screen

The BIOS Setup program can be used under two modes: **EZ Mode** and **Advanced Mode**. You can change modes from **Setup Mode** in **Boot menu** or by pressing the <F7> hotkey.

3.2.1 EZ Mode

The EZ Mode provides you an overview of the basic system information, and allows you to select the display language, system performance, mode and boot device priority. To access the Advanced Mode, select **Advanced Mode** or press the <F7> hotkey for the advanced BIOS settings.



The default screen for entering the BIOS setup program can be changed. Refer to the **Setup Mode** item in section **Boot menu** for details.

The screenshot shows the ASUS UEFI BIOS Utility - EZ Mode interface. The interface is divided into several sections:

- Information:** Displays system properties like BIOS version (MAXIMUS VIII GENE), CPU (Intel(R) Core(TM) i5-6400), speed (2700 MHz), and memory (4096 MB).
- CPU Temperature:** Shows CPU Core Voltage (2.128 V) and Motherboard Temperature (27C).
- DRAM Status:** Shows DIMM status for slots A1, A2, B1, and B2.
- SATA Information:** Lists SATA ports (P1-P6) and their configurations.
- EZ System Tuning:** Allows selecting system performance modes: Quiet, Performance, and Energy Saving. The current mode is Normal.
- Boot Priority:** Allows selecting boot devices. The current boot priority is P2: WDC WD800JD-00LSA0 (76319MB).
- FAN Profile:** Shows fan speeds (CPU FAN: 1750 RPM) and fan control options (CHA1-FAN2, CPU OPT FAN, EXT FAN2).
- Intel Rapid Storage Technology:** A toggle switch set to 'On'.
- CPU FAN:** A graph showing fan speed (%) vs. temperature (°C) with a 'QFan Control' button.
- Navigation:** Bottom bar includes 'Default(F5)', 'Save & Exit(F10)', 'Advanced Mode(F7)', and 'Search on FAQ'.

Callouts and their descriptions:

- Displays the system properties of the selected mode. Click < or > to switch EZ System Tuning modes** (points to EZ System Tuning)
- Displays the CPU/motherboard temperature, CPU voltage output, CPU/chassis/power fan speed, and SATA information** (points to Information, CPU Temperature, and SATA Information)
- Selects the display language of the BIOS setup program** (points to Language)
- Creates storage RAID and configures system overclocking** (points to SATA Information)
- Enables or disables the Intel Rapid Storage Technology** (points to Intel Rapid Storage Technology)
- Saves the changes and resets the system** (points to Save & Exit(F10))
- Click to go to Advanced mode** (points to Advanced Mode(F7))
- Search on the FAQ** (points to Search on FAQ)
- Click to display boot devices** (points to Boot Priority)
- Selects the boot device priority** (points to Boot Priority)
- Displays the CPU Fan's speed. Click the button to manually tune the fans** (points to CPU FAN graph)
- Loads optimized default settings** (points to Default(F5))



The boot device options vary depending on the devices you installed to the system.

3.2.2 Advanced Mode

The Advanced Mode provides advanced options for experienced end-users to configure the BIOS settings. The figure below shows an example of the Advanced Mode. Refer to the following sections for the detailed configurations.



To switch from EZ Mode to Advanced Mode, click **Advanced Mode(F7)** or press the <F7> hotkey.

The screenshot shows the ASUS UEFI BIOS Utility in Advanced Mode. The interface is dark-themed with red accents. At the top, there's a header with the Republic of Gamers logo and the title 'UEFI BIOS Utility - Advanced Mode'. Below the header is a menu bar with options: My Favorites, Main, Extreme Tweaker (selected), Advanced, Monitor, Boot, Tool, and Exit. The main area is divided into several sections: 'My Favorites' (showing LN2 Mode, Target CPU Turbo-Mode Frequency: 3300MHz, Target DRAM Frequency: 2133MHz, Target Cache Frequency: 3300MHz), 'AI Overclock Tuner' (set to Auto), 'ASUS MultiCore Enhancement' (set to Sync All Cores), 'CPU Core Ratio' (with 1-4 Core Ratio Limits set to Auto), and 'DRAM Odd Ratio Mode' (set to Enabled). On the right side, there's a 'Hardware Monitor' section showing CPU (Frequency: 2700 MHz, Temperature: 58°C, BCLK: 100.0 MHz, Core Voltage: 2.016 V, Ratio: 27x) and Memory (Frequency: 2133 MHz, Voltage: 2.416 V, Capacity: 4096 MB) information. At the bottom, there's a footer with 'Version 2.17.1246. Copyright (C) 2015 American Megatrends, Inc.', 'Last Modified', 'EzMode(F7)', and 'Search on FAQ'. A red box highlights a note: '[Manual]: When the manual mode is selected, BCLK(base clock) frequency can be assigned manually. [XMP]: When XMP(extreme memory profile) mode is selected, BCLK frequency and memory parameters will be optimized automatically.'

Labels in the image include:

- Configuration fields
- Pop-up Menu
- Menu bar
- Language
- MyFavorite(F3)
- Qfan Control(F6)
- EZ Tuning Wizard(F11)
- Quick Note (F9)
- Scroll bar
- Hot Keys
- Sub-menu item
- Menu items
- General help
- Last modified settings
- Go back to EZ Mode
- Search on the FAQ
- Displays the CPU temperature, CPU, and memory voltage output

Menu bar

The menu bar on top of the screen has the following main items:

My Favorites	For saving the frequently-used system settings and configuration.
Main	For changing the basic system configuration
Extreme Tweaker	For changing the overclocking settings
Advanced	For changing the advanced system settings
Monitor	For displaying the system temperature, power status, and changing the fan settings.
Boot	For changing the system boot configuration
Tool	For configuring options for special functions
Exit	For selecting the exit options and loading default settings

Menu items

The highlighted item on the menu bar displays the specific items for that menu. For example, selecting **Main** shows the Main menu items.

The other items (My Favorites, Extreme Tweaker, Advanced, Monitor, Boot, Tool, and Exit) on the menu bar have their respective menu items.

Submenu items

A greater than sign (>) before each item on any menu screen means that the item has a submenu. To display the submenu, select the item and press <Enter>.

Language

This button above the menu bar contains the languages that you can select for your BIOS. Click this button to select the language that you want to display in your BIOS screen.

MyFavorite(F3)

This button above the menu bar shows all BIOS items in a Tree Map setup. Select frequently-used BIOS settings and save it to MyFavorite menu.



Refer to section **My Favorites** for more information.

Qfan Control(F6)

This button above the menu bar displays the current settings of your fans. Use this button to manually tweak the fans to your desired settings.

EZ Tuning Wizard(F11)

This button above the menu bar allows you to view and tweak the overclocking settings of your system. It also allows you to change the motherboard's SATA mode from AHCI to RAID mode.

Quick Note (F9)

This button above the menu bar allows you to key in notes of the activities that you have done in BIOS.



- The quick Note function does not support the following keyboard functions: delete, cut, copy and paste.
- You can only use the alphanumeric characters to enter your notes.

Hot keys

This button above the menu bar contains the navigation keys for the BIOS setup program. Use the navigation keys to select items in the menu and change the settings.

Scroll bar

A scroll bar appears on the right side of a menu screen when there are items that do not fit on the screen. Press the Up/Down arrow keys or <Page Up> / <Page Down> keys to display the other items on the screen.

General help

At the bottom of the menu screen is a brief description of the selected item. Use the <F12> key to capture the BIOS screen and save it to the removable storage device.

Configuration fields

These fields show the values for the menu items. If an item is user-configurable, you can change the value of the field opposite the item. You cannot select an item that is not user-configurable.

A configurable field is highlighted when selected. To change the value of a field, select it and press <Enter> to display a list of options.

Last Modified button

This button shows the items that you last modified and saved in BIOS Setup.

3.3 My Favorites

My Favorites is your personal space where you can easily save and access your favorite BIOS items.



My Favorites comes with several performance, power saving, and fast boot related items by default. You can personalize this screen by adding or removing items.

Adding items to My Favorites

To add frequently-used BIOS items to My Favorites:

1. Press <F3> on your keyboard or click  to open Setup Tree Map screen.
2. On the Setup Tree Map screen, select the BIOS items that you want to save in My Favorites screen then click the plus sign (“+”) to save it in My Favorites screen.



You cannot add the following items to My Favorite items:

- Items with sub-menu options.
- User-managed items such as language and boot order.
- Configuration items such as Memory SPD Information, system time and date.

3. Click **Exit (ESC)** or press <Esc> key to close Setup Tree Map screen.
4. Go to My Favorites menu to view the saved BIOS items.

3.4 Main menu

The Main menu screen appears when you enter the Advanced Mode of the BIOS Setup program. The Main menu provides you an overview of the basic system information, and allows you to set the system date, time, language, and security settings.

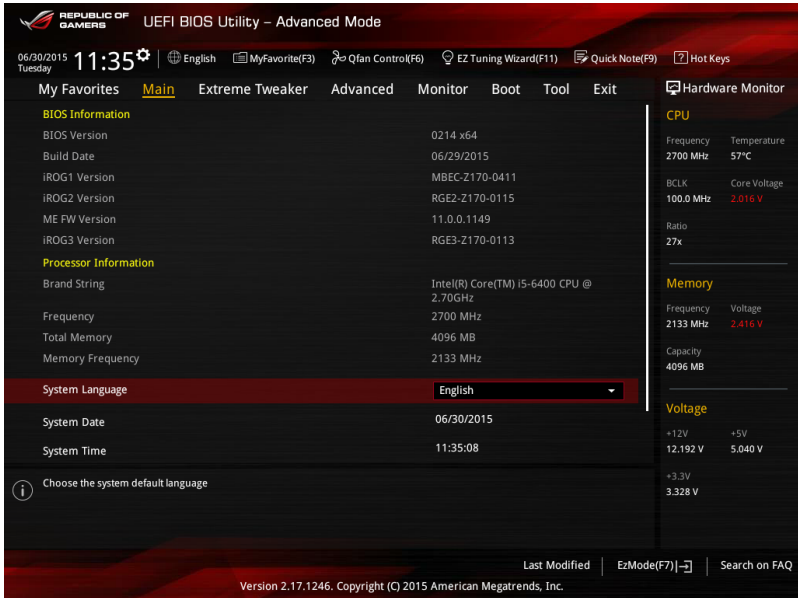

Security

The Security menu items allow you to change the system security settings.

The screenshot shows the 'Main/Security' menu in the ASUS UEFI BIOS Utility. The interface is dark-themed with red accents. At the top, it displays the date and time (06/30/2015, 11:35), language (English), and various utility icons. The 'Main' menu is highlighted, and the 'Security' sub-menu is selected. The Security menu contains a 'Password Description' section with instructions for Administrator and User passwords, and a table for password settings. On the right, there is a 'Hardware Monitor' section showing CPU, Memory, and Voltage status.

Minimum length	3
Maximum length	20
Administrator Password	Not Installed
User Password	Not Installed

Frequency	Temperature
2700 MHz	58°C

BCLK	Core Voltage
100.0 MHz	2.016 V

Ratio
27x

Frequency	Voltage
2133 MHz	2.400 V

Capacity
4096 MB

+12V	+5V
12.192 V	5.040 V
+3.3V	
3.328 V	



- If you have forgotten your BIOS password, erase the CMOS Real Time Clock (RTC) RAM to clear the BIOS password. See section 2.3.1 Rear I/O connection for location of the Clear CMOS button to clear RTC RAM.
- The Administrator or User Password items on top of the screen show the default [Not Installed]. After you set a password, these items show [Installed].

Administrator Password

If you have set an administrator password, we recommend that you enter the administrator password for accessing the system. Otherwise, you might be able to see or change only selected fields in the BIOS setup program.

To set an administrator password:

1. Select the **Administrator Password** item and press <Enter>.
2. From the **Create New Password** box, key in a password, then press <Enter>.
3. Confirm the password when prompted.

To change an administrator password:

1. Select the **Administrator Password** item and press <Enter>.
2. From the **Enter Current Password** box, key in the current password, then press <Enter>.
3. From the **Create New Password** box, key in a new password, then press <Enter>.
4. Confirm the password when prompted.

To clear the administrator password, follow the same steps as in changing an administrator password, but press <Enter> when prompted to create/confirm the password. After you clear the password, the **Administrator Password** item on top of the screen shows **Not Installed**.

User Password

If you have set a user password, you must enter the user password for accessing the system. The **User Password** item on top of the screen shows the default **Not Installed**. After you set a password, this item shows **Installed**.

To set a user password:

1. Select the **User Password** item and press <Enter>.
2. From the **Create New Password** box, key in a password, then press <Enter>.
3. Confirm the password when prompted.

To change a user password:

1. Select the **User Password** item and press <Enter>.
2. From the **Enter Current Password** box, key in the current password, then press <Enter>.
3. From the **Create New Password** box, key in a new password, then press <Enter>.
4. Confirm the password when prompted.

To clear the user password, follow the same steps as in changing a user password, but press <Enter> when prompted to create/confirm the password. After you clear the password, the **User Password** item on top of the screen shows **Not Installed**.

3.5 Extreme Tweaker menu

The Extreme Tweaker menu items allow you to configure overclocking-related items.



Be cautious when changing the settings of the Extreme Tweaker menu items. Incorrect field values can cause the system to malfunction



The configuration options for this section vary depending on the CPU and DIMM model you installed on the motherboard.

Scroll down to display other BIOS items.



Ai Overclock Tuner [Auto]

Allows you to select the CPU overclocking options to achieve the desired CPU internal frequency. Configuration options:

- [Auto] Loads the optimal settings for the system.
- [Manual] Allows you to individually set overclocking parameters.
- [X.M.P.] If you install memory modules supporting the eXtreme Memory Profile (X.M.P.) Technology, choose this item to set the profiles supported by your memory modules for optimizing the system performance.



The [X.M.P.] configuration option appears only when you install memory modules supporting the eXtreme Memory Profile (X.M.P.) Technology.



When the **Ai Overclock Tuner** is set to [Manual] or [XMP], the following items appear.

BCLK Frequency [100]

This item allows you to set the BCLK (base clock) frequency to enhance the system performance. Use the <+> or <-> to adjust the value. The values range from 40.0 MHz to 500.0 MHz.



When **Ai Overclock Tuner** is set to [XMP], the XMP mode supported by the installed memory module is displayed.

ASUS MultiCore Enhancement [Auto]

[Auto] This item allows you to maximize the overlocking performance optimized by ASUS core ratio settings.

[Disabled] This item allows you to set to default core ratio settings.

CPU Core Ratio [Auto]

This item allows you to set the CPU core ratio limit per core or synchronize automatically to all cores.

Configuration options: [Auto] [Sync All Cores] [Per Core]



When the CPU Core Ratio is set to [**Sync All Cores**], the following item appears:

1-Core Ratio Limit [Auto]

Select [**Auto**] to apply the CPU default Turbo Ratio setting or manually assign a 1-Core Limit value that must be higher than or equal to the 2-Core Ratio Limit.



When the CPU Core Ratio is set to [**Per Core**], the following item appears:

1-Core Ratio Limit [Auto]

Select [**Auto**] to apply the CPU default Turbo Ratio setting or manually assign a 1-Core Limit value that must be higher than or equal to the 2-Core Ratio Limit.

2-Core Ratio Limit [Auto]

Select [**Auto**] to apply the CPU default Turbo Ratio setting or manually assign a 2-Core Limit value that must be higher than or equal to the 3-Core Ratio Limit.

3-Core Ratio Limit [Auto]

Select [**Auto**] to apply the CPU default Turbo Ratio setting or manually assign a 3-Core Limit value that must be higher than or equal to the 4-Core Ratio Limit.

4-Core Ratio Limit [Auto]

Select [**Auto**] to apply the CPU default Turbo Ratio setting or manually assign a 4-Core Limit value that must be higher than or equal to the 3-Core Ratio Limit.



If you assign a value for more Core Ratio Limit, do not set the less Core Ratio Limit to [**Auto**].

DRAM Odd ratio Mode [Enabled]

This item allows you to enable, disable or automatically set the odd ratio to provide better granularity.

Configuration options: [Disabled] [Enabled]

DRAM Frequency [Auto]

This item allows you to set the memory operating frequency. The configurable options vary with the BCLK (base clock) frequency setting. Select the auto mode to apply the optimized setting.

Configuration options: [Auto] [DDR4-800MHz] - [DDR4-4266MHz]

Xtreme Tweaking [Disabled]

This item may help improve some benchmarks performance.

Configuration options: [Enabled] [Disabled]

TPU [Keep Current Settings]

This item allows you to automatically overclock the CPU and DRAM frequencies and voltage for an enhanced system performance.

- [Keep Current Settings] Keep the current settings without changing anything.
- [TPU I] Applies air cooling overclocking conditions.
- [TPU II] Applies water cooling overclocking conditions.



Ensure to use water cooling device before selecting [TPU II].

EPU Power Saving Mode [Disabled]

The ASUS EPU (Energy Processing Unit) sets the CPU in its minimum power consumption settings. Enable this item to set lower CPU core/cache voltage and achieve the best energy saving condition.

Configuration options: [Disabled] [Enabled]

CPU SVID Support [Auto]

Disable this item to stop the CPU from communicating with the external voltage regulator.

Configuration options: [Auto] [Disabled] [Enabled]

DRAM Timing Control

The sub-items in this menu allow you to set the DRAM timing control features. Use the <+> and <-> keys to adjust the value. To restore the default setting, type [auto] using the keyboard and press the <Enter> key.

Misc.

MRC Fast Boot [Auto]

Allows you to enable, disable or automatically set the MRC fast boot.

Configuration options: [Auto] [Enabled] [Disabled]

DRAM CLK Period [Auto]

Configuration options: [Auto] [1] – [26]

Memory Scrambler [Enabled]

Set this item to enable or disable memory scrambler support.

Configuration options: [Enabled] [Disabled]

Channel A DIMM Control [Enable Both DIMMS]

Allows you to enable or disable the Channel A DIMM slots.

Configuration options: [Enable Both DIMMS] [Disable DIMM0] [Disable DIMM1] [Disable Both DIMMS]

Channel B DIMM Control [Enable Both DIMMS]

Allows you to enable or disable the Channel B DIMM slots.

Configuration options: [Enable Both DIMMS] [Disable DIMM0] [Disable DIMM1] [Disable Both DIMMS]

MCH Full Check [Auto]

Enable this item to enhance the stability of your system. Disable this item to enhance the DRAM overclocking capability.

Configuration options: [Auto] [Enabled] [Disabled]

DLLBwEn [Auto]

Select values from 2 to 4 for best memory overclocking.

Configuration options: [Auto] [0] - [7]

DIGI+ VRM

VRM Initialization Check [Disabled]

Enable or disable this item if any error occurs during VRM initialization.

Configuration options [Disabled] [Enabled]

CPU Load-line Calibration [Auto]

Load-line is defined by Intel® specification and affects CPU power voltage. The CPU working voltage decreases proportionally to CPU loading. Higher load-line calibration could get higher voltage and good overclocking performance, but increases the CPU and VRM thermal conditions. Select from levels 1 to 7 to adjust the CPU power voltage from 0% to 100%.

Configuration options [Auto] [Level 1] - [Level 7]



The actual performance boost may vary depending on your CPU specification.



DO NOT remove the thermal module. The thermal conditions should be monitored.

CPU Current Capability [Auto]

This item provides a total power range for CPU overclocking. A higher value setting provides higher power consumption delivery and extends the overclocking frequency range simultaneously.

Configuration options: [Auto] [100%] [110%] [120%] [130%] [140%]



Configure higher values when overclocking or under a high CPU loading for extra power support.

CPU VRM Switching Frequency [Auto]

This item affects the VRM transient response speed and the component thermal production. Select **[Manual]** to configure a higher frequency for a quicker transient response speed.

Configuration options: [Auto] [Manual]



DO NOT remove the thermal module. The thermal conditions should be monitored.



The following item appears only when you set the CPU VRM Switching Frequency to **[Manual]**.

Fixed CPU VRM Switching Frequency (KHz) [300]

This item allows you to set a higher frequency for a quicker transient response speed. Use the <+> or <-> to adjust the value. The values range from 250 KHz to 500 KHz with an interval of 50 KHz.



Do not remove the thermal module when the manual mode is selected. The thermal conditions should be monitored.



The following item appears only when the CPU VRM Switching Frequency is set to **[Auto]**.

VRM Spread Spectrum [Auto]

This item allows to enhance the system stability.

Configuration options: [Auto] [Disabled] [Enabled]

CPU Power Duty Control [T.Probe]

DIGI + VRM Duty Control adjusts the current of every VRM phase and the thermal conditions of every phase component.

[T. Probe] Select to set the VRM thermal balance mode.

[Extreme] Select to set the VRM current balance mode.



DO NOT remove the thermal module. The thermal conditions should be monitored.

CPU Power Phase Control [Auto]

This item allows you to set the power phase control of the CPU.

Configuration options: [Auto] [Standard] [Optimized] [Extreme]

CPU Power Thermal Control [115]

Higher temperature provides a wider CPU power thermal range and extends the overclocking tolerance to enlarge the overclocking potential.

Configuration options: [115] - [136]



DO NOT remove the thermal module. The thermal conditions should be monitored

Boot Voltages

CPU Core/Cache Boot Voltage [Auto]

The voltage for CPU at initial boot.

Configuration options: [Auto] [0.600] - [1.700]

DMI Boot Voltage [Auto]

The voltage for DMI at initial boot.

Configuration options: [Auto] [0.300] - [1.900]

Core PLL Boot Voltage [Auto]

The voltage for Core PLL at initial boot.

Configuration options: [Auto] [0.70000] - [2.40000]

CPU System Agent Boot Voltage [Auto]

The voltage for CPU System Agent at initial boot.

Configuration options: [Auto] [0.7000] - [1.8000]

CPU VCCIO Boot Voltage [Auto]

The voltage for CPU VCCIO at initial boot.

Configuration options: [Auto] [0.7000] - [1.8000]

Internal CPU Power Management

The subitems in this menu allow you to set the CPU ratio and features.

Intel(R) SpeedStep(tm) [Enabled]

Allows the operating system to dynamically adjust the processor voltage and cores frequency to decrease the average power consumption and decrease average heat production. Configuration options: [Enabled] [Disabled]

Turbo Mode [Enabled]

Allows you to enable your processor cores to run faster than the base operating frequency when it is below power, current and specification limit. Configuration options: [Disabled] [Enabled]



The following items appear only when you set the Turbo Mode to **[Enabled]**.

Turbo Mode Parameters**Long Duration Package Power Limit [Auto]**

Allows you to limit the Turbo Ratio's time duration that exceeds the TDP (Thermal Design Power) for maximum performance. Use the <+> and <-> keys to adjust the value.

Configuration options: [Auto] [1] - [4095]

Package Power Time Window [Auto]

Also known as Power Limit 1, and allows you to maintain the time window for Turbo Ratio over TDP (Thermal Design Power). Use the <+> and <-> keys to adjust the value.

Configuration options: [Auto] [1] - [127]

Short Duration Package Power Limit [Auto]

Also known as Power Limit 2, and allows you to provide rapid protection when the package power exceeds the Power Limit 1. Use the <+> and <-> keys to adjust the value.

Configuration options: [Auto] [1] - [4095]

IA AC Load Line [Auto]

This item allows you to set the AC loadline defined in 1/100 mOhms. Use the <+> and <-> keys to adjust the value.

Configuration options: [Auto] [0.01] - [62.49]

IA DC Load Line [Auto]

This item allows you to set the DC loadline defined in 1/100 mOhms. Use the <+> and <-> keys to adjust the value.

Configuration options: [Auto] [0.01] - [62.49]

Tweaker's Paradise**Initial BCLK Frequency [Auto]**

This item allows you to set the initial BCLK (base clock) frequency to start overclocking from the assigned BCLK frequency.

Configuration options: [Auto] [40.0 MHz] – [500.0 MHz]

BCLK Amplitude [Auto]

This item allows you to set the magnitude of the base clock driven for the processor.

Configuration options: [Auto] [700mV] [800mV] [900mV] [1000mV]

BCLK Slew Rate [Auto]

This item allows you to set the speed at which each clock rises and falls.

Configuration options: [Auto] [1.5V/ns] [2.5V/ns] [3.5V/ns] [4.5V/ns]

BCLK Spread Spectrum [Auto]

This item allows you to reduce the EMI. Disable to get more accurate base clocks.

Configuration options: [Auto] [Disabled] [-0.22] [-0.34] [-0.46] [+0.12] [+0.22] [+0.28] [+0.38] [+0.17]

BCLK Frequency Slew Rate

This item allows you to set frequency update rate. Lower values speed up clock changes.

Configuration options: [Auto] [Disable] [32us/MHz] [64us/MHz] [128us/MHz] [512us/MHz]

DRAM VTT Voltage [Auto]

Configuration options: [Auto] [0.500] - [1.300]

VPPDDR Voltage [Auto]

Configuration options: [Auto] [1.86500] - [3.13500]

DMI Voltage [Auto]

Configuration options: [Auto] [0.30000] - [1.90000]

Core PLL Voltage [Auto]

Configuration options: [Auto] [0.70000] - [1.60000]

PLL Bandwidth [Auto]

Select Level 6 to Level 8 when overclocking High BCLK or High CPU frequency.

Configuration options: [Auto] [Level 0] - [Level 8]

Eventual DRAM Voltage [Auto]

Configuration options: [Auto] [1.0032] - [2.0064]

Eventual CPU Standby Voltage [Auto]

Configuration options: [Auto] [0.80000] - [1.80000]

Eventual PLL Termination Voltage [Auto]

Configuration options: [Auto] [0.36000] - [2.10000]

CPU Core/Cache Current Limit Max. [Auto]

This item allows you to configure a higher current limit to prevent a frequency or power throttling when overclocking. Use the <+> and <-> keys to adjust the value.

Configuration options: [Auto] [0.00] - [255.50]

CPU Graphics Current Limit Max. [Auto]

This item allows you to configure a higher current limit to prevent a frequency or power throttling when overclocking. Use the <+> and <-> keys to adjust the value.

Configuration options: [Auto] [0.00] - [255.50]

Min. CPU Cache Ratio [Auto]

This item allows you to set the minimum possible CPU cache ratio. Use the <+> and <-> keys to adjust the value.

Configuration options: [Auto] [8] - [33]

Max. CPU Cache Ratio [Auto]

This item allows you to set the maximum possible CPU cache ratio. Use the <+> and <-> keys to adjust the value.

Configuration options: [Auto] [8] - [33]

Max. CPU Graphics Ratio [Auto]

This item allows you to set the CPU graphics ratio. Use the <+> and <-> keys to adjust the value.

Configuration options: [Auto] [8] - [26]

CPU Core/Cache Voltage [Auto]

Configures the mode of Voltage fed to the cores of the processor.

Configuration options: [Auto] [Manual Mode] [Offset Mode] [Adaptive Mode]



The following items appear only when you set the CPU Core/Cache Voltage to **[Manual Mode]**.

CPU Core Voltage Override [Auto]

Allows you to configure the CPU Core voltage.

Configuration options: [Auto] [0.600] - [1.700]



The following items appear only when you set the CPU Core/Cache Voltage to **[Offset Mode]**.

Offset Mode Sign [+]

[+] To offset the voltage by a positive value.

[-] To offset the voltage by a negative value.

CPU Core Voltage Offset [Auto]

This item allows you to configure the CPU core voltage offset value.

Configuration options: [Auto] [-0.635] - [0.635]



The following items appear only when you set the CPU Core/Cache Voltage to **[Adaptive Mode]**.

Offset Mode Sign [-]

[+] To offset the voltage by a positive value.

[-] To offset the voltage by a negative value.

Additional Turbo Mode CPU Core Voltage [Auto]

This item allows you to configure the CPU core voltage offset value.

Configuration options: [Auto] [0.250] - [1.920]

Offset Voltage [Auto]

This item allows you to configure the CPU core voltage offset value.

Configuration options: [Auto] [0.001] - [0.999]

DRAM Voltage [Auto]

Configuration options: [Auto] [1.0032] - [2.0064]

CPU VCCIO Voltage [Auto]

Configuration options: [Auto] [0.70000] - [1.80000]

CPU System Agent Voltage [Auto]

Configuration options: [Auto] [0.70000] - [1.80000]

PLL Termination Voltage [Auto]

Configuration options: [Auto] [0360] - [2.100]

PCH Core Voltage [Auto]

Configuration options: [Auto] [0.70000] - [1.80000]

CPU Graphics Voltage Mode [Auto]

Configures the mode of Voltage fed to the CPU graphics.

Configuration options: [Auto] [Manual Mode] [Offset Mode]



The following items appear only when you set the CPU Graphics Voltage Mode to **[Manual Mode]**.

CPU Graphics Voltage Override [Auto]

Allows you to configure the CPU Graphics Voltage.

Configuration options: [Auto] [0.600] - [1.700]



The following items appear only when you set the CPU Graphics Voltage Mode to **[Offset Mode]**.

Offset Mode Sign [+]

[+] To offset the voltage by a positive value.

[-] To offset the voltage by a negative value.

CPU Graphics Voltage Offset [Auto]

This item allows you to configure the CPU core voltage offset value.

Configuration options: [Auto] [0.001] - [0.635]

CPU Standby Voltage [Auto]

Configuration options: [Auto] [0.80000] - [1.80000]

DRAM REF Voltage Control

DRAM CTRL REF Voltage on CHA/CHB [Auto]

Configures the DRAM reference voltage on the control lines. The reference voltage will be the DRAM voltage times the configured value.

Configuration options: [Auto] [0.39500] - [0.63000]

DRAM DATA REF Voltage on CHA/CHB DIMM0/1 Rank0/1 BL0-7 [Auto]

Configures the DRAM Data REF Voltage.

Configuration options: [Auto] [0] - [63]

3.6 Advanced menu

The Advanced menu items allow you to change the settings for the CPU and other system devices.



Be cautious when changing the settings of the Advanced menu items. Incorrect field values can cause the system to malfunction.

The screenshot displays the ASUS UEFI BIOS Utility in Advanced Mode. The top bar includes the Republic of Gamers logo, the title 'UEFI BIOS Utility - Advanced Mode', and the date/time '06/30/2015 11:37 Tuesday'. Below the title are utility icons for English, MyFavorite(F3), Qfan Control(F6), EZ Tuning Wizard(F11), Quick Note(F9), and Hot Keys. The main menu includes 'My Favorites', 'Main', 'Extreme Tweaker', 'Advanced' (highlighted), 'Monitor', 'Boot', 'Tool', 'Exit', and 'Hardware Monitor'. The 'Advanced' menu is expanded to show 'CPU Configuration' (selected), 'Platform Misc Configuration', 'System Agent (SA) Configuration', 'ROG Effects', 'PCH Configuration', 'PCH Storage Configuration', 'USB Configuration', 'Network Stack Configuration', 'Onboard Devices Configuration', 'APM Configuration', and 'HDD/SSD SMART Information'. The 'CPU Configuration Parameters' section is visible at the bottom left. On the right, the 'Hardware Monitor' section displays the following data:

CPU	
Frequency	2700 MHz
Temperature	57°C
BCLK	100.0 MHz
Core Voltage	2.016 V
Ratio	27x
Memory	
Frequency	2133 MHz
Voltage	2.416 V
Capacity	4096 MB
Voltage	
+12V	+5V
12.192 V	5.040 V
+3.3V	
3.328 V	

At the bottom of the screen, it shows 'Last Modified | EzMode(F7) | Search on FAQ' and 'Version 2.17.1246. Copyright (C) 2015 American Megatrends, Inc.'

3.6.1 CPU Configuration

The items in this menu show the CPU-related information that the BIOS automatically detects.



The items in this menu may vary based on the CPU installed.

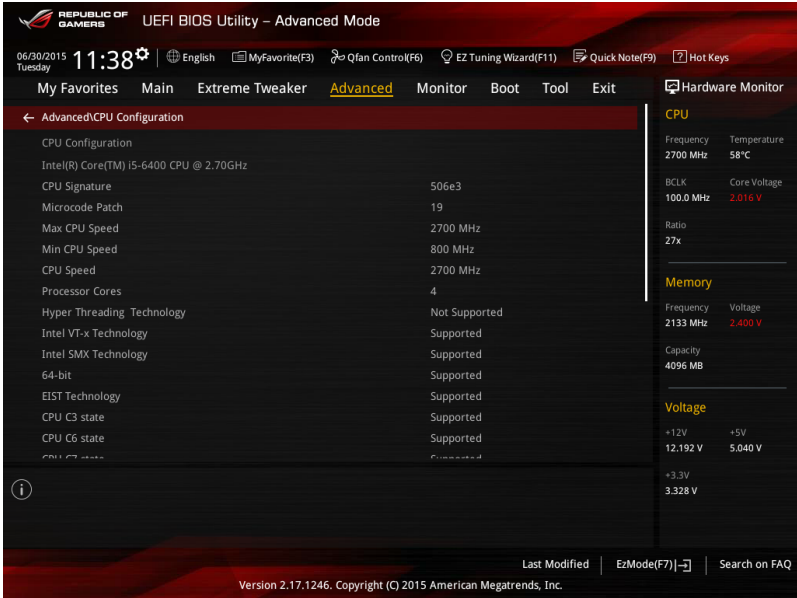

Active Processor Cores [All]

This item allows you to select the number of CPU cores to activate in each processor package.

Configuration options: [All] [1] [2] [3]

Intel Virtualization Technology [Enabled]

When set to [Enabled], a VMM can utilize the additional hardware capabilities provided by Vanderpool Technology.

Configuration options: [Disabled] [Enabled]

Hardware Prefetcher [Enabled]

This item allows you to enable or disable the MLC streamer prefetcher.

Configuration options: [Disabled] [Enabled]

Adjacent Cache Line Prefetcher [Enabled]

This item allows you to enable or prefetching of adjacent cache lines.

Configuration options: [Disabled] [Enabled]

Boot Performance Mode [Auto]

This item allows you to select the CPU performance state during system boot before the operating system takes control. The CPU runs at a selected performance ratio based on CPU configuration.

Configuration options: [Max Battery] [Max Non-Turbo Performance] [Turbo Performance] [Auto]

CPU Power Management Configuration

This item allows you to manage and configure the CPU's power.

Intel SpeedStep(tm) Technology [Enabled]

This item allows your system to adjust the CPU's voltage and cores frequency, resulting in decreased power consumption and heat production.

[Disabled] The CPU runs at its default speed.

[Enabled] The system controls the CPU speed.

Turbo Mode [Enabled]

This item allows you to automatically set the CPU cores to run faster than the base operating frequency when it is below the operating power, current and temperature specification limit.

Configuration options: [Enabled] [Disabled]

CPU C-States [Auto]

This item allows you to set the power saving of the CPU states.

Configuration options: [Auto] [Disabled] [Enabled]



The following items appear only when you set the CPU C-States to **[Enabled]**.

Enhanced C-States [Enabled]

When enabled, CPU will switch to minimum speed when all cores enter C-State.

Configuration options: [Enabled] [Disabled]

CPU C3 Report [Enabled]

This item allows you to disable or enable the CPU C3 report to the operating system.

Configuration options: [Enabled] [Disabled]

CPU C6 Report [Enabled]

This item allows you to disable or enable the CPU C6 report to the operating system.

Configuration options: [Enabled] [Disabled]

CPU C7 Report [CPU C7s]

This item allows you to disable or enable the CPU C6 report to the operating system.

Configuration options: [Disabled] [CPU C7] [CPU C7s]

Package C State Limit [Auto]

This item allows you to set the a C-state limit for the CPU package.

Configuration options: [C0/C1] [C2] [C3] [C6] [C7] [C7s] [Auto]

CFG Lock [Disabled]

This item allows you to disable or enable the CFG Lock.

Configuration options: [Enabled] [Disabled]

3.6.2 Platform Misc Configuration

The items in this menu allow you to configure the platform-related features.

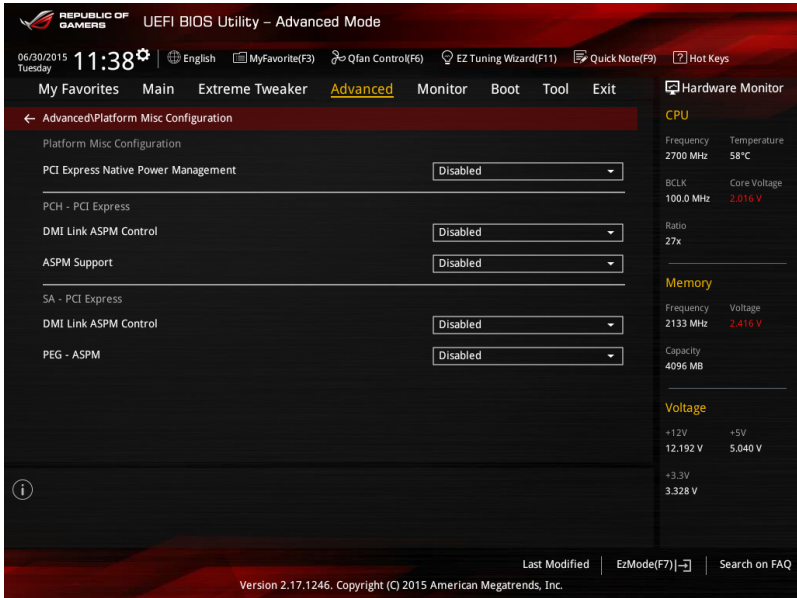

PCI Express Native Power Management [Disabled]

Enable this item to enhance the PCI-E power saving condition.

Configuration options: [Disabled] [Enabled]



The following item appears only when you set the PCI Express Native Power Management to **[Enabled]**.

Native ASPM [Disabled]

Enable this item for the Windows Vista operating system to control the Active State Power Management (ASPM) support for devices.

[Enabled] Vista controls the ASPM support for the device.

[Disabled] BIOS controls the ASPM support for the device.

PCH - PCI Express

DMI Link ASPM Control [Disabled]

This item is for the control of the Active State Power Management on SA side of the DMI link.

Configuration options: [Enabled] [Disabled]

ASPM Support [Disabled]

Select the ASPM level for energy saving conditions.

Configuration options: [Disabled] [L0s] [L1s] [L0sL1] [Auto]

SA - PCI Express

DMI Link ASPM Control [Disabled]

This item is for the control of the Active State Power Management on SA side of the DMI link.

Configuration options: [Disabled] [L1]

PEG ASPM [Disabled]

This item is for the control of the Active State Power Management for the PEG 0.

Configuration options: [Disabled] [Auto] [ASPM L0s] [ASPM L1] [ASPM L0sL1]

3.6.3 System Agent (SA) Configuration

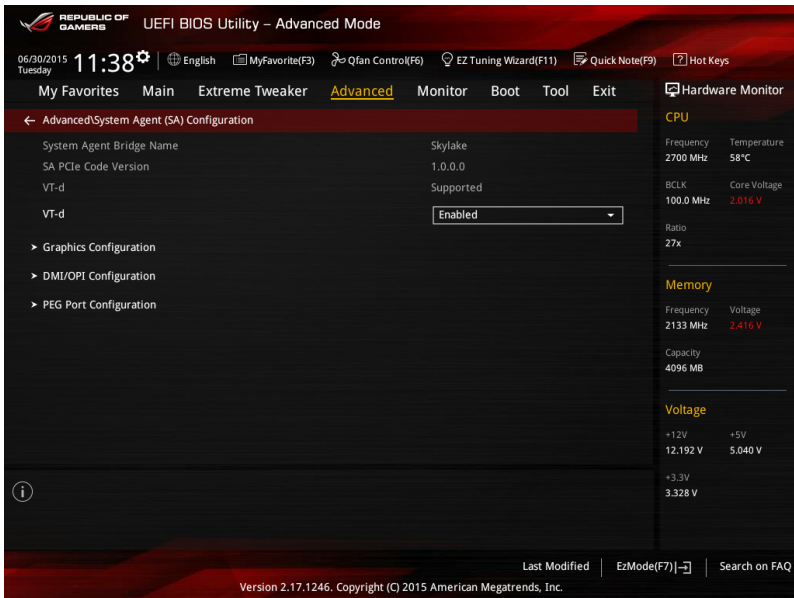

VT-d [Enabled]

Allows you to enable virtualization technology function on memory control hub.

Configuration options: [Enabled] [Disabled]

Graphics Configuration

Allows you to select a primary display from graphical devices.

Primary Display [Auto]

[Auto] The primary display will be set to PCI-E when a PCI-E graphic card is detected.

[IGFX] Force the primary display to be from the IGFX Graphics.

[PEG] Force the primary display to be from the PEG Graphics.

[PCI-E] Force the primary display to be from the PCI-E graphic cards.

iGPU Multi-Monitor [Disabled]

Set this to enabled to empower both integrated and discrete graphics for multi-monitor output.

Configuration options: [Enabled] [Disabled]

DMI/OPI Configuration

Allows you to configure the DMI/OPI settings.

DMI Max Link Speed [Auto]

Configuration options: [Auto] [Gen1] [Gen2] [Gen3]

PEG Port Configuration

Allows you to configure the PEG Port settings.

PCIEX16/X8_1

PCIEX16/X8_1 Link Speed [Auto]

Allows you to select the operating speed of the PCIEX16/X8_1 speed.

Configuration options:

- [Auto] The system will automatically select the PCIEX16/X8_1 slot speed.
- [Gen1] The PCIEX16/X8_1 slot will run at PCI-E 1.0 speed.
- [Gen2] The PCIEX16/X8_1 slot will run at PCI-E 2.0 speed.
- [Gen3] The PCIEX16/X8_1 slot will run at PCI-E 3.0 speed.

PCIEX8_2

PCIEX8_2 Link Speed [Auto]

Allows you to select the operating speed of the PCIEX8_2 speed.

Configuration options:

- [Auto] The system will automatically select the PCIEX16/X8_1 slot speed.
- [Gen1] The PCIEX8_2 slot will run at PCI-E 1.0 speed.
- [Gen2] The PCIEX8_2 slot will run at PCI-E 2.0 speed.
- [Gen3] The PCIEX8_2 slot will run at PCI-E 3.0 speed.

3.6.4 ROG Effects

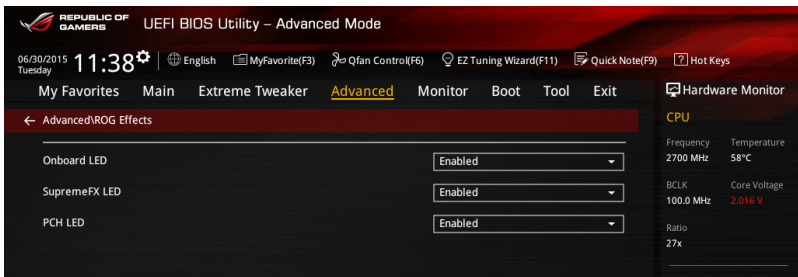

Onboard LED [Enabled]

This item allows you to enable all the onboard LEDs.

Configuration options: [Enabled] [Disabled]

SupremeFX (ROG Audio) LED [Enabled]

This item allows you to enable ROG Audio LED.

Configuration options: [Enabled] [Disabled]

PCH (Logo) LED [Enabled]

[Enabled] LEDs will always light up at the S0(Working), S3(Sleep), and S5(Soft off) states, but not light up at the S4/S5 state when the “ErP Ready” is enabled.

[Disabled] LEDs will not light up.

3.6.5 PCH Configuration

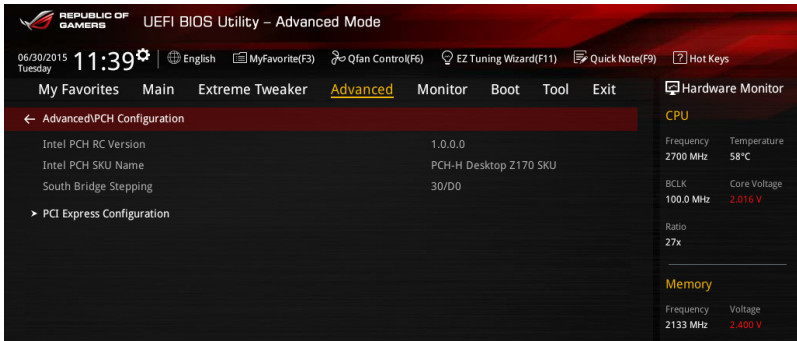

PCI Express Configuration

This item allows you to configure the PCI Express slots.

PCI-E Speed [Auto]

This item allows your system to automatically select the PCI Express port speed. When set to [Gen1], the PCI-E port runs at PCI-E 1.0 speed. When set to [Gen2], the PCI-E port runs at PCI-E 2.0 speed.

Configuration options: [Auto] [Gen1] [Gen2] [Gen 3]

3.6.6 PCH Storage Configuration

While entering Setup, the BIOS automatically detects the presence of SATA devices. The SATA Port items show **Empty** if no SATA device is installed to the corresponding SATA port. Scroll down to display the other BIOS items.

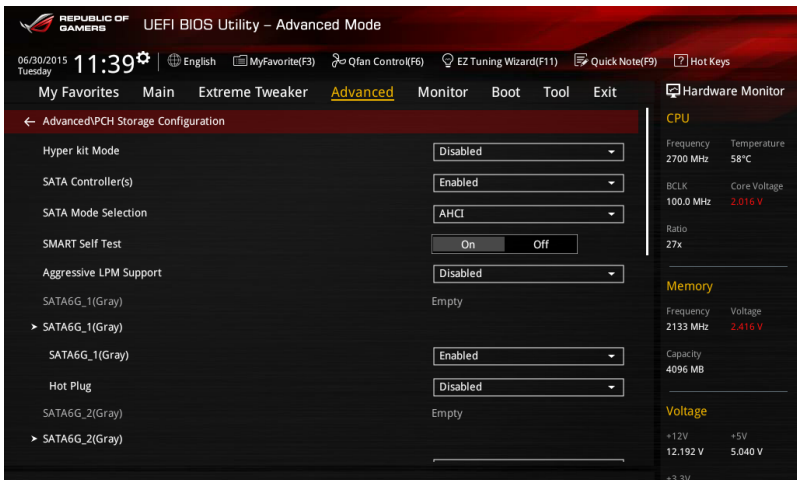

Hyper kit Mode [Disabled]

[Enabled] Enable for "ASUS Hyper kit" card.

[Disabled] Enable M.2 devices.

SATA Controller(s) [enabled]

This item allows you to enable or disable the SATA Device.

Configuration options: [Disabled] [Enabled]

SATA Mode Selection [AHCI]

This item allows you to set the SATA configuration.

[AHCI] Set to [AHCI] when you want the SATA hard disk drives to use the AHCI (Advanced Host Controller Interface). The AHCI allows the onboard storage driver to enable advanced Serial ATA features that increases storage performance on random workloads by allowing the drive to internally optimize the order of commands.

[RAID] Set to [RAID] when you want to create a RAID configuration from the SATA hard disk drives.



The following item appears only when you set the SATA Mode Selection to [RAID].

M.2 PCIe Storage RAID Support [Disabled]

This item allows you to enable or disable PCIe port to SATA for RAID Remapping.

Configuration options: [Disabled] [Enabled]

SATA Express PCIe Storage RAID Support [Disabled]

This item allows you to enable or disable PCIe port to SATA for RAID Remapping.

Configuration options: [Disabled] [Enabled]

PCIe_X4_1 PCIe Storage RAID Support [Disabled]

This item allows you to enable or disable PCIe port to SATA for RAID Remapping.

Configuration options: [Disabled] [Enabled]

SMART Self Test [On]

SMART (Self-Monitoring, Analysis and Reporting Technology) is a monitoring system that shows a warning message during POST (Power-On Self Test) when an error occurs in the hard disks.

Configuration options: [On] [Off]

Aggressive LPM Support [Disabled]

This item is designed for LPM (link power management) support with a better energy saving conditions. When set to [Enabled], the hot plug function of SATA ports are disabled.

Configuration options: [Disabled] [Enabled]

SATA6G_1(Gray) - SATA6G_6(Gray)

SATA6G_1(Gray) - SATA6G_6(Gray) [Enabled]

This item allows you to enable or disable the selected SATA port.

Configuration options: [Disabled] [Enabled]

Hot Plug [Disabled]

These items appears only when the SATA Mode Selection is set to [AHCI] and allows you to enable or disable SATA Hot Plug Support.

Configuration options: [Disabled] [Enabled]

3.6.7 USB Configuration

The items in this menu allow you to change the USB-related features.

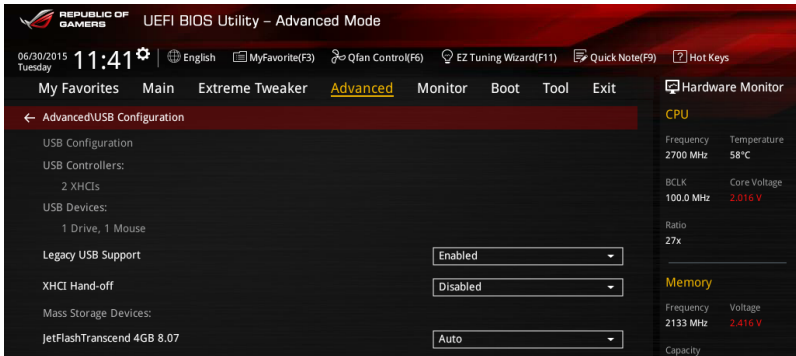

The **USB Devices** item shows the auto-detected values. If no USB device is detected, the item shows **None**.

Legacy USB Support [Enabled]

[Disabled] The USB devices can be used only for the BIOS setup program. It cannot be recognized in boot devices list.

[Enabled] Enables the support for USB devices on legacy operating systems (OS).

[Auto] Allows the system to detect the presence of USB devices at startup. If detected, the USB controller legacy mode is enabled. If no USB device is detected, the legacy USB support is disabled.

XHCI Hand-off [Disabled]



This item is set to [Disabled] by default for the EHCI (enhanced host controller interface) support by XHCI drivers in operating systems.

[Disabled] Support XHCI by XHCI drivers for operating systems with XHCI support.

[Enabled] Support XHCI by BIOS for operating systems without XHCI support.

USB Single Port Control

This item allows you to enable or disable the individual USB ports.



Refer to section **1.2.2 Motherboard layout** for the location of the USB ports.

3.6.8 Network Stack Configuration

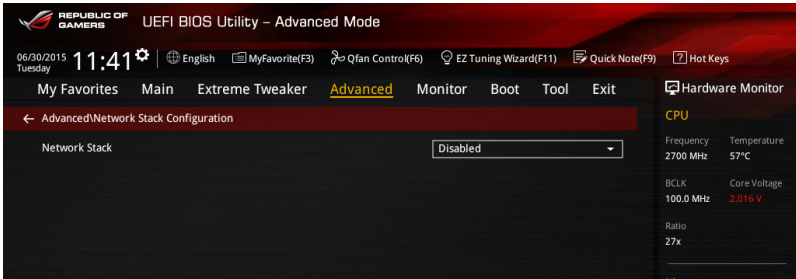

Network Stack [Disabled]

This item allows you to disable or enable the UEFI network stack.

Configuration options: [Disabled] [Enabled]



The following items appear only when you set the Network Stack to [Enabled].

Ipv4/Ipv6 PXE Support [Enabled]

This item allows you to enable or disable the Ipv4/Ipv6 PXE boot option.

Configuration options: [Disabled] [Enabled]

3.6.9 Onboard Devices Configuration

Scroll down to view the other BIOS items.

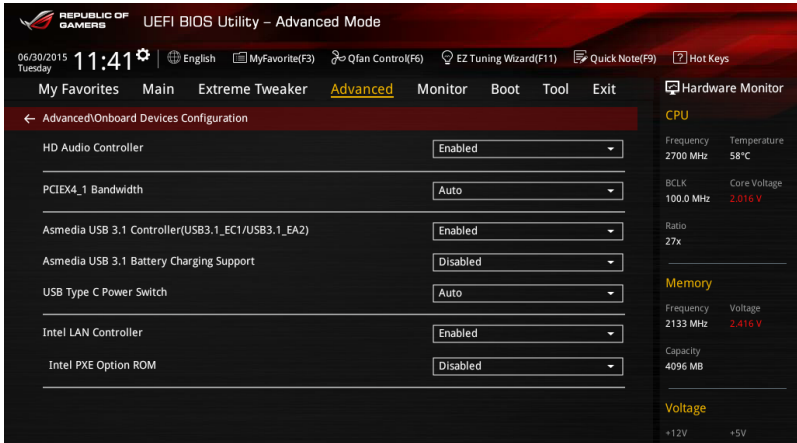

HD Audio Controller [Enabled]

[Disabled] HDA will be unconditionally disabled

[Enabled] HDA will be unconditionally enabled

PCIEX4_1 Bandwidth [Auto]

[Auto] Run at X2 mode with SATA6G_56/SATAEXPRESS_2 enabled

[X4 Mode] X4 mode

Asmedia USB 3.1 Controller(USB3.1_EC1/USB3.1_EA2) [Enabled]

This item allows you to disable or enable the ASMedia USB 3.1 Controller.

Configuration options: [Disabled] [Enabled]

Asmedia USB 3.1 Battery Charging Support [Disabled]

This item allows you to disable or enable the ASMedia USB 3.1 Battery Charging Support.

Configuration options: [Disabled] [Enabled]

USB Type C Power Switch [Auto]

[Auto] The system will automatically detect your USB Type C devices and provide suitable power if needed.

[Enabled] The USB Type C port will always provide power to your devices.

Intel LAN Controller [Enabled]

This item allows you to enable or disable the Intel LAN Controller.

Configuration options: [Disabled] [Enabled]



The following item appears only when you set the Intel LAN Controller to **[Enabled]**.

Intel LAN PXE Option ROM [Disabled]

This item appears only when Intel LAN Controller is set to **[Enabled]**. This item allows you to enable or disable the Intel LAN preboot execution environment (PXE) option ROM. Configuration options: [Enabled] [Disabled]

3.6.10 APM Configuration

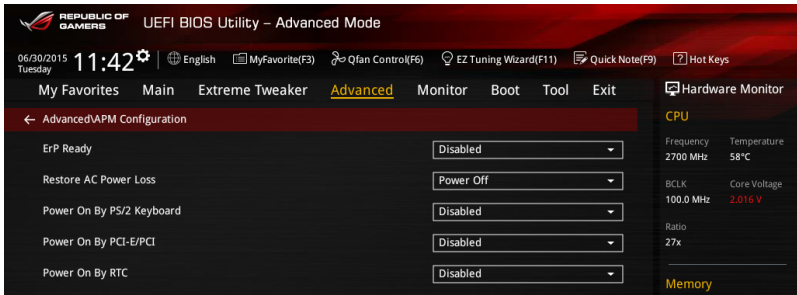

ErP Ready [Disabled]

Allows you to switch off some power at S4+S5 or S5 to get the system ready for ErP requirement. When set to **[Enabled]**, all other PME options will be switched off.

Configuration options: [Disabled] [Enabled(S4+S5)] [Enabled(S5)]

Restore AC Power Loss [Power Off]

[Power Off] The system goes into OFF state after an AC power loss.

[Power On] The system goes into ON state after an AC power loss.

[Last State] The system goes into either OFF or ON state, whatever the system state was before the AC power loss.

Power On By PS/2 Keyboard [Disabled]

Allows you to power on by pressing a specific key(s) on the keyboard.

Configuration options: [Disabled] [Space Bar] [Ctrl-Esc] [Power Key]

Power On By PCI-E/PCI [Disabled]

Allows you to enable or disable the wake-on-LAN function for the onboard LAN controller or other installed PCI-E LAN cards.

Configuration options: [Disabled] [Enabled]

Power On By RTC [Disabled]

[Disabled] Disables RTC to generate a wake event.

[Enabled] Generates a wake event and configure the real-time clock (RTC) alarm date.

3.6.11 HDD/SSD SMART Information

This menu displays the SMART information of the connected devices.

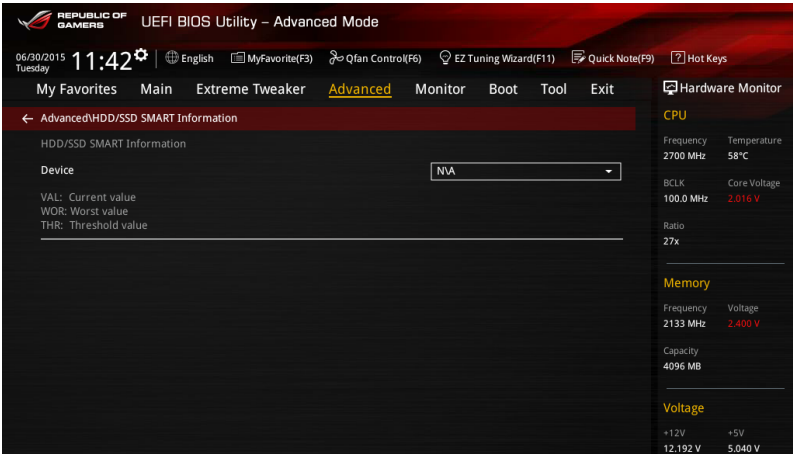

3.7 Monitor menu

The Monitor menu displays the system temperature/power status, and allows you to change the fan settings.

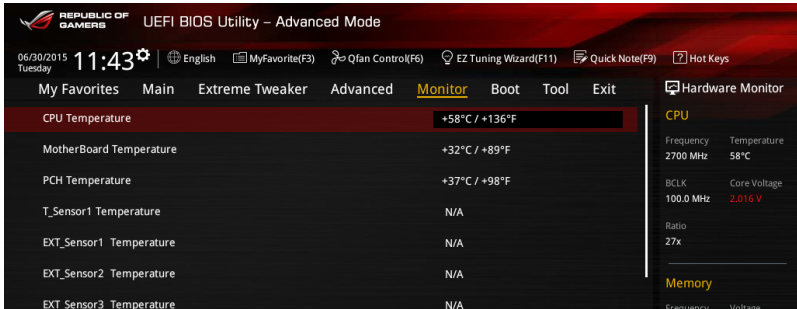

Q-Fan Configuration

Qfan Tuning

Click this item to automatically detect the lowest speed and configure the minimum duty cycle for each fan.

CPU Q-Fan Control [Auto]

- [Auto] Detect the type of CPU fan installed and automatically switches the mode control.
- [PWM Mode] Enable the CPU Q-Fan control feature in PWM mode for 4-pin CPU fan.
- [DC Mode] Enable the CPU Q-Fan control feature in DC mode for 3-pin CPU fan.
- [Disabled] Disable the Q-Fan control.

CPU Fan Step Up [0 sec]

This item allows you to set the value of the CPU fan step up.

Configuration options: [0 sec] [2.1 sec] [2.8 sec] [3.6 sec] [4.5 sec] [5.0 sec] [6.3 sec] [8.5 sec] [12 sec] [25 sec]

CPU Fan Step Down [0 sec]

This item allows you to set the value of the CPU fan step down.

Configuration options: [0 sec] [2.1 sec] [2.8 sec] [3.6 sec] [4.5 sec] [5.0 sec] [6.3 sec] [8.5 sec] [12 sec] [25 sec]

CPU Fan Speed Lower Limit [200 RPM]

This item allows you to set the low limit warning for CPU Fan speed.

Configuration options: [Ignore] [200 RPM] [300 RPM] [400 RPM] [500 RPM] [600 RPM]

CPU Fan Profile [Standard]

This item allows you to set the appropriate performance level of the CPU fan.

- [Standard] Set to make the CPU fan adjust automatically depending on the CPU temperature.
- [Silent] Set to minimize the fan speed for quiet CPU fan operation.
- [Turbo] Set to achieve maximum CPU fan speed.
- [Manual] Set to assign the detailed fan speed control parameters.



The following items appear only when you set the CPU Fan Profile to **[Manual]**.

CPU Upper Temperature [70]

Use the <+> or <-> keys to adjust the upper limit of the CPU temperature. The values range from 20 to 75.

CPU Fan Max. Duty Cycle (%) [100]

Use the <+> or <-> keys to adjust the maximum CPU fan duty cycle. The values range from 20% to 100%. When the CPU temperature reaches the upper limit, the CPU fan will operate at the maximum duty cycle.

CPU Middle Temperature [25]

Use the <+> or <-> keys to adjust the middle limit of the CPU temperature. The values range from 20 to 75.

CPU Fan Middle. Duty Cycle (%) [20]

Use the <+> or <-> keys to adjust the middle CPU fan duty cycle. The values range from 20% to 100%. When the CPU temperature reaches the middle limit, the CPU fan will operate at the middle duty cycle.

CPU Lower Temperature [20]

Use the <+> or <-> keys to adjust the lower limit of the CPU temperature. The values range from 20 to 75. The CPU fan will operate at the minimum duty cycle when the temperature is lower than the limit.

CPU Fan Min. Duty Cycle(%) [20]

Use the <+> or <-> keys to adjust the minimum CPU fan duty cycle. The values range from 0% to 100%. When the CPU temperature is under the limit, the CPU fan will operate at the minimum duty cycle.

Chassis Fan 1-4 Q-Fan Control [DC Mode]

- [Disabled] Disable the Chassis Q-Fan control feature.
- [DC mode] Enable the Chassis Q-Fan control in DC mode for 3-pin chassis fan.
- [PWM mode] Enable the Chassis Q-Fan control in PWM mode for 4-pin chassis fan.

Chassis Fan 1-4 Q-Fan Source [CPU]

The assignment fan will be controlled according to the selected temperature source.

Configuration options: [CPU] [MotherBoard] [PCH] [T_SENSOR1] [EXT_Sensor1] [EXT_Sensor2] [EXT_Sensor3]



For EXT_Sensor1-3, connect a Thermistor cable to the EXT_TS1-3 header then place the other end to the component to get the temperature.

Chassis Fan 1-4 Step Up [0 sec]

This item allows you to set the value of the CPU fan step up.

Configuration options: [0 sec] [12 sec] [25 sec] [51 sec] [76 sec] [102 sec] [127 sec] [153 sec] [178 sec] [204 sec]

Chassis Fan 1-4 Step Down [0 sec]

This item allows you to set the value of the CPU fan step down.

Configuration options: [0 sec] [12 sec] [25 sec] [51 sec] [76 sec] [102 sec] [127 sec] [153 sec] [178 sec] [204 sec] **Chassis Fan 1-3 Fan Speed Low Limit [200 RPM]**

This item allows you to disable or set the chassis fan warning speed.

Configuration options: [Ignore] [200 RPM] [300 RPM] [400 RPM] [500 RPM] [600 RPM]

Chassis Fan 1-4 Profile [Standard]

This item allows you to set the appropriate performance level of the chassis fan.

[Standard] Sets to [Standard] to make the chassis fan automatically adjust depending on the chassis temperature.

[Silent] Sets to [Silent] to minimize the fan speed for quiet chassis fan operation.

[Turbo] Sets to [Turbo] to achieve maximum chassis fan speed.

[Manual] Sets to [Manual] to assign detailed fan speed control parameters.



The following four items appear only when you set Chassis Fan 1-4 Profile to **[Manual]**.

Chassis Fan 1-4 Upper Temperature [70]

Use the <+> or <-> keys to adjust the upper limit of the Chassis Fan 1-4 temperature. The values range from 20 to 75.

Chassis Fan 1-4 Max. Duty Cycle (%) [100]

Use the <+> or <-> keys to adjust the maximum Chassis Fan 1-4 duty cycle. The values range from 20% to 100%. When the CPU temperature reaches the upper limit, the Chassis Fan 1-4 will operate at the maximum duty cycle.

Chassis Fan 1-4 Middle Temperature [45]

Use the <+> or <-> keys to adjust the middle limit of the Chassis Fan 1-4 temperature. The values range from 20 to 75.

Chassis Fan 1-4 Middle. Duty Cycle (%) [60]

Use the <+> or <-> keys to adjust the middle Chassis Fan 1-4 duty cycle. The values range from 20% to 100%. When the CPU temperature reaches the middle limit, the Chassis Fan 1-4 will operate at the middle duty cycle.

Chassis Fan 1-4 Lower Temperature [40]

Use the <+> or <-> keys to adjust the lower limit of the Chassis Fan 1-4 temperature. The values range from 20 to 75. The Chassis Fan 1-4 will operate at the minimum duty cycle when the temperature is lower than the limit.

Chassis Fan 1-4 Min. Duty Cycle(%) [60]

Use the <+> or <-> keys to adjust the minimum Chassis Fan 1-4 fan duty cycle. The values range from 0% to 100%. When the CPU temperature is under the limit, the Chassis Fan 1-4 fan will operate at the minimum duty cycle.

ASUS FAN EXTENSION CARD is required to configure these items

Extension Fan 1-3 Q-Fan Control [DC Mode]

- [Disabled] Disable the Extension Fan Q-Fan control feature.
- [DC mode] Enable the Extension Fan Q-Fan control in DC mode for 3-pin chassis fan.
- [PWM mode] Enable the Extension Fan Q-Fan control in PWM mode for 4-pin chassis fan.

Extension Fan 1-3 Q-Fan Source [CPU]

The assignment fan will be controlled according to the selected temperature source. Configuration options: [CPU] [MotherBoard] [VRM] [PCH] [T_SENSOR1] [EXT_Sensor1] [EXT_Sensor2] [EXT_Sensor3]



For EXT_Sensor1-3, connect a Thermistor cable to the EXT_TS1-3 header then place the other end to the component to get the temperature.

Extension Fan 1-3 Fan Speed Low Limit [200 RPM]

This item allows you to disable or set the chassis fan warning speed. Configuration options: [Ignore] [200 RPM] [300 RPM] [400 RPM] [500 RPM] [600 RPM]

Extension Fan 1-3 Profile [Standard]

- This item allows you to set the appropriate performance level of the CPU fan.
- [Standard] Set to make the CPU fan adjust automatically depending on the CPU temperature.
- [Silent] Set to minimize the fan speed for quiet CPU fan operation.
- [Turbo] Set to achieve maximum CPU fan speed.
- [Manual] Set to assign the detailed fan speed control parameters.



The following items appear only when you set the Extension Fan Profile to **[Manual]**.

Extension Fan 1-3 Upper Temperature [70]

Use the <+> or <-> keys to adjust the upper limit of the Extension Fan 1-4 temperature. The values range from 20 to 75.

Extension Fan 1-3 Max. Duty Cycle (%) [100]

Use the <+> or <-> keys to adjust the maximum Extension Fan 1-4 duty cycle. The values range from 20% to 100%. When the CPU temperature reaches the upper limit, the Extension Fan 1-4 will operate at the maximum duty cycle.

Extension Fan 1-3 Middle Temperature [45]

Use the <+> or <-> keys to adjust the middle limit of the Extension Fan 1-4 temperature. The values range from 20 to 75.

Extension Fan 1-3 Middle. Duty Cycle (%) [60]

Use the <+> or <-> keys to adjust the middle Extension Fan 1-4 duty cycle. The values range from 20% to 100%. When the CPU temperature reaches the middle limit, the Extension Fan 1-4 will operate at the middle duty cycle.

Extension Fan 1-3 Lower Temperature [40]

Use the <+> or <-> keys to adjust the lower limit of the Extension Fan 1-4 temperature. The values range from 20 to 75. The Extension Fan 1-4 will operate at the minimum duty cycle when the temperature is lower than the limit.

Extension Fan 1-3 Min. Duty Cycle(%) [60]

Use the <+> or <-> keys to adjust the minimum Extension Fan 1-4 duty cycle. The values range from 0% to 100%. When the CPU temperature is under the limit, the Extension Fan 1-4 will operate at the minimum duty cycle.

Water Pump Control [Disabled]

- [Disabled] Disable the Water Pump control feature.
- [DC mode] Enable the Water Pump control in DC mode for 3-pin chassis fan.
- [PWM mode] Enable the Water Pump control in PWM mode for 4-pin chassis fan.

Anti Surge Support [On]

Enable this item for Over Voltage Protection (OVP) and Under Voltage Protection (UVP) functions.

Configuration options: [On] [Off]

3.8 Boot menu

The Boot menu items allow you to change the system boot options. Scroll down to display the other BIOS items.

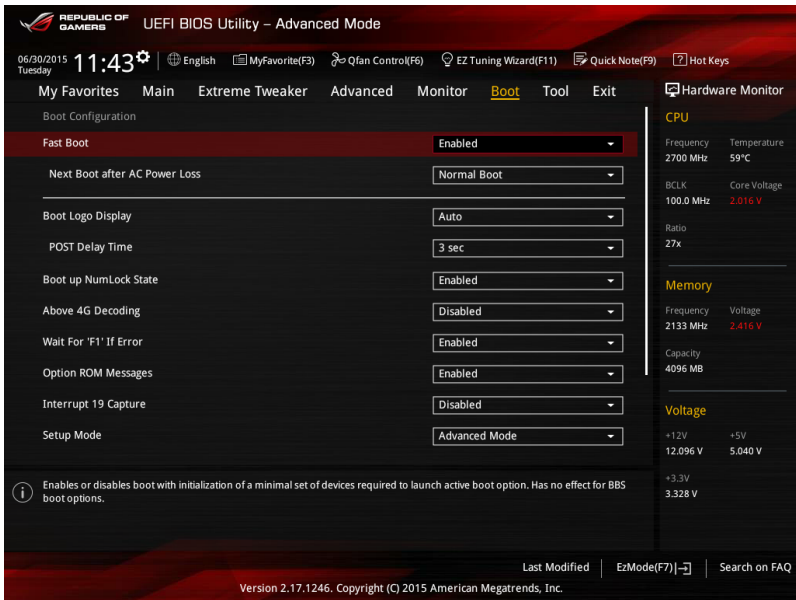

Fast Boot [Enabled]

[Disabled] Allows your system to go back to its normal boot speed.

[Enabled] Allows your system to accelerate the boot speed.



The following items appear only when you set the Fast Boot to **[Enabled]**.

Next Boot after AC Power Loss [Normal Boot]

[Normal Boot] Returns to normal boot on the next boot after an AC power loss.

[Fast Boot] Accelerates the boot speed on the next boot after an AC power loss.

Boot Logo Display [Auto]

- [Auto] Auto adjustments for Windows requirements.
[Full Screen] Maximize the boot logo size.
[Disabled] Hid the logo during POST.



The following items appears only when you set the Boot Logo Display item to **[Disabled]**.

Post Report [5 sec]

This item This item allows you to select a desired waiting time of the POST report from 0 to 10 seconds or until <ESC> is pressed.



The following items appears only when you set the Boot Logo Display item to **[Full Screen]** or **[Auto]**.

Post Delay Time [3 sec]

This item This item allows you to select a desired additional POST waiting time to easily enter the BIOS Setup. You can only execute the POST delay time during normal boot. The values range from 0 to 10 seconds.



This feature only works when set under normal boot.

Boot up NumLock State [Enabled]

- [Enabled] Set the power-on state of the NumLock to **[On]**.
[Disabled] Set the power-on state of the NumLock to **[Off]**.

Above 4G Decoding [Disabled]

This item enables or disables 64-bit capable devices to be decoded in above 4G address space if your system supports 64-bit PCI Decoding.

Configuration options: [Enabled] [Disabled]

Wait For 'F1' If Error [Enabled]

Enable this item for the system to pause until the F1 key is pressed when any error occurs.
Configuration options: [Disabled] [Enabled]

Option ROM Messages [Enabled]

- [Enabled] The Option ROM Messages will be shown during the POST.
[Disabled] Only the ASUS logo will be shown during the POST.

Interrupt 19 Capture [Disabled]

- [Enabled] Execute the trap right away.
[Disabled] Execute the trap during legacy boot.

Setup Mode [Advanced Mode]

- [Advanced Mode] This item allows you to go to Advanced Mode of the BIOS after POST.
[EZ Mode] This item allows you to go to EZ Mode of the BIOS after POST.

CSM (Compatibility Support Module)

This item allows you to configure the CSM (Compatibility Support Module) items to fully support the various VGA, bootable devices and add-on devices for better compatibility.

Launch CSM [Enabled]

- | | |
|------------|---|
| [Auto] | The system automatically detects the bootable devices and the add-on devices. |
| [Enabled] | For better compatibility, enable the CSM to fully support the non-UEFI driver add-on devices or the Windows® UEFI mode. |
| [Disabled] | Disable the CSM to fully support the non-UEFI driver add-on devices or the Windows® UEFI mode. |



The following items appear only when you set the Launch CSM to **[Enabled]**.

Boot Devices Control [UEFI and Legacy OPROM]

This item allows you to select the type of devices that you want to boot.

Configuration options: [UEFI and Legacy OPROM] [Legacy OPROM only] [UEFI only]

Boot from Network Devices [Legacy only]

This item allows you to select the type of network devices that you want to launch.

Configuration options: [Legacy only] [UEFI driver first] [Ignore]

Boot from Storage Devices [Legacy only]

This item allows you to select the type of storage devices that you want to launch.

Configuration options: [Legacy only] [UEFI driver first] [Ignore]

Boot from PCI-E/PCI Expansion Devices [Legacy only]

This item allows you to select the type of PCI-E/PCI expansion devices that you want to launch.

Configuration options: [Legacy only] [UEFI driver first]

Secure Boot

This item allows you to configure the Windows® Secure Boot settings and manage its keys to protect the system from unauthorized access and malwares during POST.

OS Type [Windows UEFI mode]

- | | |
|---------------------|--|
| [Windows UEFI Mode] | This item allows you to select your installed operating system. Execute the Microsoft® Secure Boot check. Only select this option when booting on Windows® UEFI mode or other Microsoft® Secure Boot compliant OS. |
| [Other OS] | Get the optimized function when booting on Windows® non-UEFI mode. Microsoft® Secure Boot only supports Windows® UEFI mode. |

Key Management

Clear Secure Boot keys

This item allows you to clear all default Secure Boot keys.

Save Secure Boot Keys

This item allows you to save the PK (Platform Keys) to a USB storage device.

PK Management

Set New Key

This item allows you to load the downloaded PK from a USB storage device.



The PK file must be formatted as a UEFI variable structure with time-based authenticated variable.

Delete Key

This item allows you to delete the PK from your system. Once the PK is deleted, all the system's Secure Boot keys will not be active.

Configuration options: [Yes] [No]

KEK Management



Key-exchange Key (KEK) refers to Microsoft® Secure Boot Key-Enrollment Key (KEK).

Delete Key

Allows you to delete the KEK from your system.

Configuration options: [Yes] [No]

Set New Key

Allows you to load the downloaded KEK from a USB storage device.

Append Key

Allows you to load the additional KEK from a storage device for an additional db and dbx loaded management.



The KEK file must be formatted as a UEFI variable structure with time-based authenticated variable.

DB Management

Delete Key

Allows you to delete the db file from your system.

Configuration options: [Yes] [No]

Set New Key

Allows you to load the downloaded db from a USB storage device.

Append Key

Allows you to load the additional db from a storage device so that more images can be loaded securely.



The dbx file must be formatted as a UEFI variable structure with time-based authenticated variable. DBX Management

DBX Management

Delete Key

Allows you to delete the dbx file from your system.

Set New Key

Allows you to load the downloaded dbx from a USB storage device.

Configuration options: [Yes] [No]

Append Key

Allows you to load the additional dbx from a storage device so that more db's images cannot be loaded.



The dbx file must be formatted as a UEFI variable structure with time-based authenticated variable.

Boot Option Priorities

These items specify the boot device priority sequence from the available devices. The number of device items that appears on the screen depends on the number of devices installed in the system.



- To access Windows® OS in Safe Mode, press <F8> after POST (Windows® 8 not supported).
 - To select the boot device during system startup, press <F8> when the ASUS Logo appears.
-

Boot Override

These items displays the available devices. The number of device items that appears on the screen depends on the number of devices installed in the system. Click an item to start booting from the selected device.

3.9 Tool menu

The Tools menu items allow you to configure options for special functions. Select an item then press <Enter> to display the submenu.

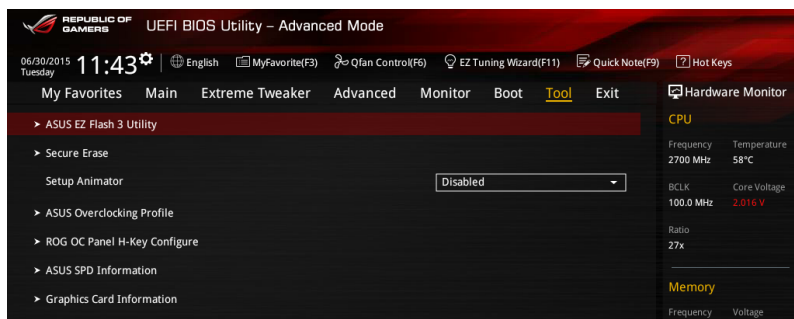

Setup Animator [Disabled]

This item allows you to disable or enable the Setup Animator.

Configuration options: [Disabled] [Enabled]

3.9.1 ASUS EZ Flash 3 Utility

Allows you to run ASUS EZ Flash 3. When you press <Enter>, a confirmation message appears. Use the Left/Right arrow key to select between [by USB] or [by Internet], then press <Enter> to confirm your choice.



For more details, refer to section ASUS EZ Flash 3 utility.

3.9.2 Secure Erase

SSD speeds may lower over time as with any storage medium due to data processing. Secure Erase completely and safely cleans your SSD, restoring it to factory performance levels.



Secure Erase is only available in AHCI mode. Ensure to set the SATA mode to AHCI. Click **Advanced > SATA Configuration > AHCI**.

To launch Secure Erase, click **Tool > Secure Erase** on the Advanced mode menu.



Check the ASUS support site for a full list of SSDs tested with Secure Erase. The drive may become unstable if you run Secure Erase on an incompatible SSD.



- The time to erase the contents of your SSD may take a while depending on its size. Do not turn off the system during the process.
- Secure Erase is only supported on Intel SATA port. For more information about Intel SATA ports, refer to section 1.2.2 of this manual.

Displays the available SSDs

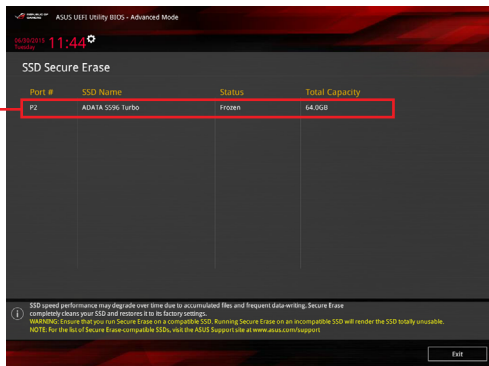

Status definition:

- **Frozen.** The frozen state is the result of a BIOS protective measure. The BIOS guards drives that do not have password protection by freezing them prior to booting. If the drive is frozen, a power off or hard reset of your PC must be performed to proceed with the Secure Erase.
- **Locked.** SSDs might be locked if the Secure Erase process is either incomplete or was stopped. This may be due to a third party software that uses a different password defined by ASUS. You have to unlock the SSD in the software before proceeding with Secure Erase.

3.9.3 ASUS Overclocking Profile

This item allows you to store or load multiple BIOS settings.

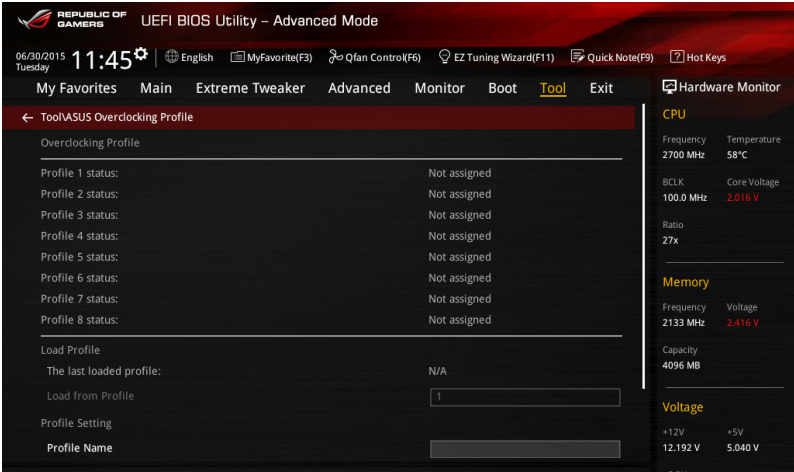

Profile Name

Key in the profile name to save current BIOS settings to profile 1 to 8.

Save to Profile

Saves the current BIOS settings to profile number 1 to 8.

Load/Save Profile from/to USB Drive

Load/Save profiles from/to an external USB Drive.

3.9.4 ROG OC Panel H-Key Configure

The ROG OC Panel H-Key Configure allows you to input and save values on the CPU core voltage, VCCSA voltage, BCLK Frequency, and CPU ratio in the UEFI BIOS. The saved values can be synchronized to a compatible OC Panel device and these values can be tweaked or configured using the OC Panel without going to the BIOS menu.

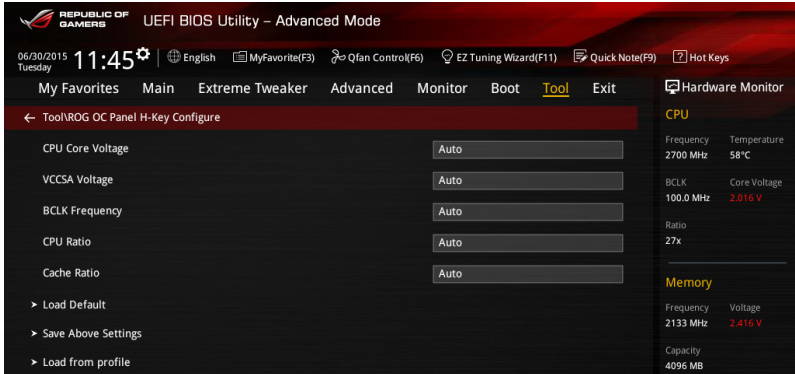

Load Default

This item allows you to load the default values of the CPU Core Voltage, VCCSA Voltage, BCLK Frequency, and CPU Ratio.

Save Above Settings

This item allows you to save the new values of the CPU Core Voltage, VCCSA Voltage, BCLK Frequency, and CPU Ratio.

Load from profile

This item allows you to load the previous values of the CPU Core Voltage, VCCSA Voltage, BCLK Frequency, and CPU Ratio.

3.9.5 ASUS SPD Information

Allows you to view the DRAM SPD information.

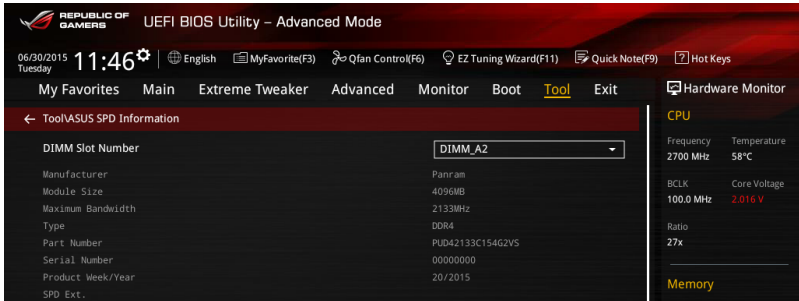

DIMM slot number

Allows you to select the DIMM slot number to show the plugged DRAM Serial Presence Detect (SPD) information.

Configuration options: [DIMM_A1] [DIMM_A2] [DIMM_B1] [DIMM_B2]



Some DRAM manufacturers may not be recognized.

3.9.6 Graphics Card Information

This item displays the information about the graphics card installed in your system.

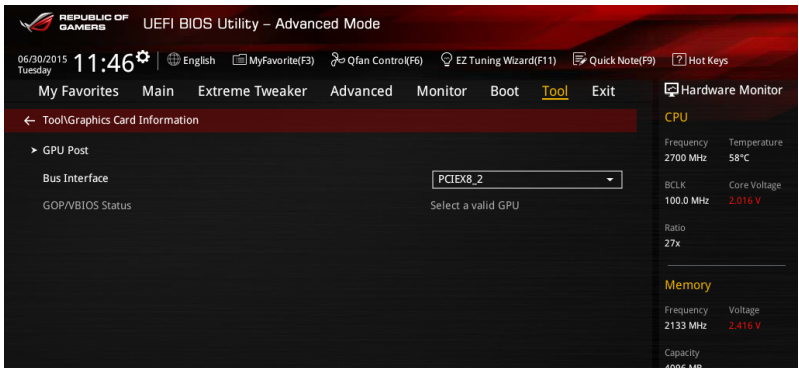

GPU Post

This item displays the information and recommended configuration for the PCIE slots that the graphics card is installed in your system.

Bus Interface

This item allows you to select the bus interface.

Configuration options: [PCIEX16/X8_1] [PCIEX8_2]

3.10 Exit menu

The Exit menu items allow you to load the optimal default values for the BIOS items, and save or discard your changes to the BIOS items.

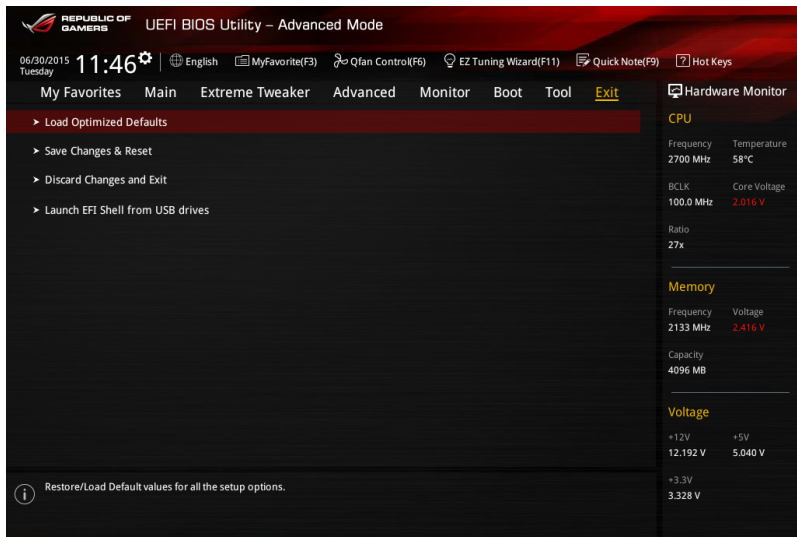

Load Optimized Defaults

This option allows you to load the default values for each of the parameters on the Setup menu. When you select this option or if you press <F5>, a confirmation window appears. Select Yes to load the default values.

Save Changes & Reset

Once you are finished making your selections, choose this option from the Exit menu to ensure the values you selected are saved. When you select this option or if you press <F10>, a confirmation window appears. Select Yes to save changes and exit.

Discard Changes & Exit

This option allows you to exit the Setup program without saving your changes. When you select this option or if you press <Esc>, a confirmation window appears. Select Yes to discard changes and exit.

Launch EFI Shell from USB device

This option allows you to attempt to launch the EFI Shell application (shellx64.efi) from one of the available filesystem devices.

3.11 Updating BIOS

The ASUS website publishes the latest BIOS versions to provide enhancements on system stability, compatibility, and performance. However, BIOS updating is potentially risky. If there is no problem using the current version of BIOS, DO NOT manually update the BIOS. Inappropriate BIOS updating may result to system's failure to boot. Carefully follow the instructions in this chapter to update your BIOS when necessary.



Visit <http://www.asus.com> to download the latest BIOS file for this motherboard.

The following utilities allow you to manage and update the motherboard BIOS setup program.

1. EZ Update: Updates the BIOS in Windows® environment.
2. ASUS EZ Flash 3: Updates the BIOS using a USB flash drive.
3. ASUS CrashFree BIOS 3: Restores the BIOS using the motherboard support DVD or a USB flash drive when the BIOS file fails or gets corrupted.
4. ASUS BIOS Updater: Updates the BIOS in DOS environment using the motherboard support DVD and a USB flash disk drive.

3.11.1 EZ Update

The EZ Update is a utility that allows you to update the motherboard BIOS in Windows® environment.



- EZ Update requires an Internet connection either through a network or an ISP (Internet Service Provider).
 - This utility is available in the support DVD that comes with the motherboard package.
-

3.11.2 ASUS EZ Flash 3 Utility

ASUS EZ Flash 3 Utility allows you to update the BIOS without having to use a bootable floppy disk or an OS-based utility.



Before you start using this utility, download the latest BIOS from the ASUS website at <http://www.asus.com>.

To update the BIOS using ASUS EZ Flash 3 Utility:

1. Insert the USB flash disk that contains the latest BIOS file to the USB port.
2. Enter the Advanced Mode of the BIOS setup program. Go to the Tool menu to select **ASUS EZ Flash 3 Utility** and press <Enter>. Use the Left/Right arrow key to select between [by USB] or [by Internet], then press <Enter> to confirm your choice.

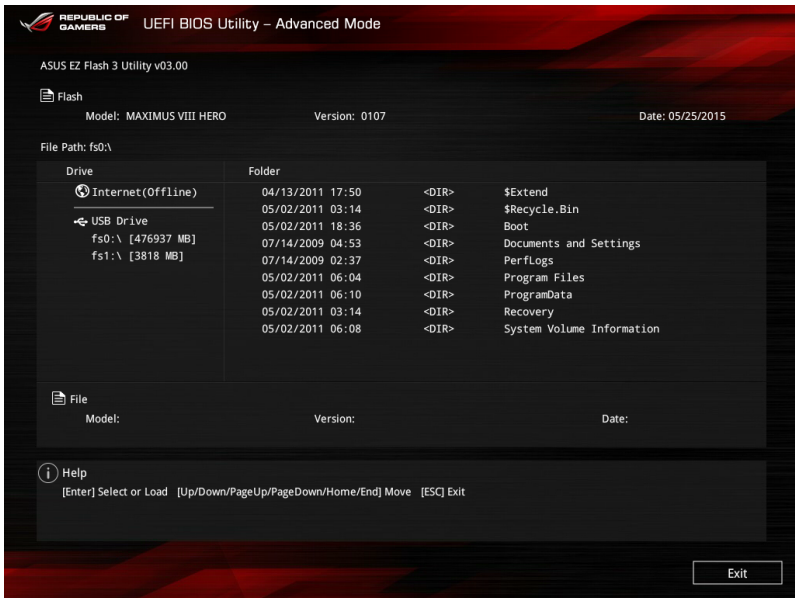

3. Press <Tab> to switch to the Drive field.
4. Press the Up/Down arrow keys to find the USB flash disk that contains the latest BIOS, and then press <Enter>.
5. Press <Tab> to switch to the Folder Info field.
6. Press the Up/Down arrow keys to find the BIOS file, and then press <Enter> to perform the BIOS update process. Reboot the system when the update process is done.



-
- This function can support devices such as a USB flash disk with FAT 32/16 format and single partition only.
 - DO NOT shut down or reset the system while updating the BIOS to prevent system boot failure!
-



Ensure to load the BIOS default settings to ensure system compatibility and stability. Select the Load Optimized Defaults item under the Exit menu. See section **3.10 Exit Menu** for details.

3.11.3 ASUS CrashFree BIOS 3

The ASUS CrashFree BIOS 3 utility is an auto recovery tool that allows you to restore the BIOS file when it fails or gets corrupted during the updating process. You can restore a corrupted BIOS file using the motherboard support DVD or a USB flash drive that contains the BIOS file.



The BIOS file in the motherboard support DVD may be older than the BIOS file published on the ASUS official website. If you want to use the newer BIOS file, download the file at <http://support.asus.com> and save it to a USB flash drive.

Recovering the BIOS

To recover the BIOS:

1. Turn on the system.
2. Insert the motherboard support DVD to the optical drive, or the USB flash drive containing the BIOS file to the USB port.
3. The utility automatically checks the devices for the BIOS file. When found, the utility reads the BIOS file and enters the ASUS EZ Flash 3 Utility automatically.
4. The system requires you to enter BIOS Setup to recover the BIOS setting. To ensure system compatibility and stability, we recommend that you press <F5> to load default BIOS values.



DO NOT shut down or reset the system while updating the BIOS! Doing so can cause system boot failure!

3.11.4 ASUS BIOS Updater

ASUS BIOS Updater allows you to update the BIOS in DOS environment.



The screen captures used in this section are for reference only and may not be exactly the same as actually shown on your computer screen.

Before updating BIOS

- Prepare the motherboard support DVD and a USB flash drive.
- Download the latest BIOS file and BIOS Updater from <http://support.asus.com> and save them in your USB flash drive.



NTFS is not supported under DOS environment. Ensure that your USB flash drive is in single partition and in FAT32/16 format.

- Turn off the computer.
- Ensure that your computer has a DVD optical drive.

Booting the system in DOS environment

To boot the system in DOS:

1. Insert the USB flash drive with the latest BIOS file and BIOS Updater to the USB port.
2. Boot your computer then press <F8> to launch the select boot device screen.
3. When the select boot device screen appears, insert the Support DVD into the optical drive then select the optical drive as the boot device.

```
Please select boot device:
-----
E1:  ASUS DVD-E818A6T  (4069MB)
     USB DISK 2.0  (3824MB)
UEFI: (FAT)  USB DISK 2.0  (3824MB)
Enter Setup
-----

↑ and ↓ to move selection
ENTER to select boot device
ESC to boot using defaults
```

- When the booting message appears, press <Enter> within five (5) seconds to enter FreeDOS prompt.

```
ISOLINUX 3.20 2006-08-26 Copyright (C) 1994-2005 H. Peter Anvin
A Bootable DVD/CD is detected. Press ENTER to boot from the DVD/CD.
If no key is pressed within 5 seconds, the system will boot next priority
device automatically. boot:
```

- On the FreeDOS prompt, type **d:** then press <Enter> to switch the disk from Drive C (optical drive) to Drive D (USB flash drive).

```
Welcome to FreeDOS (http://www.freedos.org) !
C: /> d:
D: />
```

Updating the BIOS file

To update the BIOS file:

- On the FreeDOS prompt, type **bupdater /pc /g** and press <Enter>.

```
D: /> bupdater /pc /g
```

- On the BIOS Updater screen, press <Tab> to switch from Files panel to Drives panel then select **D:**.

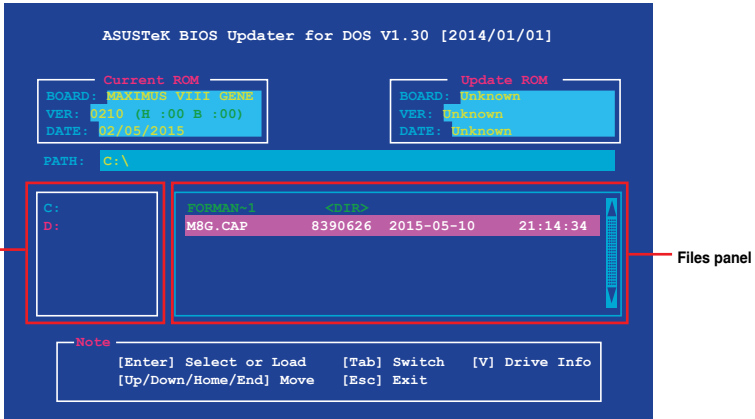

- Press <Tab> to switch from Drives panel to Files panel then press <Up/Down or Home/End> keys to select the BIOS file and press <Enter>.

4. After the BIOS Updater checks the selected BIOS file, select **Yes** to confirm the BIOS update.



The BIOS Backup feature is not supported due to security regulations.

5. Select **Yes** then press <Enter>. When BIOS update is done, press <ESC> to exit BIOS Updater.
6. Restart your computer.



DO NOT shut down or reset the system while updating the BIOS to prevent system boot failure.



Ensure to load the BIOS default settings to ensure system compatibility and stability. Select the **Load Optimized Defaults** item under the **Exit** BIOS menu. See section **3.10 Exit menu** for details.

Software Support

4

4.1 Installing an operating system



-
- This motherboard supports Windows® 7 and 64-bit Windows® 8, Windows® 8.1, and Windows® 10 operating systems (OS).
 - Motherboard settings and hardware options vary. Use the setup procedures presented in this chapter for reference only. Refer to your OS documentation for detailed information.
-

4.1.1 Windows® 7 and USB 3.0 driver installation for 100 Series

Based on the chipset specification, the 100 series requires USB 3.0 drivers to be preloaded in order to use USB keyboard/mouse during Windows® 7 installation. This section is a guide on preloading USB 3.0 drivers and installing Windows® 7.

Method 1: Using SATA ODD & USB devices

Load USB 3.0 drivers using the ASUS support DVD and install Windows® 7 using a USB device.

Requirement:

- 1 x ASUS support DVD
- 1 x Windows® 7 installation source
- 1 x SATA ODD
- 1 x USB device (ODD or storage)



The USB storage device requires 8 GB or more capacity. It is recommended to format the storage device before use.

1. Insert the Windows® 7 installation DVD into a USB ODD, or copy all files on the Windows® 7 installation DVD to a USB storage device on a working system.
2. Connect the USB ODD or USB storage device to your 100 series platform.
3. Insert the ASUS support DVD into a SATA ODD on your 100 series platform.
4. Power on your system and press F8 during POST (Power-On Self Test) to enter the boot screen.

5. Select the USB ODD or USB storage device as the boot device.

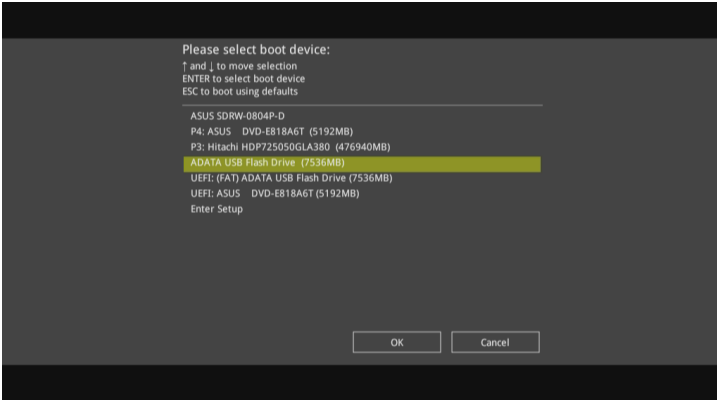

6. The USB 3.0 driver will be loaded automatically during installation startup.

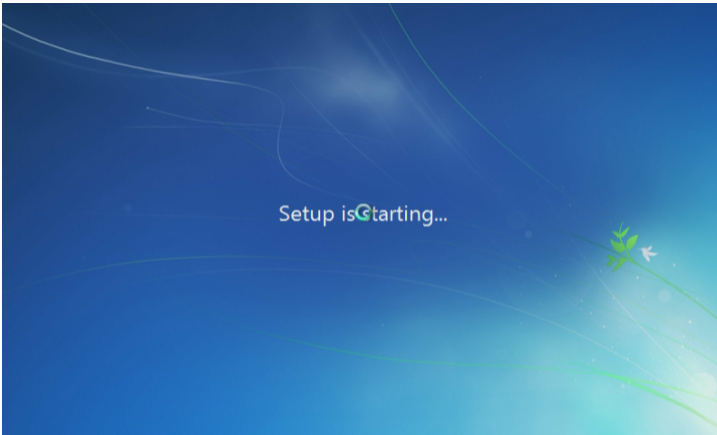

The "Setup is starting..." screen will show up if the USB 3.0 driver is loaded correctly.

7. Follow the onscreen instructions to complete the Windows® 7 installation.

Method 2: Using a modified Windows® 7 ISO

Load USB 3.0 drivers and install Windows® 7 using a modified Windows® 7 installation DVD.

Requirement:

- 1 x ASUS support DVD
 - 1 x Windows® 7 installation source
 - 1 x Working system (PC or notebook)
 - 1 x SATA ODD
1. On your working system, create an ISO image file of the Windows® 7 installation source using a third-party ISO software.
 2. Copy both “Auto_Unattend.xml” and “Auto_Unattend” folder from the root directory of the ASUS supporting DVD to your system.
 3. Edit the ISO file and add both “Auto_Unattend.xml” and “Auto_Unattend” folder into the ISO file.
 4. Burn this ISO file onto an empty DVD to create a modified Windows® 7 installation DVD.
 5. Insert the modified Windows® 7 installation DVD into an ODD on your 100 series platform.
 6. Power on your system and press F8 during POST (Power-On Self Test) to enter the boot screen.
 7. Select the ODD as the boot device.
 8. The USB 3.0 driver will be loaded automatically during installation startup.



The “Setup is starting...” screen will show up if the USB 3.0 driver is loaded correctly.

9. Follow the onscreen instructions to complete the Windows® 7 installation.

Method 3: Using ASUS EZ Installer

Use the ASUS EZ Installer to create a modified Windows® 7 installation source

Requirement:

- 1 x ASUS support DVD
- 1 x Windows® 7 installation DVD
- 1 x Working system (PC or notebook)
- 1 x SATA ODD
- 1 x USB storage device (8 GB or more)

1. Insert the Windows® 7 installation DVD.
2. Launch the ASUS EZ Installer located on the ASUS support DVD.
3. Select a method of creating a modified Windows® 7 installation file:
 - Windows® 7 OS disk to USB storage device

- Select **Windows 7 OS disk to USB storage device** then click **Next**.

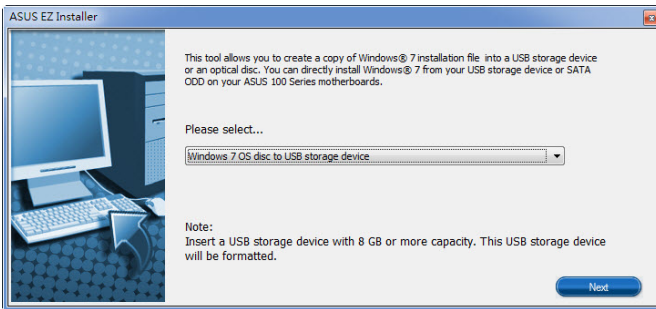

- Check **I agree** and then click **Next**.

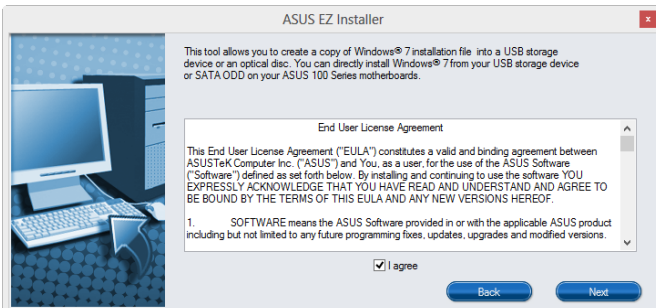

- Select the source of the Windows® 7 installation disk then click **Next**.

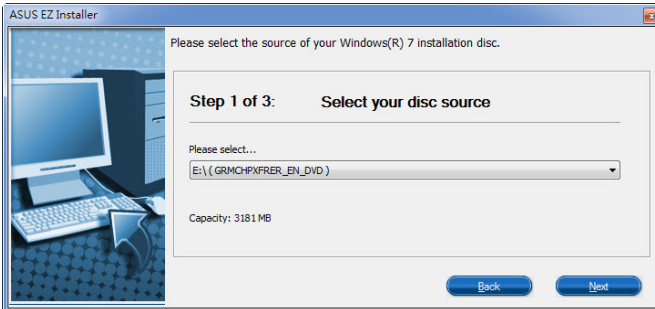

- Select the USB storage device and click **next**.



Click the refresh icon  if the USB storage device is not displayed.

- Click **Yes** to clear the contents on the USB storage device and create a bootable USB device.



Make sure to backup contents on the USB storage device, as it will be formatted.

- Once completed, click **OK** to finish.

- Windows® 7 OS disk to ISO file
 - Select **Windows 7 OS disk to ISO file** then click **Next**.

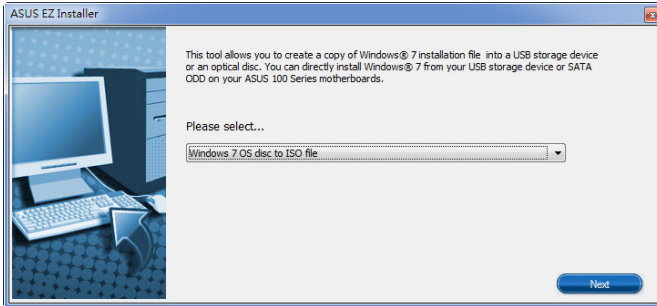

- Check **I agree** and then click **Next**.

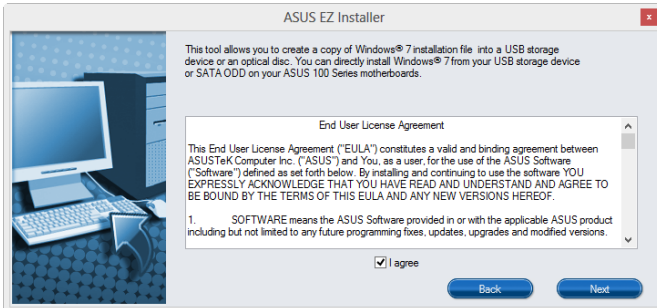

- Select the source of the Windows® 7 installation disk then click **Next**.

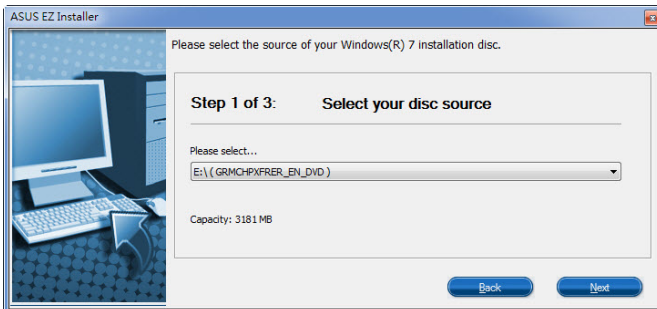

- Select the folder to save the modified Windows® 7 installation ISO file and click **Next**.

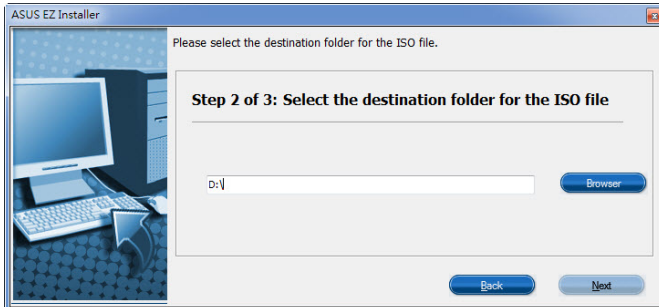

- Once completed, click OK to finish.
 - Burn this ISO file onto an empty DVD to create a modified Windows® 7 installation DVD.
4. Insert the modified Windows® 7 installation DVD into an ODD or connect the USB storage device with modified Windows® 7 installation files onto your 100 series platform.
 5. Power on your system and press F8 during POST (Power-On Self Test) to enter the boot screen.
 6. Select the ODD or USB storage device as the boot device.
 7. The USB 3.0 driver will be loaded automatically during installation startup.



The "Setup is starting..." screen will show up if the USB 3.0 driver is loaded correctly.

8. Follow the onscreen instructions to complete the Windows® 7 installation.

4.2 Support DVD information



The contents of the support DVD are subject to change at any time without notice. Visit www.asus.com for updates.

4.2.1 Running the support DVD



Ensure that you have an Administrator account before running the support DVD in Windows® 7, Windows® 8, Windows® 8.1, or Windows® 10 OS.

To run the support DVD:

1. Place the Support DVD into the optical drive.
2. In the **AutoPlay** dialog box, click **Run ASSETUP.exe**.

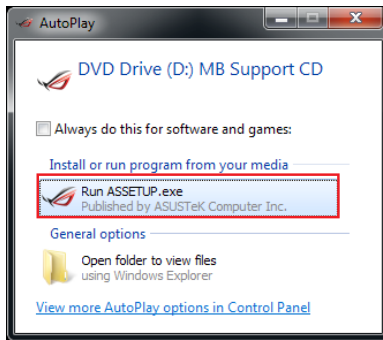

If Autorun is NOT enabled in your computer, browse the contents of the support DVD to locate the file **SETUP.EXE** from the **BIN** folder. Double-click the **ASSETUP.EXE** to run the support DVD.

Support DVD main menu

Shows the available device drivers if the system detects installed devices. Install the necessary drivers to use the devices.

Click to display the applications and other software that the motherboard supports.

Contains the list of supplementary user manuals. Click an item to open the folder of the user guide

Click to display product related information.

Click to select an item to install

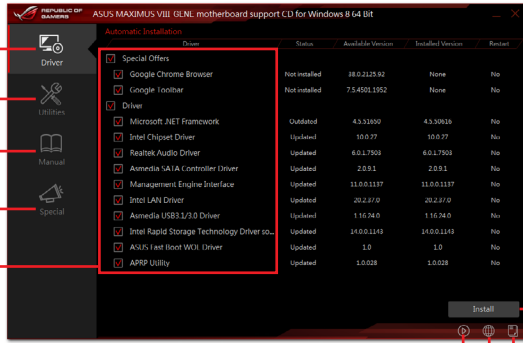

Contains ROG related videos.

Click to display the ASUS contact information.

Click to browse the file list of the suport CD

Click to install the selected items

4.2.2 Obtaining the software manuals

The software manuals are included in the support DVD. Follow the instructions below to get the necessary software manuals.



The software manual files are in Portable Document Format (PDF). Install the Adobe® Acrobat® Reader from the **Utilities** tab before opening the files.

To read about your motherboard's utility guide:

1. Click **Manual** tab > **Motherboard Installation Guide**.

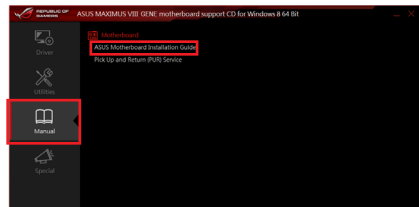

2. From the **Manual** folder, open the folder of the software manual that you wish to read.

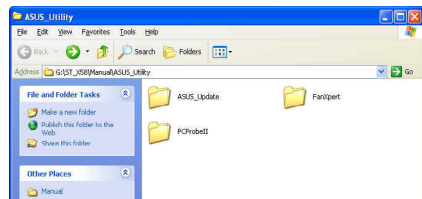

- Some software manuals are provided in different languages. Open the language's folder to view the software manual.

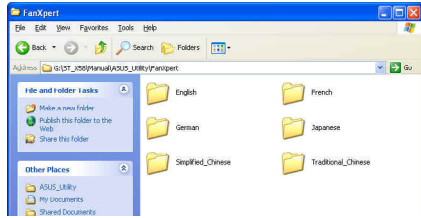

The screenshots in this section are for reference only. The actual software manuals containing in the support DVD vary by models.

4.3 Software information

Most of the applications in the support DVD have wizards that will conveniently guide you through the installation. View the online help or readme file that came with the software application for more information.

4.4 AI Suite 3

AI Suite 3 is an all-in-one interface that integrates several ASUS utilities and allows you to launch and operate these utilities simultaneously.

Installing AI Suite 3



Ensure that you have an Administrator account before installing AI Suite 3 in Windows® 7, Windows® 8, Windows® 8.1, or Windows® 10 OS.

To install AI Suite 3 on your computer:

Windows® 7 OS

- Place the Support DVD into the optical drive.
- In the **AutoPlay** dialog box, click **Run ASSETUP.exe** then select the **Utilities** tab

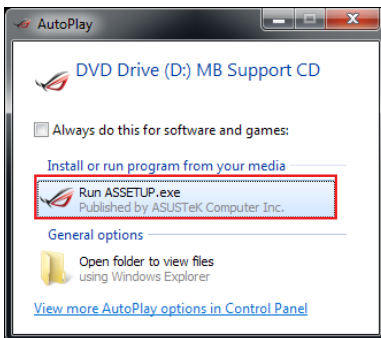

- From the **Utilities** tab, check **AI Suite 3** and select **Install**, then follow the succeeding onscreen instructions.

Windows® 8 / Windows® 8.1 / Windows® 10 OS

1. Place the Support DVD into the optical drive then follow onscreen instructions.
2. From the **ASUS motherboard support DVD** main menu, select the **Utilities** tab and check **AI Suite 3** and select **Install**.
3. Follow the succeeding onscreen instructions.

If the **ASUS motherboard support DVD** main menu did not appear, try the following steps:

- a. Go to the **Start Screen** then click the **Desktop** app.
- b. On the lower left corner of the Desktop, click **File Explorer**  then select your DVD drive and double-click the **Setup** application.

Launching AI Suite 3

Windows® 7 OS

From the Desktop, click **Start > All Programs > ASUS > AI Suite 3 > AI Suite 3**.

You can also launch AI Suite 3 in Windows® 7 by clicking  on the Notification area.

Windows® 8 / Windows® 8.1 / Windows® 10 OS

To launch AI Suite 3 in Windows® 8 or Windows® 10, tap the **AI Suite 3** app on the Start Screen (or if you're using a mouse, click the **AI Suite 3** app on the Start screen).

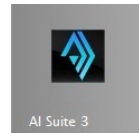

AI Suite 3 Main menu

The AI Suite 3 main menu gives you easy-access controls and insight to what's going on with your computer - allowing you to optimize performance settings while at the same time ensuring system stability.

The AI Suite main menu includes a quick-access menu bar that allows you to swiftly launch any of the integrated ASUS utilities. Click  on the left of the menu to launch the menu bar.



The AI Suite 3 screenshots in this section are for reference only and can vary depending on motherboard model.

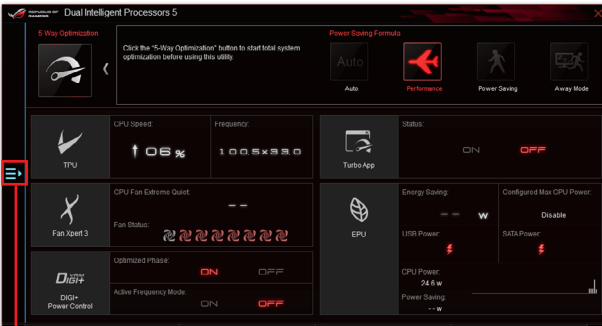

Click to launch AI Suite 3 menu bar

AI Suite 3 main menu bar

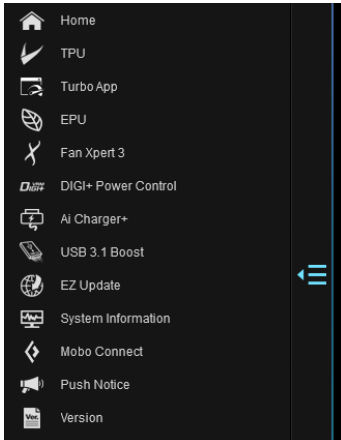

- Some functions in the AI Suite 3 main menu in this user guide may vary depending on the motherboard model.
- Refer to the software manual in the support DVD or visit the ASUS website at www.asus.com for detailed software configuration.

4.5 Dual Intelligent Processors 5

ASUS Dual Intelligent Processors 5 combines TPU, EPU, DIGI+ Power Control, Fan Xpert 3, and Turbo App functions to push the system's performance to its optimal potential. It automatically balances the system's performance, power saving, levels, and fan settings via the user-friendly AI Suite 3 utility.

5-Way Optimization

The 5-Way Optimization function dynamically optimizes your PC based on real-time usage to provide the best system status. It covers the essential areas such as CPU performance, energy saving, stable digital power, cool and quiet fan control, and includes tailored settings for your apps to ensure your PC is ready for gaming, entertainment, productivity, or just about anything.

Click this 5-Way Optimization button to auto-detect and tune the best settings for your system

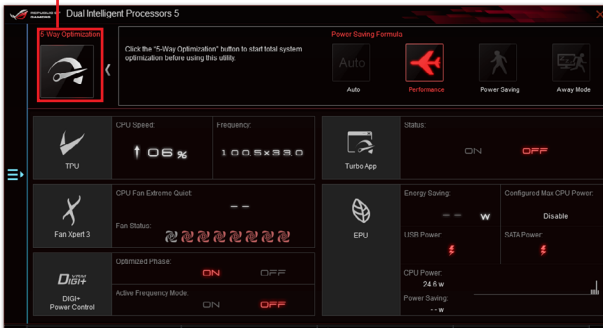

DO NOT remove your fan during the tuning process.

Turbo Processing Unit (TPU)

TPU allows you to manually adjust the CPU frequency, CPU cache, core frequencies, DRAM frequency, and related voltages for an enhanced system stability and a performance boost.



Refer to the CPU documentation before adjusting CPU voltage settings. Setting a high voltage may damage the CPU permanently, and setting a low voltage may lead to an unstable system.



For system stability, the TPU settings are not saved in the BIOS and are not loaded during system bootup. Save your overclocking settings as a TPU profile and manually load this profile after system bootup.

Using TPU

CPU Frequency

Click ◀ or ▶ to adjust the Base Clock Frequency, CPU Ratio, and CPU Cache Ratio

Click ◀ or ▶ to select the number of cores to adjust

Tick to enable Group Tuning



CPU Cache Voltage adjustments

Click to load the saved profile

CPU Core Voltage adjustments

Click to apply the adjustments

Click to save the adjustment into a profile

Click to undo the adjustments



- Set the CPU Ratio Setting item in BIOS to **[Auto]** before using the CPU Frequency in TPU. Refer to the **BIOS** chapter of your motherboard's user guide for details.
- The CPU Frequency bars show the status of the CPU cores, which vary with your CPU model.

GPU Boost

CPU Graphics Voltage Adjustments



Click to load the saved profile

Click to save the adjustment into a profile

Click to enable the default settings

Click to apply the adjustments

Click to undo the adjustments

Energy Processing Unit (EPU)

EPU is a real-time system power-saving chip that automatically detects the current system load and intelligently moderates power usage. It offers a total system-wide energy optimization, reduces fan noise, and extends the lifespan of your hardware components.

Using EPU

The screenshot shows the BIOS/UEFI interface for 'Dual Intelligent Processors 5'. The 'Auto' mode is selected. The interface includes sections for 'Voltage Downgrade' (None, High, Extreme), 'Enable Away Mode', 'Power Plan' (Monitor Off, Sleep), and 'Fan Profile' (Standard (ASUS)). Annotations with red lines point to various controls: 'Click to configure the settings in Auto mode' points to the 'Auto' tab; 'Click to configure the settings in High Performance mode' points to the 'Performance' tab; 'Click to configure the settings in Max Power Saving mode' points to the 'Power Saving' tab; 'Click to configure the settings in Away mode' points to the 'Away Mode' tab; 'Click to configure the Global settings' points to the 'Global Setting' tab; 'Tick to select a setting for Voltage Decrement' points to the 'None' radio button; 'Click to enable the default settings' points to the 'Default' button; 'Click to undo the adjustments' points to the 'Reset' button; 'Click to apply the adjustments' points to the 'Apply' button; 'Click < or > to adjust the Power Plan time' points to the sliders for 'Monitor Off' and 'Sleep'; and 'Click > to select a fan profile' points to the 'Fan Profile' dropdown menu.

Click to configure the settings in Auto mode

Click to configure the settings in High Performance mode

Click to configure the settings in Max Power Saving mode

Click to configure the settings in Away mode

Click to configure the Global settings

Tick to select a setting for Voltage Decrement

Click to enable the default settings

Click to undo the adjustments

Click to apply the adjustments

Click < or > to adjust the Power Plan time

Click > to select a fan profile

DIGI+ Power Control

ASUS DIGI+ Power Control features the revolutionary and innovative digital VRM and DRAM Voltage controllers. These controllers offers ultra-precise memory and voltage tuning for optimal system efficiency, stability and performance.



The following screens are for reference only. Configuration options varies depending on the motherboard model.

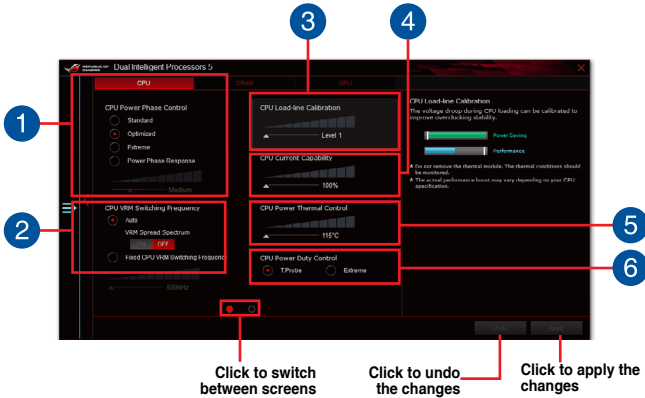

- 1 CPU Power Phase Control**
Increase the phase number under a heavy system load to get more transient and better thermal performance. Reduce the phase number under a light system load to increase the VRM efficiency.
- 2 CPU VRM Switching Frequency**
Enables spread spectrum to enhance system stability.
- 3 CPU Load-line Calibration**
It allows you to adjust the voltage range to control the CPU Load-line. Adjust to a high value for system performance or to a low value for power efficiency. **CPU**
- 4 CPU Current Capability**
CPU Current Capability provides a wider total power range for overclocking. A higher value brings a wider total power range and extends the overclocking frequency range simultaneously.
- 5 CPU Power Thermal Control**
A higher temperature brings a wider CPU power thermal range and extends the overclocking tolerance to enlarge the overclocking potential.
- 6 CPU Power Duty Control**
CPU Power Duty Control adjusts the current of every VRM phase and the thermal conditions of every phase component.

Fan Xpert 3

ASUS Fan Xpert 3 provides customizable settings of your fans for a cooler and more quiet computing environment. With its fan Auto Tuning feature, ASUS Fan Xpert 3 automatically tweaks the settings of CPU and chassis fans to achieve their best cooling performance. ASUS Fan Xpert 3 also supports hardware level PWM/DC combo mode for the CPU and chassis fans. You can also reduce the CPU fan speed below the default minimum for a noiseless operation during light loads.

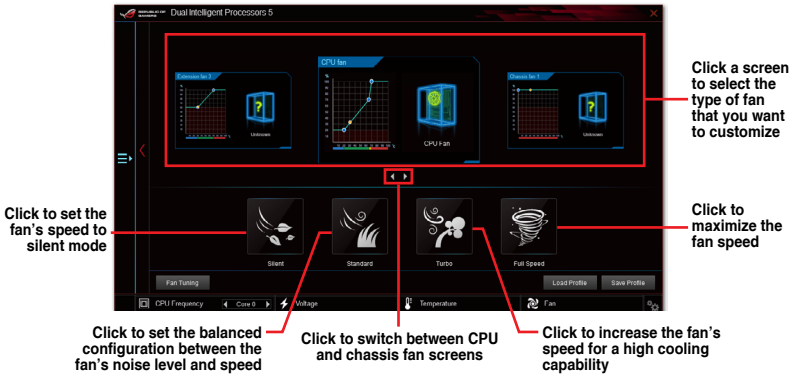

Turbo App

Turbo App allows you customize the system performance, network priority, and audio setting of an application.

When an application is on the Turbo App List, you can allocate the CPU frequency, assign a network priority, and define the audio setting of the selected application.

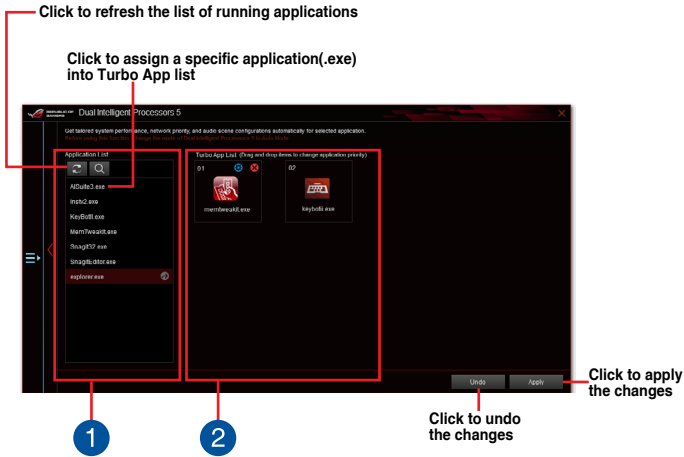

- 1 Applications list pane**
Displays all the running applications on your system.
- 2 Turbo App List pane**
Displays the applications added to the Turbo App List. Click the  icon for more settings.

* Only applications on the Turbo App List can be configured.

Ai Charger+

Ai Charger+ allows you to fast-charge your portable BC 1.1* mobile devices on your computer's USB port three times faster than the standard USB devices**.

Launching Ai Charger+

To launch Ai Charger+, click  on the left of the AI Suite 3 main menu, then select **Ai Charger+**.



Ai Charger+ is available only in selected motherboard models.

Ai Charger+ screen



- * Check the manufacturer if your USB device is a Battery Charging Specification 1.1 (BC 1.1) compliant or compatible device.
 - ** Actual charging speeds may vary depending on the charging rate and specifications of your USB device.
 - To ensure normal charging function, disconnect and reconnect your USB device every time you enable or disable Ai Charger+.
 - Ai Charger+ does not support USB hubs, USB extension cables, and generic USB cables.
-

USB 3.1 Boost

USB 3.0 Boost technology supports UASP (USB Attached SCSI Protocol) that automatically speeds up the transfer rates of your USB storage devices.

Launching USB 3.1 Boost

To launch USB 3.0 Boost, click  on the left of the AI Suite 3 main menu, then select **USB 3.1 Boost**.

Using the USB 3.1 Boost

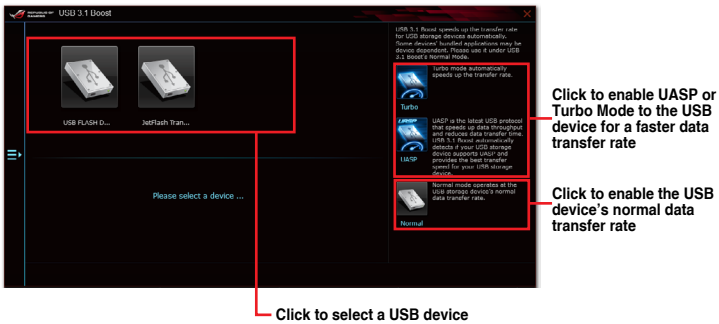

Ensure to connect your USB 3.0 or 3.1 device to the USB ports that support USB 3.1 Boost. Refer to the **Rear I/O connection** section of your user guide for more details.



- USB 3.1 Boost automatically detects the USB devices that support UASP. For a list of UASP-supported USB devices, visit the ASUS website at www.asus.com.
- The data transfer speed varies with USB devices. For a higher data transfer performance, use a USB 3.1 device.

EZ Update

EZ Update is a utility that allows you to automatically update your motherboard's software, drivers, or BIOS.

With this utility, you can also manually update the BIOS and select the boot logo that will display during POST.

Launching EZ Update

To launch EZ Update, click  on the left of the AI Suite 3 main menu, then click **EZ Update** on the AI Suite 3 main menu bar.

EZ Update screen

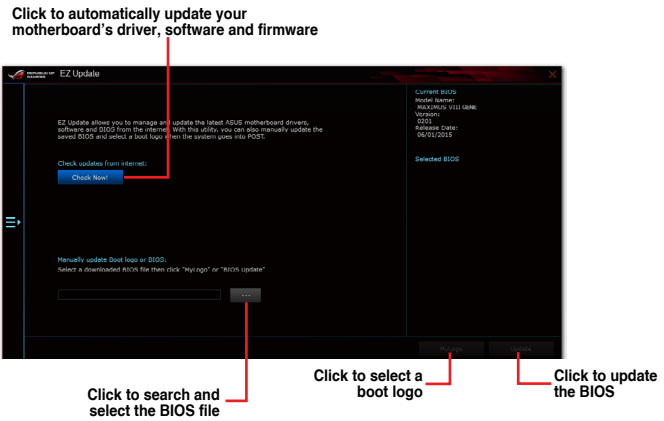

Viewing the SPD information

Click the **SPD** tab to view the memory's information.



Mobo Connect

Mobo Connect allows you to share the PC's keyboard/mouse for smart devices, or stream audio playback from your smart device to the PC.

Launching Mobo Connect

To launch Mobo Connect, click  on the left of the AI Suite 3 main menu, then select **Mobo Connect**.

Mobo Connect screen

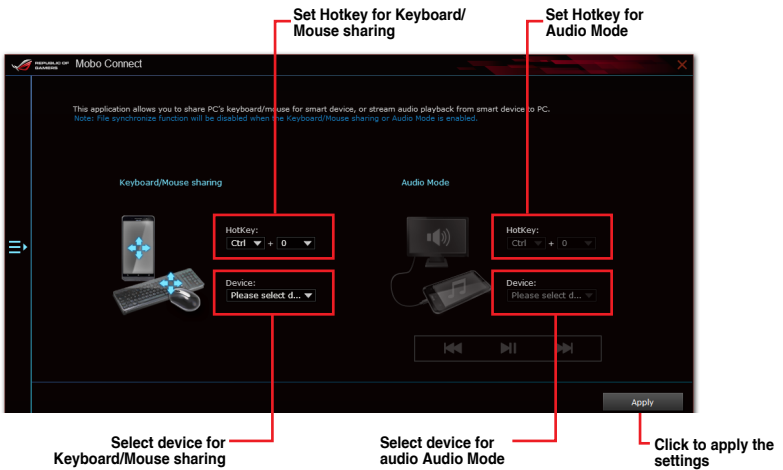

Push Notice

This utility allows you get the detailed status of your system to your smart device. You can also send messages to your smart device using this utility.





Before using this utility, ensure that you pair your computer with your smart device. For pairing information, refer to section **Pairing your computer and smart device**.

Launching Push Notice on your computer

To launch Push Notice, click  on the left of the AI Suite 3 main menu, then select **Push Notice**.

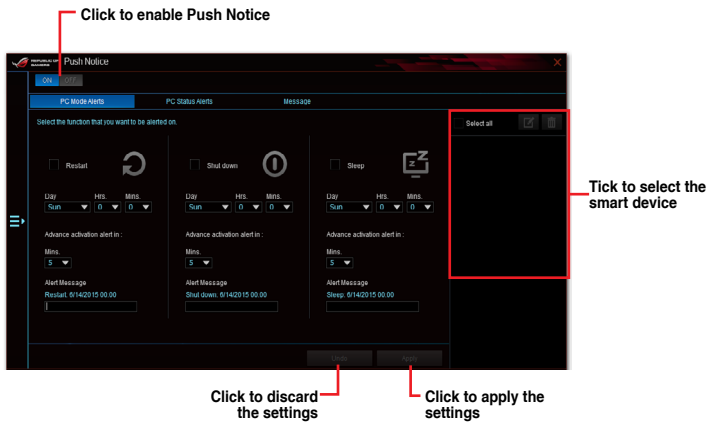
Push Notice screen



You can also enable the Push Notice via the Push Notice shortcut on the lower-right corner of your screen. To do this, click << then click  then select .

Pairing your computer and smart device

To pair your computer and smart device:

1. On your smart device, tap  to launch Push Notice.
2. Tap **Push Scan** then tap the name of your computer that you want to pair with.



To pair your computer and smart device, ensure that both are connected to the same wireless network.

Setting up PC Mode alerts of your computer

This feature allows you to restart, shut down, or put your computer to sleep mode and sends an alert to your smart device.

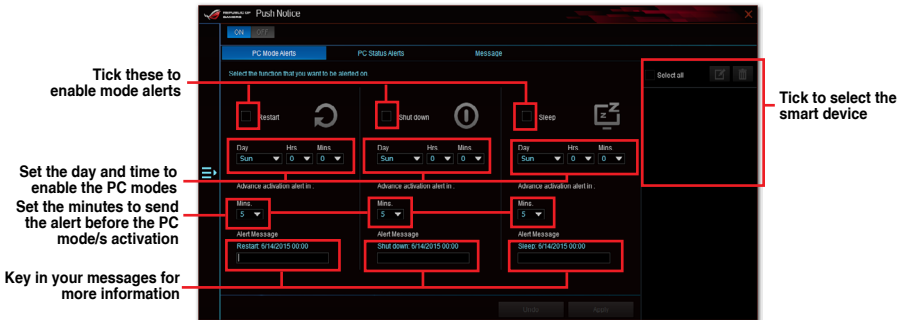

Setting up PC Status alerts

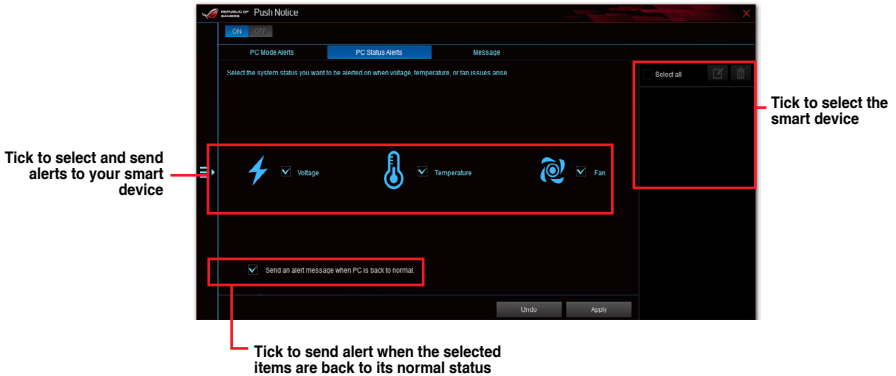

This feature allows you to send alerts of the unusual activities of the voltage, temperature, and fan settings of your computer to your smart device.



Sending messages to your smart device

This feature allows you to send messages to your smart device.



You can also send messages via the Push Notice messaging shortcut on the lower-right corner of your screen. To do this, click << then click  then select .

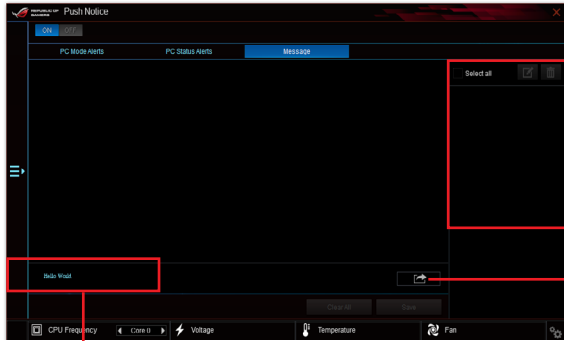

Tap to select the smart device

Click to send your message

Click to key in your message

Viewing your computer status on your smart device

Tap  on your smart device to launch Push Notice.

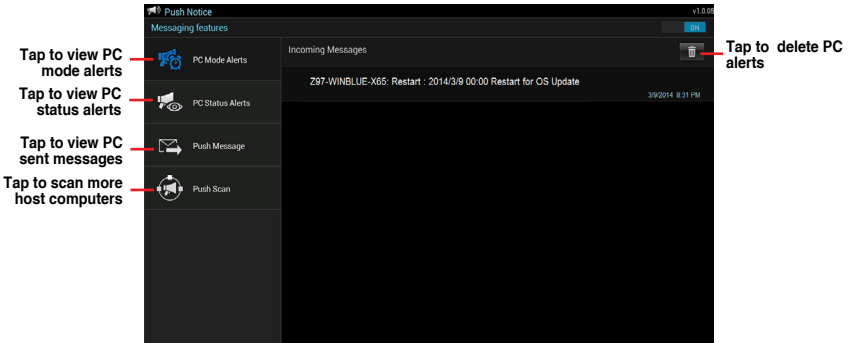

Tap to view PC mode alerts

Tap to view PC status alerts

Tap to view PC sent messages

Tap to scan more host computers

Tap to delete PC alerts

4.6 ROG Audio features

Installing the Software

Follow the installation wizard to install the Realtek® Audio Manager driver from the support DVD that is bundled with the motherboard.

If the Realtek® audio software is correctly installed, you will find the Realtek® HD Audio Manager icon on the taskbar. Double-click on the icon to display the Realtek® HD Audio Manager.



Realtek® HD Audio Manager

Sonic Studio II

Sonic Studio II is an audio suite that offers six audio controls: Reverb, Bass Boost, Equalizer, Voice Clarity, Smart EQ (Smart Volume), and Surround. Surround is dedicated for 2-channel headset and offers one of the best virtual surround technology for gaming.

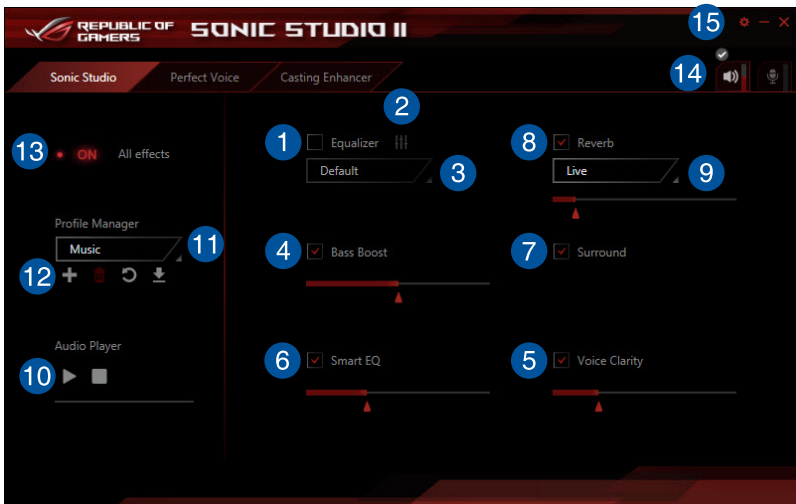

- 1 Equalizer**
Check this box to enable Equalizer. This item allows you to adjust the frequencies to suit your favorite type of music.
- 2 Equalizer advanced settings**
This item available only when the Equalizer is enabled. This item allows you to configure the Equalizer settings. You can manually set or customized your setting or choose from any of the preset equalizer settings available.
- 3 Equalizer presets**
Displays the current or selected equalizer preset.
- 4 Bass Boost**
Check this box to boosts the bass effects. Use the slider to adjust the sound of the bass effect.
- 5 Voice Clarity**
Check this box to enable Voice Clarity. Voice clarity extracts and boost the frequency of the human voice for crystal clear in-game communications and dialogues in movies.
- 6 Smart EQ**
Check this box to enable Smart EQ. This item automatically adjust the frequency of an audio content to maintain deep bass and crispy high frequencies.
- 7 Surround**
Check this box to enable Surround. This item recreates a multichannel listening experience over your stereo headphones or speakers.
- 8 Reverb**
Check this box to enable Reverb. This item increases the feeling if spaciousness and lets you choose other reverb presets.
- 9 Reverb presets**
Click to select a reverb effect from the different environmental spaces for reverb effects.

This item is only available when the Reverb switch is enabled.
- 10 Test tone**
Click the play button to start the test for the selected preset profile.
- 11 Preset profiles**
Click any of the preset profiles. Choose from Gaming, Music, or Movie.
- 12 Profile Register, Open, or Reset**
Allows you to Register, Open, or Reset to the default setting of a profile.
- 13 Sonic Studio switch**
Click to toggle the Sonic Studio function ON/OFF.
- 14 Volume**
Allows you to adjust the volume of the connected devices.
- 15 Sonic Studio settings**
Click this button to change the language or view the tutorial.

Perfect Voice

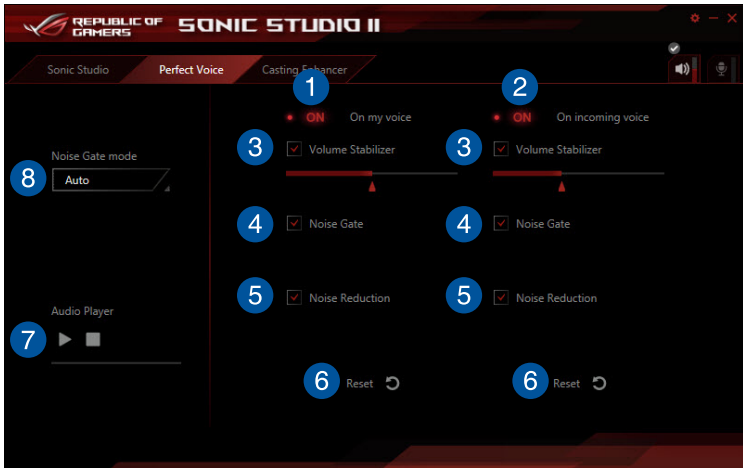

- 1 On my voice switch**
Click to toggle Perfect Voice on my voice ON/OFF.
- 2 On incoming voice switch**
Click to toggle Perfect Voice on incoming voice ON/OFF
- 3 Volume Stabilizer**
Check this box to enable Volume Stabilizer on your voice or on incoming voice. Use the slider to adjust the MIC volume.
- 4 Noise Gate**
Check this box to enable Noise Gate. This item removes the background noise between words and sentences on your voice or on incoming voice.
- 5 Noise Reduction**
Check this box to enable Noise Reduction. This item removes the remaining voice on top of your voice or your friend's voice.
- 6 Reset**
Click this button to reset the settings on your voice or on incoming voice to the default settings.
- 7 Test tone**
Click the play button to start the test for the selected preset profile.
- 8 Noise Gate mode**
Click to choose the Noise Gate mode from Auto or Manual. Manual mode allows you to use the slider to adjust the Noise Gate and Noise Reduction.

Casting Enhancer

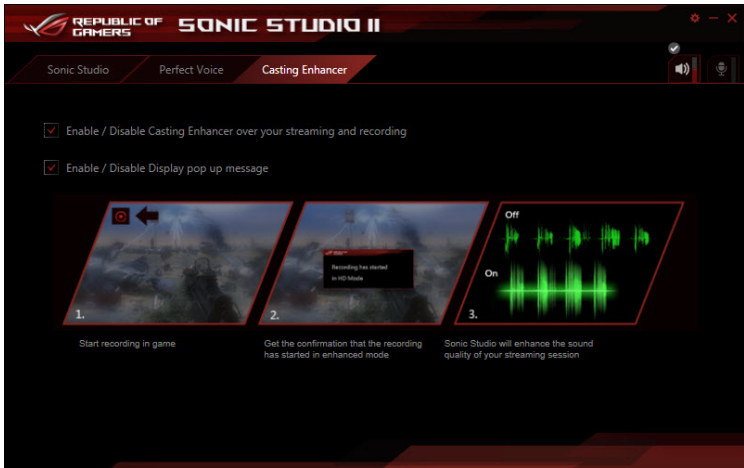

Sonic SenseAmp

Sonic SenseAmp is an exclusive ROG invention that is a built-in headphone AMP on onboard audio with three AMP levels adjustment. It detects your headphone's impedance and adjusts the built-in AMP accordingly.



Sonic SenseAmp only works on front panel.

When you plug a headphone into the front headphone jack, Sonic SenseAmp displays a pop-up window that displays “Detecting headphone impedance”.

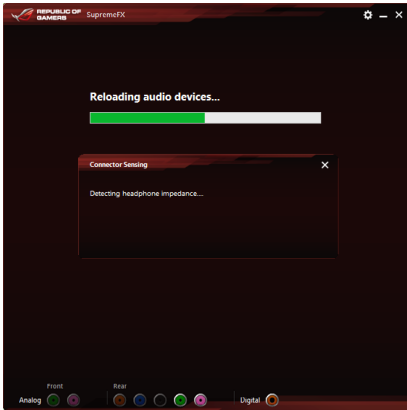

After detecting the headphone's impedance, Sonic SenseAmp displays another pop-up window similar to the one shown below.

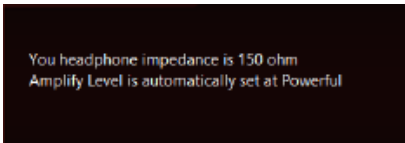

Refer to the table below on the behavior of Sonic SenseAmp when adjusting the impedance of the detected headphone:

32 ohm	Amplify Level is automatically set at Performance
150 ohms	Amplify Level is automatically set at Powerful
> 150 ohms	Amplify Level is automatically set at Extreme
Other device	The device plugged in detected as other device

After you close the pop-window, Sonic SenseAmp enters speaker configuration and displays the adjusted headphone impedance.

Click to manually adjust the amplify level
Displays the impedance of your headphone

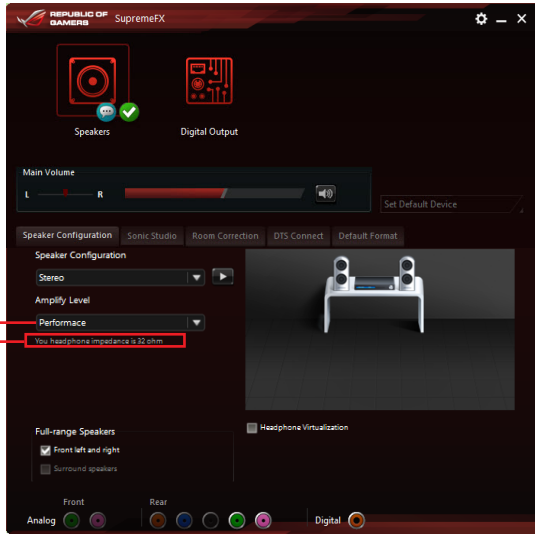

DTS Connect

DTS Connect delivers excellent audio entertainment across all formats and works with 4, 5, 1 and 7.1 channels of incredible surround sound . It also allows you to connect your PC to a home theatre system.

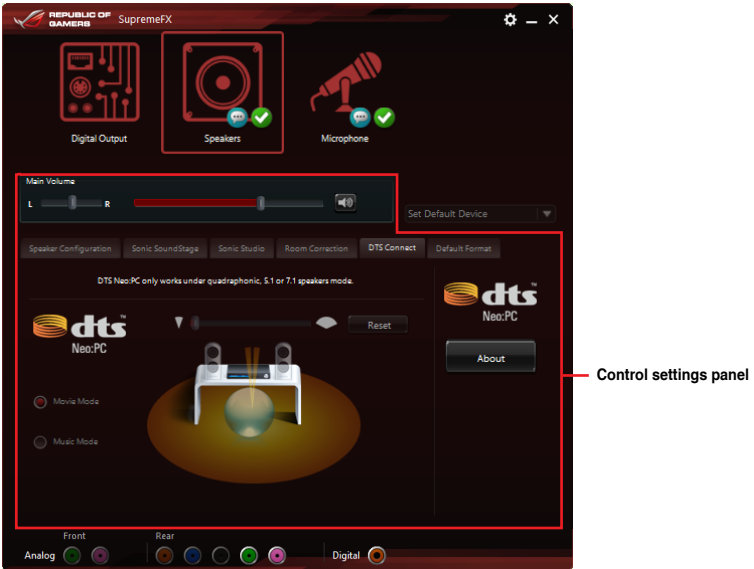

4.7 Sonic Radar II

Sonic Radar II is designed for First Person Shooting (FPS) games and shows the precise direction and intensity of where a sound is coming from. It features a simple and friendly user-interface and also features sound enhancers to amplify desired sound effects.

Display Menu

Customize the settings for each game including Transparency, Signal, Size, and Remanency.

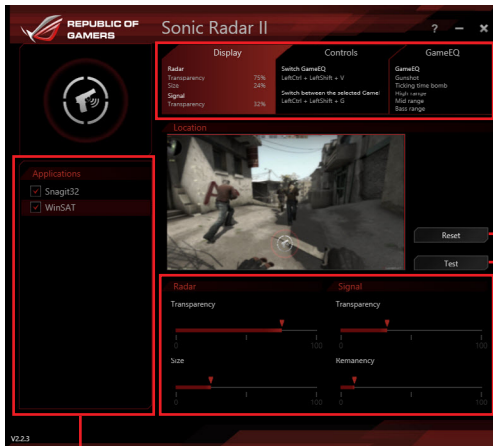

Displays the options available. Click a tab to select an option. Each option has its own settings and menus.

Click to reset to the default settings

Click to start the test tone

Use the sliders to adjust the settings

Displays the list of games

Control Menu

Allows you to configure shortcut keys.



Audio Mode/Radar Selection menu

Allows you to configure the sound enhancers.



Tick to choose the desired sound enhancer



Audio Mode/Radar Selection are enabled with shortcut keys in the game. Refer to the **Controls** tab for more information about the shortcut key settings.

4.8 GameFirst III

GameFirst III is a network management software that features four preset packet prioritized profiles (Optimization, Game, Media Streaming and File Sharing) facilitating different user scenarios. Users can also manually allocate bandwidth and adjust priority settings of each application to run faster and smoother.

To use GameFirst III, double-click  on the desktop.



The screenshot shows the GameFirst III interface with the following callouts and instructions:

- Click to open the tabs for different functions**: Points to the top navigation tabs: Application, Network Monitor, Bandwidth Test, and Network Information.
- Click any item for quick view**: Points to the 'Application' tab.
- Click to load a preset priority profile and configure its settings**: Points to the 'Select priority profile mode' sidebar, which includes Optimization (1), Game (2), Media Streaming (3), and File Sharing (4).
- Use the bar to adjust the bandwidth speed settings or key in the value of the input field**: Points to the bandwidth control bars for each application in the 'Optimization Mode' table.
- Tick to toggle the preset priority profile function on/off**: Points to the 'Function switch' at the bottom left, which has 'ON' and 'OFF' options.
- Tick to display all the applications.**: Points to the 'Show all applications' checkbox.
- Click to reset and load the default settings of the selected profile**: Points to the 'Reset' button at the bottom right.
- Allows you to block traffic of the application or set priority**: Points to the priority dropdown menu for each application.

- 1 **Optimization Mode**
Game packets are prioritized and other packets also optimized.
- 2 **Game Mode**
Game packets given top priority.
- 3 **Media Streaming Mode**
Media-streaming packets given top priority.
- 4 **File Sharing Mode**
File-sharing packets given top priority.

Network Monitor

Top 5 application

Displays the top 5 bandwidth consuming applications currently used.

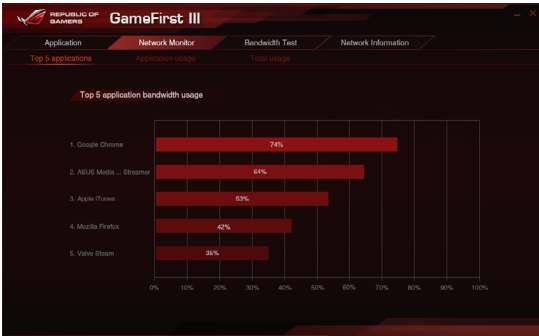

Application usage

Displays the individual downloading and uploading bandwidth of currently used applications.

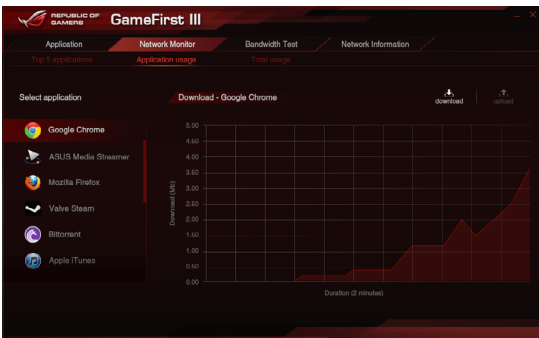

Total usage

Displays the total downloading and uploading bandwidth of the currently used applications.

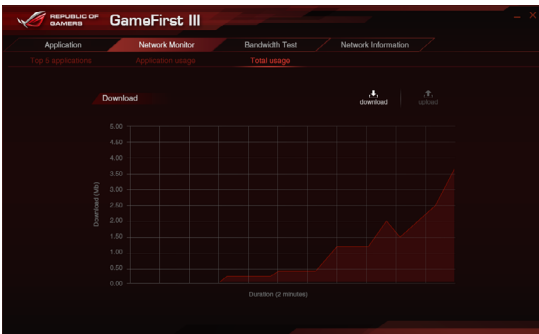

4.9 KeyBot II

KeyBot II is a built-in microprocessor that provides instant upgrade to your keyboard. You can configure and assign macros to specific keys on your keyboard to perform specific or several tasks at the same time. You can also configure your PC for overclocking, or enter BIOS directly.

1. Connect the USB keyboard into the dedicated KeyBot USB port.



Refer to the **Rear I/O connection** section for more information about the location of the KeyBot USB port.

2. Double-click  on the desktop to launch the KeyBot II application on your PC.

Click to load or save configuration files

Click to configure Macro Keys, Smart Input, Function Keys, and Shortcut settings

Click to toggle the KeyBot II function on/off

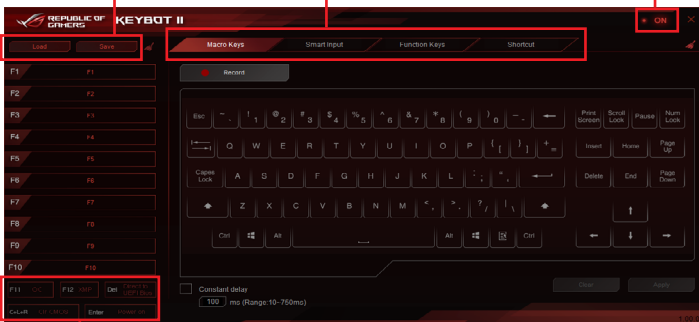

Click any of the items to perform a specific task, or click their corresponding keys on the keyboard

Smart Input

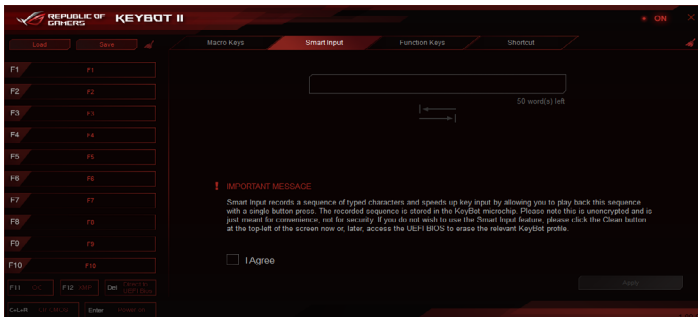

Function Keys



Shortcut

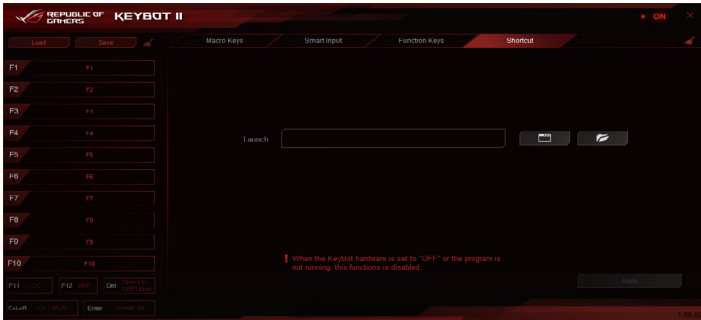

4.10 ASUS Media Streamer

ASUS Media Streamer allows you to enjoy your PC's multimedia content anywhere. You can pipe music from your PC or stream your favorite movie to a smart TV using your PC or smart device.



- Ensure to enable the DLNA setting of your devices first.
- ASUS Media Streamer supports NFC function.



- Ensure to install ASUS HomeCloud on your PC.
- An Internet connection is required to fully utilize this feature.

To use ASUS Media Streamer:

On your computer, click **ASUS HomeCloud** then select **Media Streamer**. On your device, click **Media Streamer**.

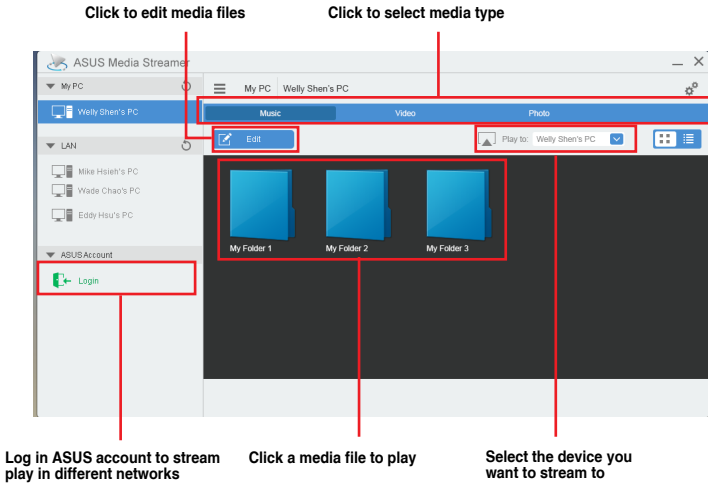

Adding and deleting media files

Drag and drop or tick files to add or delete.



The following media formats are supported: .3gp, .mp4, .m4a, .aac, .ts, .flac, .mp3, .mid, .xmf, .mxmf, .rtttl, .rtx, .ota, .imy, .ogg, .mkv, .wav, .jpg, .gif, .png, .bmp, .webp, .webm

4.11 RAMDisk

RAMDisk is a data-storage software that reserves a part of your system's memory and turns it into a high-speed virtual drive where you can store cache files and game apps for instant access. The Dynamic Memory Allocation function can release the unused memory of RAMDisk back to the system when needed and helps extend the lifespan of your SSD or HDD.



The following folders are not suitable for RAMDisk optimization. Moving them into the RAMDisk might negatively affect the performance of your system.

- **Swap file/Page file:** The swap file is a permanent storage space used as the virtual memory expansion of the system memory. Moving the swap file into the RAM Disk simply defeats the whole purpose of having it and may affect your system's performance.
- **Startup folders:** Since RAMDisk loads during boot up together with the contents of the Junction folders, changing the location of the startup folders may cause system error and disable loading your RAMDisk.



To launch RAMDisk, click .

Creating/Deleting a RAMDisk drive

Your RAMDisk drive allows you to place your favorite applications and files into RAM so you can utilize your RAM speed for better read/write performance. The files that are stored inside the RAMDisk are automatically backed up every time your PC is turned off.



The startup time may take a while, depending on the size of your RAMDisk drive.

To create RAMDisk drives:

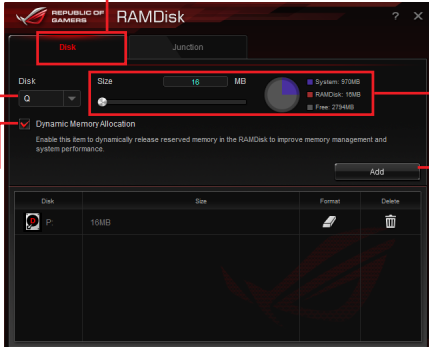

The screenshot shows the RAMDisk application window. The title bar reads "REPUBLIC OF GAMERS RAMDisk". The interface has two tabs: "Disk" and "Junction". The "Disk" tab is active, showing a "Disk" dropdown menu set to "G:", a "Size" slider set to "16 MB", and a pie chart showing memory usage: System (570MB), RAMDisk (10MB), and Free (2794MB). Below the slider, there is a checked checkbox for "Dynamic Memory Allocation" with a sub-note: "Enables this item to dynamically release reserved memory in the RAMDisk to improve memory management and system performance." At the bottom right, there is an "Add" button. Below the main interface is a table with columns: Disk, Size, Format, and Delete.

Disk	Size	Format	Delete
P:	10MB		

Annotations with arrows pointing to the interface:

- Click to create RAMDisk drives (points to the "Disk" tab)
- Click the drop-down arrow to choose a drive name for your RAMDisk (points to the "G:" dropdown)
- Move the slider to the right to set the size allocation (points to the "16 MB" slider)
- Click to finish creating the RAMDisk drive (points to the "Add" button)
- Tick to enable Dynamic Memory Allocation function (points to the checked checkbox)

To delete or format an existing RAMDisk drive:

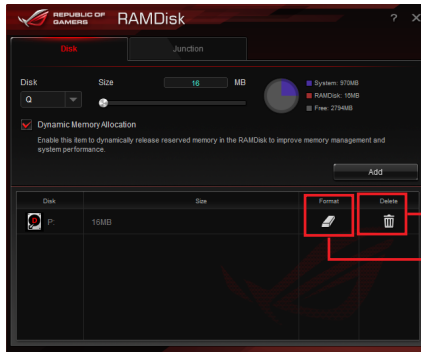

Click to delete the existing RAMDisk drive

Click to format the existing RAMDisk drive



The format function is available only if you enable the Dynamic Memory Allocation function on your disk.

Creating/Deleting a Junction Point

A junction point creates a link that remaps the original contents into the RAMDisk, enabling access to the desired application or data to be done purely within the original file location.

Select the Junction tab to create your junction point

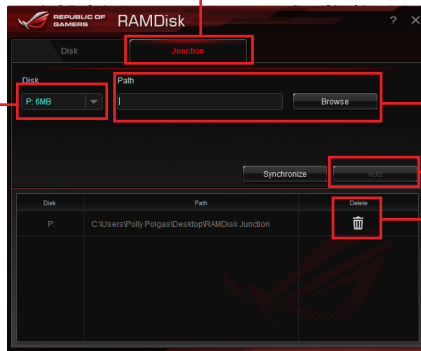

Click the drop-down arrow to select your RAMDisk drive and its available storage space.

Click to select where to create a junction point.

Click to finish adding the new junction point.

Click to delete the existing junction point.

Synchronizing backup files

After creating a junction point, RAMDisk automatically creates a backup folder in the file's original location. Use RAMDisk to manually synchronize updates with these backup files.

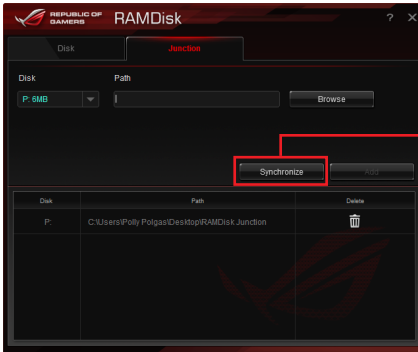

Click Synchronize to update your files

4.12 MemTweakt

MemTweakt is a software that you can use to view all levels of memory timings. You can validate your MemTweakt settings to generate a memory efficiency score that you can share and compare with other users on the ROG website.



MemTweakt functions depends on the chipset on the motherboard. Each chipset has different options.

To use MemTweakt, double-click  on the desktop.

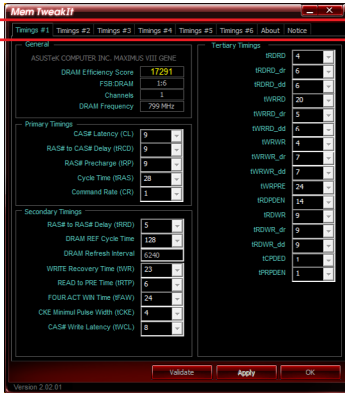

Click a tab to configure the memory timing



Click About tab then click REPUBLIC OF GAMERS to access the official ROG website

Click to exit MemTweakt
Click to apply your settings
Click to validate your settings.

Validating and saving your MemTweakIt settings

To validate and save your configuration online:

1. Launch MemTweakIt and click **Validate**.
2. In **Online Mode**, key in your ASUS account ID and password, and click **Submit**.



Your configuration will be displayed in MemTweakIt webpage.

To validate and save your configuration manually:

1. Launch MemTweakIt and click **Validate**.
2. In **Manual Mode**, click **Save Validation File**.
3. Key in a file name for your configuration file and click **Submit**.
4. Click **validation webpage**.

Validation

Online Mode

Login via your ASUS Member ID (Email) to validate your score !

Account

Password

Submit

Forgot your password?
If you are not an ASUS Member, please [register here](#).
What is an [ASUS Member ID?](#)

Manual Mode

Step #1 : Save your current settings as a validation file on your hard drive (use the button below).

Save Validation File

Step #2 : Submit your validation file on the [validation web page](#).
If the validation succeeds, you will get an ID.

OK

5. In **MemTweakIt - Validation File Upload** window, key in your ASUS account ID and password.
6. Click **Browse**, locate the saved .cvf file, and click **Open**.
7. Click **Submit**.

MemTweakIt - Validation File Upload

Login via your ASUS Member ID and submit the .cvf file generated by Mem TweakIt to verify and validate your score.

MemTweakIt! Submit Form™
ASUS Member Login (Email) :

Password :

MemTweakIt! Validation File (.cvf) : Browse...

Submit

ASUS MemTweakIt! Member - Copyright 2011-2012 © ASUS Corp Inc.



Your configuration will be displayed in MemTweakIt webpage.

4.13 ROG CPU-Z

This utility gathers information about the main devices installed in your system and displays it in an ROG custom layout. ROG CPU-Z provides you information and status of your CPU, motherboard, memory, graphics card, and other components installed in your system. You can generate a report about your system info and send or post it on the CPU-Z website.

To use ROG CPU-Z, double-click  on the desktop.

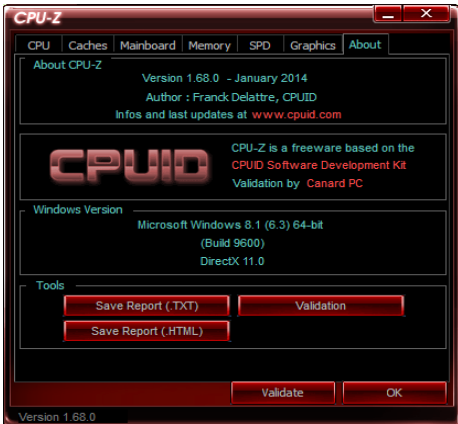
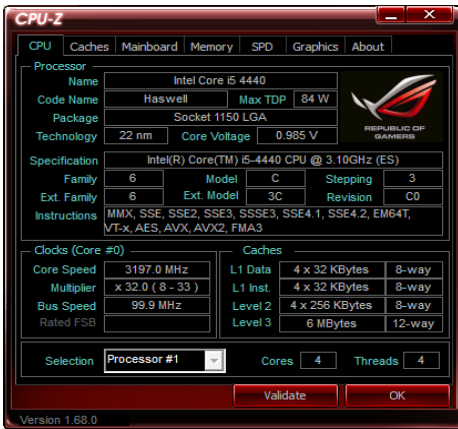

4.14 RAMCache

ROG RAMCache software provides a user-friendly and transparent solution to increase your PC overall performance, by utilizing the system memory (DRAM) that is not in use. RAMCache allocates a cache of RAM between the computer hard disk and the applications, then reads in real time your performance needs regarding the applications you are currently using and the disk I/O demands. RAMCache copies the most frequently used data from the disk to the RAM cache where it can be processed faster, and then automatically writes it back to the disk – thus accelerating the computer overall performance with a minimized risk of data loss.

To use RAMCache, double-click  on the desktop.

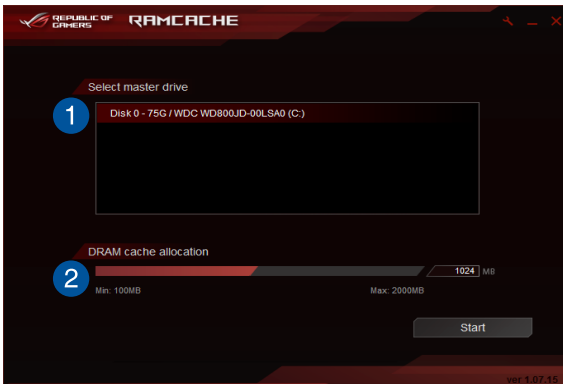

To start RAMCache:

1. Launch RAMCache and select disk or partition to cache.
2. Select cache size and then click **Start**.



- You can only cache one partition at a time.
- Min and Max amounts of RAM at disposal is automatically updated.

RAID Support

5

5.1 RAID configurations

The motherboard comes with the Intel® Rapid Storage Technology that supports RAID 0, RAID 1, RAID 10 and RAID 5 configuration.



If you want to install a Windows® operating system to a hard disk drive included in a RAID set, you have to create a RAID driver disk and load the RAID driver during OS installation. Refer to section 5.2 **Creating a RAID driver disk** for details.

5.1.1 RAID definitions

RAID 0 (Data striping) optimizes two identical hard disk drives to read and write data in parallel, interleaved stacks. Two hard disks perform the same work as a single drive but at a sustained data transfer rate, double that of a single disk alone, thus improving data access and storage. Use of two new identical hard disk drives is required for this setup.

RAID 1 (Data mirroring) copies and maintains an identical image of data from one drive to a second drive. If one drive fails, the disk array management software directs all applications to the surviving drive as it contains a complete copy of the data in the other drive. This RAID configuration provides data protection and increases fault tolerance to the entire system. Use two new drives or use an existing drive and a new drive for this setup. The new drive must be of the same size or larger than the existing drive.

RAID 5 stripes both data and parity information across three or more hard disk drives. Among the advantages of RAID 5 configuration include better HDD performance, fault tolerance, and higher storage capacity. The RAID 5 configuration is best suited for transaction processing, relational database applications, enterprise resource planning, and other business systems. Use a minimum of three identical hard disk drives for this setup.

RAID 10 is data striping and data mirroring combined without parity (redundancy data) having to be calculated and written. With the RAID 10 configuration you get all the benefits of both RAID 0 and RAID 1 configurations. Use four new hard disk drives or use an existing drive and three new drives for this setup.

5.1.2 Installing Serial ATA hard disks

The motherboard supports Serial ATA hard disk drives. For optimal performance, install identical drives of the same model and capacity when creating a disk array.

To install the SATA hard disks for a RAID configuration:

1. Install the SATA hard disks into the drive bays.
2. Connect the SATA signal cables.
3. Connect a SATA power cable to the power connector on each drive.

5.1.3 Setting the RAID item in BIOS

You must enable the RAID function in the BIOS Setup before creating RAID sets using SATA HDDs. To do this:

1. Enter the BIOS Setup during POST.
2. Go to the **Advanced** menu > **SATA Configuration**, and then press <Enter>.
3. Set the SATA Mode item to [RAID Mode].
4. Save your changes, and then exit the BIOS Setup.



Refer to Chapter 3 for details on entering and navigating through the BIOS Setup



Due to chipset limitation, when SATA ports are set to RAID mode, all SATA ports run at RAID mode together.

5.1.4 Intel® Rapid Storage Technology Option ROM utility

To enter the Intel® Rapid Storage Technology Option ROM utility:

1. Turn on the system.
2. During POST, press <Ctrl> + <I> to display the utility main menu.

```

Intel(R) Rapid Storage Technology - Option ROM - v10.5.1.1070
Copyright(C) 2003-10 Intel Corporation. All Rights Reserved.

[ MAIN MENU ]
1. Create RAID Volume      4. Recovery Volume Options
2. Delete RAID Volume     5. Acceleration Options
3. Reset Disks to Non-RAID 6. Exit

[ DISK/VOLUME INFORMATION ]

RAID Volumes:
None defined.

Physical Devices:
Port Device Model      Serial #              Size  Type/Status (Vol ID)
0  ST3160812AS         9LS0BJA4             149.0GB Non-RAID Disk
1  ST3160812AS         9LS0F4HL             149.0GB Non-RAID Disk
2  ST3160812AS         3LS0JYL8             149.0GB Non-RAID Disk
3  ST3160812AS         9LS0BJ5H             149.0GB Non-RAID Disk

[↑↓]-Select      [ESC]-Exit      [ENTER]-Select Menu

```

The navigation keys at the bottom of the screen allow you to move through the menus and select the menu options.



The RAID BIOS setup screens shown in this section are for reference only and may not exactly match the items on your screen.



The utility supports maximum four hard disk drives for RAID configuration.

Creating a RAID set

To create a RAID set:

1. From the utility main menu, select **1. Create RAID Volume** and press <Enter>. The following screen appears:

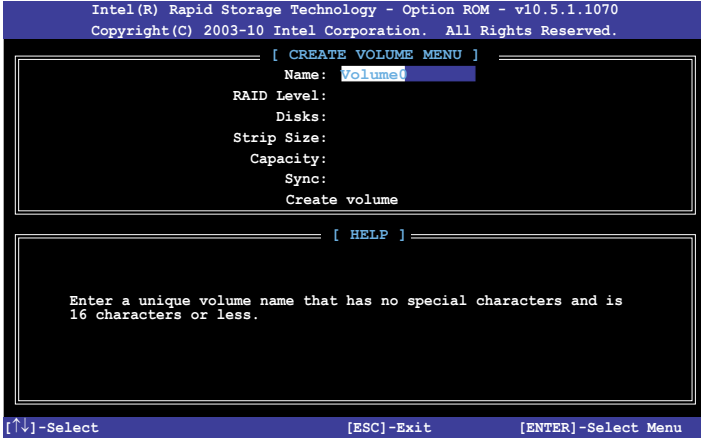

2. Enter a name for the RAID set and press <Enter>.
3. When the RAID Level item is selected, press the up/down arrow key to select a RAID level to create, and then press <Enter>.
4. When the Disks item is selected, press <Enter> to select the hard disk drives you want to include in the RAID set. The SELECT DISKS screen appears:

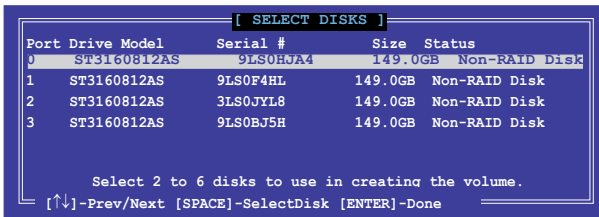

5. Use the Up/Down arrow key to select a drive, and then press <Space> to select. A small triangle marks the selected drive. Press <Enter> after completing your selection.
6. Use the Up/Down arrow key to select the stripe size for the RAID array (for RAID 0, 10 and 5 only), and then press <Enter>. The available stripe size values range from 4KB to 128KB. The following are typical values:
 - RAID 0: 128KB
 - RAID 10: 64KB
 - RAID 5: 64KB



We recommend a lower stripe size for server systems, and a higher stripe size for multimedia computer systems used mainly for audio and video editing.

7. When the **Capacity** item is selected, enter the RAID volume capacity that you want and press <Enter>. The default value indicates the maximum allowed capacity.
8. When the **Create Volume** item is selected, press <Enter>. The following warning message appears:

WARNING: ALL DATA ON SELECTED DISKS WILL BE LOST
Are you sure you want to create this volume? (Y/N) :

9. Press <Y> to create the RAID volume and return to the main menu, or <N> to go back to the CREATE VOLUME menu.

Deleting a RAID set



Be cautious when deleting a RAID set. You will lose all data on the hard disk drives when you delete a RAID set.

To delete a RAID set:

1. From the utility main menu, select **2. Delete RAID Volume** and press <Enter>. The following screen appears:

```
[ DELETE VOLUME MENU ]
Name      Level      Drives  Capacity  Status  Bootable
Volume0   RAID0 (Stripe)  2       298.0GB  Normal  Yes

[ HELP ]

Deleting a volume will reset the disks to non-RAID.

WARNING: ALL DISK DATA WILL BE DELETED.
        (This does not apply to Recovery volumes)

[↑↓]-Select      [ESC]-Previous Menu  [DEL]-Delete Volume
```

2. Use the Up/Down arrow key to select the RAID set you want to delete, and then press . The following warning message appears:

```
[ DELETE VOLUME VERIFICATION ]

ALL DATA IN THE VOLUME WILL BE LOST!
(This does not apply to Recovery volumes)

Are you sure you want to delete volume "Volume0"? (Y/N):
```

3. Press <Y> to delete the RAID set and return to the utility main menu, or press <N> to return to the DELETE VOLUME menu.

Exiting the Intel® Rapid Storage Technology Option ROM utility

To exit the utility:

1. From the utility main menu, select **5. Exit**, and then press <Enter>. The following warning message appears:

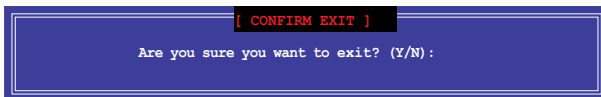

5.2 Creating a RAID driver disk

A floppy disk with the RAID driver is required when installing a Windows® operating system on a hard disk drive that is included in a RAID set.



The motherboard does not provide a floppy drive connector. You have to use a USB floppy disk drive when creating a SATA RAID driver disk.

5.2.1 Creating a RAID driver disk without entering the OS

To create a RAID driver disk without entering the OS:

1. Boot your computer.
2. Press during POST to enter the BIOS setup utility.
3. Set the optical drive as the primary boot device.
4. Insert the support DVD into the optical drive.
5. Save changes and exit BIOS.
6. When the Make Disk menu appears, press <1> to create a RAID driver disk.
7. Insert a formatted floppy disk into the USB floppy disk drive, then press <Enter>.
8. Follow the succeeding screen instructions to complete the process.

5.2.2 Creating a RAID driver disk in Windows®

To create a RAID driver disk in Windows®:

1. Start Windows®.
2. Plug the USB floppy disk drive and insert a floppy disk.
3. Place the motherboard support DVD into the optical drive.
4. Go to the **Make Disk** menu, and then click **Intel AHC/RAID Driver Disk** to create a RAID driver disk.
5. Select **USB floppy disk drive** as the destination disk.
6. Follow the succeeding screen instructions to complete the process.



Write-protect the floppy disk to avoid a computer virus infection.

5.2.3 Installing the RAID driver during Windows® OS installation

To install the RAID driver for Windows® 7 or later OS:

1. During the OS installation, click **Load Driver** to allow you to select the installation media containing the RAID driver.
2. Insert the USB flash drive with RAID driver into the USB port or the support DVD into the optical drive, and then click **Browse**.
3. Click the name of the device you've inserted, go to **Drivers > RAID**, and then select the RAID driver for the corresponding OS version. Click **OK**.
4. Follow the succeeding screen instructions to complete the installation.



Before loading the RAID driver from a USB flash drive, you have to use another computer to copy the RAID driver from the support DVD to the USB flash drive.

Appendix

Notices

Federal Communications Commission Statement

This device complies with Part 15 of the FCC Rules. Operation is subject to the following two conditions:

- This device may not cause harmful interference.
- This device must accept any interference received including interference that may cause undesired operation.

This equipment has been tested and found to comply with the limits for a Class B digital device, pursuant to Part 15 of the FCC Rules. These limits are designed to provide reasonable protection against harmful interference in a residential installation. This equipment generates, uses and can radiate radio frequency energy and, if not installed and used in accordance with manufacturer's instructions, may cause harmful interference to radio communications. However, there is no guarantee that interference will not occur in a particular installation. If this equipment does cause harmful interference to radio or television reception, which can be determined by turning the equipment off and on, the user is encouraged to try to correct the interference by one or more of the following measures:

- Reorient or relocate the receiving antenna.
- Increase the separation between the equipment and receiver.
- Connect the equipment to an outlet on a circuit different from that to which the receiver is connected.
- Consult the dealer or an experienced radio/TV technician for help.



The use of shielded cables for connection of the monitor to the graphics card is required to assure compliance with FCC regulations. Changes or modifications to this unit not expressly approved by the party responsible for compliance could void the user's authority to operate this equipment.

IC: Canadian Compliance Statement

Complies with the Canadian ICES-003 Class B specifications. This device complies with RSS 210 of Industry Canada. This Class B device meets all the requirements of the Canadian interference-causing equipment regulations.

This device complies with Industry Canada license exempt RSS standard(s). Operation is subject to the following two conditions: (1) this device may not cause interference, and (2) this device must accept any interference, including interference that may cause undesired operation of the device.

Cet appareil numérique de la Classe B est conforme à la norme NMB-003 du Canada. Cet appareil numérique de la Classe B respecte toutes les exigences du Règlement sur le matériel brouilleur du Canada.

Cet appareil est conforme aux normes CNR exemptes de licence d'Industrie Canada. Le fonctionnement est soumis aux deux conditions suivantes :

- (1) cet appareil ne doit pas provoquer d'interférences et
- (2) cet appareil doit accepter toute interférence, y compris celles susceptibles de provoquer un fonctionnement non souhaité de l'appareil.

Canadian Department of Communications Statement

This digital apparatus does not exceed the Class B limits for radio noise emissions from digital apparatus set out in the Radio Interference Regulations of the Canadian Department of Communications.

This class B digital apparatus complies with Canadian ICES-003.

VCCI: Japan Compliance Statement

Class B ITE

この装置は、クラスB情報技術装置です。この装置は、家庭環境で使用することを目的としていますが、この装置がラジオやテレビジョン受信機に近接して使用されると、受信障害を引き起こすことがあります。

取扱説明書に従って正しい取り扱いをして下さい。

VCCI-B

KC: Korea Warning Statement

B급 기기 (가정용 방송통신기자재)

이 기기는 가정용(B급) 전자파적합기기로서 주로 가정에서 사용하는 것을 목적으로 하며, 모든 지역에서 사용할 수 있습니다.

REACH

Complying with the REACH (Registration, Evaluation, Authorisation, and Restriction of Chemicals) regulatory framework, we published the chemical substances in our products at ASUS REACH website at <http://csr.asus.com/english/REACH.htm>.



DO NOT throw the motherboard in municipal waste. This product has been designed to enable proper reuse of parts and recycling. This symbol of the crossed out wheeled bin indicates that the product (electrical and electronic equipment) should not be placed in municipal waste. Check local regulations for disposal of electronic products.



DO NOT throw the mercury-containing button cell battery in municipal waste. This symbol of the crossed out wheeled bin indicates that the battery should not be placed in municipal waste.

ASUS Recycling/Takeback Services

ASUS recycling and takeback programs come from our commitment to the highest standards for protecting our environment. We believe in providing solutions for you to be able to responsibly recycle our products, batteries, other components as well as the packaging materials. Please go to <http://csr.asus.com/english/Takeback.htm> for detailed recycling information in different regions.

Google™ License Terms

Copyright© 2015 Google Inc. All Rights Reserved.

Licensed under the Apache License, Version 2.0 (the "License"); you may not use this file except in compliance with the License. You may obtain a copy of the License at:

<http://www.apache.org/licenses/LICENSE-2.0>

Unless required by applicable law or agreed to in writing, software distributed under the License is distributed on an "AS IS" BASIS, WITHOUT WARRANTIES OR CONDITIONS OF ANY KIND, either express or implied.

See the License for the specific language governing permissions and limitations under the License.

English AsusTek Inc. hereby declares that this device is in compliance with the essential requirements and other relevant provisions of CE Directives. Please see the CE Declaration of Conformity for more details.

Français AsusTek Inc. déclare par la présente que cet appareil est conforme aux critères essentiels et autres clauses pertinentes des directives européennes. Veuillez consulter la déclaration de conformité CE pour plus d'informations.

Deutsch AsusTek Inc. erklärt hiermit, dass dieses Gerät mit den wesentlichen Anforderungen und anderen relevanten Bestimmungen der CE-Richtlinien übereinstimmt. Weitere Einzelheiten entnehmen Sie bitte der CE-Konformitätserklärung.

Italiano AsusTek Inc. con la presente dichiara che questo dispositivo è conforme ai requisiti essenziali e alle altre disposizioni pertinenti alle direttive CE. Per maggiori informazioni fate riferimento alla dichiarazione di conformità CE.

Компания ASUS заявляет, что это устройство соответствует основным требованиям и другим соответствующим условиям европейских директив. Подробную информацию, пожалуйста, смотрите в декларации соответствия.

Български С настоящото AsusTek Inc. декларира, че това устройство е в съответствие със съществениите изисквания и другите приложими постановления на директивите CE. Вижте CE декларацията за съвместимост за повече информация.

Hrvatski AsusTek Inc. ovim izjavljuje da je ovaj uređaj sukladan s bitnim zahtjevima i ostalim odgovarajućim odredbama CE direktiva. Više pojedinosti potražite u CE izvaji o skladnosti.

Čeština Společnost AsusTek Inc. tímto prohlašuje, že toto zařízení splňuje základní požadavky a další příslušná ustanovení směrníc CE. Další podrobnosti viz Prohlášení o shodě CE.

Dansk AsusTek Inc. Erklærer hermed, at denne enhed er i overensstemmelse med hovedkravene and andre relevante bestemmelser i CE-direktiverne. Du kan læse mere i CE-overensstemmelseserklæring.

Nederlands AsusTek Inc. verklaart hierbij dat dit apparaat compatibel is met de essentiële vereisten en andere relevante bepalingen van CE-richtlijnen. Raadpleeg de CE-verklaring van conformiteit voor meer details.

Eesti Käesolevaga kinnitab AsusTek Inc., et see seade vastab CE direktiivide oluliste nõuetele ja teisteles asjakohastele sätetele. Vt üksikasju CE vastavusdeklaratsioonist.

Suomi AsusTek Inc. vakuuttaa täten, että tämä laite on CE-direktiivien olennaisten vaatimusten ja muiden asiaan kuuluvien lisäysten mukainen. Katso lisätietoja CE-vaatimustenmukaisuusvakuutuksesta.

Ελληνικά Με το παρόν, η AsusTek Inc. Δηλώνει ότι αυτή η συσκευή συμμορφώνεται με τις θεμελιώδεις απαιτήσεις και άλλες σχετικές διατάξεις των Οδηγιών της ΕΕ. Για περισσότερες λεπτομέρειες ανατρέξτε στην Δήλωση Συμμόρφωσης ΕΕ.

Magyar Az AsusTek Inc. ezennel kijelenti, hogy a készülék megfelel a CE-irányelvek alapvető követelményeinek és ide vonatkozó egyéb rendelkezéseinek. További részletekért tekintse meg a CE-megfelelőségi nyilatkozatot.

Latviski Lidz ar šo AsusTek Inc. paziņo, ka šī ierīce atbilst būtiskajām prasībām un citiem saistošajiem nosacījumiem, kas norādīti CE direktīvā. Lai uzzinātu vairāk, skatiet CE Atbilstības deklarāciju.

Lietuvių Šiuo dokumentu bendrovė „AsusTek Inc.“ pareiškia, kad šis įrenginys atitinka pagrindinius CE direktyvų reikalavimus ir kitas susijusias nuostatas. Daugiau informacijos rasite CE atitikties deklaracijoje.

Norsk AsusTek Inc. erklærer herved at denne enheten er i samsvar med hovedsaklige krav og andre relevante forskrifter i CE-direktiver. Du finner mer informasjon i CE-samsvarserklæringen.

Polski Niniejszym AsusTek Inc. deklaruje, że to urządzenie jest zgodne z istotnymi wymaganiami oraz innymi powiązanymi zaleceniami Dyrektywy CE. W celu uzyskania szczegółów, sprawdź Deklarację zgodności CE.

Português A AsusTek Inc. declara que este dispositivo está em conformidade com os requisitos essenciais e outras disposições relevantes das Diretivas da CE. Para mais detalhes, consulte a Declaração de Conformidade CE.

Română Prin prezenta, AsusTek Inc. declară faptul că acest dispozitiv respectă cerințele esențiale și alte prevederi relevante ale directivelor CE. Pentru mai multe detalii, consultați declarația de conformitate CE.

Srpski AsusTek Inc. ovim izjavljuje da je ovaj uređaj u saglasnosti sa ključnim zahtjevima i drugim relevantnim odredbama CE Direktiva. Molimo vas, pogledajte CE Deklaraciju o uskladenosti za više detalja.

Slovensky Spoločnosť AsusTek Inc. týmto prehlasuje, že toto zariadenie vyhovuje príslušným požiadavkám a ďalším súvisiacim ustanoveniam smerníc ES. Viac podrobností si pozrite v prehlásení o zhode ES.

Slovenščina AsusTek Inc. tukaj izjavlja, da je ta naprava skladna s temeljnimi zahtevami in drugimi relevantnimi določili direktiv CE. Za več informacij glejte Izjavo CE o skladnosti.

Español Por la presente, AsusTek Inc. declara que este dispositivo cumple los requisitos básicos y otras disposiciones relevantes de las directivas de la CE. Consulte la Declaración de conformidad de la CE para obtener más detalles.

Svenska AsusTek Inc. förklarar härmed att denna enhet är i överensstämmelse med de grundläggande kraven och andra relevanta bestämmelser i CE-direktiven. Se CE-försäkran om överensstämmelse för mer information.

Українська AsusTek Inc. заявляє, що цей пристрій відповідає основним вимогам відповідних Директив ЄС. Будь ласка, див. більше подробиць у Декларації відповідності нормам ЄС.

Türkçe AsusTek Inc., bu aygıtın temel gereksinimleri ve CE Yönergelerinin diğer ilgili koşullarına uyumlu olduğunu beyan eder. Daha fazla ayrıntı için lütfen CE Uygunluk Beyanına bakın.

Bosanski AsusTek Inc. ovim potvrđuje da je ovaj uređaj uskladen s osnovnim zahtjevima i drugim relevantnim propisima Direktiva EK. Za više informacija molimo pogledajte Deklaraciju o uskladenosti EK.

ASUS contact information

ASUSTeK COMPUTER INC.

Address 15 Li-Te Road, Peitou, Taipei, Taiwan 11259
Telephone +886-2-2894-3447
Fax +886-2-2890-7798
E-mail info@asus.com.tw
Web site www.asus.com.com/

Technical Support

Telephone +86-21-38429911
Fax +86-21-5866-8722, ext. 9101#
Online support <http://www.asus.com/tw/support/>

ASUS COMPUTER INTERNATIONAL (America)

Address 800 Corporate Way, Fremont, CA 94539, USA
Telephone +1-510-739-3777
Fax +1-510-608-4555
Web site <http://www.asus.com/us/>

Technical Support

Support fax +1-812-284-0883
Telephone +1-812-282-2787
Online support <http://www.service.asus.com/>

ASUS COMPUTER GmbH (Germany and Austria)

Address Harkort Str. 21-23, D-40880 Ratingen, Germany
Fax +49-2102-959911
Web site <http://www.asus.com/de>
Online contact <http://eu-rma.asus.com/sales>

Technical Support

Telephone +49-1805-010923
Support Fax +49-2102-9599-11
Online support <http://www.asus.com/de/support/>

DECLARATION OF CONFORMITY

Per FCC Part 2, Section 2.1077(a)



Responsible Party Name: **Asus Computer International**

Address: **800 Corporate Way, Fremont, CA 94539.**

Phone/Fax No: **(510)739-3777/(510)608-4555**

hereby declares that the product

Product Name : Motherboard

Model Number : MAXIMUS VIII GENE

Conforms to the following specifications:

FCC Part 15, Subpart B, Unintentional Radiators

Supplementary Information:

This device complies with part 15 of the FCC Rules. Operation is subject to the following two conditions: (1) This device may not cause harmful interference, and (2) this device must accept any interference received, including interference that may cause undesired operation.

Representative Person's Name : Steve Chang / President

Signature :

Date : Jul. 03, 2015

Ver. 140331

ASUS IN SEARCH OF INCREDIBLE

EC Declaration of Conformity

We, the undersigned,

Manufacturer: **ASUSTEK COMPUTER INC.**
 Address: **4F, No. 156, Lite Rd., Peitou, Taipei 112, TAIWAN**
 Authorized representative in Europe: **ASUS COMPUTER GmbH**
 Address, City: **HARKORT STR. 21-25, 40880 RATINGEN**
 Country: **GERMANY**

declare the following apparatus:

Product name : **Motherboard**
 Model name : **MAXIMUS VIII GENE**

conform with the essential requirements of the following directives:

2004/108/EC EMC Directive
 EN 55022:2011(A2:2011)
 EN 61000-3-2:2006(A2:2009)
 EN 55013:2001(A1:2005+A2:2006)

2006/95/EC LVD Directive

EN 60958-1 V.1.1 (2006-01)
 EN 300 440-1 V.1.1 (2010-08)
 EN 300 440-2 V.1.4 (2010-08)
 EN 301 488-3 V.1.4 (2009-05)
 EN 301 488-4 V.1.4 (2009-05)
 EN 301 488-5 V.1.4 (2009-05)
 EN 301 488-6 V.1.4 (2009-05)
 EN 301 488-7 V.1.4 (2009-05)
 EN 301 488-8 V.1.4 (2009-05)
 EN 301 488-9 V.1.4 (2009-05)
 EN 301 488-10 V.1.4 (2009-05)
 EN 301 488-11 V.1.4 (2009-05)
 EN 301 488-12 V.1.4 (2009-05)
 EN 301 488-13 V.1.4 (2009-05)
 EN 301 488-14 V.1.4 (2009-05)
 EN 301 488-15 V.1.4 (2009-05)
 EN 301 488-16 V.1.4 (2009-05)
 EN 301 488-17 V.2.2 (2012-09)
 EN 301 488-18 V.2.2 (2012-09)
 EN 301 488-19 V.2.2 (2012-09)
 EN 302 320-3 V.1.2 (2007-06)
 EN 302 320-4 V.1.3 (2007-06)
 EN 302 320-5 V.1.1 (2009-01)
 EN 302 320-6 V.1.1 (2009-01)
 EN 302 320-7 V.1.1 (2009-01)
 EN 302 320-8 V.1.1 (2009-01)
 EN 302 320-9 V.1.1 (2009-01)
 EN 302 320-10 V.1.1 (2009-01)
 EN 302 320-11 V.1.1 (2009-01)
 EN 302 320-12 V.1.1 (2009-01)
 EN 302 320-13 V.1.1 (2009-01)
 EN 302 320-14 V.1.1 (2009-01)
 EN 302 320-15 V.1.1 (2009-01)
 EN 302 320-16 V.1.1 (2009-01)
 EN 302 320-17 V.1.1 (2009-01)
 EN 302 320-18 V.1.1 (2009-01)
 EN 302 320-19 V.1.1 (2009-01)
 EN 302 320-20 V.1.1 (2009-01)
 EN 302 320-21 V.1.1 (2009-01)
 EN 302 320-22 V.1.1 (2009-01)
 EN 302 320-23 V.1.1 (2009-01)
 EN 302 320-24 V.1.1 (2009-01)
 EN 302 320-25 V.1.1 (2009-01)
 EN 302 320-26 V.1.1 (2009-01)
 EN 302 320-27 V.1.1 (2009-01)
 EN 302 320-28 V.1.1 (2009-01)
 EN 302 320-29 V.1.1 (2009-01)
 EN 302 320-30 V.1.1 (2009-01)
 EN 302 320-31 V.1.1 (2009-01)
 EN 302 320-32 V.1.1 (2009-01)
 EN 302 320-33 V.1.1 (2009-01)
 EN 302 320-34 V.1.1 (2009-01)
 EN 302 320-35 V.1.1 (2009-01)
 EN 302 320-36 V.1.1 (2009-01)
 EN 302 320-37 V.1.1 (2009-01)
 EN 302 320-38 V.1.1 (2009-01)
 EN 302 320-39 V.1.1 (2009-01)
 EN 302 320-40 V.1.1 (2009-01)
 EN 302 320-41 V.1.1 (2009-01)
 EN 302 320-42 V.1.1 (2009-01)
 EN 302 320-43 V.1.1 (2009-01)
 EN 302 320-44 V.1.1 (2009-01)
 EN 302 320-45 V.1.1 (2009-01)
 EN 302 320-46 V.1.1 (2009-01)
 EN 302 320-47 V.1.1 (2009-01)
 EN 302 320-48 V.1.1 (2009-01)
 EN 302 320-49 V.1.1 (2009-01)
 EN 302 320-50 V.1.1 (2009-01)
 EN 302 320-51 V.1.1 (2009-01)
 EN 302 320-52 V.1.1 (2009-01)
 EN 302 320-53 V.1.1 (2009-01)
 EN 302 320-54 V.1.1 (2009-01)
 EN 302 320-55 V.1.1 (2009-01)
 EN 302 320-56 V.1.1 (2009-01)
 EN 302 320-57 V.1.1 (2009-01)
 EN 302 320-58 V.1.1 (2009-01)
 EN 302 320-59 V.1.1 (2009-01)
 EN 302 320-60 V.1.1 (2009-01)
 EN 302 320-61 V.1.1 (2009-01)
 EN 302 320-62 V.1.1 (2009-01)
 EN 302 320-63 V.1.1 (2009-01)
 EN 302 320-64 V.1.1 (2009-01)
 EN 302 320-65 V.1.1 (2009-01)
 EN 302 320-66 V.1.1 (2009-01)
 EN 302 320-67 V.1.1 (2009-01)
 EN 302 320-68 V.1.1 (2009-01)
 EN 302 320-69 V.1.1 (2009-01)
 EN 302 320-70 V.1.1 (2009-01)
 EN 302 320-71 V.1.1 (2009-01)
 EN 302 320-72 V.1.1 (2009-01)
 EN 302 320-73 V.1.1 (2009-01)
 EN 302 320-74 V.1.1 (2009-01)
 EN 302 320-75 V.1.1 (2009-01)
 EN 302 320-76 V.1.1 (2009-01)
 EN 302 320-77 V.1.1 (2009-01)
 EN 302 320-78 V.1.1 (2009-01)
 EN 302 320-79 V.1.1 (2009-01)
 EN 302 320-80 V.1.1 (2009-01)
 EN 302 320-81 V.1.1 (2009-01)
 EN 302 320-82 V.1.1 (2009-01)
 EN 302 320-83 V.1.1 (2009-01)
 EN 302 320-84 V.1.1 (2009-01)
 EN 302 320-85 V.1.1 (2009-01)
 EN 302 320-86 V.1.1 (2009-01)
 EN 302 320-87 V.1.1 (2009-01)
 EN 302 320-88 V.1.1 (2009-01)
 EN 302 320-89 V.1.1 (2009-01)
 EN 302 320-90 V.1.1 (2009-01)
 EN 302 320-91 V.1.1 (2009-01)
 EN 302 320-92 V.1.1 (2009-01)
 EN 302 320-93 V.1.1 (2009-01)
 EN 302 320-94 V.1.1 (2009-01)
 EN 302 320-95 V.1.1 (2009-01)
 EN 302 320-96 V.1.1 (2009-01)
 EN 302 320-97 V.1.1 (2009-01)
 EN 302 320-98 V.1.1 (2009-01)
 EN 302 320-99 V.1.1 (2009-01)
 EN 302 320-100 V.1.1 (2009-01)

2006/95/EC LVD Directive

EN 60950-1:2006 / A12: 2011
 EN 60950-1:2006 / A2: 2013

2009/125/EC RoHS Directive

Regulation (EC) No. 1275/2008
 Regulation (EC) No. 642/2009
 Regulation (EC) No. 2782/2009
 Regulation (EU) No. 617/2013

2011/65/EU RoHS Directive

CE marking

Ver. 150308



(EC conformity marking)

Position : **CEO**
 Name : **Jerry Shen**

Signature : _____

Declaration Date: **03/07/2015**
 Year to begin affixing CE marking: **2015**