

**TUF B360-PRO
GAMING**

ASUS®

Motherboard

Copyright © 2018 ASUSTeK COMPUTER INC. All Rights Reserved.

No part of this manual, including the products and software described in it, may be reproduced, transmitted, transcribed, stored in a retrieval system, or translated into any language in any form or by any means, except documentation kept by the purchaser for backup purposes, without the express written permission of ASUSTeK COMPUTER INC. ("ASUS").

Product warranty or service will not be extended if: (1) the product is repaired, modified or altered, unless such repair, modification of alteration is authorized in writing by ASUS; or (2) the serial number of the product is defaced or missing.

ASUS PROVIDES THIS MANUAL "AS IS" WITHOUT WARRANTY OF ANY KIND, EITHER EXPRESS OR IMPLIED, INCLUDING BUT NOT LIMITED TO THE IMPLIED WARRANTIES OR CONDITIONS OF MERCHANTABILITY OR FITNESS FOR A PARTICULAR PURPOSE. IN NO EVENT SHALL ASUS, ITS DIRECTORS, OFFICERS, EMPLOYEES OR AGENTS BE LIABLE FOR ANY INDIRECT, SPECIAL, INCIDENTAL, OR CONSEQUENTIAL DAMAGES (INCLUDING DAMAGES FOR LOSS OF PROFITS, LOSS OF BUSINESS, LOSS OF USE OR DATA, INTERRUPTION OF BUSINESS AND THE LIKE), EVEN IF ASUS HAS BEEN ADVISED OF THE POSSIBILITY OF SUCH DAMAGES ARISING FROM ANY DEFECT OR ERROR IN THIS MANUAL OR PRODUCT.

SPECIFICATIONS AND INFORMATION CONTAINED IN THIS MANUAL ARE FURNISHED FOR INFORMATIONAL USE ONLY, AND ARE SUBJECT TO CHANGE AT ANY TIME WITHOUT NOTICE, AND SHOULD NOT BE CONSTRUED AS A COMMITMENT BY ASUS. ASUS ASSUMES NO RESPONSIBILITY OR LIABILITY FOR ANY ERRORS OR INACCURACIES THAT MAY APPEAR IN THIS MANUAL, INCLUDING THE PRODUCTS AND SOFTWARE DESCRIBED IN IT.

Products and corporate names appearing in this manual may or may not be registered trademarks or copyrights of their respective companies, and are used only for identification or explanation and to the owners' benefit, without intent to infringe.

Offer to Provide Source Code of Certain Software

This product contains copyrighted software that is licensed under the General Public License ("GPL"), under the Lesser General Public License Version ("LGPL") and/or other Free Open Source Software Licenses. Such software in this product is distributed without any warranty to the extent permitted by the applicable law. Copies of these licenses are included in this product.

Where the applicable license entitles you to the source code of such software and/or other additional data, you may obtain it for a period of three years after our last shipment of the product, either

(1) for free by downloading it from <https://www.asus.com/support/>

or

(2) for the cost of reproduction and shipment, which is dependent on the preferred carrier and the location where you want to have it shipped to, by sending a request to:

ASUSTeK Computer Inc.
Legal Compliance Dept.
15 Li Te Rd.,
Beitou, Taipei 112
Taiwan

In your request please provide the name, model number and version, as stated in the About Box of the product for which you wish to obtain the corresponding source code and your contact details so that we can coordinate the terms and cost of shipment with you.

The source code will be distributed WITHOUT ANY WARRANTY and licensed under the same license as the corresponding binary/object code.

This offer is valid to anyone in receipt of this information.

ASUSTeK is eager to duly provide complete source code as required under various Free Open Source Software licenses. If however you encounter any problems in obtaining the full corresponding source code we would be much obliged if you give us a notification to the email address gpl@asus.com, stating the product and describing the problem (please DO NOT send large attachments such as source code archives, etc. to this email address).

Contents

Safety information.....	iv
About this guide.....	iv
Package contents.....	vi
ASUS TUF B360-PRO GAMING specifications summary	vi
Chapter 1: Product Introduction	
1.1 Before you proceed	1-1
1.2 Motherboard overview.....	1-1
1.3 Central Processing Unit (CPU)	1-9
1.4 System memory	1-10
Chapter 2: BIOS Information	
2.1 Managing and updating your BIOS	2-1
2.2 BIOS setup program	2-6
2.3 Exit menu	2-11
Appendix	
Notices	A-1

Safety information

Electrical safety

- To prevent electrical shock hazard, disconnect the power cable from the electrical outlet before relocating the system.
- When adding or removing devices to or from the system, ensure that the power cables for the devices are unplugged before the signal cables are connected. If possible, disconnect all power cables from the existing system before you add a device.
- Before connecting or removing signal cables from the motherboard, ensure that all power cables are unplugged.
- Seek professional assistance before using an adapter or extension cord. These devices could interrupt the grounding circuit.
- Ensure that your power supply is set to the correct voltage in your area. If you are not sure about the voltage of the electrical outlet you are using, contact your local power company.
- If the power supply is broken, do not try to fix it by yourself. Contact a qualified service technician or your retailer.

Operation safety

- Before installing the motherboard and adding devices on it, carefully read all the manuals that came with the package.
- Before using the product, ensure all cables are correctly connected and the power cables are not damaged. If you detect any damage, contact your dealer immediately.
- To avoid short circuits, keep paper clips, screws, and staples away from connectors, slots, sockets and circuitry.
- Avoid dust, humidity, and temperature extremes. Do not place the product in any area where it may become wet.
- Place the product on a stable surface.
- If you encounter technical problems with the product, contact a qualified service technician or your retailer.

About this guide

This user guide contains the information you need when installing and configuring the motherboard.

How this guide is organized

This guide contains the following parts:

- **Chapter 1: Product Introduction**
This chapter describes the features of the motherboard and the new technology it supports. It includes descriptions of the switches, jumpers, and connectors on the motherboard.
- **Chapter 2: BIOS Information**
This chapter discusses changing system settings through the BIOS Setup menus.

Where to find more information

Refer to the following sources for additional information and for product and software updates.

1. ASUS website

The ASUS website (www.asus.com) provides updated information on ASUS hardware and software products.

2. Optional documentation

Your product package may include optional documentation, such as warranty flyers, that may have been added by your dealer. These documents are not part of the standard package.

Conventions used in this guide

To ensure that you perform certain tasks properly, take note of the following symbols used throughout this manual.



DANGER/WARNING: Information to prevent injury to yourself when trying to complete a task.



CAUTION: Information to prevent damage to the components when trying to complete a task.



IMPORTANT: Instructions that you **MUST** follow to complete a task.



NOTE: Tips and additional information to help you complete a task.

Typography

Bold text

Indicates a menu or an item to select.

Italics

Used to emphasize a word or a phrase.

<Key>

Keys enclosed in the less-than and greater-than sign means that you must press the enclosed key.

Example: <Enter> means that you must press the Enter or Return key.

<Key1> + <Key2> + <Key3>

If you must press two or more keys simultaneously, the key names are linked with a plus sign (+).

Package contents

Check your motherboard package for the following items.

Motherboard	1 x ASUS TUF B360-PRO GAMING motherboard
Cables	2 x SATA 6 Gb/s cables
	1 x IO Shield
Accessories	2 x M.2 Screw Package
	1 x CPU Installation Tool
Application DVD	1 x Support DVD
	1 x User manual
Documentation	1 x TUF Certification card
	1 x TUF GAMING sticker



If any of the above items is damaged or missing, contact your retailer.

ASUS TUF B360-PRO GAMING specifications summary

CPU	LGA1151 socket for 8th Gen Intel® Core™ Processor Supports 14nm CPU Supports Intel® Turbo Boost Technology 2.0* * The Intel® Turbo Boost Technology 2.0 support depends on the CPU types. ** Refer to www.asus.com for Intel® CPU support list.
Chipset	Intel® B360 Chipset
Memory	4 x DIMM, max. 64GB, DDR4 2666/2400/2133 MHz, non-ECC, un-buffered memory Dual channel memory architecture Supports Intel® Extreme Memory Profile (XMP) * DDR4 2666 MHz and higher memory modules will run at max. 2666 MHz on Intel® 8th Gen 6-core or higher processors. ** Refer to www.asus.com for the latest Memory QVL (Qualified Vendors List).
Expansion slots	1 x PCIe 3.0/2.0 x16 slot 1 x PCIe 3.0/2.0 x16 slot (max. at x4 mode) 4 x PCIe 3.0/2.0 x1 slots
Multi-GPU support	Supports AMD® 2-Way/Quad-GPU CrossFireX™ Technology
VGA	Integrated Graphics Processor- Intel® HD Graphics support Multi-VGA output support: HDMI/D-sub ports - Supports HDMI 1.4b with max. resolution 4096 x 2160 @ 24Hz / 2560 x 1600 @ 60Hz - Supports D-sub with max. resolution 1920*1200 @ 60Hz Supports Intel® InTru™ 3D/Quick Sync Video/Clear Video HD Technology/ Insider™ Maximum shared memory of 1024 MB (for iGPU exclusively)

(continued on the next page)

ASUS TUF B360-PRO GAMING specifications summary

Storage	<p>Intel® B360 Chipset</p> <ul style="list-style-type: none"> - 1 x M.2_1 Socket 3 with M Key, type 2242/2260/2280 storage devices support (both SATA & PCIE x2 mode)* - 1 x M.2_2 Socket 3 with M Key, type 2242/2260/2280/22110 storage devices support (PCIE x4 mode) - 6 x SATA 6.0 Gb/s ports - Ready for Intel® Optane Memory <p>* The M.2_1 socket shares SATA_2 port when using M.2 SATA mode devices. Adjust BIOS settings to use a SATA device.</p>
LAN	<p>Intel® I219-V Gigabit LAN</p> <ul style="list-style-type: none"> - Dual interconnect between the integrated Media Access Controller (MAC) and physical layer (PHY) <p>TUF LANGuard ASUS Turbo LAN Utility</p>
Audio	<p>Realtek® ALC887 8-channel* high definition audio CODEC</p> <ul style="list-style-type: none"> - Exclusive DTS Custom for GAMING Headsets - Audio Shielding: Ensures precision analog/digital separation and greatly reduces multi-lateral interference - Dedicated audio PCB layers: Separate layers for left and right channels to guard the quality of the sensitive audio signals - Premium Japanese audio capacitors: Provide warm, natural and immersive sound with exceptional clarity and fidelity. - Supports jack-detection and front panel jack-retasking
USB	<p>Intel® B360 Chipset</p> <ul style="list-style-type: none"> - 2 x USB 3.1 Gen 2 ports up to 10Gbps at back panel (Type-A) - 3 x USB 3.1 Gen 1 ports up to 5Gbps (2 ports @mid-board; 1 ports @back pane <1C>) - 6 x USB 2.0 ports (2 ports @mid-board; 4 ports @back panel)
Exclusive TUF Gaming Features	<p>TUF Armor</p> <p>TUF Components (TUF Cap, TUF Chokes, MOSFET & LANGuard ; certified by military-standard)</p> <p>ASUS TUF PROTECTION</p> <ul style="list-style-type: none"> - ASUS SafeSlot Core: Fortified PCIe with solid soldering - ASUS ESD Guard: Enhanced ESD protection - ASUS Overvoltage Protection: World-class circuit-protecting power design - ASUS Stainless-Steel Back I/O: 3X corrosion-resistance for greater durability! - ASUS DIGI+ VRM: 4+2 Phase digital power design <p>ASUS SafeSlot</p> <p>Exclusive DTS Custom for GAMING Headsets</p> <p>Turbo LAN</p>

(continued on the next page)

ASUS TUF B360-PRO GAMING specifications summary

ASUS Special Features	<p>Superb Performance</p> <p>M.2 onboard</p> <ul style="list-style-type: none"> - The latest transfer technologies with up to 32Gb/s data transfer speeds <p>ASUS Fan Xpert 4 Core</p> <ul style="list-style-type: none"> - Advanced fan and liquid controls for ultimate cooling and quietness <p>ASUS EPU</p> <ul style="list-style-type: none"> - EPU <p>ASUS Exclusive Features</p> <ul style="list-style-type: none"> - AURA Sync - ASUS Ai Charger - ASUS AI Suite 3 <p>EZ DIY</p> <p>EZ Update</p> <p>UEFI BIOS EZ Mode</p> <ul style="list-style-type: none"> - Featuring friendly graphics user interface - ASUS CrashFree BIOS 3 - ASUS EZ Flash 3 <p>File Transfer</p> <ul style="list-style-type: none"> - Cloud GO! - File Transfer <p>Q-Design</p> <ul style="list-style-type: none"> - ASUS Q-LED (CPU, DRAM, VGA, Boot Device LED) - ASUS Q-Slot - ASUS Q-DIMM
ASUS Quiet Thermal Solution	<ul style="list-style-type: none"> - ASUS Fan Xpert 4 Core - Stylish Fanless Design: PCH Heat-sink & MOS Heat-sink
Back Panel I/O Ports	<ul style="list-style-type: none"> 1 x D-sub port 1 x HDMI port 1 x PS/2 combo port 1 x LAN (RJ45) port 2 x USB 3.1 Gen 2 ports (Type-A) 1 x USB 3.1 Gen 1 Type-C™ port 4 x USB 2.0 ports 8-channel Audio I/O ports

(continued on the next page)

ASUS TUF B360-PRO GAMING specifications summary

Internal I/O Connectors	<p>1 x USB 3.1 Gen 1 connector supports additional 2 USB ports (19-pin)</p> <p>1 x USB 2.0 connector supports additional 2 USB ports</p> <p>1 x M.2_1 Socket 3 (for M Key, type 2242/2260/2280 devices)</p> <p>1 x M.2_2 Socket 3 (for M Key, type 2242/2260/2280/22110 devices)</p> <p>6 x SATA 6.0Gb/s connectors</p> <p>1 x CPU Fan connector (support DC/PWM mode)</p> <p>1 x AIO_Pump header (4-pin)</p> <p>2 x Chassis Fan connectors (4-pin) for both 3-pin(DC mode) and 4-pin(PWM mode) coolers control</p> <p>1 x Front panel audio connector (AAFP)</p> <p>1 x 24-pin EATX Power connector</p> <p>1 x 8-pin EATX 12V Power connector</p> <p>1 x System Panel</p> <p>1 x COM port</p> <p>1 x S/PDIF header</p> <p>1 x RGB header</p> <p>1 x Clear CMOS jumper</p>
BIOS	<p>128 Mb Flash ROM, UEFI AMI BIOS, PnP, DMI3.0, WfM2.0, SM BIOS 3.1, ACPI 6.1, Multi-language BIOS, ASUS EZ Flash 3, CrashFree BIOS 3, F6 Qfan Control, F3 My Favorites, F4 AURA ON/OFF, F9 Search, Last Modified log, F12 PrintScreen, and ASUS DRAM SPD (Serial Presence Detect) memory information</p>
Manageability	<p>WfM 2.0, DMI 3.0, WOL by PME, PXE</p>
Support DVD	<p>Drivers</p> <p>ASUS Utilities</p> <p>ASUS EZ Update</p> <p>Anti-virus software (OEM version)</p>
OS Support	<p>Windows® 10 (64-bit)</p>
Form factor	<p>ATX form factor: 12.0 in. x 9.29 in. (30.5 cm x 23.6 cm)</p>



Specifications are subject to change without notice.

Product Introduction

1

1.1 Before you proceed

Take note of the following precautions before you install motherboard components or change any motherboard settings.



- Unplug the power cord from the wall socket before touching any component.
- Before handling components, use a grounded wrist strap or touch a safely grounded object or a metal object, such as the power supply case, to avoid damaging them due to static electricity.
- Before you install or remove any component, ensure that the ATX power supply is switched off or the power cord is detached from the power supply. Failure to do so may cause severe damage to the motherboard, peripherals, or components.

1.2 Motherboard overview

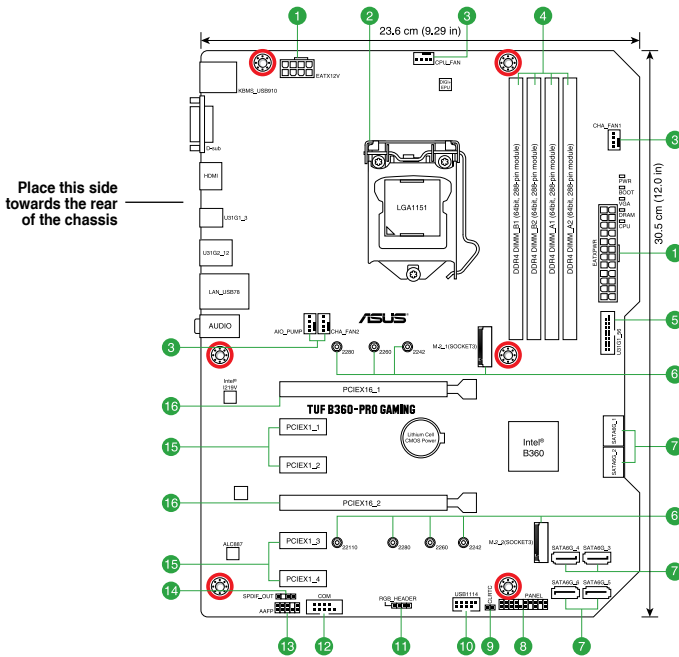

Unplug the power cord before installing or removing the motherboard. Failure to do so can cause you physical injury and damage motherboard components.

1.2.1 Layout contents

Connectors/Jumpers/Slots		Page
1.	ATX power connectors (24-pin EATXPWR, 8-pin EATX12V)	1-2
2.	Intel® LGA1151 CPU socket	1-3
3.	CPU, chassis, and AIO pump fan connectors (4-pin CPU_FAN, 4-pin CHA_FAN1~2, 4-pin AIO_PUMP FAN)	1-3
4.	DDR4 DIMM slots	1-3
5.	USB 3.1 Gen 1 connector (20-1 pin U31G1_56)	1-3
6.	M.2 sockets (M.2_1; M.2_2)	1-4
7.	Intel® B360 Serial ATA 6.0 Gb/s connector (7-pin SATA6G_1~6)	1-4
8.	System panel connector (20-3 pin PANEL)	1-4
9.	Clear RTC RAM (2-pin CLRRTC)	1-5
10.	USB 2.0 connector (10-1 pin USB1114)	1-5
11.	AURA RGB header (4-pin RGB_HEADER)	1-5
12.	Serial port connector (10-1 pin COM)	1-5
13.	Front panel audio connector (10-1 pin AAFP)	1-6
14.	Digital audio connector (4-1 pin SPDIF_OUT)	1-6
15.	PCI Express 3.0/2.0 x1 slots	1-6
16.	PCI Express 3.0/2.0 x16 slots	1-6

1 ATX power connectors (24-pin EATXPWR, 8-pin EATX12V)

Correctly orient the ATX power supply plugs into these connectors and push down firmly until the connectors completely fit.

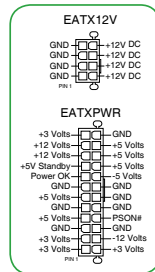

- For a fully configured system, we recommend that you use a power supply unit (PSU) that complies with ATX 12 V Specification 2.0 (or later version) and provides a minimum power of 350 W. This PSU type has 24-pin and 8-pin power plugs.
- We recommend that you use a PSU with higher power output when configuring a system with more power-consuming devices or when you intend to install additional devices. The system may become unstable or may not boot up if the power is inadequate.

2 Intel® LGA1151 CPU socket

Install Intel® LGA1151 CPU into this surface mount LGA1151 socket, which is designed for 8th Generation Intel® Core™ i7 / i5 / i3, Pentium®, and Celeron® processors.



For more details, refer to **1.3 Central Processing Unit (CPU)**.

3 CPU, chassis, and AIO pump fan connectors (4-pin CPU_FAN, 4-pin CHA_FAN1~2, 4-pin AIO_PUMP FAN)

Connect the fan cables to the fan connectors on the motherboard, ensuring that the black wire of each cable matches the ground pin of the connector.

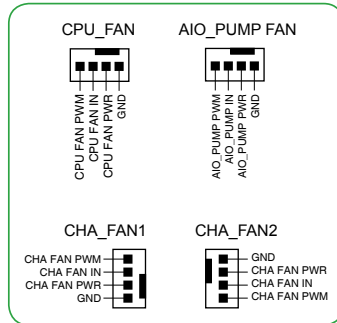

4 DDR4 DIMM slots

Install 2 GB, 4 GB, 8 GB, and 16 GB unbuffered non-ECC DDR4 DIMMs into these DIMM sockets.



For more details, refer to **1.4 System memory**.

5 USB 3.1 Gen 1 connector (20-1 pin U31G1_56)

Connect a USB 3.1 Gen 1 module to any of these connectors for additional USB 3.1 Gen 1 front or rear panel ports. These connectors comply with USB 3.1 Gen 1 specifications and provides faster data transfer speeds of up to 5 Gbps, faster charging time for USB-chargeable devices, optimized power efficiency, and backward compatibility with USB 2.0

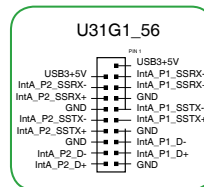

6 M.2 sockets (M.2_1; M.2_2)

These sockets allow you to install M.2 (NGFF) SSD modules.

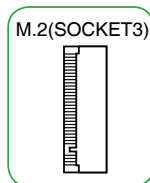

- The M.2_1 socket supports M Key and 2242/2260/2280 storage devices (both SATA & PCIE x2 mode), and supports data transfer speed of up to 16Gb/s.
- The M.2_2 socket supports M Key and 2242/2260/2280/22110 storage devices (PCIE x4 mode), and supports data transfer speed of up to 32Gb/s.
- When a device in SATA mode is installed on the M.2_1 socket, SATA_2 port cannot be used.

7 Intel® B360 Serial ATA 6.0Gb/s connectors (7-pin SATA6G_1-6)

These connectors connect to Serial ATA 6.0 Gb/s hard disk drives via Serial ATA 6.0 Gb/s signal cables.

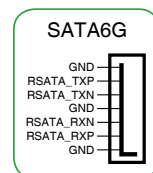

8 System panel connector (20-3 pin PANEL)

This connector supports several chassis-mounted functions.

• System power LED (4-pin PWR_LED)

This 4-pin connector is for the system power LED. Connect the chassis power LED cable to this connector. The system power LED lights up when you turn on the system power, and blinks when the system is in sleep mode.

• System power LED (2-pin or 3-1 pin PLED)

The 2-pin or 3-1 pin connector is for the system power LED.

• Hard disk drive activity LED (2-pin HDD_LED)

This 2-pin connector is for the HDD Activity LED.

• System warning speaker (4-pin SPEAKER)

This 4-pin connector is for the chassis-mounted system warning speaker.

• ATX power button/soft-off button (2-pin PWR_SW)

This connector is for the system power button.

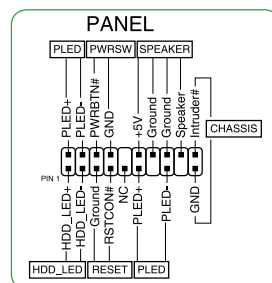

- **Reset button (2-pin RESET)**

This 2-pin connector is for the chassis-mounted reset button for system reboot without turning off the system power.

- **Chassis intrusion connector (2-pin CHASSIS)**

This connector is for a chassis-mounted intrusion detection sensor or switch.

9

Clear RTC RAM (2-pin CLRRTC)

This header allows you to clear the CMOS RTC RAM data of the system setup information such as date, time, and system passwords.

To erase the RTC RAM:

1. Turn OFF the computer and unplug the power cord.
2. Use a metal object such as a screwdriver to short the two pins.
3. Plug the power cord and turn ON the computer.
4. Hold down the key during the boot process and enter BIOS setup to re-enter data.

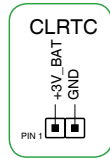

If the steps above do not help, remove the onboard battery and short the two pins again to clear the CMOS RTC RAM data. After clearing the CMOS, reinstall the battery.

10

USB 2.0 connector (10-1 pin USB1114)

Connect a USB module cable to this connector, then install the module to a slot opening at the back of the system chassis. This USB connectors comply with USB 2.0 specifications and supports up to 480Mbps connection speed.

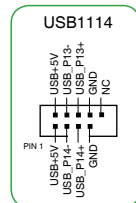

11

AURA RGB header (4-pin RGB_HEADER)

These connectors are for RGB LED strips.

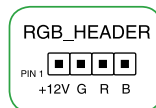

12

Serial port connector (10-1 pin COM)

This connector is for a serial (COM) port. Connect the serial port module cable to this connector, then install the module to a slot opening at the back of the system chassis.

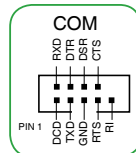

13 Front panel audio connector (10-1 pin AAFP)

This connector is for a chassis-mounted front panel audio I/O module that supports HD Audio standard. Connect one end of the front panel audio I/O module cable to this connector.

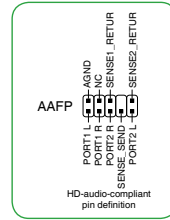

14 Digital audio connector (4-1 pin SPDIF_OUT)

This connector is for an additional Sony/Philips Digital Interface (S/PDIF) port. Connect the S/PDIF Out module cable to this connector, then install the module to a slot opening at the back of the system chassis.

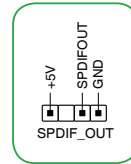

We recommend that you connect a high-definition front panel audio module to this connector to avail of the motherboard's high-definition audio capability.

15 PCI Express 3.0/2.0 x1 slots

This motherboard has four PCI Express 3.0/2.0 x1 slots that support PCI Express x1 network cards, SCSI cards, and other cards that comply with the PCI Express specifications.

16 PCI Express 3.0/2.0 x16 slots

This motherboard supports two PCI Express 3.0/2.0 x16 graphic cards that comply with the PCI Express specifications. Actual PCI Express speeds varies per BIOS settings.

VGA configuration	PCI Express operating mode	
	PCIe 3.0 x16_1 (gray)	PCIe 3.0 x16_2
Single VGA/PCIe card	x16 (Recommended for single VGA card)	N/A
Dual VGA/PCIe cards	x16	x4



- In single VGA card mode, use the PCIe 3.0 x16_1 slot (gray) for a PCI Express x16 graphics card to get better performance.
- We recommend that you provide sufficient power when running CrossFire™ mode.
- Connect a chassis fan to the motherboard connector labeled CHA_FAN1/2 when using multiple graphics cards for better thermal environment.

1.2.2 Rear panel connectors

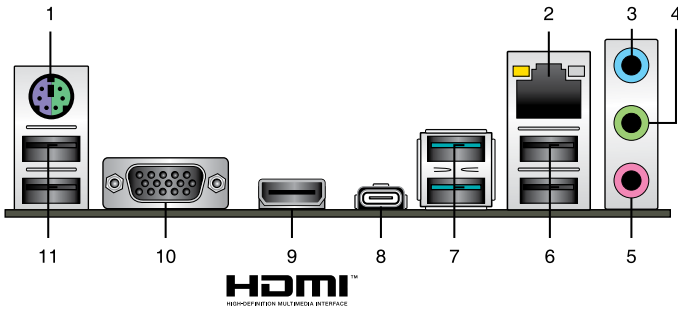

- PS/2 Mouse/Keyboard combo port.** This port connects to a PS/2 mouse or PS/2 keyboard.
- LAN (RJ-45) port.** This port allows Gigabit connection to a Local Area Network (LAN) through a network hub.

LAN port LED indications

Activity/Link LED		Speed LED	
Status	Description	Status	Description
Off	No link	OFF	10Mbps connection
Orange	Linked	ORANGE	100Mbps connection
Orange (Blinking)	Data activity	GREEN	1Gbps connection
Orange (Blinking then steady)	Ready to wake up from S5 mode		

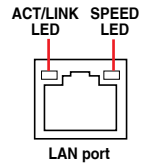

- Line In port (light blue).** This port connects to the tape, CD, DVD player, or other audio sources.
- Line Out port (lime).** This port connects to a headphone or a speaker. In the 4, 5.1 and 7.1-channel configurations, the function of this port becomes Front Speaker Out.
- Microphone port (pink).** This port connects to a microphone.



Refer to the audio configuration table for the function of the audio ports in 2, 4, 5.1, or 7.1-channel configuration.

Audio 2, 4, 5.1, or 7.1-channel configuration

Port	Headset 2-channel	4-channel	5.1-channel	7.1-channel
Light Blue (Rear panel)	Line In	Rear Speaker Out	Rear Speaker Out	Rear Speaker Out
Lime (Rear panel)	Line Out	Front Speaker Out	Front Speaker Out	Front Speaker Out
Pink (Rear panel)	Mic In	Mic In	Bass/Center	Bass/Center
Lime (Front panel)	-	-	-	Side Speaker Out



To configure a 7.1-channel audio output:

Use a chassis with HD audio module in the front panel to support a 7.1-channel audio output.

6. **USB 2.0 ports.** These 4-pin Universal Serial Bus (USB) ports are for USB 2.0/1.1 devices.
7. **USB 3.1 Gen 2 Type-A ports.** These 9-pin Universal Serial Bus 3.1 (USB 3.1) ports are for USB 3.1 Gen 2 devices.



- Due to the limitation of USB 3.1 Gen 2 and USB 3.1 Gen 1 controller, USB 3.1 Gen 2 and USB 3.1 Gen 1 devices can only be used under Windows OS environment and after the USB 3.1 Gen 2 and USB 3.1 Gen 1 driver installation.
 - We strongly recommend that you connect USB 3.1 Gen 2 and USB 3.1 Gen 1 devices to USB 3.1 Gen 2 and USB 3.1 Gen 1 ports for faster and better performance from your USB 3.1 Gen 2 and USB 3.1 Gen 1 devices.
-

8. **USB 3.1 Gen 1 Type-C™ port.** This 24-pin Universal Serial Bus (USB) port is for USB (Type C) devices.
9. **HDMI port.** This port is for a High-Definition Multimedia Interface (HDMI) connector, and is HDCP compliant allowing playback of HD DVD, Blu-ray, and other protected content.
10. **D-sub port.** This port is for a VGA monitor or other VGA compatible devices.
11. **USB 2.0 ports.** These 4-pin Universal Serial Bus (USB) ports are for USB 2.0/1.1 devices.

1.3 Central Processing Unit (CPU)

This motherboard comes with a surface mount LGA1151 socket designed for the 8th Generation Intel® Core™ i7 / Core™ i5 / Core™ i3, Pentium® and Celeron® processors.

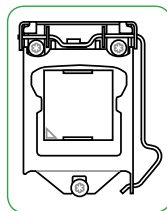

Unplug all power cables before installing the CPU.



- Ensure that you install the correct CPU designed for the LGA1151 socket only. DO NOT install a CPU designed for LGA1150, LGA1155 and LGA1156 sockets on the LGA1151 socket.
- Upon purchase of the motherboard, ensure that the PnP cap is on the socket and the socket contacts are not bent. Contact your retailer immediately if the PnP cap is missing, or if you see any damage to the PnP cap/socket contacts/motherboard components.
- Keep the cap after installing the motherboard. ASUS will process Return Merchandise Authorization (RMA) requests only if the motherboard comes with the cap on the LGA1151 socket.
- The product warranty does not cover damage to the socket contacts resulting from incorrect CPU installation/removal, or misplacement/loss/incorrect removal of the PnP cap.

Installing the CPU

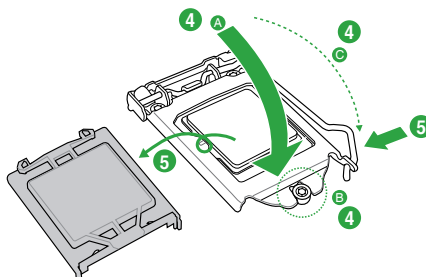
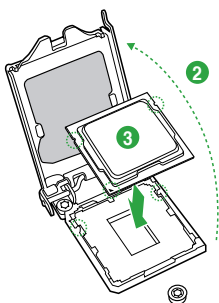
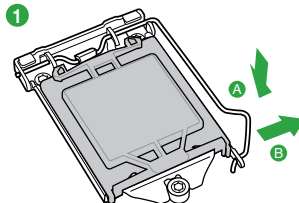
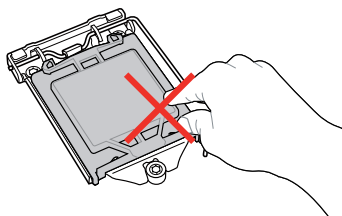

Apply the Thermal Interface Material to the CPU heatsink and CPU before you install the heatsink and fan if necessary.

1.4 System memory

Overview

This motherboard comes with four Double Data Rate 4 (DDR4) Dual Inline Memory Module (DIMM) sockets. The figure illustrates the location of the DDR4 DIMM sockets:

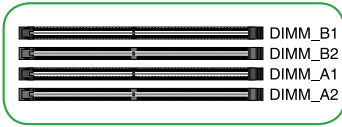

Channel	Sockets
Channel A	DIMM_A1 & DIMM_A2
Channel B	DIMM_B1 & DIMM_B2



- You may install varying memory sizes in Channel A and Channel B. The system maps the total size of the lower-sized channel for the dual-channel configuration. Any excess memory from the higher-sized channel is then mapped for single-channel operation.
- Always install DIMMs with the same CAS latency. For optimal compatibility, we recommend that you install memory modules of the same version or date code (D/C) from the same vendor. Check with the retailer to get the correct memory modules.
- According to Intel® CPU spec, DIMM voltage below 1.35V is recommended to protect the CPU.
- Due to Intel® chipset limitation, DDR4 2666MHz and higher memory modules will run at max. 2666MHz on Intel® 8th Gen. 6-core or higher processors.



- The default memory operation frequency is dependent on its Serial Presence Detect (SPD), which is the standard way of accessing information from a memory module. Under the default state, some memory modules for overclocking may operate at a lower frequency than the vendor-marked value.
- For system stability, use a more efficient memory cooling system to support a full memory load (4 DIMMs).
- Refer to www.asus.com for the latest Memory QVL (Qualified Vendors List)

Installing a DIMM

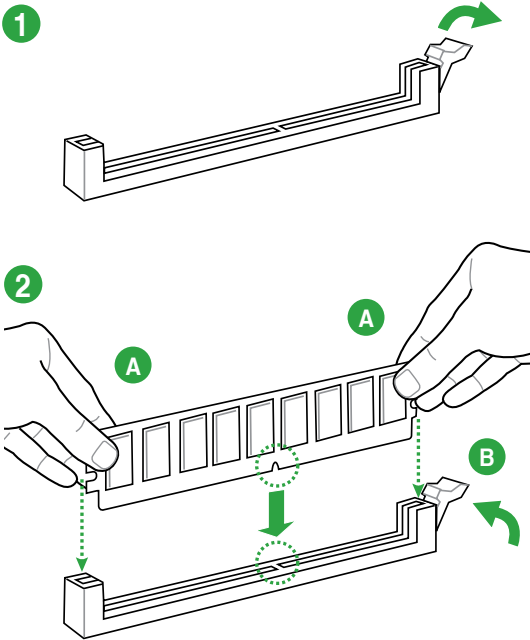

To remove a DIMM

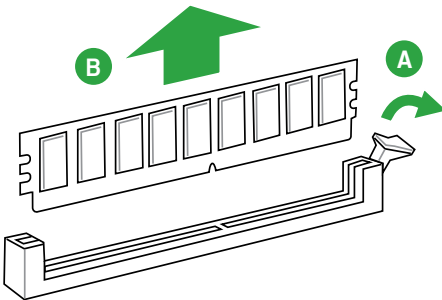

BIOS Information

2

2.1 Managing and updating your BIOS



Save a copy of the original motherboard BIOS file to a USB flash disk in case you need to restore the BIOS in the future. Copy the original motherboard BIOS using the ASUS Update utility.

2.1.1 EZ Update

EZ Update is a utility that allows you to automatically update your motherboard's softwares, drivers and the BIOS version easily. With this utility, you can also manually update the saved BIOS and select a boot logo when the system goes into POST.

To launch EZ Update, click **EZ Update** on the AI Suite 3 main menu bar.

The screenshot shows the ASUS EZ Update utility window. It features a dark blue background with white text. At the top right, it displays 'Current BIOS' information: Model Name: Z170K, Version: 302, Release Date: 05/22/2015. Below this, there are two main sections: 'Check updates from internet:' with a 'Check Now!' button, and 'Manually update Boot logo or BIOS:' with a 'Select a downloaded BIOS file then click "MyLogo" or "BIOS Update"' instruction and a file selection button. At the bottom right, there are three buttons: 'MyLogo', 'BIOS Update', and 'Update BIOS'. Red lines with text annotations point to these elements: 'Click to automatically update your motherboard's driver, software and firmware' points to the 'Check Now!' button; 'Click to find and select the BIOS from file' points to the file selection button; 'Click to select a boot logo' points to the 'MyLogo' button; and 'Click to update the BIOS' points to the 'Update BIOS' button.



EZ Update requires an Internet connection either through a network or an ISP (Internet Service Provider).

2.1.2 ASUS EZ Flash 3

The ASUS EZ Flash 3 allows you to download and update to the latest BIOS through the Internet without having to use a bootable floppy disk or an OS-based utility.



- Ensure to load the BIOS default settings to ensure system compatibility and stability. Select the Load Optimized Defaults item under the Exit menu. See section **2.3 Exit Menu** for details.
- Check your local Internet connection before updating through the Internet.

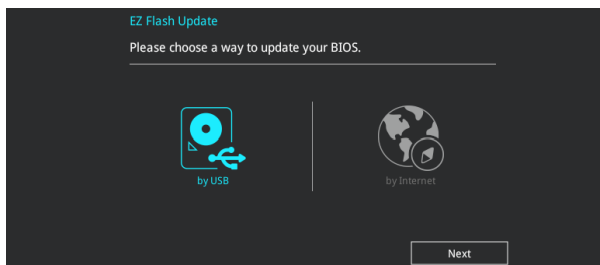

To update the BIOS using EZ Flash 3:

1. Enter the **Advanced Mode** of the BIOS setup program. Go to the **Tool** menu to select ASUS EZ Flash 3 and press <Enter> to enable it.
2. Follow the steps below to update the BIOS via USB or Internet.

Via USB

- a) Insert the USB flash disk that contains the latest BIOS file to the USB port, then select **by USB**.
- b) Press <Tab> to switch to the **Drive** field.
- c) Press the Up/Down arrow keys to find the USB flash disk that contains the latest BIOS, and then press <Enter>.
- d) Press <Tab> to switch to the **Folder** field.
- e) Press the Up/Down arrow keys to find the BIOS file, and then press <Enter> to perform the BIOS update process.

Via the Internet

- a) Select **by Internet**.
 - b) Press the Left/Right arrow keys to select an Internet connection method, and then press <Enter>.
 - c) Follow the onscreen instructions to complete the update.
3. Reboot the system when the update process is done.



-
- ASUS EZ Flash 3 supports USB devices, such as a USB flash disk, with FAT 32/16 format and single partition only.
 - DO NOT shut down or reset the system while updating the BIOS to prevent system boot failure!
-

2.1.3 ASUS CrashFree BIOS 3 utility

The ASUS CrashFree BIOS 3 is an auto recovery tool that allows you to restore the BIOS file when it fails or gets corrupted during the updating process. You can restore a corrupted BIOS file using the motherboard support DVD or a USB flash drive that contains the updated BIOS file.



-
- Before using this utility, rename the BIOS file in the removable device into **TGB360P.CAP**.
 - The BIOS file in the support DVD may not be the latest version. Download the latest BIOS file from the ASUS website at www.asus.com.
-

Recovering the BIOS

To recover the BIOS:

1. Turn on the system.
2. Insert the support DVD to the optical drive or the USB flash drive that contains the BIOS file to the USB port.
3. The utility automatically checks the devices for the BIOS file. When found, the utility reads the BIOS file and enters ASUS EZ Flash 3 utility automatically.
4. The system requires you to enter BIOS Setup to recover BIOS settings. To ensure system compatibility and stability, we recommend that you press <F5> to load default BIOS values.



DO NOT shut down or reset the system while updating the BIOS! Doing so can cause system boot failure!

2.1.4 ASUS BIOS Updater

ASUS BIOS Updater allows you to update the BIOS in DOS environment.



The screen captures used in this section are for reference only and may not be exactly the same as actually shown on your computer screen.

Before updating BIOS

- Prepare the motherboard support DVD and a USB flash drive.
- Download the latest BIOS file and BIOS Updater from <https://www.asus.com/support> and save them in your USB flash drive.



NTFS is not supported under FreeDOS environment. Ensure that your USB flash drive is in single partition and in FAT32/16 format.

- Turn off the computer.
- Ensure that your computer has a DVD optical drive.

Booting the system in DOS environment

To boot the system in DOS:

1. Insert the USB flash drive with the latest BIOS file and BIOS Updater to the USB port.
2. Boot your computer then press <F8> to launch the select boot device screen.
3. When the select boot device screen appears, insert the Support DVD into the optical drive then select the optical drive as the boot device.

Please select boot device:

↑ and ↓ to move selection
ENTER to select boot device
ESC to boot using defaults

```
P2: ST3808110AS (76319MB)
aigo miniking (250MB)
UEFI: (FAT) ASUS DRW-2014L1T(4458MB)
P1: ASUS DRW-2014L1T(4458MB)
UEFI: (FAT) aigo miniking (250MB)
Enter Setup
```

4. When the booting message appears, press <Enter> within five (5) seconds to enter FreeDOS prompt.

```
ISOLINUX 3.20 2006-08-26 Copyright (C) 1994-2005 H. Peter Anvin
A Bootable DVD/CD is detected. Press ENTER to boot from the DVD/CD.
If no key is pressed within 5 seconds, the system will boot next priority
device automatically. boot:
```

5. On the FreeDOS prompt, type **d:** then press <Enter> to switch the disk from Drive C (optical drive) to Drive D (USB flash drive).

```
Welcome to FreeDOS (http://www.freedos.org) !
C: /> d:
D: />
```

Updating the BIOS file

To update the BIOS file:

1. On the FreeDOS prompt, type **bupdater /g** and press <Enter>.

```
D: /> bupdater /g
```

- On the BIOS Updater screen, press <Tab> to switch from Files panel to Drives panel then select D: .

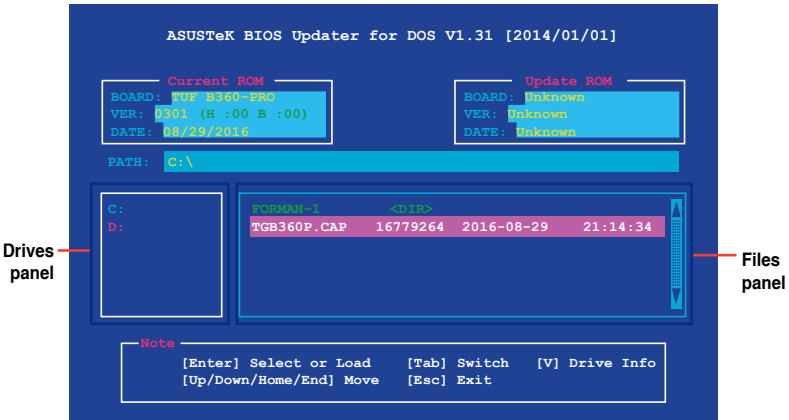

- Press <Tab> to switch from Drives panel to Files panel then press <Up/Down or Home/End> keys to select the BIOS file and press <Enter>.
- After the BIOS Updater checks the selected BIOS file, select **Yes** to confirm the BIOS update.



The BIOS Backup feature is not supported due to security regulations.

- Select **Yes** then press <Enter>. When BIOS update is done, press <ESC> to exit BIOS Updater.
- Restart your computer.



DO NOT shut down or reset the system while updating the BIOS to prevent system boot failure.



Ensure to load the BIOS default settings to ensure system compatibility and stability. Select the **Load Optimized Defaults** item under the **Exit BIOS** menu. See section 2.3 **Exit Menu** for details.

2.2 BIOS setup program

Use the BIOS Setup program to update the BIOS or configure its parameters. The BIOS screens include navigation keys and brief online help to guide you in using the BIOS Setup program.

Entering BIOS Setup at startup

To enter BIOS Setup at startup:

Press <Delete> or <F2> during the Power-On Self Test (POST). If you do not press <Delete> or <F2>, POST continues with its routines.

Entering BIOS Setup after POST

To enter BIOS Setup after POST:

Press <Ctrl>+<Alt>+ simultaneously.

Press the reset button on the system chassis.

Press the power button to turn the system off then back on. Do this option only if you failed to enter BIOS Setup using the first two options.



Using the power button, reset button, or the <Ctrl>+<Alt>+ keys to force reset from a running operating system can cause damage to your data or system. We recommend you always shut down the system properly from the operating system.



- The BIOS setup screens shown in this section are for reference purposes only, and may not exactly match what you see on your screen.
 - Visit the ASUS website at www.asus.com to download the latest BIOS file for this motherboard.
 - Ensure that a USB mouse is connected to your motherboard if you want to use the mouse to control the BIOS setup program.
 - If the system becomes unstable after changing any BIOS setting, load the default settings to ensure system compatibility and stability. Select the **Load Optimized Defaults** item under the Exit menu or press hotkey F5. See section 2.3 **Exit Menu** for details.
 - If the system fails to boot after changing any BIOS setting, try to clear the CMOS and reset the motherboard to the default value. See section 1.2 **Motherboard overview** for information on how to erase the RTC RAM.
-

BIOS menu screen

The BIOS setup program can be used under two modes: **EZ Mode** and **Advanced Mode**. Press <F7> to change between the two modes.

2.2.1 EZ Mode

By default, the EZ Mode screen appears when you enter the BIOS setup program. The EZ Mode provides you an overview of the basic system information, and allows you to select the display language, system performance mode, fan profile and boot device priority. To access the Advanced Mode, click **Advanced Mode(F7)** or press <F7>.



The default screen for entering the BIOS setup program can be changed. Go to the **Setup Mode** item in the **Boot menu**.

Displays a quick overview of the system status

Displays the system properties of the selected mode. Click < > to switch EZ System Tuning modes

The screenshot shows the 'UEFI BIOS Utility - EZ Mode' interface. At the top, it displays the date and time (04:54), language (English), and search function (F9). The main area is divided into several sections: 'Information' (system model, CPU, speed, memory), 'CPU Temperature' (31°C), 'CPU Core Voltage' (1.024 V), 'Motherboard Temperature' (30°C), 'DRAM Status', 'SATA Information', 'X.M.P.' (disabled), 'FAN Profile' (CPU and CHA2 fans), 'Intel Rapid Storage Technology' (On/Off), 'CPU FAN' speed graph (1764 RPM), 'QFan Control', 'EZ System Tuning' (Normal mode), 'Boot Priority' (UEFI: USB 2.0 SD/MMC Reader, UEFI: SanDisk), and 'Boot Menu(F8)'. At the bottom, navigation options are listed: Default(F5), Save & Exit(F10), Advanced Mode(F7) | < >, and Search on FAQ.

Selects the display language of the BIOS setup program

Search(F9)

AURA ON/OFF(F4)

Information
TUF B360-PRO GAMING BIOS Ver: 0203
Intel(R) Core(TM) i5-8400 CPU @ 2.80GHz
Speed: 2800 MHz
Memory: 4096 MB (DDR4 2133MHz)

CPU Temperature

CPU Core Voltage

1.024 V

Motherboard Temperature

30°C

EZ System Tuning

Click the icon to specify your preferred system settings for a power-saving system environment



< Normal >

DRAM Status

DIMM_A1: SK Hynix 8192MB 2133MHz

DIMM_A2: N/A

DIMM_B1: N/A

DIMM_B2: N/A

SATA Information

X.M.P.

Disabled Disabled

FAN Profile

CPU FAN

1764 RPM

CHA1 FAN

N/A

CHA2 FAN

N/A

AIO PUMP

N/A

Intel Rapid Storage Technology

On Off

CPU FAN

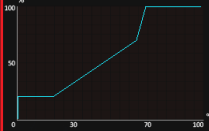

QFan Control

Boot Priority

Choose one and drag the items. Switch all

UEFI: USB 2.0 SD/MMC Reader, Partition 1 (947MB)

UEFI: SanDisk, Partition 1 (30528MB)

Boot Menu(F8)

Default(F5)

Save & Exit(F10)

Advanced Mode(F7) | < >

Search on FAQ

Enables or disables the SATA RAID mode for Intel Rapid Storage Technology

Displays the CPU Fan's speed. Click the button to manually tune the fans

Loads optimized default settings

Saves the changes and resets the system

Click to go to Advanced mode

Search on the FAQ

Click to display boot devices

Selects the boot device priority



The boot device options vary depending on the devices you installed to the system.

2.2.2 Advanced Mode

The Advanced Mode provides advanced options for experienced end-users to configure the BIOS settings. The figure below shows an example of the **Advanced Mode**. Refer to the following sections for the detailed configurations.



To access the EZ Mode, click **EzMode(F7)** or press <F7>.

The screenshot shows the UEFI BIOS Utility - Advanced Mode interface. The interface is dark-themed with blue and white text. At the top, there is a search bar and a scroll bar. The main menu includes My Favorites, Main, AI Tweaker, **Advanced**, Monitor, Boot, Tool, and Exit. The Advanced mode is currently selected, showing various configuration fields such as L2 Cache, L3 Cache, L4 Cache, Intel VT-x Technology, Intel SMX Technology, Software Guard Extensions (SGX), Tcc Offset Time Window, Hardware Prefetcher, Adjacent Cache Line Prefetch, Intel (VMX) Virtualization Technology, Active Processor Cores, Hyper-Threading, and CPU - Power Management Control. A pop-up menu is open for Software Guard Extensions (SGX), showing options: Software Controlled, Disabled, and Software Controlled. The bottom of the screen displays the version number (2.19.1269), copyright information (© 2018 American Megatrends, Inc.), and navigation options like Last Modified, EzMode(F7), Hot Keys, and Search on FAQ. A Hardware Monitor section on the right provides a quick overview of system status, including CPU frequency (3200 MHz), temperature (32°C), BCLK (100.00 MHz), core voltage (1.040 V), Ratio (32x), Memory frequency (2133 MHz), voltage (1.200 V), and Capacity (8192 MB). The Voltage section shows +12V (+5V), 12.096 V (4.960 V), +3.3V, and 3.344 V.

Configuration fields

Pop-up Menu

Menu bar

Language

MyFavorite(F3)

Qfan Control(F6)

Search(F9)

AURA ON/OFF(F4)

Scroll bar

Menu items

General help

Last modified settings

Go back to EZ Mode

Hot Keys

Search on the FAQ

Displays a quick overview of the system status

Menu bar

The menu bar on top of the screen has the following main items:

My Favorites	For saving the frequently-used system settings and configuration
Main	For changing the basic system configuration
Ai Tweaker	For changing the overclocking settings
Advanced	For changing the advanced system settings
Monitor	For displaying the system temperature, power status, and changing the fan settings
Boot	For changing the system boot configuration
Tool	For configuring options for special functions
Exit	For selecting the exit options and loading default settings

Menu items

The highlighted item on the menu bar displays the specific items for that menu. For example, selecting **Main** shows the Main menu items.

The other items (My Favorites, Ai Tweaker, Advanced, Monitor, Boot, Tool, and Exit) on the menu bar have their respective menu items.

Submenu items

A greater than sign (>) before each item on any menu screen means that the item has a submenu. To display the submenu, select the item and press <Enter>.

Language

This button above the menu bar contains the languages that you can select for your BIOS. Click this button to select the language that you want to display in your BIOS screen.

My Favorites (F3)

This button above the menu bar shows all BIOS items in a Tree Map setup. Select frequently-used BIOS settings and save it to MyFavorites menu.

Q-Fan Control (F6)

This button above the menu bar displays the current settings of your fans. Use this button to manually tweak the fans to your desired settings.

Search (F9)

This button allows you to search for BIOS items by entering its name, enter the item name to find the related item listing.

AURA (F4)

This button allows you to turn the RGB LED lighting or functional LED on or off.

[ON] All AURA effects will be enabled. (Default mode)

[OFF] All AURA effects will be disabled.

Search on FAQ

Move your mouse over this button to show a QR code, scan this QR code on your mobile device to connect to the BIOS FAQ web page of the ASUS support website. You can also scan the following QR code:



Scroll bar

A scroll bar appears on the right side of a menu screen when there are items that do not fit on the screen. Press the Up/Down arrow keys or <Page Up> / <Page Down> keys to display the other items on the screen.

General help

At the bottom of the menu screen is a brief description of the selected item. Use <F12> key to capture the BIOS screen and save it to the removable storage device.

Configuration fields

These fields show the values for the menu items. If an item is user-configurable, you can change the value of the field opposite the item. You cannot select an item that is not user-configurable.

A configurable field is highlighted when selected. To change the value of a field, select it and press <Enter> to display a list of options.

Hot keys

This button contains the navigation keys for the BIOS setup program. Use the navigation keys to select items in the menu and change the settings.

Last Modified button

This button shows the items that you last modified and saved in BIOS Setup.

2.3 Exit menu

The Exit menu items allow you to load the optimal default values for the BIOS items, and save or discard your changes to the BIOS items.

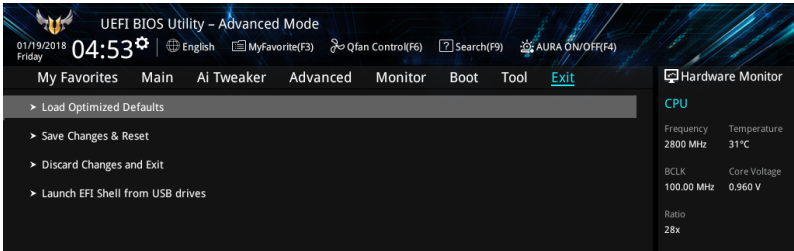

Load Optimized Defaults

This option allows you to load the default values for each of the parameters on the Setup menus. When you select this option or if you press <F5>, a confirmation window appears. Select OK to load the default values.

Save Changes & Reset

Once you are finished making your selections, choose this option from the Exit menu to ensure the values you selected are saved. When you select this option or if you press <F10>, a confirmation window appears. Select OK to save changes and exit.

Discard Changes and Exit

This option allows you to exit the Setup program without saving your changes. When you select this option or if you press <Esc>, a confirmation window appears. Select OK to discard changes and exit.

Launch EFI Shell from USB drives

This option allows you to attempt to launch the EFI Shell application (shellx64.efi) from one of the available USB devices.

Appendix

Notices

Federal Communications Commission Statement

This device complies with Part 15 of the FCC Rules. Operation is subject to the following two conditions:

- This device may not cause harmful interference.
- This device must accept any interference received including interference that may cause undesired operation.

This equipment has been tested and found to comply with the limits for a Class B digital device, pursuant to Part 15 of the FCC Rules. These limits are designed to provide reasonable protection against harmful interference in a residential installation. This equipment generates, uses and can radiate radio frequency energy and, if not installed and used in accordance with manufacturer's instructions, may cause harmful interference to radio communications. However, there is no guarantee that interference will not occur in a particular installation. If this equipment does cause harmful interference to radio or television reception, which can be determined by turning the equipment off and on, the user is encouraged to try to correct the interference by one or more of the following measures:

- Reorient or relocate the receiving antenna.
- Increase the separation between the equipment and receiver.
- Connect the equipment to an outlet on a circuit different from that to which the receiver is connected.
- Consult the dealer or an experienced radio/TV technician for help.



The use of shielded cables for connection of the monitor to the graphics card is required to assure compliance with FCC regulations. Changes or modifications to this unit not expressly approved by the party responsible for compliance could void the user's authority to operate this equipment.

Compliance Statement of Innovation, Science and Economic Development Canada (ISED)

This device complies with Innovation, Science and Economic Development Canada licence exempt RSS standard(s). Operation is subject to the following two conditions: (1) this device may not cause interference, and (2) this device must accept any interference, including interference that may cause undesired operation of the device.

CAN ICES-3(B)/NMB-3(B)

Déclaration de conformité de Innovation, Sciences et Développement économique Canada (ISED)

Le présent appareil est conforme aux CNR d'Innovation, Sciences et Développement économique Canada applicables aux appareils radio exempts de licence. L'exploitation est autorisée aux deux conditions suivantes : (1) l'appareil ne doit pas produire de brouillage, et (2) l'utilisateur de l'appareil doit accepter tout brouillage radioélectrique subi, même si le brouillage est susceptible d'en compromettre le fonctionnement.

CAN ICES-3(B)/NMB-3(B)

VCCI: Japan Compliance Statement

Class B ITE

この装置は、クラスB情報技術装置です。この装置は、家庭環境で使用することを目的としていますが、この装置がラジオやテレビジョン受信機に近接して使用されると、受信障害を引き起こすことがあります。

取扱説明書に従って正しい取り扱いをして下さい。

V C C I - B

KC: Korea Warning Statement

B급 기기 (가정용 방송통신기자재)

이 기기는 가정용(B급) 전자파적합기기로서 주로 가정에서 사용하는 것을 목적으로 하며, 모든 지역에서 사용할 수 있습니다.

REACH

Complying with the REACH (Registration, Evaluation, Authorisation, and Restriction of Chemicals) regulatory framework, we published the chemical substances in our products at ASUS REACH website at <http://csr.asus.com/english/REACH.htm>.



DO NOT throw the motherboard in municipal waste. This product has been designed to enable proper reuse of parts and recycling. This symbol of the crossed out wheeled bin indicates that the product (electrical and electronic equipment) should not be placed in municipal waste. Check local regulations for disposal of electronic products.



DO NOT throw the mercury-containing button cell battery in municipal waste. This symbol of the crossed out wheeled bin indicates that the battery should not be placed in municipal waste.

ASUS Recycling/Takeback Services

ASUS recycling and takeback programs come from our commitment to the highest standards for protecting our environment. We believe in providing solutions for you to be able to responsibly recycle our products, batteries, other components as well as the packaging materials. Please go to <http://csr.asus.com/english/Takeback.htm> for detailed recycling information in different regions.

Regional notice for California



WARNING

Cancer and Reproductive Harm -
www.P65Warnings.ca.gov

Google™ License Terms

Copyright© 2018 Google Inc. All Rights Reserved.

Licensed under the Apache License, Version 2.0 (the “License”); you may not use this file except in compliance with the License. You may obtain a copy of the License at:

<http://www.apache.org/licenses/LICENSE-2.0>

Unless required by applicable law or agreed to in writing, software distributed under the License is distributed on an “AS IS” BASIS, WITHOUT WARRANTIES OR CONDITIONS OF ANY KIND, either express or implied.

See the License for the specific language governing permissions and limitations under the License.

English ASUSTeK Computer Inc. hereby declares that this device is in compliance with the essential requirements and other relevant provisions of related Directives. Full text of EU declaration of conformity is available at: www.asus.com/support

Français AsusTek Computer Inc. déclare par la présente que cet appareil est conforme aux critères essentiels et autres clauses pertinentes des directives concernées. La déclaration de conformité de l'UE peut être téléchargée à partir du site Internet suivant: www.asus.com/support

Deutsch ASUSTeK Computer Inc. erklärt hiermit, dass dieses Gerät mit den wesentlichen Anforderungen und anderen relevanten Bestimmungen der zugehörigen Richtlinien übereinstimmt. Der gesamte Text der EU-Konformitätserklärung ist verfügbar unter: www.asus.com/support

Italiano ASUSTeK Computer Inc. con la presente dichiara che questo dispositivo è conforme ai requisiti essenziali e alle altre disposizioni pertinenti con le direttive correlate. Il testo completo della dichiarazione di conformità UE è disponibile all'indirizzo: www.asus.com/support

Русский Компания ASUS заявляет, что это устройство соответствует основным требованиям и другим соответствующим условиям соответствующих директив. Подробную информацию, пожалуйста, смотрите на www.asus.com/support

Български С настоящото ASUSTeK Computer Inc. декларира, че това устройство е в съответствие със съществениите изисквания и другите приложими постановления на свързаните директиви. Пълният текст на декларацията за съответствие на ЕС е достъпен на адрес: www.asus.com/support

Hrvatski ASUSTeK Computer Inc. ovim izjavljuje da je ovaj uređaj sukladan s bitnim zahtjevima i ostalim odgovarajućim odredbama vezanih direktiva. Cijeli tekst EU izjave o sukladnosti dostupan je na: www.asus.com/support

Čeština Společnost ASUSTeK Computer Inc. tímto prohlašuje, že toto zařízení splňuje základní požadavky a další příslušná ustanovení souvisejících směrnic. Plné znění prohlášení o shodě EU je k dispozici na adrese: www.asus.com/support

Dansk ASUSTeK Computer Inc. erklærer hermed, at denne enhed er i overensstemmelse med hovedkravene og andre relevante bestemmelser i de relaterede direktiver. Hele EU-overensstemmelseserklæringen kan findes på: www.asus.com/support

Nederlands ASUSTeK Computer Inc. verklaart hierbij dat dit apparaat voldoet aan de essentiële vereisten en andere relevante bepalingen van de verwante richtlijnen. De volledige tekst van de EU-verklaring van conformiteit is beschikbaar op: www.asus.com/support

Eesti Käesolevaga kinnitab ASUSTeK Computer Inc, et see seade vastab asjakohaste direktiivide olulistele nõuetele ja teistele asjassepuutuvatele sätetele. El vastavusdeklaratsiooni täielik tekst on saadaval järgmisel aadressil: www.asus.com/support

Suomi ASUSTeK Computer Inc. ilmoittaa täten, että tämä laite on asiaankuuluvien direktiivien olennaisien vaatimusten ja muiden tätä koskevien säädösten mukainen. EU-yhdenmukaisuusilmoituksen koko teksti on luettavissa osoitteessa: www.asus.com/support

Ελληνικά Με το παρόν, η ASUSTeK Computer Inc. δηλώνει ότι αυτή η συσκευή συμμορφώνεται με τις θεμελιώδεις απαιτήσεις και άλλες σχετικές διατάξεις των Οδηγιών της ΕΕ. Το πλήρες κείμενο της δήλωσης συμμόρφωσης είναι διαθέσιμο στη διεύθυνση: www.asus.com/support

Magyar Az ASUSTeK Computer Inc. ezennel kijelenti, hogy ez az eszköz megfelel a kapcsolódó irányelvek lényeges követelményeinek és egyéb vonatkozó rendelkezéseinek. Az EU megfélelősegi nyilatkozat teljes szövege innen letölthető: www.asus.com/support

Latviski ASUSTeK Computer Inc. ar šo paziņo, ka šī ierīce atbilst saistošo Direktīvu būtiskajām prasībām un citiem citiem saistošajiem nosacījumiem. Pilns ES atbilstības paziņojuma teksts pieejams šeit: www.asus.com/support

Lietuvių „ASUSTeK Computer Inc.“ šiuo tvirtina, kad šis įrenginys atitinka pagrindinius reikalavimus ir kitas svarbias susijusių direktyvų nuostatas. Visą ES atitikties deklaracijos tekstą galima rasti: www.asus.com/support

Norsk ASUSTeK Computer Inc. erklærer herved at denne enheten er i samsvar med hovedsaklige krav og andre relevante forskrifter i relaterte direktiver. Fullstendig tekst for EU-samsvarserklæringen finnes på: www.asus.com/support

Polski Firma ASUSTeK Computer Inc. niniejszym oświadcza, że urządzenie to jest zgodne z zasadniczymi wymogami i innymi właściwymi postanowieniami powiązanych dyrektyw. Pełny tekst deklaracji zgodności UE jest dostępny pod adresem: www.asus.com/support

Português A ASUSTeK Computer Inc. declara que este dispositivo está em conformidade com os requisitos essenciais e outras disposições relevantes das Diretivas relacionadas. Texto integral da declaração da UE disponível em: www.asus.com/support

Română ASUSTeK Computer Inc. declară că acest dispozitiv se conformează cerințelor esențiale și altor prevederi relevante ale directivelor conexe. Textul complet al declarației de conformitate a Uniunii Europene se găsește la: www.asus.com/support

Srpski ASUSTeK Computer Inc. ovim izjavljuje da je ovaj uređaj u saglasnosti sa osnovnim zahtevima i drugim relevantnijim odredbama povezanih Direktiva. Pun tekst EU deklaracije o usaglasenosti je dostupan da adres: www.asus.com/support

Slovensky Spoločnosť ASUSTeK Computer Inc. týmto vyhlasuje, že toto zariadenie vyhovuje základným požiadavkám a ostatým príslušným ustanoveniam príslušných smerníc. Celý text vyhlásenia o zhode pre štáty EÚ je dostupný na adrese: www.asus.com/support

Slovenščina ASUSTeK Computer Inc. izjavlja, da je ta naprava skladna z bistvenimi zahtevami in drugimi ustreznimi določbami povezanih direktiv. Celotno besedilo EU-izjave o skladnosti je na voljo na spletnem mestu: www.asus.com/support

Español Por la presente, ASUSTeK Computer Inc. declara que este dispositivo cumple los requisitos básicos y otras disposiciones pertinentes de las directivas relacionadas. El texto completo de la declaración de la UE de conformidad está disponible en: www.asus.com/support

Svenska ASUSTeK Computer Inc. förklarar härmed att denna enhet överensstämmer med de grundläggande kraven och andra relevanta föreskrifter i relaterade direktiv. Fulltext av EU-försäkran om överensstämmelse finns på: www.asus.com/support

Українська ASUSTeK Computer Inc. заявляє, що цей пристрій відповідає основним вимогам та іншим відповідним положенням відповідних Директив. Повний текст декларації відповідності стандартам ЄС доступний на: www.asus.com/support

Türkçe ASUSTeK Computer Inc., bu aygıtın temel gereksinimlerle ve ilişkili Yönergelerin diğer ilgili kullarıyla uyumlu olduğunu beyan eder. AB uyuşluk bildirimini tam metni şu adreste bulunabilir: www.asus.com/support

Bosanski ASUSTeK Computer Inc. ovim izjavljuje da je ovaj uređaj uskladen sa bitnim zahtjevima i ostalim odgovarajućim odredbama vezanih direktiva. Cijeli tekst EU izjave o uskladenosti dostupan je na: www.asus.com/support

ASUS contact information

ASUSTeK COMPUTER INC.

Address 4F, No. 150, Li-Te Rd., Peitou, Taipei 112, Taiwan
Telephone +886-2-2894-3447
Fax +886-2-2890-7798
Web site <https://www.asus.com>

Technical Support

Telephone +86-21-38429911
Fax +86-21-58668722 ext: 9101
Online Support <https://www.asus.com/support/Product/ContactUs/Services/questionform/?lang=en>

ASUS COMPUTER INTERNATIONAL (America)

Address 800 Corporate Way, Fremont, CA 94539, USA
Telephone +1-510-739-3777
Fax +1-510-608-4555
Web site <https://www.asus.com/us/>

Technical Support

Support fax +1-812-284-0883
Telephone +1-812-282-2787
Online support <https://www.asus.com/support/Product/ContactUs/Services/questionform/?lang=en-us>

ASUS COMPUTER GmbH (Germany and Austria)

Address Harkort Str. 21-23, 40880 Ratingen, Germany
Fax +49-2102-959931
Web site <https://www.asus.com/de/>

Technical Support

Telephone +49-2102-5789555
Support Fax +49-2102-959911
Online support <https://www.asus.com/support/Product/ContactUs/Services/questionform/?lang=de-de>

DECLARATION OF CONFORMITY
Compliance Information Statement

Per FCC Part 2 Section 2. 1077(a)



Responsible Party Name: Asus Computer International

Address: 800 Corporate Way, Fremont, CA 94539.

Phone/Fax No: (510)739-3777/(510)608-4555

hereby declares that the product

Product Name : Motherboard

Model Number : TUF H370-PRO GAMING,
TUF B360-PRO GAMING,
TUF B360-PLUS GAMING

Conforms to the following specifications:

FCC Part 15, Subpart B, Unintentional Radiators

Supplementary Information:

This device complies with part 15 of the FCC Rules. Operation is subject to the following two conditions: (1) This device may not cause harmful interference, and (2) this device must accept any interference received, including interference that may cause undesired operation.