

**Z170-PRO**

**ASUS**<sup>®</sup>

**Motherboard**

**Copyright© 2015 ASUSTeK COMPUTER INC. All Rights Reserved.**

No part of this manual, including the products and software described in it, may be reproduced, transmitted, transcribed, stored in a retrieval system, or translated into any language in any form or by any means, except documentation kept by the purchaser for backup purposes, without the express written permission of ASUSTeK COMPUTER INC. ("ASUS").

Product warranty or service will not be extended if: (1) the product is repaired, modified or altered, unless such repair, modification of alteration is authorized in writing by ASUS; or (2) the serial number of the product is defaced or missing.

ASUS PROVIDES THIS MANUAL "AS IS" WITHOUT WARRANTY OF ANY KIND, EITHER EXPRESS OR IMPLIED, INCLUDING BUT NOT LIMITED TO THE IMPLIED WARRANTIES OR CONDITIONS OF MERCHANTABILITY OR FITNESS FOR A PARTICULAR PURPOSE. IN NO EVENT SHALL ASUS, ITS DIRECTORS, OFFICERS, EMPLOYEES OR AGENTS BE LIABLE FOR ANY INDIRECT, SPECIAL, INCIDENTAL, OR CONSEQUENTIAL DAMAGES (INCLUDING DAMAGES FOR LOSS OF PROFITS, LOSS OF BUSINESS, LOSS OF USE OR DATA, INTERRUPTION OF BUSINESS AND THE LIKE), EVEN IF ASUS HAS BEEN ADVISED OF THE POSSIBILITY OF SUCH DAMAGES ARISING FROM ANY DEFECT OR ERROR IN THIS MANUAL OR PRODUCT.

SPECIFICATIONS AND INFORMATION CONTAINED IN THIS MANUAL ARE FURNISHED FOR INFORMATIONAL USE ONLY, AND ARE SUBJECT TO CHANGE AT ANY TIME WITHOUT NOTICE, AND SHOULD NOT BE CONSTRUED AS A COMMITMENT BY ASUS. ASUS ASSUMES NO RESPONSIBILITY OR LIABILITY FOR ANY ERRORS OR INACCURACIES THAT MAY APPEAR IN THIS MANUAL, INCLUDING THE PRODUCTS AND SOFTWARE DESCRIBED IN IT.

Products and corporate names appearing in this manual may or may not be registered trademarks or copyrights of their respective companies, and are used only for identification or explanation and to the owners' benefit, without intent to infringe.

**Offer to Provide Source Code of Certain Software**

This product contains copyrighted software that is licensed under the General Public License ("GPL"), under the Lesser General Public License Version ("LGPL") and/or other Free Open Source Software Licenses. Such software in this product is distributed without any warranty to the extent permitted by the applicable law. Copies of these licenses are included in this product.

Where the applicable license entitles you to the source code of such software and/or other additional data, you may obtain it for a period of three years after our last shipment of the product, either

(1) for free by downloading it from <http://support.asus.com/download>

or

(2) for the cost of reproduction and shipment, which is dependent on the preferred carrier and the location where you want to have it shipped to, by sending a request to:

ASUSTeK Computer Inc.  
Legal Compliance Dept.  
15 Li Te Rd.,  
Beitou, Taipei 112  
Taiwan

In your request please provide the name, model number and version, as stated in the About Box of the product for which you wish to obtain the corresponding source code and your contact details so that we can coordinate the terms and cost of shipment with you.

The source code will be distributed WITHOUT ANY WARRANTY and licensed under the same license as the corresponding binary/object code.

This offer is valid to anyone in receipt of this information.

ASUSTeK is eager to duly provide complete source code as required under various Free Open Source Software licenses. If however you encounter any problems in obtaining the full corresponding source code we would be much obliged if you give us a notification to the email address [gpl@asus.com](mailto:gpl@asus.com), stating the product and describing the problem (please DO NOT send large attachments such as source code archives, etc. to this email address).

# Contents

Safety information.....	vi
About this guide.....	vii
Z170-PRO specifications summary.....	ix
Package contents.....	xvi
Installation tools and components.....	xvii

## Chapter 1: Product Introduction

1.1	Special features.....	1-1
1.1.1	Product highlights.....	1-1
1.1.2	Other special features.....	1-2
1.2	Motherboard overview.....	1-3
1.2.1	Before you proceed.....	1-3
1.2.2	Motherboard layout.....	1-4
1.2.3	Central Processing Unit (CPU).....	1-6
1.2.4	System memory.....	1-7
1.2.5	Expansion slots.....	1-17
1.2.6	Onboard buttons and switches.....	1-19
1.2.7	Jumpers.....	1-20
1.2.8	Onboard LEDs.....	1-22
1.2.9	Internal connectors.....	1-23

## Chapter 2: Basic Installation

2.1	Building your PC system.....	2-1
2.1.1	Motherboard installation.....	2-1
2.1.2	CPU installation.....	2-3
2.1.3	CPU heatsink and fan assembly installation.....	2-5
2.1.4	DIMM installation.....	2-7
2.1.5	ATX Power connection.....	2-8
2.1.6	SATA device connection.....	2-9
2.1.7	Front I/O Connector.....	2-10
2.1.8	Expansion Card installation.....	2-11
2.2	Motherboard rear and audio connections.....	2-12
2.2.1	Rear I/O connection.....	2-12
2.2.2	Audio I/O connections.....	2-14
2.3	Starting up for the first time.....	2-16
2.4	Turning off the computer.....	2-16

## Chapter 3: BIOS Setup

<b>3.1</b>	<b>Knowing BIOS</b> .....	<b>3-1</b>
<b>3.2</b>	<b>BIOS setup program</b> .....	<b>3-2</b>
	3.2.1 EZ Mode.....	3-3
	3.2.2 Advanced Mode .....	3-4
	3.2.3 QFan Control.....	3-7
	3.2.4 EZ Tuning Wizard .....	3-9
<b>3.3</b>	<b>My Favorites</b> .....	<b>3-12</b>
<b>3.4</b>	<b>Main menu</b> .....	<b>3-14</b>
<b>3.5</b>	<b>Ai Tweaker menu</b> .....	<b>3-16</b>
<b>3.6</b>	<b>Advanced menu</b> .....	<b>3-31</b>
	3.6.1 CPU Configuration .....	3-32
	3.6.2 Platform Misc Configuration .....	3-34
	3.6.3 System Agent (SA) Configuration .....	3-35
	3.6.4 PCH Configuration .....	3-36
	3.6.5 PCH Storage Configuration.....	3-37
	3.6.6 USB Configuration .....	3-39
	3.6.7 Network Stack Configuration.....	3-40
	3.6.8 Onboard Devices Configuration .....	3-40
	3.6.9 APM Configuration .....	3-42
	3.6.10 HDD/SSD SMART Information .....	3-43
	3.6.11 Intel(R) Thunderbolt Configuration.....	3-44
<b>3.7</b>	<b>Monitor menu</b> .....	<b>3-47</b>
<b>3.8</b>	<b>Boot menu</b> .....	<b>3-53</b>
<b>3.9</b>	<b>Tool menu</b> .....	<b>3-58</b>
	3.9.1 ASUS EZ Flash 3 Utility .....	3-58
	3.9.2 Secure Erase .....	3-58
	3.9.3 ASUS Overclocking Profile .....	3-60
	3.9.4 ASUS SPD Information .....	3-61
	3.9.5 Graphics Card Information .....	3-61
<b>3.10</b>	<b>Exit menu</b> .....	<b>3-62</b>
<b>3.11</b>	<b>Updating BIOS</b> .....	<b>3-63</b>
	3.11.1 EZ Update .....	3-63
	3.11.2 ASUS EZ Flash 3 .....	3-64
	3.11.3 ASUS CrashFree BIOS 3 .....	3-66

<b>Chapter 4:</b>	<b>Software Support</b>	
<b>4.1</b>	<b>Installing an operating system</b>	<b>4-1</b>
4.1.1	Windows® 7 and USB 3.0 driver for 100 Series	4-1
<b>4.2</b>	<b>Support DVD information</b>	<b>4-8</b>
4.2.1	Running the support DVD	4-8
4.2.2	Obtaining the software manuals	4-9
<b>4.3</b>	<b>Software information</b>	<b>4-10</b>
<b>4.4</b>	<b>AI Suite 3</b>	<b>4-10</b>
4.4.1	Ai Charger	4-14
4.4.2	USB 3.1 Boost	4-15
4.4.3	EZ Update	4-16
4.4.4	Push Notice	4-18
4.4.5	System Information	4-21
<b>4.5</b>	<b>Audio configurations</b>	<b>4-23</b>
<b>Chapter 5:</b>	<b>RAID Support</b>	
<b>5.1</b>	<b>RAID configurations</b>	<b>5-1</b>
5.1.1	RAID definitions	5-1
5.1.2	Installing Serial ATA hard disks	5-2
5.1.3	Setting the RAID item in BIOS	5-2
5.1.4	Intel® Rapid Storage Technology Option ROM utility	5-3
<b>5.2</b>	<b>Creating a RAID driver disk</b>	<b>5-7</b>
5.2.1	Creating a RAID driver disk in Windows®	5-7
5.2.2	Installing the RAID driver during Windows® OS installation	5-8
<b>Appendix</b>		
	<b>Notices</b>	<b>A-1</b>
	<b>ASUS contact information</b>	<b>A-5</b>

# Safety information

## Electrical safety

- To prevent electrical shock hazard, disconnect the power cable from the electrical outlet before relocating the system.
- When adding or removing devices to or from the system, ensure that the power cables for the devices are unplugged before the signal cables are connected. If possible, disconnect all power cables from the existing system before you add a device.
- Before connecting or removing signal cables from the motherboard, ensure that all power cables are unplugged.
- Seek professional assistance before using an adapter or extension cord. These devices could interrupt the grounding circuit.
- Ensure that your power supply is set to the correct voltage in your area. If you are not sure about the voltage of the electrical outlet you are using, contact your local power company.
- If the power supply is broken, do not try to fix it by yourself. Contact a qualified service technician or your retailer.

## Operation safety

- Before installing the motherboard and adding devices on it, carefully read all the manuals that came with the package.
- Before using the product, ensure all cables are correctly connected and the power cables are not damaged. If you detect any damage, contact your dealer immediately.
- To avoid short circuits, keep paper clips, screws, and staples away from connectors, slots, sockets and circuitry.
- Avoid dust, humidity, and temperature extremes. Do not place the product in any area where it may become wet.
- Place the product on a stable surface.
- If you encounter technical problems with the product, contact a qualified service technician or your retailer.

## About this guide

This user guide contains the information you need when installing and configuring the motherboard.

## How this guide is organized

This guide contains the following parts:

### 1. Chapter 1: Product Introduction

This chapter describes the features of the motherboard and the new technology it supports. It includes description of the switches, jumpers, and connectors on the motherboard.

### 2. Chapter 2: Basic Installation

This chapter lists the hardware setup procedures that you have to perform when installing system components.

### 3. Chapter 3: BIOS Setup

This chapter tells how to change system settings through the BIOS Setup menus. Detailed descriptions of the BIOS parameters are also provided.

### 4. Chapter 4: Software Support

This chapter describes the contents of the support DVD that comes with the motherboard package and the software.

### 5. Chapter 5: RAID Support

This chapter describes the RAID configurations.

## Where to find more information

Refer to the following sources for additional information and for product and software updates.

### 1. ASUS website

The ASUS website ([www.asus.com](http://www.asus.com)) provides updated information on ASUS hardware and software products.

### 2. Optional documentation

Your product package may include optional documentation, such as warranty flyers, that may have been added by your dealer. These documents are not part of the standard package.

## Conventions used in this guide

To ensure that you perform certain tasks properly, take note of the following symbols used throughout this manual.



**DANGER/WARNING:** Information to prevent injury to yourself when trying to complete a task.



**CAUTION:** Information to prevent damage to the components when trying to complete a task.



**IMPORTANT:** Instructions that you **MUST** follow to complete a task.



**NOTE:** Tips and additional information to help you complete a task.

## Typography

**Bold text**

Indicates a menu or an item to select.

*Italics*

Used to emphasize a word or a phrase.

<Key>

Keys enclosed in the less-than and greater-than sign means that you must press the enclosed key.

Example: <Enter> means that you must press the Enter or Return key.

<Key1> + <Key2> + <Key3>

If you must press two or more keys simultaneously, the key names are linked with a plus sign (+).



## Z170-PRO specifications summary

<p><b>CPU</b></p>	<p>LGA1151 socket for 6th Generation Intel® Core™ i7/ i5/ i3/Pentium®/Celeron® Processors</p> <p>Supports 14nm CPU</p> <p>Supports Intel® Turbo Boost Technology 2.0*</p> <p><b>* The Intel® Turbo Boost Technology 2.0 support depends on the CPU types.</b></p>
<p><b>Chipset</b></p>	<p>Intel® Z170 Express Chipset</p>
<p><b>Memory</b></p>	<p>4 x DIMM, max. 64GB, DDR4 3866(O.C.)* / 3800(O.C.)* / 3733(O.C.) * / 3600(O.C.)* / 3466(O.C.)* / 3400(O.C.)* / 3333(O.C.)* / 3300(O.C.)* / 3200(O.C.)* / 3000(O.C.)* / 2800(O.C.)* / 2666(O.C.)* / 2400(O.C.)* / 2133 MHz, non-ECC, un-buffered memory</p> <p>Dual channel memory architecture</p> <p>Supports Intel® Extreme Memory Profile (XMP)</p> <p><b>* Hyper DIMM support is subject to the physical characteristics of individual CPUs. Please refer to Memory QVL(Qualified Vendors List) for details.</b></p>
<p><b>Expansion slots</b></p>	<p>2 x PCI Express 3.0/2.0 x16 slots (single at x16 or dual at x8/x8 mode)</p> <p>1 x PCI Express 3.0/2.0 x16 slot* (max. at x4 mode, compatible with PCIe x1, x2 and x4 devices)</p> <p>4 x PCI Express 2.0 x1 slots</p> <p><b>* The PCIe x16_3 slot shares bandwidth with SATA6G_56. The PCIe x16_3 is default set at x2 mode.</b></p>
<p><b>VGA</b></p>	<p>Integrated Graphics Processor- Intel® HD Graphics support</p> <p>Multi-VGA output support: DisplayPort/HDMI/DVI-D ports</p> <p>Supports DisplayPort 1.2* with max. resolution 4096 x 2160@24Hz / 3840 x 2160@60Hz</p> <p>Supports HDMI 1.4b with max. resolution 4096 x 2160@24Hz / 2560 x 1600@60Hz</p> <p>Supports DVI-D with max. resolution 1920 x 1200@60Hz</p> <p>Supports Intel® InTru™ 3D/Quick Sync Video/Clear Video HD Technology/ Insider™</p> <p>Supports up to 3 displays simultaneously</p> <p>Maximum shared memory of 512MB</p> <p><b>* DP 1.2 Multi-Stream Transport compliant, supports DP 1.2 monitor daisy chain up to 3 displays</b></p>
<p><b>Multi-GPU support</b></p>	<p>Supports NVIDIA® 2-Way/Quad-GPU SLI™ Technology (with 2 PCIe x16 graphics card)</p> <p>Supports AMD® 3-Way/Quad-GPU CrossFireX™ Technology</p>

*(continued on the next page)*

## Z170-PRO specifications summary

<p><b>Storage</b></p>	<p><b>Intel® Z170 Express Chipset with RAID 0, 1, 5, 10 and Intel Rapid Storage Technology 14 support*</b></p> <ul style="list-style-type: none"> <li>- 1 x SATA Express port (compatible with 2 x SATA 6.0 Gb/s ports)</li> <li>- 1 x M.2 Socket 3 with M Key, type 2242/2260/2280/22110 storage devices support (both SATA &amp; PCIe mode)**</li> <li>- 6 x SATA 6.0 Gb/s ports (gray, 2 from SATA Express)</li> <li>- Supports Intel® Smart Response Technology***</li> </ul> <p>* Supports PCIe RAID configurations via onboard M.2 and PCIe16_3 slot storages.</p> <p>** The M.2 socket shares SATA ports with SATA Express. Adjust BIOS settings to use an M.2 SATA device.</p> <p>*** These functions will work depending on the CPU installed.</p>
<p><b>LAN</b></p>	<p>Gigabit Intel LAN connection - 802.3az Energy Efficient Ethernet (EEE) appliance</p> <p>Intel® I219-V Gigabit LAN- Dual interconnect between the integrated Media Access Controller (MAC) and physical layer (PHY)</p> <p>ASUS Turbo LAN Utility</p>
<p><b>Audio</b></p>	<p>Realtek® ALC1150 8-channel high definition audio CODEC featuring Crystal Sound 3</p> <ul style="list-style-type: none"> <li>- Power pre-regulator reduces power input noise to ensure consistent performance</li> <li>- Separate layer for left and right track, ensuring both sound deliver equal quality</li> <li>- Top notch audio sensation delivers according to the audio configuration</li> <li>- Audio shielding ensures precise analog/digital separation and greatly reduced multi-lateral interference</li> <li>- Unique de-pop circuit to reduce start-up popping noise to audio outputs</li> <li>- EMI protection cover to prevent electrical noise from affecting the amplifier quality</li> <li>- Audio Amplifier to enhance the highest quality sound for headphones and speakers</li> <li>- Premium Japan-made audio capacitors provides warm, natural, and immersive sound with exceptional clarity and fidelity</li> <li>- High quality 112dB SNR stereo playback output (Line-out@back) &amp; 104dB SNR recording input (Line-in) support</li> <li>- Absolute Pitch 192khz/24bit true BD lossless sound</li> <li>- BD audio layer content protection</li> <li>- DTS® Studio Sound™</li> <li>- DTS® Connect</li> <li>- Supports jack-detection, multi-streaming, front panel jack-retasking (MIC)</li> <li>- Optical S/PDIF out port at back I/O</li> </ul>

*(continued on the next page)*

# Z170-PRO specifications summary

<b>USB</b>	<p>Intel® Z170 Express Chipset- supports ASUS USB 3.1 Boost</p> <ul style="list-style-type: none"><li>- 6 x USB 3.0/2.0 ports (4 ports @mid-board, 2 ports @back panel, blue)</li><li>- 6 x USB 2.0/1.1 ports (4 ports @mid-board, 2 ports @back panel, black)</li></ul> <p>Intel® USB 3.1 controller - supports ASUS USB 3.1 Boost and 3A power output</p> <ul style="list-style-type: none"><li>- 1 x USB 3.1/3.0/2.0 port @back panel (teal blue, Type A)</li><li>- 1 x USB 3.1/3.0/2.0 port @back panel (Type C)</li></ul>
<b>ASUS Exclusive Features</b>	<p><b>Superb Performance</b></p> <p><b>OC Design: ASUS PRO Clock Technology</b></p> <ul style="list-style-type: none"><li>- Full BCLK range for extreme overclocking performance</li></ul> <p><b>5-Way Optimization</b></p> <ul style="list-style-type: none"><li>- Whole system optimization with a single click! Perfectly consolidates better CPU performance, power saving, digital power control, system cooling and app usages.</li></ul> <p><b>DIGI+ Power Control</b></p> <ul style="list-style-type: none"><li>- CPU Power: Digital 8-phase power design</li><li>- iGPU Power: Digital 2-phase power design</li></ul> <p><b>TPU</b></p> <ul style="list-style-type: none"><li>- Auto Tuning, GPU Boost</li></ul> <p><b>EPU</b></p> <ul style="list-style-type: none"><li>- EPU</li></ul> <p><b>Fan Xpert 3</b> featuring Fan Auto Tuning function and multiple thermistors selection for optimized system cooling control</p> <p><b>Turbo App</b> featuring system performance tuning, network priority, and audio scene configuration for selected applications</p> <p><b>UEFI BIOS</b></p> <ul style="list-style-type: none"><li>- Most advanced options with fast response time</li></ul> <p><b>Special Memory O.C. Design</b></p> <ul style="list-style-type: none"><li>- Superb memory O.C. capability under full load by minimizing the coupling noise and signal reflection effect</li></ul> <p><b>PC Cleaner</b></p> <ul style="list-style-type: none"><li>- Fast and easy way to get rid of unnecessary junk files</li></ul> <p><b>Remote Entertainment</b></p> <p><b>Remote GO!</b></p> <ul style="list-style-type: none"><li>- Remote GO! Function: Cloud GO!, Remote Desktop, Remote Keyboard &amp; Mouse, File Transfer</li><li>- Wi-Fi GO! &amp; NFC Remote app for portable smartphone/tablet, supporting iOS 7 &amp; Android 4.0 systems</li></ul>

*(continued on the next page)*

## Z170-PRO specifications summary

### ASUS Exclusive Features

#### **Media Streamer**

- Pipe music or movies from your PC to a smart TV, your entertainment goes wherever you go!
- Media Streamer app for portable smartphone/tablet, supporting iOS 7 & Android 4.0 systems

#### **HyStream**

- Stream Android/iOS/Windows devices' screen on your PC screen\*

\* Contact your device vendor for supporting information.

#### **eSports Champions**

##### **Turbo LAN**

- Fast and smooth online gaming with lower pings and less lags

##### **Crystal Sound 3**

- Hear the cleanest sound with dedicated audio design onboard!

##### **Turbo APP**

- Tailored app performance, network priority and audio configuration for your needs

#### **EZ DIY**

##### **Push Notice**

- Monitor your PC status with smart devices in real time

##### **UEFI BIOS EZ Mode** featuring friendly graphics user interface

- CrashFree BIOS 3
- EZ Flash 3

##### **Q-Design**

- ASUS Q-Shield
- ASUS Q-LED (CPU, DRAM, VGA, Boot Device LED)
- ASUS Q-Slot
- ASUS Q-DIMM
- ASUS Q-Connector

*(continued on the next page)*

# Z170-PRO specifications summary

<b>ASUS Special Features</b>	<b>ASUS 5X Protection II:</b> <ul style="list-style-type: none"><li>- ASUS LANGuard - Protects against LAN surges, lightning strikes and static-electricity discharges!</li><li>- ASUS Overvoltage Protection - World-class circuit-protecting power design</li><li>- ASUS DIGI+ VRM - 8+2 Phase digital power design</li><li>- ASUS DRAM Overcurrent Protection: Enhanced DRAM overcurrent protection</li><li>- ASUS Stainless-Steel Back I/O: 3X corrosion-resistance for greater durability!</li></ul> AI suite 3 Mobo Connect USB 3.1 Boost Ai Charger MemOK!
<b>ASUS Quiet Thermal Solution</b>	<b>Quiet Thermal Design</b> <ul style="list-style-type: none"><li>- ASUS Fan Xpert 3</li><li>- ASUS Fanless Design: Heat-sink solution</li></ul>
<b>ASUS Exclusive Overclocking Features</b>	<b>Precision Tweaker 2</b> <ul style="list-style-type: none"><li>- CPU Core/Cache Voltage: Adjustable CPU Core/Cache Voltage at 0.005V increment</li><li>- CPU Graphics Voltage: Adjustable CPU Graphics voltage at 0.005V increment</li><li>- CPU VCCIO Voltage: Adjustable CPU VCCIO Voltage at 0.0125V increment</li><li>- CPU System Agent Voltage: Adjustable CPU System Agent Voltage at 0.0125V increment</li><li>- DRAM Voltage: 200-step Memory voltage control</li><li>- PCH Core Voltage: 88-step Chipset voltage control</li></ul> <b>SFS (Stepless Frequency Selection)</b> <ul style="list-style-type: none"><li>- BCLK/PCIE frequency tuning from 40MHz up to 500MHz at 0.01MHz increment</li></ul> <b>Overclocking Protection:</b> <ul style="list-style-type: none"><li>- ASUS C.P.R.(CPU Parameter Recall)</li></ul>

*(continued on the next page)*

## Z170-PRO specifications summary

<b>Rear Panel I/O Ports</b>	<ul style="list-style-type: none"> <li>1 x DisplayPort</li> <li>1 x HDMI port</li> <li>1 x DVI-D</li> <li>1 x Optical S/PDIF out</li> <li>1 x Intel LAN (RJ45) port</li> <li>1 x USB 3.1/3.0/2.0 port (teal blue, Type A)</li> <li>1 x USB 3.1/3.0/2.0 port (Type C)</li> <li>2 x USB 3.0/2.0 ports (blue)</li> <li>2 x USB 2.0 ports</li> <li>8-channel Audio I/O ports</li> </ul>
<b>Internal I/O connectors</b>	<ul style="list-style-type: none"> <li>2 x USB 3.0/2.0 connectors support additional 4 USB ports (19-pin)</li> <li>2 x USB 2.0/1.1 connectors support additional 4 USB ports</li> <li>1 x M.2 Socket 3 (for M Key, type 2242/2260/2280/22110 devices)</li> <li>1 x SATA Express connector</li> <li>4 x SATA 6.0Gb/s connectors (gray)</li> <li>1 x CPU Fan connector (4-pin) for both 3-pin(DC mode) and 4-pin(PWM mode) CPU coolers control with auto detection support</li> <li>1 x CPU OPT Fan connector (4-pin)</li> <li>1 x Water Pump header (4-pin)</li> <li>2 x Chassis Fan connectors (4-pin) for both 3-pin(DC mode) and 4-pin(PWM mode) coolers control</li> <li>1 x Front panel audio connector (AAFP)</li> <li>1 x S/PDIF out header</li> <li>1 x Thunderbolt header (5-pin) for ASUS ThunderboltEX series support</li> <li>1 x TPM connector</li> <li>1 x 24-pin EATX Power connector</li> <li>1 x 8-pin EATX 12V Power connector</li> <li>1 x System Panel(Q-Connector)</li> <li>1 x MemOK! button</li> <li>1 x CPU OV jumper</li> <li>1 x Clear CMOS header</li> <li>1 x DRCT(Direct Key) header</li> <li>1 x 5-pin EXT_FAN(Extension Fan) connector</li> </ul>
<b>BIOS Features</b>	<p>128 Mb Flash ROM, UEFI AMI BIOS, PnP, DMI3.0, WfM2.0, SM BIOS 3.0, ACPI 5.0, Multi-language BIOS, ASUS EZ Flash 3, CrashFree BIOS 3, F11 EZ Tuning Wizard, F6 Qfan Control, F3 My Favorites, Quick Note, Last Modified log, F12 PrintScreen and ASUS DRAM SPD (Serial Presence Detect) memory information</p>

*(continued on the next page)*

## Z170-PRO specifications summary

<b>Manageability</b>	WfM 2.0, DMI 3.0, WOL by PME, PXE
<b>Accessories</b>	4 x Serial ATA 6.0Gb/s cables 1 x ASUS SLI bridge connector 1 x ASUS Q-Shield 1 x Q-connector 1 x M.2 screw package 1 x CPU Installation Tool 1 x User's Manual 1 x Z170 Series Exclusive Feature manual
<b>Support DVD contents</b>	Drivers ASUS Utilities EZ Update Anti-virus software (OEM version)
<b>Operating system support</b>	Windows® 10* Windows® 8.1* Windows® 7  * <b>64-bit supported only.</b>
<b>Form factor</b>	ATX Form Factor, 12" x 9.6" (30.5 cm x 24.4 cm)



---

Specifications are subject to change without notice.

---

# Package contents

Check your motherboard package for the following items.

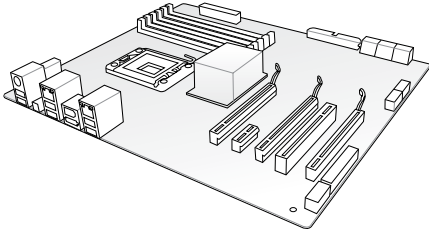

ASUS Z170-PRO Series motherboard



1 x M.2 screws

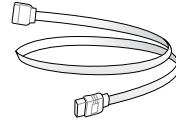

4 x Serial ATA 6 Gb/s cables

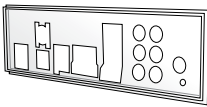

1 x ASUS Q-Shield

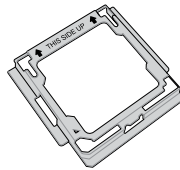

1 x CPU Installation Tool

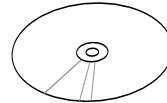

Support DVD

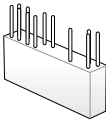

1 x ASUS Q-Connector kit



1 x ASUS SLI™ bridge connector



User manual



- 
- If any of the above items is damaged or missing, contact your retailer.
  - The illustrated items above are for reference only. Actual product specifications may vary with different models.
  - CPU Installation Tool & Q-Connector are in the color box package only.
-



# Installation tools and components

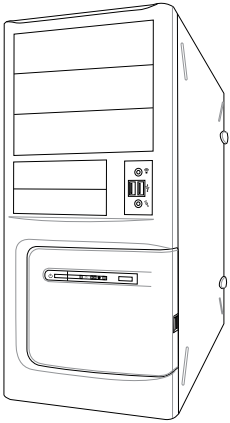

PC chassis

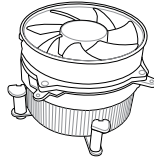

Intel® LGA1151 compatible CPU Fan

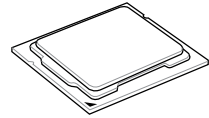

Intel® LGA1151 CPU

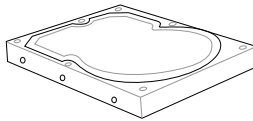

SATA hard disk drive



Phillips (cross) screwdriver

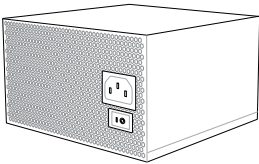

Power supply unit

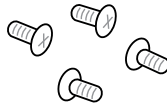

1 bag of screws

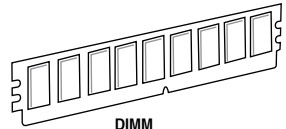

DIMM

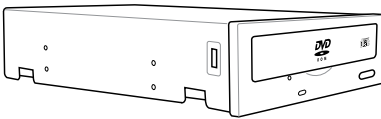

SATA optical disc drive (optional)

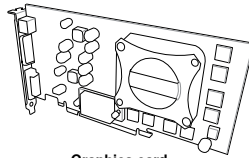

Graphics card



---

The tools and components above are not included in the motherboard package.

---



# Product Introduction

# 1

## 1.1 Special features

### 1.1.1 Product highlights

#### **LGA1151 socket for the 6th Generation Intel® Core™ i7/Intel® Core™ i5/Intel® Core™ i3, Pentium® and Celeron® processors**

This motherboard supports 6th generation Intel® Core™ i7/Intel® Core™ i5/Intel® Core™ i3, Pentium®, and Celeron® processors in the LGA1151 package. It provides great graphics and system performance with its GPU, dual-channel DDR4 memory slots and PCI Express 2.0/3.0 expansion slots.

#### **Intel® Z170 Express Chipset**

Intel® Z170 Express Chipset is a single chipset that supports the LGA1151 socket for the 6th generation Intel® Core™ i7/Intel® Core™ i5/Intel® Core™ i3, Pentium®, and Celeron® processors. It utilizes the serial point-to-point links, which increases bandwidth and enhances the system's performance. It natively supports up to ten USB 3.0 ports, six SATA 6 Gb/s ports, and M.2 Gen 3 X4 support for faster data retrieval.

#### **PCI Express® 3.0**

PCI Express® 3.0 (PCIe 3.0) is the PCI Express bus standard that provides twice the performance and speed of PCIe 2.0. It provides an optimal graphics performance, unprecedented data speed and seamless transition with its complete backward compatibility to PCIe 1.0/2.0 devices.

#### **Quad-GPU SLI and 3-WAY CrossFireX™ Support**

This motherboard features NVIDIA SLI and 3-Way AMD CrossfireX support that enables multi-GPU setup, giving you the full power of the latest graphics technologies. It also features native support for 4K/UHD (ultra high definition) resolution of up to 4096 x 2160 via HDMI or DisplayPort, resulting to four times the number of pixels for incredible visual clarity, detail, and realism.

#### **SATA Express support**

SATA Express provides faster data transfer speeds of up to 10 Gb/s, allowing your system to catch up with the speed of the SSDs. It also features backward compatibility with up to two SATA drives of the same speed.

## Dual-Channel DDR4 3866 MHz Support

The motherboard supports the dual-channel DDR4 memory that features data transfer rates of DDR4 3866 MHz to boost the system's performance, and to meet the higher bandwidth requirements of 3D graphics, multimedia and Internet applications.

## PCIe 3.0 x4 M.2 Support

With a 4x PCI Express 3.0/2.0 bandwidth, the M.2 can support up to 32 Gbit/s of data transfer speed. It is a perfect choice for the operating system or application drive, making your system and its installed apps work in a faster pace.

## Complete USB 3.1 integration

This motherboard has the latest USB 3.1 connectivity built in for the very fastest USB data transfers — that's up to 10 Gb/s, or twice as fast as USB 3.0. The next-generation standard is completely backward-compatible with your existing USB devices, and you'll be all set for USB 3.1's breakneck speeds.

### 1.1.2 Other special features

#### DTS Connect

To get the most out of your audio entertainment across all formats and quality levels, DTS Connect combines two enabling technologies, DTS Neo:PC™ upmixes stereo sources (CDs, MP3s, WMAs, internet radio) into as many as 7.1 channels of incredible surround sound. Consumers can connect their PC to a home theater system. DTS Interactive is capable of performing mult-channel encoding of DTS bitstreams on personal computers, and sending encoded bitstreams out of a digital audio connection (such as S/PDIF or HDMI) designed to deliver audio to an external decoder.

#### ErP Ready

The motherboard is European Union's Energy-related Products (ErP) ready, and ErP requires products to meet certain energy efficiency requirement in regards to energy consumptions. This is in line with ASUS vision of creating environment-friendly and energy-efficient products through product design and innovation to reduce carbon footprint of the product and thus mitigate environmental impacts.

## 1.2 Motherboard overview

### 1.2.1 Before you proceed

Take note of the following precautions before you install motherboard components or change any motherboard settings.



- 
- Unplug the power cord from the wall socket before touching any component.
  - Before handling components, use a grounded wrist strap or touch a safely grounded object or a metal object, such as the power supply case, to avoid damaging them due to static electricity.
  - Hold components by the edges to avoid touching the ICs on them.
  - Whenever you uninstall any component, place it on a grounded antistatic pad or in the bag that came with the component.
  - Before you install or remove any component, ensure that the ATX power supply is switched off or the power cord is detached from the power supply. Failure to do so may cause severe damage to the motherboard, peripherals, or components.
-



## Layout contents

Connectors/Jumpers/Buttons and switches/Slots	Page
1. ATX power connectors (24-pin EATXPWR, 8-pin EATX12V)	1-29
2. LGA1151 CPU socket	1-6
3. CPU, water pump, CPU optional, extension, and chassis fan connectors (4-pin CPU_FAN; 3-pin W_PUMP; 4-pin CPU_OPT; 5-pin EXT_FAN; 4-pin CHA_FAN1-2)	1-28
4. DDR4 DIMM slots	1-7
5. MemOK! button	1-19
6. USB 3.0 connectors (20-1 pin USB3_12, USB3_34)	1-26
7. Intel® Serial ATA 6 Gb/s connectors (7-pin SATA 6G_34; SATA 6G_56; SATAEXPRESS)	1-23
8. M.2 Socket 3	1-32
9. System panel connector (20-5 pin PANEL)	1-30
10. Clear RTC RAM (2-pin CLRRTC)	1-20
11. DirectKey connector (2-pin DRCT)	1-31
12. USB 2.0 connectors (10-1 pin USB1112; USB1314)	1-27
13. Thunderbolt header (5-pin TB_HEADER)	1-25
14. TPM connector (14-1 pin TPM)	1-31
15. T_Sensor connector (2-pin T_SENSOR)	1-24
16. Front panel audio connector (10-1 pin AAFP)	1-25
17. Digital audio connector (4-1 pin SPDIF_OUT)	1-24
18. CPU Over Voltage jumper (3-pin CPU_OV)	1-21

## 1.2.3 Central Processing Unit (CPU)

The motherboard comes with a surface mount LGA1151 socket designed for the 6th Generation Intel® Core™ i7 / Intel® Core™ i5 / Intel® Core™ i3, Pentium®, and Celeron® processors.

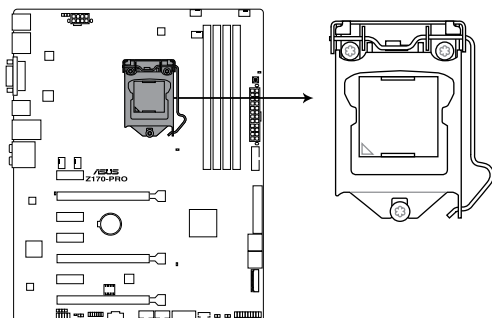

**Z170-PRO CPU LGA1151**



---

Ensure that you install the correct CPU designed for LGA1151 socket only. **DO NOT** install a CPU designed for other sockets on the LGA1151 socket.

---



- Ensure that all power cables are unplugged before installing the CPU.
  - Upon purchase of the motherboard, ensure that the PnP cap is on the socket and the socket contacts are not bent. Contact your retailer immediately if the PnP cap is missing, or if you see any damage to the PnP cap/socket contacts/motherboard components. ASUS will shoulder the cost of repair only if the damage is shipment/transit-related.
  - Keep the cap after installing the motherboard. ASUS will process Return Merchandise Authorization (RMA) requests only if the motherboard comes with the cap on the LGA1151 socket.
  - The product warranty does not cover damage to the socket contacts resulting from incorrect CPU installation/removal, or misplacement/loss/incorrect removal of the PnP cap.
-



## 1.2.4 System memory

The motherboard comes with four (4) Double Data Rate 4 (DDR4) Dual Inline Memory Modules (DIMM) slots.



A DDR4 module is notched differently from a DDR, DDR2, or DDR3 module. DO NOT install a DDR, DDR2, or DDR3 memory module to the DDR4 slot.

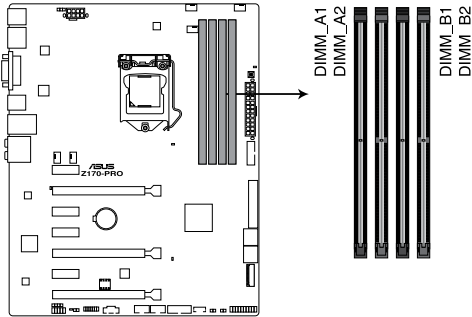

Z170-PRO 288-pin DDR4 DIMM socket

### Recommended memory configurations

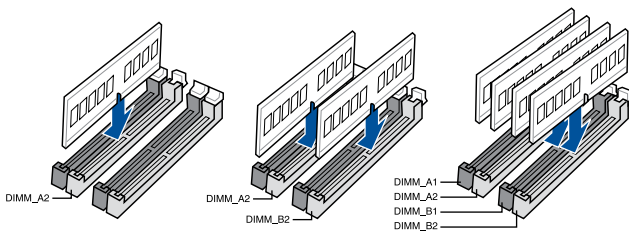

## Memory configurations

You may install 2 GB, 4 GB, 8 GB, and 16 GB unbuffered and non-ECC DDR4 DIMMs into the DIMM sockets.



- You may install varying memory sizes in Channel A and Channel B. The system maps the total size of the lower-sized channel for the dual-channel configuration. Any excess memory from the higher-sized channel is then mapped for single-channel operation.
- According to Intel® CPU spec, DIMM voltage below 1.65 V is recommended to protect the CPU.
- Due to the memory address limitation on 32-bit Windows® OS, when you install 4GB or more memory on the motherboard, the actual usable memory for the OS can be about 3GB or less. For effective use of memory, we recommend that you do any of the following:
  - a) Use a maximum of 3GB system memory if you are using a 32-bit Windows® OS.
  - b) Install a 64-bit Windows® OS when you want to install 4 GB or more on the motherboard.
  - c) For more details, refer to the Microsoft® support site at <http://support.microsoft.com/kb/929605/en-us>.
- This motherboard does not support DIMMs made up of 512 Mb (64 MB) chips or less (Memory chip capacity counts in Megabit, 8 Megabit/Mb = 1 Megabyte/MB).



- The default memory operation frequency is dependent on its Serial Presence Detect (SPD), which is the standard way of accessing information from a memory module. Under the default state, some memory modules for overclocking may operate at a lower frequency than the vendor-marked value. To operate at the vendor-marked or at a higher frequency, refer to section **3.5 Ai Tweaker menu** for manual memory frequency adjustment.
- For system stability, use a more efficient memory cooling system to support a full memory load (4 DIMMs) or overclocking condition.
- Always install the DIMMS with the same CAS Latency. For an optimum compatibility, we recommend that you install memory modules of the same version or data code (D/C) from the same vendor. Check with the vendor to get the correct memory modules.
- When running XMP at DDR4 3200 MHz or higher, the system's stability depends on the CPU's capabilities.

## Z170-PRO Motherboard Qualified Vendors Lists (QVL)

### DDR4 3866 (O.C.) MHz capability

Vendors	Part No.	Size	SS/DS	Chip Brand	Chip NO.	Timing	Voltage	DIMM socket support (Optional)		
								1	2	4
CORSAIR	CMK8GX4M2B3866C19 ver. 4.23	16GB(4GB*4)	SS	Samsung	K4A4G085WD	19-23-23-45	1.35V	•		

### DDR4 3800 (O.C.) MHz capability

Vendors	Part No.	Size	SS/DS	Chip Brand	Chip NO.	Timing	Voltage	DIMM socket support (Optional)		
								1	2	4
G.SKILL	F4-3800C18D-8GTZ	8GB(4GB*2)	SS	Samsung	K4A4G085WD	18-20-20-38	1.35V	•		
AVEXIR	AVD4UZ138001804G-2XXXX	8GB(4GB*2)	SS	Samsung	K4A4G085WD	18-20-20-40	1.35V	•		

### DDR4 3733 (O.C.) MHz capability

Vendors	Part No.	Size	SS/DS	Chip Brand	Chip NO.	Timing	Voltage	DIMM socket support (Optional)		
								1	2	4
G.SKILL	F4-3733C17D-8GRK	8GB(4GB*2)	SS	Samsung	K4A4G085WD	17-19-19-39	1.35V	•		
G.SKILL	F4-3733C17D-8GTZ	8GB(4GB*2)	SS	Samsung	K4A4G085WD	17-19-19-39	1.35V	•		
G.SKILL	F4-3733C17D-8GVK	8GB(4GB*2)	SS	Samsung	K4A4G085WD	17-19-19-39	1.35V	•		
G.SKILL	F4-3733C17D-16GRK	16GB(4GB*4)	SS	Samsung	K4A4G085WD	17-19-19-39	1.35V	•	•	
G.SKILL	F4-3733C17D-16GTZ	16GB(4GB*4)	SS	Samsung	K4A4G085WD	17-19-19-39	1.35V	•	•	
G.SKILL	F4-3733C17D-16GVK	16GB(4GB*4)	SS	Samsung	K4A4G085WD	17-19-19-39	1.35V	•	•	
AVEXIR	AVD4UZ137331804G-2XXXX	8GB(4GB*2)	SS	Samsung	K4A4G085WD	18-20-20-40	1.35V	•		

### DDR4 3600 (O.C.) MHz capability

Vendors	Part No.	Size	SS/DS	Chip Brand	Chip NO.	Timing	Voltage	DIMM socket support (Optional)		
								1	2	4
G.SKILL	F4-3600C17D-8GRK	8GB(4GB*2)	SS	Samsung	K4A4G085WD	17-18-18-38	1.35V	•		
G.SKILL	F4-3600C17D-8GTZ	8GB(4GB*2)	SS	Samsung	K4A4G085WD	17-18-18-38	1.35V	•		
G.SKILL	F4-3600C17D-8GVK	8GB(4GB*2)	SS	Samsung	K4A4G085WD	17-18-18-38	1.35V	•		
G.SKILL	F4-3600C17Q-16GRK	16GB(4GB*4)	SS	Samsung	K4A4G085WD	17-18-18-38	1.35V	•	•	
G.SKILL	F4-3600C17Q-16GTZ	16GB(4GB*4)	SS	Samsung	K4A4G085WD	17-18-18-38	1.35V	•	•	
G.SKILL	F4-3600C17Q-16GVK	16GB(4GB*4)	SS	Samsung	K4A4G085WD	17-18-18-38	1.35V	•	•	
CORSAIR	CMD8GX4M2B3600C18 ver. 4.23	16GB(4GB*4)	SS	Samsung	K4A4G085WD	18-19-19-39	1.35V	•		
CORSAIR	CMD16GX4M4B3600C18 ver. 4.23	16GB(4GB*4)	SS	Samsung	K4A4G085WD	18-19-19-39	1.35V	•	•	
AVEXIR	AVD4UZ136001804G-2XXXX	8GB(4GB*2)	SS	Samsung	K4A4G085WD	18-20-20-40	1.35V	•		
AVEXIR	AVD4UZ136001804G-4XXXX	16GB(4GB*4)	SS	Samsung	K4A4G085WD	18-20-20-40	1.35V	•	•	

## DDR4 3466 (O.C.) MHz capability

Vendors	Part No.	Size	SS/DS	Chip Brand	Chip NO.	Timing	Voltage	DIMM socket support (Optional)		
								1	2	4
G.SKILL	F4-3466C16D-8GRK	8GB(4GB*2)	SS	Samsung	K4A4G085WD	16-18-18-38	1.35V		•	
G.SKILL	F4-3466C16D-8GTZ	8GB(4GB*2)	SS	Samsung	K4A4G085WD	16-18-18-38	1.35V		•	
G.SKILL	F4-3466C16D-8GVK	8GB(4GB*2)	SS	Samsung	K4A4G085WD	16-18-18-38	1.35V		•	
G.SKILL	F4-3466C16Q-16GRK	16GB(4GB*4)	SS	Samsung	K4A4G085WD	16-18-18-38	1.35V		•	•
G.SKILL	F4-3466C16Q-16GTZ	16GB(4GB*4)	SS	Samsung	K4A4G085WD	16-18-18-38	1.35V		•	•
G.SKILL	F4-3466C16Q-16GVK	16GB(4GB*4)	SS	Samsung	K4A4G085WD	16-18-18-38	1.35V		•	•
CORSAIR	CMD16GX4M4B3466C18	16GB(4GB*4)	SS	Samsung	K4A4G085WD	18-19-19-39	1.35V		•	•
AVEXIR	AVD4UZ134661704G-2XXXX	8GB(4GB*2)	SS	Samsung	K4A4G085WD	17-18-18-38	1.35V		•	
AVEXIR	AVD4UZ134661704G-4XXXX	16GB(4GB*4)	SS	Samsung	K4A4G085WD	17-18-18-38	1.35V		•	•

## DDR4 3400 (O.C.) MHz capability

Vendors	Part No.	Size	SS/DS	Chip Brand	Chip NO.	Timing	Voltage	DIMM socket support (Optional)		
								1	2	4
G.SKILL	F4-3400C16D-16GRK	16GB(8GB*2)	DS	Samsung	K4A4G085WD	16-18-18-38	1.35V		•	
G.SKILL	F4-3400C16D-16GTZ	16GB(8GB*2)	DS	Samsung	K4A4G085WD	16-18-18-38	1.35V		•	
G.SKILL	F4-3400C16D-16GVK	16GB(8GB*2)	DS	Samsung	K4A4G085WD	16-18-18-38	1.35V		•	
G.SKILL	F4-3400C16D-32GRK	32GB(16GB*2)	DS	Samsung		16-18-18-38	1.35V		•	
G.SKILL	F4-3400C16D-32GTZ	32GB(16GB*2)	DS	Samsung		16-18-18-38	1.35V		•	
G.SKILL	F4-3400C16D-32GVK	32GB(16GB*2)	DS	Samsung		16-18-18-38	1.35V		•	
G.SKILL	F4-3400C16Q-16GRBD	16GB(4GB*4)	SS	Samsung	K4A4G085WD	16-18-18-38	1.35V		•	•
G.SKILL	F4-3400C16Q-16GRKD	16GB(4GB*4)	SS	Samsung	K4A4G085WD	16-16-16-36	1.35V		•	•
G.SKILL	F4-3400C16Q-16GRBD	16GB(4GB*4)	SS	Samsung	K4A4G085WD	16-18-18-38	1.35V		•	•
G.SKILL	F4-3400C16Q-32GRK	32GB(8GB*4)	DS	Samsung	K4A4G085WD	16-18-18-38	1.35V		•	•
G.SKILL	F4-3400C16Q-32GTZ	32GB(8GB*4)	DS	Samsung	K4A4G085WD	16-18-18-38	1.35V		•	•
G.SKILL	F4-3400C16Q-32GVK	32GB(8GB*4)	DS	Samsung	K4A4G085WD	16-18-18-38	1.35V		•	•
G.SKILL	F4-3400C16Q-64GRK	64GB(16GB*4)	DS	Samsung		16-18-18-38	1.35V		•	•
G.SKILL	F4-3400C16Q-64GTZ	64GB(16GB*4)	DS	Samsung		16-18-18-38	1.35V		•	•
G.SKILL	F4-3400C16Q-64GVK	64GB(16GB*4)	DS	Samsung		16-18-18-38	1.35V		•	•
CORSAIR	CMD16GX4M4B3400C16 ver. 5.29	16GB(4GB*4)	SS	SK Hynix	H5AN4G8NMFR	16-18-18-40	1.35V		•	
CORSAIR	CMK16GX4M4B3400C16 ver. 4.23	16GB(4GB*4)	SS	Samsung	K4A4G085WD	16-18-18-36	1.35V		•	•
CORSAIR	CMK16GX4M2B3400C16 ver. 4.23	16GB(8GB*2)	DS	Samsung	K4A4G085WD	16-18-18-36	1.35V		•	•
CORSAIR	CMK32GX4M4B3400C16 ver. 4.23	32GB(8GB*4)	DS	Samsung	K4A4G085WD	16-18-18-36	1.35V		•	•

## DDR4 3333 (O.C.) MHz capability

Vendors	Part No.	Size	SS/ DS	Chip Brand	Chip NO.	Timing	Voltage	DIMM socket support (Optional)		
								1	2	4
G.SKILL	F4-3333C16Q-16GRKD	16GB(4GB*4)	SS	Samsung	K4A4G085WD	16-18-18-36	1.35V	•	•	•
CORSAIR	CMD16GX4M4B3333C16 ver4.23	16GB(4GB*4)	SS	Samsung	K4A4G085WD	16-18-18-36	1.35V	•	•	•
A-DATA	AX4U3333W4G16	16GB(4GB*4)	SS	SK Hynix	H5AN4G8NMFR	16-16-16-36	1.35V	•	•	•
AVEXIR	AVD4UZ133331604G-2XXXX	8GB(4GB*2)	SS	Samsung	K4A4G085WD	16-18-18-38	1.35V	•	•	•
AVEXIR	AVD4UZ133331604G-4XXXX	16GB(4GB*4)	SS	Samsung	K4A4G085WD	16-18-18-38	1.35V	•	•	•

## DDR4 3300 (O.C.) MHz capability

Vendors	Part No.	Size	SS/ DS	Chip Brand	Chip NO.	Timing	Voltage	DIMM socket support (Optional)		
								1	2	4
G.SKILL	F4-3300C16Q-16GRK	16GB(4GB*4)	SS	Samsung	K4A4G085WD	16-18-18-36	1.35V	•	•	•
G.SKILL	F4-3300C16Q-16GRKD	16GB(4GB*4)	SS	Samsung	K4A4G085WD	16-18-18-36	1.35V	•	•	•
CORSAIR	CMD16GX4M4B3300C16	16GB(4GB*4)	SS	Samsung	K4A4G085WD	16-18-18-36	1.35V	•	•	•

## DDR4 3200 (O.C.) MHz capability

Vendors	Part No.	Size	SS/ DS	Chip Brand	Chip NO.	Timing	Voltage	DIMM socket support (Optional)		
								1	2	4
G.SKILL	F4-3200C16D-8GRK	8GB(4GB*2)	SS	Samsung	K4A4G085WD	16-16-16-36	1.35V	•	•	•
G.SKILL	F4-3200C16D-8GTZ	8GB(4GB*2)	SS	Samsung	K4A4G085WD	16-16-16-36	1.35V	•	•	•
G.SKILL	F4-3200C16D-8GVK	8GB(4GB*2)	SS	Samsung	K4A4G085WD	16-16-16-36	1.35V	•	•	•
G.SKILL	F4-3200C16D-16GRK	16GB(8GB*2)	DS	Samsung	K4A4G085WD	16-16-16-36	1.35V	•	•	•
G.SKILL	F4-3200C16D-16GTZ	16GB(8GB*2)	DS	Samsung	K4A4G085WD	16-16-16-36	1.35V	•	•	•
G.SKILL	F4-3200C16D-16GVK	16GB(8GB*2)	DS	Samsung	K4A4G085WD	16-16-16-36	1.35V	•	•	•
G.SKILL	F4-3200C15D-32GRK	32GB(16GB*2)	DS	Samsung		15-15-15-35	1.35V	•	•	•
G.SKILL	F4-3200C15D-32GTZ	32GB(16GB*2)	DS	Samsung		15-15-15-35	1.35V	•	•	•
G.SKILL	F4-3200C15D-32GVK	32GB(16GB*2)	DS	Samsung		15-15-15-35	1.35V	•	•	•
G.SKILL	F4-3200C16D-32GRK	32GB(16GB*2)	DS	Samsung		16-18-18-38	1.35V	•	•	•
G.SKILL	F4-3200C16D-32GTZ	32GB(16GB*2)	DS	Samsung		16-18-18-38	1.35V	•	•	•
G.SKILL	F4-3200C16D-32GVK	32GB(16GB*2)	DS	Samsung		16-18-18-38	1.35V	•	•	•
G.SKILL	F4-3200C16Q-16GFR	16GB(4GB*4)	SS	Samsung	K4A4G085WD	16-16-16-36	1.35V	•	•	•
G.SKILL	F4-3200C16Q-16GRB	16GB(4GB*4)	SS	Samsung	K4A4G085WD	16-16-16-36	1.35V	•	•	•
G.SKILL	F4-3200C16Q-16GRKD	16GB(4GB*4)	SS	Samsung	K4A4G085WD	16-16-16-36	1.35V	•	•	•
G.SKILL	F4-3200C16Q-16GTZ	16GB(4GB*4)	SS	Samsung	K4A4G085WD	16-16-16-36	1.35V	•	•	•
G.SKILL	F4-3200C16Q-16GVK	16GB(4GB*4)	SS	Samsung	K4A4G085WD	16-16-16-36	1.35V	•	•	•
G.SKILL	F4-3200C16Q-32GRK	32GB(8GB*4)	DS	Samsung	K4A4G085WD	16-16-16-36	1.35V	•	•	•
G.SKILL	F4-3200C16Q-32GTZ	32GB(8GB*4)	DS	Samsung	K4A4G085WD	16-16-16-36	1.35V	•	•	•
G.SKILL	F4-3200C16Q-32GVK	32GB(8GB*4)	DS	Samsung	K4A4G085WD	16-16-16-36	1.35V	•	•	•
G.SKILL	F4-3200C16Q-64GRK	64GB(16GB*4)	DS	Samsung		16-18-18-38	1.35V	•	•	•
G.SKILL	F4-3000C16Q-64GTZ	64GB(16GB*4)	DS	Samsung		16-18-18-38	1.35V	•	•	•
G.SKILL	F4-3200C16Q-64GVK	64GB(16GB*4)	DS	Samsung		16-18-18-38	1.35V	•	•	•
AVEXIR	AVD4U32001604G-4BZ1	16GB(4GB*4)	SS	SK Hynix	H5AN4G8NMFR	16-18-18-36	1.35V	•	•	•

(continued on the next page)

## DDR4 3200 (O.C.) MHz capability

Vendors	Part No.	Size	SS/ DS	Chip Brand	Chip NO.	Timing	Voltage	DIMM socket support (Optional)		
								1	2	4
AVEXIR	AVD4U32001604G-4CIR	16GB(4GB*4)	SS			16-18-18-36	1.35V	•	•	•
CORSAIR	CMD16GX4M4B3200C16	16GB(4GB*4)	SS			16-18-18-36	1.35V	•	•	
CORSAIR	CMK32GX4M2B3200C16	32GB(16GB*2)	DS	Samsung		16-18-18-36	1.35V	•		
GEIL	GPR416GB3200C15QC	16GB(4GB*4)	SS			15-15-15-35	1.35V	•	•	•
Kingston	HX432C16PB2K4/16	16GB(4GB*4)	SS			16-16-16-39	1.35V	•	•	•
Panram	PUD43200C164G4NJW	16GB(4GB*4)	SS			16-18-18-39	1.35V	•	•	•

## DDR4 3000 (O.C.) MHz capability

Vendors	Part No.	Size	SS/ DS	Chip Brand	Chip NO.	Timing	Voltage	DIMM socket support (Optional)		
								1	2	4
G.SKILL	F4-3000C15D-8GRK	8GB(4GB*2)	SS	Samsung	K4A4G085WD	15-15-15-35	1.35V	•		
G.SKILL	F4-3000C15D-8GTZ	8GB(4GB*2)	SS	Samsung	K4A4G085WD	15-15-15-35	1.35V	•		
G.SKILL	F4-3000C15D-8GVK	8GB(4GB*2)	SS	Samsung	K4A4G085WD	15-15-15-35	1.35V	•		
G.SKILL	F4-3000C15D-16GRK	16GB(8GB*2)	DS	Samsung	K4A4G085WD	15-15-15-35	1.35V	•		
G.SKILL	F4-3000C15D-16GTZ	16GB(8GB*2)	DS	Samsung	K4A4G085WD	15-15-15-35	1.35V	•		
G.SKILL	F4-3000C15D-16GVK	16GB(8GB*2)	DS	Samsung	K4A4G085WD	15-15-15-35	1.35V	•		
G.SKILL	F4-3000C15D-32GRK	32GB(16GB*2)	DS	Samsung		15-15-15-35	1.35V	•		
G.SKILL	F4-3000C15D-32GTZ	32GB(16GB*2)	DS	Samsung		15-15-15-35	1.35V	•		
G.SKILL	F4-3000C15D-32GVK	32GB(16GB*2)	DS	Samsung		15-15-15-35	1.35V	•		
G.SKILL	F4-3000C15Q-16GRR	16GB(4GB*4)	SS	Samsung	K4A4G085WD	15-15-15-35	1.35V	•	•	
G.SKILL	F4-3000C15Q-16GRB	16GB(4GB*4)	SS	Samsung	K4A4G085WD	15-15-15-35	1.35V	•	•	
G.SKILL	F4-3000C15Q-16GRK	16GB(4GB*4)	SS	Samsung	K4A4G085WD	15-15-15-35	1.35V	•	•	
G.SKILL	F4-3000C15Q-16GTZ	16GB(4GB*4)	SS	Samsung	K4A4G085WD	15-15-15-35	1.35V	•	•	
G.SKILL	F4-3000C15Q-16GVK	16GB(4GB*4)	SS	Samsung	K4A4G085WD	15-15-15-35	1.35V	•	•	
G.SKILL	F4-3000C15Q-32GRR	32GB(8GB*4)	DS	Samsung	K4A4G085WD	15-15-15-35	1.35V	•	•	
G.SKILL	F4-3000C15Q-32GRB	32GB(8GB*4)	DS	Samsung	K4A4G085WD	15-15-15-35	1.35V	•	•	
G.SKILL	F4-3000C15Q-32GRK	32GB(8GB*4)	DS	Samsung	K4A4G085WD	15-15-15-35	1.35V	•	•	
G.SKILL	F4-3000C15Q-32GTZ	32GB(8GB*4)	DS	Samsung	K4A4G085WD	15-15-15-35	1.35V	•	•	
G.SKILL	F4-3000C15Q-32GVK	32GB(8GB*4)	DS	Samsung	K4A4G085WD	15-15-15-35	1.35V	•	•	
G.SKILL	F4-3000C15Q-64GRK	64GB(16GB*4)	DS	Samsung		15-15-15-35	1.35V	•	•	
G.SKILL	F4-3000C15Q-64GTZ	64GB(16GB*4)	DS	Samsung		15-15-15-35	1.35V	•	•	
G.SKILL	F4-3000C15Q-64GVK	64GB(16GB*4)	DS	Samsung		15-15-15-35	1.35V	•	•	
AVEXIR	AVD4U30001604G-4CI	16GB(4GB*4)	SS	SK Hynix	H5AN4G8NMFR	16-18-18-36	1.35V	•	•	
AVEXIR	AVD4U30001504G-4B21	16GB(4GB*4)	SS	SK Hynix	H5AN4G8NMFR	15-15-15-35	1.35V	•	•	
AVEXIR	AVD4U30001608G-4CI	32GB(8GB*4)	DS	SK Hynix	H5AN4G8NMFR	16-18-18-36	1.35V	•	•	
Kingston	HX430C15PB2K4/16	16GB(4GB*4)	SS			15-16-16-39	1.35V	•	•	
CORSAIR	CMD16GX4M4B3000C15	16GB(4GB*4)	SS	Samsung	K4A4G085WD	15-17-17-35	1.35V	•	•	
CORSAIR	CMK16GX4M4B3000C15	16GB(4GB*4)	SS	Samsung	K4A4G085WD	15-17-17-35	1.35V	•	•	
Panram	PUD43000C154G4NJW	16GB(4GB*4)	SS			15-17-17-35	1.35V	•	•	
Asint	SLB404G08-EWWHMX	16GB(8GB*2)	SS	SK Hynix	H5AN4G8NMFR	15-15-15-44	1.35V	•		

## DDR4 2800 (O.C.) MHz capability

Vendors	Part No.	Size	SS/DS	Chip Brand	Chip NO.	Timing	Voltage	DIMM socket support (Optional)		
								1	2	4
ADATA	AX4U2800W4G17	32GB (4GB*8)	DS	-	-	17-17-17-36	1.2	*	*	*
ADATA	AX4U2800W8G17	8GB	DS	-	-	15-15-15-36	1.2	*	*	*
Apacer	78.BAGM8.AF20B (XMP)	4GB	SS	-	-	17-17-17-36	-	*	*	*
Apacer	78.CAGM8.AF30B (XMP)	8GB	DS	-	-	17-17-17-36	-	*	*	*
AVEXIR	AVD4U28001504G-4CIR (XMP)	4GB	SS	-	-	15-15-15-35	1.35	*	*	*
AVEXIR	AVD4U28001608G-4CIR (XMP)	32GB (4GB*8)	DS	-	-	16-16-16-36	1.2	*	*	*
CORSAIR	CMD16GX4M4A2800C16 (Ver4.23)(XMP)	16GB (4GB*4)	SS	-	-	16-18-18-36	1.2	*	*	*
CORSAIR	CMD16GX4M4A2800C16 (Ver5.29)	16GB (4GB*4)	SS	-	-	16-18-18-36	1.2	*	*	*
CORSAIR	CMD32GX4M4A2800C16 (Ver5.29)(XMP)	32GB (8GB*4)	DS	-	-	18-18-18-36	1.2	*	*	*
CORSAIR	CMK16GX4M4A2800C16 (Ver4.23)(XMP)	16GB (4GB*4)	SS	-	-	16-16-18-36	1.2	*	*	*
CORSAIR	CMK16GX4M4A2800C16 (Ver5.29)	16GB (4GB*4)	SS	-	-	16-18-18-36	1.2	*	*	*
CORSAIR	CMK32GX4M4A2800C16 (Ver5.29)(XMP)	32GB (8GB*4)	DS	-	-	16-18-18-36	1.2	*	*	*
G.SKILL	F4-2800C15Q2-64GRK (XMP)	64GB (8GB*8)	DS	-	-	15-16-16-35	1.25	*	*	*
G.SKILL	F4-2800C16Q-16GRR (XMP)	16GB (4GB*4)	SS	-	-	16-16-16-36	1.2	*	*	*
G.SKILL	F4-2800C16Q-32GRR (XMP)	32GB (8GB*4)	DS	-	-	16-16-16-36	1.2	*	*	*
Kingston	HX428C14PBK4/16 (XMP)	16GB (4GB*4)	SS	-	-	14-15-15-40	1.35	*	*	*
Panram	PUD42800C164G4NJW (XMP)	16GB (4GB*4)	SS	-	-	16-18-18-36	1.25	*	*	*

## DDR4 2666 (O.C.) MHz capability

Vendors	Part No.	Size	SS/DS	Chip Brand	Chip NO.	Timing	Voltage	DIMM socket support (Optional)		
								1	2	4
AVEXIR	AVD4U26661504G-4CIR (XMP)	4GB	SS	-	-	15-15-15-35	1.2	*	*	*
AVEXIR	AVD4U26661608G-4CIR (XMP)	32GB (4GB*8)	DS	-	-	16-16-16-36	1.2	*	*	*
CORSAIR	CMD128GX4M8A2666C15 (Ver4.31)(XMP)	128GB (16x 8GB)	DS	-	-	15-17-17-35	1.2	*	*	*
CORSAIR	CMD16GX4M4A2666C15 (Ver4.23)(XMP)	16GB (4GB*4)	SS	-	-	15-17-17-35	1.2	*	*	*
CORSAIR	CMD16GX4M4A2666C16 (Ver4.23)(XMP)	16GB (4GB*4)	SS	-	-	16-18-18-35	1.2	*	*	*
CORSAIR	CMD16GX4M4A2666C16 (Ver5.29)(XMP)	16GB (4GB*4)	SS	-	-	16-18-18-35	1.2	*	*	*
CORSAIR	CMD32GX4M4A2666C15 (Ver4.23)(XMP)	32GB (8GB*4)	DS	-	-	15-17-17-35	1.2	*	*	*
CORSAIR	CMD32GX4M4A2666C15 (Ver5.29)	32GB (8GB*4)	DS	-	-	15-17-17-35	1.2	*	*	*
CORSAIR	CMD32GX4M4A2666C16 (Ver4.23)(XMP)	32GB (8GB*4)	DS	-	-	16-18-18-35	1.2	*	*	*
CORSAIR	CMK16GX4M4A2666C15 (Ver4.23)(XMP)	16GB (4GB*4)	SS	-	-	15-17-17-35	1.2	*	*	*
CORSAIR	CMK16GX4M4A2666C15 (Ver5.29)	16GB (4GB*4)	SS	-	-	15-17-17-35	1.2	*	*	*
CORSAIR	CMK16GX4M4A2666C16 (Ver4.23)(XMP)	16GB (4GB*4)	SS	-	-	16-18-18-35	1.2	*	*	*

(continued on the next page)

## DDR4 2666 (O.C.) MHz capability

Vendors	Part No.	Size	SS/DS	Chip Brand	Chip NO.	Timing	Voltage	DIMM socket support (Optional)		
								1	2	4
CORSAIR	CMK16GX4M4A2666C16 (Ver5.29)(XMP)	16GB (4GB*4)	SS	-	-	16-18-18-35	1.2	•	•	•
CORSAIR	CMK32GX4M4A2666C15 (Ver4.23)(XMP)	32GB (8GB*4)	DS	-	-	15-17-17-35	1.2	•	•	•
CORSAIR	CMK32GX4M4A2666C15 (Ver5.29)(XMP)	32GB (8GB*4)	DS	-	-	15-17-17-35	1.2	•	•	•
CORSAIR	CMK32GX4M4A2666C16 (Ver5.29)(XMP)	32GB (8GB*4)	DS	-	-	16-16-18-35	1.2	•	•	•
CORSAIR	CMK32GX4M4A2666C16R (Ver4.23)(XMP)	32GB (8GB*4)	DS	-	-	16-18-18-35	1.2	•	•	•
G.SKILL	F4-2666C15Q-16GRR (XMP)	16GB (4GB*4)	SS	-	-	15-15-15-35	1.2	•	•	•
G.SKILL	F4-2666C15Q-32GRR (XMP)	32GB (8GB*4)	DS	-	-	15-15-15-35	1.2	•	•	•
G.SKILL	F4-2666C16Q2-64GRB (XMP)	64GB (8GB*8)	DS	-	-	16-16-16-36	1.2	•	•	•
KLEVV	IMA41GU6MFR8N-CF0 (XMP)	8GB	DS	ISDT	I5AN4G8NMFR	15-15-15-35	1.2	•	•	•
KLEVV	IMA451U6MFR8N-CF0 (XMP)	4GB	SS	ISDT	I5AN4G8NMFR	15-15-15-35	1.2	•	•	•
Team	TCD44G2666C15ABK (XMP)	4GB	SS	Samsung	K4A4G085WD	15-15-15-35	1.2	•	•	•
Team	TCD48G2666C15ABK (XMP)	32GB (8GB*4)	DS	Team	TCD48G2666C15ABK	15-15-15-35	1.2	•	•	•

## DDR4 2400 (O.C.) MHz capability

Vendors	Part No.	Size	SS/DS	Chip Brand	Chip NO.	Timing	Voltage	DIMM socket support (Optional)		
								1	2	4
AVEXIR	AVD4U24001604G-4CIR (XMP)	4GB	SS	-	-	16-16-16-36	1.2	•	•	•
AVEXIR	AVD4U24001608G-4M	32GB (4GB*8)	DS	SK Hynix	H5AN4G8NMFRFC	16-16-16-39	1.2	•	•	•
AVEXIR	AVD4U24001608G-4M (XMP)	32GB (4GB*8)	DS	SK Hynix	H5AN4G8NMFRFC	16-16-16-36	1.2	•	•	•
CORSAIR	CMD16GX4M4A2400C14 (Ver4.23)(XMP)	16GB (4GB*4)	SS	-	-	14-16-16-31	1.2	•	•	•
CORSAIR	CMD32GX4M4A2400C14 (Ver4.23)(XMP)	32GB (8GB*4)	DS	-	-	14-16-16-31	1.2	•	•	•
CORSAIR	CMK16GX4M4A2400C14 (Ver4.23)(XMP)	16GB (4GB*4)	SS	-	-	14-16-16-31	1.2	•	•	•
CORSAIR	CMK32GX4M4A2400C14 (Ver4.23)(XMP)	32GB (8GB*4)	DS	-	-	14-16-16-31	1.2	•	•	•
Crucial	BLS4G4D240FSA.8FAD	4GB	SS	-	-	16-16-16-40	1.2	•	•	•
crucial	BLS4G4D240FSA.8FAR (XMP)	4GB	SS	-	-	17-16-16-39	1.2	•	•	•
Crucial	BLS8G4D240FSA.16FAD	8GB	DS	-	-	16-16-16-40	1.2	•	•	•
crucial	BLS8G4D240FSA.16FAR (XMP)	8GB	DS	-	-	17-16-16-39	1.2	•	•	•
G.SKILL	F4-2400C15Q-16GRR	16GB (4GB*4)	SS	-	-	15-15-15-35	1.2	•	•	•
G.SKILL	F4-2400C15Q2-128GRK (XMP)	128GB (16GB*8)	DS	-	-	15-15-15-35	1.2	•	•	•
G.SKILL	F4-2400C15Q-32GRR	32GB (8GB*4)	DS	-	-	15-15-15-35	1.2	•	•	•

(continued on the next page)



## DDR4 2400 (O.C.) MHz capability

Vendors	Part No.	Size	SS/DS	Chip Brand	Chip NO.	Timing	Voltage	DIMM socket support (Optional)		
								1	2	4
Kingston	HX424C12PB2K4/16	16GB (4GB*4)	SS	-	-	15-15-15-36	1.2	•	•	•
Panram	PUD42400C154G4NJW	16GB (4GB*4)	SS	-	-	15-15-15-35	1.2	•	•	•
Panram	PUD42400C158G4NJW	32GB (8GB*4)	DS	-	-	15-15-15-35	1.2	•	•	•
Team	TED44GM2400C16BK	4GB	SS	Samsung	K4A4G085WD	16-16-16-39	1.2	•	•	•
Team	TED48GM2400C16BK	8GB	DS	Samsung	K4A4G085WD	16-16-16-39	1.2	•	•	•
V-color	TD4G8C17-UH	4GB	SS	V-color	DW3J0460HM	15-15-15-36	1.2	•	•	•

## DDR4 2133 (O.C.) MHz capability

Vendors	Part No.	Size	SS/DS	Chip Brand	Chip NO.	Timing	Voltage	DIMM socket support (Optional)		
								1	2	4
ADATA	AD4U2133W4G15-B	4GB	SS	SK Hynix	H5AN4G8NMFRFTFC	15-15-15-36	-	•	•	•
ADATA	AD4U2133W8G15	8GB	DS	SK Hynix	H5AN4G8NMFRFTFC	15-15-15-36	1.2	•	•	•
Apacer	78.B1GM3.AF00B	4GB	SS	SK Hynix	H5AN4G8NMFRFTFC	15-15-15-36	1.2	•	•	•
Apacer	78.C1GM3.AF10B	8GB	DS	SK Hynix	H5AN4G8NMFRFTFC	15-15-15-36	1.2	•	•	•
AVEXIR	AVD4U21331504G-4M	4GB	SS	AVEXIR	512X8DDR4	15-15-15-35	1.2	•	•	•
Century Micro Inc	CD8G-D4U2133	8GB	DS	SK Hynix	H5AN4G8NMFRFTFC	15-15-15-36	-	•	•	•
CORSAIR	CMK16GX4M4A2133C13 (Ver4.23)(XMP)	16GB (4GB*4)	SS	-	-	13-15-15-28	1.2	•	•	•
CORSAIR	CMK32GX4M4A2133C13 (Ver4.23)(XMP)	32GB (8GB*4)	DS	-	-	13-15-15-28	1.2	•	•	•
CORSAIR	CMK64GX4M8A2133C13 (Ver4.23)(XMP)	64GB (8GB*8)	DS	-	-	13-15-15-28	1.2	•	•	•
CORSAIR	CMV4GX4M1A2133C15	4GB	SS	-	-	15-15-15-36	1.2	•	•	•
CORSAIR	CMV8GX4M1A2133C15	8GB	DS	-	-	15-15-15-36	1.2	•	•	•
G.SKILL	F4-2133C15Q-16GRR	16GB (4GB*4)	SS	-	-	15-15-15-35	1.2	•	•	•
G.SKILL	F4-2133C15Q-32GRR	32GB (8GB*4)	DS	-	-	15-15-15-35	-	•	•	•
KLEVV	IMA41GU6MFR8N-TF0	8GB	DS	ISDT	IS5AN4G8NMFR	15-15-15-35	1.2	•	•	•
KLEVV	IMA451U6MFR8N-TF0	4GB	SS	ISDT	IS5AN4G8NMFR	15-15-15-35	1.2	•	•	•
Panram	PUD42133C134G4NJW	16GB (4GB*4)	SS	-	-	13-13-13-35	1.2	•	•	•
Panram	PUD42133C138G4NJW	32GB (8GB*4)	DS	-	-	13-13-13-35	1.2	•	•	•
Panram	PUD42133C154G2V5	8GB (4GB*2)	SS	SK Hynix	H5AN4G8NMFRFTFC	15-15-15-36	1.2	•	•	•
Panram	PUD42133C154GNJK	4GB	SS	-	-	15-15-15-36	1.2	•	•	•
Panram	PUD42133C158G2V5	16GB (8GB*2)	DS	SK Hynix	H5AN4G8NMFRFTFC	15-15-15-36	1.2	•	•	•
Panram	PUD42133C158GNJK	8GB	DS	-	-	15-15-15-36	1.2	•	•	•
Samsung	M378A1G43DB0-CPB	8GB	DS	Samsung	K4A4G085WD	15-15-15-36	-	•	•	•
SanMax	SMD-4G28HP-21P	4GB	SS	SK Hynix	H5AN4G8NMFRFTFC	15-15-15-37	-	•	•	•

(continued on the next page)

## DDR4 2133 (O.C.) MHz capability

Vendors	Part No.	Size	SS/DS	Chip Brand	Chip NO.	Timing	Voltage	DIMM socket support (Optional)		
								1	2	4
SanMax	SMD-8G28HP-21P	8GB	DS	SK Hynix	H5AN4G8NMFRTFC	15-15-15-37	-	•	•	•
SK Hynix	HMA82GU6MFR8N-TF	16GB	DS	SK Hynix	H5AN8G8NMFRTFC	15-15-15-36	-	•	•	•
SUPER TALENT	FBU2B008GM	8GB	DS	Micron	D9RGQ	15-15-15-36	1.2	•	•	•
Team	TED44GM2133C15ABK	4GB	SS	SK Hynix	H5AN4G8NMFRTFC	15-15-15-36	1.2	•	•	•
Transcend	TS1GLH64V1H	8GB	DS	Samsung	K4A4G085WD	15-15-15-37	-	•	•	•
Transcend	TS512MLH64V1H	4GB	SS	Samsung	K4A4G085WD	15-15-15-37	-	•	•	•
UMAX	84G44G93MC-210MCALGF15	4GB	SS	Micron	D9RGQ	15-15-15-36	-	•	•	•
UMAX	84G48G93MC-210MCGNGF15	8GB	DS	Micron	D9RGQ	15-15-15-36	-	•	•	•



Side(s): SS - Single-sided DS - Double-sided DIMM support:

- 1** Supports one (1) module inserted into any slot as Single-channel memory configuration. We suggest that you install the module into A2 slot.
- 2** Supports two (2) modules inserted into one pair of the dark gray slots or the black slots as one pair of dual-channel memory configuration. We suggest that you install the modules into slots A2 and B2 for better compatibility.
- 4** Supports four (4) modules inserted into both the dark gray slots and black slots as two pairs of quad-channel memory configuration. We suggest that you install the modules into slots A1, A2, B1, and B2 for better compatibility.



- ASUS exclusively provides hyper DIMM support function.
- Hyper DIMM support is subject to the physical characteristics of individual CPUs. Load the X.M.P. or D.O.C.P. settings in the BIOS for the hyper DIMM support.
- Visit the ASUS website for the latest QVL.

## 1.2.5 Expansion slots



Unplug the power cord before adding or removing expansion cards. Failure to do so may cause you physical injury and damage motherboard components.

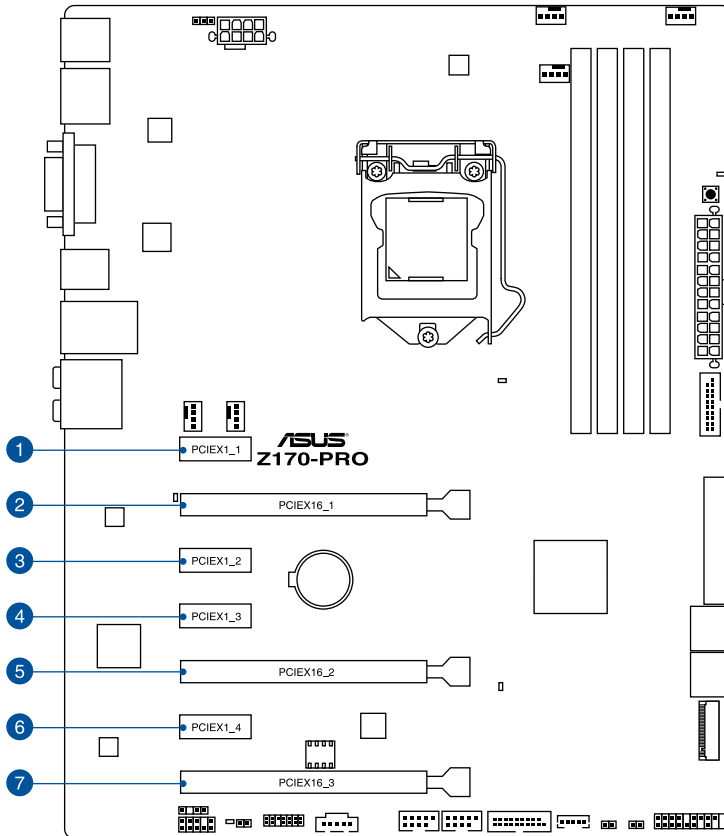

Slot No.	Slot Description
1	PCIe 2.0 x1_1 slot
2	PCIe 3.0/2.0 x16_1 slot
3	PCIe 2.0 x1_2 slot
4	PCIe 2.0 x1_3 slot
5	PCIe 3.0/2.0 x16_2 slot
6	PCIe 2.0 x1_4 slot
7	PCIe 3.0/2.0 x16_3 slot

VGA configuration	PCI Express 3.0 operating mode	
	PCIe 3.0/2.0 x16_1	PCIe 3.0/2.0 x16_2
Single VGA/PCIe card	x16 (single VGA recommended)	N/A
Dual VGA/PCIe card	x8	x8



- We recommend that you provide sufficient power when running CrossFireX™ or SLI™ mode.
- Connect a chassis fan to the motherboard connector labeled CHA\_FAN1-2 when using multiple graphics cards for better thermal environment.

### IRQ assignments for this motherboard

	A	B	C	D
PCIe x16_1	shared	-	-	-
PCIe x16_2	shared	-	-	-
PCIe x16_3	shared	-	-	-
PCIe x1_1	-	shared	-	-
PCIe x1_2	-	-	shared	-
PCIe x1_3	shared	-	-	-
PCIe x1_4	-	-	-	shared
SMBUS Controller	shared	-	-	-
Intel SATA Controller	shared	-	-	-
Intel LAN1(i219)	shared	-	-	-
Intel xHCI	shared	-	-	-
HD Audio	shared	-	-	-
Intel USB 3.1	shared	-	-	-

## 1.2.6 Onboard buttons and switches

Onboard buttons and switches allow you to fine-tune performance when working on a bare or open-case system. This is ideal for overclockers and gamers who continually change settings to enhance system performance.

### 1. MemOK! button

Installing DIMMs that are not compatible with the motherboard may cause system boot failure. If the system fails to boot during POST stage and the DRAM\_LED near the MemOK! button lights continuously, press the MemOK! button until the DRAM\_LED starts blinking. System will begin automatic memory compatibility tuning and reboot for successful boot.

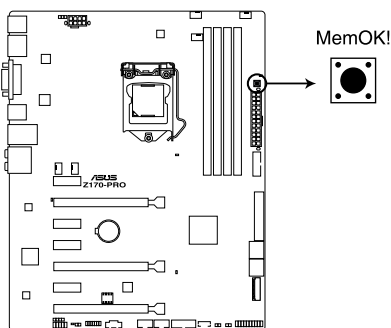

**Z170-PRO MemOK! button**



- Refer to section **1.2.8 Onboard LEDs** for the exact location of the DRAM\_LED.
- The DRAM\_LED also lights up when the DIMM is not properly installed. Turn off the system and reinstall the DIMM before using the MemOK! function.
- The MemOK! button does not function under Windows® OS environment.
- During the tuning process, the system loads and tests failsafe memory settings. It takes about 30 seconds for the system to test one set of failsafe settings. If the test fails, the system reboots and test the next set of failsafe settings. The blinking speed of the DRAM\_LED increases, indicating different test processes.
- Due to memory tuning requirement, the system automatically reboots when each timing set is tested. If the installed DIMMs still fail to boot after the whole tuning process, the DRAM\_LED lights continuously. Replace the DIMMs with ones recommended in the Memory QVL (Qualified Vendors Lists) in this user manual or at [www.asus.com](http://www.asus.com).
- If you turn off the computer and replace DIMMs during the tuning process, the system continues memory tuning after turning on the computer. To stop memory tuning, turn off the computer and unplug the power cord for about 5–10 seconds.
- If your system fails to boot up due to BIOS overclocking, press the MemOK! button to boot and load the BIOS default settings. A message will appear during POST reminding you that the BIOS has been restored to its default settings.
- We recommend that you download and update to the latest BIOS version from [www.asus.com](http://www.asus.com) after using the MemOK! function.

## 1.2.7 Jumpers

### 1. Clear RTC RAM (2-pin CLRTC)

This header allows you to clear the Real Time Clock (RTC) RAM in CMOS. You can clear the CMOS memory of date, and system setup parameters by erasing the CMOS RTC RAM data. The onboard button cell battery powers the RAM data in CMOS, which include system setup information such as system passwords.

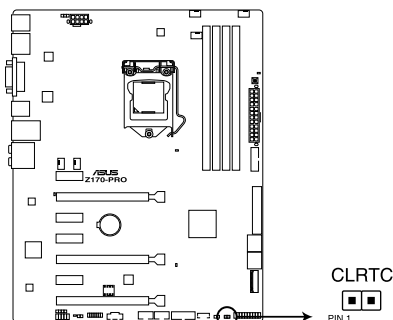

**Z170-PRO Clear RTC RAM**

#### To erase the RTC RAM:

1. Turn OFF the computer and unplug the power cord.
2. Use a metal object such as a screwdriver to short the two pins.
3. Plug the power cord and turn ON the computer.
4. Hold down the <Del> key during the boot process and enter BIOS setup to re-enter data.



---

Except when clearing the RTC RAM, never short-circuit the CLRTC jumper. Shorting the CLRTC jumper will cause system boot failure!

---



- If the steps above do not help, remove the onboard battery and short the two pins again to clear the CMOS RTC RAM data. After clearing the CMOS, reinstall the battery.
  - You do not need to clear the RTC when the system hangs due to overclocking. For system failure due to overclocking, use the CPU Parameter Recall (C.P.R.) feature. Shut down and reboot the system, then the BIOS automatically resets parameter settings to default values.
  - Due to chipset behavior, AC power off is required to enable C.P.R. function. You must turn off and on the power supply or unplug and plug the power cord before rebooting the system.
-

## 2. CPU Over Voltage jumper (3-pin CPU\_OV)

The CPU Over Voltage jumper allows you to set a higher CPU voltage for a flexible overclocking system, depending on the type of the installed CPU. To gain more CPU voltage setting, insert the jumper to pins 2-3. To go back to its default CPU voltage setting, insert the jumper to pins 1-2.

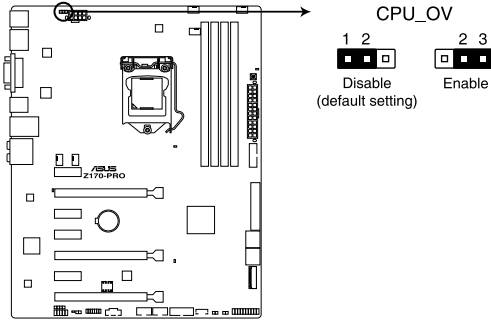

**Z170-PRO CPU\_OV setting**

## 1.2.8 Onboard LEDs

### 1. POST State LEDs

The POST State LEDs provide the status of these key components during POST (Power-On-Self Test): CPU, memory modules, VGA card, and hard disk drives. If an error is found, the critical component's LED stays lit up until the problem is solved.

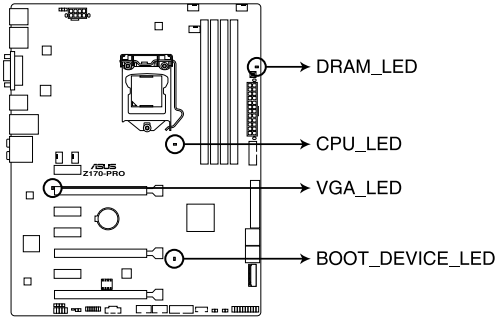

**Z170-PRO CPU/ DRAM/  
BOOT\_DEVICE/ VGA LED**

### 2. Power LED (PWR\_LED)

This LED lights up when the system is on.

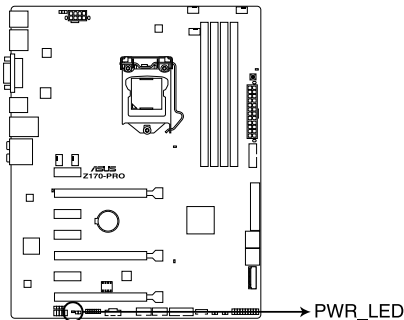

**Z170-PRO PWR\_LED**



## 1.2.9 Internal connectors

### 1. Intel® Serial ATA 6 Gb/s connectors (7-pin SATA 6G\_34; SATA 6G\_56; SATAEXPRESS)

These connectors connect to Serial ATA 6 Gb/s hard disk drives via Serial ATA 6 Gb/s signal cables.

If you installed Serial ATA hard disk drives, you can create a RAID 0, 1, 5, and 10 configuration with the Intel® Rapid Storage Technology through the onboard Intel® Z170 chipset.

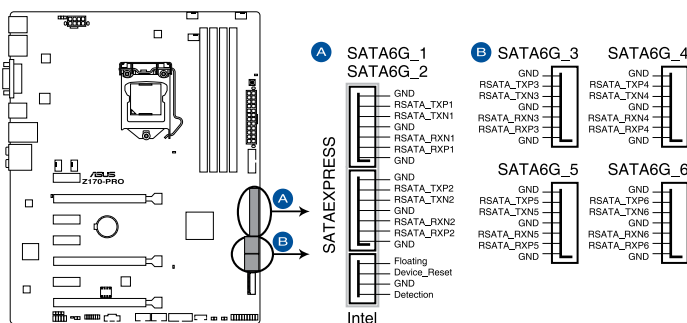

**Z170-PRO Intel® SATA 6 Gb/s connectors**

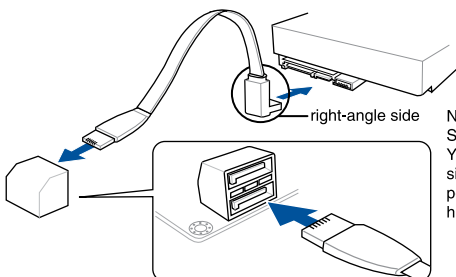

NOTE: Connect the right-angle side of SATA signal cable to SATA device. You may also connect the right-angle side of SATA cable to the onboard SATA port to avoid mechanical conflict with huge graphics cards.



- These connectors are set to **[AHCI Mode]** by default. If you intend to create a Serial ATA RAID set using these connectors, set the SATA Mode item in the BIOS to **[RAID Mode]**. Refer to section 3.6.5 **PCH Storage Configuration** for details.
- Before creating a RAID set, refer to section 5.1 **RAID configurations** or the manual bundled in the motherboard support DVD.



- The M.2 socket shares SATA ports with SATA Express. Only one SATA device could be activated. To use an M.2 SATA device, refer to section 3.6.8 **Onboard Devices Configuration** regarding the BIOS switch.
- The SATAEXPRESS connector can support one SATA Express device or two SATA devices.

## 2. T\_Sensor connector (2-pin T\_SENSOR)

This connector is for the thermistor cable that allows you to monitor the temperature of your motherboard's critical components and connected devices.

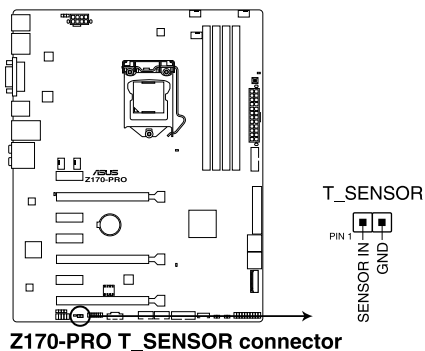

The thermistor cable is purchased separately.

## 3. Digital audio connector (4-1 pin SPDIF\_OUT)

This connector is for an additional Sony/Philips Digital Interface (S/PDIF) port. Connect the S/PDIF Out module cable to this connector, then install the module to a slot opening at the back of the system chassis.

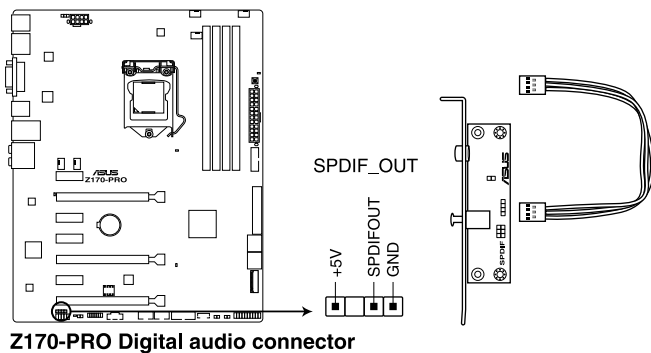

The S/PDIF module is purchased separately.

#### 4. Front panel audio connector (10-1 pin AAFP)

This connector is for a chassis-mounted front panel audio I/O module that supports either HD Audio or legacy AC'97 audio standard. Connect one end of the front panel audio I/O module cable to this connector.

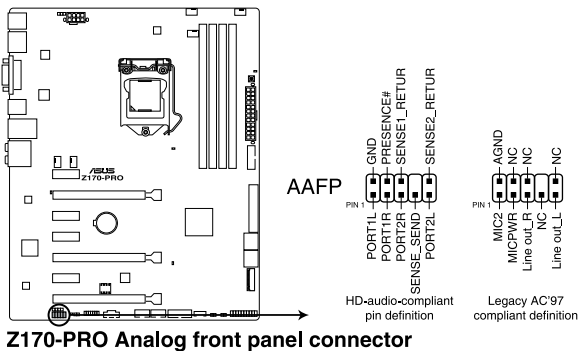

- We recommend that you connect a high-definition front panel audio module to this connector to avail of the motherboard's high-definition audio capability.
- If you want to connect a high-definition or an AC'97 front panel audio module to this connector, set the Front Panel Type item in the BIOS setup to **[HD Audio]** or **[AC97]**.

#### 5. Thunderbolt header (5-pin TB\_HEADER)

This connector is for the add-on Thunderbolt I/O card that supports Intel's Thunderbolt Technology, allowing you to connect up to six Thunderbolt-enabled devices and a DisplayPort-enabled display in a daisy-chain configuration.

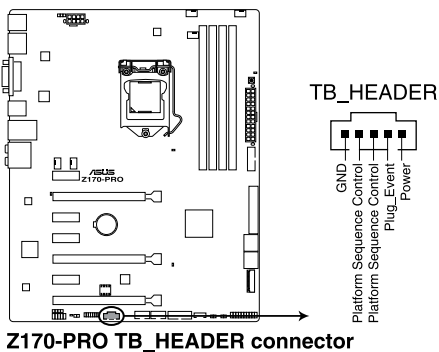

The add-on Thunderbolt I/O card and Thunderbolt cables are purchased separately.

## 6. USB 3.0 connectors (20-1 pin USB3\_12, USB3\_34)

These connectors allow you to connect a USB 3.0 module for additional USB 3.0 front or rear panel ports. With an installed USB 3.0 module, you can enjoy all the benefits of USB 3.0 including faster data transfer speeds of up to 5 Gb/s, faster charging time for USB-chargable devices, optimized power efficiency, and backward compatibility with USB 2.0.

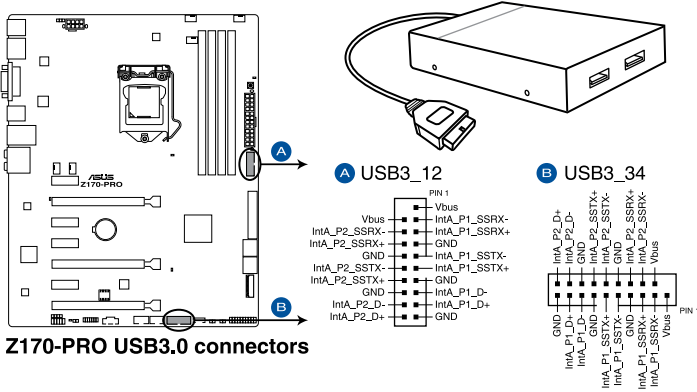

The USB 3.0 module is purchased separately.



- These connectors are based on xHCI specification. We recommend you to install the related driver to fully use the USB 3.0 ports under Windows® 7.
- These USB 3.0 ports support native UASP transfer standard in Windows® 8.1 and Turbo Mode when using USB 3.1 Boost feature.

## 7. USB 2.0 connectors (10-1 pin USB1112; USB1314)

These connectors are for USB 2.0 ports. Connect the USB module cable to any of these connectors, then install the module to a slot opening at the back of the system chassis. These USB connectors comply with USB 2.0 specification that supports up to 48 Mb/s connection speed.

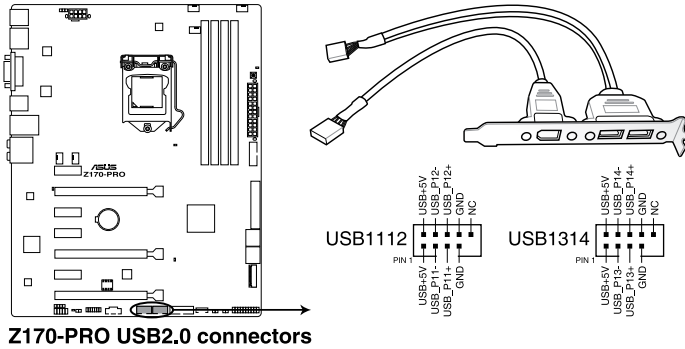

DO NOT connect a 1394 cable to the USB connectors. Doing so will damage the motherboard!



The USB 2.0 module is purchased separately.

## 8. CPU, water pump, CPU optional, extension, and chassis fan connectors (4-pin CPU\_FAN; 4-pin W\_PUMP; 4-pin CPU\_OPT; 5-pin EXT\_FAN; 4-pin CHA\_FAN1-2)

Connect the fan cables to the fan connectors on the motherboard, ensuring that the black wire of each cable matches the ground pin of the connector.



- DO NOT forget to connect the fan cables to the fan connectors. Insufficient air flow inside the system may damage the motherboard components. These are not jumpers! Do not place jumper caps on the fan connectors!
- Ensure that the CPU fan cable is securely installed to the CPU fan connector.

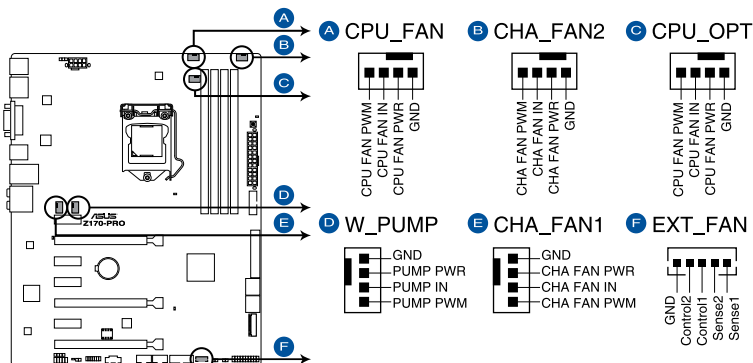

**Z170-PRO Fan connectors**



- The CPU\_FAN connector supports the CPU fan of maximum 1A (12 W) fan power.
- The CPU\_FAN connector and CHA\_FAN connectors support the ASUS FAN Xpert 3 feature.
- W\_PUMP function support depends on water cooling device.
- The CPU fan connector detects the type of CPU fan installed and automatically switches the control modes. To configure the CPU fan's control mode, go to **Advanced Mode > Monitor > CPU Q-Fan Control** item in BIOS.
- The chassis fan connectors support DC and PWM modes. To set these fans to DC or PWM, go to **Advanced Mode > Monitor > Chassis Fan 1/4 Q-Fan Control** items in BIOS.



The FAN EXTENSION CARD is purchased separately.



## 10. System panel connector (20-5 pin PANEL)

This connector supports several chassis-mounted functions.

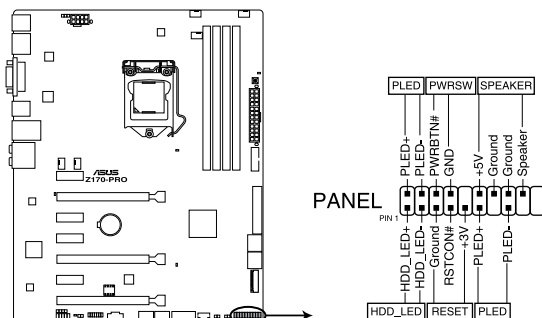

**Z170-PRO System panel connector**

- **System power LED (2-pin or 3-1 pin PLED)**

The 2-pin or 3-1 pin connector is for the system power LED. Connect the chassis power LED cable to this connector. The system power LED lights up when you turn on the system power, and blinks when the system is in sleep mode.

- **Hard disk drive activity LED (2-pin HDD\_LED)**

This 2-pin connector is for the HDD Activity LED. Connect the HDD Activity LED cable to this connector. The HDD LED lights up or flashes when data is read from or written to the HDD.

- **System warning speaker (4-pin SPEAKER)**

This 4-pin connector is for the chassis-mounted system warning speaker. The speaker allows you to hear system beeps and warnings.

- **ATX power button/soft-off button (2-pin PWRSW)**

This connector is for the system power button. Pressing the power button turns the system on or puts the system in sleep or soft-off mode depending on the operating system settings. Pressing the power switch for more than four seconds while the system is ON turns the system OFF.

- **Reset button (2-pin RESET)**

This 2-pin connector is for the chassis-mounted reset button for system reboot without turning off the system power.



## 11. TPM connector (14-1 pin TPM)

This connector supports a Trusted Platform Module (TPM) system, which securely store keys, digital certificates, passwords and data. A TPM system also helps enhance network security, protect digital identities, and ensures platform integrity.

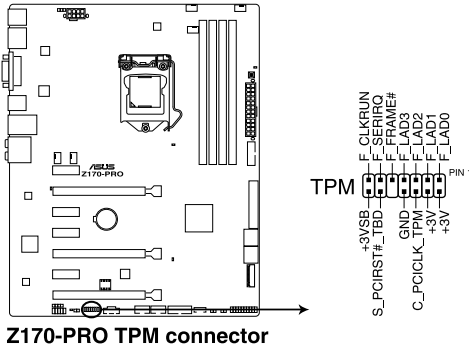

The TPM module is purchased separately.

## 12. DirectKey connector (2-pin DRCT)

This connector is for the chassis-mounted button that supports the DirectKey function. Connect the button cable that supports DirectKey, from the chassis to this connector on the motherboard.

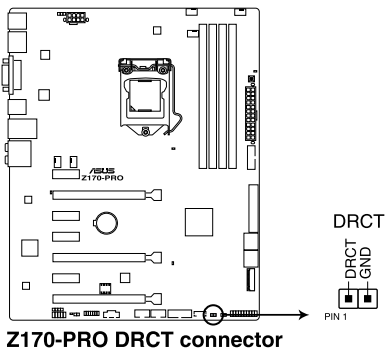

Ensure that your chassis comes with the extra button cable that supports the DirectKey feature. Refer to the technical documentation that came with the chassis for details.

### 13. M.2 socket 3

This socket allows you to install an M.2 (NGFF) SSD module.

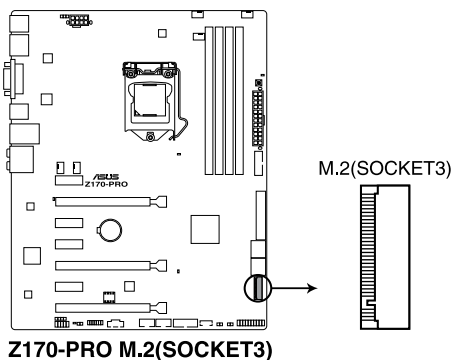

**Z170-PRO M.2(SOCKET3)**



- This socket supports M Key and type 2242/2260/2280/22110 storage devices.
- The M.2 socket shares SATA ports with SATA Express. Only one SATA device could be activated. To use an M.2 SATA device, refer to section 3.6.7 **Onboard Device Configuration** regarding the BIOS switch.
- When using Intel® Desktop Responsiveness technologies with PCIe M.2 device, ensure to set up the Windows® UEFI operating system under RAID mode.



The M.2 (NGFF) SSD module is purchased separately.

# Basic Installation

# 2

## 2.1 Building your PC system

### 2.1.1 Motherboard installation



The diagrams in this section are for reference only. The motherboard layout may vary with models, but the installation steps are the same for all models.

1. Install the ASUS Q-Shield to the chassis rear I/O panel.

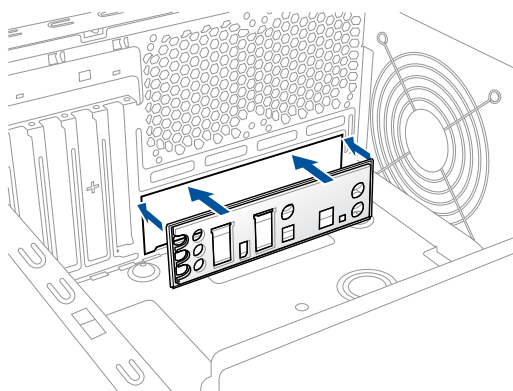

2. Place the motherboard into the chassis, ensuring that its rear I/O ports are aligned to the chassis' rear I/O panel.

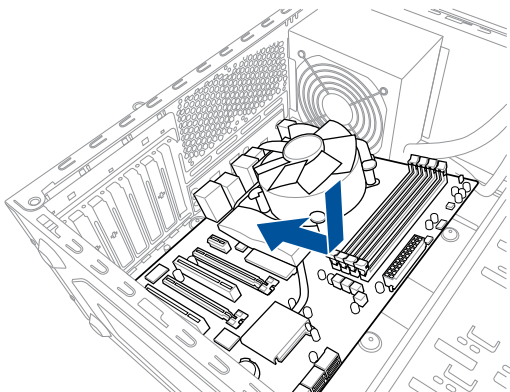

3. Place nine (9) screws into the holes indicated by circles to secure the motherboard to the chassis.

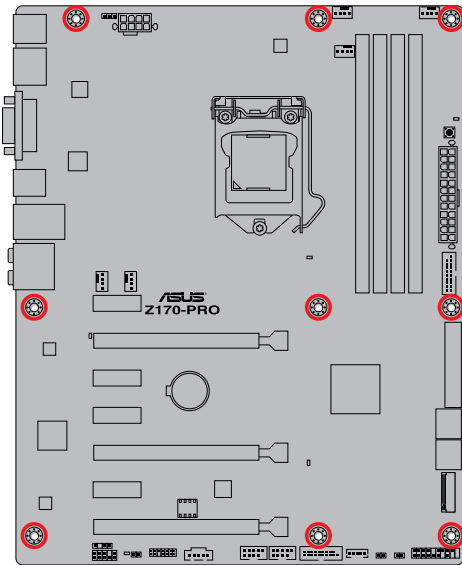
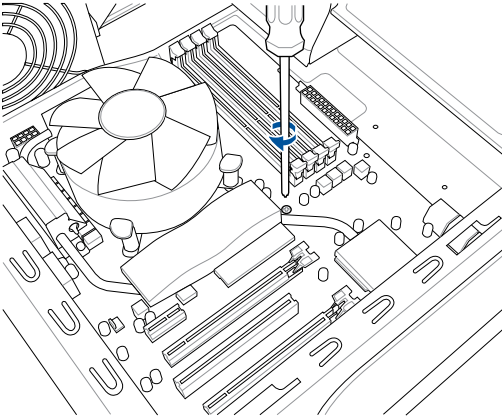

DO NOT overtighten the screws! Doing so can damage the motherboard.

## 2.1.2 CPU installation



Ensure that you install the correct CPU designed for LGA1151 socket only. DO NOT install a CPU designed for LGA1155 and LGA1156 sockets on the LGA1151 socket.

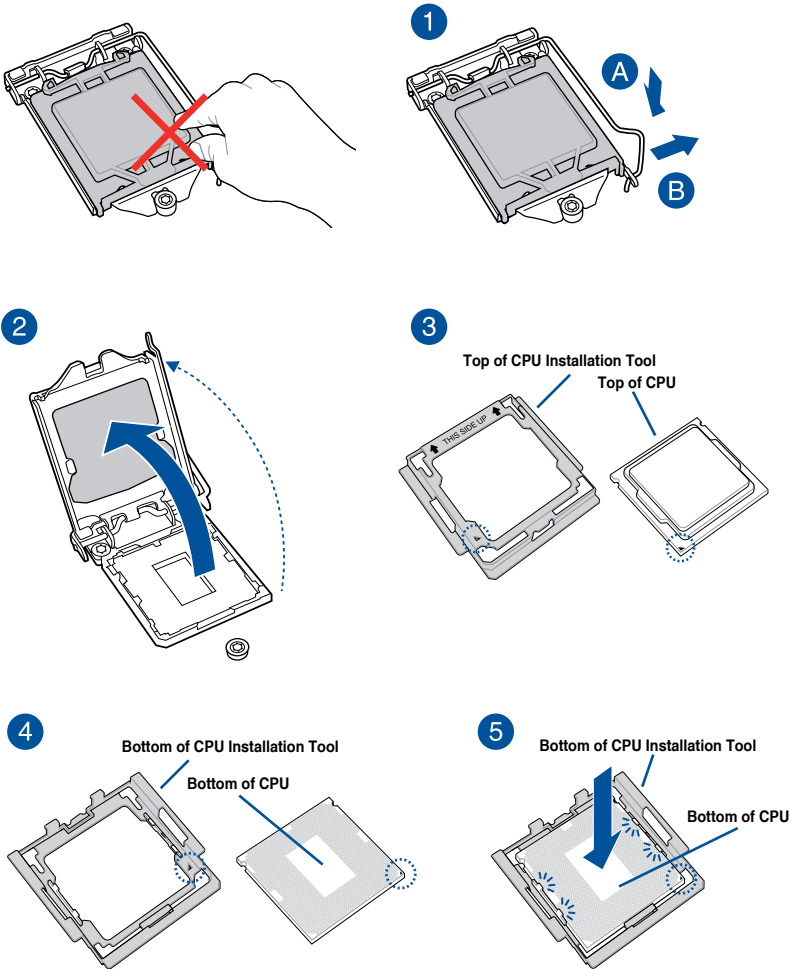

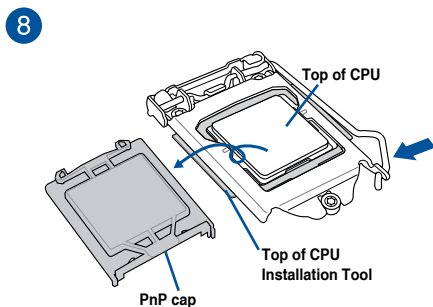
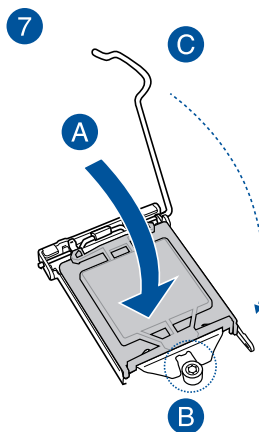
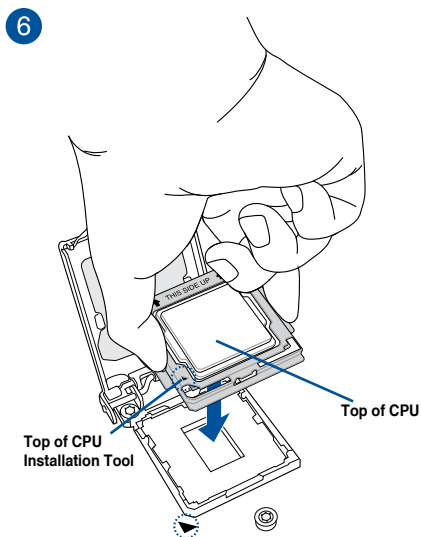

- The CPU Installation Tool is only compatible on ASUS motherboards with an Intel® LGA1151 socket.
- Ensure that the CPU is firmly clicked into place before installing it onto the CPU socket on the motherboard.
- Use the CPU Installation Tool for installing the CPU only. DO NOT damage or bend the CPU Installation Tool.
- Always firmly hold both sides of the CPU Installation Tool when installing, removing, or picking up the CPU Installation Tool.
- Ensure to use a soft stable surface when installing the CPU to the CPU Installation Tool to prevent CPU damage.
- ASUS will not cover damages resulting from incorrect CPU installation/removal, incorrect CPU orientation/placement, or other damages resulting from negligence by the user.

## 2.1.3 CPU heatsink and fan assembly installation

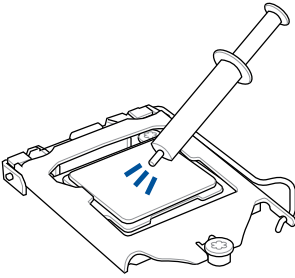

Apply the Thermal Interface Material to the CPU heatsink and CPU before you install the heatsink and fan, if necessary.

To install the CPU heatsink and fan assembly

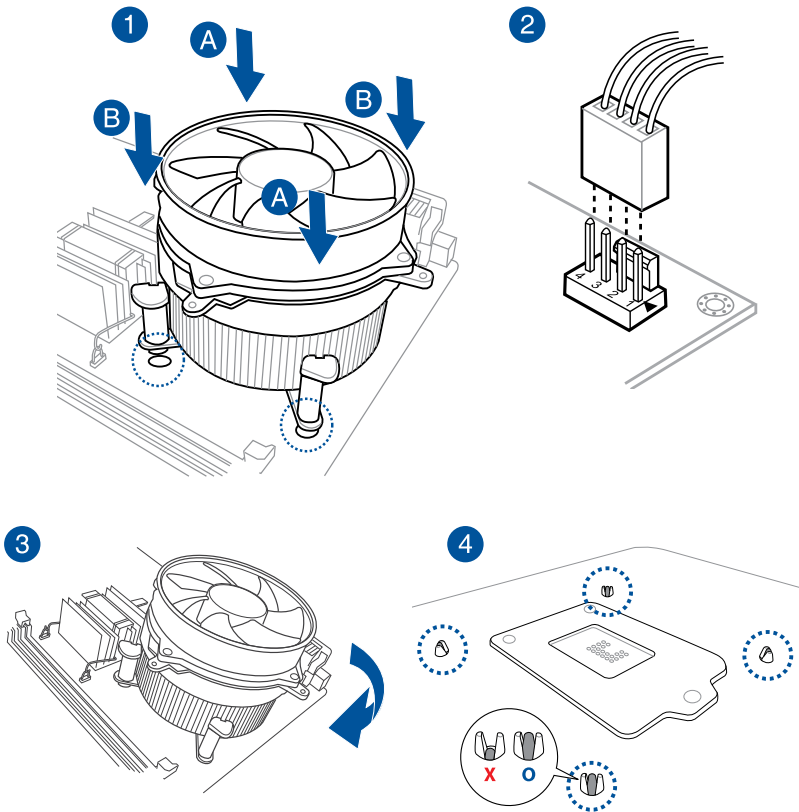

To uninstall the CPU heatsink and fan assembly

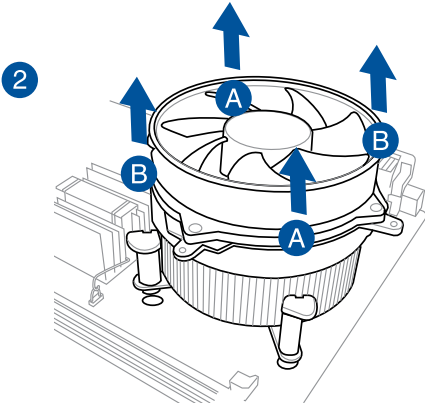
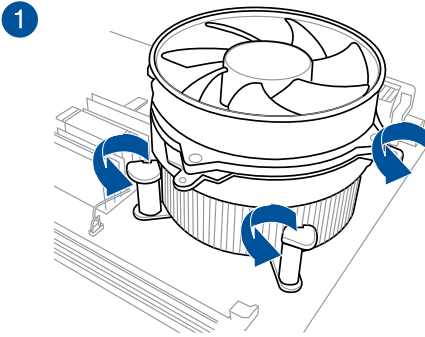



## 2.1.4 DIMM installation

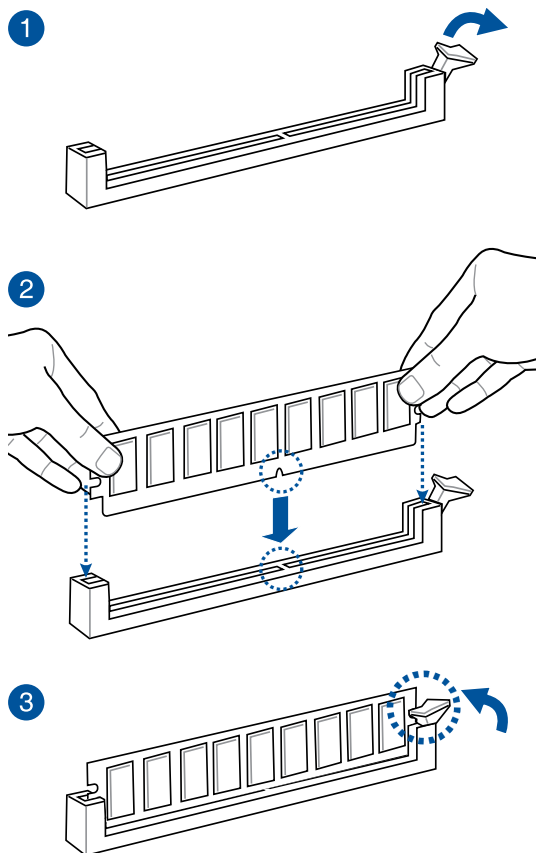

To remove a DIMM

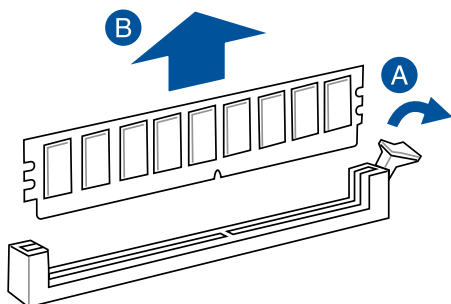

## 2.1.5 ATX Power connection

1

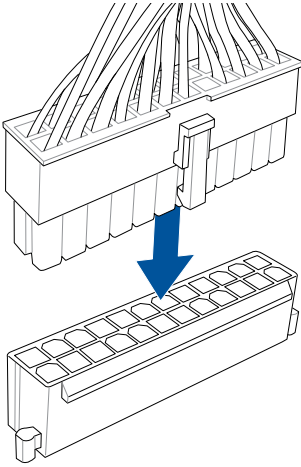

2

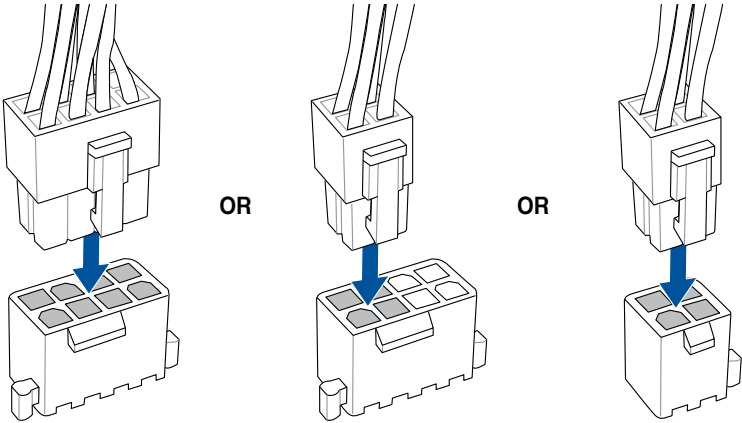

## 2.1.6 SATA device connection

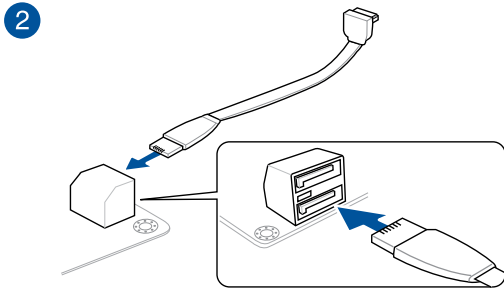
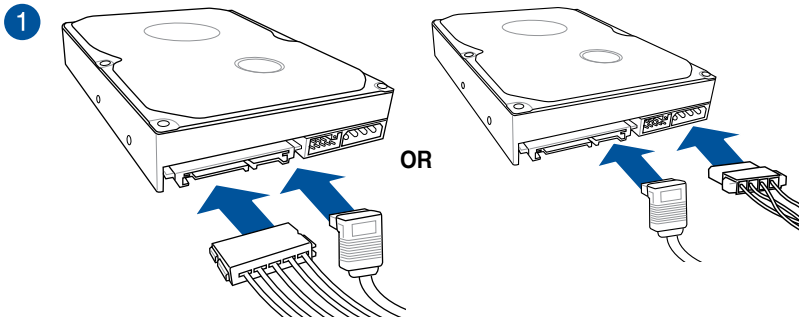

## 2.1.7 Front I/O Connector

### To install ASUS Q-Connector

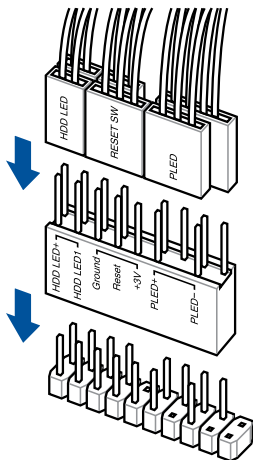

### To install USB 2.0 connector

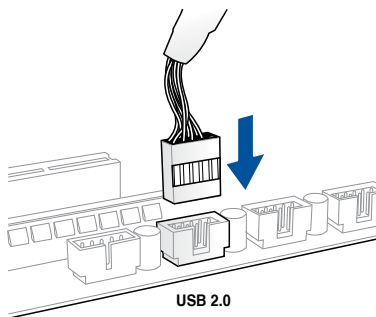

### To install front panel audio connector

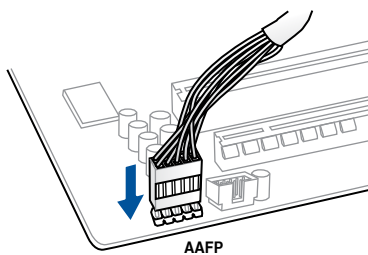

### To install USB 3.0 connector

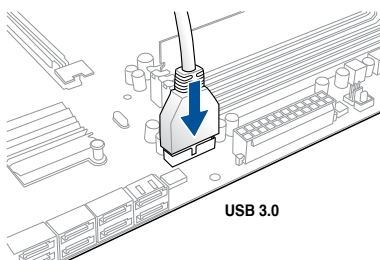

## 2.1.8 Expansion Card installation

To install PCIe x16 cards

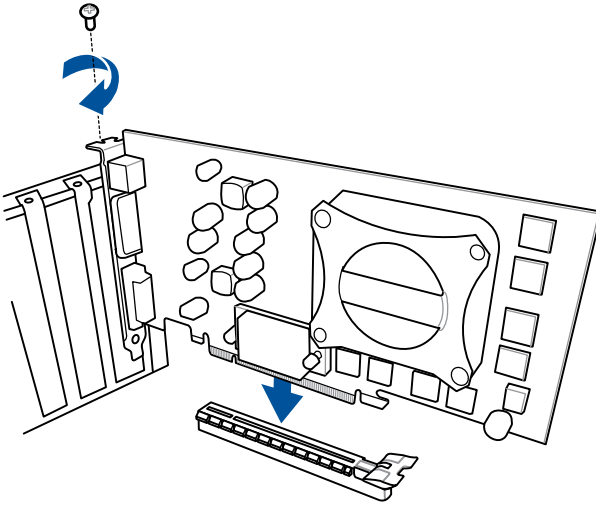

To install PCIe x1 cards

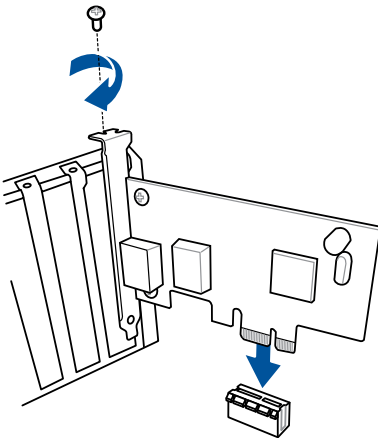

## 2.2 Motherboard rear and audio connections

### 2.2.1 Rear I/O connection

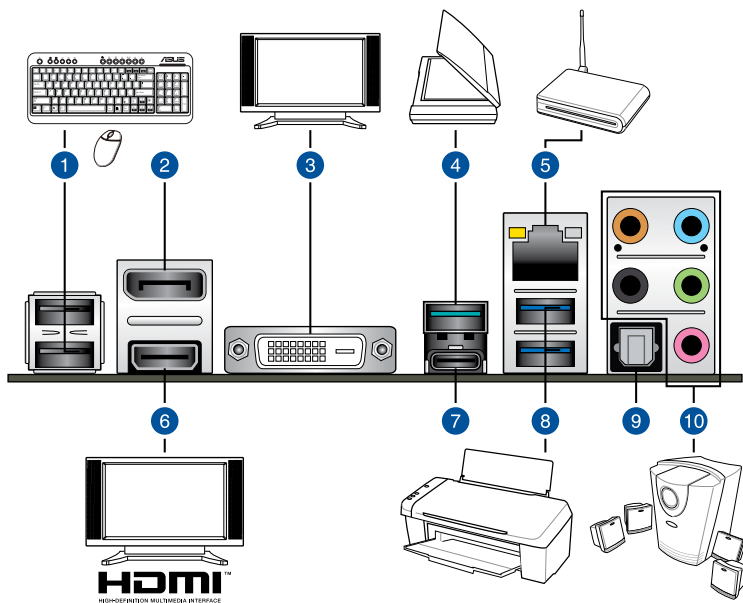

#### Rear panel connectors

1.	USB 2.0 port 9 and 10	6.	HDMI 1.4 port
2.	DisplayPort	7.	USB Type-C port EC1 (supports USB 3.1 Boost)
3.	DVI port	8.	USB 3.0 port 5 and 6 (supports USB 3.1 Boost)
4.	USB 3.1 ports EA2 (supports USB 3.1 Boost)	9.	Optical S/PDIF OUT port
5.	Intel® LAN port (I219-V)*	10.	Audio I/O ports*

\* and \*\*: Refer to the tables on the next page for LAN port LEDs, and audio port definitions.



- USB 3.0 devices can only be used as data storage only.
- We strongly recommend that you connect USB 3.1/3.0 devices to USB 3.1/3.0 ports for faster and better performance for your USB devices.
- Multi-VGA output supports up to two displays under Windows® OS environment or BIOS, and one display under DOS.
- Intel display architecture design supports the following maximum supported pixel clocks (Pixel Clock = H total x V Total x Frame Rate (Fresh screen rate)):
  - DisplayPort: 675 MHz
  - HDMI port: 300 MHz
  - DVI port: 148 MHz

### \* LAN ports LED indications

Activity Link LED		Speed LED	
Status	Description	Status	Description
Off	No link	Off	10 Mbps connection
Orange	Linked	Orange	100 Mbps connection
Orange (Blinking)	Data activity	Green	1 Gbps connection
Orange (Blinking then steady)	Ready to wake up from S5 mode		

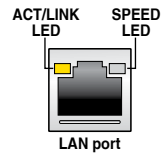

You can disable the LAN controllers in BIOS. Due to hardware design, the LAN1 port's LEDs may continue to blink even when disabled.

### \*\* Audio 2.1, 4.1, 5.1 or 7.1-channel configuration

Port	Headset 2.1-channel	4.1-channel	5.1-channel	7.1-channel
Light Blue	Line In	Line In	Line In	Side Speaker Out
Lime	Line Out	Front Speaker Out	Front Speaker Out	Front Speaker Out
Pink	Mic In	Mic In	Mic In	Mic In
Orange	–	–	Center/Sub woofer	Center/Sub woofer
Black	–	Rear Speaker Out	Rear Speaker Out	Rear Speaker Out

## 2.2.2 Audio I/O connections

### Audio I/O ports

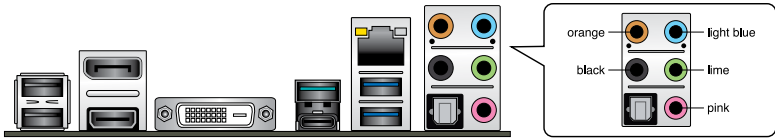

### Connect to Headphone and Mic

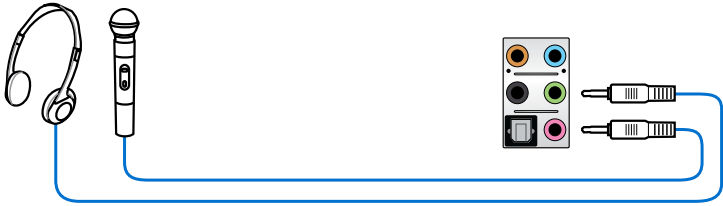

### Connect to Stereo Speakers

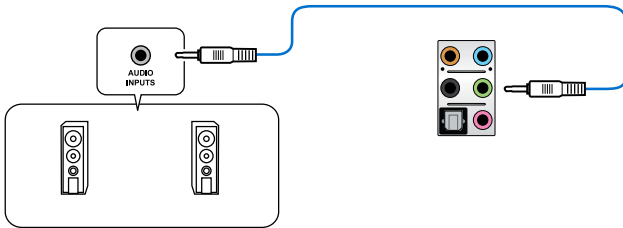

### Connect to 2.1 channel Speakers

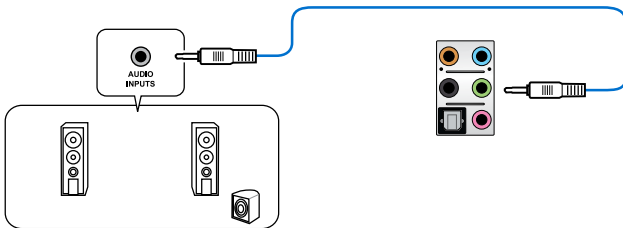



### Connect to 4.1 channel Speakers

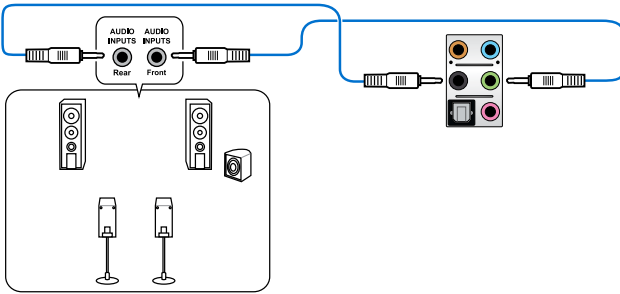

### Connect to 5.1 channel Speakers

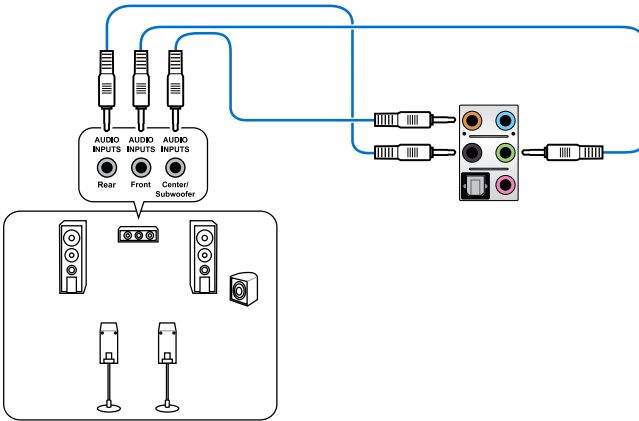

### Connect to 7.1 channel Speakers

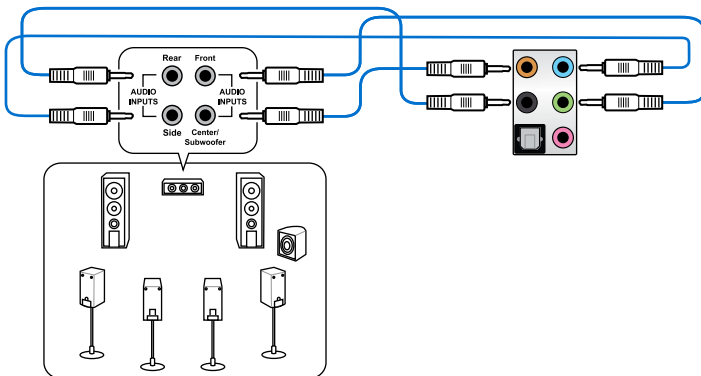

## 2.3 Starting up for the first time

1. After making all the connections, replace the system case cover.
2. Ensure that all switches are off.
3. Connect the power cord to the power connector at the back of the system chassis.
4. Connect the power cord to a power outlet that is equipped with a surge protector.
5. Turn on the devices in the following order:
  - a. Monitor
  - b. External SCSI devices (starting with the last device on the chain)
  - c. System power
6. After applying power, the system power LED on the system front panel case lights up. For systems with ATX power supplies, the system LED lights up when you press the ATX power button. If your monitor complies with the “green” standards or if it has a “power standby” feature, the monitor LED may light up or change from orange to green after the system LED turns on.

The system then runs the power-on self tests (POST). While the tests are running, the BIOS beeps (refer to the BIOS beep codes table) or additional messages appear on the screen. If you do not see anything within 30 seconds from the time you turned on the power, the system may have failed a power-on test. Check the jumper settings and connections or call your retailer for assistance.

BIOS Beep	Description
One short beep	VGA detected Quick boot set to disabled No keyboard detected
One continuous beep followed by two short beeps then a pause (repeated)	No memory detected
One continuous beep followed by three short beeps	No VGA detected
One continuous beep followed by four short beeps	Hardware component failure

7. At power on, hold down the <Delete> key to enter the BIOS Setup. Follow the instructions in Chapter 3.

## 2.4 Turning off the computer

While the system is ON, press the power button for less than four seconds to put the system on sleep mode or soft-off mode, depending on the BIOS setting. Press the power switch for more than four seconds to let the system enter the soft-off mode regardless of the BIOS setting.

# BIOS Setup

# 3

## 3.1 Knowing BIOS



---

The new ASUS UEFI BIOS is a Unified Extensible Interface that complies with UEFI architecture, offering a user-friendly interface that goes beyond the traditional keyboard-only BIOS controls to enable a more flexible and convenient mouse input. You can easily navigate the new UEFI BIOS with the same smoothness as your operating system. The term "BIOS" in this user manual refers to "UEFI BIOS" unless otherwise specified.

---

BIOS (Basic Input and Output System) stores system hardware settings such as storage device configuration, overclocking settings, advanced power management, and boot device configuration that are needed for system startup in the motherboard CMOS. In normal circumstances, the default BIOS settings apply to most conditions to ensure optimal performance. **DO NOT change the default BIOS settings** except in the following circumstances:

- An error message appears on the screen during the system bootup and requests you to run the BIOS Setup.
- You have installed a new system component that requires further BIOS settings or update.



---

Inappropriate BIOS settings may result to instability or boot failure. **We strongly recommend that you change the BIOS settings only with the help of a trained service personnel.**

---



---

When downloading or updating the BIOS file, rename it as **Z170P.CAP** for this motherboard.

---

## 3.2 BIOS setup program

Use the BIOS Setup to update the BIOS or configure its parameters. The BIOS screen include navigation keys and brief onscreen help to guide you in using the BIOS Setup program.

### Entering BIOS at startup

To enter BIOS Setup at startup, press <Delete> during the Power-On Self Test (POST). If you do not press <Delete>, POST continues with its routines.

### Entering BIOS Setup after POST

To enter BIOS Setup after POST:

- Press <Ctrl>+<Alt>+<Delete> simultaneously.
- Press the reset button on the system chassis.
- Press the power button to turn the system off then back on. Do this option only if you failed to enter BIOS Setup using the first two options.

After doing either of the three options, press <Delete> key to enter BIOS.



- 
- The BIOS setup screens shown in this section are for reference purposes only, and may not exactly match what you see on your screen.
  - Ensure that a USB mouse is connected to your motherboard if you want to use the mouse to control the BIOS setup program.
  - If the system becomes unstable after changing any BIOS setting, load the default settings to ensure system compatibility and stability. Select the **Load Optimized Defaults** item under the **Exit** menu or press hotkey <F5>. See section 3.10 **Exit Menu** for details.
  - If the system fails to boot after changing any BIOS setting, try to clear the CMOS and reset the motherboard to the default value. See section 1.2.6 **Onboard buttons and switches** for information on how to erase the RTC RAM via the Clear CMOS button.
  - The BIOS setup program does not support the Bluetooth devices.
- 

### BIOS menu screen

The BIOS Setup program can be used under two modes: **EZ Mode** and **Advanced Mode**. You can change modes from the **Exit** menu or from the **Exit/Advanced Mode** screen.

### 3.2.1 EZ Mode

By default, the EZ Mode screen appears when you enter the BIOS setup program. The EZ Mode provides you an overview of the basic system information, and allows you to select the display language, system performance mode and boot device priority. To access the Advanced Mode, click **Exit/Advanced Mode**, then select **Advanced Mode** or press <F7> hotkey for the advanced BIOS settings.



The default screen for entering the BIOS setup program can be changed between EZ Mode or Advanced Mode. Refer to the Setup Mode item in section 3.8 **Boot menu** for details.

The screenshot shows the ASUS UEFI BIOS Utility - EZ Mode interface. The top bar displays the date (02/03/2015), time (12:01), language (English), and EZ Tuning Wizard (F11). The main area is divided into several sections: Information (CPU/motherboard temperature, CPU voltage, fan speed, SATA info), DRAM Status, X.M.P., FAN Profile, Intel Rapid Storage Technology, CPU FAN speed graph, EZ System Tuning (Normal, Quiet, Energy Saving), and Boot Priority. The bottom bar contains navigation options: Default (F5), Save & Exit (F10), Advanced Mode (F7), and Search on FAQ.

**Displays the system properties of the selected mode. Click < > to switch EZ System Tuning modes**

**Displays the CPU/motherboard temperature, CPU voltage output, CPU/chassis/power fan speed, and SATA information**

**Selects the display language of the BIOS setup program**

**Creates storage RAID and configures system overclocking**

**Enables or disables the SATA RAID mode for Intel Rapid Storage Technology**

**Displays the CPU Fan's speed. Click the button to manually tune the fans**

**Loads optimized default settings**

**Saves the changes and resets the system**

**Click to go to Advanced mode**

**Search on the FAQ**

**Click to display boot devices**

**Selects the boot device priority**



The boot device options vary depending on the devices you installed to the system.

### 3.2.2 Advanced Mode

The Advanced Mode provides advanced options for experienced end-users to configure the BIOS settings. The figure below shows an example of the Advanced Mode. Refer to the following sections for the detailed configurations.



To switch from EZ Mode to Advanced Mode, click **Advanced Mode** or press <F7> hotkey.

The screenshot shows the ASUS UEFI BIOS Utility in Advanced Mode. The interface includes a menu bar at the top with options like Language, MyFavorite(F3), Qfan Control(F6), EZ Tuning Wizard(F11), and Quick Note(F9). The main area is divided into sections: My Favorites, Main, Ai Tweaker, Advanced, Monitor, Boot, Tool, and Exit. The Ai Tweaker section is expanded, showing settings for AI Overclock Tuner, ASUS MultiCore Enhancement, CPU Core Ratio, DRAM Odd Ratio Mode, DRAM Frequency, TPU, EPU Power Saving Mode, CPU SVID Support, and DRAM Timing Control. The Hardware Monitor section on the right displays CPU and Memory status, including frequency, voltage, and temperature. A scroll bar and hot keys are visible at the top right. A footer contains version information and a search bar for the FAQ.

**Configuration fields**

**Pop-up Menu**

**Menu bar** Language MyFavorite(F3) Qfan Control(F6) EZ Tuning Wizard(F11) Quick Note(F9) Scroll bar Hot Keys

**My Favorites** Main **Ai Tweaker** Advanced Monitor Boot Tool Exit

Target CPU Turbo-Mode Frequency : 2800MHz  
Target DRAM Frequency : 2133MHz  
Target Cache Frequency : 2800MHz

**AI Overclock Tuner** Auto

ASUS MultiCore Enhancement Auto

CPU Core Ratio Auto

DRAM Odd Ratio Mode Enabled

**DRAM Frequency** Auto

TPU Keep Current Settings

EPU Power Saving Mode Disabled

CPU SVID Support Auto

> DRAM Timing Control

**Hardware Monitor**

**CPU**

Frequency	Temperature
2200 MHz	46°C
BCLK	Core Voltage
100.0 MHz	0.944 V
Ratio	
22x	

**Memory**

Frequency	Voltage
2133 MHz	1.200 V
Capacity	
4096 MB	

**Voltage**

+12V	+5V
12.192 V	5.080 V
+3.3V	
3.328 V	

[Manual]: When the manual mode is selected, BCLK(base clock) frequency can be assigned manually.  
[XMP]: When XMP(extreme memory profile) mode is selected, BCLK frequency and memory parameters will be optimized automatically.

Version 2.17.1246. Copyright (C) 2015 American Megatrends, Inc.

Last Modified | EzMode(F7) | Search on FAQ

**Menu items** General help Last modified settings Go back to EZ Mode Search on the FAQ

**Sub-menu item** Displays the CPU temperature, CPU, and memory voltage output

## Menu bar

The menu bar on top of the screen has the following main items:

<b>My Favorites</b>	For saving the frequently-used system settings and configuration.
<b>Main</b>	For changing the basic system configuration
<b>Ai Tweaker</b>	For changing the overclocking settings
<b>Advanced</b>	For changing the advanced system settings
<b>Monitor</b>	For displaying the system temperature, power status, and changing the fan settings.
<b>Boot</b>	For changing the system boot configuration
<b>Tool</b>	For configuring options for special functions
<b>Exit</b>	For selecting the exit options and loading default settings

## Menu items

The highlighted item on the menu bar displays the specific items for that menu. For example, selecting **Main** shows the Main menu items.

The other items (My Favorites, Ai Tweaker, Advanced, Monitor, Boot, Tool, and Exit) on the menu bar have their respective menu items.

## Submenu items

A greater than sign (>) before each item on any menu screen means that the item has a submenu. To display the submenu, select the item and press <Enter>.

## Language

This button above the menu bar contains the languages that you can select for your BIOS. Click this button to select the language that you want to display in your BIOS screen.

## My Favorites (F3)

This button above the menu bar shows all BIOS items in a Tree Map setup. Select frequently-used BIOS settings and save it to MyFavorites menu.



---

Refer to section **3.3 My Favorites** for more information.

---

## Q-Fan Control (F6)

This button above the menu bar displays the current settings of your fans. Use this button to manually tweak the fans to your desired settings.



---

Refer to section **3.2.3 QFan Control** for more information.

---

## EZ Tuning Wizard (F11)

This button above the menu bar allows you to view and tweak the overclocking settings of your system. It also allows you to change the motherboard's SATA mode from AHCI to RAID mode.



---

Refer to section **3.2.4 EZ Tuning Wizard** for more information.

---

## Search on FAQ

Move your mouse over this button to show a QR code, scan this QR code on your mobile device to connect to the BIOS FAQ web page of the ASUS support website. You can also scan the following QR code:



## Quick Note (F9)

This button above the menu bar allows you to key in notes of the activities that you have done in BIOS.



- 
- The Quick Note function does not support the following keyboard functions: delete, cut, copy, and paste.
  - You can only use the alphanumeric characters to enter your notes.
- 

## Hot keys

This button above the menu bar contains the navigation keys for the BIOS setup program. Use the navigation keys to select items in the menu and change the settings.

## Scroll bar

A scroll bar appears on the right side of a menu screen when there are items that do not fit on the screen. Press the Up/Down arrow keys or <Page Up> / <Page Down> keys to display the other items on the screen.

## General help

At the top right corner of the menu screen is a brief description of the selected item. Use <F12> key to capture the BIOS screen and save it to the removable storage device.

## Configuration fields

These fields show the values for the menu items. If an item is user-configurable, you can change the value of the field opposite the item. You cannot select an item that is not user-configurable.

A configurable field is highlighted when selected. To change the value of a field, select it and press <Enter> to display a list of options.

## Last Modified button

This button shows the items that you last modified and saved in BIOS Setup.



### 3.2.3 QFan Control

The QFan Control allows you to set a fan profile or manually configure the operating speed of your CPU and chassis fans.

The screenshot shows the ASUS UEFI BIOS Utility in Advanced Mode. The Q-Fan Control section is active, displaying a list of fans to be configured: CPU FAN, CHA1 FAN, CHA2 FAN, EXT FAN1, EXT FAN2, and EXT FAN3. A graph shows fan speed (%) on the y-axis (0 to 100) and temperature (°C) on the x-axis (0 to 100). The graph is currently set to PWM mode. Below the graph, there are five fan profiles: Standard, Silent, Turbo, Full Speed, and Manual. The Manual profile is selected. At the bottom, there are buttons for Undo, Apply, and Exit (ESC). The interface also shows the date and time (01/30/2015, 05:51) and various utility icons like MyFavorite(F3), Qfan Control(F6), EZ Tuning Wizard(F11), Quick Note(F9), and Hot Keys.

Click to select a fan to be configured

Click to activate PWM Mode

Click to activate DC Mode

Select a profile to apply to your fans

Click to undo the changes

Click to apply the fan setting

Click to go back to main menu

Select to manually configure your fans

## Configuring fans manually

Select **Manual** from the list of profiles to manually configure your fans' operating speed.

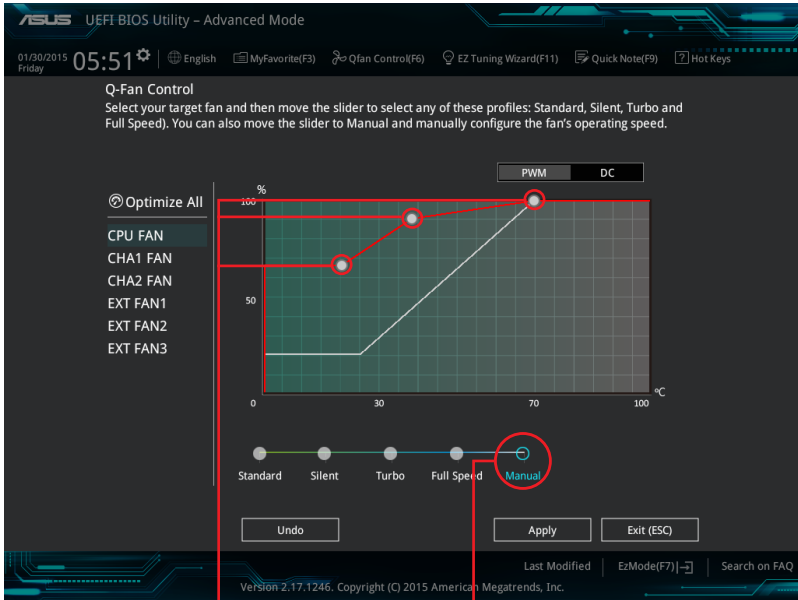

Speed points

Select to manually  
configure your fans

To configure your fans:

1. Select the fan that you want to configure and to view its current status.
2. Click and drag the speed points to adjust the fans' operating speed.
3. Click **Apply** to save the changes then click **Exit (ESC)**.

## 3.2.4 EZ Tuning Wizard

EZ Tuning Wizard allows you to easily overclock your CPU and DRAM, computer usage, and CPU fan to their best settings. You can also set RAID in your system using this feature.

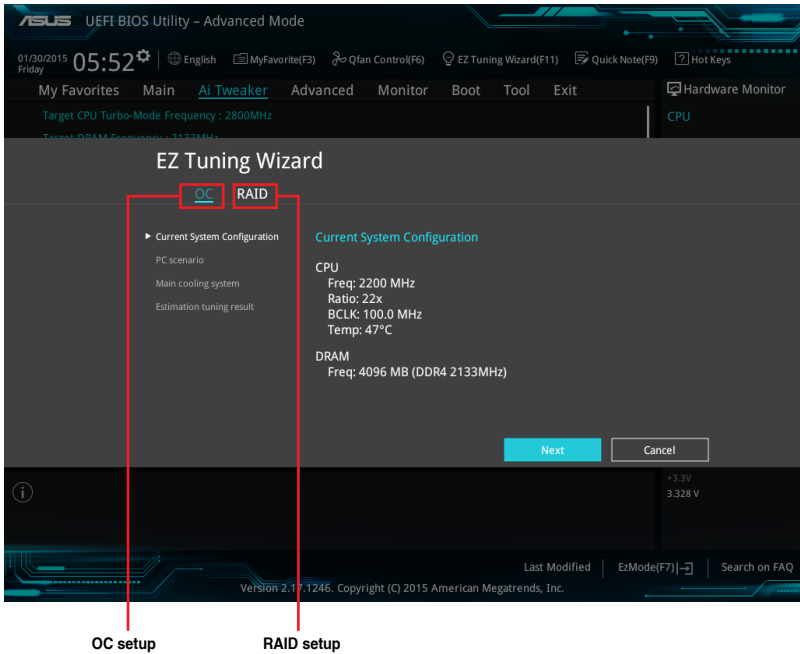

### OC Tuning

To start OC Tuning:

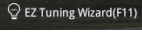
1. Press <F11> on your keyboard or click  from the BIOS screen to open EZ Tuning Wizard screen.
2. Click **OC** then click **Next**.
3. Select a PC scenario **Daily Computing** or **Gaming/Media Editing**, then click **Next**.

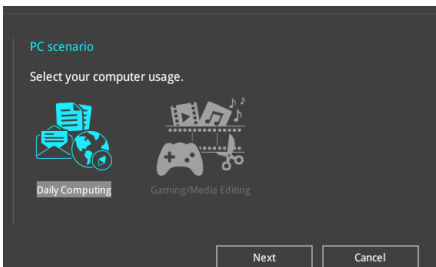

4. Select a Main Cooling System **BOX cooler**, **Tower cooler**, **Water cooler**, or **I'm not sure**, then click **Next**.

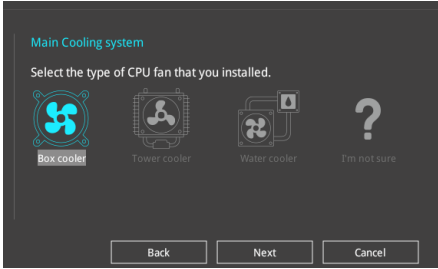

5. After selecting the Main Cooling System, click **Next** then click **Yes** to start the OC Tuning.

## Creating RAID

To create RAID:

1. Press <F11> on your keyboard or click **EZ Tuning Wizard(F11)** from the BIOS screen to open EZ Tuning Wizard screen.
2. Click **RAID** then click **Next**.



- Ensure that your HDDs have no existing RAID volumes.
- Ensure to connect your HDDs to Intel® SATA connectors.

3. Select the port that you want to set to [RAID] mode, **PCIe** or **SATA**, then click **Next**.

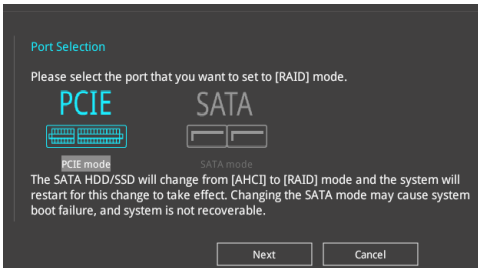

4. Select the type of storage for your RAID, **Easy Backup** or **Super Speed**, then click **Next**.

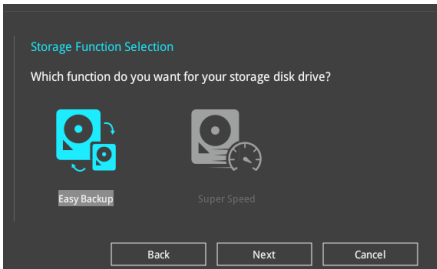

- a. For Easy Backup, click **Next** then select from **Easy Backup (RAID1)** or **Easy Backup (RAID10)**.

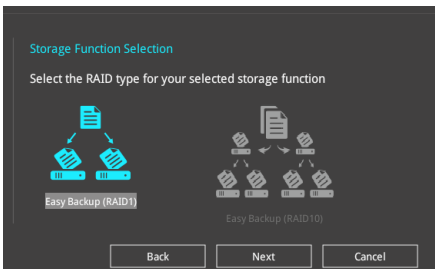

---

You can only select Easy Backup (RAID 10) if you connect four (4) HDDs.

---

- b. For Super Speed, click **Next** then select from **Super Speed (RAID0)** or **Super Speed (RAID5)**.

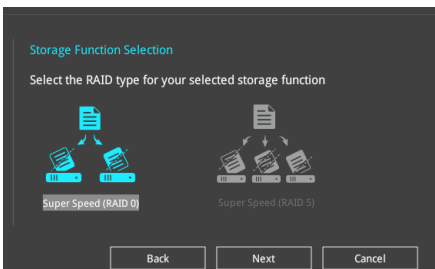

5. After selecting the type of RAID, click **Next** then click **Yes** to continue the RAID setup.
6. After the RAID setup is done, click **Yes** to exit the setup then click **OK** to reset your system.

### 3.3 My Favorites

My Favorites is your personal space where you can easily save and access your favorite BIOS items.

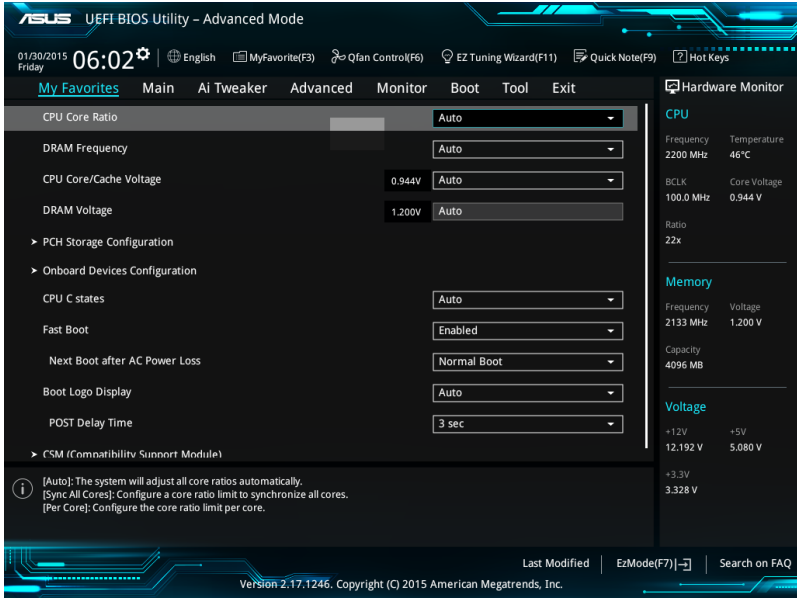



My Favorites comes with several performance, power saving, and fast boot related items by default. You can personalize this screen by adding or removing items.

## Adding items to My Favorites

To add BIOS items:

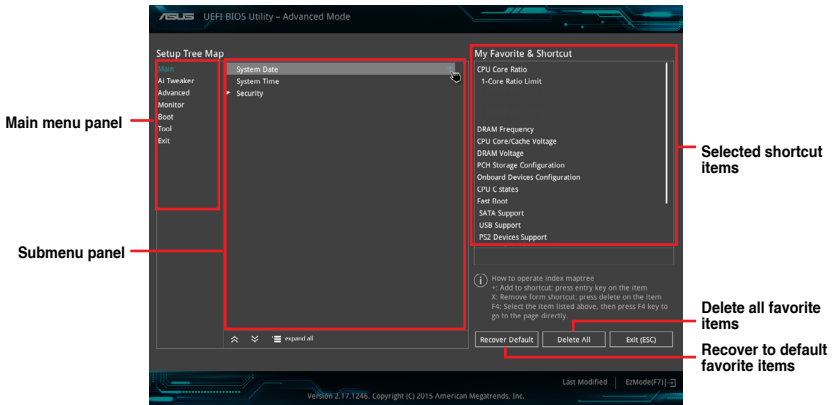
1. Press <F3> on your keyboard or click  (F3)MyFavorite from the BIOS screen to open Setup Tree Map screen.
2. On the Setup Tree Map screen, select the BIOS items that you want to save in My Favorites screen.



3. Select an item from main menu panel, then click the submenu that you want to save as favorite from the submenu panel and click  or press <Enter> on your keyboard.



You cannot add the following items to My Favorite items:

- Items with submenu options
- User-managed items such as language and boot order
- Configuration items such as Memory SPD Information, system time and date.

4. Click **Exit (ESC)** or press <Esc> key to close Setup Tree Map screen.
5. Go to My Favorites menu to view the saved BIOS items.

### 3.4 Main menu

The Main menu screen appears when you enter the Advanced Mode of the BIOS Setup program. The Main menu provides you an overview of the basic system information, and allows you to set the system date, time, language, and security settings.

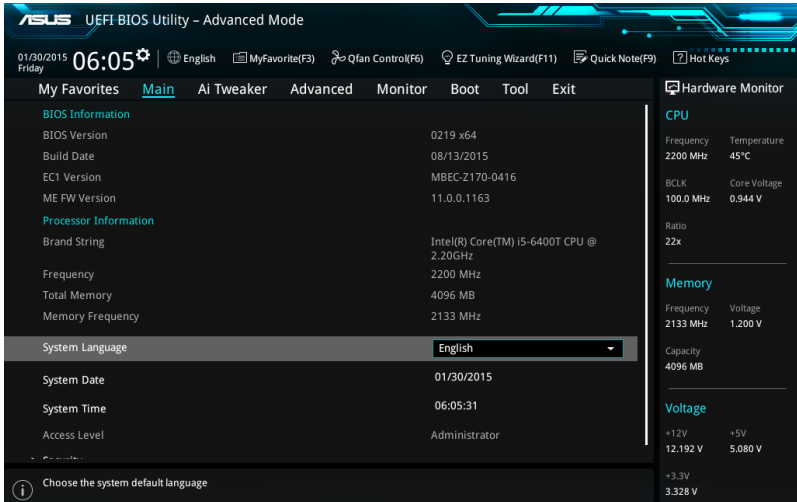

### Security

The Security menu items allow you to change the system security settings.

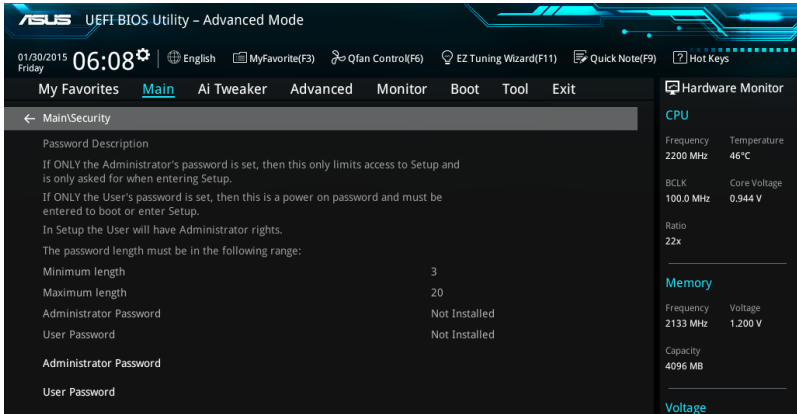

- If you have forgotten your BIOS password, erase the CMOS Real Time Clock (RTC) RAM to clear the BIOS password. See section 1.2.6 Onboard buttons and switches for information on how to erase the RTC RAM via the Clear CMOS button.
- The Administrator or User Password items on top of the screen show the default **[Not Installed]**. After you set a password, these items show **[Installed]**.



## Administrator Password

If you have set an administrator password, we recommend that you enter the administrator password for accessing the system. Otherwise, you might be able to see or change only selected fields in the BIOS setup program.

### To set an administrator password:

1. Select the **Administrator Password** item and press <Enter>.
2. From the **Create New Password** box, key in a password, then press <Enter>.
3. Confirm the password when prompted.

### To change an administrator password:

1. Select the **Administrator Password** item and press <Enter>.
2. From the **Enter Current Password** box, key in the current password, then press <Enter>.
3. From the **Create New Password** box, key in a new password, then press <Enter>.
4. Confirm the password when prompted.

To clear the administrator password, follow the same steps as in changing an administrator password, but press <Enter> when prompted to create/confirm the password. After you clear the password, the **Administrator Password** item on top of the screen shows **[Not Installed]**.

## User Password

If you have set a user password, you must enter the user password for accessing the system. The User Password item on top of the screen shows the default **[Not Installed]**. After you set a password, this item shows **[Installed.]**

### To set a user password:

1. Select the **User Password** item and press <Enter>.
2. From the **Create New Password** box, key in a password, then press <Enter>.
3. Confirm the password when prompted.

## To change a user password:

1. Select the **User Password** item and press <Enter>.
2. From the **Enter Current Password** box, key in the current password, then press <Enter>.
3. From the **Create New Password** box, key in a new password, then press <Enter>.
4. Confirm the password when prompted.

To clear the user password, follow the same steps as in changing a user password, but press <Enter> when prompted to create/confirm the password. After you clear the password, the **User Password** item on top of the screen shows **[Not Installed]**.

## 3.5 Ai Tweaker menu

The Ai Tweaker menu items allow you to configure overclocking-related items.



Be cautious when changing the settings of the Ai Tweaker menu items. Incorrect field values can cause the system to malfunction.



The configuration options for this section vary depending on the CPU and DIMM model you installed on the motherboard.

Scroll down to display other BIOS items.

ASUS UEFI BIOS Utility - Advanced Mode

01/20/2015 Friday 06:09 English MyFavorite(F3) Qfan Control(F6) EZ Tuning Wizard(F11) Quick Note(F9) Hot Keys

My Favorites Main **Ai Tweaker** Advanced Monitor Boot Tool Exit

Target CPU Turbo-Mode Frequency : 2800MHz  
Target DRAM Frequency : 2133MHz  
Target Cache Frequency : 2800MHz

AI Overclock Tuner **Auto**

ASUS MultiCore Enhancement **Auto**

CPU Core Ratio **Auto**

DRAM Odd Ratio Mode **Enabled**

DRAM Frequency **Auto**

TPU **Keep Current Settings**

EPU Power Saving Mode **Disabled**

CPU SVID Support **Auto**

▶ DRAM Timing Control

[Manual]: When the manual mode is selected, BCLK(base clock) frequency can be assigned manually.  
[XMP]: When XMP(extreme memory profile) mode is selected, BCLK frequency and memory parameters will be optimized automatically.

Hardware Monitor

**CPU**

Frequency	Temperature
2200 MHz	46°C
BCLK	Core Voltage
100.0 MHz	0.944 V
Ratio	
22x	

**Memory**

Frequency	Voltage
2133 MHz	1.200 V
Capacity	
4096 MB	

**Voltage**

+12V	+5V
12.192 V	5.080 V
+3.3V	
3.328 V	

Last Modified | EzMode(F7) | Search on FAQ

Version 2.17.1246, Copyright (C) 2015 American Megatrends, Inc.

## Ai Overclock Tuner [Auto]

This item allows you to select the CPU overclocking options to achieve the desired CPU internal frequency. Select any of these preset overclocking configuration options:

- [Auto]            Loads the optimal settings for the system.
- [Manual]        Automatically optimizes the CPU ratio and BCLK frequency.
- [XMP]            If you install memory modules supporting the eXtreme Memory Profile (XMP) Technology, choose this item to set the profiles supported by your memory modules for optimizing the system performance.



---

The following item appears only when you set the Ai Overclocking Tuner to **[Manual]**.

---

### BCLK Frequency [100.00]

This item allows you to set the BCLK (base clock) frequency to enhance the system performance. Use the <+> or <-> to adjust the value. The values range from 40.0 MHz to 650.0 MHz.



---

We recommend you to set the value based on the CPU specification, as high BCLK frequencies may damage the CPU permanently.

---

## ASUS MultiCore Enhancement [Auto]

- [Auto]            This item allows you to maximize the overlocking performance optimized by ASUS core ratio settings.
- [Disabled]       This item allows you to set to default core ratio settings.

## CPU Core Ratio [Auto]

This item allows you to set the CPU core ratio limit per core or synchronize automatically to all cores.

Configuration options: [Auto] [Sync All Cores] [Per Core]



---

When the CPU Core Ratio is set to **[Synch All Cores]**, the following item appears:

---

### 1-Core Ratio Limit [Auto]

Select **[Auto]** to apply the CPU default Turbo Ratio setting or manually assign a 1-Core Limit value that must be higher than or equal to the 2-Core Ratio Limit.



---

When the CPU Core Ratio is set to **[Per Core]**, the following item appears:

---

### 1-Core Ratio Limit [Auto]

Select **[Auto]** to apply the CPU default Turbo Ratio setting or manually assign a 1-Core Limit value that must be higher than or equal to the 2-Core Ratio Limit.

**2-Core Ratio Limit [Auto]**

Select **[Auto]** to apply the CPU default Turbo Ratio setting or manually assign a 2-Core Limit value that must be higher than or equal to the 3-Core Ratio Limit.

**3-Core Ratio Limit [Auto]**

Select **[Auto]** to apply the CPU default Turbo Ratio setting or manually assign a 3-Core Limit value that must be higher than or equal to the 4-Core Ratio Limit.

**4-Core Ratio Limit [Auto]**

Select **[Auto]** to apply the CPU default Turbo Ratio setting or manually assign a 4-Core Limit value that must be higher than or equal to the 3-Core Ratio Limit.



If you assign a value for more Core Ratio Limit, do not set the less Core Ratio Limit to **[Auto]**.

**DRAM Odd Ratio Mode [Enabled]**

This item allows you to enable or disable the odd ratio mode for better granularity.

Configuration options: [Disabled] [Enabled]

**DRAM Frequency [Auto]**

This item allows you to set the memory operating frequency. The configurable options vary with the BCLK (base clock) frequency setting. Select the auto mode to apply the optimized setting.

Configuration options: [DDR4-800MHz] [DDR4-933MHz] [DDR4-1066MHz] [DDR4-1200MHz] [DDR4-1333MHz] [DDR4-1466MHz] [DDR4-1600MHz] [DDR4-1733MHz] [DDR4-1866MHz] [DDR4-2000MHz] [DDR4-2133MHz] [DDR4-2266MHz] [DDR4-2400MHz] [DDR4-2533MHz] [DDR4-2666MHz] [DDR4-2800MHz] [DDR4-2933MHz] [DDR4-3066MHz] [DDR4-3200MHz] [DDR4-3333MHz] [DDR4-3466MHz] [DDR4-3600MHz] [DDR4-3733MHz] [DDR4-3866MHz] [DDR4-4000MHz] [DDR4-4133MHz] [DDR4-4266MHz]

**TPU [Keep Current Settings]**

This item allows you to automatically overclock the CPU and DRAM frequencies and voltage for an enhanced system performance.

[Keep Current Settings] Keep the current settings without changing anything.

[TPU I] Applies air cooling overclocking conditions.

[TPU II] Applies water cooling overclocking conditions.



Ensure to use water cooling device before selecting **[TPU II]**.

**EPU Power Saving Mode [Disabled]**

The ASUS EPU (Energy Processing Unit) sets the CPU in its minimum power consumption settings.

Configuration options: [Disabled] [Enabled]

**CPU SVID Support [Auto]**

Disable this item to stop the CPU from communicating with the external voltage regulator.

Configuration options: [Auto] [Disabled] [Enabled]

## DRAM Timing Control

The subitems in this menu allow you to set the DRAM timing control features. Use the <+> or <-> keys to adjust the value. To restore the default setting, type [auto] using the keyboard and press the <Enter> key.



Changing the values in this menu may cause the system to become unstable! If this happens, revert to the default settings.

### Primary Timings

#### **DRAM CAS# Latency [Auto]**

Configuration options: [Auto] [1] – [31]

#### **DRAM RAS# to CAS# Delay [Auto]**

Configuration options: [Auto] [1] – [31]

#### **DRAM RAS# ACT Time [Auto]**

Configuration options: [Auto] [1] – [63]

#### **DRAM COMMAND Rate [Auto]**

Configuration options: [Auto] [1] – [2]

### Secondary Timings

#### **DRAM RAS# to RAS# Delay L [Auto]**

Configuration options: [Auto] [1] – [15]

#### **DRAM RAS# to RAS# Delay S [Auto]**

Configuration options: [Auto] [1] – [15]

#### **DRAM REF Cycle Time [Auto]**

Configuration options: [Auto] [1] – [1023]

#### **DRAM Refresh Interval [Auto]**

Configuration options: [Auto] [1] – [32767]

#### **DRAM WRITE Recovery Time [Auto]**

Configuration options: [Auto] [1] – [31]

#### **DRAM READ to PRE Time [Auto]**

Configuration options: [Auto] [1] – [15]

#### **DRAM FOUR ACT WIN Time [Auto]**

Configuration options: [Auto] [1] – [63]

#### **DRAM WRITE to READ Delay [Auto]**

Configuration options: [Auto] [1] – [15]

#### **DRAM WRITE to READ Delay L [Auto]**

Configuration options: [Auto] [1] – [15]

#### **DRAM WRITE to READ Delay S [Auto]**

Configuration options: [Auto] [1] – [15]

### **DRAM CKE Minimum Pulse Width [Auto]**

Configuration options: [Auto] [1] – [15]

### **DRAM Write Latency [Auto]**

Configuration options: [Auto] [1] – [31]

### **Skew Control**

#### ***ODT RTT WR (CHA) [Auto]***

Configuration options: [Auto] [0 DRAM CLOCK] [80 DRAM CLOCK] [120 DRAM CLOCK] [240 DRAM CLOCK] [255 DRAM CLOCK]

#### ***ODT RTT PARK (CHA) [Auto]***

Configuration options: [Auto] [0 DRAM CLOCK] [34 DRAM CLOCK] [40 DRAM CLOCK] [48 DRAM CLOCK] [60 DRAM CLOCK] [80 DRAM CLOCK] [120 DRAM CLOCK] [240 DRAM CLOCK]

#### ***ODT RTT NOM (CHA) [Auto]***

Configuration options: [Auto] [0 DRAM CLOCK] [34 DRAM CLOCK] [40 DRAM CLOCK] [48 DRAM CLOCK] [60 DRAM CLOCK] [80 DRAM CLOCK] [120 DRAM CLOCK] [240 DRAM CLOCK]

#### ***ODT RTT WR (CHB) [Auto]***

Configuration options: [Auto] [0 DRAM CLOCK] [80 DRAM CLOCK] [120 DRAM CLOCK] [240 DRAM CLOCK] [255 DRAM CLOCK]

#### ***ODT RTT PARK (CHB) [Auto]***

Configuration options: [Auto] [0 DRAM CLOCK] [34 DRAM CLOCK] [40 DRAM CLOCK] [48 DRAM CLOCK] [60 DRAM CLOCK] [80 DRAM CLOCK] [120 DRAM CLOCK] [240 DRAM CLOCK]

#### ***ODT RTT NOM (CHB) [Auto]***

Configuration options: [Auto] [0 DRAM CLOCK] [34 DRAM CLOCK] [40 DRAM CLOCK] [48 DRAM CLOCK] [60 DRAM CLOCK] [80 DRAM CLOCK] [120 DRAM CLOCK] [240 DRAM CLOCK]

#### ***ODT\_READ\_DURATION [Auto]***

Configuration options: [Auto] [0] - [7]

#### ***ODT\_READ\_DELAY [Auto]***

Configuration options: [Auto] [0] - [7]

#### ***ODT\_WRITE\_DURATION [Auto]***

Configuration options: [Auto] [0] - [7]

#### ***ODT\_WRITE\_DELAY [Auto]***

Configuration options: [Auto] [0] - [7]

#### ***Data Rising Slope [Auto]***

Configuration options: [Auto] [0] - [15]

#### ***Data Rising Slope Offset [Auto]***

Configuration options: [Auto] [0] - [1]

#### ***CMD Rising Slope [Auto]***

Configuration options: [Auto] [0] - [15]

#### ***CMD Rising Slope Offset [Auto]***

Configuration options: [Auto] [0] - [1]

#### ***Ctl Rising Slope [Auto]***

Configuration options: [Auto] [0] - [15]

**Ctl Rising Slope Offset [Auto]**

Configuration options: [Auto] [0] - [1]

**Clk Rising Slope [Auto]**

Configuration options: [Auto] [0] - [15]

**Clk Rising Slope Offset [Auto]**

Configuration options: [Auto] [0] - [1]

**Data Falling Slope [Auto]**

Configuration options: [Auto] [0] - [15]

**Data Falling Slope Offset [Auto]**

Configuration options: [Auto] [0] - [1]

**CMD Falling Slope [Auto]**

Configuration options: [Auto] [0] - [15]

**CMD Falling Slope Offset [Auto]**

Configuration options: [Auto] [0] - [1]

**Ctl Falling Slope [Auto]**

Configuration options: [Auto] [0] - [15]

**Ctl Falling Slope Offset [Auto]**

Configuration options: [Auto] [0] - [1]

**Clk Falling Slope [Auto]**

Configuration options: [Auto] [0] - [15]

**Clk Falling Slope Offset [Auto]**

Configuration options: [Auto] [0] - [1]

**RTL IOL control****DRAM RTL INIT Value [Auto]**

Configuration options: [Auto] [0] - [127]

**DRAM RTL (CHA DIMM0 Rank0) [Auto]**

Configuration options: [Auto] [0] - [127]

**DRAM RTL (CHA DIMM0 Rank1) [Auto]**

Configuration options: [Auto] [0] - [127]

**DRAM RTL (CHA DIMM1 Rank0) [Auto]**

Configuration options: [Auto] [0] - [127]

**DRAM RTL (CHA DIMM1 Rank1) [Auto]**

Configuration options: [Auto] [0] - [127]

**DRAM RTL (CHB DIMM0 Rank0) [Auto]**

Configuration options: [Auto] [0] - [127]

**DRAM RTL (CHB DIMM0 Rank1) [Auto]**

Configuration options: [Auto] [0] - [127]

**DRAM RTL (CHB DIMM1 Rank0) [Auto]**

Configuration options: [Auto] [0] - [127]

**DRAM RTL (CHB DIMM1 Rank1) [Auto]**

Configuration options: [Auto] [0] - [127]

**DRAM IOL (CHA DIMM0 Rank0) [Auto]**

Configuration options: [Auto] [0] - [15]

**DRAM IOL (CHA DIMM0 Rank1) [Auto]**

Configuration options: [Auto] [0] - [15]

**DRAM IOL (CHA DIMM1 Rank0) [Auto]**

Configuration options: [Auto] [0] - [15]

**DRAM IOL (CHA DIMM1 Rank1) [Auto]**

Configuration options: [Auto] [0] - [15]

**DRAM IOL (CHB DIMM0 Rank0) [Auto]**

Configuration options: [Auto] [0] - [15]

**DRAM IOL (CHB DIMM0 Rank1) [Auto]**

Configuration options: [Auto] [0] - [15]

**DRAM IOL (CHB DIMM1 Rank0) [Auto]**

Configuration options: [Auto] [0] - [15]

**DRAM IOL (CHB DIMM1 Rank1) [Auto]**

Configuration options: [Auto] [0] - [15]

**IO Latency offset****CHA IO\_Latency\_offset**

Configuration options: [Auto] [0] - [127]

**CHB IO\_Latency\_offset**

Configuration options: [Auto] [0] - [127]

**IO Latency RFR delay****CHA RFR delay**

Configuration options: [Auto] [0] - [127]

**CHB RFR delay**

Configuration options: [Auto] [0] - [127]

**Third Timings****tRDRD\_sg [Auto]**

Configuration options: [Auto] [0] - [63]

**tRDRD\_dg [Auto]**

Configuration options: [Auto] [0] - [63]

**tRDWR\_sg [Auto]**

Configuration options: [Auto] [0] - [63]

**tRDWR\_dg [Auto]**

Configuration options: [Auto] [0] - [63]

**tWRWR\_sg [Auto]**

Configuration options: [Auto] [0] - [63]

**tWRWR\_dg [Auto]**

Configuration options: [Auto] [0] - [63]

**tWRRD\_sg [Auto]**

Configuration options: [Auto] [0] - [127]

**tWRRD\_dg [Auto]**

Configuration options: [Auto] [0] - [63]

**tRDRD\_dr [Auto]**

Configuration options: [Auto] [0] - [63]



**tRDRD\_dd [Auto]**

Configuration options: [Auto] [0] - [63]

**tRDWR\_dr [Auto]**

Configuration options: [Auto] [0] - [63]

**tRDWR\_dd [Auto]**

Configuration options: [Auto] [0] - [63]

**tWRWR\_dr [Auto]**

Configuration options: [Auto] [0] - [63]

**tWRWR\_dd [Auto]**

Configuration options: [Auto] [0] - [63]

**tWRRD\_dr [Auto]**

Configuration options: [Auto] [0] - [63]

**tWRRD\_dd [Auto]**

Configuration options: [Auto] [0] - [63]

**TWRPRE [Auto]**

Configuration options: [Auto] [0] - [127]

**TRDPRE [Auto]**

Configuration options: [Auto] [0] - [15]

**tREFIX9 [Auto]**

Configuration options: [Auto] [0] - [127]

**OREF\_RI [Auto]**

Configuration options: [Auto] [0] - [255]

**Misc.****MRC Fast Boot [Auto]**

Allows you to enable, disable or automatically set the MRC fast boot.

Configuration options: [Auto] [Enabled] [Disabled]

**DRAM CLK Period [Auto]**

Configuration options: [Auto] [1] - [26]

**Memory Scrambler [Enabled]**

Set this item to enable or disable memory scrambler support.

Configuration options: [Enabled] [Disabled]

**Channel A DIMM Control [Enable Both DIMMs]**

Allows you to enable or disable the Channel A DIMM slots.

Configuration options: [Enable Both DIMMs] [Disable DIMM0] [Disable DIMM1]  
[Disable Both DIMMs]

**Channel B DIMM Control [Enable Both DIMMs]**

Allows you to enable or disable the Channel B DIMM slots.

Configuration options: [Enable Both DIMMs] [Disable DIMM0] [Disable DIMM1]  
[Disable Both DIMMs]

### MCH Full Check [Auto]

Enable this item to enhance the stability of your system. Disable this item to enhance the DRAM overlocking capability.

Configuration options: [Auto] [Enabled] [Disabled]

### DLLBwEn [Auto]

Configuration options: [Auto] [1] - [7]

## DIGI+ VRM

### CPU Load-line Calibration [Auto]

Load-line is defined by Intel® specification and affects CPU power voltage. The CPU working voltage decreases proportionally to CPU loading. Higher load-line calibration could get higher voltage and good overlocking performance, but increases the CPU and VRM thermal conditions. Select from levels 1 to 7 to adjust the CPU power voltage from 0% to 100%.

Configuration options [Auto] [Level 1] - [Level 7]



---

The actual performance boost may vary depending on your CPU specification.

---



---

DO NOT remove the thermal module. The thermal conditions should be monitored.

---

### CPU Current Capability [Auto]

This item provides a total power range for CPU overlocking. A higher value setting provides higher power consumption delivery and extends the overlocking frequency range simultaneously.

Configuration options: [Auto] [100%] [110%] [120%] [130%] [140%]



---

Configure higher values when overlocking or under a high CPU loading for extra power support.

---

### CPU VRM Switching Frequency [Auto]

This item affects the VRM transient response speed and the component thermal production. Select [Manual] to configure a higher frequency for a quicker transient response speed.

Configuration options: [Auto] [Manual]



---

DO NOT remove the thermal module. The thermal conditions should be monitored.

---



---

The following item appears only when you set the CPU VRM Switching Frequency to [Manual].

---

### **Fixed CPU VRM Switching Frequency (KHz) [300]**

This item allows you to set a higher frequency for a quicker transient response speed. Use the <+> or <-> to adjust the value. The values range from 250 KHz to 500 KHz with an interval of 50 KHz.



---

Do not remove the thermal module when the manual mode is selected. The thermal conditions should be monitored.

---



---

The following item appears only when the CPU VRM Switching Frequency is set to **[Auto]**.

---

#### **VRM Spread Spectrum [Auto]**

This item allows to enhance the system stability.

Configuration options: [Auto] [Disabled] [Enabled]

#### **CPU Power Duty Control [T.Probe]**

DIGI + VRM Duty Control adjusts the current of every VRM phase and the thermal conditions of every phase component.

[T. Probe]                      Select to set the VRM thermal balance mode.

[Extreme]                      Select to set the VRM current balance mode.



---

DO NOT remove the thermal module. The thermal conditions should be monitored.

---

#### **CPU Power Phase Control [Auto]**

This item allows you to set the power phase control of the CPU.

Configuration options: [Auto] [Standard] [Optimized] [Extreme]

#### **CPU Graphics Load-line Calibration [Auto]**

The load-line is defined by the Intel VRM specification and affects the GT power voltage. The GT working voltage will decrease proportionally depending on the GT loading.

Configuration options: [Auto] [Level 0] - [Level 10]



---

The boosted performance may vary depending on the GT specification. DO NOT remove the thermal module.

---

#### **CPU Graphics Current Capability [Auto]**

This item adjusts the total power range for GT overclocking. A higher value setting provides higher power consumption delivery and extends the overclocking frequency range simultaneously.

Configuration options: [Auto] [100%] [110%] [120%] [130%] [140%]



---

Configure higher values when overclocking or under a high GT loading for extra power support.

---

#### **CPU Graphics Switching Frequency [Auto]**

The switching frequency will affect the GT transient response speed and the component thermal production.

Configuration options: [Auto] [Manual]



---

DO NOT remove the thermal module. The thermal conditions should be monitored.

---



---

The following item appears only when you set the **CPU Graphics Switching Frequency** to **[Manual]**.

---

**Fixed CPU Graphics Switching Frequency (KHz) [300]**

This item allows you to set a higher frequency for a quicker transient response speed and component thermal production. Use the <+> or <-> to adjust the value. The values range from 250 KHz to 500 KHz with an interval of 50 KHz.

**CPU Graphics Power Phase Control [Auto]**

This item allows you to set the power phase control of the CPU Graphics. Configuration options: [Auto] [Standard] [Optimized] [Extreme]



---

DO NOT remove the thermal module. The thermal conditions should be monitored.

---

**Boot Voltages**

**CPU Core/Cache Boot Voltage [Auto]**

Configuration options: [Auto] [0.600] - [1.700]

**DMI Boot Voltage [Auto]**

Configuration options: [Auto] [0.300] - [1.900]

**CPU System Agent Boot Voltage [Auto]**

Configuration options: [Auto] [0.7000] - [1.8000]

**CPU VCCIO Boot Voltage [Auto]**

Configuration options: [Auto] [0.7000] - [1.8000]

**CPU Standby Boot Voltage [Auto]**

Configuration options: [Auto] [0.7000] - [2.2000]

**Internal CPU Power Management**

The subitems in this menu allow you to set the CPU ratio and features.

**Intel(R) SpeedStep(tm) [Auto]**

Allows the operating system to dynamically adjust the processor voltage and cores frequency to decrease the average power consumption and decrease average heat production.

Configuration options: [Auto] [Disabled] [Enabled]

**Turbo Mode [Enabled]**

Allows you to enable your processor cores to run faster than the base operating frequency when it is below power, current and specification limit.

Configuration options: [Disabled] [Enabled]



---

The following items appear only when you set the Turbo Mode to **[Enabled]**.

---

**Turbo Mode Parameters****Long Duration Package Power Limit [Auto]**

Allows you to limit the Turbo Ratio's time duration that exceeds the TDP (Thermal Design Power) for maximum performance. Use the <+> and <-> keys to adjust the value.

Configuration options: [Auto] [1] - [4095]

**Package Power Time Window [Auto]**

Also known as Power Limit 1, and allows you to maintain the time window for Turbo Ratio over TDP (Thermal Design Power). Use the <+> and <-> keys to adjust the value.

Configuration options: [Auto] [1] - [127]

**Short Duration Package Power Limit [Auto]**

As known as Power Limit 2, and allows you to provide rapid protection when the package power exceeds the Power Limit 1. Use the <+> and <-> keys to adjust the value.

Configuration options: [Auto] [1] - [4095]

**IA AC Load Line [Auto]**

This item allows you to set the AC loadline defined in 1/100 mOhms. Use the <+> and <-> keys to adjust the value.

Configuration options: [Auto] [0.01] - [62.49]

**IA DC Load Line [Auto]**

This item allows you to set the DC loadline defined in 1/100 mOhms. Use the <+> and <-> keys to adjust the value.

Configuration options: [Auto] [0.01] - [62.49]

**Tweaker's Paradise****FCLK Frequency for Early Power On [Auto]**

This item allows you to set the FCLK frequency.

Configuration: [Auto] [Normal (800Mhz)] [1 GHz] [400 MHz]

**Initial BCLK Frequency [Auto]**

This item allows you to start overclocking the system from the initial BCLK (base clock) frequency to the assigned BCLK frequency. Use the <+> or <-> to adjust the value.

The values range from 40.0 MHz to 650.0 MHz.

**BCLK Amplitude [Auto]**

This item allows you to set the magnitude of the base clock driven for the processor.

Configuration options: [Auto] [700mV] [800mV] [900mV] [1000mV]

**BCLK Slew Rate [Auto]**

This item allows you to set the speed at which each clock rises and falls.

Configuration options: [Auto] [1.5V/ns] [2.5V/ns] [3.5V/ns] [4.5V/ns]

**BCLK Spread Spectrum [Auto]**

This item allows you to reduce the EMI. Diable to get more accurate base clocks.

Configuration options: [Auto] [Disabled] [-0.22] [-0.34] [-0.46] [+0.12] [+0.22] [+0.28] [+0.38] [+0.17]

**BCLK Frequency Slew Rate [Auto]**

Configuration options: [Auto] [Disabled] [32us/MHz] [64us/MHz] [128us/MHz] [512us/MHz]

**VPPDDR Voltage [Auto]**

Configuration options: [Auto] [1.865] - [2.700]

**DMI Voltage [Auto]**

Configuration options: [Auto] [0.30000] - [1.90000]

**Internal PLL Voltage [Auto]**

Configuration options: [Auto] [0.90000] - [1.84500]

**CPU Core/Cache Current Limit Max. [Auto]**

This item allows you to configure a higher current limit to prevent a frequency or power throttling when overclocking. Use the <+> and <-> keys to adjust the value.

Configuration options: [Auto] [0.00] - [255.50]

**CPU Graphics Current Limit Max. [Auto]**

This item allows you to configure a higher current limit to prevent a frequency or power throttling when overclocking. Use the <+> and <-> keys to adjust the value.

Configuration options: [Auto] [0.00] - [255.50]

**Min. CPU Cache Ratio [Auto]**

This item allows you to set the minimum possible CPU cache ratio. Use the <+> and <-> keys to adjust the value.

Configuration options: [Auto] [8] - [33]

**Max. CPU Cache Ratio [Auto]**

This item allows you to set the maximum possible CPU cache ratio. Use the <+> and <-> keys to adjust the value.

Configuration options: [Auto] [8] - [33]

**Max. CPU Graphics Ratio [Auto]**

This item allows you to set the CPU graphics ratio. Use the <+> and <-> keys to adjust the value.

Configuration options: [Auto] [1] - [19]

**Extreme Over-voltage [Disabled]**

Enable this item to allow higher voltages for overclocking, but the CPU lifetime will not be guaranteed

Configuration options: [Disabled] [Enabled]



---

This item can only be enabled when the onboard CPU\_OV jumper is switched on.

---

**CPU Core/Cache Voltage [Auto]**

Configures the mode of Voltage fed to the cores of the processor.

Configuration options: [Auto] [Manual Mode] [Offset Mode] [Adaptive Mode]



---

The following items appear only when you set the CPU Core/Cache Voltage to **[Manual Mode]**.

---

### **CPU Core Voltage Override [Auto]**

Allows you to configure the CPU Core voltage.  
Configuration options: [Auto] [0.600] - [1.700]



---

The following items appear only when you set the CPU Core/Cache Voltage to **[Offset Mode]**.

---

### **Offset Mode Sign [+]**

- [+] To offset the voltage by a positive value.
- [-] To offset the voltage by a negative value.

### **CPU Core Voltage Offset [Auto]**

This item allows you to configure the CPU core voltage offset value.  
Configuration options: [Auto] [0.005] - [0.635]



---

The following items appear only when you set the CPU Core/Cache Voltage to **[Adaptive Mode]**.

---

### **Offset Mode Sign [-]**

- [+] To offset the voltage by a positive value.
- [-] To offset the voltage by a negative value.

### **Additional Turbo Mode CPU Core Voltage [Auto]**

This item allows you to configure the CPU core voltage offset value.  
Configuration options: [Auto] - [1.920]

### **Offset Voltage [Auto]**

This item allows you to configure the CPU core voltage offset value.  
Configuration options: [Auto] [0.001] - [0.999]

### **DRAM Voltage [Auto]**

Configuration options: [Auto] [1.0032] - [2.0064]

### **CPU VCCIO Voltage [Auto]**

Configuration options: [Auto] [0.70000] - [1.80000]

### **CPU System Agent Voltage [Auto]**

Configuration options: [Auto] [0.70000] - [1.80000]

### **CPU Graphics Voltage Mode [Auto]**

Configures the mode of Voltage fed to the CPU graphics.  
Configuration options: [Auto] [Manual Mode] [Offset Mode]



---

The following items appear only when you set the CPU Graphics Voltage Mode to **[Manual Mode]**.

---

### **CPU Graphics Voltage Override [Auto]**

Allows you to configure the CPU Graphics Voltage.

Configuration options: [Auto] [0.600] - [1.700]



---

The following items appear only when you set the CPU Graphics Voltage Mode to **[Offset Mode]**.

---

#### **Offset Mode Sign [+]**

[+] To offset the voltage by a positive value.

[-] To offset the voltage by a negative value.

#### **CPU Graphics Voltage Offset [Auto]**

This item allows you to configure the CPU core voltage offset value.

Configuration options: [Auto] [0.001] - [0.635]

### **PCH Core Voltage [Auto]**

Configuration options: [Auto] [0.70000] - [1.80000]

### **CPU Standby Voltage [Auto]**

Configuration options: [Auto] [0.80000] - [1.60000]

### **DRAM REF Voltage Control**

#### **DRAM CTRL REF Voltage on CHA/CHB [Auto]**

Configures the DRAM reference voltage on the control lines. The reference voltage will be the DRAM voltage times the configured value.

Configuration options: [Auto] [0.39500] - [0.63000]

#### **DRAM DATA REF Voltage on CHA DIMM0 Rank0 BL0-7 [Auto]**

Configures the DRAM Data REF Voltage.

Configuration options: [Auto] [0] - [63]

#### **DRAM DATA REF Voltage on CHA DIMM0 Rank1 BL0-7 [Auto]**

Configures the DRAM Data REF Voltage.

Configuration options: [Auto] [0] - [63]

#### **DRAM DATA REF Voltage on CHA DIMM1 Rank0 BL0-7 [Auto]**

Configures the DRAM Data REF Voltage.

Configuration options: [Auto] [0] - [63]

#### **DRAM DATA REF Voltage on CHA DIMM1 Rank1 BL0-7 [Auto]**

Configures the DRAM Data REF Voltage.

Configuration options: [Auto] [0] - [63]

#### **DRAM DATA REF Voltage on CHB DIMM0 Rank0 BL0-7 [Auto]**

Configures the DRAM Data REF Voltage.

Configuration options: [Auto] [0] - [63]

#### **DRAM DATA REF Voltage on CHB DIMM0 Rank1 BL0-7 [Auto]**

Configures the DRAM Data REF Voltage.



Configuration options: [Auto] [0] - [63]

### **DRAM DATA REF Voltage on CHB DIMM1 Rank0 BL0-7 [Auto]**

Configures the DRAM Data REF Voltage.

Configuration options: [Auto] [0] - [63]

### **DRAM DATA REF Voltage on CHB DIMM1 Rank1 BL0-7 [Auto]**

Configures the DRAM Data REF Voltage.

Configuration options: [Auto] [0] - [63]

## 3.6 Advanced menu

The Advanced menu items allow you to change the settings for the CPU and other system devices.



Be cautious when changing the settings of the Advanced menu items. Incorrect field values can cause the system to malfunction.

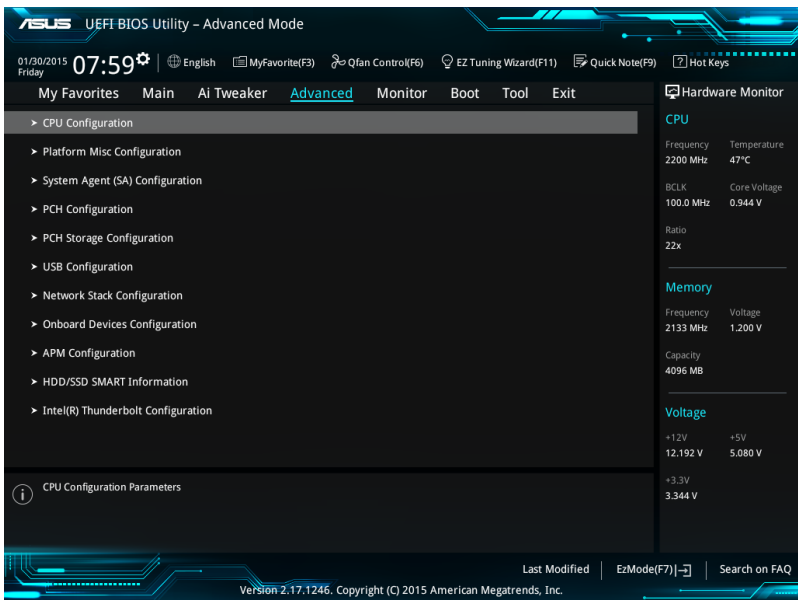

### 3.6.1 CPU Configuration

The items in this menu show the CPU-related information that the BIOS automatically detects.



The items in this menu may vary based on the CPU installed.

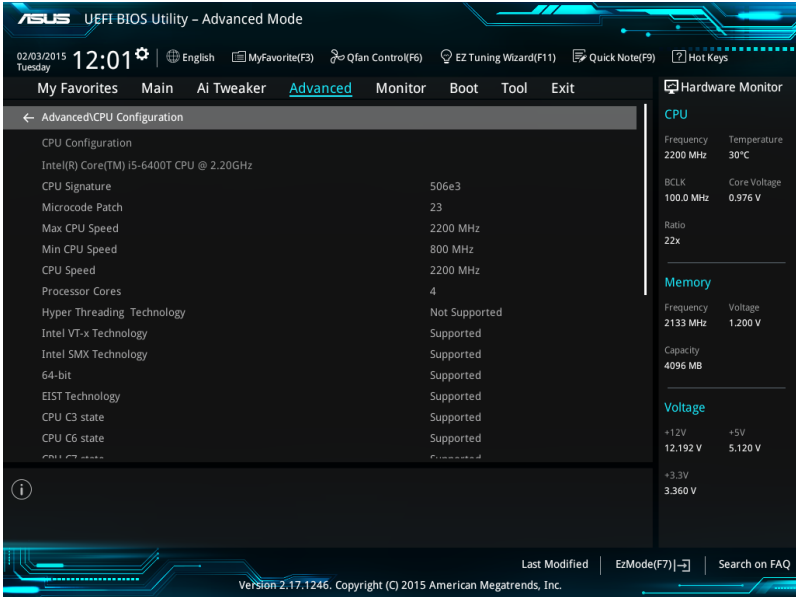

#### Active Processor Cores [All]

This item allows you to select the number of CPU cores to activate in each processor package.

Configuration options: [All] [1] [2] [3]

#### Intel Virtualization Technology [Enabled]

When set to [Enabled], a VMM can utilize the additional hardware capabilities provided by Vanderpool Technology.

Configuration options: [Disabled] [Enabled]

#### Hardware Prefetcher [Enabled]

This item allows the CPU to prefetch commands and data in the L2 cache, reduces the DRAM loading time and improves the system performance.

Configuration options: [Disabled] [Enabled]

**Adjacent Cache Line Prefetcher [Enabled]**

This item allows the mid level cache (L2) to prefetch adjacent cache lines, reducing the DRAM loading time and improves the system performance.

Configuration options: [Disabled] [Enabled]

**Boot Performance Mode [Auto]**

This item allows you to select the CPU performance state during system boot before the operating system takes control. The CPU runs at a selected performance ratio based on CPU configuration.

Configuration options: [Auto] [Max Non-Turbo Performance] [Max Battery] [Turbo Performance]

**CPU Power Management Configuration**

This item allows you to manage and configure the CPU's power.

**Intel SpeedStep(tm) [Auto]**

This item allows your system to adjust the CPU's voltage and cores frequency, resulting in decreased power consumption and heat production.

[Auto]

[Disabled]      The CPU runs at its default speed.

[Enabled]      The system controls the CPU speed.

**Turbo Mode [Enabled]**

This item allows you to automatically set the CPU cores to run faster than the base operating frequency when it is below the operating power, current and temperature specification limit.

Configuration options: [Enabled] [Disabled]

**CPU C-States [Auto]**

This item allows you to set the power saving of the CPU states.

Configuration options: [Auto] [Disabled] [Enabled]



---

The following items appear only when you set the CPU C-States to **[Enabled]**.

---

***Enhanced C-States [Disabled]***

When enabled, CPU will switch to minimum speed when all cores enter C-State.

Configuration options: [Enabled] [Disabled]

***CPU C3 Report [Enabled]***

This item allows you to disable or enable the CPU C3 report to the operating system.

Configuration options: [Enabled] [Disabled]

***CPU C6 Report [Enabled]***

This item allows you to disable or enable the CPU C6 report to the operating system.

Configuration options: [Enabled] [Disabled]

### **CPU C7 Report [CPU C7s]**

This item allows you to disable or enable the CPU C7 report to the operating system.

Configuration options: [Disabled] [CPU C7] [CPU C7s]

### **CPU C8 Report [Enabled]**

This item allows you to disable or enable the CPU C8 report to the operating system.

Configuration options: [Enabled] [Disabled]

### **Package C State Limit [Auto]**

This item allows you to set the a C-state limit for the CPU package.

Configuration options: [Auto] [Enabled] [C0/C1] [C2] [C3] [C6] [C7] [C7s] [C8]

### **CFG Lock [Disabled]**

This item allows you to disable or enable the CFG Lock.

Configuration options: [Enabled] [Disabled]

## **3.6.2 Platform Misc Configuration**

The items in this menu allow you to configure the platform-related features.

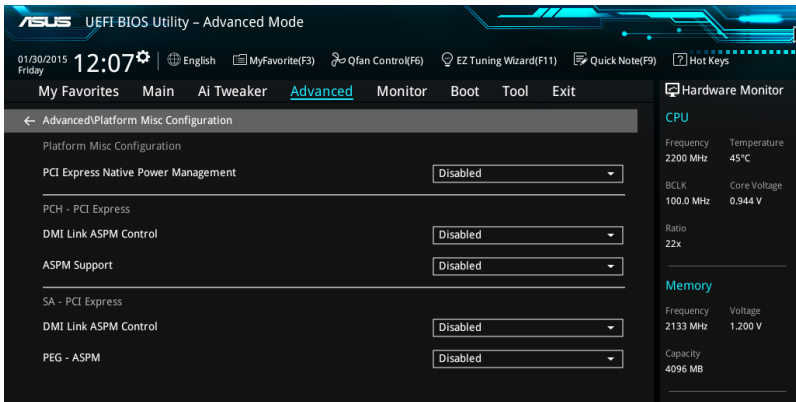

### **PCI Express Native Power Management [Disabled]**

This item allows you to enhance the power saving feature of PCI Express and perform ASPM operations in the operating system.

Configuration options: [Disabled] [Enabled]



The following item appears only when you set the PCI Express Native Power Management to **[Enabled]**.

### **Native ASPM [Disabled]**

[Enabled] Windows® Vista OS controls the ASPM (active state power management) support for devices.

[Disabled] BIOS controls the ASPM support for the device.

## PCH - PCI Express

### DMI Link ASPM Control [Disabled]

This item allows you to control the Active State Power Management on both NB (NorthBridge) side and SB (SouthBridge) side of the DMI Link.

Configuration options: [Disabled] [Enabled]

### ASPM Support [Disabled]

This item allows you to select the ASPM state for energy-saving conditions.

Configuration options: [Disabled] [L0s] [L1] [L0sL1] [Auto]

## SA - PCI Express

### DMI Link ASPM Control [Disabled]

This item allows you to control the Active State Power Management on both CPU and PCH (platform controller hub) Both DMI link ASPM control items of the CPU and PCH sides must be enabled for the ASPM to take effect.

Configuration options: [Disabled] [L1]

### PEG - ASPM [Disabled]

This item allows you to select the ASPM state for energy-saving conditions, or use the ASUS optimized energy saving profile.

Configuration options: [Disabled] [Auto] [ASPM L0s] [ASPM L1] [ASPM L0sL1]

## 3.6.3 System Agent (SA) Configuration

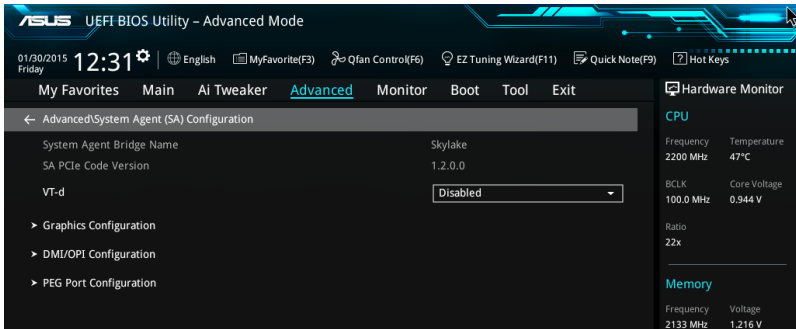

### VT-d [Disabled]

Allows you to enable virtualization technology function on memory control hub.

Configuration options: [Enabled] [Disabled]

### Graphics Configuration

This item allows you to select a primary display from CPU and PCIe graphical devices.

**Primary Display [Auto]**

This item allows you to select the primary display from CPU and PCIe devices.  
Configuration options: [Auto] [IGFX] [PEG] [PCIe]

**iGPU Multi-Monitor [Disabled]**

This item allows you to enable the iGPU Multi-Monitor. The iGPU shared system memory size is fixed 64 MB.  
Configuration options: [Disabled] [Enabled]

**RC6(Render standby) [Enabled]**

This item allows you to enable render standby support.  
Configuration options: [Disabled] [Enabled]

**DVMT Pre-Allocated [32M]**

This item allows you to select DVMT 5.0 Pre-Allocated (Fixed) Graphics Memory size used by the Internal Graphics Device.  
Configuration options: [32M] [64M] [96M] [128M] [160M] [192M] [224M] [256M] [288M] [320M] [352M] [384M] [416M] [448M] [480M] [512M]

**DMI/OPI Configuration**

This item allows you to control various DMI (direct media interface) functions.

**DMI Max Link Speed [Auto]**

Set this item to **[Enabled]** to set DMI speed.  
Configuration options: [Auto] [Gen1] [Gen2] [Gen3]

**PEG Port Configuration**

This item allows you to configure the PEG Port settings.

**PCIEx16\_1 Link Speed [Auto]**

This item allows you to configure the PCIEx16\_1 slot.  
Configuration options: [Auto] [Gen1] [Gen2] [Gen3]

**PCIEx16\_2 Link Speed [Auto]**

This item allows you to configure the PCIEx16\_2 slot.  
Configuration options: [Auto] [Gen1] [Gen2] [Gen3]

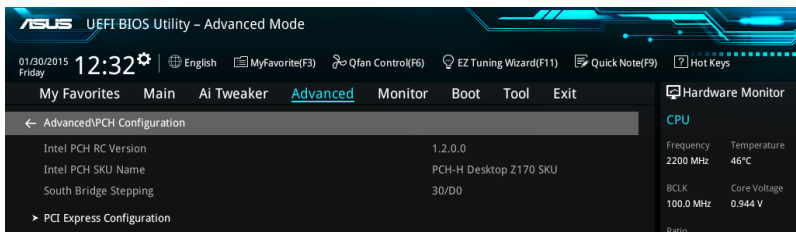
**3.6.4 PCH Configuration**

## PCI Express Configuration

This item allows you to configure the PCI Express slots.

### PCIe Speed [Auto]

This item allows your system to automatically select the PCI Express port speed.  
Configuration options: [Auto] [Gen1] [Gen2] [Gen3]

## 3.6.5 PCH Storage Configuration

While entering Setup, the BIOS automatically detects the presence of SATA devices. The SATA Port items show **Not Present** if no SATA device is installed to the corresponding SATA port.

Scroll down to display the other BIOS items.

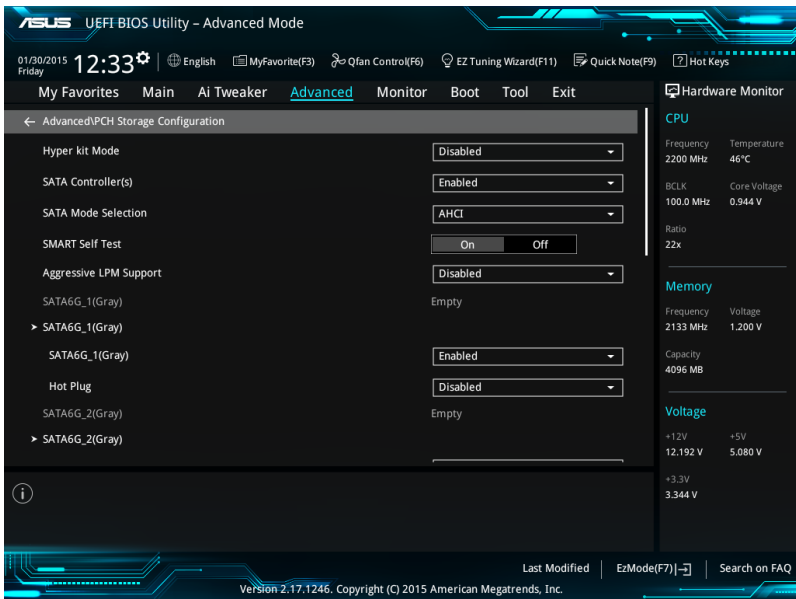

### Hyper kit Mode [Disabled]

This item allows you to enable or disable M.2 devices. Enable this option for “ASUS Hyper kit” card.

Configuration options: [Disabled] [Enabled]

### SATA Controller(s) [Enabled]

This item allows you to enable or disable the SATA Device.

Configuration options: [Disabled] [Enabled]

## SATA Mode Selection [AHCI]

This item allows you to set the SATA configuration.

- [AHCI] Set to [AHCI] when you want the SATA hard disk drives to use the AHCI (Advanced Host Controller Interface). The AHCI allows the onboard storage driver to enable advanced Serial ATA features that increases storage performance on random workloads by allowing the drive to internally optimize the order of commands.
- [RAID] Set to [RAID] when you want to create a RAID configuration from the SATA hard disk drives.



---

The following item appears only when you set the SATA Mode Selection to **[RAID]**.

---

### M.2 PCIE Storage RAID Support [Disabled]

This item allows you to enable or disable PCIE port to SATA for RAID Remapping.  
Configuration options: [Disabled] [Enabled]

### SATA Express PCIE Storage RAID Support [Disabled]

This item allows you to enable or disable PCIE port to SATA for RAID Remapping.  
Configuration options: [Disabled] [Enabled]

### PCIE16\_3 PCIE Storage RAID Support [Disabled]

This item allows you to enable or disable PCIE port to SATA for RAID Remapping.  
Configuration options: [Disabled] [Enabled]

## SMART Self Test [On]

SMART (Self-Monitoring, Analysis and Reporting Technology) is a monitoring system that shows a warning message during POST (Power-on Self Test) when an error occurs in the hard disks.

Configuration options: [On] [Off]

## Aggressive LPM Support [Disabled]

This item is designed for LPM (link power management) support with a better energy saving conditions. When disabled, the hot plug function of SATA ports are disabled.

Configuration options: [Disabled] [Enabled]

## SATA6G\_1(Gray) - SATA6G\_6(Gray)

### SATA6G\_1(Gray) - SATA6G\_6(Gray) [Enabled]

This item allows you to enable or disable the selected SATA port.  
Configuration options: [Disabled] [Enabled]

### Hot Plug [Disabled]

These items appears only when the SATA Mode Selection is set to **[AHCI]** and allows you to enable or disable SATA Hot Plug Support.

Configuration options: [Disabled] [Enabled]



## 3.6.6 USB Configuration

The items in this menu allow you to change the USB-related features.

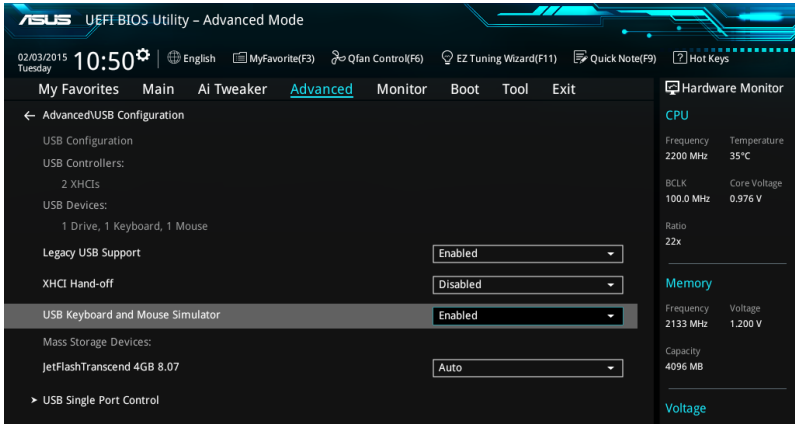

The **Mass Storage Devices** item shows the auto-detected values. If no USB device is detected, the item shows **None**.

### Legacy USB Support [Enabled]

- [Enabled] Your system supports the USB devices in legacy operating systems.
- [Disabled] Your USB devices can be used for BIOS setup only and cannot be recognized in the boot devices list.
- [Auto] Your system automatically detects the presence of USB devices at startup. If any USB devices are detected, the legacy USB support is enabled.

### XHCI Hand-off [Disabled]

- [Enabled] Enables the support for operating systems without an XHCI hand-off feature.
- [Disabled] Disables the XHCI Hand-off support.

### USB Keyboard and Mouse Simulator [Enabled]

- [Enabled] Enables the support for operating systems without a USB keyboard and mouse feature to simulate a USB keyboard and mouse in Windows 7.
- [Disabled] Disables the USB Keyboard and Mouse Simulator.



Ensure to install Usb driver in your system before you disable this item.

### USB Single Port Control

This item allows you to enable or disable the individual USB ports.



Refer to section **1.2.2 Motherboard layout** for the location of the USB ports.

### 3.6.7 Network Stack Configuration

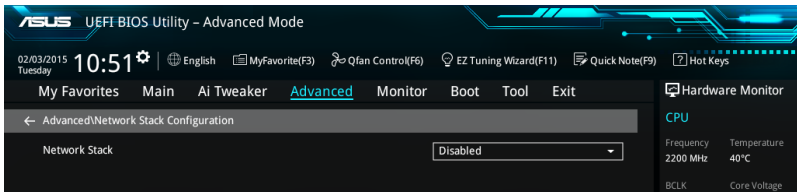

#### Network stack [Disable]

This item allows you to disable or enable the UEFI network stack.

Configuration options: [Disable] [Enable]



The following item appears only when you set the Network Stack to [Enabled].

#### Ipv4/Ipv6 PXE Support [Enabled]

This item allows you to enable or disable the Ipv4/Ipv6 PXE wake event.

Configuration options: [Disabled] [Enabled]

### 3.6.8 Onboard Devices Configuration

Scroll down to view the other BIOS items.

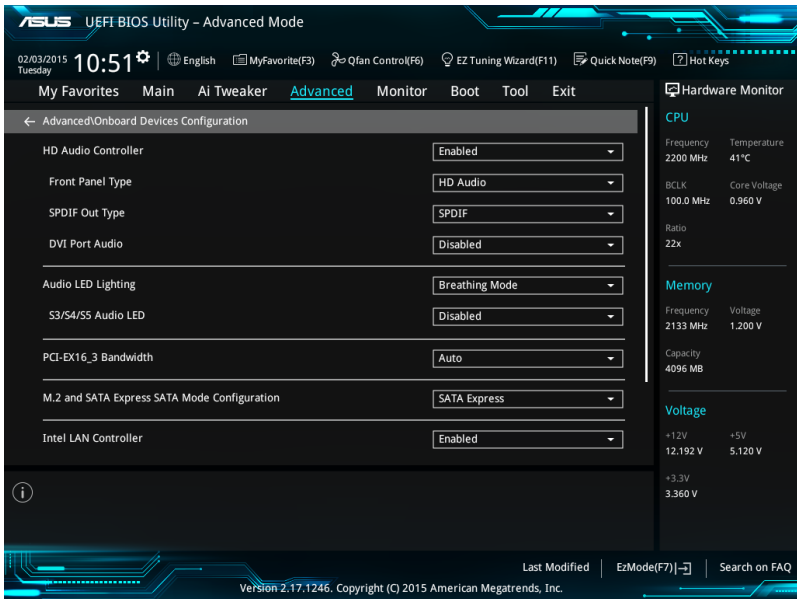

## HD Audio Controller [Enabled]

This item allows you to use the Azalia High Definition Audio Controller

Configuration options: [Disabled] [Enabled]



---

The following items appear only when you set the HD Audio Controller to **[Enabled]**.

---

### Front Panel Type [HD Audio]

This item allows you to set the front panel audio connector (AAFP) mode to legacy AC'97 or high-definition audio depending on the audio standard that the front panel audio module supports.

[HD Audio] Sets the front panel audio connector (AAFP) mode to high definition audio.

[AC97] Sets the front panel audio connector (AAFP) mode to legacy AC'97

### SPDIF Out Type [SPDIF]

[SPDIF] Sets to an SPDIF audio output.

[HDMI] Sets to an HDMI audio output.

### DVI Port Audio [Disabled]

Configuration Options: [Disabled] [Enabled]

## Audio LED Lighting [Breathing Mode]

[Disabled] Turn off the Audio LED.

[Still Mode] Turn on the Audio LED.

[Breathing Mode] Turn on Audio LED breathing mode.



---

The following items appear only when you set the Audio LED Lighting to **[Still Mode]** or **[Breathing Mode]**.

---

### S3/S4/S5 Audio LED [Disabled]

This item allows you to enable or disable the audio LED in S3/S4/S5 mode.

Configuration Options: [Disabled] [Enabled]

## PCI-EX16\_3 Bandwidth [Auto]

[Auto] Run at X2 mode with SATA6G\_56 enabled.

[X4 mode] Run at X4 mode for higher performance with SATA6G\_56 disabled.

## M.2 and SATA Express Mode Configuration [SATA Express]

[M.2] SATA mode will be switched to M.2. SATA Express can only support PCIE devices.

[SATA Express] SATA mode will be switched to SATA Express. M.2 can only support PCIE devices.

## Intel LAN Controller [Enabled]

This item allows you to enable or disable the Intel LAN1/2 controllers.

Configuration options: [Disabled] [Enabled]



The following item appears only when you set the Intel LAN Controller to **[Enabled]**.

### Intel PXE Option ROM **[Disabled]**

This item allows you to enable or disable the PXE OptionRom of the Intel® LAN controller.

Configuration options: **[Enabled]** **[Disabled]**

### Intel USB 3.1 Controller **[Enabled]**

This item allows you to disable or enable the Intel® USB 3.1 controller of your system.

Configuration options: **[Disabled]** **[Enabled]**

### USB Type C Power Switch **[Auto]**

**[Auto]** The system will automatically detect your USB Type C devices and provide suitable power if needed.

**[Enabled]** The USB Type C port will always provide power to your devices.

## 3.6.9 APM Configuration

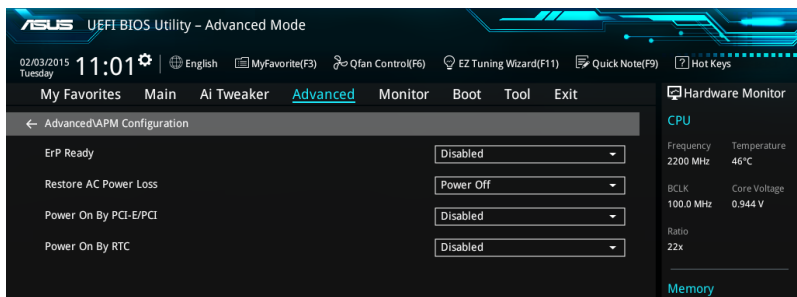

### ErP Ready **[Disabled]**

This item allows you to switch off some power at S4+S5 or S5 to get the system ready for ErP requirement. When set to **[Enabled]**, all other PME options are switched off.

Configuration options: **[Disabled]** **[Enabled (S4+S5)]** **[Enabled (S5)]**

### Restore AC Power Loss **[Power Off]**

This item allows your system to go to ON state, OFF state, or both states after an AC power loss. When setting your system to **[Last State]**, it goes to the previous state before the AC power loss.

Configuration options: **[Power Off]** **[Power On]** **[Last State]**

### Power On By PCI-E/PCI **[Disabled]**

This item allows you to enable or disable the Wake-on-LAN function of the onboard LAN controller or other installed PCI-E LAN cards.

Configuration options: **[Disabled]** **[Enabled]**

## Power On By RTC [Disabled]

This item allows you to enable or disable the RTC (Real-Time Clock) to generate a wake event and configure the RTC alarm date. When enabled, you can set the days, hours, minutes, or seconds to schedule an RTC alarm date.

Configuration options: [Disabled] [Enabled]

## 3.6.10 HDD/SSD SMART Information

This menu displays the SMART information of the connected devices.

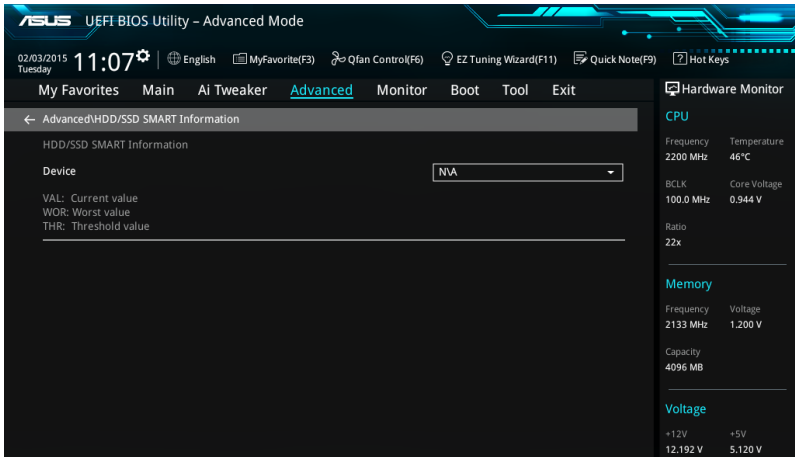

## 3.6.11 Intel(R) Thunderbolt Configuration

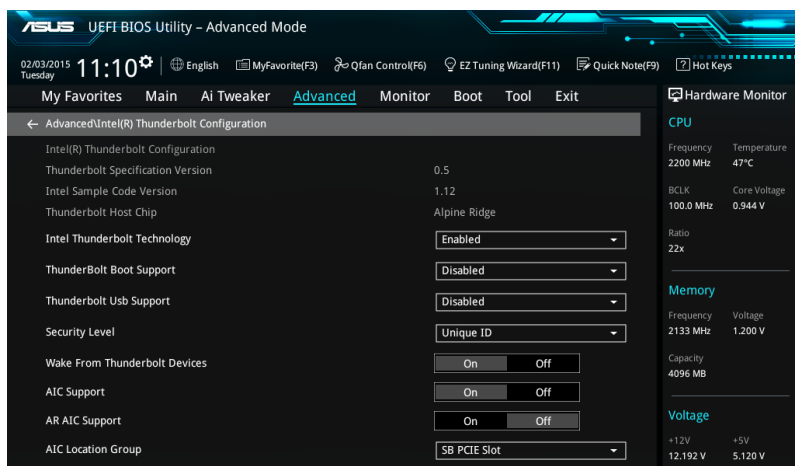

### Intel Thunderbolt Technology [Enabled]

This item allows you to enable or disable the Intel® Thunderbolt Function.

Configuration options: [Disabled] [Enabled]

### Thunderbolt Boot Support [Disabled]

This item allows you to enable or disable Thunderbolt attached device as a bootable device.

Configuration options: [Disabled] [Enabled]

### Thunderbolt USB Support [Disabled]

This item allows you to disable or enable the Thunderbolt USB Boot Support.

Configuration options: [Disabled] [Enabled]

### Security Level [Unique ID]

This item allows you to select the security level.

Configuration options: [Legacy Mode] [Unique ID] [One time saved Key] [DP++ only]

### Wake From Thunderbolt Devices [On]

This item allows you to enable or disable system wake from Thunderbolt devices.

Configuration options: [On] [Off]

### AIC support [On]

This item allows you to enable or disable Go2Sx command application before going to sleep.

Configuration options: [On] [Off]

### AR AIC Support [Off]

This item allows you to enable or disable AR AIC card support.

Configuration options: [On] [Off]

### **AIC Location Group [SB PCIE Slot]**

This item allows you to select AIC Location Group.

Configuration options: [CPU0 NB PCIE Slot] [SB PCIE Slot]

### **AIC Location [BACK IO]**

This item allows you to select Thunderbolt AIC Location.

Configuration options: [BACK IO] [PCIEx16\_3]

### **GPIO3 Force Pwr [Off]**

This item allows you to enable or disable GPIO3.

Configuration options: [On] [Off]

### **Wait time in ms after applying Force Pwr [200]**

This item allows you to set the wait time (in milli seconds) before accessing the TBT controller, after Force Pwr is asserted.

Configuration options: [1] - [65535]

### **Thunderbolt PCIe Cache-line Size [32]**

This item allows you to select the Cache-line size value to be configured on Thunderbolt PCIe subtree.

Configuration options: [0] [1] [2] [4] [8] [16] [32] [64] [128]

### **SMI/Notify Support [On]**

This item allows you to enable or disable SMI/Notify Support.

Configuration options: [On] [Off]

### **SwSMI Support [On]**

This item allows you to enable or disable SwSMI support in ASL code.

Configuration options: [On] [Off]

### **Notify Support [On]**

This item allows you to enable or disable Notify support in ASL code.

Configuration options: [On] [Off]

### **MSI enabled in FADT [Enabled]**

Configuration options: [Disabled] [Enabled]

### **Enable CLK REQ [Disabled]**

This item allows you to enable or disable ClkReq for all the downstreams ports and endpoints devices.

Configuration options: [Disabled] [Enabled]

### **Enable ASPM [Disabled]**

This item allows you to enable or disable ASPM support for all the downstreams ports and endpoints devices.

Configuration options: [Disabled] [Enabled]

### **Enable LTR [Disabled]**

This item allows you to enable or disable Latency Tolerance Reporting support for all the Thunderbolt(TM) devices.

Configuration options: [Disabled] [Enabled]

### **Native OS Hot Plug [Off]**

Configuration options: [On] [Off]

### **GPIO filter [Enabled]**

Configuration options: [Disabled] [Enabled]

### **\_RMV Method return value [0]**

This item allows you to choose \_RMV Method return value for Thunderbolt in ASL code.

Configuration options: [0] [1]

### **Ignore Thunderbolt Option Rom [On]**

This item allows you to enable or disable ignore Thunderbolt Device Option Rom.

[On]               Skip TBT Option Rom at POST time.

[Off]              Execute TBT Option Rom at POST time.

### **Thunderbolt SwSMI Delay [0]**

Configuration options: [1] - [65535]

### **TBT Device IO resource Support [Off]**

This item allows you to enable or disable IO resource for Thunderbolt Device.

Configuration options: [On] [Off]

### **Reserved Mem per phy slot [32]**

Configuration options: [0] - [1200]

### **Reserved PMem per phy slot [32]**

Configuration options: [0] - [1200]



## 3.7 Monitor menu

The Monitor menu displays the system temperature/power status, and allows you to change the fan settings.

Scroll down to display the other BIOS items.

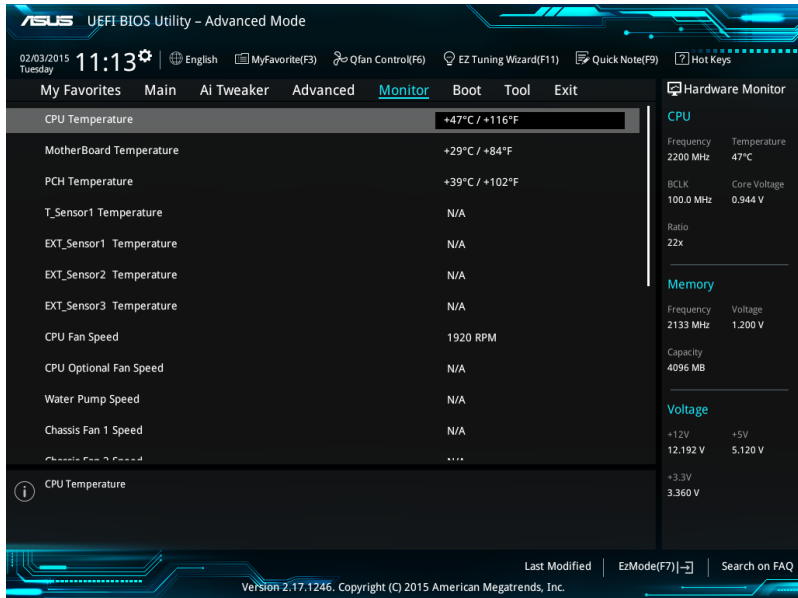

### CPU Temperature / MB Temperature / PCH Core Temperature / T\_SENSOR1 Temperature / EXT\_SENSOR1-3 Temperature [xxx°C/xxx°F]

The onboard hardware monitor automatically detects and displays the CPU, motherboard, VRM, PCH Core, and SENSOR1 temperatures. Select **[Ignore]** if you do not wish to display the detected temperatures.

### CPU Fan Speed, CPU Optional Fan, Water Pump Speed, Chassis Fan 1-2 Speed, EXT Fan 1-3 [xxxx RPM] or [Ignore] / [N/A]

The onboard hardware monitor automatically detects and displays the CPU, chassis, and power fan speed in rotations per minute (RPM). If the fan is not connected to the motherboard, the field shows N/A. Select **[Ignore]** if you do not wish to display the detected speed.

### CPU Core Voltage, 3.3V Voltage, 5V Voltage, 12V Voltage

The onboard hardware monitor automatically detects the voltage output through the onboard voltage regulators. Select **[Ignore]** if you do not want to detect this item.

## Qfan Configuration

### Qfan Tuning

Click this item to automatically detect the lowest speed and configure the minimum duty cycle for each fan.

### CPU Q-Fan Control [Auto]

- [Auto] Detect the type of CPU fan installed and automatically switches the mode control.
- [PWM Mode] Enable the CPU Q-Fan control feature in PWM mode for 4-pin CPU fan.
- [DC Mode] Enable the CPU Q-Fan control feature in DC mode for 3-pin CPU fan.
- [Disabled] Disable the Q-Fan control.

### CPU Fan Step Up [0 sec]

This item allows you to set the value of the CPU fan step up.

Configuration options: [0 sec] [2.1 sec] [2.8 sec] [3.6 sec] [4.5 sec] [5.0 sec] [6.3 sec] [8.5 sec] [12 sec] [25 sec]

### CPU Fan Step Down [0 sec]

This item allows you to set the value of the CPU fan step down.

Configuration options: [0 sec] [2.1 sec] [2.8 sec] [3.6 sec] [4.5 sec] [5.0 sec] [6.3 sec] [8.5 sec] [12 sec] [25 sec]

### CPU Fan Speed Lower Limit [200 RPM]

This item allows you to set the low limit warning for CPU Fan speed.

Configuration options: [Ignore] [200 RPM] [300 RPM] [400 RPM] [500 RPM] [600 RPM]

### CPU Fan Profile [Standard]

This item allows you to set the appropriate performance level of the CPU fan.

- [Standard] Set to make the CPU fan adjust automatically depending on the CPU temperature.
- [Silent] Set to minimize the fan speed for quiet CPU fan operation.
- [Turbo] Set to achieve maximum CPU fan speed.
- [Manual] Set to assign the detailed fan speed control parameters.



---

The following items appear only when you set the CPU Fan Profile to **[Manual]**.

---

#### **CPU Upper Temperature [70]**

Use the <+> or <-> keys to adjust the upper limit of the CPU temperature. The values range from 25 to 75.

#### **CPU Fan Max. Duty Cycle (%) [100]**

Use the <+> or <-> keys to adjust the maximum CPU fan duty cycle. The values range from 20% to 100%. When the CPU temperature reaches the upper limit, the CPU fan will operate at the maximum duty cycle.

#### **CPU Middle Temperature [25]**

Use the <+> or <-> keys to adjust the middle limit of the CPU temperature. The values range from 20 to 75.

**CPU Fan Middle. Duty Cycle (%) [20]**

Use the <+> or <-> keys to adjust the maximum CPU fan duty cycle. The values range from 20% to 100%. When the CPU temperature reaches the upper limit, the CPU fan will operate at the maximum duty cycle.

**CPU Lower Temperature [20]**

Use the <+> or <-> keys to adjust the lower limit of the CPU temperature. The values range from 20 to 75. The CPU fan will operate at the minimum duty cycle when the temperature is lower than the limit.

**CPU Fan Min. Duty Cycle(%) [20]**

Use the <+> or <-> keys to adjust the minimum CPU fan duty cycle. The values range from 0% to 100%. When the CPU temperature is under the limit, the CPU fan will operate at the minimum duty cycle.

**Chassis Fan 1-2 Q-Fan Control [DC Mode]**

- [Disabled]      Disable the Chassis Q-Fan control feature.  
 [DC mode]      Enable the Chassis Q-Fan control in DC mode for 3-pin chassis fan.  
 [PWM mode]    Enable the Chassis Q-Fan control in PWM mode for 4-pin chassis fan.

**Chassis Fan 1-2 Q-Fan Source [CPU]**

The assignment fan will be controlled according to the selected temperature source. Configuration options: [CPU] [MotherBoard] [VRM] [PCH] [T\_SENSOR1] [EXT\_Sensor1] [EXT\_Sensor2] [EXT\_Sensor3]



---

For EXT\_Sensor1-3, connect a Thermistor cable to the EXT\_TS1-3 header then place the other end to the component to get the temperature.

---

**Chassis Fan 1-2 Step Up [0 sec]**

This item allows you to set the value of the CPU fan step up.  
 Configuration options: [0 sec] [12 sec] [25 sec] [51 sec] [76 sec] [102 sec] [127 sec] [153 sec] [178 sec] [204 sec]

**Chassis Fan 1-2 Step Down [0 sec]**

This item allows you to set the value of the CPU fan step down.  
 Configuration options: [0 sec] [12 sec] [25 sec] [51 sec] [76 sec] [102 sec] [127 sec] [153 sec] [178 sec] [204 sec]

**Chassis Fan 1-2 Fan Speed Low Limit [200 RPM]**

This item allows you to disable or set the chassis fan warning speed.  
 Configuration options: [Ignore] [200 RPM] [300 RPM] [400 RPM] [500 RPM] [600 RPM]

**Chassis Fan 1-2 Profile [Standard]**

This item allows you to set the appropriate performance level of the chassis fan.

- [Standard]      Sets to [Standard] to make the chassis fan automatically adjust depending on the chassis temperature.  
 [Silent]        Sets to [Silent] to minimize the fan speed for quiet chassis fan operation.  
 [Turbo]        Sets to [Turbo] to achieve maximum chassis fan speed.  
 [Manual]       Sets to [Manual] to assign detailed fan speed control parameters.



---

The following four items appear only when you set Chassis Fan 1-2 Profile to **[Manual]**.

---

**Chassis Fan 1-2 Upper Temperature [70]**

Use the <+> or <-> keys to adjust the upper limit of the Chassis Fan 1-4 temperature. The values range from 20 to 75.

**Chassis Fan 1-2 Max. Duty Cycle (%) [100]**

Use the <+> or <-> keys to adjust the maximum Chassis Fan 1-4 duty cycle. The values range from 20% to 100%. When the CPU temperature reaches the upper limit, the Chassis Fan 1-4 will operate at the maximum duty cycle.

**Chassis Fan 1-2 Middle Temperature [45]**

Use the <+> or <-> keys to adjust the middle limit of the Chassis Fan 1-4 temperature. The values range from 20 to 75.

**Chassis Fan 1-2 Middle. Duty Cycle (%) [60]**

Use the <+> or <-> keys to adjust the maximum Chassis Fan 1-4 duty cycle. The values range from 20% to 100%. When the CPU temperature reaches the upper limit, the Chassis Fan 1-4 will operate at the maximum duty cycle.

**Chassis Fan 1-2 Lower Temperature [40]**

Use the <+> or <-> keys to adjust the lower limit of the Chassis Fan 1-4 temperature. The values range from 20 to 75. The Chassis Fan 1-4 will operate at the minimum duty cycle when the temperature is lower than the limit.

**Chassis Fan 1-2 Min. Duty Cycle(%) [60]**

Use the <+> or <-> keys to adjust the minimum Chassis Fan 1-4 fan duty cycle. The values range from 0% to 100%. When the CPU temperature is under the limit, the Chassis Fan 1-4 fan will operate at the minimum duty cycle.

**Allow Fan Stop [Disabled]**

This item allow the fan to run at 0% duty cycle when the temperature of the source is dropped below the lower temperature.

Configuration options: [Disabled] [Enabled]

**ASUS FAN EXTENSION CARD is required to configure these items**

**Extension Fan 1-3 Q-Fan Control [DC Mode]**

[Disabled]      Disable the Extension Fan Q-Fan control feature.

[DC mode]      Enable the Extension Fan Q-Fan control in DC mode for 3-pin chassis fan.

[PWM mode]    Enable the Extension Fan Q-Fan control in PWM mode for 4-pin chassis fan.

**Extension Fan 1-3 Q-Fan Source [CPU]**

The assignment fan will be controlled according to the selected temperature source.

Configuration options: [CPU] [MotherBoard] [VRM] [PCH] [T\_SENSOR1] [EXT\_Sensor1] [EXT\_Sensor2] [EXT\_Sensor3]



---

For EXT\_Sensor1-3, connect a Thermistor cable to the EXT\_TS1-3 header then place the other end to the component to get the temperature.

---

**Extension Fan 1-3 Fan Speed Low Limit [200 RPM]**

This item allows you to disable or set the chassis fan warning speed.

Configuration options: [Ignore] [200 RPM] [300 RPM] [400 RPM] [500 RPM] [600 RPM]

**Extension Fan 1-3 Profile [Standard]**

This item allows you to set the appropriate performance level of the CPU fan.

- [Standard] Set to make the CPU fan adjust automatically depending on the CPU temperature.
- [Silent] Set to minimize the fan speed for quiet CPU fan operation.
- [Turbo] Set to achieve maximum CPU fan speed.
- [Manual] Set to assign the detailed fan speed control parameters.



---

The following items appear only when you set the Extension Fan Profile to **[Manual]**.

---

**Extension Fan 1-3 Upper Temperature [70]**

Use the <+> or <-> keys to adjust the upper limit of the Extension Fan 1-4 temperature. The values range from 20 to 75.

**Extension Fan 1-3 Max. Duty Cycle (%) [100]**

Use the <+> or <-> keys to adjust the maximum Extension Fan 1-4 duty cycle. The values range from 20% to 100%. When the CPU temperature reaches the upper limit, the Extension Fan 1-4 will operate at the maximum duty cycle.

**Extension Fan 1-3 Middle Temperature [45]**

Use the <+> or <-> keys to adjust the middle limit of the Extension Fan 1-4 temperature. The values range from 20 to 75.

**Extension Fan 1-3 Middle. Duty Cycle (%) [60]**

Use the <+> or <-> keys to adjust the maximum Extension Fan 1-4 duty cycle. The values range from 20% to 100%. When the CPU temperature reaches the upper limit, the Extension Fan 1-4 will operate at the maximum duty cycle.

**Extension Fan 1-3 Lower Temperature [40]**

Use the <+> or <-> keys to adjust the lower limit of the Extension Fan 1-4 temperature. The values range from 20 to 75. The Extension Fan 1-4 will operate at the minimum duty cycle when the temperature is lower than the limit.

**Extension Fan 1-3 Min. Duty Cycle(%) [60]**

Use the <+> or <-> keys to adjust the minimum Extension Fan 1-4 duty cycle. The values range from 0% to 100%. When the CPU temperature is under the limit, the Extension Fan 1-4 will operate at the minimum duty cycle.

**Allow Fan Stop [Disabled]**

This item allow the fan to run at 0% duty cycle when the temperature of the source is dropped below the lower temperature.

Configuration options: [Disabled] [Enabled]

**Water Pump Control [Disabled]**

- [Disabled] Disable the Water Pump control feature.
- [DC mode] Enable the Water Pump control in DC mode for 3-pin chassis fan.
- [PWM mode] Enable the Water Pump control in PWM mode for 4-pin chassis fan.



---

The following items appear only when you set the Water Pump Control to **[DC mode]** or **[PWM mode]**.

---

***Water Pump Upper Temperature [70]***

Use the <+> or <-> keys to adjust the upper limit of the Water Pump temperature. The values range from 20 to 75.

***Water Pump Max. Duty Cycle (%) [100]***

Use the <+> or <-> keys to adjust the maximum Extension Fan 1-4 duty cycle. The values range from 20% to 100%. When the CPU temperature reaches the upper limit, the Water Pump will operate at the maximum duty cycle.

***Water Pump Middle Temperature [25]***

Use the <+> or <-> keys to adjust the middle limit of the Water Pump temperature. The values range from 20 to 75.

***Water Pump Middle. Duty Cycle (%) [100]***

Use the <+> or <-> keys to adjust the maximum Water Pump duty cycle. The values range from 20% to 100%. When the CPU temperature reaches the upper limit, the Water Pump will operate at the maximum duty cycle.

***Water Pump Lower Temperature [20]***

Use the <+> or <-> keys to adjust the lower limit of the Water Pump temperature. The values range from 20 to 75. The Water Pump will operate at the minimum duty cycle when the temperature is lower than the limit.

***Water Pump Min. Duty Cycle(%) [100]***

Use the <+> or <-> keys to adjust the minimum Water Pump duty cycle. The values range from 0% to 100%. When the CPU temperature is under the limit, the Water Pump will operate at the minimum duty cycle.

## **Anti Surge Support [On]**

Enable this item for Over Voltage Protection (OVP) and Under Voltage Protection (UVP) functions.

Configuration options: [On] [Off]

## 3.8 Boot menu

The Boot menu items allow you to change the system boot options.

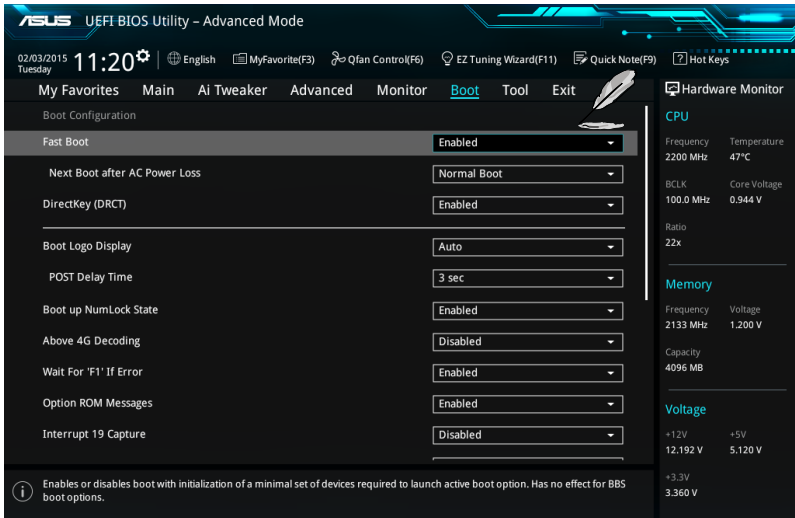

### Fast Boot [Enabled]

[Disabled] Allows your system to go back to its normal boot speed.

[Enabled] Allows your system to accelerate the boot speed.



The following items appear only when you set the Fast Boot to **[Enabled]**.

### Next Boot after AC Power Loss [Normal Boot]

[Normal Boot] Returns to normal boot on the next boot after an AC power loss.

[Fast Boot] Accelerates the boot speed on the next boot after an AC power loss.

### DirectKey (DRCT) [Enabled]

[Disabled] Disables the DirectKey button. The system will only power on or off when you press the DirectKey button.

[Enabled] Allows the system to power on and go to the BIOS Setup directly when you press the Reset button. Connect the 2-pin connector of the chassis reset button cable to the onboard DRCT header.

### Boot Logo Display [Auto]

[Auto] Sets the boot logo to display during POST.

[Full Screen] Sets the boot logo display in full screen during POST.

[Disabled] Disables the boot logo display during POST.



The following item appears only when you set the Boot Logo Display to **[Auto]** and **[Full Screen]**.

### Post Delay Time [3 sec]

This item allows you to select a desired additional POST waiting time to easily enter the BIOS Setup. You can only execute the POST delay time during normal boot. The values range from 0 to 10 seconds.



---

This feature only works when set under normal boot.

---



---

The following items appear only when you set the Boot Logo Display to **[Disabled]**.

---

### Post Report [5 sec]

This item allows you to select a desired POST report waiting time.  
Configuration options: [1 sec] - [10 sec] [Until Press ESC]

### Boot up NumLock State [Enabled]

This item allows you to enable or disable power-on state of the NumLock.  
Configuration options: [Disabled] [Enabled]

### Above 4G Decoding [Disabled]

This item enables or disables 64-bit capable devices to be decoded in above 4G address space if your system supports 64-bit PCI Decoding.

Configuration options: [Enabled] [Disabled]

### Wait For 'F1' If Error [Enabled]

This item allows your system to wait for the <F1> key to be pressed when error occurs.  
Configuration options: [Disabled] [Enabled]

### Option ROM Messages [Enabled]

[Enabled] The Option ROM Messages will be shown during the POST.  
[Disabled] Only the ASUS logo will be shown during the POST.

### Interrupt 19 Capture [Disabled]

[Enabled] Execute the trap right away.  
[Disabled] Execute the trap during legacy boot.

### Setup Mode [EZ Mode]

[Advanced Mode] This item allows you to go to Advanced Mode of the BIOS after POST.  
[EZ Mode] This item allows you to go to EZ Mode of the BIOS after POST.



## CSM (Compatibility Support Module)

This item allows you to configure the CSM (Compatibility Support Module) items to fully support the various VGA, bootable devices and add-on devices for better compatibility.

### Launch CSM [Enabled]

- |            |   |
|------------|---|
| [Auto]     | The system automatically detects the bootable devices and the add-on devices.   |
| [Enabled]  | For better compatibility, enable the CSM to fully support the non-UEFI driver add-on devices or the Windows® UEFI mode. |
| [Disabled] | Disable the CSM to fully support the non-UEFI driver add-on devices or the Windows® UEFI mode.                          |



---

The following items appear only when you set the Launch CSM to **[Enabled]**.

---

#### ***Boot Devices Control [UEFI and Legacy OPROM]***

This item allows you to select the type of devices that you want to boot.

Configuration options: [UEFI and Legacy OPROM] [Legacy OPROM only] [UEFI only]

#### ***Boot from Network Devices [Legacy only]***

This item allows you to select the type of network devices that you want to launch.

Configuration options: [Legacy only] [UEFI driver first] [Ignore]

#### ***Boot from Storage Devices [Legacy only]***

This item allows you to select the type of storage devices that you want to launch.

Configuration options: [Legacy only] [UEFI driver first] [Ignore]

#### ***Boot from PCI-E/PCI Expansion Devices [Legacy only]***

This item allows you to select the type of PCI-E/PCI expansion devices that you want to launch.

Configuration options: [Legacy only] [UEFI driver first]

## Secure Boot

This item allows you to configure the Windows® Secure Boot settings and manage its keys to protect the system from unauthorized access and malwares during POST.

### OS Type [Windows UEFI mode]

- |                     |  |
|---------------------|--|
| [Windows UEFI Mode] | This item allows you to select your installed operating system. Execute the Microsoft® Secure Boot check. Only select this option when booting on Windows® UEFI mode or other Microsoft® Secure Boot compliant OS. |
| [Other OS]          | Get the optimized function when booting on Windows® non-UEFI mode. Microsoft® Secure Boot only supports Windows® UEFI mode.  |

### Key Management

#### Clear Secure Boot keys

This item allows you to clear all default Secure Boot keys.

### Save Secure Boot Keys

This item allows you to save the PK (Platform Keys) to a USB storage device.

### PK Management

#### Set New Key

This item allows you to load the downloaded PK from a USB storage device.



---

The PK file must be formatted as a UEFI variable structure with time-based authenticated variable.

---

#### Delete Key

This item allows you to delete the PK from your system. Once the PK is deleted, all the system's Secure Boot keys will not be active.

Configuration options: [Yes] [No]

### KEK Management



---

Key-exchange Key (KEK) refers to Microsoft® Secure Boot Key-Enrollment Key (KEK).

---

#### Set New Key

Allows you to load the downloaded KEK from a USB storage device.

#### Append Key

Allows you to load the additional KEK from a storage device for an additional db and dbx loaded management.

#### Delete Key

Allows you to delete the KEK from your system.

Configuration options: [Yes] [No]



---

The KEK file must be formatted as a UEFI variable structure with time-based authenticated variable.

---

### DB Management

#### Set New Key

Allows you to load the downloaded db from a USB storage device.

#### Append Key

Allows you to load the additional db from a storage device so that more images can be loaded securely.

#### Delete Key

Allows you to delete the db file from your system.

Configuration options: [Yes] [No]



---

The db file must be formatted as a UEFI variable structure with time-based authenticated variable. DBX Management

---

## DBX Management

### Set New Key

Allows you to load the downloaded dbx from a USB storage device.

Configuration options: [Yes] [No]

### Append Key

Allows you to load the additional dbx from a storage device so that more db's images cannot be loaded.

### Delete Key

Allows you to delete the dbx file from your system.



---

The dbx file must be formatted as a UEFI variable structure with time-based authenticated variable.

---

## Boot Option Priorities

These items specify the boot device priority sequence from the available devices. The number of device items that appears on the screen depends on the number of devices installed in the system.



- To access Windows® OS in Safe Mode, press <F8> after POST (Windows® 8 not supported).
  - To select the boot device during system startup, press <F8> when the ASUS Logo appears.
- 

## Boot Override

These items displays the available devices. The number of device items that appears on the screen depends on the number of devices installed in the system. Click an item to start booting from the selected device.

## 3.9 Tool menu

The Tool menu items allow you to configure options for special functions. Select an item then press <Enter> to display the submenu.

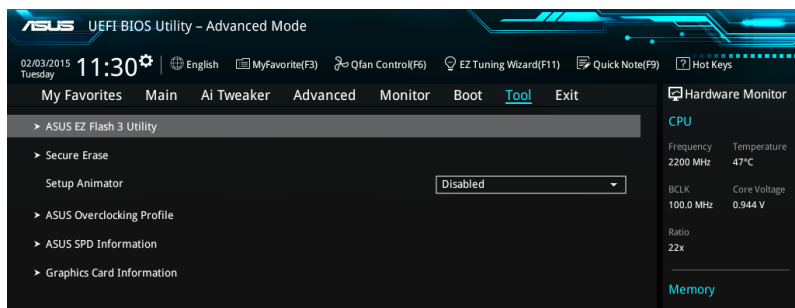

### Setup Animator [Disabled]

This item allows you to enable or disable the Setup animator.

Configuration options: [Disabled] [Enabled]

### 3.9.1 ASUS EZ Flash 3 Utility

This item allows you to run ASUS EZ Flash 3. When you press <Enter>, a confirmation message appears. Use the left/right arrow key to select between [Yes] or [No], then press <Enter> to confirm your choice.



For more details, refer to section **3.11.2 ASUS EZ Flash 3**.

### 3.9.2 Secure Erase

SSD speeds may lower over time as with any storage medium due to data processing. Secure Erase completely and safely cleans your SSD, restoring it to factory performance levels.



Secure Erase is only available in AHCI mode. Ensure to set the SATA mode to AHCI. Click **Advanced > SATA Configuration > AHCI**.

To launch Secure Erase, click **Tool > Secure Erase** on the Advanced mode menu.



Check the ASUS support site for a full list of SSDs tested with Secure Erase. The drive may become unstable if you run Secure Erase on an incompatible SSD.



- The time to erase the contents of your SSD may take a while depending on its size. Do not turn off the system during the process.
- Secure Erase is only supported on Intel SATA port. For more information about Intel SATA ports, refer to section 1.2.2 of this manual.

Displays the available SSDs

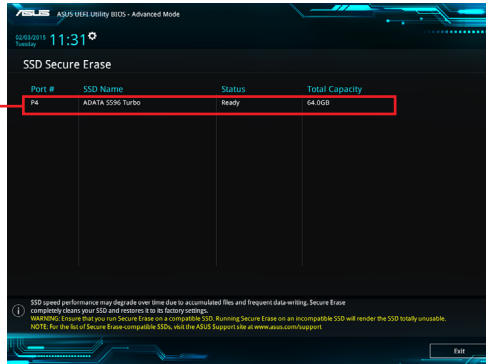

#### Status definition:

- **Frozen.** The frozen state is the result of a BIOS protective measure. The BIOS guards drives that do not have password protection by freezing them prior to booting. If the drive is frozen, a power off or hard reset of your PC must be performed to proceed with the Secure Erase.
- **Locked.** SSDs might be locked if the Secure Erase process is either incomplete or was stopped. This may be due to a third party software that uses a different password defined by ASUS. You have to unlock the SSD in the software before proceeding with Secure Erase.

### 3.9.3 ASUS Overclocking Profile

This item allows you to store or load multiple BIOS settings.

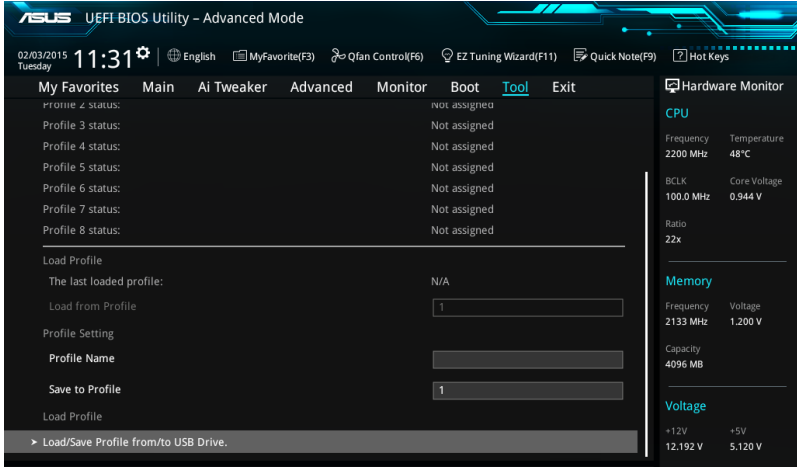

#### Load from Profile

This item allows you to load the previous BIOS settings saved in the BIOS Flash. Key in the profile number that saved your BIOS settings, press <Enter>, and then select **Yes**.



- DO NOT shut down or reset the system while updating the BIOS to prevent the system boot failure!
- We recommend that you update the BIOS file only coming from the same memory/CPU configuration and BIOS version.

#### Profile Name

This item allows you to key in a profile name.

#### Save to Profile

This item allows you to save the current BIOS settings to the BIOS Flash, and create a profile. Key in a profile number from one to eight, press <Enter>, and then select **Yes**.

#### Load/Save Profile from/to USB Drive

This item allows you to load or save profile from your USB drive, load and save profile to your USB drive.

### 3.9.4 ASUS SPD Information

This item allows you to view the DRAM SPD information.

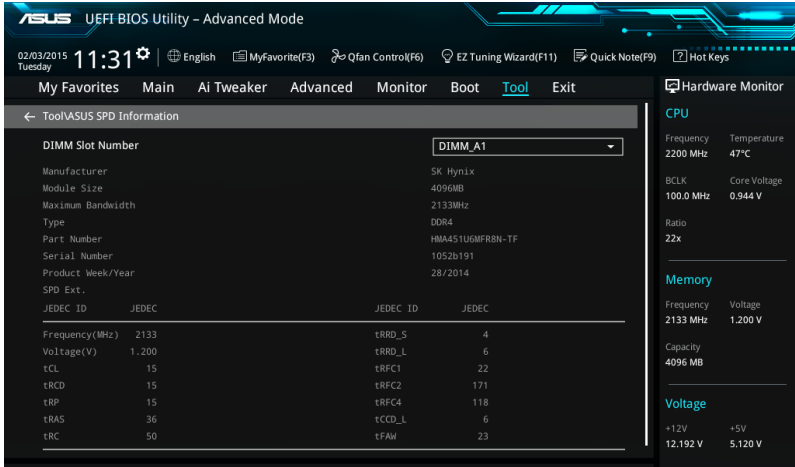

### 3.9.5 Graphics Card Information

This item displays the information about the graphics card installed in your system.

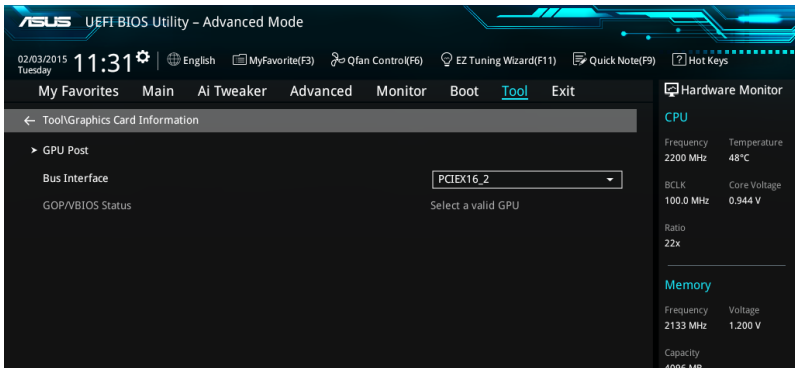

#### GPU Post

This item displays the information and recommended configuration for the PCIE slots that the graphics card is installed in your system.

#### Bus Interface

This item allows you to select the bus interface.

Configuration options: [PCIEX16\_1] [PCIEX16\_2]

## 3.10 Exit menu

The Exit menu items allow you to load the optimal default values for the BIOS items, and save or discard your changes to the BIOS items. You can access the EZ Mode from the Exit menu.

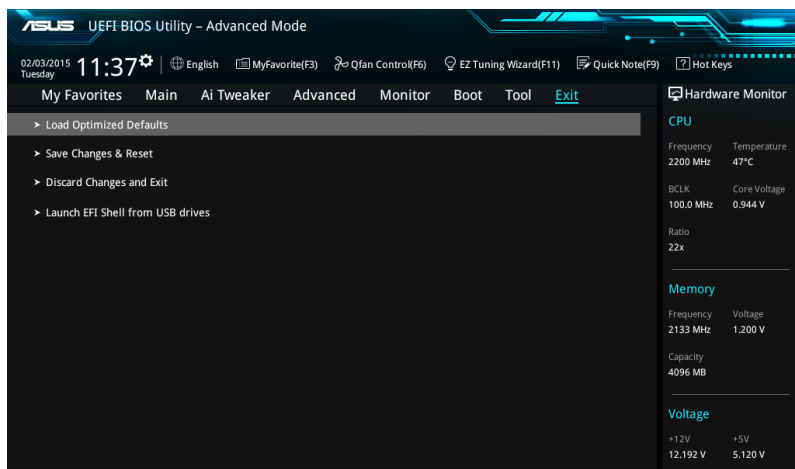

### Load Optimized Defaults

This option allows you to load the default values for each of the parameters on the Setup menus. When you select this option or if you press <F5>, a confirmation window appears. Select **OK** to load the default values.

### Save Changes & Reset

Once you are finished making your selections, choose this option from the Exit menu to ensure the values you selected are saved. When you select this option or if you press <F10>, a confirmation window appears. Select **OK** to save changes and exit.

### Discard Changes & Exit

This option allows you to exit the Setup program without saving your changes. When you select this option or if you press <Esc>, a confirmation window appears. Select **Yes** to discard changes and exit.

### Launch EFI Shell from USB drives

This option allows you to attempt to launch the EFI Shell application (shellx64.efi) from one of the available filesystem devices.



## 3.11 Updating BIOS

The ASUS website publishes the latest BIOS versions to provide enhancements on system stability, compatibility, and performance. However, BIOS updating is potentially risky. If there is no problem using the current version of BIOS, DO NOT manually update the BIOS. Inappropriate BIOS updating may result to system's failure to boot. Carefully follow the instructions in this chapter to update your BIOS when necessary.



---

Visit <http://www.asus.com> to download the latest BIOS file for this motherboard.

---

The following utilities allow you to manage and update the motherboard BIOS setup program.

1. EZ Update: Updates the BIOS in Windows® environment.
2. ASUS EZ Flash 3: Updates the BIOS using a USB flash drive.
3. ASUS CrashFree BIOS 3: Restores the BIOS using the motherboard support DVD or a USB flash drive when the BIOS file fails or gets corrupted.

### 3.11.1 EZ Update

The EZ Update is a utility that allows you to update the motherboard BIOS in Windows® environment.



- EZ Update requires an Internet connection either through a network or an ISP (Internet Service Provider).
  - This utility is available in the support DVD that comes with the motherboard package.
  - Refer to section **4.4.3 EZ Update** of this user guide for more information.
-

### 3.11.2 ASUS EZ Flash 3

ASUS EZ Flash 3 allows you to download and update to the latest BIOS through the Internet without having to use a bootable floppy disk or an OS-based utility.



Updating through the Internet varies per region and Internet conditions. Check your local Internet connection before updating through the Internet.

#### To update the BIOS by USB:

1. Enter the Advanced Mode of the BIOS setup program. Go to the Tool menu to select **ASUS EZ Flash Utility** and press <Enter>.
2. Insert the USB flash disk that contains the latest BIOS file to the USB port.
3. Select **by USB**.

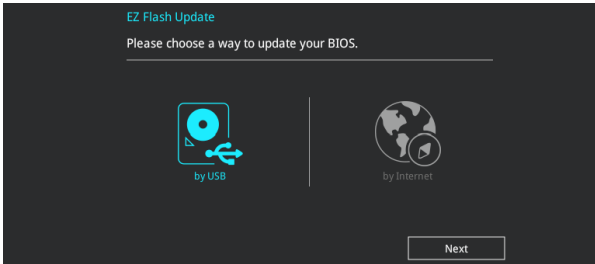

4. Press <Tab> to switch to the Drive field.
5. Press the Up/Down arrow keys to find the USB flash disk that contains the latest BIOS, and then press <Enter>.
6. Press <Tab> to switch to the Folder Info field.
7. Press the Up/Down arrow keys to find the BIOS file, and then press <Enter> to perform the BIOS update process. Reboot the system when the update process is done.

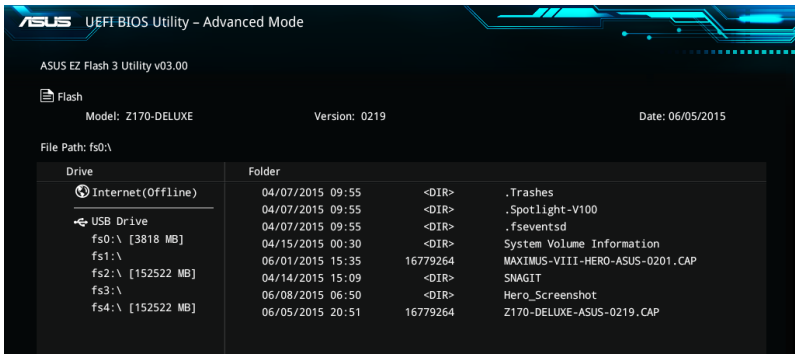



- This function can support devices such as a USB flash disk with FAT 32/16 format and single partition only.
- DO NOT shut down or reset the system while updating the BIOS to prevent system boot failure!



Ensure to load the BIOS default settings to ensure system compatibility and stability. Select the Load Optimized Defaults item under the Exit menu. See section **3.10 Exit Menu** for details.

### To update the BIOS by Internet:

1. Enter the Advanced Mode of the BIOS setup program. Go to the Tool menu to select **ASUS EZ Flash Utility** and press <Enter>.
2. Select **by Internet**.

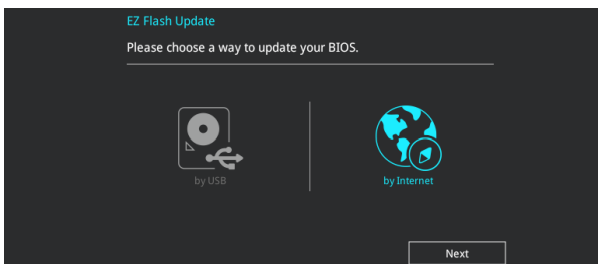

3. Press the Left/Right arrow keys to select an Internet connection method, and then press <Enter>.

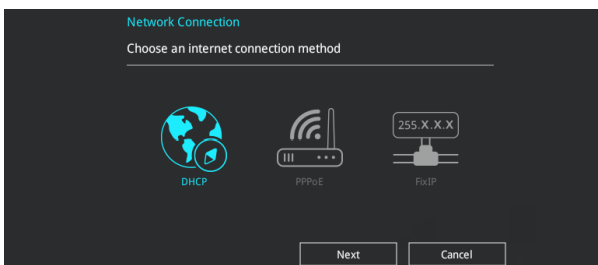

4. Follow the onscreen instructions to complete the update.
5. Reboot the system when the update process is done.



Ensure to load the BIOS default settings to ensure system compatibility and stability. Select the Load Optimized Defaults item under the Exit menu. See section **3.10 Exit Menu** for details.

### 3.11.3 ASUS CrashFree BIOS 3

The ASUS CrashFree BIOS 3 utility is an auto recovery tool that allows you to restore the BIOS file when it fails or gets corrupted during the updating process. You can restore a corrupted BIOS file using the motherboard support DVD or a USB flash drive that contains the BIOS file.



---

The BIOS file in the motherboard support DVD may be older than the BIOS file published on the ASUS official website. If you want to use the newer BIOS file, download the file at <http://support.asus.com> and save it to a USB flash drive.

---

#### Recovering the BIOS

##### To recover the BIOS:

1. Turn on the system.
2. Insert the motherboard support DVD to the optical drive, or the USB flash drive containing the BIOS file to the USB port.
3. The utility automatically checks the devices for the BIOS file. When found, the utility reads the BIOS file and enters ASUS EZ Flash 3 automatically.
4. The system requires you to enter BIOS Setup to recover the BIOS setting. To ensure system compatibility and stability, we recommend that you press <F5> to load default BIOS values.



---

**DO NOT** shut down or reset the system while updating the BIOS! Doing so can cause system boot failure!

---

# Software Support

# 4

## 4.1 Installing an operating system

---



Motherboard settings and hardware options vary. The setup procedures presented in this chapter are for reference only. Refer to Windows® operating system documentation for detailed information.

---

### 4.1.1 Windows® 7 and USB 3.0 driver for 100 Series

Based on the chipset specification, the 100 series requires USB 3.0 drivers to be preloaded in order to use USB keyboard/mouse during Windows® 7 installation. This section is a guide on preloading USB 3.0 drivers and installing Windows® 7.

#### Method 1: Using SATA ODD & USB devices

Load USB 3.0 drivers using the ASUS support DVD and install Windows® 7 using a USB device.

##### Requirement:

- 1 x ASUS support DVD
- 1 x Windows® 7 installation source
- 1 x SATA ODD
- 1 x USB device (ODD or storage)



The USB storage device requires 8 GB or more capacity. It is recommended to format the storage device before use.

---

1. Insert the Windows® 7 installation DVD into a USB ODD, or copy all files on the Windows® 7 installation DVD to a USB storage device on a working system.
2. Connect the USB ODD or USB storage device to your 100 series platform.
3. Insert the ASUS support DVD into a SATA ODD on your 100 series platform.
4. Power on your system and press F8 during POST (Power-On Self Test) to enter the boot screen.

5. Select the USB ODD or USB storage device as the boot device.

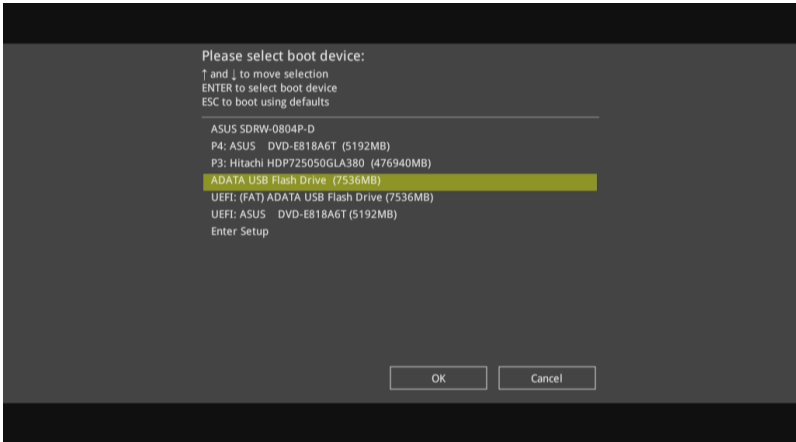

6. The USB 3.0 driver will be loaded automatically during installation startup.

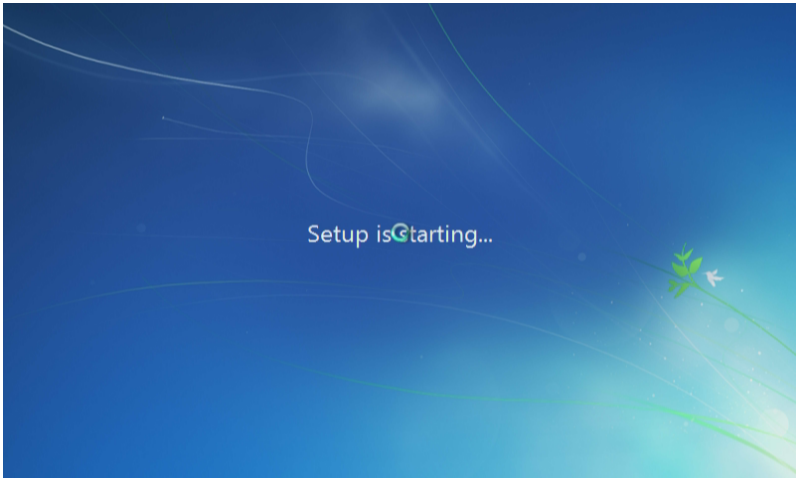

The "Setup is starting..." screen will show up if the USB 3.0 driver is loaded correctly.

7. Follow the onscreen instructions to complete the Windows® 7 installation.

## Method 2: Using a modified Windows® 7 ISO

Load USB 3.0 drivers and install Windows® 7 using a modified Windows® 7 installation DVD.

### Requirement:

- 1 x ASUS support DVD
  - 1 x Windows® 7 installation source
  - 1 x Working system (PC or notebook)
  - 1 x SATA ODD
1. On your working system, create an ISO image file of the Windows® 7 installation source using a third-party ISO software.
  2. Copy both "Auto\_Unattend.xml" and "Auto\_Unattend" folder from the root directory of the ASUS supporting DVD to your system.
  3. Edit the ISO file and add both "Auto\_Unattend.xml" and "Auto\_Unattend" folder into the ISO file.
  4. Burn this ISO file onto an empty DVD to create a modified Windows® 7 installation DVD.
  5. Insert the modified Windows® 7 installation DVD into an ODD on your 100 series platform.
  6. Power on your system and press F8 during POST (Power-On Self Test) to enter the boot screen.
  7. Select the ODD as the boot device.
  8. The USB 3.0 driver will be loaded automatically during installation startup.



---

The "Setup is starting..." screen will show up if the USB 3.0 driver is loaded correctly.

---

9. Follow the onscreen instructions to complete the Windows® 7 installation.

### Method 3: Using ASUS EZ Installer

Use the ASUS EZ Installer to create a modified Windows® 7 installation source.

#### Requirement:

- 1 x ASUS support DVD
- 1 x Windows® 7 installation DVD
- 1 x Working system (PC or notebook)
- 1 x SATA ODD
- 1 x USB storage device (8 GB or more)

1. Insert the Windows® 7 installation DVD.
2. Launch the ASUS EZ Installer located on the ASUS support DVD.
3. Select a method of creating a modified Windows® 7 installation file:
  - Windows® 7 OS disk to USB storage device

- Select **Windows 7 OS disk to USB storage device** then click **Next**.

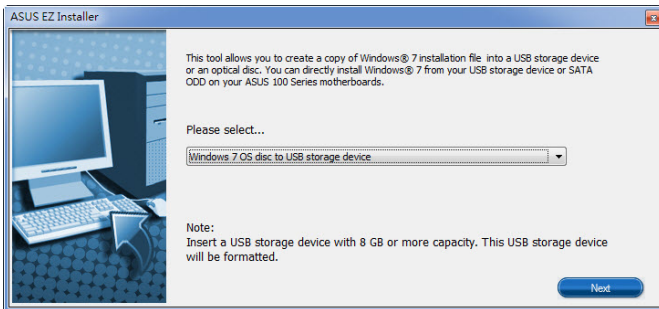

- Check **I agree** and then click **Next**.

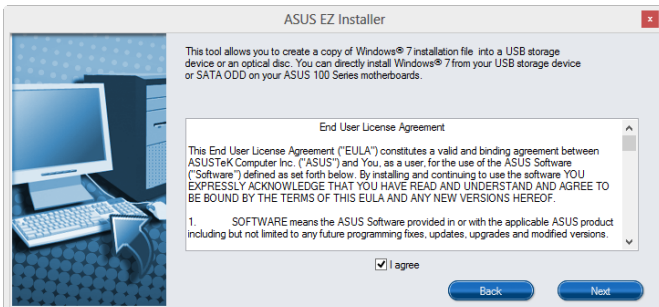



- Select the source of the Windows® 7 installation disk then click **Next**.

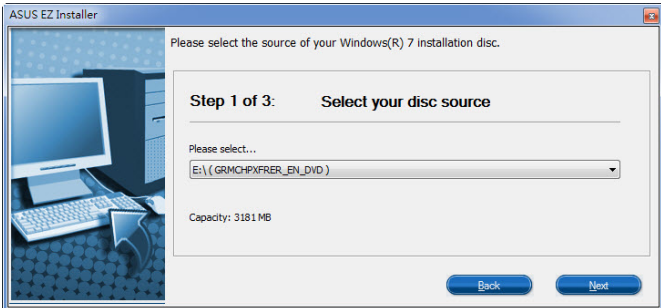

- Select the USB storage device and click **next**.



Click the refresh icon  if the USB storage device is not displayed.

- Click **Yes** to clear the contents on the USB storage device and create a bootable USB device.



Make sure to backup contents on the USB storage device, as it will be formatted.

- Once completed, click **OK** to finish.

- Windows® 7 OS disk to ISO file
  - Select **Windows 7 OS disk to ISO file** then click **Next**.

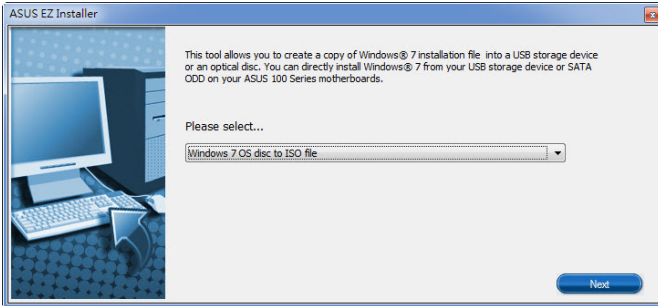

- Check **I agree** and then click **Next**.

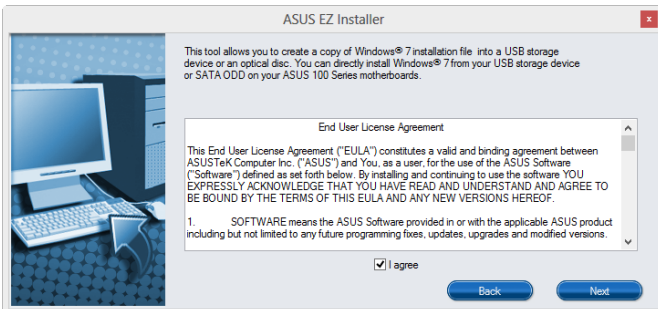

- Select the source of the Windows® 7 installation disk then click **Next**.

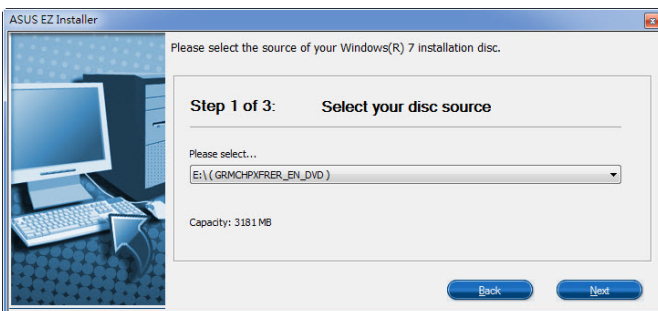

- Select the folder to save the modified Windows® 7 installation ISO file and click **Next**.

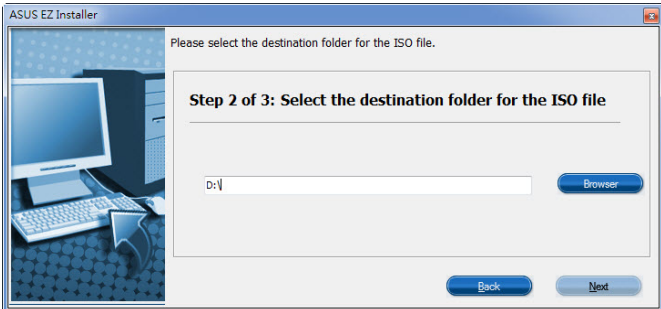

- Once completed, click OK to finish.
  - Burn this ISO file onto an empty DVD to create a modified Windows® 7 installation DVD.
4. Insert the modified Windows® 7 installation DVD into an ODD or connect the USB storage device with modified Windows® 7 installation files onto your 100 series platform.
  5. Power on your system and press F8 during POST (Power-On Self Test) to enter the boot screen.
  6. Select the ODD or USB storage device as the boot device.
  7. The USB 3.0 driver will be loaded automatically during installation startup.



---

The "Setup is starting..." screen will show up if the USB 3.0 driver is loaded correctly.

---

8. Follow the onscreen instructions to complete the Windows® 7 installation.

## 4.2 Support DVD information



The contents of the support DVD are subject to change at any time without notice. Visit the ASUS website at [www.asus.com](http://www.asus.com) for updates.

### 4.2.1 Running the support DVD



Ensure that you have an Administrator account before running the support DVD in your operating system.

To run the Support DVD:

1. Place the Support DVD into the optical drive.
2. In the **AutoPlay** dialog box, Click **Run ASSETUP.EXE**.

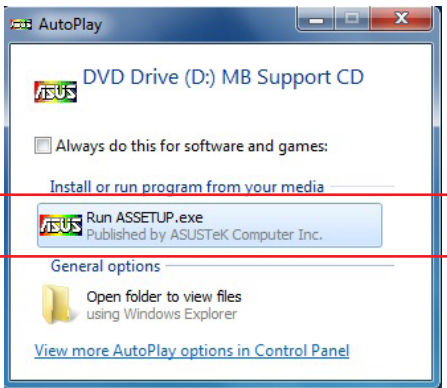

If the **AutoPlay** dialog box does not appear, browse the contents of the support DVD and double-Click `\\bin\\ASSETUP.EXE` to launch the **ASUS motherboard support DVD** main menu.

## Support DVD main menu

Shows the available device drivers if the system detects installed devices. Install the necessary drivers to use the devices.

Click to display the applications and other software that the motherboard supports

Contains the list of supplementary user manuals. Click an item to open the folder of the user guide

Click to display product related information

Click to select an item to install

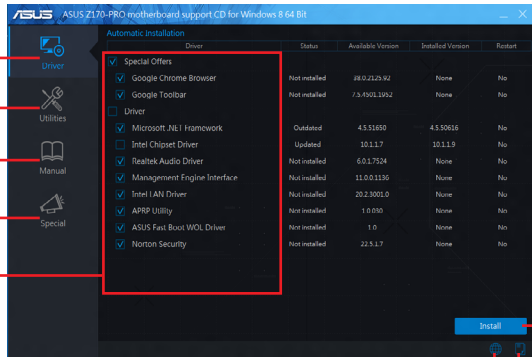

Click to display the ASUS contact information

Click to browse the file list of the support CD

Click to install the selected items

## 4.2.2 Obtaining the software manuals

The software manuals are included in the support DVD. Follow the instructions below to get the necessary software manuals.



The software manual files are in Portable Document Format (PDF). Install the Adobe® Acrobat® Reader from the **Utilities** tab before opening the files.

To read about your motherboard's software manual:

1. Run the Support DVD.
2. In the Support DVD main menu, click the **Manual** tab.
3. Click the software manual that you wish to read.

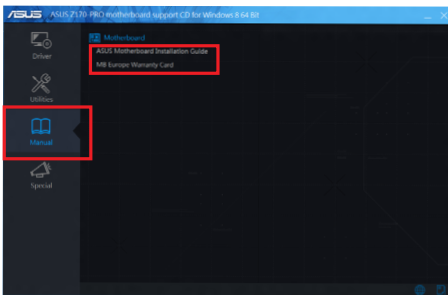

## 4.3 Software information

Most of the applications in the support DVD have wizards that will conveniently guide you through the installation. View the online help or readme file that came with the software application for more information.

## 4.4 AI Suite 3

AI Suite 3 is an all-in-one interface that integrates several ASUS utilities and allows you to launch and operate these utilities simultaneously.

### Installing AI Suite 3



---

Ensure that you have an Administrator account before installing AI Suite 3 in your operating system.

---

To install AI Suite 3 on your computer:

#### Windows® 7 OS

1. Place the Support DVD into the optical drive.
2. In the **AutoPlay** dialog box, Click **Run ASSETUP.exe** then select the **Utilities** tab.

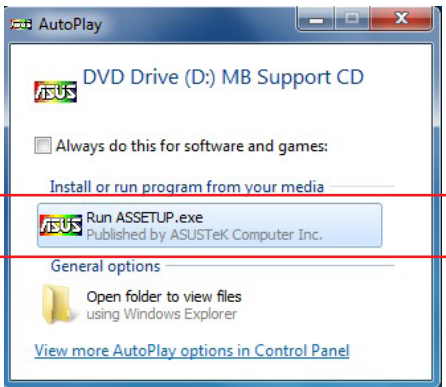

3. From the **Utilities** tab, Click **AI Suite 3** then follow the succeeding onscreen instructions.

## Windows® 8.1 OS

1. Place the Support DVD into the optical drive then follow onscreen instructions.
2. From the **ASUS motherboard support DVD** main menu, select the Utilities tab and Click **AI Suite 3**.
3. Follow the succeeding onscreen instructions.

If the **ASUS motherboard support DVD** main menu did not appear, try the following:

- a. Go to the **Start Screen** then Click the **Desktop** app.
- b. On the lower left corner of the Desktop, Click **File Explorer**  then select your DVD drive and tap or double-Click the **Setup** application.

## Launching AI Suite 3

### Windows® 7 OS

From the Desktop, Click **Start > All Programs > ASUS > AI Suite 3 > AI Suite 3**.

You can also launch AI Suite in Windows® 7 by clicking or tapping  on the Notification area.

### Windows® 8.1 OS

To launch AI Suite 3 in Windows® 8.1, tap the AI Suite 3 app on the Start Screen (or if you're using a mouse, Click the AI Suite 3 app on the Start Screen).

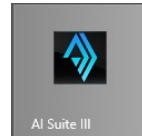

## AI Suite 3 Main menu

The AI Suite 3 main menu gives you easy-access controls and insight to what's going on with your computer - allowing you to optimize performance settings while at the same time ensuring system stability.

The AI Suite main menu includes a quick-access menu bar that allows you to swiftly launch any of the integrated ASUS utilities. Click  on the left of the menu to launch the menu bar.



The AI Suite 3 screenshots in this section are for reference only and can vary depending on motherboard model.

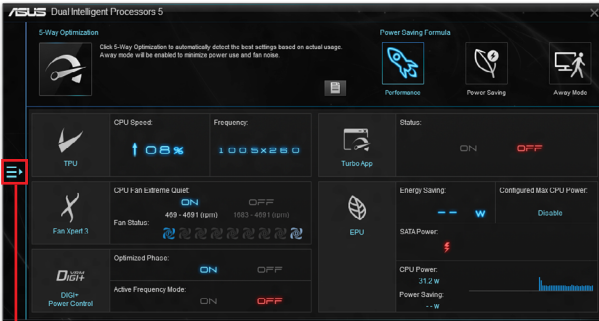

Click to launch AI Suite 3 menu bar

## AI Suite 3 main menu bar

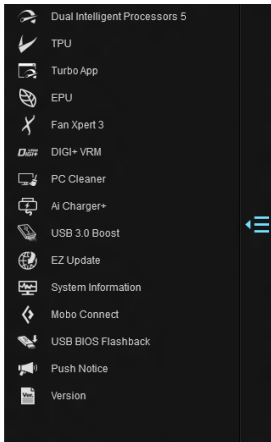

- Some functions in the AI Suite 3 main menu in this user guide may vary depending on the motherboard model.
- Refer to the software manual in the support DVD or visit the ASUS website at [www.asus.com](http://www.asus.com) for detailed software configuration.



### AI Suite 3 mini-menu

The AI Suite 3 mini-menu appears on the desktop and can be conveniently accessed and moved around. The AI Suite 3 mini-menu allows you to quickly access the important items in the AI Suite 3.

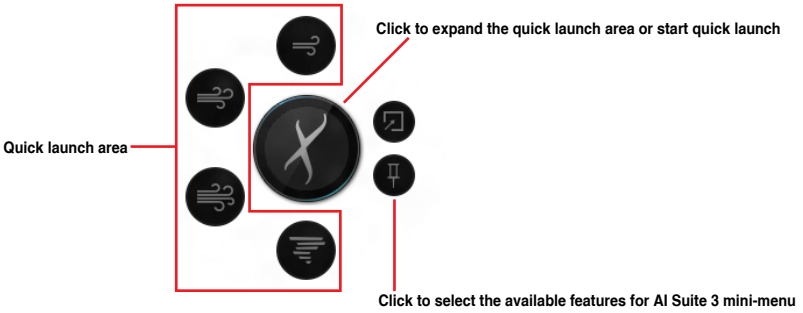

## 4.4.1 Ai Charger

Ai Charger allows you to fast-charge your portable BC 1.1\* mobile devices on your computer's USB port three times faster than the standard USB devices\*\*.

### Launching Ai Charger

To launch Ai Charger, click  on the left of the AI Suite 3 main menu, then select **Ai Charger**.



---

Ai Charger is available only in selected motherboard models.

---

### Ai Charger screen



Tick to enable or disable Ai Charger

Click to apply the selection



- \* Check the manufacturer if your USB device is a Battery Charging Specification 1.1 (BC 1.1) compliant or compatible device.
  - \*\* Actual charging speeds may vary depending on the charging rate and specifications of your USB device.
  - To ensure normal charging function, disconnect and reconnect your USB device every time you enable or disable Ai Charger.
  - Ai Charger does not support USB hubs, USB extension cables, and generic USB cables.
-

## 4.4.2 USB 3.1 Boost

USB 3.1 Boost technology supports UASP (USB Attached SCSI Protocol) that automatically speeds up the transfer rates of your USB storage devices.

### Launching USB 3.1 Boost

To launch USB 3.1 Boost, click  on the left of the AI Suite 3 main menu, then select **USB 3.1 Boost**.

### Using the USB 3.1 Boost



Ensure to connect your USB 3.0 or 3.1 device to the USB ports that support USB 3.1 Boost. Refer to the **Rear I/O connection** section of your user guide for more details.



- USB 3.1 Boost automatically detects the USB devices that support UASP. For a list of UASP-supported USB devices, visit the ASUS website at [www.asus.com](http://www.asus.com).
- The data transfer speed varies with USB devices. For a higher data transfer performance, use a USB 3.1 device.

### 4.4.3 EZ Update

EZ Update is a utility that allows you to automatically update your motherboard's software, drivers and BIOS easily.

With this utility, you can also manually update the BIOS and select the boot logo that displays during POST.

#### Launching EZ Update

To launch EZ Update, click  on the left of the AI Suite 3 main menu, then select **EZ Update**.

#### Using EZ Update

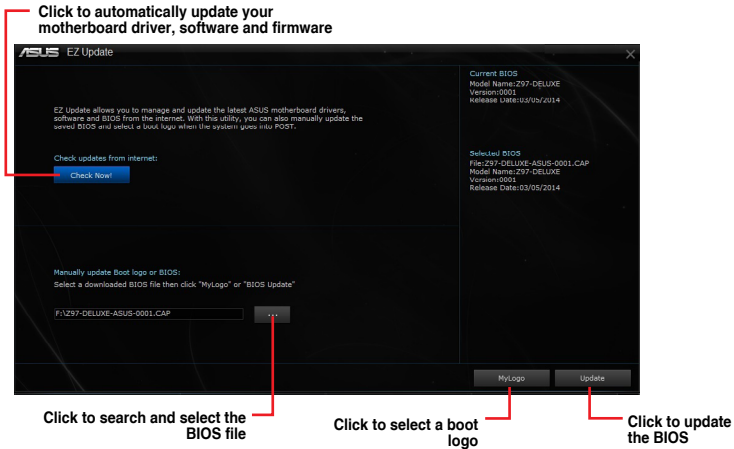

## Manually update the BIOS and selecting a boot logo

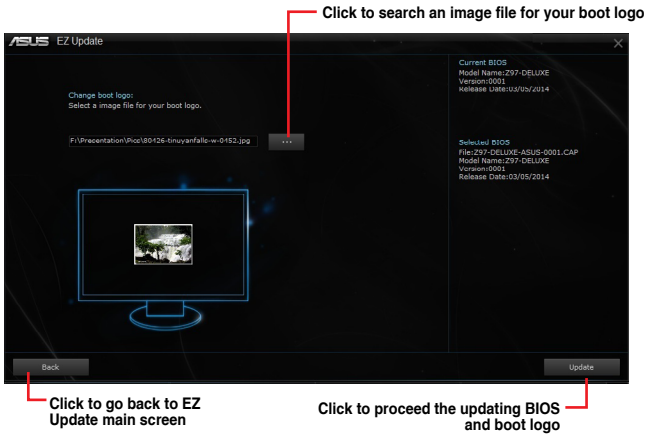

After you Click **BIOS Update** button, Click **Flash** to update the BIOS and upload the boot logo in your system.

## 4.4.4 Push Notice

This utility allows you get the detailed status of your system to your smart device. You can also send messages to your smart device using this utility.



Before using this utility, ensure that you pair your computer with your smart device. For pairing information, refer to section **Pairing your computer and smart device**.

### Launching Push Notice on your computer

To launch Push Notice, click  on the left of the AI Suite 3 main menu, then select **Push Notice**.

### Push Notice screen

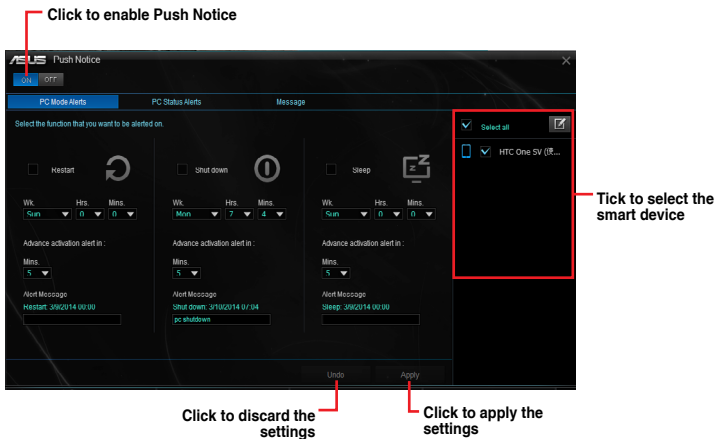

The screenshot shows the 'Push Notice' utility window. At the top left, there is a 'Click to enable Push Notice' annotation pointing to the 'ON/OFF' toggle. The main area is divided into three sections: 'PC Mode Alerts', 'PC Status Alerts', and 'Message'. Each section has a 'Select the function that you want to be alerted on' area with a grid of options (e.g., Restart, Shut down, Sleep) and 'Advance activation alert in' settings. At the bottom right, there is a 'Tick to select the smart device' annotation pointing to a list of devices, with 'HTC One SV (R...)' selected. At the bottom center, there are 'Undo' and 'Apply' buttons, with 'Click to discard the settings' pointing to 'Undo' and 'Click to apply the settings' pointing to 'Apply'.



You can also enable the Push Notice via the Push Notice shortcut on the lower-right corner of your screen. To do this, Click << then Click  then select .

### Pairing your computer and smart device

To pair your computer and smart device:

1. On your smart device, tap  to launch Push Notice.
2. Tap **Push Scan** then tap the name of your computer that you want to pair with.



To pair your computer and smart device, ensure that both are connected to the same wireless network.

## Setting up PC Mode alerts of your computer

This feature allows you to restart, shut down, or put your computer to sleep mode and sends an alert to your smart device.

Tick these to enable mode alerts

Set the day and time to enable the PC modes

Set the minutes to send the alert before the PC mode/s activation

Key in your messages for more information

Tick to select the smart device

## Setting up PC Status alerts

This feature allows you to send alerts of the unusual activities of the voltage, temperature, and fan settings of your computer to your smart device.

Tick to select and send alerts to your smart device



Tick to select the smart device

Tick to send alert when the components selected are back to its normal status

## Sending messages to your smart device

This feature allows you to send messages to your smart device.



You can also send messages via the Push Notice messaging shortcut on the lower-right corner of your screen. To do this, Click << then Click  then select .

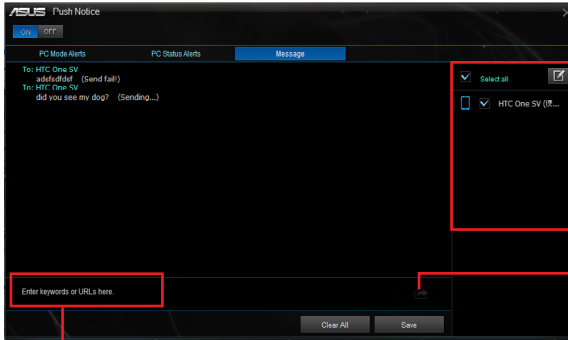

Tick to select the smart device

Click to send your message

Click to key in your message

## Viewing your computer status on your smart device

Tap  on your smart device to launch Push Notice.

Push Notice

- Tap to view PC mode alerts
- Tap to view PC status alerts
- Tap to view PC sent messages
- Tap to scan more host computers

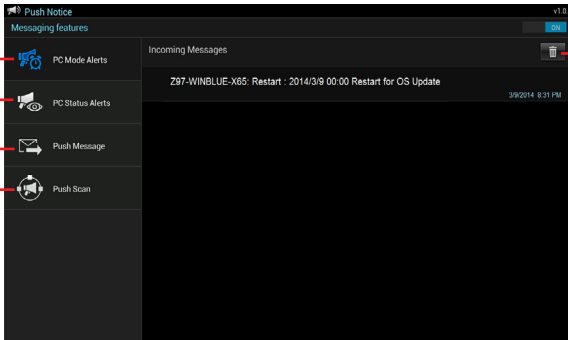

Tap to delete PC alerts



## 4.4.5 System Information

This utility allows you get the detailed information of the motherboard, CPU, and memory settings.

### Launching the System Information

To launch System Information, click  on the left of the AI Suite 3 main menu, then select **System Information**.

### Viewing the motherboard information

Click the **MB** tab to view the motherboard's information.

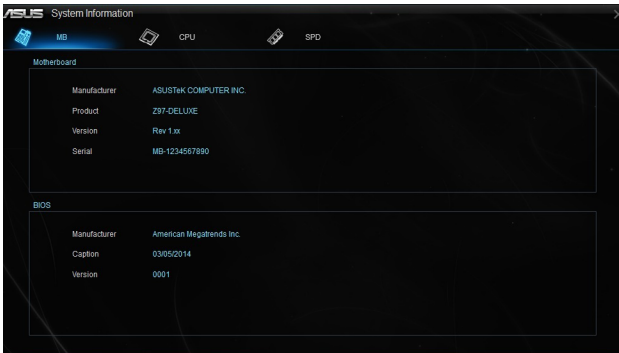

### Viewing the CPU information

Click the **CPU** tab to view the processor's information.

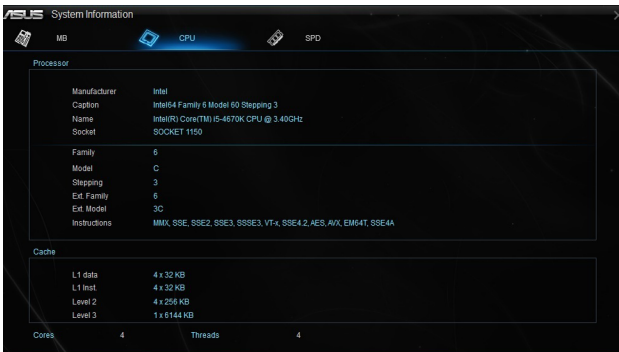

## Viewing the SPD information

Click the **SPD** tab to view the memory's information.



## 4.5 Audio configurations

The Realtek® audio CODEC provides 8-channel audio capability to deliver the ultimate audio experience on your computer. The software provides Jack-Sensing function, S/PDIF Out support, and interrupt capability. The CODEC also includes the Realtek® proprietary UAJ® (Universal Audio Jack) technology for all audio ports, eliminating cable connection errors, and giving users plug and play convenience.

Follow the installation wizard to install the Realtek® Audio Driver from the support DVD that came with the motherboard package.

If the Realtek® audio software is correctly installed, you will find the Realtek® HD Audio Manager icon on the taskbar. Double-Click on the icon to display the Realtek® HD Audio Manager.



Realtek® HD Audio Manager

### Realtek® HD Audio Manager with DTS Studio Sound™ for Windows® 8.1 / Windows® 7



## Selecting an audio output

Realtek HD Audio Manager allows you to select the type of audio output depending on the output device that you are using.

To select an audio output:

1. Insert the audio device's jack to the Line Out (lime) port. If the audio device's jack is already inserted to the corresponding port, Click  on the Realtek HD Audio Manager.
2. On the pop-up window, tick the audio device that you plugged to the Line Out port then Click **Next**.

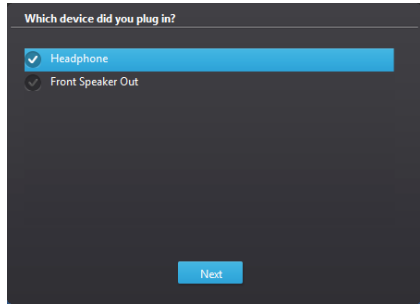

- a. If you select **Headphone**, Click to select the type of headphone installed then Click **OK**.

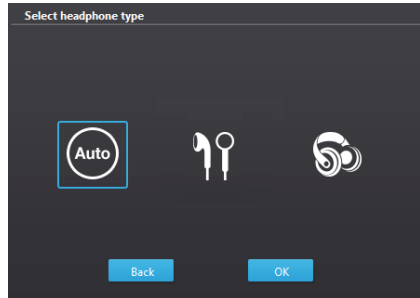

- b. If you select **Front Speaker Out**, Click to select the type of speaker installed then Click **OK**.

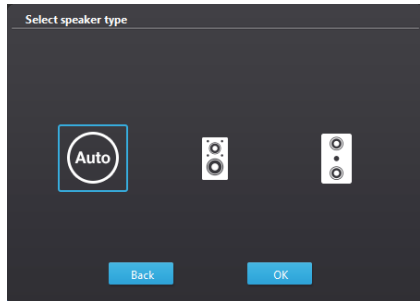

# RAID Support

# 5

## 5.1 RAID configurations

The motherboard supports Intel® Rapid Storage Technology with RAID 0, RAID 1, RAID 10, and RAID 5 solution.



---

If you want to install a Windows® operating system to a hard disk drive included in a RAID set, you have to create a RAID driver disk and load the RAID driver during OS installation. Refer to section 5.2 **Creating a RAID driver disk** for details.

---

### 5.1.1 RAID definitions

**RAID 0 (Data striping)** optimizes two identical hard disk drives to read and write data in parallel, interleaved stacks. Two hard disks perform the same work as a single drive but at a sustained data transfer rate, double that of a single disk alone, thus improving data access and storage. Use of two new identical hard disk drives is required for this setup.

**RAID 1 (Data mirroring)** copies and maintains an identical image of data from one drive to a second drive. If one drive fails, the disk array management software directs all applications to the surviving drive as it contains a complete copy of the data in the other drive. This RAID configuration provides data protection and increases fault tolerance to the entire system. Use two new drives or use an existing drive and a new drive for this setup. The new drive must be of the same size or larger than the existing drive.

**RAID 5** stripes both data and parity information across three or more hard disk drives. Among the advantages of RAID 5 configuration include better HDD performance, fault tolerance, and higher storage capacity. The RAID 5 configuration is best suited for transaction processing, relational database applications, enterprise resource planning, and other business systems. Use a minimum of three identical hard disk drives for this setup.

**RAID 10** is data striping and data mirroring combined without parity (redundancy data) having to be calculated and written. With the RAID 10 configuration you get all the benefits of both RAID 0 and RAID 1 configurations. Use four new hard disk drives or use an existing drive and three new drives for this setup.

## 5.1.2 Installing Serial ATA hard disks

The motherboard supports Serial ATA hard disk drives. For optimal performance, install identical drives of the same model and capacity when creating a disk array.

To install the SATA hard disks for a RAID configuration:

1. Install the SATA hard disks into the drive bays.
2. Connect the SATA signal cables.
3. Connect a SATA power cable to the power connector on each drive.

## 5.1.3 Setting the RAID item in BIOS

You must enable the RAID function in the BIOS Setup before creating RAID sets using SATA HDDs.

To set the RAID item in BIOS:

1. Enter the BIOS Setup during POST.
2. Go to the **Advanced** menu > **SATA Configuration**, then press <Enter>.
3. Set the SATA Mode item to **[RAID Mode]**.
4. Save your changes, and then exit the BIOS Setup.



---

Refer to Chapter 3 for details on entering and navigating through the BIOS Setup

---



---

Due to chipset limitation, when SATA ports are set to RAID mode, all SATA ports run at RAID mode together.

---

## 5.1.4 Intel® Rapid Storage Technology Option ROM utility

To enter the Intel® Rapid Storage Technology Option ROM utility:

1. Turn on the system.
2. During POST, press <Ctrl> + <I> to display the utility main menu.

```

Intel(R) Rapid Storage Technology - Option - v10.5.1.1070
Copyright(C) 2003-14 Intel Corporation. All Rights Reserved.

[ MAIN MENU ]

1. Create RAID Volume          4. Recovery Volume Options
2. Delete RAID Volume         5. Acceleration Options
3. Reset Disks to Non-RAID    6. Exit

[ DISK/VOLUME INFORMATION ]

RAID Volumes:
None defined.

Physical Devices:
Port  Device Model  Serial #      Size   Type/Status (Vol ID)
0     ST3160812AS     9LS0HJA4     149.0GB Non-RAID Disk
1     ST3160812AS     9LS0F4HL     149.0GB Non-RAID Disk
2     ST3160812AS     3LS0JYL8     149.0GB Non-RAID Disk
3     ST3160812AS     9LS0BJ5H     149.0GB Non-RAID Disk

[↑↓]-Select      [ESC]-Exit      [ENTER]-Select Menu

```

The navigation keys at the bottom of the screen allow you to move through the menus and select the menu options.



The RAID BIOS setup screens shown in this section are for reference only and may not exactly match the items on your screen.



The utility supports maximum four hard disk drives for RAID configuration.

## Creating a RAID set

To create a RAID set:

1. From the utility main menu, select **1. Create RAID Volume** and press <Enter>. The following screen appears:

```
Intel(R) Rapid Storage Technology - Option - v10.5.1.1070
Copyright(C) 2003-14 Intel Corporation. All Rights Reserved.

[CREATE VOLUME MENU]
Name: Volume 0
RAID Level:
Disks:
Strip Size:
Capacity:
Sync:
Create volume

[HELP]

Enter a unique volume name that has no special characters
and is 16 characters or less.

[↑↓]-Select      [ESC]-Exit      [ENTER]-Select Menu
```

2. Enter a name for the RAID set and press <Enter>.
3. When the RAID Level item is selected, press the up/down arrow key to select a RAID level to create, and then press <Enter>.
4. When the Disks item is selected, press <Enter> to select the hard disk drives you want to include in the RAID set. The SELECT DISKS screen appears:

```
[SELECT DISKS]

Port  Device Model  Serial #  Size  Status
0    ST3160812AS  9LS0HJA4  149.0GB  Non-RAID Disk
1    ST3160812AS  9LS0F4HL  149.0GB  Non-RAID Disk
2    ST3160812AS  3LS0JVL8  149.0GB  Non-RAID Disk
3    ST3160812AS  9LS0BJ5H  149.0GB  Non-RAID Disk

Select 2 to 6 to use in creating the volume.

[↑↓]-Prev/Next  [SPACE]-SelectDisk  [ENTER]-Done
```



5. Use the up/down arrow key to select a drive, and then press <Space> to select. A small triangle marks the selected drive. Press <Enter> after completing your selection.
6. Use the up/down arrow key to select the stripe size for the RAID array (for RAID 0, 10 and 5 only), then press <Enter>. The available stripe size values range from 4 KB to 128 KB. The following are typical values:
  - RAID 0: 128 KB
  - RAID 10: 64 KB
  - RAID 5: 64 KB



---

We recommend a lower stripe size for server systems, and a higher stripe size for multimedia computer systems used mainly for audio and video editing.

---

7. When the **Capacity** item is selected, enter the RAID volume capacity that you want and press <Enter>. The default value indicates the maximum allowed capacity.
8. When the **Create Volume** item is selected, press <Enter>. The following warning message appears:

```
WARNING: ALL DATA ON SELECTED DISKS WILL BE LOST.  
Are you sure you want to create this volume? (Y/N)
```

9. Press <Y> to create the RAID volume and return to the main menu, or <N> to go back to the **CREATE VOLUME** menu.

## Deleting a RAID set



Be cautious when deleting a RAID set. You will lose all data on the hard disk drives when you delete a RAID set.

To delete a RAID set:

1. From the utility main menu, select **2. Delete RAID Volume** and press <Enter>. The following screen appears:

```
[DELETE VOLUME MENU]
Name      Level      Drives  Capacity  Status  Bootable
Volume0   RAID0 (Stripe)  2       298.0GB  Normal  Yes

[HELP]

Deleting a volume will reset the disks to non-RAID.

WARNING: ALL DISK DATA WILL BE DELETED.
(This does not apply to Recovery volumes)

[↑]-Select  [ESC]-Previous Menu  [DEL]-Delete Volume
```

2. Use the up/down arrow key to select the RAID set you want to delete, and then press <Delete>. The following warning message appears:

```
[DELETE VOLUME VERIFICATION]

ALL DATA IN THE VOLUME WILL BE LOST!
(This does not apply to Recovery volumes)

Are you sure you want to delete "Volume0"? (Y/N):
```

3. Press <Y> to delete the RAID set and return to the utility main menu, or press <N> to return to the DELETE VOLUME menu.

## Exiting the Intel® Rapid Storage Technology Option ROM utility

To exit the utility:

1. From the utility main menu, select **5. Exit**, then press <Enter>. The following warning message appears:

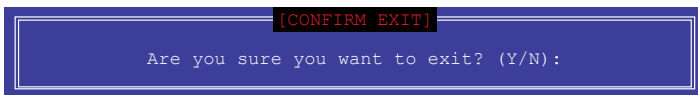

2. Press <Y> to exit or press <N> to return to the utility main menu.

## 5.2 Creating a RAID driver disk

A floppy disk with the RAID driver is required when installing a Windows® operating system on a hard disk drive that is included in a RAID set.



---

Ensure to set PCI-EX16\_3 slot bandwidth to X4 mode if you want to create a RAID configuration with a PCIe device on the PCI-EX16\_3 slot. Refer to section **3.6.8 Onboard Devices Configuration** for more information.

---

### 5.2.1 Creating a RAID driver disk in Windows®

To create a RAID driver disk in Windows®:

1. Start Windows®.
2. Plug the USB storage device.
3. Place the motherboard support DVD into the optical drive.
4. Go to the **Intel AHCI/RAID Driver** menu then click **Intel AHCI/RAID Driver path** to open the RAID driver folder.
5. Select **32bit** or **64bit** folder depending on your operating system. Copy the files of the selected folder to the root path of your USB storage device.



---

To set up a Windows® UEFI operating system under RAID mode, ensure to load the UEFI driver for your optical drive.

---

## 5.2.2 Installing the RAID driver during Windows® OS installation

To install the RAID driver for Windows® 7:

1. During the OS installation, click **Load Driver** to allow you to select the installation media containing the RAID driver.
2. Insert the USB flash drive with RAID driver into the USB port or the support DVD into the optical drive, and then click **Browse**.
3. Click the name of the device you've inserted, go to **Drivers > RAID**, and then select the RAID driver for the corresponding OS version. Click **OK**.
4. Follow the succeeding screen instructions to complete the installation.



---

Before loading the RAID driver from a USB flash drive, you have to use another computer to copy the RAID driver from the support DVD to the USB flash drive.

---

# Appendix

## Notices

### Federal Communications Commission Statement

This device complies with Part 15 of the FCC Rules. Operation is subject to the following two conditions:

- This device may not cause harmful interference.
- This device must accept any interference received including interference that may cause undesired operation.

This equipment has been tested and found to comply with the limits for a Class B digital device, pursuant to Part 15 of the FCC Rules. These limits are designed to provide reasonable protection against harmful interference in a residential installation. This equipment generates, uses and can radiate radio frequency energy and, if not installed and used in accordance with manufacturer's instructions, may cause harmful interference to radio communications. However, there is no guarantee that interference will not occur in a particular installation. If this equipment does cause harmful interference to radio or television reception, which can be determined by turning the equipment off and on, the user is encouraged to try to correct the interference by one or more of the following measures:

- Reorient or relocate the receiving antenna.
- Increase the separation between the equipment and receiver.
- Connect the equipment to an outlet on a circuit different from that to which the receiver is connected.
- Consult the dealer or an experienced radio/TV technician for help.



---

The use of shielded cables for connection of the monitor to the graphics card is required to assure compliance with FCC regulations. Changes or modifications to this unit not expressly approved by the party responsible for compliance could void the user's authority to operate this equipment.

---

## IC: Canadian Compliance Statement

Complies with the Canadian ICES-003 Class B specifications. This device complies with RSS 210 of Industry Canada. This Class B device meets all the requirements of the Canadian interference-causing equipment regulations.

This device complies with Industry Canada license exempt RSS standard(s). Operation is subject to the following two conditions: (1) this device may not cause interference, and (2) this device must accept any interference, including interference that may cause undesired operation of the device.

Cet appareil numérique de la Classe B est conforme à la norme NMB-003 du Canada. Cet appareil numérique de la Classe B respecte toutes les exigences du Règlement sur le matériel brouilleur du Canada.

Cet appareil est conforme aux normes CNR exemptes de licence d'Industrie Canada. Le fonctionnement est soumis aux deux conditions suivantes :

- (1) cet appareil ne doit pas provoquer d'interférences et
- (2) cet appareil doit accepter toute interférence, y compris celles susceptibles de provoquer un fonctionnement non souhaité de l'appareil.

## Canadian Department of Communications Statement

This digital apparatus does not exceed the Class B limits for radio noise emissions from digital apparatus set out in the Radio Interference Regulations of the Canadian Department of Communications.

This class B digital apparatus complies with Canadian ICES-003.

## VCCI: Japan Compliance Statement

### Class B ITE

この装置は、クラスB情報技術装置です。この装置は、家庭環境で使用することを目的としていますが、この装置がラジオやテレビジョン受信機に近接して使用されると、受信障害を引き起こすことがあります。

取扱説明書に従って正しい取り扱いをして下さい。

V C C I - B

## KC: Korea Warning Statement

B급 기기 (가정용 방송통신기자재)

이 기기는 가정용(B급) 전자파적합기기로서 주로 가정에서 사용하는 것을 목적으로 하며, 모든 지역에서 사용할 수 있습니다.

## REACH

Complying with the REACH (Registration, Evaluation, Authorisation, and Restriction of Chemicals) regulatory framework, we published the chemical substances in our products at ASUS REACH website at <http://csr.asus.com/english/REACH.htm>.



DO NOT throw the motherboard in municipal waste. This product has been designed to enable proper reuse of parts and recycling. This symbol of the crossed out wheeled bin indicates that the product (electrical and electronic equipment) should not be placed in municipal waste. Check local regulations for disposal of electronic products.



DO NOT throw the mercury-containing button cell battery in municipal waste. This symbol of the crossed out wheeled bin indicates that the battery should not be placed in municipal waste.

## ASUS Recycling/Takeback Services

ASUS recycling and takeback programs come from our commitment to the highest standards for protecting our environment. We believe in providing solutions for you to be able to responsibly recycle our products, batteries, other components as well as the packaging materials. Please go to <http://csr.asus.com/english/Takeback.htm> for detailed recycling information in different regions.

## Google™ License Terms

**Copyright© 2015 Google Inc. All Rights Reserved.**

Licensed under the Apache License, Version 2.0 (the "License"); you may not use this file except in compliance with the License. You may obtain a copy of the License at:

<http://www.apache.org/licenses/LICENSE-2.0>

Unless required by applicable law or agreed to in writing, software distributed under the License is distributed on an "AS IS" BASIS, WITHOUT WARRANTIES OR CONDITIONS OF ANY KIND, either express or implied.

See the License for the specific language governing permissions and limitations under the License.

**English** AsusTek Inc. hereby declares that this device is in compliance with the essential requirements and other relevant provisions of CE Directives. Please see the CE Declaration of Conformity for more details.

**Français** AsusTek Inc. déclare par la présente que cet appareil est conforme aux critères essentiels et autres clauses pertinentes des directives européennes. Veuillez consulter la déclaration de conformité CE pour plus d'informations.

**Deutsch** AsusTek Inc. erklärt hiermit, dass dieses Gerät mit den wesentlichen Anforderungen und anderen relevanten Bestimmungen der CE-Richtlinien übereinstimmt. Weitere Einzelheiten entnehmen Sie bitte der CE-Konformitätserklärung.

**Italiano** AsusTek Inc. con la presente dichiara che questo dispositivo è conforme ai requisiti essenziali e alle altre disposizioni pertinenti alle direttive CE. Per maggiori informazioni fate riferimento alla dichiarazione di conformità CE.

**Компания** ASUS заявляет, что это устройство соответствует основным требованиям и другим соответствующим условиям европейских директив. Подробную информацию, пожалуйста, смотрите в декларации соответствия.

**Български** С настоящото AsusTek Inc. декларира, че това устройство е в съответствие със съществениите изисквания и другите приложими постановления на директивите CE. Вижте CE декларацията за съвместимост за повече информация.

**Hrvatski** AsusTek Inc. ovim izjavljuje da je ovaj uređaj sukladan s bitnim zahtjevima i ostalim odgovarajućim odredbama CE direktiva. Više pojedinosti potražite u CE izvaji o skladnosti.

**Čeština** Společnost AsusTek Inc. tímto prohlašuje, že toto zařízení splňuje základní požadavky a další příslušná ustanovení směrníc CE. Další podrobnosti viz Prohlášení o shodě CE.

**Dansk** AsusTek Inc. Erklærer hermed, at denne enhed er i overensstemmelse med hovedkravene and andre relevante bestemmelser i CE-direktiverne. Du kan læse mere i CE-overensstemmelseserklæring.

**Nederlands** AsusTek Inc. verklaart hierbij dat dit apparaat compatibel is met de essentiële vereisten en andere relevante bepalingen van CE-richtlijnen. Raadpleeg de CE-verklaring van conformiteit voor meer details.

**Eesti** Käesolevaga kinnitab AsusTek Inc., et see seade vastab CE direktiivide oluliste nõuetele ja teisteles asjakohastele sätetele. Vt üksikasju CE vastavusdeklaratsioonist.

**Suomi** AsusTek Inc. vakuuttaa täten, että tämä laite on CE-direktiivien olennaisten vaatimusten ja muiden asiaan kuuluvien lisäysten mukainen. Katso lisätietoja CE-vaatimustenmukaisuusvakuutuksesta.

**Ελληνικά** Με το παρόν, η AsusTek Inc. Δηλώνει ότι αυτή η συσκευή συμμορφώνεται με τις θεμελιώδεις απαιτήσεις και άλλες σχετικές διατάξεις των Οδηγιών της ΕΕ. Για περισσότερες λεπτομέρειες ανατρέξτε στην Δήλωση Συμμόρφωσης ΕΕ.

**Magyar** Az AsusTek Inc. ezennel kijelenti, hogy a készülék megfelel a CE-irányelvek alapvető követelményeinek és ide vonatkozó egyéb rendelkezéseinek. További részletekért tekintse meg a CE-megfelelőségi nyilatkozatot.

**Latviski** Lidz ar šo AsusTek Inc. paziņo, ka šī ierīce atbilst būtiskajām prasībām un citiem saistošajiem nosacījumiem, kas norādīti CE direktīvā. Lai uzzinātu vairāk, skatiet CE Atbilstības deklarāciju.

**Lietuvių** Šiuo dokumentu bendrovė „AsusTek Inc.“ pareiškia, kad šis įrenginys atitinka pagrindinius CE direktyvų reikalavimus ir kitas susijusias nuostatas. Daugiau informacijos rasite CE atitikties deklaracijoje.

**Norsk** AsusTek Inc. erklærer herved at denne enheten er i samsvar med hovedsaklige krav og andre relevante forskrifter i CE-direktiver. Du finner mer informasjon i CE-samsvarserklæringen.

**Polski** Niniejszym AsusTek Inc. deklaruje, że to urządzenie jest zgodne z istotnymi wymaganiami oraz innymi powiązanymi zaleceniami Dyrektywy CE. W celu uzyskania szczegółów, sprawdź Deklarację zgodności CE.

**Português** A AsusTek Inc. declara que este dispositivo está em conformidade com os requisitos essenciais e outras disposições relevantes das Diretivas da CE. Para mais detalhes, consulte a Declaração de Conformidade CE.

**Română** Prin prezenta, AsusTek Inc. declară faptul că acest dispozitiv respectă cerințele esențiale și alte prevederi relevante ale directivelor CE. Pentru mai multe detalii, consultați declarația de conformitate CE.

**Srpski** AsusTek Inc. ovim izjavljuje da je ovaj uređaj u saglasnosti sa ključnim zahtjevima i drugim relevantnim odredbama CE Direktiva. Molimo vas, pogledajte CE Deklaraciju o uskladenosti za više detalja.

**Slovensky** Spoločnosť AsusTek Inc. týmto prehlasuje, že toto zariadenie vyhovuje príslušným požiadavkám a ďalším súvisiacim ustanoveniam smerníc ES. Viac podrobností si pozrite v prehlásení o zhode ES.

**Slovenščina** AsusTek Inc. tukaj izjavlja, da je ta naprava skladna s temeljnimi zahtevami in drugimi relevantnimi določili direktiv CE. Za več informacij glejte Izjavo CE o skladnosti.

**Español** Por la presente, AsusTek Inc. declara que este dispositivo cumple los requisitos básicos y otras disposiciones relevantes de las directivas de la CE. Consulte la Declaración de conformidad de la CE para obtener más detalles.

**Svenska** AsusTek Inc. förklarar härmed att denna enhet är i överensstämmelse med de grundläggande kraven och andra relevanta bestämmelser i CE-direktiven. Se CE-försäkran om överensstämmelse för mer information.

**Українська** AsusTek Inc. заявляє, що цей пристрій відповідає основним вимогам відповідних Директив ЄС. Будь ласка, див. більше подробиць у Декларації відповідності нормам ЄС.

**Türkçe** AsusTek Inc., bu aygıtın temel gereksinimleri ve CE Yönergelerinin diğer ilgili koşullarına uyumlu olduğunu beyan eder. Daha fazla ayrıntı için lütfen CE Uygunluk Beyanına bakın.

**Bosanski** AsusTek Inc. ovim potvrđuje da je ovaj uređaj uskladen s osnovnim zahtjevima i drugim relevantnim propisima Direktiva EK. Za više informacija molimo pogledajte Deklaraciju o uskladenosti EK.



## ASUS contact information

### ASUSTeK COMPUTER INC.

Address 15 Li-Te Road, Peitou, Taipei, Taiwan 11259  
Telephone +886-2-2894-3447  
Fax +886-2-2890-7798  
E-mail [info@asus.com.tw](mailto:info@asus.com.tw)  
Web site [www.asus.com.com/](http://www.asus.com.com/)

#### **Technical Support**

Telephone +86-21-38429911  
Fax +86-21-5866-8722, ext. 9101#  
Online support <http://www.asus.com/tw/support/>

### ASUS COMPUTER INTERNATIONAL (America)

Address 800 Corporate Way, Fremont, CA 94539, USA  
Telephone +1-510-739-3777  
Fax +1-510-608-4555  
Web site <http://www.asus.com/us/>

#### **Technical Support**

Support fax +1-812-284-0883  
Telephone +1-812-282-2787  
Online support <http://www.service.asus.com/>

### ASUS COMPUTER GmbH (Germany and Austria)

Address Harkort Str. 21-23, D-40880 Ratingen, Germany  
Fax +49-2102-959911  
Web site <http://www.asus.com/de>  
Online contact <http://eu-rma.asus.com/sales>

#### **Technical Support**

Telephone +49-1805-010923  
Support Fax +49-2102-9599-11  
Online support <http://www.asus.com/de/support/>



**EC Declaration of Conformity**

We, the undersigned,

Manufacturer: ASUS OF COMPUTER INC.  
 4F, NO. 150, LITE RD., SEITZOU, TAIPEI 112, TAIWAN  
 Authorized representative in Europe: ASUS COMPUTER GmbH  
 Address, City: HARKORT STR. 21-23, 40880 RATINGEN  
 Country: GERMANY

declare the following apparatus:

Product name: Motherboard  
 Model name: Z170-PRO

conform with the essential requirements of the following directives:

- 2004/108/EC EMC Directive
  - EN 55022:2010/A2:2011
  - EN 55024:2010
  - EN 55035:2010/A2:2011
  - EN 55032:2007/A1:2011
- 1989/532/EEC BATTERY Directive
  - EN 300 358 V1.6 (2012-06)
  - EN 300 440-1 V1.6 (10/10-08)
  - EN 300 440-2 V1.6 (10/10-08)
  - EN 300 440-3 V1.6 (10/10-08)
  - EN 301 511 V1.0 (20/03-03)
  - EN 301 998-1 V1.2 (1/01-05)
  - EN 301 998-2 V1.2 (1/01-05)
  - EN 301 883 V1.7 (20/12-08)
  - EN 301 883 V1.7 (20/12-08)
  - EN 302 544-2 V1.1 (10/09-01)
  - EN 302 544-1 (10/09-01)
  - EN 55060:2001
  - EN 62479:2010
  - EN 62311:2008
- 2006/66/EC LVD Directive
  - EN 60950-1:2006/A12:2011
  - EN 60950-1:2006/AC:2013
- 2007/25/EC EPT Directive
  - Regulation (EC) No. 1275/2008
  - Regulation (EC) No. 642/2009
- 2011/65/EU RoHS Directive
  - EN 50528:2011
  - EN 302 291-1 V1.1 (10/05-07)
  - EN 302 291-2 V1.1 (10/05-07)
  - EN 302 291-3 V1.1 (10/05-07)
  - EN 50526:2013

Ver: 1/03/26



(EC conformity marking)

Position: CEO  
 Name: Jerry Shen

Signature: \_\_\_\_\_

Declaration Date: 07/09/2015  
 Year to begin affixing CE marking: 2015

**DECLARATION OF CONFORMITY**

Per FCC Part 2 Section 2.1077(a)



Responsible Party Name: Asus Computer International

Address: 800 Corporate Way, Fremont, CA 94539.

Phone/Fax No: (510)739-3777/(510)608-4555

herby declares that the product

Product Name : Motherboard

Model Number : Z170-PRO

Conforms to the following specifications:

- FCC Part 15, Subpart B, Unintentional Radiators

**Supplementary Information:**

This device complies with part 15 of the FCC Rules. Operation is subject to the following two conditions: (1) This device may not cause harmful interference, and (2) this device must accept any interference received, including interference that may cause undesired operation.

Representative Person's Name : Steve Chang / President

Signature :

Date : SEP. 07. 2015

Ver: 14/03/31