



## **P8H61-M LX3 R2.0 Series**

- *P8H61-M LX3 R2.0*
- *P8H61-M LX3 PLUS R2.0*

# Motherboard

E7378

First Edition

May 2012

**Copyright © 2012 ASUSTeK COMPUTER INC. All Rights Reserved.**

No part of this manual, including the products and software described in it, may be reproduced, transmitted, transcribed, stored in a retrieval system, or translated into any language in any form or by any means, except documentation kept by the purchaser for backup purposes, without the express written permission of ASUSTeK COMPUTER INC. ("ASUS").

Product warranty or service will not be extended if: (1) the product is repaired, modified or altered, unless such repair, modification or alteration is authorized in writing by ASUS; or (2) the serial number of the product is defaced or missing.

ASUS PROVIDES THIS MANUAL "AS IS" WITHOUT WARRANTY OF ANY KIND, EITHER EXPRESS OR IMPLIED, INCLUDING BUT NOT LIMITED TO THE IMPLIED WARRANTIES OR CONDITIONS OF MERCHANTABILITY OR FITNESS FOR A PARTICULAR PURPOSE. IN NO EVENT SHALL ASUS, ITS DIRECTORS, OFFICERS, EMPLOYEES OR AGENTS BE LIABLE FOR ANY INDIRECT, SPECIAL, INCIDENTAL, OR CONSEQUENTIAL DAMAGES (INCLUDING DAMAGES FOR LOSS OF PROFITS, LOSS OF BUSINESS, LOSS OF USE OR DATA, INTERRUPTION OF BUSINESS AND THE LIKE), EVEN IF ASUS HAS BEEN ADVISED OF THE POSSIBILITY OF SUCH DAMAGES ARISING FROM ANY DEFECT OR ERROR IN THIS MANUAL OR PRODUCT.

SPECIFICATIONS AND INFORMATION CONTAINED IN THIS MANUAL ARE FURNISHED FOR INFORMATIONAL USE ONLY, AND ARE SUBJECT TO CHANGE AT ANY TIME WITHOUT NOTICE, AND SHOULD NOT BE CONSTRUED AS A COMMITMENT BY ASUS. ASUS ASSUMES NO RESPONSIBILITY OR LIABILITY FOR ANY ERRORS OR INACCURACIES THAT MAY APPEAR IN THIS MANUAL, INCLUDING THE PRODUCTS AND SOFTWARE DESCRIBED IN IT.

Products and corporate names appearing in this manual may or may not be registered trademarks or copyrights of their respective companies, and are used only for identification or explanation and to the owners' benefit, without intent to infringe.

**Offer to Provide Source Code of Certain Software**

This product contains copyrighted software that is licensed under the General Public License ("GPL"), under the Lesser General Public License Version ("LGPL") and/or other Free Open Source Software Licenses. Such software in this product is distributed without any warranty to the extent permitted by the applicable law. Copies of these licenses are included in this product.

Where the applicable license entitles you to the source code of such software and/or other additional data, you may obtain it for a period of three years after our last shipment of the product, either

(1) for free by downloading it from <http://support.asus.com/download>  
or

(2) for the cost of reproduction and shipment, which is dependent on the preferred carrier and the location where you want to have it shipped to, by sending a request to:

ASUSTeK Computer Inc.  
Legal Compliance Dept.  
15 Li Te Rd.,  
Beitou, Taipei 112  
Taiwan

In your request please provide the name, model number and version, as stated in the About Box of the product for which you wish to obtain the corresponding source code and your contact details so that we can coordinate the terms and cost of shipment with you.

The source code will be distributed WITHOUT ANY WARRANTY and licensed under the same license as the corresponding binary/object code.

This offer is valid to anyone in receipt of this information.

ASUSTeK is eager to duly provide complete source code as required under various Free Open Source Software licenses. If however you encounter any problems in obtaining the full corresponding source code we would be much obliged if you give us a notification to the email address [gpl@asus.com](mailto:gpl@asus.com), stating the product and describing the problem (please DO NOT send large attachments such as source code archives, etc. to this email address).

# Contents

Safety information .....	vi
About this guide .....	vi
P8H61-M LX3 R2.0 Series specifications summary.....	viii

## Chapter 1: Product introduction

<b>1.1</b>	<b>Welcome!</b> .....	<b>1-1</b>
<b>1.2</b>	<b>Package contents</b> .....	<b>1-1</b>
<b>1.3</b>	<b>Special features</b> .....	<b>1-1</b>
1.3.1	Product highlights .....	1-1
1.3.2	Innovative ASUS features .....	1-3
<b>1.4</b>	<b>Before you proceed</b> .....	<b>1-5</b>
<b>1.5</b>	<b>Motherboard overview</b> .....	<b>1-6</b>
1.5.1	Placement direction .....	1-6
1.5.2	Screw holes .....	1-6
1.5.3	Motherboard layout .....	1-7
1.5.4	Layout contents.....	1-7
<b>1.6</b>	<b>Central Processing Unit (CPU)</b> .....	<b>1-8</b>
1.6.1	Installing the CPU .....	1-8
1.6.2	Installing the CPU heatsink and fan .....	1-11
1.6.3	Uninstalling the CPU heatsink and fan .....	1-12
<b>1.7</b>	<b>System memory</b> .....	<b>1-13</b>
1.7.1	Overview .....	1-13
1.7.2	Memory configurations.....	1-14
1.7.3	Installing a DIMM .....	1-18
1.7.4	Removing a DIMM .....	1-18
<b>1.8</b>	<b>Expansion slots</b> .....	<b>1-19</b>
1.8.1	Installing an expansion card .....	1-19
1.8.2	Configuring an expansion card .....	1-19
1.8.3	PCI Express x1 slot.....	1-19
1.8.4	PCI Express 3.0/2.0 x16 slot.....	1-19
<b>1.9</b>	<b>Jumpers</b> .....	<b>1-20</b>
<b>1.10</b>	<b>Connectors</b> .....	<b>1-21</b>
1.10.1	Rear panel connectors.....	1-21
1.10.2	Internal connectors .....	1-22

# Contents

<b>1.11</b>	<b>Software support</b> .....	<b>1-27</b>
1.11.1	Installing an operating system .....	1-27
1.11.2	Support DVD information .....	1-27

## Chapter 2: BIOS information

<b>2.1</b>	<b>Managing and updating your BIOS</b> .....	<b>2-1</b>
2.1.1	ASUS Update utility .....	2-1
2.1.2	ASUS EZ Flash 2 .....	2-2
2.1.3	ASUS CrashFree BIOS 3 utility .....	2-3
2.1.4	ASUS BIOS Updater .....	2-4
<b>2.2</b>	<b>BIOS setup program</b> .....	<b>2-6</b>
<b>2.3</b>	<b>Main menu</b> .....	<b>2-10</b>
2.3.1	System Language [English] .....	2-10
2.3.2	System Date [Day xx/xx/xxxx].....	2-10
2.3.3	System Time [xx:xx:xx] .....	2-10
2.3.4	Security .....	2-10
<b>2.4</b>	<b>Ai Tweaker menu</b> .....	<b>2-12</b>
2.4.1	Ai Overclock Tuner [Auto] .....	2-12
2.4.2	ASUS MultiCore Enhancement [Enabled] .....	2-12
2.4.3	Memory Frequency [Auto].....	2-12
2.4.4	GPU Boost .....	2-13
2.4.5	DRAM Timing Control .....	2-13
2.4.6	CPU Power Management .....	2-13
<b>2.5</b>	<b>Advanced menu</b> .....	<b>2-14</b>
2.5.1	CPU Configuration .....	2-14
2.5.2	PCH Configuration .....	2-16
2.5.3	SATA Configuration .....	2-16
2.5.4	System Agent Configuration .....	2-17
2.5.5	USB Configuration .....	2-18
2.5.6	Onboard Devices Configuration .....	2-18
2.5.7	APM .....	2-19
2.5.8	Network Stack.....	2-19
<b>2.6</b>	<b>Monitor menu</b> .....	<b>2-20</b>
2.6.1	CPU Temperature / MB Temperature [xxx°C/xxx°F].....	2-20
2.6.2	CPU / Chassis Fan Speed .....	2-20

## Contents

2.6.3	CPU Voltage, 3.3V Voltage, 5V Voltage, 12V Voltage ..	2-20
2.6.4	CPU Q-Fan Control [Enabled] .....	2-21
2.6.5	Chassis Q-Fan Control [Enabled] .....	2-21
2.6.6	Anti Surge Support [Enabled] .....	2-22
<b>2.7</b>	<b>Boot menu .....</b>	<b>2-23</b>
2.7.1	Bootup NumLock State [On] .....	2-23
2.7.2	Full Screen Logo [Enabled].....	2-23
2.7.3	Wait for 'F1' If Error [Enabled].....	2-23
2.7.4	Option ROM Messages [Force BIOS].....	2-24
2.7.5	Setup Mode [EZ Mode] .....	2-24
2.7.6	UEFI/Legacy Boot [Enabled both UEFI and Legacy]....	2-24
2.7.7	PCI ROM Priority [Legacy ROM] .....	2-24
2.7.8	Boot Option Priorities .....	2-24
2.7.9	Boot Override.....	2-24
<b>2.8</b>	<b>Tools menu .....</b>	<b>2-25</b>
2.8.1	ASUS EZ Flash 2 Utility .....	2-25
2.8.2	ASUS SPD Information .....	2-25
2.8.3	ASUS O.C. Profile.....	2-25
<b>2.9</b>	<b>Exit menu .....</b>	<b>2-26</b>

## Appendices

Notices.....	A-1
--------------	-----

# Safety information

## Electrical safety

- To prevent electric shock hazard, disconnect the power cable from the electric outlet before relocating the system.
- When adding or removing devices to or from the system, ensure that the power cables for the devices are unplugged before the signal cables are connected. If possible, disconnect all power cables from the existing system before you add a device.
- Before connecting or removing signal cables from the motherboard, ensure that all power cables are unplugged.
- Seek professional assistance before using an adapter or extension cord. These devices could interrupt the grounding circuit.
- Ensure that your power supply is set to the correct voltage in your area. If you are not sure about the voltage of the electrical outlet you are using, contact your local power company.
- If the power supply is broken, do not try to fix it by yourself. Contact a qualified service technician or your retailer.

## Operation safety

- Before installing the motherboard and adding devices on it, carefully read all the manuals that came with the package.
- Before using the product, ensure that all cables are correctly connected and the power cables are not damaged. If you detect any damage, contact your dealer immediately.
- To avoid short circuits, keep paper clips, screws, and staples away from connectors, slots, sockets and circuitry.
- Avoid dust, humidity, and temperature extremes. Do not place the product in any area where it may become wet.
- Place the product on a stable surface.
- If you encounter technical problems with the product, contact a qualified service technician or your retailer.

## About this guide

This user guide contains the information you need when installing and configuring the motherboard.

### How this guide is organized

This guide contains the following parts:

- **Chapter 1: Product introduction**  
This chapter describes the features of the motherboard and the new technology it supports.
- **Chapter 2: BIOS information**  
This chapter tells how to change system settings through the BIOS Setup menus. Detailed descriptions of the BIOS parameters are also provided.

## Conventions used in this guide

To ensure that you perform certain tasks properly, take note of the following symbols used throughout this manual.



**DANGER/WARNING:** Information to prevent injury to yourself when trying to complete a task.



**CAUTION:** Information to prevent damage to the components when trying to complete a task.



**IMPORTANT:** Instructions that you **MUST** follow to complete a task.



**NOTE:** Tips and additional information to help you complete a task.

## Where to find more information

Refer to the following sources for additional information and for product and software updates.

### 1. ASUS websites

The ASUS website provides updated information on ASUS hardware and software products. Refer to the ASUS contact information.

### 2. Optional documentation

Your product package may include optional documentation, such as warranty flyers, that may have been added by your dealer. These documents are not part of the standard package.

## Typography

### **Bold text**

*Italics*

<Key>

Indicates a menu or an item to select.

Used to emphasize a word or a phrase.

Keys enclosed in the less-than and greater-than sign means that you must press the enclosed key.

Example: <Enter> means that you must press the Enter or Return key.

<Key1>+<Key2>+<Key3>

If you must press two or more keys simultaneously, the key names are linked with a plus sign (+).

Example: <Ctrl>+<Alt>+<D>

## P8H61-M LX3 R2.0 Series specifications summary

<b>CPU</b>	<p>LGA1155 socket for Intel® 3rd/2nd Generation Core™ i7 / Core™ i5 / Core™ i3 / Pentium® / Celeron® processors</p> <p>Supports Intel 22nm CPU</p> <p>Supports Intel® Turbo Boost Technology 2.0</p> <p>* The Intel® Turbo Boost Technology 2.0 support depends on the CPU types.</p> <p>** Refer to <a href="http://www.asus.com">www.asus.com</a> for Intel® CPU support list.</p>
<b>Chipset</b>	Intel® H61 Express Chipset
<b>Memory</b>	<p>2 x DIMMs, max. 16GB, DDR3 2200 (O.C.) / 2133 (O.C.) / 2000 (O.C.) / 1866 (O.C.) / 1600 / 1333 / 1066 MHz, non-ECC, unbuffered memory</p> <p>Dual-channel memory architecture</p> <p>* DDR3 1600 MHz and higher memory frequency is supported by Intel® 3rd generation processors.</p> <p>** Refer to <a href="http://www.asus.com">www.asus.com</a> for the latest Memory QVL (Qualified Vendors List).</p> <p>***When you install a total memory of 4GB capacity or more, Windows® 32-bit operating system may only recognize less than 3GB. We recommend a maximum of 3GB system memory if you are using a Windows® 32-bit operating system.</p>
<b>Expansion slots</b>	<p>1 x PCI Express 3.0*/2.0 x16 slot with latch</p> <p>2 x PCI Express 2.0 x1 slots</p> <p>* PCIe 3.0 speed is supported by Intel® 3rd generation Core™ processors.</p>
<b>Graphics</b>	<p>Supports D-Sub with max. resolution of 2048 x 1536 @75Hz</p> <p>Max. UMA Memory: 1748MB</p>
<b>Storage</b>	<p>Intel® H61 Express Chipset:</p> <ul style="list-style-type: none"> <li>- 4 x Serial ATA 3.0 Gb/s connectors</li> </ul>
<b>LAN</b>	Realtek® 8111F PCIe Gigabit LAN controller
<b>Audio</b>	<p>VIA® VT1708S 8-channel* High Definition Audio CODEC</p> <ul style="list-style-type: none"> <li>- Supports Multi-Streaming</li> </ul> <p>* Use a chassis with HD audio module in the front panel to support an 8-channel audio output.</p>
<b>USB</b>	10 x USB 2.0/1.1 ports (6 ports at the mid-board, 4 ports at the back panel)
<b>Other features</b>	100% All High-quality Conductive Polymer Capacitors <b>(P8H61-M LX3 PLUS R2.0 only)</b>

*(continued on the next page)*



## P8H61-M LX3 R2.0 Series specifications summary

<b>ASUS unique features</b>	<p>ASUS Anti-Surge Protection  ASUS UEFI BIOS featuring friendly graphics user interface  ASUS AI Suite II  ASUS Fan Xpert  ASUS Q-Fan 2  ASUS Network iControl* featuring instant network bandwidth domination for top network program in use  ASUS AI Charger  ASUS WebStorage  ASUS CrashFree BIOS 3  ASUS EZ Flash 2  ASUS MyLogo 2™  * The ASUS Network iControl feature does not support Windows® XP/Vista operating systems.</p>
<b>Rear panel ports</b>	<p>1 x PS/2 keyboard port (purple)  1 x PS/2 mouse port (green)  1 x D-Sub port  1 x LAN (RJ-45) port  4 x USB 2.0/1.1 ports  3 x Audio jacks</p>
<b>Internal connectors/jumpers</b>	<p>3 x USB 2.0/1.1 connectors support additional 6 USB 2.0/1.1 ports  4 x SATA 3.0 Gb/s connectors  1 x 4-pin CPU fan connector  1 x 4-pin chassis fan connector  1 x Front panel audio connector  1 x System panel connector  1 x Speaker connector  1 x 24-pin ATX power connector  1 x 4-pin ATX 12V power connector  1 x Clear CMOS jumper</p>
<b>BIOS features</b>	<p>64 Mb Flash ROM, UEFI BIOS, PnP, DMI v2.0, WfM 2.0, ACPI v2.0a, SM BIOS v2.7, SLP 3.0, EUP-ready, Multi-language BIOS, ASUS EZ Flash 2, ASUS CrashFree BIOS 3, F12 PrintScreen function, F3 Shortcut function, and ASUS DRAM SPD (Serial Presence Detect) memory information</p>
<b>Manageability</b>	<p>WOL, PXE, PME Wake Up</p>
<b>Accessories</b>	<p>2 x Serial ATA 3.0Gb/s cables  1 x I/O shield  1 x User Manual  1 x Support DVD</p>
<b>Support DVD</b>	<p>Drivers  ASUS utilities  ASUS Update  Anti-virus software (OEM version)</p>
<b>Form factor</b>	<p>MicroATX form factor: 8.9 in x 6.8 in (22.6 cm x 17.3 cm)</p>

\* Specifications are subject to change without notice.



# Chapter 1

## Product introduction

### 1.1 Welcome!

Thank you for buying an ASUS® P8H61-M LX3 R2.0 Series motherboard!

The motherboard delivers a host of new features and latest technologies, making it another standout in the long line of ASUS quality motherboards!

Before you start installing the motherboard, and hardware devices on it, check the items in your package with the list below.

### 1.2 Package contents

Check your motherboard package for the following items.

<b>Motherboard</b>	ASUS P8H61-M LX3 R2.0 Series motherboard
<b>Cables</b>	2 x Serial ATA 3.0Gb/s cables
<b>Accessories</b>	1 x I/O shield
<b>Application DVD</b>	ASUS motherboard support DVD
<b>Documentation</b>	User Manual



- P8H61-M LX3 R2.0 Series motherboards include P8H61-M LX3 R2.0 and P8H61-M LX3 PLUS R2.0 two models. The package contents may vary from models.
- If any of the items is damaged or missing, contact your retailer.

### 1.3 Special features

#### 1.3.1 Product highlights



#### LGA1155 socket for Intel® 3rd/2nd Generation Core™ i7 / Core™ i5 / Core™ i3 / Pentium® / Celeron® Processors

This motherboard supports the Intel® 3rd/2nd generation Core™ i7/i5/i3/Pentium®/Celeron® processors in the LGA1155 package, with iGPU, memory, and PCI Express controllers integrated to support onboard graphics out with dedicated chipsets, 2-channel (2 DIMMs) DDR3 memory, and 16 PCI Express 3.0/2.0 lanes. This provides great graphics performance. Intel® 3rd/2nd generation Core™ i7/i5/i3/Pentium®/Celeron® processors are among the most powerful and energy efficient CPUs in the world.



### Intel® H61 Express Chipset

The Intel® H61 Express Chipset is the latest single-chipset design to support the new 1155 socket Intel® 3rd/2nd Generation Core™ i7 / Core™ i5 / Core™ i3 / Pentium® / Celeron® processors. It provides improved performance by utilizing serial point-to-point links, which allows increased bandwidth and stability.



### Dual-Channel DDR3 2200 (O.C.) / 2133 (O.C.) / 2000 (O.C.) / 1866 (O.C.) / 1600 / 1333 / 1066 MHz support

The motherboard supports DDR3 memory that features data transfer rates of 2200 (O.C.) / 2133 (O.C.) / 2000 (O.C.) / 1866 (O.C.) / 1600 / 1333 / 1066 MHz to meet the higher bandwidth requirements of the latest 3D graphics, multimedia, and Internet applications. The dual-channel DDR3 architecture enlarges the bandwidth of your system memory to boost system performance.



### PCI Express® 3.0

PCI Express® 3.0 (PCIe 3.0) is the latest PCI Express bus standard with improved encoding schemes that provide twice the performance of the current PCIe 2.0. The total bandwidth for a x16 link reaches a maximum of 32Gb/s, double the 16 Gb/s of PCIe 2.0 (in x16 mode). As such, PCIe 3.0 provides users an unprecedented data speeds, combined with the convenience and seamless transition offered by complete backward compatibility with PCIe 1.0 and PCIe 2.0 devices. PCIe 3.0 will become a must-have feature for users who wish to improve and optimize graphic performance, as well as have the latest technology available to them.

\* PCI 3.0 speed is supported by Intel® 3rd generation Core™ processors.



### 8-channel high definition audio

The onboard 8-channel HD audio (High Definition Audio, previously codenamed Azalia) CODEC enables high-quality 192KHz/24-bit audio output and jack-detect feature that automatically detects and identifies what types of peripherals are plugged into the audio I/O jacks and notifies users of inappropriate connection, which means there will be no more confusion of Line-in, Line-out, and Mic jacks.



### Gigabit LAN solution

The onboard LAN controller is a highly integrated Gb LAN controller. It is enhanced with an ACPI management function to provide efficient power management for advanced operating systems.



### 100% All High-quality Conductive Polymer Capacitors (P8H61-M LX3 PLUS R2.0 only)

This motherboard uses all high-quality conductive polymer capacitors for durability, improved lifespan, and enhanced thermal capacity.

## 1.3.2 Innovative ASUS features



### ASUS UEFI BIOS

#### Flexible and Easy BIOS Interface

ASUS UEFI BIOS offers the first mouse-controlled graphical BIOS designed with selectable modes, providing a user-friendly interface that goes beyond the traditional keyboard-only controls. It also natively supports fully-utilized hard drives larger than 2.2TB in 64-bit operating systems.

#### ASUS exclusive interface

EZ Mode displays frequently-accessed info. Users can choose system performance settings, and drag and drop boot priorities. Advanced Mode for performance enthusiasts includes detailed DRAM settings via a dedicated memory info page for complete insight.

#### New upgrade! Quick and easy information for enhanced system control

- F12 BIOS snapshot hotkey for sharing UEFI information and troubleshooting
- New F3 Shortcut for most accessed information
- ASUS DRAM SPD (Serial Presence Detect) information for accessing memory information, detecting faulty DIMMs, and helping with difficult POST situations.



### Network iControl

With a one-click on/off button, the software currently in use is set as top priority over all other network programs, dominating the network bandwidth with ease. Moreover, you can prioritize your favorite software easily by configuring profiles through the intuitive user interface. Within the profile, programs can be pre-scheduled to run in a specific time period to avoid network clogging and long-waits on downloads. Auto PPPoE network connection gives a one-step setup and an intuitive network bandwidth control center.



---

The Network iControl feature does not support Windows® XP/Vista operating systems.

---

### Ai Charger

Ai Charger is ASUS fast-charging software that supports iPod, iPhone, and iPad.



- 
- Check your USB mobile device if it fully supports the BC 1.1 function.
  - The actual charging speed may vary with your USB device's conditions.
-



### AI Suite II

With its fast user-friendly interface, ASUS AI Suite II consolidates all the exclusive ASUS features into one simple to use software package. It allows you to supervise overclocking, energy management, fan speed control, and voltage and sensor readings. This all-in-one software offers diverse and ease to use functions, with no need to switch back and forth between different utilities.



### ASUS Anti-Surge Protection

This special design prevents expensive devices and the motherboard from damage caused by power surges from switching power supply (PSU).



### ASUS Fan Xpert

ASUS Fan Xpert intelligently allows you to adjust the CPU fan and chassis fan speeds according to different ambient temperatures caused by different climate conditions in different geographic regions and your PC's loading. The built-in variety of useful profiles offer flexible controls of fan speed to achieve a quiet and cool environment.

### ASUS MyLogo2™

This feature allows you to convert your favorite photo into a 256-color boot logo for a more colorful and vivid image on your screen.



### ASUS CrashFree BIOS 3

ASUS CrashFree BIOS 3 is an auto-recovery tool that allows you to restore a corrupted BIOS file using the bundled support DVD or USB flash disk that contains the latest BIOS file.



### ASUS EZ Flash 2

ASUS EZ Flash 2 is a utility that allows you to update the BIOS without using an OS-based utility.



### ErP ready

The motherboard is European Union's Energy-related Products (ErP) ready, and ErP requires products to meet certain energy efficiency requirements in regards to energy consumptions. This is in line with ASUS vision of creating environment-friendly and energy-efficient products through product design and innovation to reduce carbon footprint of the product and thus mitigate environmental impacts.

## 1.4 Before you proceed

Take note of the following precautions before you install motherboard components or change any motherboard settings.



- Unplug the power cord from the wall socket before touching any component.
- Before handling components, use a grounded wrist strap or touch a safely grounded object or a metal object, such as the power supply case, to avoid damaging them due to static electricity.
- Hold components by the edges to avoid touching the ICs on them.
- Whenever you uninstall any component, place it on a grounded antistatic pad or in the bag that came with the component.
- Before you install or remove any component, ensure that the ATX power supply is switched off or the power cord is detached from the power supply. Failure to do so may cause severe damage to the motherboard, peripherals, or components.

### Standby Power LED

The motherboard comes with a standby power LED that lights up to indicate that the system is ON, in sleep mode, or in soft-off mode. This is a reminder that you should shut down the system and unplug the power cable before removing or plugging in any motherboard component. The illustration below shows the location of the onboard LED.

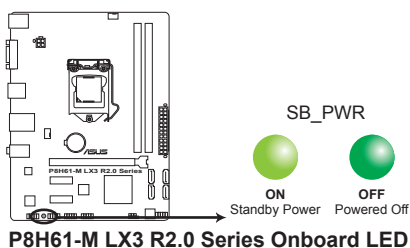

## 1.5 Motherboard overview

Before you install the motherboard, study the configuration of your chassis to ensure that the motherboard fits into it.



Ensure that you unplug the power cord before installing or removing the motherboard. Failure to do so can cause you physical injury and damage motherboard components.

### 1.5.1 Placement direction

When installing the motherboard, ensure that you place it into the chassis in the correct orientation. The edge with external ports goes to the rear part of the chassis as indicated in the image below.

### 1.5.2 Screw holes

Place six screws into the holes indicated by circles to secure the motherboard to the chassis.



Do not overtighten the screws! Doing so can damage the motherboard.

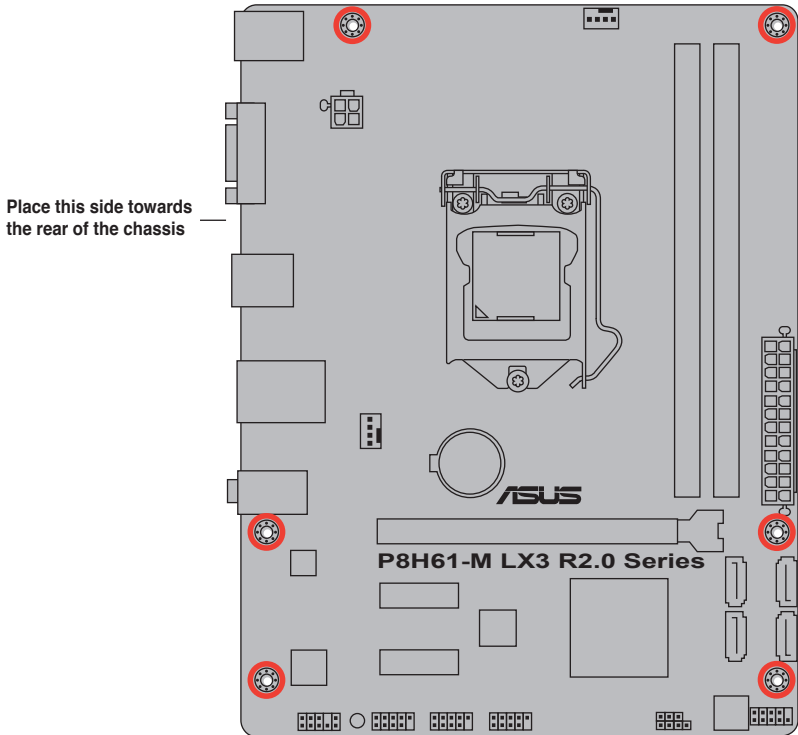



## 1.5.3 Motherboard layout

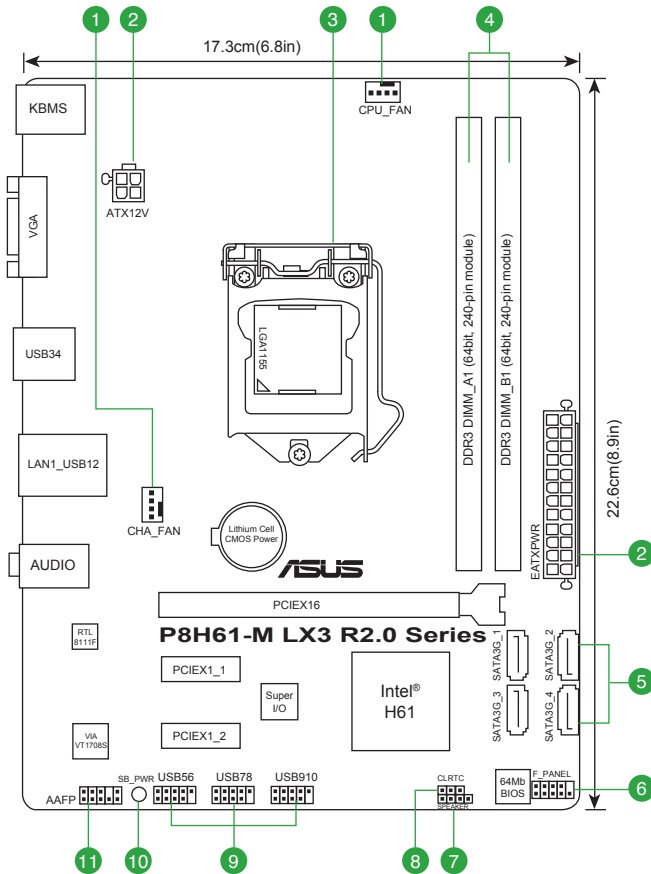

## 1.5.4 Layout contents

Connectors/Jumpers/Slots/LED	Page	Connectors/Jumpers/Slots/LED	Page
1. CPU and chassis fan connectors (4-pin CPU_FAN, 4-pin CHA_FAN)	1-25	7. Speaker connector (4-pin SPEAKER)	1-26
2. ATX power connectors (24-pin EATXPWR, 4-pin ATX12V)	1-23	8. Clear RTC RAM (3-pin CLRTC)	1-20
3. Intel® LGA1155 CPU socket	1-8	9. USB connectors (10-1 pin USB56, USB78, USB910)	1-25
4. DDR3 DIMM slots	1-13	10. Standby power LED (SB_PWR)	1-5
5. Intel® H61 Serial ATA 3.0Gb/s connectors (7-pin SATA3G_1/2/3/4)	1-24	11. Front panel audio connector (10-1 pin AAFP)	1-22
6. System panel connector (10-1 pin F_PANEL)	1-26		

## 1.6 Central Processing Unit (CPU)

The motherboard comes with a surface mount LGA1155 socket designed for the Intel® 3rd / 2nd Generation Core™ i7 / i5 / i3 / Pentium® / Celeron® processors.



Unplug all power cables before installing the CPU.



- Upon purchase of the motherboard, ensure that the PnP cap is on the socket and the socket contacts are not bent. Contact your retailer immediately if the PnP cap is missing, or if you see any damage to the PnP cap/socket contacts/motherboard components. ASUS will shoulder the cost of repair only if the damage is shipment/transit-related.
- Keep the cap after installing the motherboard. ASUS will process Return Merchandise Authorization (RMA) requests only if the motherboard comes with the cap on the LGA1155 socket.
- The product warranty does not cover damage to the socket contacts resulting from incorrect CPU installation/removal, or misplacement/loss/incorrect removal of the PnP cap.

### 1.6.1 Installing the CPU

To install a CPU:

1. Locate the CPU socket on the motherboard.

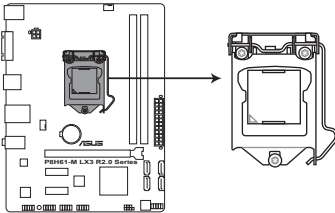

**P8H61-M LX3 R2.0 Series CPU socket LGA1155**

2. Press the load lever with your thumb (A), and then move it to the right (B) until it is released from the retention tab.



To prevent damage to the socket pins, do not remove the PnP cap unless you are installing a CPU.

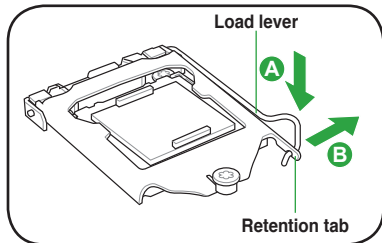

3. Lift the load lever in the direction of the arrow until the load plate is completely lifted.

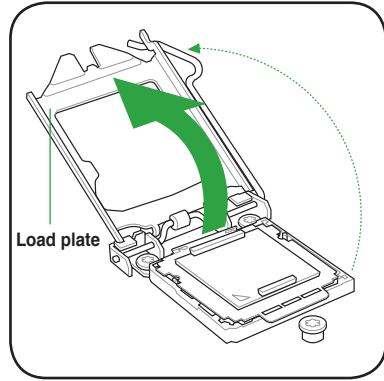

4. Remove the PnP cap from the CPU socket by lifting the tab only.

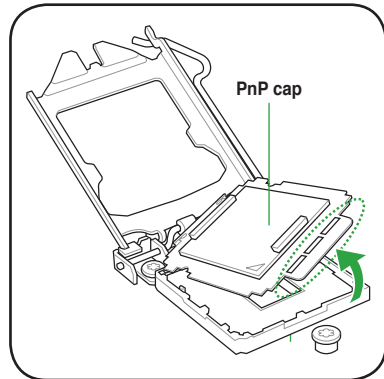

5. Position the CPU over the socket, ensuring that the gold triangle is on the bottom-left corner of the socket, and then fit the socket alignment keys into the CPU notches.



The CPU fits in only one correct orientation. DO NOT force the CPU into the socket to prevent bending the connectors on the socket and damaging the CPU!

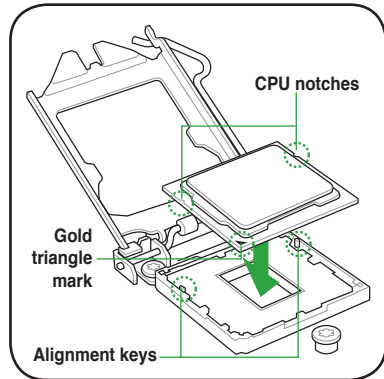

6. Apply some Thermal Interface Material to the exposed area of the CPU that the heatsink will be in contact with, ensuring that it is spread in an even thin layer.



Some heatsinks come with pre-applied thermal paste. If so, skip this step.



The Thermal Interface Material is toxic and inedible. DO NOT eat it. If it gets into your eyes or touches your skin, wash it off immediately, and seek professional medical help.

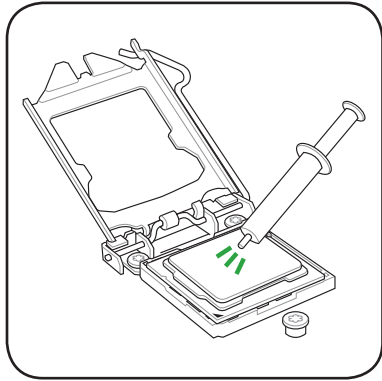

7. Close the load plate (A), and then push down the load lever (B), ensuring that the front edge of the load plate slides under the retention knob (C).

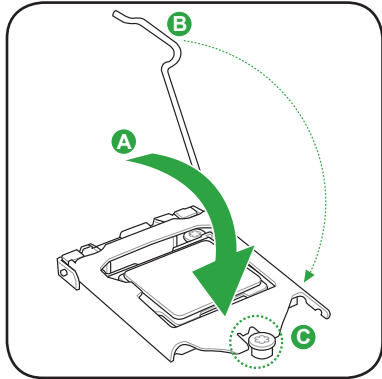

8. Insert the load lever under the retention tab.

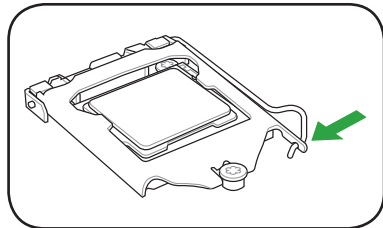

## 1.6.2 Installing the CPU heatsink and fan

The Intel® LGA1155 processor requires a specially designed heatsink and fan assembly to ensure optimum thermal condition and performance.



- When you buy a boxed Intel® processor, the package includes the CPU fan and heatsink assembly. If you buy a CPU separately, ensure that you use only Intel®-certified multi-directional heatsink and fan.
- Your Intel® LGA1155 heatsink and fan assembly comes in a push-pin design and requires no tool to install.
- Use an LGA1155-compatible CPU heatsink and fan assembly only. The LGA1155 socket is incompatible with the LGA775 and LGA1366 sockets in size and dimension.



If you purchased a separate CPU heatsink and fan assembly, ensure that you have properly applied Thermal Interface Material to the CPU heatsink or CPU before you install the heatsink and fan assembly.



Ensure that you have installed the motherboard to the chassis before you install the CPU fan and heatsink assembly.

To install the CPU heatsink and fan:

1. Place the heatsink on top of the installed CPU, ensuring that the four fasteners match the holes on the motherboard.



Orient the heatsink and fan assembly such that the CPU fan cable is closest to the CPU fan connector.

2. Push down two fasteners at a time in a diagonal sequence to secure the heatsink and fan assembly in place.

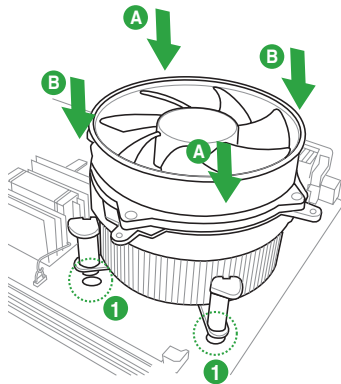
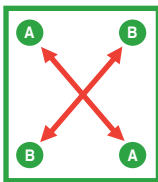

The type of CPU heatsink and fan assembly may differ, but the installation steps and functions should remain the same. The illustration above is for reference only.

3. Connect the CPU fan cable to the connector on the motherboard labeled CPU\_FAN.

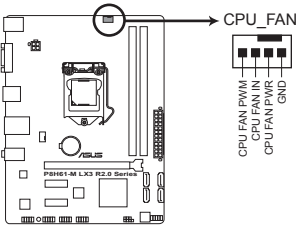

**P8H61-M LX3 R2.0 Series CPU fan connector**



Do not forget to connect the CPU fan connector! Hardware monitoring errors can occur if you fail to plug this connector.

### 1.6.3 Uninstalling the CPU heatsink and fan

To uninstall the CPU fan and fan:

1. Disconnect the CPU fan cable from the connector on the motherboard.
2. Rotate each fastener counterclockwise.
3. Pull up two fasteners at a time in a diagonal sequence to disengage the heatsink and fan assembly from the motherboard.

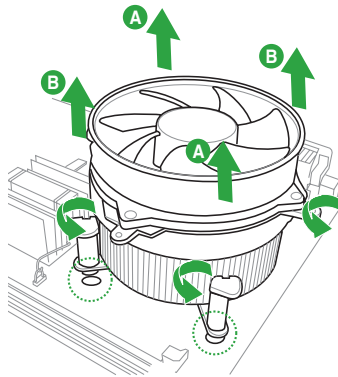
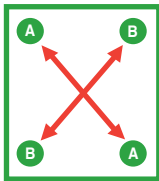

- Carefully remove the heatsink and fan assembly from the motherboard.
- Rotate each fastener clockwise to ensure correct orientation when reinstalling.

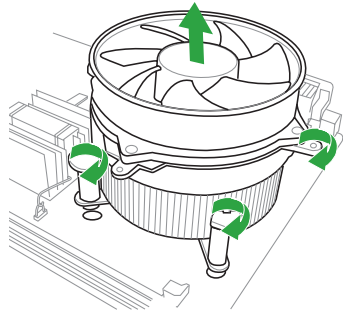

## 1.7 System memory

### 1.7.1 Overview

The motherboard comes with two Double Data Rate 3 (DDR3) Dual Inline Memory Modules (DIMM) sockets.

A DDR3 module has the same physical dimensions as a DDR2 DIMM but is notched differently to prevent installation on a DDR2 DIMM socket. DDR3 modules are developed for better performance with less power consumption.

The figure illustrates the location of the DDR3 DIMM sockets:

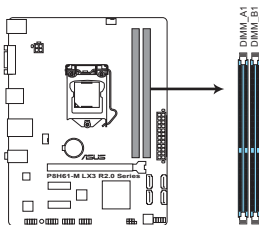

Channel	Sockets
Channel A	DIMM_A1
Channel B	DIMM_B1

**P8H61-M LX3 R2.0 Series 240-pin DDR3 DIMM sockets**

## 1.7.2 Memory configurations

You may install 1GB, 2GB, 4GB and 8GB unbuffered non-ECC DDR3 DIMMs into the DIMM sockets.



- You may install varying memory sizes in Channel A and Channel B. The system maps the total size of the lower-sized channel for the dual-channel configuration. Any excess memory from the higher-sized channel is then mapped for single-channel operation.
- Always install DIMMs with the same CAS latency. For optimum compatibility, we recommend that you obtain memory modules from the same vendor.
- Due to the memory address limitation on 32-bit Windows® OS, when you install 4GB or more memory on the motherboard, the actual usable memory for the OS can be about 3GB or less. For effective use of memory, we recommend that you do any of the following:
  - Use a maximum of 3GB system memory if you are using a 32-bit Windows® OS.
  - Install a 64-bit Windows® OS when you want to install 4GB or more on the motherboard.
- This motherboard does not support DIMMs made up of 512Mb (64MB) chips or less.



- The default memory operation frequency is dependent on its Serial Presence Detect (SPD), which is the standard way of accessing information from a memory module. Under the default state, some memory modules for overclocking may operate at a lower frequency than the vendor-marked value. To operate at the vendor-marked or at a higher frequency, refer to section 2.4 **Ai Tweaker menu** for manual memory frequency adjustment.
- For system stability, use a more efficient memory cooling system to support a full memory load (2 DIMMs) or overclocking condition.

## P8H61-M LX3 R2.0 Series Motherboard Qualified Vendors Lists (QVL)

### DDR3-2400 (O.C.) MHz capability

Vendors	Part No.	Size	SS/DS	Chip Brand	Chip NO.	Timing	Voltage	DIMM socket support (optional)	
								1DIMM	2DIMMs
CORSAIR	CMGTx8(XMP)	8GB(2GB x 4)	SS	-	-	10-12-10-27	1.65V	•	•
G.SKILL	F3-19200CL11Q-16GBZHD(XMP1.3)	16GB(4GB x 4)	DS	-	-	11-11-11-31	1.65V	•	•
G.SKILL	F3-19200CL9D-4GBPIS(XMP)	4GB(2 x 2GB)	DS	-	-	9-11-9-28	1.65V	•	•
GEIL	GET34GB2400C9DC(XMP)	2GB	DS	-	-	9-11-9-27	1.65V	•	•
KINGMAX	FLLE88F-C8KKA HAI(XMP)	2GB	SS	-	-	10-11-10-30	1.8V	•	•
Transcend	TX2400KLU-4GK(427852)(XMP)	4GB(2 x 2GB)	SS	-	-	-	1.65V	•	•
Transcend	TX2400KLU-4GK (381850)(XMP)	4GB(2 x 2GB)	SS	-	-	9	1.65V	•	•
Transcend	TX2400KLU-4GK(374243)(XMP)	4GB(2 x 2GB)	DS	-	-	9	1.65V	•	•
PATRIOT	PVV34G2400C9K(XMP)	4GB(2 x 2GB)	DS	-	-	9-11-9-27	1.65V	•	•



DDR3 1600 MHz and higher memory frequency is supported by Intel® 3rd generation processors.



## DDR3-2250 (O.C.) MHz capability

Vendors	Part No.	Size	SS/DS	Chip Brand	Chip NO.	Timing	Voltage	DIMM socket support (optional)	
								1DIMM	2DIMMs
KINGSTON	KHX2250C9D3T1K2/4GX(XMP)	4GB(2 x 2GB)	DS	-	-	-	1.65V	*	*

## DDR3-2200 (O.C.) MHz capability

Vendors	Part No.	Size	SS/DS	Chip Brand	Chip NO.	Timing	Voltage	DIMM socket support (optional)	
								1DIMM	2DIMMs
G.SKILL	F3-17600CL8D-4GBPS(XMP)	4GB(2 x 2GB)	DS	-	-	8-8-8-24	1.65V	*	*
GEIL	GET34GB2200C9DC(XMP)	2GB	DS	-	-	9-10-9-28	1.65V	*	*
GEIL	GET38GB2200C9ADC(XMP)	4GB	DS	-	-	9-11-9-28	1.65V	*	*
KINGMAX	FLKE85F-B8KJAA-FEIS(XMP)	2GB	DS	-	-	-	-	*	*
KINGMAX	FLKE85F-B8KHA EEEH(XMP)	4GB(2 x 2GB)	DS	-	-	-	1.5V-1.7V	*	*
KINGMAX	FLKE85F-B8KJA FEIH(XMP)	4GB(2 x 2GB)	DS	-	-	-	1.5V-1.7V	*	*

## DDR3-2133 (O.C.) MHz capability

Vendors	Part No.	Size	SS/DS	Chip Brand	Chip NO.	Timing	Voltage	DIMM socket support (optional)	
								1DIMM	2DIMMs
A-DATA	AX3U2133GC2G9B-DG2(XMP)	2GB	SS	-	-	9-11-9-27	1.55~1.75V	*	*
CORSAIR	CMT16GX3M4X2133C9(XMP 1.3)	16GB (4GB x4)	DS	-	-	9-11-10-27	1.50V	*	*
CORSAIR	CMT4GX3M2A2133C9(XMP)	4GB(2x 2GB)	DS	-	-	9-10-9-24	1.65V	*	*
CORSAIR	CMT4GX3M2B2133C9(XMP)	4GB(2x 2GB)	DS	-	-	9-10-9-27	1.50V	*	*
CORSAIR	CMT8GX3M2B2133C9(XMP)	8GB (4GB x 2)	DS	-	-	9-11-9-27	1.50V	*	*
G.SKILL	F3-17000CL9Q-16GBZH(XMP1.3)	16GB (4GB x4)	DS	-	-	9-11-10-28	1.65V	*	*
GEIL	GE34GB2133C9DC(XMP)	2GB	DS	-	-	9-9-9-28	1.65V	*	*
GEIL	GU34GB2133C9DC(XMP)	4GB(2 x 2GB)	DS	-	-	9-9-9-28	1.65V	*	*
KINGSTON	KHX2133C9AD3T1K2/4GX(XMP)	4GB (2x 2GB)	DS	-	-	-	1.65V	*	*
KINGSTON	KHX2133C9AD3X2K2/4GX(XMP)	4GB(2 x 2GB)	DS	-	-	9-11-9-27	1.65V	*	*
KINGSTON	KHX2133C9AD3T1K4/8GX(XMP)	8GB(4 x 2GB)	DS	-	-	9-11-9-27	1.65V	*	*
KINGSTON	KHX2133C9AD3T1FK4/8GX(XMP)	8GB(4x 2GB)	DS	-	-	-	1.65V	*	*

## DDR3-2000 (O.C.) MHz capability

Vendors	Part No.	Size	SS/DS	Chip Brand	Chip NO.	Timing	Voltage	DIMM socket support (optional)	
								1DIMM	2DIMMs
Apacer	78.AAGD5 9KD(XMP)	6GB(3 x 2GB)	DS	-	-	9-9-9-27	1.65V	*	*
CORSAIR	CMZ4GX3M2A2000C10(XMP)	4GB(2 x 2GB)	SS	-	-	10-10-10-27	1.50V	*	*
CORSAIR	CMT6GX3M3A2000C8(XMP)	6GB(3 x 2GB)	DS	-	-	8-9-8-24	1.65V	*	*
G.SKILL	F3-16000CL9D-4GBFLS(XMP)	4GB(2 x 2GB)	DS	-	-	9-9-9-24	1.65V	*	*
G.SKILL	F3-16000CL9D-4GBTD(XMP)	4GB(2 x 2GB)	DS	-	-	9-9-9-27	1.65V	*	*
G.SKILL	F3-16000CL6T-6GBPIS(XMP)	6GB (3x 2GB)	DS	-	-	6-9-6-24	1.65V	*	*
GEIL	GUP34GB2000C9DC(XMP)	4GB(2 x 2GB)	DS	-	-	9-9-9-28	1.65V	*	*
KINGSTON	KHX2000C9AD3T1K2/4GX(XMP)	4GB (2x 2GB)	DS	-	-	-	1.65V	*	*
KINGSTON	KHX2000C9AD3T1K2/4GX(XMP)	4GB (2x 2GB)	DS	-	-	-	1.65V	*	*
KINGSTON	KHX2000C9AD3T1K3/6GX(XMP)	6GB (3x 2GB)	DS	-	-	9	1.65V	*	*
KINGSTON	KHX2000C9AD3T1K3/6GX(XMP)	6GB (3x 2GB)	DS	-	-	-	1.65V	*	*
Transcend	TX2000KLN-8GK(XMP)	8GB(2 x 4GB)	DS	-	-	-	1.6V	*	*
Asint	SLA302G08-ML2HB(XMP)	4GB	DS	HYNIX	H5TQ2G83BFR H9C	-	-	*	*

## DDR3-1866 (O.C.) MHz capability

Vendors	Part No.	Size	SS/DS	Chip Brand	Chip NO.	Timing	Voltage	DIMM socket support (optional)	
								1DIMM	2DIMMs
CORSAIR	CMT4GX3M2A1866C9(XMP)	4GB(2 x 2GB)	DS	-	-	9-9-9-24	1.65V	*	*
CORSAIR	CMT6GX3MA1866C9(XMP)	6GB(3 x 2GB)	DS	-	-	9-9-9-24	1.65V	*	*
CORSAIR	CMT2GX3M2A1866C9(XMP)	8GB(2 x 4GB)	DS	-	-	9-10-9-27	1.50V	*	*
G.SKILL	F3-14900CL9Q-16GBZL(XMP1.3)	16GB(4GB x 4)	DS	-	-	9-10-9-28	1.5V	*	*
G.SKILL	F3-14900CL10Q-24GBZLD(XMP1.3)	64GB(8GB x 8)	DS	-	-	10-11-10-30	1.5V	*	*
G.SKILL	F3-14900CL9D-8GBXL(XMP)	8GB(2 x 4GB)	DS	-	-	9-10-9-28	1.5V	*	*
G.SKILL	F3-14900CL9Q-8GBXL(XMP)	8GB(2GB x 4)	DS	-	-	9-9-9-24	1.6V	*	*
KINGSTON	KHX1866C9D3T1K3/8GX(XMP)	3GB(3 x 1GB)	SS	-	-	-	1.65V	*	*
KINGSTON	KHX1866C9D3K4/16GX(XMP)	16GB(4GB x 4)	DS	-	-	-	1.65V	*	*
KINGSTON	KHX1866C9D3T1K3/8GX(XMP)	6GB(3 x 2GB)	DS	-	-	-	1.65V	*	*
KINGSTON	KHX1866C11D3P1K2/8G	8GB(4GB x 2)	DS	-	-	-	1.5V	*	*

## DDR3-1600 MHz capability

Vendors	Part No.	Size	SS/DS	Chip Brand	Chip NO.	Timing	Voltage	DIMM socket support (Optional)	
								1 DIMM	2 DIMMs
A-DATA	AM2U16BC4P2	4GB	DS	A-DATA	3CCD-1509A EL1126T	-	-	*	*
CORSAIR	CMP4GX3M2C1600C7(XMP)	4GB(2 x 2GB)	DS	-	-	7-8-7-20	1.65V	*	*
G.SKILL	F3-12800CL7D-8GBRH(XMP)	8GB(2 x 4GB)	DS	-	-	7-8-7-24	1.6V	*	*
KINGSTON	KHX1600C9AD3/2G	2GB	DS	-	-	-	1.65V	*	*

## DDR3-1333 MHz capability

Vendors	Part No.	Size	SS/DS	Chip Brand	Chip NO.	Timing	Voltage	DIMM socket support (optional)	
								1DIMM	2DIMMs
A-DATA	AM2U139C2P1	2GB	SS	ADATA	3CCD-1509A EL1127T	-	-	*	*
A-DATA	AM2U139C4P2	4GB	DS	ADATA	3CCD-1509A EL1127T	-	-	*	*
A-DATA	SU3U1333W8G9-B	8GB	DS	ELPIDA	J4208BASE-DJ-F	-	-	*	*
Apacer	AU02GFA33C9N8GC	2GB	DS	Apacer	AMS5D5808APQSBG	-	-	*	*
CORSAIR	TR3X3G1333C9 G2	3GB(3 x 1GB)	SS	-	-	9-9-9-24	1.50V	*	*
CORSAIR	TW3X4G1333C9D G	4GB(2 x 2GB)	DS	-	-	9-9-9-24	1.50V	*	*
CORSAIR	CMX4GX3M1A1333C9	4GB	DS	-	-	9-9-9-24	1.50V	*	*
Crucial	BL25664BN1337.16FF (XMP)	6GB(3 x 2GB)	DS	-	-	7-7-7-24	1.65V	*	*
ELPIDA	EBJ10UE8EDF0-DJ-F	1GB	SS	ELPIDA	J1108EDSE-DJ-F	-	1.35V(low voltage)	*	*
ELPIDA	EBJ21UE8EDF0-DJ-F	2GB	DS	ELPIDA	J1108EDSE-DJ-F	-	1.35V(low voltage)	*	*
G.SKILL	F3-10600CL8D-2GBHK(XMP)	1GB	SS	G.SKILL	-	-	-	*	*
G.SKILL	F3-10600CL9D-2GBNQ	2GB(2 x 1GB)	SS	-	-	9-9-9-24	1.5V	*	*
G.SKILL	F3-10666CL8D-4GBECO(XMP)	4GB(2 x 2GB)	DS	-	-	8-8-8-8-24	XMP 1.35V	*	*
GEIL	GG34GB1333C9DC	4GB(2 x 2GB)	DS	GEIL	GL1L128M88BA12N	9-9-9-24	1.3V(low voltage)	*	*
GEIL	GVP34GB1333C7DC	4GB(2 x 2GB)	DS	-	-	7-7-7-24	1.5V	*	*
KINGMAX	FLFD45F-B8KL9 NAES	1GB	SS	KINGMAX	KKB8FNWBFGNX-27A	-	-	*	*
KINGMAX	FLFF65F-C8KL9 NEES	4GB	DS	KINGMAX	KFC8FNLF-DXX-15A	-	-	*	*
KINGMAX	FLFF65F-C8KM9 NEES	4GB	DS	KINGMAX	KFC8FNMXF-BXX-15A	-	-	*	*
KINGSTON	KVR1333D3N9/2G	2GB	SS	Hynix	H5TQ2G83AFRH9C	9	-	*	*
KINGSTON	KHX1333C9D3UK2/4GX(XMP)	4GB(2 x 2GB)	DS	-	-	9	XMP 1.25V	*	*
KINGSTON	KVR1333D3N9/4G	4GB	DS	ELPIDA	J2108BCSE-DJ-F	-	1.5V	*	*
KINGSTON	KVR1333D3N9/4G	4GB	DS	KTC	D2568JENCNGD9U	-	1.5V	*	*
Micron	MT8JTF25664AZ-1G4M1	2GB	SS	MICRON	IJM22 D9PFJ	-	-	*	*
Micron	MT16JTF51264AZ-1G4D1	4GB	DS	Micron	OLD22D9LGK	-	-	*	*
NANYA	NT4GC64B8H0NFC-G	4GB	DS	NANYA	NT5CB256M8GN-CG	-	-	*	*
Super Talent	W1333UA1GH	1GB	SS	Hynix	H5TQ1G83TFR	9	-	*	*
Super Talent	W1333UB4GS	4GB	DS	SAMSUNG	K4B2G0846C	-	-	*	*
Super Talent	W1333UX6GM	6GB(3x 2GB)	DS	Micron	0BF27D9KPT	9-9-9-24	1.5V	*	*
Transcend	JM1333KLN-2G	2GB	SS	Micron	0YD77D9LGK	-	-	*	*
Transcend	JM1333KLU-2G	2GB	DS	Transcend	TK243PDF3	-	-	*	*

## DDR3-1066 MHz capability

Vendors	Part No.	Size	SS/DS	Chip Brand	Chip NO.	Timing	Voltage	DIMM socket support (optional)	
								1DIMM	2DIMMs
Crucial	CT12864BA1067.8FF	1GB	SS	Micron	9GF22D9KPT	7	-	•	•
ELPIDA	EBJ10UE8EDF0-AE-F	1GB	SS	ELPIDA	J1108EDSE-DJ-F	-	1.35V(low voltage)	•	•
ELPIDA	EBJ21UE8EDF0-AE-F	2GB	DS	ELPIDA	J1108EDSE-DJ-F	-	1.35V(low voltage)	•	•
KINGSTON	KVR1066D3N7/2G	2GB	DS	ELPIDA	J1108BDSE-DJ-F	7	1.5V	•	•
KINGSTON	KVR1066D3N7/4G	4GB	DS	Hynix	H5TQ2G83AFR	7	1.5V	•	•
Micron	MT16JTF25664AZ-1G1F1	2GB	DS	Micron	9HF22D9KPT	7	-	•	•



**SS: Single-sided / DS: Double-sided**

**DIMM support:**

- **1 DIMM:** Supports one module inserted into either slot as single-channel memory configuration.
- **2 DIMMs:** Supports one pair of modules inserted into both the blue slots as one pair of dual-channel memory configuration.



Visit the ASUS website at [www.asus.com](http://www.asus.com) for the latest QVL.

### 1.7.3 Installing a DIMM



Unplug the power supply before adding or removing DIMMs or other system components. Failure to do so can cause severe damage to both the motherboard and the components.

1. Press the retaining clips outward to unlock a DIMM socket.
2. Align a DIMM on the socket such that the notch on the DIMM matches the DIMM slot key on the socket.

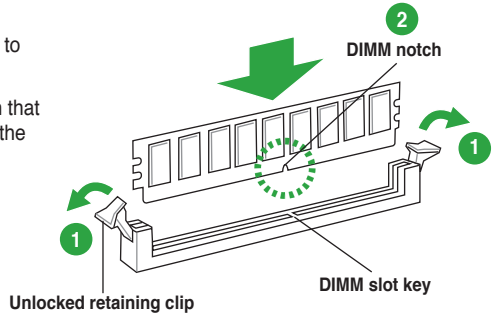

A DIMM is keyed with a notch so that it fits in only one direction. DO NOT force a DIMM into a socket in the wrong direction to avoid damaging the DIMM.

3. Firmly insert the DIMM into the socket until the retaining clips snap back in place and the DIMM is properly seated.

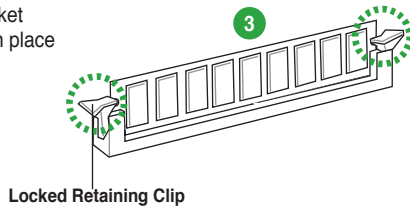

### 1.7.4 Removing a DIMM

To remove a DIMM:

1. Simultaneously press the retaining clips outward to unlock the DIMM.



Support the DIMM lightly with your fingers when pressing the retaining clips. The DIMM might get damaged when it flips out with extra force.

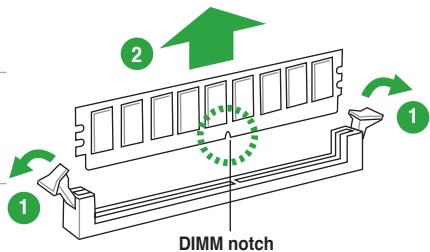

2. Remove the DIMM from the socket.

## 1.8 Expansion slots

In the future, you may need to install expansion cards. The following sub-sections describe the slots and the expansion cards that they support.



---

Unplug the power cord before adding or removing expansion cards. Failure to do so may cause you physical injury and damage motherboard components.

---

### 1.8.1 Installing an expansion card

To install an expansion card:

1. Before installing the expansion card, read the documentation that came with it and make the necessary hardware settings for the card.
2. Remove the system unit cover (if your motherboard is already installed in a chassis).
3. Remove the bracket opposite the slot that you intend to use. Keep the screw for later use.
4. Align the card connector with the slot and press firmly until the card is completely seated on the slot.
5. Secure the card to the chassis with the screw you removed earlier.
6. Replace the system cover.

### 1.8.2 Configuring an expansion card

After installing the expansion card, configure it by adjusting the software settings.

1. Turn on the system and change the necessary BIOS settings, if any. See Chapter 2 for information on BIOS setup.
2. Assign an IRQ to the card.
3. Install the software drivers for the expansion card.



---

When using PCI cards on shared slots, ensure that the drivers support “Share IRQ” or that the cards do not need IRQ assignments. Otherwise, conflicts will arise between the two PCI groups, making the system unstable and the card inoperable.

---

### 1.8.3 PCI Express x1 slot

This motherboard supports PCI Express x1 network cards, SCSI cards, and other cards that comply with the PCI Express specifications.

### 1.8.4 PCI Express 3.0/2.0 x16 slot

This motherboard has a PCI Express 3.0/2.0 x16 slot that supports PCI Express 3.0/2.0 x16 graphic cards complying with the PCI Express specifications.

# 1.9 Jumpers

## Clear RTC RAM (3-pin CLRRTC)

This jumper allows you to clear the Real Time Clock (RTC) RAM in CMOS. You can clear the CMOS memory of date, time, and system setup parameters by erasing the CMOS RTC RAM data. The onboard button cell battery powers the RAM data in CMOS, which include system setup information such as system passwords.

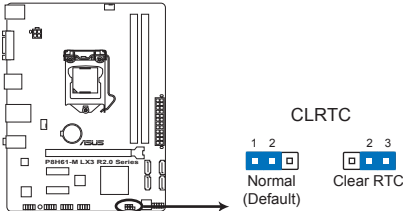

**P8H61-M LX3 R2.0 Series Clear RTC RAM**

To erase the RTC RAM:

1. Turn OFF the computer and unplug the power cord.
2. Move the jumper cap from pins 1-2 (default) to pins 2-3. Keep the cap on pins 2-3 for about 5-10 seconds, then move the cap back to pins 1-2.
3. Plug the power cord and turn ON the computer.
4. Hold down the <Del> key during the boot process and enter BIOS setup to re-enter data.



---

Except when clearing the RTC RAM, never remove the cap on CLRRTC jumper default position. Removing the cap will cause system boot failure!

---



- If the steps above do not help, remove the onboard battery and move the jumper again to clear the CMOS RTC RAM data. After clearing the CMOS, reinstall the battery.
  - You do not need to clear the RTC when the system hangs due to overclocking. For system failure due to overclocking, use the CPU Parameter Recall (C.P.R.) feature. Shut down and reboot the system, then the BIOS automatically resets parameter settings to default values.
-

## 1.10 Connectors

### 1.10.1 Rear panel connectors

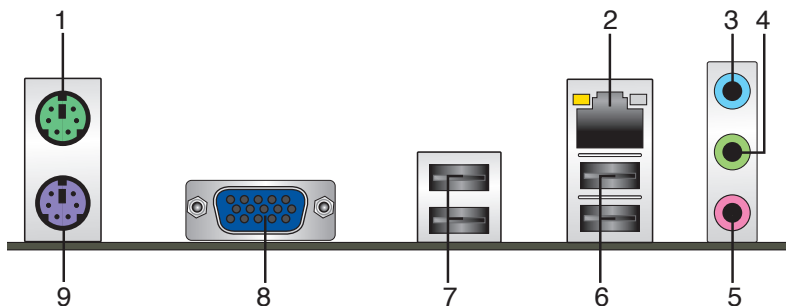

1. **PS/2 Mouse port.** This port connects to a PS/2 mouse.
2. **LAN (RJ-45) port.** This port allows Gigabit connection to a Local Area Network (LAN) through a network hub. Refer to the table below for the LAN port LED indications.

#### LAN port LED indications

Activity/Link LED		Speed LED	
Status	Description	Status	Description
OFF	No link	OFF	10Mbps connection
ORANGE	Linked	ORANGE	100Mbps connection
BLINKING	Data activity	GREEN	1Gbps connection

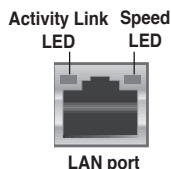

3. **Line In port (light blue).** This port connects to the tape, CD, DVD player, or other audio sources.
4. **Line Out port (lime).** This port connects to a headphone or a speaker. In the 4, 6, and 8-channel configurations, the function of this port becomes Front Speaker Out.
5. **Microphone port (pink).** This port connects to a microphone.



Refer to the audio configuration table below for the function of the audio ports in 2, 4, 6, or 8-channel configuration.

#### Audio 2, 4, 6, or 8-channel configuration

Port	Headset 2-channel	4-channel	6-channel	8-channel
Light Blue (Rear panel)	Line In	Rear Speaker Out	Rear Speaker Out	Rear Speaker Out
Lime (Rear panel)	Line Out	Front Speaker Out	Front Speaker Out	Front Speaker Out
Pink (Rear panel)	Mic In	Mic In	Bass/Center	Bass/Center
Lime (Front panel)	-	-	-	Side Speaker Out



#### To configure an 8-channel audio output:

Use a chassis with HD audio module in the front panel to support an 8-channel audio output.

6. **USB 2.0 ports 1 and 2.** These two 4-pin Universal Serial Bus (USB) ports are for USB 2.0/1.1 devices.
7. **USB 2.0 ports 3 and 4.** These two 4-pin Universal Serial Bus (USB) ports are for USB 2.0/1.1 devices.
8. **D-Sub port.** This 15-pin port connects to a VGA monitor or other VGA-compatible devices.
9. **PS/2 Keyboard port.** This port connects to a PS/2 keyboard.

## 1.10.2 Internal connectors

### 1. Front panel audio connector (10-1 pin AAFP)

This connector is for a chassis-mounted front panel audio I/O module that supports either HD Audio or legacy AC '97 audio standard. Connect one end of the front panel audio I/O module cable to this connector.

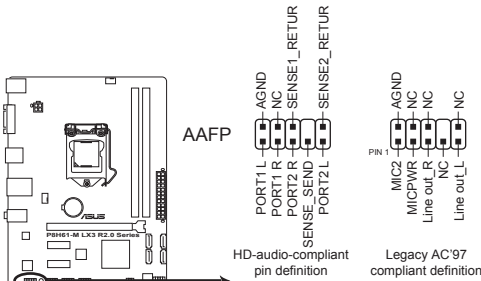

**P8H61-M LX3 R2.0 Series Front panel audio connector**



- We recommend that you connect a high-definition front panel audio module to this connector to avail of the motherboard's high-definition audio capability.
- If you want to connect a high-definition front panel audio module to this connector, set the **Front Panel Type** item in the BIOS setup to **[HD]**. If you want to connect an AC'97 front panel audio module to this connector, set the item to **[AC97]**. By default, this connector is set to **[HD]**. See section **2.5.6 Onboard Devices Configuration** for details.



## 2. ATX power connectors (24-pin EATXPWR, 4-pin ATX12V)

These connectors are for ATX power supply plugs. The power supply plugs are designed to fit these connectors in only one orientation. Find the proper orientation and push down firmly until the connectors completely fit.

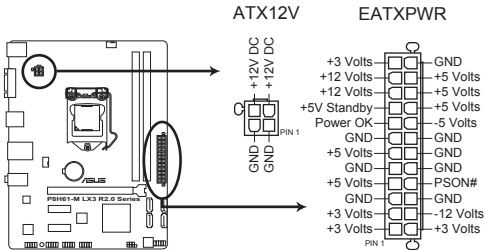

**P8H61-M LX3 R2.0 Series ATX power connectors**



- For a fully configured system, we recommend that you use a power supply unit (PSU) that complies with ATX 12 V Specification 2.0 (or later version) and provides a minimum power of 350 W.
- DO NOT forget to connect the 4-pin ATX +12V power plug. Otherwise, the system will not boot up.
- We recommend that you use a PSU with higher power output when configuring a system with more power-consuming devices. The system may become unstable or may not boot up if the power is inadequate.
- If you are uncertain about the minimum power supply requirement for your system, refer to the Recommended Power Supply Wattage Calculator at <http://support.asus.com/PowerSupplyCalculator/PSCalculator.aspx?SLanguage=en-us> for details.

### 3. Intel® H61 Serial ATA 3.0Gb/s connectors (7-pin SATA3G\_1~4)

These connectors connect to Serial ATA 3.0 Gb/s hard disk drives and optical drives via Serial ATA 3.0 Gb/s signal cables.

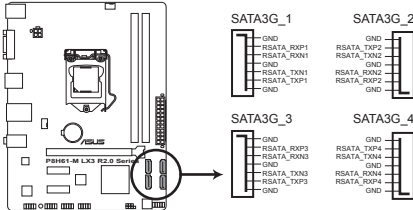

**P8H61-M LX3 R2.0 Series Intel® SATA 3.0Gb/s connectors**



- You must install Windows® XP Service Pack 3 or later version before using Serial ATA hard disk drives.
- Due to H61 Chipset limitation, AHCI Mode only works on Windows® Vista / Windows® 7. Please use IDE Mode on Windows® XP.
- [IDE] is the default SATA type. Under Windows® XP, there is no need to change the SATA type.
- To configure the SATA type in BIOS, click **Advanced Mode > Advanced tab > SATA Configuration > SATA Mode Selection**.
- When using hot-plug and NCQ on Windows® Vista / Windows® 7, set the **SATA Mode Selection** item in the BIOS to [AHCI]. See section 2.5.3 **SATA Configuration** for details.

#### 4. CPU and chassis fan connectors (4-pin CPU\_FAN, 4-pin CHA\_FAN)

Connect the fan cables to the fan connectors on the motherboard, ensuring that the black wire of each cable matches the ground pin of the connector.

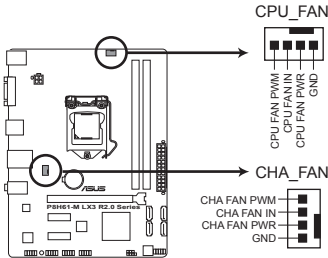

**P8H61-M LX3 R2.0 Series Fan connectors**



Do not forget to connect the fan cables to the fan connectors. Insufficient air flow inside the system may damage the motherboard components. These are not jumpers! Do not place jumper caps on the fan connectors!



- The two fan connectors support fans of maximum 2A (24 W) fan power.
- Only the 4-pin CPU fan and chassis fan support the ASUS Q-Fan 2 and Fan Xpert features.

#### 5. USB connectors (10-1 pin USB56, USB78, USB910)

These connectors are for USB 2.0 ports. Connect the USB module cable to any of these connectors, then install the module to a slot opening at the back of the system chassis. These USB connectors comply with USB 2.0 specification that supports up to 480 Mbps connection speed.

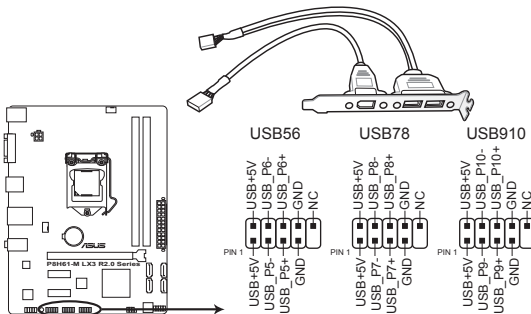

**P8H61-M LX3 R2.0 Series USB2.0 connectors**



Never connect a 1394 cable to the USB connectors. Doing so will damage the motherboard!



The USB module cable is purchased separately.

**6. System panel connector (10-1 pin F\_PANEL)**

This connector supports several chassis-mounted functions.

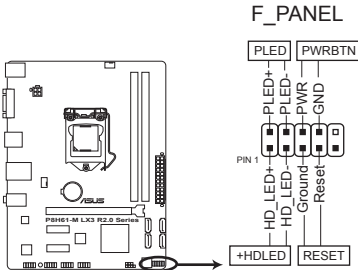

**P8H61-M LX3 R2.0 Series System panel connector**

- **System power LED (2-pin PLED)**

This 2-pin connector is for the system power LED. Connect the chassis power LED cable to this connector. The system power LED lights up when you turn on the system power, and blinks when the system is in sleep mode.

- **Hard disk drive activity LED (2-pin +HDLED)**

This 2-pin connector is for the HDD Activity LED. Connect the HDD Activity LED cable to this connector. The IDE LED lights up or flashes when data is read from or written to the HDD.

- **Power/Soft-off button (2-pin PWRBTN)**

This 2-pin connector is for the system power button.

- **Reset button (2-pin RESET)**

This 2-pin connector is for the chassis-mounted reset button for system reboot without turning off the system power.

**7. Speaker connector (4-pin SPEAKER)**

The 4-pin connector is for the chassis-mounted system warning speaker. The speaker allows you to hear system beeps and warnings.

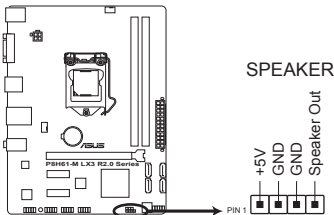

**P8H61-M LX3 R2.0 Series speaker out connector**

## 1.11 Software support

### 1.11.1 Installing an operating system

This motherboard supports Windows® XP / Vista / 7 Operating Systems (OS). Always install the latest OS version and corresponding updates to maximize the features of your hardware.



- Motherboard settings and hardware options vary. Refer to your OS documentation for detailed information.
- Ensure that you install Windows® XP Service Pack 3 or later versions / Windows® Vista Service Pack 1 or later versions before installing the drivers for better compatibility and system stability.

### 1.11.2 Support DVD information

The Support DVD that comes with the motherboard package contains the drivers, software applications, and utilities that you can install to avail all motherboard features.



The contents of the Support DVD are subject to change at any time without notice. Visit the ASUS website at [www.asus.com](http://www.asus.com) for updates.

### To run the Support DVD

Place the Support DVD into the optical drive. If Autorun is enabled in your computer, the DVD automatically displays the Specials screen. Click Drivers, Utilities, Manual, Contact, and Specials tabs to display their respective menus.



The following screen is for reference only.

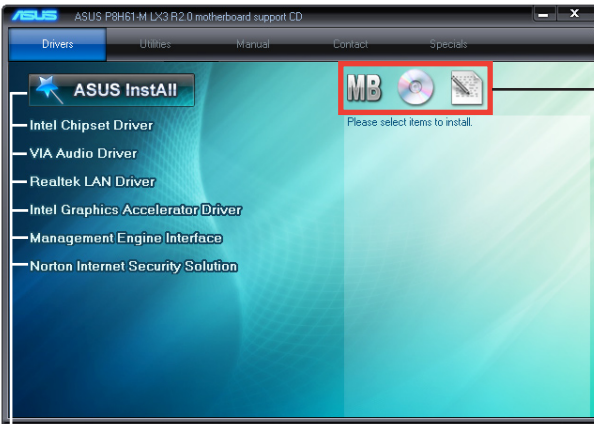

Click an icon to display Support DVD/motherboard information

Click an item to install



If Autorun is NOT enabled in your computer, browse the contents of the Support DVD to locate the file ASSETUP.EXE from the BIN folder. Double-click the ASSETUP.EXE to run the DVD.



# Chapter 2

## BIOS information

### 2.1 Managing and updating your BIOS



---

Save a copy of the original motherboard BIOS file to a USB flash disk in case you need to restore the BIOS in the future. Copy the original motherboard BIOS using the ASUS Update utility.

---

#### 2.1.1 ASUS Update utility

The ASUS Update is a utility that allows you to manage, save, and update the motherboard BIOS in Windows® environment.



- ASUS Update requires an Internet connection either through a network or an Internet Service Provider (ISP).
  - This utility is available in the support DVD that comes with the motherboard package.
- 

#### Installing ASUS Update

To install ASUS Update:

1. Place the support DVD in the optical drive. The **Specials** menu appears.
2. Click the **Utilities** tab, then click **AI Suite II**.
3. Follow the onscreen instructions to complete the installation.



---

Quit all Windows® applications before you update the BIOS using this utility.

---

#### Updating the BIOS

To update the BIOS:

1. From the Windows® desktop, click **Start > Programs > ASUS > AI Suite II > AI Suite II X.XX.XX** to launch the AI Suite II utility. The AI Suite II Quick Bar appears.
2. Click **Update** button from the Quick Bar, and then click **ASUS Update** from the popup menu. The **ASUS Update** main screen appears. From the list, select either of the following methods:

##### Updating from the Internet

- a. Select **Update BIOS from the Internet**, then click **Next**.
- b. Select the ASUS FTP site nearest you to avoid network traffic, then click **Next**.
- c. From the FTP site, select the BIOS version that you wish to download then click **Next**.



The ASUS Update utility is capable of updating itself through the Internet. Always update the utility to avail all its features.

#### *Updating from a BIOS file*

- a. Select **Update BIOS from file**, then click **Next**.
  - b. Locate the BIOS file from the **Open** window, then click **Open**.
3. Follow the onscreen instructions to complete the updating process.

## 2.1.2 ASUS EZ Flash 2

The ASUS EZ Flash 2 feature allows you to update the BIOS without using an OS-based utility.



Before you start using this utility, download the latest BIOS file from the ASUS website at [www.asus.com](http://www.asus.com).

To update the BIOS using EZ Flash 2:

1. Insert the USB flash disk that contains the latest BIOS file to the USB port.
2. Enter the **Advanced Mode** of the BIOS setup program. Go to the **Tool** menu to select **ASUS EZ Flash 2 Utility** and press <Enter> to enable it.

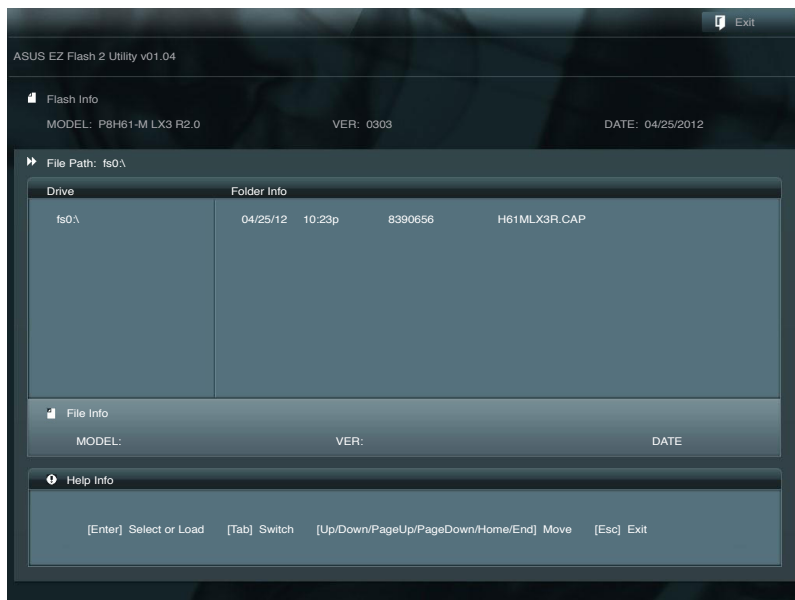



3. Press <Tab> to switch to the **Drive** field.
4. Press the Up/Down arrow keys to find the USB flash disk that contains the latest BIOS, and then press <Enter>.
5. Press <Tab> to switch to the **Folder Info** field.
6. Press the Up/Down arrow keys to find the BIOS file, and then press <Enter> to perform the BIOS update process. Reboot the system when the update process is done.



- 
- This function supports USB flash disks with **FAT 32/16** format and single partition only.
  - DO NOT shut down or reset the system while updating the BIOS to prevent system boot failure!
- 

### 2.1.3 ASUS CrashFree BIOS 3 utility

The ASUS CrashFree BIOS 3 is an auto recovery tool that allows you to restore the BIOS file when it fails or gets corrupted during the updating process. You can restore a corrupted BIOS file using the motherboard support DVD or a USB flash drive that contains the updated BIOS file.



- 
- Before using this utility, rename the BIOS file in the removable device into **H61MLX3R.CAP (P8H61-M LX3 R2.0)** or **H61ML3PR.CAP (P8H61-M LX3 PLUS R2.0)**.
  - The BIOS file in the support DVD may not be the latest version. Download the latest BIOS file from the ASUS website at [www.asus.com](http://www.asus.com).
- 

### Recovering the BIOS

To recover the BIOS:

1. Turn on the system.
2. Insert the support DVD to the optical drive or the USB flash drive that contains the BIOS file to the USB port.
3. The utility automatically checks the devices for the BIOS file. When found, the utility reads the BIOS file and enters ASUS EZ Flash 2 utility automatically.
4. The system requires you to enter BIOS Setup to recover BIOS setting. To ensure system compatibility and stability, we recommend that you press <F5> to load default BIOS values.



---

DO NOT shut down or reset the system while updating the BIOS! Doing so can cause system boot failure!

---

## 2.1.4 ASUS BIOS Updater

The ASUS BIOS Updater allows you to update BIOS in DOS environment. This utility also allows you to copy the current BIOS file that you can use as a backup when the BIOS fails or gets corrupted during the updating process.



The succeeding utility screens are for reference only. The actual utility screen displays may not be same as shown.

### Before updating BIOS

1. Prepare the motherboard support DVD and a USB flash drive in FAT32/16 format and single partition.
2. Download the latest BIOS file and BIOS Updater from the ASUS website at <http://support.asus.com> and save them on the USB flash drive.



NTFS is not supported under DOS environment. Do not save the BIOS file and BIOS Updater to a hard disk drive or USB flash drive in NTFS format.

3. Turn off the computer and disconnect all SATA hard disk drives (optional).

### Booting the system in DOS environment

1. Insert the USB flash drive with the latest BIOS file and BIOS Updater to the USB port.
2. Boot your computer. When the ASUS Logo appears, press <F8> to show the **BIOS Boot Device Select Menu**. Insert the support DVD into the optical drive and select the optical drive as the boot device.

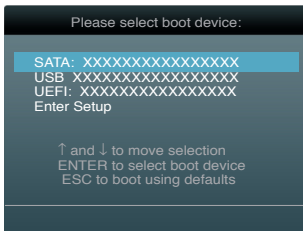

3. When the **Make Disk** menu appears, select the **FreeDOS command prompt** item by pressing the item number.
4. At the FreeDOS prompt, type **d:** and press <Enter> to switch the disk from Drive C (optical drive) to Drive D (USB flash drive).

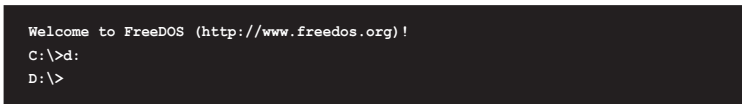

## Updating the BIOS file

To update the BIOS file using BIOS Updater

1. At the FreeDOS prompt, type `bupdater /pc /g` and press <Enter>.

```
D:\>bupdater /pc /g
```

2. The BIOS Updater screen appears as below.

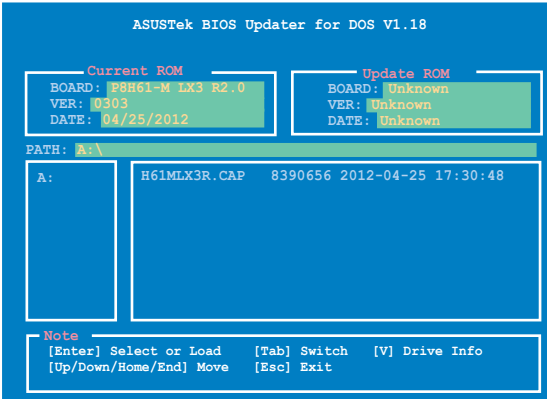

3. Press <Tab> to switch between screen fields and use the <Up/Down/Home/End> keys to select the BIOS file and press <Enter>. BIOS Updater checks the selected BIOS file and prompts you to confirm BIOS update.



4. Select Yes and press <Enter>. When BIOS update is done, press <ESC> to exit BIOS Updater. Restart your computer.



DO NOT shut down or reset the system while updating the BIOS to prevent system boot failure!



- For BIOS Updater version 1.04 or later, the utility automatically exits to the DOS prompt after updating BIOS.
- Ensure to load the BIOS default settings to ensure system compatibility and stability. Select the **Load Optimized Defaults** item under the Exit menu. Refer to section 2.9 **Exit menu** for details.
- Ensure to connect all SATA hard disk drives after updating the BIOS file if you have disconnected them.

## 2.2 BIOS setup program

Use the BIOS Setup program to update the BIOS or configure its parameters. The BIOS screens include navigation keys and brief online help to guide you in using the BIOS Setup program.

### Entering BIOS Setup at startup

To enter BIOS Setup at startup:

- Press <Delete> during the Power-On Self Test (POST). If you do not press <Delete>, POST continues with its routines.

### Entering BIOS Setup after POST

To enter BIOS Setup after POST:

- Press <Ctrl>+<Alt>+<Del> simultaneously.
- Press the reset button on the system chassis.
- Press the power button to turn the system off then back on. Do this option only if you failed to enter BIOS Setup using the first two options.



---

Using the **power button**, **reset button**, or the <Ctrl>+<Alt>+<Del> keys to force reset from a running operating system can cause damage to your data or system. We recommend to always shut down the system properly from the operating system.

---



- The BIOS setup screens shown in this section are for reference purposes only, and may not exactly match what you see on your screen.
  - Visit the ASUS website at [www.asus.com](http://www.asus.com) to download the latest BIOS file for this motherboard.
  - Ensure that a USB mouse is connected to your motherboard if you want to use the mouse to control the BIOS setup program.
  - If the system becomes unstable after changing any BIOS setting, load the default settings to ensure system compatibility and stability. Select the **Load Optimized Defaults** item under the **Exit** menu. See section **2.9 Exit Menu** for details.
  - If the system fails to boot after changing any BIOS setting, try to clear the CMOS and reset the motherboard to the default value. See section **1.9 Jumpers** for information on how to erase the RTC RAM.
- 

### BIOS menu screen

The BIOS setup program can be used under two modes: **EZ Mode** and **Advanced Mode**. You can change modes from the **Exit** menu or from the **Exit/Advanced Mode** button in the **EZ Mode/Advanced Mode** screen.

## EZ Mode

By default, the **EZ Mode** screen appears when you enter the BIOS setup program. The **EZ Mode** provides you an overview of the basic system information, and allows you to select the display language, system performance mode and boot device priority. To access the **Advanced Mode**, click **Exit/Advanced Mode** or press Esc, then select **Advanced Mode** or press F7 hot key for the advanced BIOS settings.



The default screen for entering the BIOS setup program can be changed. Refer to the **Setup Mode** item in section 2.7 **Boot menu** for details.

**Selects the display language of the BIOS setup program**

**Displays the CPU/motherboard temperature, CPU/5V/3.3V/12V voltage output, CPU/chassis fan speed**

**Exits the BIOS setup program without saving the changes, saves the changes and resets the system, or enters the Advanced Mode**

**Selects the Advanced mode functions**

**Selects the boot device priority**

**Displays the system properties of the selected mode on the right hand side**

**Displays the Advanced mode menus**

**Silent mode**

**Standard mode**

**Loads optimized default**

**Turbo mode**

**Selects the boot device priority**



- The boot device options vary depending on the devices you installed to the system.
- The **Boot Menu(F8)** button is available only when the boot device is installed to the system.

## Advanced Mode

The **Advanced Mode** provides advanced options for experienced end-users to configure the BIOS settings. The figure below shows an example of the **Advanced Mode**. Refer to the following sections for the detailed configurations.



To access the EZ Mode, click **Exit**, then select **ASUS EZ Mode**.

The screenshot shows the ASUS UEFI BIOS Utility - Advanced Mode interface. The main menu includes: Main, Ai Tweaker, Advanced, Monitor, Boot, and Tool. The current view is 'Advanced \ CPU Configuration >'. The configuration fields listed are: Processor Speed (3.60 GHz), Processor Stepping (206a6), Microcode Revision (Not loaded), L1 Data Cache (32 KB x 4), L2 Cache (52 KB x 4), L3 Cache (25.6 KB x 4), Processor Cores (6144 KB), Intel HT Technology (4), CPU Ratio Range (Not Supported), and CPU Current Ratio (Limit CPUID Maximum). The 'Limit CPUID Maximum' pop-up window is open, showing 'Disabled' and 'Enabled' options. A scroll bar is visible on the right side of the main menu. Navigation keys are listed at the bottom right: ++: Select Screen, F1: Select Item, Enter: Select, +/-: Change Opt., F1: General Help, F2: Previous Values, F3: Shortcut, F5: Optimized Defaults, F10: Save ESC: Exit, F12: Print Screen.

## Menu bar

The menu bar on top of the screen has the following main items:

<b>Main</b>	For changing the basic system configuration
<b>Ai Tweaker</b>	For changing the overclocking settings
<b>Advanced</b>	For changing the advanced system settings
<b>Monitor</b>	For displaying the system temperature, power status, and changing the fan settings
<b>Boot</b>	For changing the system boot configuration
<b>Tool</b>	For configuring options for special functions
<b>Exit</b>	For selecting the exit options and loading default settings

## **Menu items**

The highlighted item on the menu bar displays the specific items for that menu. For example, selecting **Main** shows the Main menu items.

The other items (Ai Tweaker, Advanced, Monitor, Boot, Tool, and Exit) on the menu bar have their respective menu items.

## **Back button**

This button appears when entering a submenu. Press <Esc> or use the USB mouse to click this button to return to the previous menu screen.

## **Submenu items**

A greater than sign (>) before each item on any menu screen means that the item has a submenu. To display the submenu, select the item and press <Enter>.

## **Pop-up window**

Select a menu item and press <Enter> to display a pop-up window with the configuration options for that item.

## **Scroll bar**

A scroll bar appears on the right side of a menu screen when there are items that do not fit on the screen. Press the Up/Down arrow keys or <Page Up> / <Page Down> keys to display the other items on the screen.

## **Navigation keys**

At the bottom right corner of the menu screen are the navigation keys for the BIOS setup program. Use the navigation keys to select items in the menu and change the settings.

## **General help**

At the top right corner of the menu screen is a brief description of the selected item.

## **Configuration fields**

These fields show the values for the menu items. If an item is user-configurable, you can change the value of the field opposite the item. You cannot select an item that is not user-configurable.

A configurable field is highlighted when selected. To change the value of a field, select it and press <Enter> to display a list of options.

## 2.3 Main menu

The Main menu screen appears when you enter the Advanced Mode of the BIOS Setup program. The Main menu provides you an overview of the basic system information, and allows you to set the system date, time, language, and security settings.



### 2.3.1 System Language [English]

Allows you to choose the BIOS language version from the options. Configuration options: [English] [Français] [Deutsch] [简体中文] [繁體中文] [日本語] [Español] [Русский]

### 2.3.2 System Date [Day xx/xx/xxxx]

Allows you to set the system date.

### 2.3.3 System Time [xx:xx:xx]

Allows you to set the system time.

### 2.3.4 Security

The Security menu items allow you to change the system security settings.



- If you have forgotten your BIOS password, erase the CMOS Real Time Clock (RTC) RAM to clear the BIOS password. See section 1.9 Jumpers for information on how to erase the RTC RAM.
- The **Administrator** or **User Password** items on top of the screen show the default **Not Installed**. After you set a password, these items show **Installed**.



## Administrator Password

If you have set an administrator password, we recommend that you enter the administrator password for accessing the system. Otherwise, you might be able to see or change only selected fields in the BIOS setup program.

To set an administrator password:

1. Select the **Administrator Password** item and press <Enter>.
2. From the **Create New Password** box, key in a password, then press <Enter>.
3. Confirm the password when prompted.

To change an administrator password:

1. Select the **Administrator Password** item and press <Enter>.
2. From the **Enter Current Password** box, key in the current password, then press <Enter>.
3. From the **Create New Password** box, key in a new password, then press <Enter>.
4. Confirm the password when prompted.

To clear the administrator password, follow the same steps as in changing an administrator password, but press <Enter> when prompted to create/confirm the password. After you clear the password, the **Administrator Password** item on top of the screen shows **Not Installed**.

## User Password

If you have set a user password, you must enter the user password for accessing the system. The **User Password** item on top of the screen shows the default **Not Installed**. After you set a password, this item shows **Installed**.

To set a user password:

1. Select the **User Password** item and press <Enter>.
2. From the **Create New Password** box, key in a password, then press <Enter>.
3. Confirm the password when prompted.

To change a user password:

1. Select the **User Password** item and press <Enter>.
2. From the **Enter Current Password** box, key in the current password, then press <Enter>.
3. From the **Create New Password** box, key in a new password, then press <Enter>.
4. Confirm the password when prompted.

To clear the user password, follow the same steps as in changing a user password, but press <Enter> when prompted to create/confirm the password. After you clear the password, the **User Password** item on top of the screen shows **Not Installed**.

## 2.4 Ai Tweaker menu

The Ai Tweaker menu items allow you to configure overclocking-related items.



Be cautious when changing the settings of the Ai Tweaker menu items. Incorrect field values can cause the system to malfunction.



The configuration options for this section vary depending on the CPU and DIMM model you installed on the motherboard.



### 2.4.1 Ai Overclock Tuner [Auto]

Allows you to select the CPU overclocking options to achieve the desired CPU internal frequency. Select any of these preset overclocking configuration options:

[Auto] Loads the optimal settings for the system.

[X.M.P.] If you install memory modules supporting the eXtreme Memory Profile (X.M.P.) Technology, choose this item to set the profiles supported by your memory modules for optimizing the system performance.



The Ai Overclock Tuner appears only when you install a DIMM with X.M.P. support.

### 2.4.2 ASUS MultiCore Enhancement [Enabled]

[Enabled] Select this option for maximum performance under XMP/Manual/User define memory frequency mode.

[Disabled] Select this option for default core ratio settings.

### 2.4.3 Memory Frequency [Auto]

Allows you to set the memory operating frequency. Configuration options: [DDR3-800MHz] [DDR3-1066MHz] [DDR3-1333MHz] [DDR3-1600MHz] [DDR3-1866MHz] [DDR3-2133MHz] [DDR3-2400MHz]



Selecting a very high memory frequency may cause the system to become unstable! If this happens, revert to the default setting.

## 2.4.4 GPU Boost

GPU Boost accelerates the integrated GPU for extreme graphics performance.  
Configuration options: [OK] [Cancel]

## 2.4.5 DRAM Timing Control

The sub-items in this menu allow you to set the DRAM timing control features. Use the <+> and <-> keys to adjust the value. To restore the default setting, type [auto] using the keyboard and press <Enter>.



---

Changing the values in this menu may cause the system to become unstable! If this happens, revert to the default settings.

---

## 2.4.6 CPU Power Management

The sub-items in this menu allow you to set the CPU ratio and features.

### CPU Ratio [Auto]

Allows you to manually adjust the maximum non-turbo CPU ratio. Use <+> and <-> keys or the numeric keypad to adjust the ratio. The valid value ranges vary according to your CPU model.

### Enhanced Intel SpeedStep Technology [Enabled]

Allows you to enable or disable the Enhanced Intel® SpeedStep Technology (EIST).

[Disabled] Disables this function.

[Enabled] The operating system dynamically adjusts the processor voltage and core frequency which may result in increased average consumption and decrease average heat production.

### Turbo Mode [Enabled]

[Enabled] Allows processor cores to run faster than marked frequency in specific conditions.

[Disabled] Disables this function.



---

The following three items appear only when you set the **Turbo Mode** item to [Enabled].

---

### Long Duration Power Limit [Auto]

Allows you to limit the turbo ratio's long duration power. Use the <+> and <-> keys to adjust the value.

### Long Duration Maintained [Auto]

Allows you to maintain the turbo ratio's long duration power. Use the <+> and <-> keys to adjust the value.

### Short Duration Power Limit [Auto]

Allows you to limit the turbo ratio's long duration power. Use the <+> and <-> keys to adjust the value.

### Primary Plane Current Limit [Auto]

Maximum instantaneous current allowed at any given time for CPU cores. Use <+> and <-> key to adjust the value at 0.125A increment.

### Secondary Plane Current Limit [Auto]

Maximum instantaneous current allowed at any given time for Internal Graphics cores. Use <+> and <-> key to adjust the value at 0.125A increment.

## 2.5 Advanced menu

The Advanced menu items allow you to change the settings for the CPU and other system devices.



Be cautious when changing the settings of the Advanced menu items. Incorrect field values can cause the system to malfunction.



### 2.5.1 CPU Configuration

The items in this menu show the CPU-related information that the BIOS automatically detects.



The items shown in submenu may be different due to the CPU you installed.

#### Intel Adaptive Thermal Monitor [Enabled]

[Enabled] Enables the overheated CPU to throttle its clock speed to cool down.

[Disabled] Disables the CPU thermal monitor function.

#### Active Processor Cores [All]

Allows you to choose the number of CPU cores to activate in each processor package.

Configuration options: [All] [1] [2] [3]

#### Limit CPUID Maximum [Disabled]

[Enabled] Allows legacy operating systems to boot even without support for CPUs with extended CPUID functions.

[Disabled] Disables this function.

### **Execute Disable Bit [Enabled]**

[Enabled] Enables the No-Execution Page Protection Technology.

[Disabled] Forces the XD feature flag to always return to zero (0).

### **Intel Virtualization Technology [Disabled]**

[Enabled] Allows a hardware platform to run multiple operating systems separately and simultaneously, enabling one system to virtually function as several systems.

[Disabled] Disables this function.

### **Hardware Prefetcher [Enabled]**

[Enabled] Allows a hardware platform to run multiple operating systems separately and simultaneously, enabling one system to virtually function as several systems.

[Disabled] Disables this function.

### **Adjacent Cache Line Prefetch [Enabled]**

[Enabled] Allows a hardware platform to perform adjacent cache line prefetching.

[Disabled] Disables this function.

### **CPU Power Management Configuration**

#### CPU Ratio [Auto]

Allows you to set the ratio between the CPU Core Clock and the BCLK Frequency. Use <+> and <-> keys to adjust the ratio. The valid value ranges vary according to your CPU model.

#### Enhanced Intel SpeedStep Technology [Enabled]

Allows you to enable or disable the Enhanced Intel® SpeedStep Technology (EIST).

[Disabled] The CPU runs at its default speed.

[Enabled] The operating system controls the CPU speed.

#### Turbo Mode [Enabled]

Allows you to enable or disable the Intel® Turbo Mode Technology.

[Enabled] Allows processor cores to run faster than marked frequency in specific condition.

[Disabled] Disables this function.

#### CPU C1E [Auto]

Enables or disables the C1E support function. This item should be enabled in order to enable the Enhanced Halt State. Configuration options: [Auto] [Enabled] [Disabled]

#### CPU C3 Report [Auto]

Allows you to disable or enable the CPU C3 report to OS. Configuration options: [Auto] [Enabled] [Disabled]

#### CPU C6 Report [Auto]

Allows you to disable or enable the CPU C6 report to OS. Configuration options: [Auto] [Enabled] [Disabled]

## 2.5.2 PCH Configuration

### High Precision Timer [Enabled]

Allows you to enable or disable the High Precision Event Timer.  
Configuration options: [Enabled] [Disabled]

### Intel(R) Rapid Start Technology

#### Intel(R) Rapid Start Technology [Disabled]

Allows you to enable or disable the Intel(R) Rapid Start Technology. Configuration options: [Enabled] [Disabled]



---

The following three items appear only when you set the **Intel(R) Rapid Start Technology** to [Enabled].

---

#### *Entry on S3 RTC Wake [Enabled]*

Allows you to enable or disable the iFFS invocation upon S3 RTC wake. Configuration options: [Enabled] [Disabled]

#### *Entry After [10 Minutes]*

This item appears only when you set the **Entry on S3 RTC Wake** to [Enabled] and allows you to set the RTC wake timer at S3 entry. Configuration options: [Immediately] [1 minute] [2 minutes] [5 minutes] [10 minutes] [15 minutes] [30 minutes] [1 hour] [2 hours]

#### *Active Page Threshold Support [Disabled]*

Allows you to enable or disable the Active Page Threshold Support. Configuration options: [Enabled] [Disabled]

#### *Active Memory Threshold [x]*

This item appears only when you set the **Active Page Threshold Support** to [Enabled] and allows you to set the Active Memory Threshold. When the partition size is larger than the Active Page Threshold size, the system will try to support the Intel(R) Rapid Start Technology. When the item is set to zero, the system automatically checks whether the partition size is enough at S3 entry. Key in the desired value using the numeric keypad.

### Intel(R) Smart Connect Technology

#### ISCT Configuration [Disabled]

Allows you to enable or disable the ISCT configuration. Configuration options: [Enabled] [Disabled]

## 2.5.3 SATA Configuration

While entering Setup, the BIOS automatically detects the presence of SATA devices. The SATA Port items show **Empty** if no SATA device is installed to the corresponding SATA port.

## SATA Mode Selection [IDE]

Allows you to set the SATA configuration.

[Disabled] Disables the SATA function.

[IDE] Set to [IDE] when you want to use the Serial ATA hard disk drives as Parallel ATA physical storage devices.

[AHCI] Set to [AHCI] when you want the SATA hard disk drives to use the AHCI (Advanced Host Controller Interface). The AHCI allows the onboard storage driver to enable advanced Serial ATA features that increases storage performance on random workloads by allowing the drive to internally optimize the order of commands.



- 
- Due to H61 Chipset limitation, AHCI Mode only works on Windows® Vista / Windows® 7. Please use IDE Mode on Windows® XP.
  - [IDE] is the default SATA type. Under Windows® XP, there is no need to change the SATA type.
- 

## S.M.A.R.T. Status Check [Enabled]

S.M.A.R.T. (Self-Monitoring, Analysis and Reporting Technology) is a monitor system. When read/write of your hard disk errors occur, this feature allows the hard disk to report warning messages during the POST. Configuration options: [Enabled] [Disabled]

## Hot Plug [Disabled]

This item only appears when you set the SATA Mode Selection item to [AHCI] and allows you to enable or disable the hot-plug support for each SATA port. Configuration options: [Enabled] [Disabled]

## 2.5.4 System Agent Configuration

### Memory Remap Feature [Enabled]

[Enabled] Allow you to enable remapping the memory above 4GB.

[Disabled] Disables this function.

### Graphics Configuration

#### *Primary Display [Auto]*

Allows you to decide which graphics controller to use as the primary boot device. Configuration options: [Auto] [iGPU] [PCI-E]

#### *iGPU Memory [Auto]*

Allows you to set the iGPU memory size. Configuration options: [Auto] [32M] [64M] [96M] [128M] ~ [448M] [480M] [512M] [1024M]

#### *Render Standby [Enabled]*

Allows you to enable or disable Render Standby by internal graphics devices. Configuration options: [Disabled] [Enabled]

#### *iGPU Multi-Monitor [Disabled]*

Allows you to enable or disable the Lucid Virtu support for both the integrated and discrete graphics. The iGPU shared memory size will be fixed at 64MB. Configuration options: [Disabled] [Enabled]

## 2.5.5 USB Configuration

The items in this menu allow you to change the USB-related features.



---

The **USB Devices** item shows the auto-detected values. If no USB device is detected, the item shows None.

---

### Legacy USB Support [Enabled]

- [Enabled] Enables the support for USB devices on legacy operating systems (OS).
- [Disabled] The USB devices can be used only for the BIOS setup program.
- [Auto] Allows the system to detect the presence of USB devices at startup. If detected, the USB controller legacy mode is enabled. If no USB device is detected, the legacy USB support is disabled.

### EHCI Hand-off [Disabled]

- [Enabled] Enables the support for operating systems without an EHCI hand-off feature.
- [Disabled] Disables the function.

## 2.5.6 Onboard Devices Configuration

### HD Audio Controller [Enabled]

- [Enabled] Enables the High Definition Audio Controller.
- [Disabled] Disables the controller.



---

The following item appears only when you set the **HD Audio Controller** item to [Enabled].

---

### Front Panel Type [HD]

Allows you to set the front panel audio connector (AAFP) mode to legacy AC'97 or high-definition audio depending on the audio standard that the front panel audio module supports.

- [HD] Sets the front panel audio connector (AAFP) mode to high definition audio.
- [AC97] Sets the front panel audio connector (AAFP) mode to legacy AC'97

### Realtek LAN Controller [Enabled]

- [Enabled] Enables the Realtek LAN controller.
- [Disabled] Disables the controller.

### Realtek PXE OPROM [Disabled]

This item appears only when you set the **Realtek LAN Controller** item to [Enabled] and allows you to enable or disable the Rom Help of the Realtek LAN controller. Configuration options: [Enabled] [Disabled]



## 2.5.7 APM

### Restore AC Power Loss [Power Off]

- [Power On] The system goes into on state after an AC power loss.
- [Power Off] The system goes into off state after an AC power loss.
- [Last State] The system goes into either off or on state, whatever the system state was before the AC power loss.

### Power On By PS/2 Keyboard [Disabled]

- [Disabled] Disables the Power On by a PS/2 keyboard.
- [Space Bar] Sets the Space Bar on the PS/2 keyboard to turn on the system.
- [Ctrl-Esc] Sets the Ctrl+Esc key on the PS/2 keyboard to turn on the system.
- [Power Key] Sets Power key on the PS/2 keyboard to turn on the system. This feature requires an ATX power supply that provides at least 1A on the +5VSB lead.

### Power On By PS/2 Mouse [Disabled]

- [Disabled] Disables the Power On by a PS/2 mouse.
- [Enabled] Enables the Power On by a PS/2 mouse. This feature requires an ATX power supply that provides at least 1A on the +5VSB lead.

### Power On By PCIE [Disabled]

- [Disabled] Disables the PCIE devices to generate a wake event.
- [Enabled] Enables the PCIE devices to generate a wake event.

### Power On By RTC [Disabled]

- [Disabled] Disables RTC to generate a wake event.
- [Enabled] When set to [Enabled], the items **RTC Alarm Date (Days) and Hour/Minute/Second** will become user-configurable with set values.

## 2.5.8 Network Stack

### Network Stack [Disable Link]

This item allows user to disable or enable the UEFI network stack. Configuration options: [Disable Link] [Enabled]

### Ipv4 PXE Support [Enabled]

This item appears only when you set the Network Stack item to [Enabled]. When this item is disabled, the IPV4 PXE boot option will not be created. Configuration options: [Disable Link] [Enabled]

### Ipv6 PXE Support [Enabled]

This item appears only when you set the Network Stack item to [Enabled]. When this item is disabled, the IPV6 PXE boot option will not be created. Configuration options: [Disable Link] [Enabled]

## 2.6 Monitor menu

The Monitor menu displays the system temperature/power status, and allows you to change the fan settings.



Scroll down to display the following items:

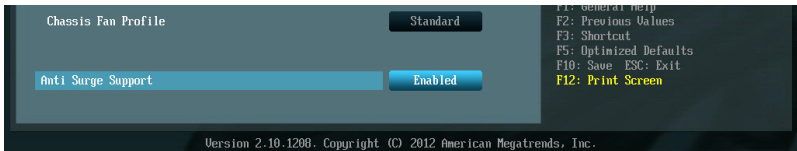

### 2.6.1 CPU Temperature / MB Temperature [xxx°C/xxx°F]

The onboard hardware monitor automatically detects and displays the CPU and motherboard temperatures. Select **Ignore** if you do not wish to display the detected temperatures.

### 2.6.2 CPU / Chassis Fan Speed [xxxx RPM] or [Ignore] / [N/A]

The onboard hardware monitor automatically detects and displays the CPU and chassis fan speeds in rotations per minute (RPM). If the fan is not connected to the motherboard, the field shows **N/A**. Select **Ignore** if you do not wish to display the detected speed.

### 2.6.3 CPU Voltage, 3.3V Voltage, 5V Voltage, 12V Voltage

The onboard hardware monitor automatically detects the voltage output through the onboard voltage regulators. Select **Ignore** if you do not want to detect this item.

## 2.6.4 CPU Q-Fan Control [Enabled]

[Disabled] Disables the CPU Q-Fan control feature.

[Enabled] Enables the CPU Q-Fan control feature.

### *CPU Fan Speed Low Limit [600 RPM]*

This item appears only when you enable the **CPU Q-Fan Control** feature and allows you to disable or set the CPU fan warning speed.

Configuration options: [Ignore] [100 RPM] [200RPM] [300 RPM] [400 RPM] [500 RPM]

### *CPU Fan Profile [Standard]*

This item appears only when you enable the **CPU Q-Fan Control** feature and allows you to set the appropriate performance level of the CPU fan.

[Standard] Sets to [Standard] to make the CPU fan automatically adjust depending on the CPU temperature.

[Silent] Sets to [Silent] to minimize the fan speed for quiet CPU fan operation.

[Turbo] Sets to [Turbo] to achieve maximum CPU fan speed.

[Manual] Sets to [Manual] to assign detailed fan speed control parameters.



---

The following four items appear only when you set **CPU Fan Profile** to [Manual].

---

### **CPU Upper Temperature [70°C]**

Use the <+> and <-> keys to adjust the upper limit of the CPU temperature. The values range from 20°C to 75°C.

### **CPU Fan Max. Duty Cycle(%) [100%]**

Use the <+> and <-> keys to adjust the maximum CPU fan duty cycle. The values range from 20% to 100%. When the CPU temperature reaches the upper limit, the CPU fan will operate at the maximum duty cycle.

### **CPU Lower Temperature [20°C]**

Use the <+> and <-> keys to adjust the lower limit of the CPU temperature. The values range from 20°C to 75°C

### **CPU Fan Min. Duty Cycle(%) [20%]**

Use the <+> and <-> keys to adjust the minimum CPU fan duty cycle. The values range from 0% to 100%. When the CPU / Chassis temperature is under the lower limit, the CPU fan will operate at the minimum duty cycle.

## 2.6.5 Chassis Q-Fan Control [Enabled]

[Disabled] Disables the Chassis Q-Fan control feature.

[Enabled] Enables the Chassis Q-Fan control feature.

### *Chassis Fan Speed Low Limit [600 RPM]*

This item appears only when you enable the **Chassis Q-Fan Control** feature and allows you to disable or set the chassis fan warning speed.

Configuration options: [Ignore] [200RPM] [300 RPM] [400 RPM] [500 RPM] [600 RPM]

### Chassis Fan Profile [Standard]

This item appears only when you enable the **Chassis Q-Fan Control** feature and allows you to set the appropriate performance level of the chassis fan.

[Standard] Sets to [Standard] to make the chassis fan automatically adjust depending on the chassis temperature.

[Silent] Sets to [Silent] to minimize the fan speed for quiet chassis fan operation.

[Turbo] Sets to [Turbo] to achieve maximum chassis fan speed.

[Manual] Sets to [Manual] to assign detailed fan speed control parameters.



---

The following four items appear only when you set **Chassis Fan Profile** to [Manual].

---

#### **Chassis Upper Temperature [70°C]**

Use the <+> and <-> keys to adjust the upper limit of the CPU temperature. The values range from 40°C to 90°C.

#### **Chassis Fan Max. Duty Cycle(%) [100%]**

Use the <+> and <-> keys to adjust the maximum chassis fan duty cycle. The values range from 60% to 100%. When the chassis temperature reaches the upper limit, the chassis fan will operate at the maximum duty cycle.

#### **Chassis Lower Temperature [40°C]**

Displays the lower limit of the chassis temperature.

#### **CPU Fan Min. Duty Cycle(%) [60%]**

Use the <+> and <-> keys to adjust the minimum chassis fan duty cycle. The values range from 60% to 100%. When the chassis temperature is under 40°C, the chassis fan will operate at the minimum duty cycle.

## **2.6.6 Anti Surge Support [Enabled]**

This item allows you to enable or disable the Anti Surge function.

Configuration options: [Disabled] [Enabled]

## 2.7 Boot menu

The Boot menu items allow you to change the system boot options.



### 2.7.1 Bootup NumLock State [On]

[On] Sets the power-on state of the NumLock to [On].

[Off] Sets the power-on state of the NumLock to [Off].

### 2.7.2 Full Screen Logo [Enabled]

[Enabled] Enables the full screen logo display feature.

[Disabled] Disables the full screen logo display feature.



Set this item to [Enabled] to use the ASUS MyLogo 2™ feature.

### Post Report [5 sec]

This item appears only when the Full Screen Logo item is set to [Disabled] and allows you to set the waiting time for the system to display the post report. Configuration options: [1 sec] [2 sec] [3 sec] [4 sec] [5 sec] [6 sec] [7 sec] [8 sec] [9 sec] [10 sec] [Until Press ESC]

### 2.7.3 Wait for 'F1' If Error [Enabled]

When this item is set to [Enabled], the system waits for the F1 key to be pressed when error occurs. Configuration options: [Disabled] [Enabled]

## 2.7.4 Option ROM Messages [Force BIOS]

[Force BIOS] The third-party ROM messages will be forced to display during the boot sequence.

[Keep Current] The third-party ROM messages will be displayed only if the third-party manufacturer had set the add-on device to do so.

## 2.7.5 Setup Mode [EZ Mode]

[Advanced Mode] Sets Advanced Mode as the default screen for entering the BIOS setup program.

[EZ Mode] Sets EZ Mode as the default screen for entering the BIOS setup program.

## 2.7.6 UEFI/Legacy Boot [Enabled both UEFI and Legacy]

[Enable both UEFI and Legacy] Enables both UEFI and Legacy boot.

[Disable UEFI] Enables the Legacy boot, and disables the UEFI boot.

[Disable Legacy] Enables the UEFI boot, and disables the Legacy boot.

## 2.7.7 PCI ROM Priority [Legacy ROM]

[Legacy ROM] Launch Legacy ROM

[EFI Compatible ROM] Launch UEFI Compatible ROM

## 2.7.8 Boot Option Priorities

These items specify the boot device priority sequence from the available devices. The number of device items that appears on the screen depends on the number of devices installed in the system.



- 
- To select the boot device during system startup, press <F8> when ASUS Logo appears.
  - To access Windows OS in Safe Mode, press <F8> after POST.
- 

## 2.7.9 Boot Override

These items displays the available devices. The number of device items that appears on the screen depends on the number of devices installed in the system. Click an item to start booting from the selected device.

## 2.8 Tools menu

The Tools menu items allow you to configure options for special functions. Select an item then press <Enter> to display the submenu.

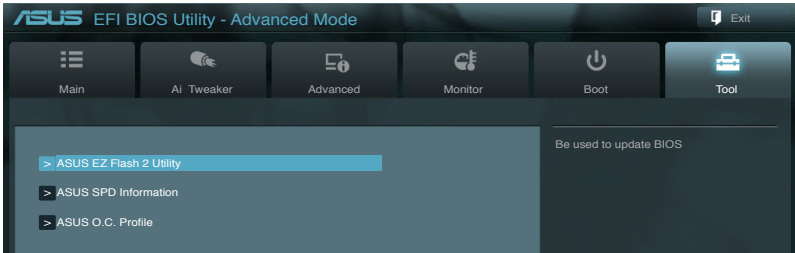

### 2.8.1 ASUS EZ Flash 2 Utility

Allows you to run ASUS EZ Flash 2. Press [Enter] to launch the ASUS EZ Flash 2 screen.



---

For more details, refer to section 2.1.2 **ASUS EZ Flash 2**.

---

### 2.8.2 ASUS SPD Information

#### DIMM Slot # [DIMM\_A1]

Displays the Serial Presence Detect (SPD) information of the DIMM module installed on the selected slot. Configuration options: [DIMM\_A1] [DIMM\_B1]

### 2.8.3 ASUS O.C. Profile

This item allows you to store or load multiple BIOS settings.



---

The **Setup Profile Status** items show **Not Installed** if no profile is created.

---

#### Label

Allows you to input the label of the setup profile.

#### Save to Profile

Allows you to save the current BIOS settings to the BIOS Flash, and create a profile. Key in a profile number from one to eight, press <Enter>, and then select **Yes**.

#### Load from Profile

Allows you to load the previous BIOS settings saved in the BIOS Flash. **Key in the profile number that saved your CMOS settings, press <Enter>, and then select Yes.**



- 
- DO NOT shut down or reset the system while updating the BIOS to prevent the system boot failure!
  - We recommend that you update the BIOS file only coming from the same memory/CPU configuration and BIOS version.
-

## 2.9 Exit menu

The Exit menu items allow you to load the optimal default values for the BIOS items, and save or discard your changes to the BIOS items. You can access the **EZ Mode** from the Exit menu.

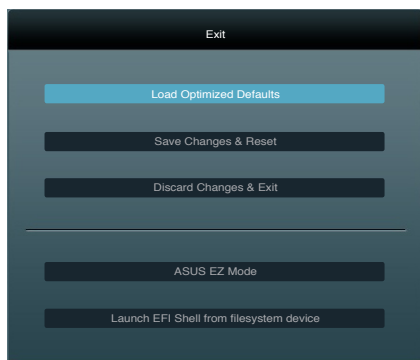

### Load Optimized Defaults

This option allows you to load the default values for each of the parameters on the Setup menus. When you select this option or if you press <F5>, a confirmation window appears. Select **Yes** to load the default values.

### Save Changes & Reset

Once you are finished making your selections, choose this option from the Exit menu to ensure the values you selected are saved. When you select this option or if you press <F10>, a confirmation window appears. Select **Yes** to save changes and exit.

### Discard Changes & Exit

This option allows you to exit the Setup program without saving your changes. When you select this option or if you press <Esc>, a confirmation window appears. Select **Yes** to discard changes and exit.

### ASUS EZ Mode

This option allows you to enter the EZ Mode screen.

### Launch EFI Shell from filesystem device

This option allows you to attempt to launch the EFI Shell application (shellx64.efi) from one of the available devices that have a filesystem.



# Appendices

## Notices

### Federal Communications Commission Statement

This device complies with Part 15 of the FCC Rules. Operation is subject to the following two conditions:

- This device may not cause harmful interference.
- This device must accept any interference received including interference that may cause undesired operation.

This equipment has been tested and found to comply with the limits for a Class B digital device, pursuant to Part 15 of the FCC Rules. These limits are designed to provide reasonable protection against harmful interference in a residential installation. This equipment generates, uses and can radiate radio frequency energy and, if not installed and used in accordance with manufacturer's instructions, may cause harmful interference to radio communications. However, there is no guarantee that interference will not occur in a particular installation. If this equipment does cause harmful interference to radio or television reception, which can be determined by turning the equipment off and on, the user is encouraged to try to correct the interference by one or more of the following measures:

- Reorient or relocate the receiving antenna.
- Increase the separation between the equipment and receiver.
- Connect the equipment to an outlet on a circuit different from that to which the receiver is connected.
- Consult the dealer or an experienced radio/TV technician for help.



The use of shielded cables for connection of the monitor to the graphics card is required to assure compliance with FCC regulations. Changes or modifications to this unit not expressly approved by the party responsible for compliance could void the user's authority to operate this equipment.

### IC: Canadian Compliance Statement

Complies with the Canadian ICES-003 Class B specifications. This device complies with RSS 210 of Industry Canada. This Class B device meets all the requirements of the Canadian interference-causing equipment regulations.

This device complies with Industry Canada license exempt RSS standard(s). Operation is subject to the following two conditions: (1) this device may not cause interference, and (2) this device must accept any interference, including interference that may cause undesired operation of the device.

Cet appareil numérique de la Classe B est conforme à la norme NMB-003 du Canada.

Cet appareil numérique de la Classe B respecte toutes les exigences du Règlement sur le matériel brouilleur du Canada.

Cet appareil est conforme aux normes CNR exemptes de licence d'Industrie Canada. Le fonctionnement est soumis aux deux conditions suivantes :

- (1) cet appareil ne doit pas provoquer d'interférences et
- (2) cet appareil doit accepter toute interférence, y compris celles susceptibles de provoquer un fonctionnement non souhaité de l'appareil.

## Canadian Department of Communications Statement

This digital apparatus does not exceed the Class B limits for radio noise emissions from digital apparatus set out in the Radio Interference Regulations of the Canadian Department of Communications.

This class B digital apparatus complies with Canadian ICES-003.

## VCCI: Japan Compliance Statement

### VCCI Class B Statement

#### 情報処理装置等電波障害自主規制について

この装置は、情報処理装置等電波障害自主規制協議会（VCCI）の基準に基づくクラスB情報技術装置です。この装置は家庭環境で使用されることを目的としていますが、この装置がラジオやテレビジョン受信機に近接して使用されると、受信障害を引き起こすことがあります。

取扱説明書に従って正しい取り扱いをして下さい。

## KC: Korea Warning Statement

B급 기기 (가정용 방송통신기자재)

이 기기는 가정용(B급) 전자파적합기기로서 주로 가정에서 사용하는 것을 목적으로 하며, 모든 지역에서 사용할 수 있습니다.

\*당해 무선설비는 전파혼신 가능성이 있으므로 인명안전과 관련된 서비스는 할 수 없습니다.

## REACH

Complying with the REACH (Registration, Evaluation, Authorisation, and Restriction of Chemicals) regulatory framework, we published the chemical substances in our products at ASUS REACH website at <http://csr.asus.com/english/REACH.htm>.



**DO NOT** throw the motherboard in municipal waste. This product has been designed to enable proper reuse of parts and recycling. This symbol of the crossed out wheeled bin indicates that the product (electrical and electronic equipment) should not be placed in municipal waste. Check local regulations for disposal of electronic products.



**DO NOT** throw the mercury-containing button cell battery in municipal waste. This symbol of the crossed out wheeled bin indicates that the battery should not be placed in municipal waste.

## ASUS Recycling/Takeback Services

ASUS recycling and takeback programs come from our commitment to the highest standards for protecting our environment. We believe in providing solutions for you to be able to responsibly recycle our products, batteries, other components as well as the packaging materials. Please go to <http://csr.asus.com/english/Takeback.htm> for the detailed recycling information in different regions.

## ASUS contact information

### ASUSTeK COMPUTER INC.

Address	15 Li-Te Road, Peitou, Taipei, Taiwan 11259
Telephone	+886-2-2894-3447
Fax	+886-2-2890-7798
E-mail	info@asus.com.tw
Web site	www.asus.com.tw

#### *Technical Support*

Telephone	+86-21-38429911
Online support	support.asus.com

### ASUS COMPUTER INTERNATIONAL (America)

Address	800 Corporate Way, Fremont, CA 94539, USA
Telephone	+1-510-739-3777
Fax	+1-510-608-4555
Web site	usa.asus.com

#### *Technical Support*

Telephone	+1-812-282-2787
Support fax	+1-812-284-0883
Online support	support.asus.com

### ASUS COMPUTER GmbH (Germany and Austria)

Address	Harkort Str. 21-23, D-40880 Ratingen, Germany
Fax	+49-2102-959911
Web site	www.asus.de
Online contact	www.asus.de/sales

#### *Technical Support*

Telephone	+49-1805-010923*
Support Fax	+49-2102-9599-11
Online support	support.asus.com

\* EUR 0.14/minute from a German fixed landline; EUR 0.42/minute from a mobile phone.

