

**P8H77-M PRO**

**ASUS**<sup>®</sup>

**Motherboard**

**Copyright © 2012 ASUSTeK COMPUTER INC. All Rights Reserved.**

No part of this manual, including the products and software described in it, may be reproduced, transmitted, transcribed, stored in a retrieval system, or translated into any language in any form or by any means, except documentation kept by the purchaser for backup purposes, without the express written permission of ASUSTeK COMPUTER INC. ("ASUS").

Product warranty or service will not be extended if: (1) the product is repaired, modified or altered, unless such repair, modification or alteration is authorized in writing by ASUS; or (2) the serial number of the product is defaced or missing.

ASUS PROVIDES THIS MANUAL "AS IS" WITHOUT WARRANTY OF ANY KIND, EITHER EXPRESS OR IMPLIED, INCLUDING BUT NOT LIMITED TO THE IMPLIED WARRANTIES OR CONDITIONS OF MERCHANTABILITY OR FITNESS FOR A PARTICULAR PURPOSE. IN NO EVENT SHALL ASUS, ITS DIRECTORS, OFFICERS, EMPLOYEES OR AGENTS BE LIABLE FOR ANY INDIRECT, SPECIAL, INCIDENTAL, OR CONSEQUENTIAL DAMAGES (INCLUDING DAMAGES FOR LOSS OF PROFITS, LOSS OF BUSINESS, LOSS OF USE OR DATA, INTERRUPTION OF BUSINESS AND THE LIKE), EVEN IF ASUS HAS BEEN ADVISED OF THE POSSIBILITY OF SUCH DAMAGES ARISING FROM ANY DEFECT OR ERROR IN THIS MANUAL OR PRODUCT.

SPECIFICATIONS AND INFORMATION CONTAINED IN THIS MANUAL ARE FURNISHED FOR INFORMATIONAL USE ONLY, AND ARE SUBJECT TO CHANGE AT ANY TIME WITHOUT NOTICE, AND SHOULD NOT BE CONSTRUED AS A COMMITMENT BY ASUS. ASUS ASSUMES NO RESPONSIBILITY OR LIABILITY FOR ANY ERRORS OR INACCURACIES THAT MAY APPEAR IN THIS MANUAL, INCLUDING THE PRODUCTS AND SOFTWARE DESCRIBED IN IT.

Products and corporate names appearing in this manual may or may not be registered trademarks or copyrights of their respective companies, and are used only for identification or explanation and to the owners' benefit, without intent to infringe.

**Offer to Provide Source Code of Certain Software**

This product contains copyrighted software that is licensed under the General Public License ("GPL"), under the Lesser General Public License Version ("LGPL") and/or other Free Open Source Software Licenses. Such software in this product is distributed without any warranty to the extent permitted by the applicable law. Copies of these licenses are included in this product.

Where the applicable license entitles you to the source code of such software and/or other additional data, you may obtain it for a period of three years after our last shipment of the product, either

(1) for free by downloading it from <http://support.asus.com/download>

or

(2) for the cost of reproduction and shipment, which is dependent on the preferred carrier and the location where you want to have it shipped to, by sending a request to:

ASUSTeK Computer Inc.  
Legal Compliance Dept.  
15 Li Te Rd.,  
Beitou, Taipei 112  
Taiwan

In your request please provide the name, model number and version, as stated in the About Box of the product for which you wish to obtain the corresponding source code and your contact details so that we can coordinate the terms and cost of shipment with you.

The source code will be distributed WITHOUT ANY WARRANTY and licensed under the same license as the corresponding binary/object code.

This offer is valid to anyone in receipt of this information.

ASUSTeK is eager to duly provide complete source code as required under various Free Open Source Software licenses. If however you encounter any problems in obtaining the full corresponding source code we would be much obliged if you give us a notification to the email address [gpl@asus.com](mailto:gpl@asus.com), stating the product and describing the problem (please DO NOT send large attachments such as source code archives, etc. to this email address).

# Contents

Contents.....	iii
Safety information.....	vi
About this guide.....	vii
P8H77-M PRO specifications summary .....	ix

## Chapter 1: Product introduction

1.1	Welcome! .....	1-1
1.2	Package contents.....	1-1
1.3	Special features.....	1-2
1.3.1	Product highlights.....	1-2
1.3.2	DIGI+ VRM Digital Power Design .....	1-3
1.3.3	ASUS Exclusive Features .....	1-4
1.3.4	ASUS Quiet Thermal Solution.....	1-5
1.3.5	ASUS EZ DIY.....	1-5
1.3.6	Other special features.....	1-6

## Chapter 2: Hardware information

2.1	Before you proceed .....	2-1
2.2	Motherboard overview.....	2-2
2.2.1	Motherboard layout .....	2-2
2.2.2	Central Processing Unit (CPU) .....	2-4
2.2.3	System memory .....	2-5
2.2.4	Expansion slots.....	2-14
2.2.5	Jumper .....	2-16
2.2.6	Onboard switches .....	2-17
2.2.7	Onboard LEDs .....	2-19
2.2.8	Internal connectors.....	2-21
2.3	Building your computer system .....	2-29
2.3.1	Additional tools and components to build a PC system .....	2-29
2.3.2	CPU installation.....	2-30
2.3.3	CPU heatsink and fan assembly installation .....	2-32
2.3.4	DIMM installation.....	2-34
2.3.5	Motherboard installation.....	2-35
2.3.6	ATX Power connection.....	2-37
2.3.7	SATA device connection.....	2-38
2.3.8	Front I/O Connector .....	2-39
2.3.9	Expansion Card installation.....	2-40
2.3.10	Rear panel connection .....	2-41
2.3.11	Audio I/O connections.....	2-43

# Contents

2.4	Starting up for the first time.....	2-45
2.5	Turning off the computer.....	2-45

## Chapter 3: BIOS setup

3.1	Knowing BIOS.....	3-1
3.2	BIOS setup program.....	3-1
	3.2.1 EZ Mode.....	3-2
	3.2.2 Advanced Mode.....	3-3
3.3	Main menu.....	3-5
3.4	Ai Tweaker menu.....	3-7
3.5	Advanced menu.....	3-13
	3.5.1 CPU Configuration.....	3-14
	3.5.2 PCH Configuration.....	3-16
	3.5.3 SATA Configuration.....	3-18
	3.5.4 System Agent Configuration.....	3-19
	3.5.5 USB Configuration.....	3-20
	3.5.6 Onboard Devices Configuration.....	3-21
	3.5.7 APM.....	3-23
	3.5.8 Network Stack.....	3-24
3.6	Monitor menu.....	3-24
3.7	Boot menu.....	3-27
3.8	Tools menu.....	3-29
	3.8.1 ASUS EZ Flash 2 Utility.....	3-29
	3.8.2 ASUS O.C. Profile.....	3-29
	3.8.3 ASUS SPD Information.....	3-30
3.9	Exit menu.....	3-31
3.10	Updating BIOS.....	3-32
	3.10.1 ASUS Update utility.....	3-32
	3.10.2 ASUS EZ Flash 2 utility.....	3-35
	3.10.3 ASUS CrashFree BIOS 3 utility.....	3-36
	3.10.4 ASUS BIOS Updater.....	3-37

## Chapter 4: Software support

4.1	Installing an operating system.....	4-1
4.2	Support DVD information.....	4-1
	4.2.1 Running the support DVD.....	4-1
	4.2.2 Obtaining the software manuals.....	4-2

# Contents

<b>4.3</b>	<b>Software information</b> .....	<b>4-3</b>
4.3.1	AI Suite II.....	4-3
4.3.2	TurboV EVO.....	4-4
4.3.3	DIGI+ VRM.....	4-6
4.3.4	EPU.....	4-8
4.3.5	FAN Xpert.....	4-9
4.3.6	Probe II.....	4-10
4.3.7	USB 3.0 Boost.....	4-11
4.3.8	MyLogo2 .....	4-12
4.3.9	Audio configurations.....	4-14
<b>4.4</b>	<b>Introduction to Intel® 2012 Desktop responsiveness technologies</b> ....	<b>4-15</b>
4.4.1	System Requirements .....	4-15
4.4.2	Intel® Smart Response Technology.....	4-17
4.4.3	Intel® Rapid Start Technology.....	4-18
4.4.4	Intel® Smart Connect Technology.....	4-24
<b>4.5</b>	<b>RAID configurations</b> .....	<b>4-27</b>
4.5.1	RAID definitions .....	4-27
4.5.2	Installing Serial ATA hard disks .....	4-28
4.5.3	Setting the RAID item in BIOS .....	4-28
4.5.4	Intel® Rapid Storage Technology Option ROM utility .....	4-28
<b>4.6</b>	<b>Creating a RAID driver disk</b> .....	<b>4-32</b>
4.6.1	Creating a RAID driver disk without entering the OS.....	4-32
4.6.2	Creating a RAID driver disk in Windows®.....	4-32
4.6.3	Installing the RAID driver during Windows® OS installation.....	4-33
4.6.4	Using a USB floppy disk drive.....	4-34
<b>Chapter 5: Multiple GPU technology support</b>		
<b>5.1</b>	<b>ATI® CrossFireX™ technology</b> .....	<b>5-1</b>
5.1.1	Requirements.....	5-1
5.1.2	Before you begin .....	5-1
5.1.3	Installing two CrossFireX™ graphics cards .....	5-2
5.1.4	Installing the device drivers.....	5-3
5.1.5	Enabling the ATI® CrossFireX™ technology .....	5-3
<b>5.2</b>	<b>LucidLogix Virtu MVP</b> .....	<b>5-4</b>
	Installing LucidLogix Virtu MVP.....	5-4
	Setting up your display.....	5-5
	Configuring LucidLogix Virtu MVP .....	5-6
<b>Appendices</b>		
	<b>Notices</b> .....	<b>A-1</b>
	<b>ASUS contact information</b> .....	<b>A-4</b>

# Safety information

## Electrical safety

- To prevent electrical shock hazard, disconnect the power cable from the electrical outlet before relocating the system.
- When adding or removing devices to or from the system, ensure that the power cables for the devices are unplugged before the signal cables are connected. If possible, disconnect all power cables from the existing system before you add a component.
- Before connecting or removing signal cables from the motherboard, ensure that all power cables are unplugged.
- Seek professional assistance before using an adapter or extension cord. These devices could interrupt the grounding circuit.
- Ensure that your power supply is set to the correct voltage in your area. If you are not sure about the voltage of the electrical outlet you are using, contact your local power company.
- If the power supply is broken, do not try to fix it by yourself. Contact a qualified service technician or your retailer.

## Operation safety

- Before installing the motherboard and adding components, carefully read all the manuals that came with the package.
- Before using the product, ensure all cables are correctly connected and the power cables are not damaged. If you detect any damage, contact your dealer immediately.
- To avoid short circuit, keep paper clips, screws, and staples away from connectors, slots, sockets and circuitry.
- Avoid dust, humidity, and temperature extremes. Do not place the product in any area where the product may be exposed to moisture.
- Place the product on a stable surface.
- If you encounter technical problems with the product, contact a qualified service technician or your retailer.

# About this guide

This user guide contains the information you need when installing and configuring the motherboard.

## How this guide is organized

This guide contains the following parts:

- **Chapter 1: Product introduction**  
This chapter describes the features of the motherboard.
- **Chapter 2: Hardware information**  
This chapter lists hardware setup procedures you have to perform when installing system components. It includes descriptions of the switches, jumpers, and connectors on the motherboard.
- **Chapter 3: BIOS setup**  
This chapter provides a detailed guide to navigating and setting up the BIOS.
- **Chapter 4: Software support**  
This chapter describes the contents of the support DVD that comes with the motherboard package and the software.
- **Chapter 5: Multiple GPU technology support**  
This chapter describes how to install and configure multiple ATI® CrossFireX™ and NVIDIA® SLI™ graphics cards.

## Where to find more information

Refer to the following sources for additional information and for product and software updates.

1. **ASUS websites**  
The ASUS website provides updated information on ASUS hardware and software products. Refer to the ASUS contact information.
2. **Optional documentation**  
Your product package may include optional documentation, such as warranty flyers, that may have been added by your dealer. These documents are not part of the standard package.

## Conventions used in this guide

To ensure that you perform certain tasks properly, take note of the following symbols used throughout this manual.



**DANGER/WARNING:** Information to prevent injury to yourself when completing a task.



**CAUTION:** Information to prevent damage to the components when completing a task.



**IMPORTANT:** Instructions you **MUST** follow to complete a task.



**NOTE:** Tips and additional information to help you complete a task.

## Typography

**Bold text**

Indicates a menu or an item to select.

*Italics*

Used to emphasize a word or a phrase.

<Key>

Keys enclosed in the less-than and greater-than sign means that you must press the enclosed key.

Example: <Enter> means that you must press the Enter or Return key.

<Key1> + <Key2> + <Key3>

If you must press two or more keys simultaneously, the key names are linked with a plus sign (+). Example: <Ctrl> + <Alt> + <Del>



## P8H77-M PRO specifications summary

<b>CPU</b>	<p>LGA1155 socket for Intel® 3<sup>rd</sup> / 2<sup>nd</sup> Core™ i7 / Core™ i5 / Core™ i3 / Pentium® / Celeron® Processors          Supports 22nm and 32nm CPU          Supports Intel® Turbo Boost Technology 2.0*</p> <p>* The Intel® Turbo Boost Technology 2.0 support depends on the CPU types.          ** Refer to <a href="http://www.asus.com">www.asus.com</a> for Intel® CPU support list.</p>
<b>Chipset</b>	Intel® H77 Express Chipset
<b>Memory</b>	<p>4 x DIMMs, max. 32GB*, DDR3 2200(O.C.)** / 2133(O.C.) / 2000(O.C.) / 1866(O.C.) / 1600 / 1333 / 1066 MHz, non-ECC, un-buffered memory          Dual-channel memory architecture          Supports Intel® Extreme Memory Profile (XMP)</p> <p>* The Max. 32GB memory capacity can be supported with DIMMs of 8GB (or above). ASUS will update QVL once the DIMMs are available on market.          ** Due to the CPU behavior, DDR3 2133/1866 MHz memory module will run at DDR3 2000/1800MHz frequency.          *** DDR3 1600 MHz and higher memory frequency is supported by Intel® 3<sup>rd</sup> generation processors.</p>
<b>Expansion slots</b>	<p>1 x PCI Express 3.0*/2.0 x16 slot [blue] (at x16 mode)          1 x PCI Express 2.0 x16 slot [black] (max. at x4 mode, compatible with PCIe x1 and x4 devices)          2 x PCI Express 2.0 x1 slots</p> <p>* PCIe 3.0 speed is supported by Intel® 3<sup>rd</sup> generation Core™ processors.</p>
<b>Graphics</b>	<p>Integrated Graphics Processor - Intel® HD Graphics support          Multi-VGA output support: DisplayPort, HDMI, DVI, RGB port</p> <ul style="list-style-type: none"> <li>- Supports DisplayPort 1.1a with max. resolution 2560x1600@60Hz</li> <li>- Supports HDMI with max. resolution 1920 x 1200@60Hz</li> <li>- Supports DVI with max. resolution 1920 x 1200@60Hz</li> <li>- Supports RGB with max. resolution 2048 x 1536@75Hz</li> <li>- Supports Intel® InTru™ 3D/Insider™/Quick Sync Video/Clear Video HD Technology/HD Graphics</li> <li>- Maximum shared memory of 1696MB</li> </ul>
<b>Multi-GPU support</b>	<p>Supports ATI® Quad-GPU CrossFireX™ Technology          Supports LucidLogix Virtu MVP Technology*</p> <p>* LucidLogix Virtu MVP Technology supports Windows® 7 Operating Systems.</p>

(continued on the next page)

# P8H77-M PRO specifications summary

<b>Storage</b>	<p><b>Intel® H77 Express Chipset:</b></p> <ul style="list-style-type: none"> <li>- 2 x Serial ATA 6Gb/s connectors (gray) with RAID 0, 1, 5, 10 support</li> <li>- 4 x Serial ATA 3Gb/s connectors (blue) with RAID 0, 1, 5, 10 support</li> <li>- Supports Intel® Smart Response Technology, Intel® Rapid Start Technology, Intel® Smart Connect Technology*</li> </ul> <p><b>Marvell® PCIe SATA 6.0 Gb/s controller**</b></p> <ul style="list-style-type: none"> <li>- 1 x eSATA port at the back I/O (6.0 Gb/s ready)</li> <li>- 1 x Serial ATA 6.0Gb/s connector (navy blue)</li> </ul> <p>* Supports on Intel® Core™ processor family with Windows® 7 Operating Systems.          ** These SATA ports are for data storage only. ATAPI devices are not supported.</p>
<b>LAN</b>	<p>Realtek® RTL8111F Gigabit LAN controller</p>
<b>Audio</b>	<p><b>Realtek ALC892 8-Channel High Definition Audio CODEC</b></p> <ul style="list-style-type: none"> <li>- Absolute Pitch 192khz/24bit true BD lossless sound</li> <li>- BD Audio Layer Content Protection</li> <li>- Supports Jack-Detection, Multi-streaming and Front Panel Jack-Retasking</li> <li>- Optical S/PDIF out port at back I/O</li> </ul>
<b>USB</b>	<p><b>Intel® H77 Express Chipset - supports ASUS USB 3.0 Boost UASP Mode*</b></p> <ul style="list-style-type: none"> <li>- 2 x USB 3.0/2.0 ports at mid-board for front panel support</li> <li>- 2 x USB 3.0/2.0 ports at back panel (blue)</li> </ul> <p><b>Intel® H77 Express Chipset</b></p> <ul style="list-style-type: none"> <li>- 10 x USB 2.0/1.1 ports (6 ports at mid-board, 4 ports at back panel)</li> </ul> <p>* The USB 3.0 ports only support Windows® 7 or later versions. UASP standard only supports Windows® 8.</p>

*(continued on the next page)*

# P8H77-M PRO specifications summary

<b>ASUS unique features</b>	<p><b>ASUS DIGI+ VRM</b></p> <ul style="list-style-type: none"><li>- Digital Power Control: Digital Power Design for the CPU and iGPU</li><li>- ASUS 4+1+1 Phase Power Design</li></ul> <p><b>ASUS EPU</b></p> <ul style="list-style-type: none"><li>- EPU, EPU switch</li></ul> <p><b>ASUS Exclusive Overclocking Features:</b></p> <ul style="list-style-type: none"><li>- ASUS Network iControl featuring instant network bandwidth domination for top network program in use</li><li>- ASUS USB 3.0 Boost featuring the latest USB 3.0 UASP standard</li><li>- ASUS Disk Unlocker featuring 3TB+ HDD support</li><li>- 100% All High-quality Conductive Polymer Capacitors</li><li>- ASUS GPU Boost</li><li>- ASUS Turbo V</li><li>- ASUS MemOK!</li><li>- ASUS AI Suite II</li><li>- ASUS Low EMI</li><li>- ASUS ESD</li></ul> <p><b>ASUS Q-Design</b></p> <ul style="list-style-type: none"><li>- ASUS Q-Shield</li><li>- ASUS Q-Slot</li><li>- ASUS Q-DIMM</li><li>- ASUS Q-Connector</li></ul> <p><b>ASUS Quiet Thermal Solution</b></p> <ul style="list-style-type: none"><li>- ASUS Fanless Design: Stylish Heatsink and MOS Heatsink Solution</li><li>- ASUS Fan Xpert</li></ul> <p><b>ASUS EZ DIY</b></p> <ul style="list-style-type: none"><li>- ASUS UEFI BIOS EZ Mode featuring friendly graphics user interface</li><li>- ASUS CrashFree BIOS 3</li><li>- ASUS EZ Flash 2</li><li>- ASUS MyLogo 2</li></ul>
<b>ASUS exclusive overclocking features</b>	<p><b>Precision Tweaker 2:</b></p> <ul style="list-style-type: none"><li>- vCore: Adjustable CPU voltage at 0.005V increment</li><li>- vCCSA: 191-step system agent voltage control</li><li>- vDRAM Bus: 191-step Memory voltage control</li><li>- vPCH: 191-step Chipset voltage control</li><li>- iGPU: 127-step iGPU voltage control</li><li>- vCPU_PLL: 1-step CPU &amp; PCH PLL voltage control</li></ul> <p><b>SFS (Stepless Frequency Selection)</b></p> <ul style="list-style-type: none"><li>- BCLK/PCIE frequency tuning from 80MHz up to 300MHz at 1MHz increment</li></ul> <p><b>Overclocking Protection:</b></p> <ul style="list-style-type: none"><li>- ASUS C.P.R.(CPU Parameter Recall)</li></ul>

(continued on the next page)

# P8H77-M PRO specifications summary

<b>Rear panel I/O ports</b>	<ul style="list-style-type: none"> <li>1 x PS/2 Keyboard/Mouse COMBO port</li> <li>1 x Optical S/PDIF out port</li> <li>1 x LAN (RJ-45) port</li> <li>1 x DisplayPort</li> <li>1 x HDMI port</li> <li>1 x DVI port</li> <li>1 x RGB port</li> <li>4 x USB 2.0/1.1 ports</li> <li>2 x USB 3.0/2.0 ports</li> <li>1 x eSATA 6.0Gb/s port</li> <li>8-channel audio ports</li> </ul>
<b>Internal I/O connectors</b>	<ul style="list-style-type: none"> <li>1 x USB 3.0/2.0 connector supports additional 2 USB 3.0/2.0 ports</li> <li>3 x USB 2.0/1.1 connectors support additional 6 USB 2.0/1.1 ports</li> <li>1 x System panel connector</li> <li>1 x S/PDIF Out connector</li> <li>1 x AAFP connector</li> <li>4 x SATA 3.0 Gb/s connectors (blue)</li> <li>3 x SATA 6.0 Gb/s connectors (2 x gray, 1 x navy blue)</li> <li>1 x Front panel audio connector</li> <li>1 x CPU fan connector (4-pin)</li> <li>2 x Chassis fan connector (4-pin)</li> <li>1 x Power fan connector (3-pin)</li> <li>1 x COM connector</li> <li>1 x LPT connector</li> <li>1 x Clear CMOS Jumper</li> <li>1 x 24-pin EATX Power connector</li> <li>1 x 8-pin EATX 12V Power connector</li> <li>1 x EPU Switch</li> <li>1 x GPU Switch</li> <li>1 x MemOK! Button</li> </ul>
<b>BIOS features</b>	<p>64 Mb Flash ROM, UEFI BIOS, PnP, DMI2.0, WfM2.0, SM BIOS 2.7, ACPI 2.0a, Multi-language BIOS, ASUS EZ Flash 2, ASUS CrashFree BIOS 3, F12 PrintScreen Function, F3 Shortcut Function and ASUS DRAM SPD (Serial Presence Detect) memory information</p>
<b>Manageability</b>	<p>WfM 2.0, DMI 2.0, WOL by PME, WOR by PME, PXE</p>

*(continued on the next page)*

## P8H77-M PRO specifications summary

<b>Accessories</b>	2 x Serial ATA 6.0Gb/s cables 2 x Serial ATA 3.0Gb/s cables 1 x User's manual 1 x ASUS Q-Shield 1 x 2-in-1 Q-connector (retail version only) 1 x Support DVD
<b>Support DVD contents</b>	Drivers ASUS Update ASUS Utilities Anti-virus software (OEM version)
<b>Form factor</b>	uATX Form Factor, 9.6"x 9.6" (24.5cm x 24.5cm)

\*Specifications are subject to change without notice.



# Chapter 1

## 1.1 Welcome!





Thank you for buying an ASUS® P8H77-M PRO motherboard!

The motherboard delivers a host of new features and supports the latest technologies, making it another standout in the long line of ASUS quality motherboards!

Before you install the motherboard, check the items in your package with the list below.

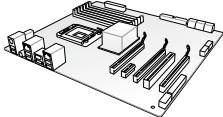
## 1.2 Package contents

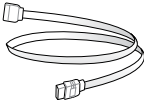
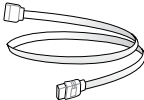
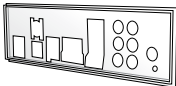
Check your motherboard package for the following items.

		
<b>ASUS P8H77-M PRO motherboard</b>	<b>User manual</b>	<b>Support DVD</b>
		
<b>2 x Serial ATA 6.0 Gb/s cables</b>	<b>2 x Serial ATA 3.0 Gb/s cables</b>	<b>1 x ASUS Q-Shield</b>
		
<b>1 x 2-in-1 ASUS Q-Connector kit</b>		



- If any of the above items is damaged or missing, contact your retailer.
- The illustrations above are for reference only. Actual product specifications may vary.

## 1.3 Special features

### 1.3.1 Product highlights

#### **LGA1155 socket for Intel® 3rd/2nd Generation Core™ i7 / Core™ i5 / Core™ i3 / Pentium® / Celeron® Processors**

This motherboard supports Intel® 3rd/2nd generation Core™ i7 / i5 / i3 / Pentium® / Celeron® processors in the LGA1155 package, with iGPU, memory and PCI Express controllers integrated to support onboard graphics output with dedicated chipsets, 2-channel (4 DIMMs) DDR3 memory and 16 PCI Express 3.0/2.0 lanes. This provides great graphics performance. Intel® 3rd / 2nd generation Core™ i7 / i5 / i3 / Pentium® / Celeron® processors are among the most powerful and energy efficient CPUs in the world.

#### **Intel® H77 Express Chipset**

The Intel® H77 Express Chipset is a single-chipset designed to support the 1155 socket Intel® 3rd / 2nd generation Core™ i7 / i5 / i3 / Pentium® / Celeron® processors. It provides improved performance by utilizing serial point-to-point links, allowing increased bandwidth and stability. Additionally, H77 chipset provides 4 USB 3.0 ports for 10 times faster data retrieval speed. Moreover, Intel® H77 Express Chipset can also enable iGPU function, letting users enjoy the latest Intel® integrated graphic performance.

#### **Dual-Channel DDR3 2200(O.C.)\* / 2133(O.C.) / 2000(O.C.) / 1866(O.C.) / 1600 / 1333 / 1066 MHz Support**

The motherboard supports DDR3 memory that features data transfer rates of DDR3 2200(O.C.)\* / 2133(O.C.) / 2000(O.C.) / 1866(O.C.) / 1600 / 1333 / 1066 MHz to meet the higher bandwidth requirements of the latest 3D graphics, multimedia, and Internet applications. The dual-channel DDR3 architecture enlarges the bandwidth of your system memory to boost system performance.

\* Due to the CPU behavior, DDR3 2133/1866MHz memory module will run at DDR3 2000/1800MHz frequency as default.

\*\*DDR3 1600 MHz and higher memory frequency is supported by Intel® 3rd generation processors.

#### **PCI Express® 3.0**

PCI Express® 3.0 (PCIe 3.0) is the latest PCI Express bus standard with improved encoding schemes that provide twice the performance of the current PCIe 2.0. The total bandwidth for a x16 link reaches a maximum of 32Gb/s, double the 16 Gb/s of PCIe 2.0 (in x16 mode). As such, PCIe 3.0 provides users unprecedented data speeds, combined with the convenience and seamless transition offered by complete backward compatibility with PCIe 1.0 and PCIe 2.0 devices. PCIe 3.0 will become a must-have feature for users who wish to improve and optimize graphic performance, as well as have the latest technology available to them.

\* PCI 3.0 speed is supported by Intel® 3rd generation Core™ processors.



## **S/PDIF out connector at the rear I/O**

This motherboard provides convenient connectivity to external home theater audio systems via the optical S/PDIF (SONY-PHILIPS Digital Interface) out connector at the rear I/O. The S/PDIF transfers digital audio without converting it to analog format, maintaining the best signal quality possible.

## **Gigabit LAN solution**

The onboard LAN controller is an integrated Gb LAN controller. It's enhanced with an ACPI management function to provide efficient power management for advanced operating systems.

## **8-channel high definition audio**

The onboard 8-channel HD audio (High Definition Audio, previously codenamed Azalia) CODEC enables high-quality 192KHz/24-bit audio output and jack-detect feature that automatically detects and identifies what types of peripherals are plugged into the audio I/O jacks. Users are notified when audio devices are plugged in to the incorrect Line-in, Line-out, and Mic port.

## **100% All High-quality Conductive Polymer Capacitors**

This motherboard uses all high-quality conductive polymer capacitors for durability, improved lifespan, and enhanced thermal capacity.

## **Complete USB 3.0 Integration**

ASUS facilitates the strategic USB 3.0 accessibility for both the front and rear panel – 4 USB 3.0 ports in total. Experience the latest plug & play connectivity at speeds up to 10 times faster than USB 2.0. The P8H77-M PRO affords greater convenience to high speed connectivity.

### **1.3.2 DIGI+ VRM Digital Power Design**

All-new digital CPU power controls work perfectly together to match digital power signal (SVID) requests from the CPU, with ultra-fast sensing and response efficiently delivering precision power. Accurate delivery reduces waste, and provides more stable CPU Vcore voltages. Users can adjust CPU PWM voltages and frequencies for various overclocking scenarios, with accurate input through UEFI BIOS tuning or the exclusive ASUS interface. This proprietary design increases overclocking headroom to push performance to its full potential.

## **ASUS EPU**

### **Energy Efficiency All Around**

Tap into the world's first real-time PC power saving chip through a simple onboard switch or AI Suite II utility. Get total system-wide energy optimization by automatically detecting current PC loadings and intelligently moderating power consumption. This also reduces fan noise and extends component longevity.

### 1.3.3 ASUS Exclusive Features

#### USB 3.0 Boost

##### Faster USB 3.0 Transmission with UASP

New ASUS USB 3.0 Boost technology supports UASP (USB Attached SCSI Protocol), the latest USB 3.0 standard. With USB 3.0 Boost technology, a USB device's transmission speed is significantly increased up to 170%, adding to an already impressive USB 3.0 transfer speed. ASUS software automatically accelerates data speeds for compatible USB 3.0 peripherals without the need for any user interaction.

#### Network iControl

##### Real-time Network Bandwidth Control

With a single-click on/off button, the application currently in use has its data and network bandwidth prioritized over other programs. Moreover, you can prioritize your favorite software easily by configuring profiles through the intuitive user interface. Within the profile, programs can be pre-scheduled to run in a specific time period to avoid network congestion and long-waits on downloads. Auto PPPoE network connection provides a one-step setup for enhanced online convenience. Overall, it's an intuitive network bandwidth control center.

#### GPU Boost

##### Go to the Limit with iGPU Level Up!

GPU Boost accelerates the integrated GPU for extreme graphics performance. The user-friendly interface facilitates flexible frequency adjustments. It easily delivers stable system-level upgrades for every use.

#### MemOK!

##### Any Memory is A-OK!

MemOK! quickly ensures memory boot compatibility. This remarkable memory rescue tool requires a mere push of a button to patch memory issues. MemOK! determines fail-safe settings and dramatically improves your system boot success. Get your system up and running in no time!

#### AI Suite II

##### One-stop Access to Innovative ASUS Features

With its user-friendly interface, ASUS AI Suite II consolidates all the exclusive ASUS features into one simple to use software package. It allows you to supervise overclocking, energy management, fan speed control, and voltage and sensor readings. This all-in-one software offers diverse and ease of use functions, without having to switch back and forth between different utilities.

#### ASUS TurboV

##### Easy, Real-Time O.C. Tunings

Feel the adrenaline rush of real-time OC-now a reality with the ASUS TurboV. This easy OC tool allows you to overclock without exiting or rebooting the OS; and its user-friendly interface makes overclocking a few clicks away. Moreover, the ASUS OC profiles in TurboV provides the best O.C. settings in different scenarios.

### 1.3.4 ASUS Quiet Thermal Solution

#### Fanless Design: stylish heatsink solution

The Wing Heatsink features a 0-dB thermal solution that offers users a noiseless PC environment. The beautifully curved fins provide a visual design flair, while also effectively cooling down hot airflows generated by the PCH chipset. Combined with usability and aesthetics, the ASUS Wing Heatsink will give users an extremely silent and cooling experience with an elegant appearance!.

#### ASUS Fan Xpert

ASUS Fan Xpert intelligently allows you to adjust the CPU and chassis fan speeds according to different ambient temperatures caused by different climate conditions in different geographic regions and your PC's loading. The built-in variety of useful profiles offer flexible controls of fan speed to achieve a quiet and cool environment.

### 1.3.5 ASUS EZ DIY

#### ASUS UEFI BIOS (EZ Mode)

##### Flexible and Easy BIOS Interface

ASUS UEFI BIOS offers the first mouse-controlled graphical BIOS designed with selectable modes, providing a user-friendly interface that goes beyond the traditional keyboard-only controls. It also fully-utilizes 2.2TB and larger hard drives with native 64-bit operating systems support.

##### ASUS exclusive interface

EZ Mode displays frequently-accessed info. Users can choose system performance settings, and drag and drop boot priorities. Advanced Mode for performance enthusiasts includes detailed DRAM settings via a dedicated memory info page for complete insight.

##### New upgrade! Quick and easy information for enhanced system control

- F12 BIOS snapshot hotkey for sharing UEFI information and troubleshooting
- New F3 Shortcut for frequently accessed information
- ASUS DRAM SPD (Serial Presence Detect) information for accessing memory information, detecting faulty DIMMs, and helping with difficult POST situations.

#### ASUS Q-Design

ASUS Q-Design enhances your DIY experience. All of Q-Slot, and Q-DIMM design speed up and simplify the DIY process!

#### ASUS Q-Shield

The specially designed ASUS Q-Shield does without the usual "fingers" - making it convenient and easy to install. With better electric conductivity, it ideally protects your motherboard against static electricity and shields it against Electronic Magnetic Interference (EMI).

## ASUS Q-Connector

The ASUS Q-Connector allows you to connect or disconnect the chassis front panel cables in one easy step with one complete module. This unique adapter eliminates the trouble of plugging in one cable at a time, making the connection quick and accurate.

## ASUS EZ-Flash 2

**Simply update the BIOS from a USB flash disk before entering the OS**

EZ Flash 2 is a user-friendly BIOS update utility. Simply launch this tool and update the BIOS from a USB flash disk before entering the OS. You can update your BIOS in a few clicks without preparing an additional floppy diskette or using an OS-based flash utility.

### 1.3.6 Other special features

#### LucidLogix® Virtu MVP™

LucidLogix® Virtu MVP featuring HyperFormance™ Technology boosts your discrete graphics card up to 60% beyond its original performance. Designed for Intel® processor graphics and Windows® 7 PCs, it perfectly combines the performance of discrete graphics cards with fast computing iGPU. Also with the newly designed Virtual Sync, users can enjoy a smoother gaming experience by eliminating tearing artifacts. LucidLogix® Virtu MVP could also dynamically assign tasks to the best available graphics resource, based on power, performance and system load. This allows users to fully utilize 3x faster video conversion with Intel® Quick Sync Video technology while retaining high-end 3D rendering and gaming performance, provided by both NVIDIA® and AMD graphic cards. When the discrete graphics card is not required, power consumption goes automatically down to near zero, making the system more environmentally-friendly. For users searching for perfection, LucidLogix Virtu MVP provides great graphical performance and the best flexibility and efficiency.

\*LucidLogix® Virtu Universal MVP™ supports Windows® 7 operating system.

\*\*Intel® Quick Sync Video feature is supported by 3<sup>rd</sup>/2<sup>nd</sup> generation Intel® Core™ processor family.

#### DisplayPort 1.1a Support

DisplayPort is a digital display interface standard that delivers up to 10.8 Gbps of bandwidth over standard cables, providing billions of colors and bi-directional communications, thus enabling the fastest refresh rates and the highest resolution digital display through a single cable. It also supports HDCP copy protection for Blu-ray Discs. Simply output 3D signals through the connected DisplayPort 1.1a cable with your 3D display, then sit back and enjoy a perfect 3D animation experience.

## HDMI Support

### Enjoy Full HD 1080p Multimedia Home-Theater Entertainment

High Definition Multimedia Surface (HDMI) is a set of digital video standards that delivers multi-channel audio and uncompressed digital video for full HD 1080p visuals through a single cable. Supporting HDCP copy protection such as HD DVD and blu-ray discs, HDMI provides you with the highest quality home theater experience.

### ErP Ready

The motherboard is European Union's Energy-related Products (ErP) ready, and ErP requires products to meet certain energy efficiency requirement in terms of energy consumption. This is in line with the ASUS vision of creating environment-friendly and energy-efficient products through product design and innovation to reduce carbon footprint and thus mitigate environmental impacts.



## 2.1 Before you proceed

Take note of the following precautions before you install motherboard components or change any motherboard settings.



- 
- Unplug the power cord from the wall socket before touching any component.
  - Before handling components, use a grounded wrist strap or touch a safely grounded object or a metal object, such as the power supply case, to avoid damaging them due to static electricity.
  - Hold components by the edges to avoid touching the ICs on them.
  - Whenever you uninstall any component, place it on a grounded antistatic pad or in the bag that came with the component.
  - Before you install or remove any component, ensure that the ATX power supply is switched off or the power cord is disconnected from the power supply. Failure to do so may cause severe damage to the motherboard, peripherals, or components.
-

## 2.2 Motherboard overview

### 2.2.1 Motherboard layout

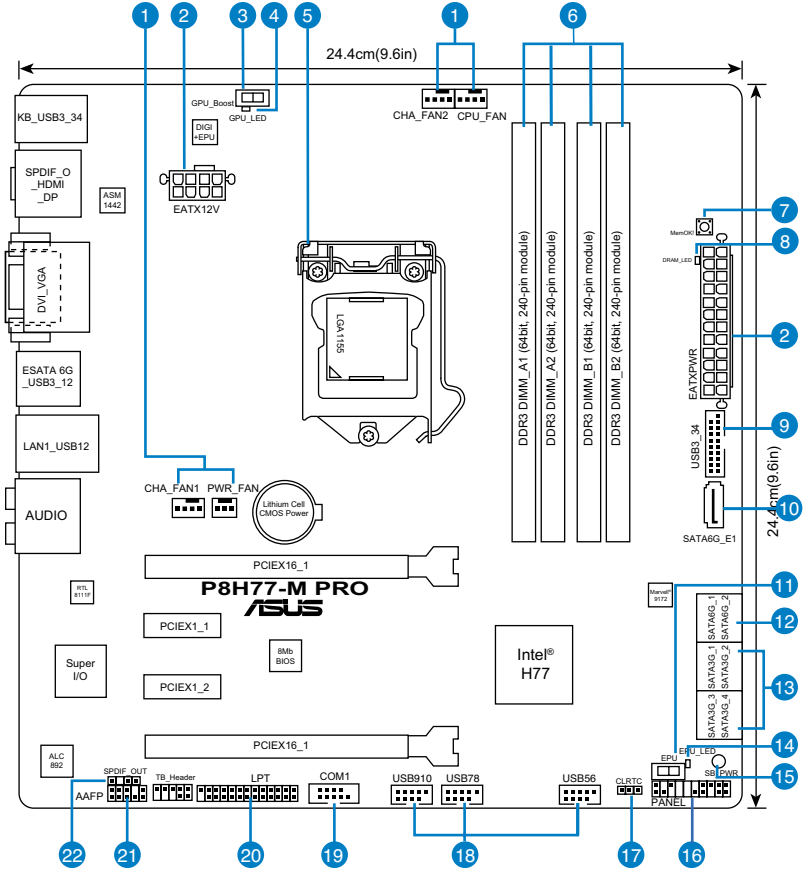

Refer to 2.2.8 Internal connectors and 2.3.10 Rear panel connection for more information about rear panel connectors and internal connectors.



## Layout contents

Connectors/Jumpers/Slots		Page
1.	CPU,Chassis, and Power fan connectors (4-pin CPU_FAN, 4-pin CHA_FAN, 3-pin PWR_FAN)	2-24
2.	EATX power connectors (24-pin EATXPWR, 8-pin EATX12V)	2-25
3.	GPU Boost switch	2-16
4.	GPU Boost LED	2-18
5.	Intel® CPU socket	2-4
6.	DDR3 DIMM sockets	2-5
7.	MemOK! switch	2-15
8.	DRAM LED	2-17
9.	USB 3.0 connector (20-1 pin USB3_34)	2-22
10.	Marvell® Serial ATA 6.0 Gb/s connectors (7-pin SATA 6G_E1 [navy blue])	2-21
11.	EPU switch	2-16
12.	Intel® H77 Serial ATA 6.0Gb/s connectors (7-pin SATA6G_1/2 [gray])	2-19
13.	Intel® H77 Serial ATA 3.0Gb/s connectors (7-pin SATA3G_1-4, [Blue])	2-20
14.	EPU LED	2-17
15.	Onboard LED (SB_PWR)	2-17
16.	System panel connector (20-8 pin F_PANEL)	2-26
17.	Clear RTC RAM (3-pin CLRTC)	2-14
18.	USB connectors (10-1 pin USB56, USB78, USB910)	2-22
19.	Serial port connectors (10-1 pin COM1)	2-25
20.	LPT connector (26-1 pin LPT )	2-24
21.	Front panel audio connector (10-1 pin AAFP)	2-23
22.	Digital audio connector (4-1 pin SPDIF_OUT)	2-23

## 2.2.2 Central Processing Unit (CPU)

The motherboard comes with a surface mount LGA1155 socket designed for the Intel® 3rd/2nd Generation Core™ i7 / i5 / i3 / Celeron® / Pentium® Processors.

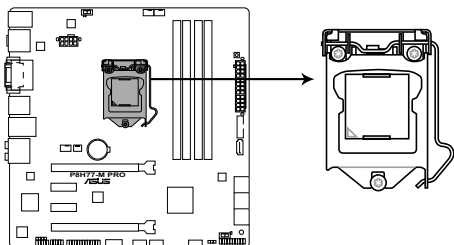

### P8H77-M PRO CPU socket LGA1155



---

Ensure that all power cables are unplugged before installing the CPU.

---



- The LGA1156 CPU is incompatible with the LGA1155 socket. DO NOT install a LGA1156 CPU on the LGA1155 socket.
  - Upon purchase of the motherboard, ensure that the PnP cap is on the socket and the socket contacts are not bent. Contact your retailer immediately if the PnP cap is missing, or if you see any damage to the PnP cap/socket contacts/motherboard components. ASUS will shoulder the cost of repair only if the damage is shipment/transit-related.
  - Keep the cap after installing the motherboard. ASUS will process Return Merchandise Authorization (RMA) requests only if the motherboard comes with the cap on the LGA1155 socket.
  - The product warranty does not cover damage to the socket contacts resulting from incorrect CPU installation/removal, or misplacement/loss/incorrect removal of the PnP cap.
-

## 2.2.3 System memory

The motherboard comes with four Double Data Rate 3 (DDR3) Dual Inline Memory Modules (DIMM) slots.



A DDR3 module is notched differently from a DDR or DDR2 module. DO NOT install a DDR or DDR2 memory module to the DDR3 slot.

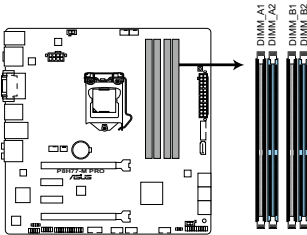

**P8H77-M PRO 240-pin DDR3 DIMM sockets**

### Recommended memory configurations

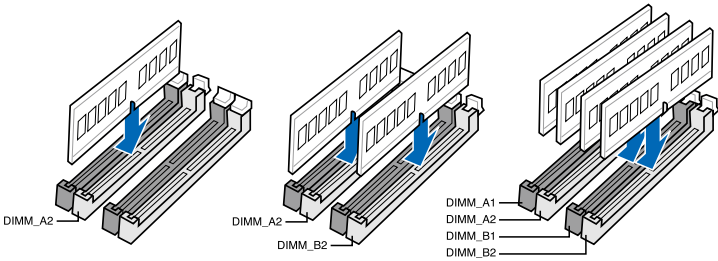

We recommend that you install the memory modules from the blue slots for better overclocking capability.

## Memory configurations

You may install 1GB, 2GB, 4GB and 8GB unbuffered and non-ECC DDR3 DIMMs into the DIMM sockets.



- You may install varying memory sizes in Channel A and Channel B. The system maps the total size of the lower-sized channel for the dual-channel configuration. Any excess memory from the higher-sized channel is then mapped for single-channel operation.
- According to Intel CPU specifications, DIMM voltage below 1.65V is recommended to protect the CPU.
- Always install DIMMs with the same CAS latency. For optimum compatibility, we recommend that you obtain memory modules from the same vendor.
- Due to the memory address limitation on 32-bit Windows OS, when you install 4GB or more memory on the motherboard, the actual usable memory for the OS is about 3GB or less. For effective use of memory, we recommend that you do any of the following:
  - Use a maximum of 3GB system memory if you are using a 32-bit Windows OS.
  - Install a 64-bit Windows OS when you want to install 4GB or more on the motherboard.
 For more details, refer to the Microsoft® support site at <http://support.microsoft.com/kb/929605/en-us>.
- This motherboard does not support DIMMs made up of 512Mb (64MB) chips or less (Memory chip capacity counts in Megabit, 8 Megabit/Mb = 1 Megabyte/MB).



- The default memory operation frequency is dependent on its Serial Presence Detect (SPD), which is the standard way of accessing information from a memory module. Under the default state, some memory modules for overclocking may operate at a lower frequency than the vendor-marked value. To operate at the vendor-marked frequency or at a higher frequency, refer to section **3.4 Ai Tweaker menu** for manual memory frequency adjustment.
- For system stability, use a more efficient memory cooling system to support a full memory load (4 DIMMs) or overclocking condition.



Visit the ASUS website [www.asus.com](http://www.asus.com) for latest QVL.

## P8H77-M PRO Motherboard Qualified Vendors Lists (QVL) DDR3 2400 MHz capability

Vendors	Part No.	Size	SS/DS	Chip Brand	Chip NO.	Timing	Voltage	DIMM socket support (Optional)		
								1 DIMM	2 DIMMs	4 DIMMs
CORSAIR	CMGTX8(XMP)	8GB (2GBx4)	SS	-	-	10-12-10-27	1.65V	*	*	*
G.SKILL	F3-19200CL11Q-16GBZHD(XMP)	16GB (4x4GB)	DS	-	-	11-11-11-31	1.65V	*	*	*
G.SKILL	F3-19200CL9D-4GBPIS(XMP)	4GB (2x2GB)	DS	-	-	9-11-9-28	1.65V	*	*	*
GEIL	GET34GB2400C9DC(XMP)	2GB	DS	-	-	9-11-9-27	1.65V	*	*	*
KINGMAX	FLLE88F-C8KKA H AIS(XMP)	2GB	SS	-	-	10-11-10-30	1.8V	*	*	*
Transcend	TX2400KLU-4GK(427652)(XMP)	4GB (2x2GB)	SS	-	-	-	1.65V	*	*	*
Transcend	TX2400KLU-4GK (381850)(XMP)	4GB (2x2GB)	SS	-	-	9	1.65V	*	*	*
Transcend	TX2400KLU-4GK(374243)(XMP)	4GB (2x2GB)	DS	-	-	9	1.65V	*	*	*
PATRIOT	PVV34G2400C9K(XMP)	4GB (2x2GB)	DS	-	-	9-11-9-27	1.65V	*	*	*

## P8H77-M PRO Motherboard Qualified Vendors Lists (QVL) DDR3 2250 MHz capability

Vendors	Part No.	Size	SS/ DS	Chip Brand	Chip NO.	Timing	Voltage	DIMM socket support (Optional)		
								1 DIMM	2 DIMMs	4 DIMMs
KINGMAX	KHX2250C9D3T1K2/4GX(XMP)	4GB (2x2GB)	DS	-	-	-	1.65V	•	•	•

## P8H77-M PRO Motherboard Qualified Vendors Lists (QVL) DDR3 2200 MHz capability

Vendors	Part No.	Size	SS/ DS	Chip Brand	Chip NO.	Timing	Voltage	DIMM socket support (Optional)		
								1 DIMM	2 DIMMs	4 DIMMs
G.SKILL	F3-17600CL8D-4GBPS(XMP)	4GB (2X2GB)	DS	-	-	8-8-8-24	1.65V	•	•	•
GEIL	GET34GB2200C9DC(XMP)	2GB	DS	-	-	9-10-9-28	1.65V	•	•	•
GEIL	GET38GB2200C9ADC(XMP)	4GB	DS	-	-	9-11-9-28	1.65V	•	•	•
KINGMAX	FLKE85F-B8KJAA-FEIS(XMP)	2GB	DS	-	-	-	-	•	•	•
KINGMAX	FLKE85F-B8KHA EEIH(XMP)	4GB (2X2GB)	DS	-	-	-	1.5V-1.7V	•	•	•
KINGMAX	FLKE85F-B8KJA FEIH(XMP)	4GB (2x2GB)	DS	-	-	-	1.5V-1.7V	•	•	•

## P8H77-M PRO Motherboard Qualified Vendors Lists (QVL) DDR3 2133 MHz capability

Vendors	Part No.	Size	SS/ DS	Chip Brand	Chip NO.	Timing	Voltage	DIMM socket support (Optional)		
								1 DIMM	2 DIMMs	4 DIMMs
A-DATA	AX3U2133GC2G9B-DG2(XMP)	2GB	SS	-	-	9-11-9-27	1.55-1.75V	•	•	•
CORSAIR	CMT16GX3M4X2133C9(XMP 1.3)	16GB (4x4GB)	DS	-	-	9-11-10-27	1.50V	•	•	•
CORSAIR	CMT4GX3M2A2133C9(XMP)	4GB (2x2GB)	DS	-	-	9-10-9-24	1.65V	•	•	•
CORSAIR	CMT4GX3M2B2133C9(XMP)	4GB (2GBx2)	DS	-	-	9-10-9-27	1.5V	•	•	•
G.SKILL	F3-17000CL9Q-16GBZH(XMP)	16GB (4GBx4)	DS	-	-	9-11-10-28	1.65V	•	•	•
GEIL	GE34GB2133C9DC(XMP)	2GB	DS	-	-	9-9-9-28	1.65V	•	•	•
GEIL	GU34GB2133C9DC(XMP)	4GB (2x2GB)	DS	-	-	9-9-9-28	1.65V	•	•	•
KINGSTON	KHX2133C9AD3T1K2/ 4GX(XMP)	4GB (2x2GB)	DS	-	-	-	1.65V	•	•	•
KINGSTON	KHX2133C9AD3X2K2/ 4GX(XMP)	4GB (2x2GB)	DS	-	-	9-11-9-27	1.65V	•	•	•
KINGSTON	KHX2133C9AD3T1K4/ 8GX(XMP)	8GB (4x2GB)	DS	-	-	9-11-9-27	1.65V	•	•	•
KINGSTON	KHX2133C9AD3T1FK4/ 8GX(XMP)	8GB (4x2GB)	DS	-	-	-	1.65V	•	•	•

## P8H77-M PRO Motherboard Qualified Vendors Lists (QVL) DDR3 2000 MHz capability

Vendors	Part No.	Size	SS/ DS	Chip Brand	Chip NO.	Timing	Voltage	DIMM socket support (Optional)		
								1 DIMM	2 DIMMs	4 DIMMs
Apacer	78.AAGD5.9KD(XMP)	6GB (3x2GB)	DS	-	-	9-9-9-27	1.65V	*	*	*
CORSAIR	CMZ4GX3M2A2000C10(XMP)	4GB (2x2GB)	SS	-	-	10-10-10-27	1.50V	*	*	*
CORSAIR	CMT6GX3M3A2000C8(XMP)	6GB (3x2GB)	DS	-	-	8-9-8-24	1.65V	*	*	*
G.SKILL	F3-16000CL9D-4GBFLS(XMP)	4GB (2GBx2)	DS	-	-	9-9-9-24	1.65V	*	*	*
G.SKILL	F3-16000CL9D-4GBTD(XMP)	4GB (2GBx2)	DS	-	-	9-9-9-27	1.65V	*	*	*
G.SKILL	F3-16000CL6T-6GBPIS(XMP)	6GB (2x4GB)	DS	-	-	6-9-6-24	1.65V	*	*	*
GEIL	GUP34GB2000C9DC(XMP)	4GB (2x2GB)	DS	-	-	9-9-9-28	1.65V	*	*	*
KINGSTON	KHX2000C9AD3T1K2/ 4GX(XMP)	4GB (2x2GB)	DS	-	-	-	1.65V	*	*	*
KINGSTON	KHX2000C9AD3W1K2/ 4GX(XMP)	4GB (2x2GB)	DS	-	-	-	1.65V	*	*	*
KINGSTON	KHX2000C9AD3T1K2/ 4GX(XMP)	4GB (2x2GB)	DS	-	-	9	1.65V	*	*	*
KINGSTON	KHX2000C9AD3W1K3/ 6GX(XMP)	6GB (3x2GB)	DS	-	-	-	1.65V	*	*	*
KINGSTON	KHX2000C9AD3T1K3/ 6GX(XMP)	6GB (3x2GB)	DS	-	-	-	1.65V	*	*	*
Transcend	TX2000LN-8GK(XMP)	8GB (2x4GB)	DS	-	-	-	1.6V	*	*	*
Asint	SLA302G08-ML2HB(XMP)	4GB	DS	HYNIX	H5TQ2G83BFR H9C	-	-	*	*	*
PATRIOT	PVT36G2000LLK	6GB (3x2GB)	DS	-	-	8-8-8-24	1.65V	*	*	*

## P8H77-M PRO Motherboard Qualified Vendors Lists (QVL) DDR3 1866 MHz capability

Vendors	Part No.	Size	SS/ DS	Chip Brand	Chip NO.	Timing	Voltage	DIMM socket support (Optional)		
								1 DIMM	2 DIMMs	4 DIMMs
A-DATA	AX3U1866PB2G8-DP2(XMP)	2GB	DS	-	-	8-8-8-24	1.55V-1.75V	*	*	*
CORSAIR	CMT4GX3M2A1866C9(XMP)	4GB (2x2GB)	DS	-	-	9-9-9-24	1.65V	*	*	*
CORSAIR	CMT6GX3MA1866C9(XMP)	6GB (3x2GB)	DS	-	-	9-9-9-24	1.65V	*	*	*
CORSAIR	CMZ8GX3M2A1866C9(XMP)	8GB (2x4GB)	DS	-	-	9-10-9-27	1.50V	*	*	*
G.SKILL	F3-14900CL9Q-16GBZL(XMP)	16GB (4GBx4)	DS	-	-	9-10-9-28	1.5V	*	*	*
G.SKILL	F3-14900CL10Q2- 64GBZLD(XMP)	64GB (8GBx8)	DS	-	-	10-11-10-30	1.5V	*	*	*
G.SKILL	F3-14900CL9D-8GBXL(XMP)	8GB (2x4GB)	DS	-	-	9-10-9-28	1.6V	*	*	*
G.SKILL	F3-14900CL9Q-8GBXL(XMP)	8GB (2GBx4)	DS	-	-	9-9-9-24	1.65V	*	*	*
KINGSTON	KHX1866C9D3T1K3/3GX(XMP)	3GB (3x1GB)	SS	-	-	-	1.65V	*	*	*
KINGSTON	KHX1866C9D3K4/16GX(XMP)	16GB (4GBx4)	DS	-	-	-	1.65V	*	*	*
KINGSTON	KHX1866C9D3T1K3/6GX(XMP)	6GB (3x2GB)	DS	-	-	-	1.65V	*	*	*
KINGSTON	KHX1866C11D3P1K2/8G	8GB (4GBx2)	DS	-	-	-	1.5V	*	*	*

# P8H77-M PRO Motherboard Qualified Vendors Lists (QVL)

## DDR3 1600 MHz capability

Vendors	Part No.	Size	SS/DS	Chip Brand	Chip NO.	Timing	Voltage	DIMM socket support (Optional)		
								1 DIMM	2 DIMMs	4 DIMMs
A-DATA	AM2U16BC2P1	2GB	SS	A-DATA	3CCD-1509A EL1126T	-	-	*	*	*
A-DATA	AD31600E001GM(O)U3K	3GB(3 x 1GB)	SS	-	-	8-8-8-24	1.65V-1.85V	*	*	*
A-DATA	AX3U1600XB2G79-2X(XMP)	4GB(2 x 2GB)	DS	-	-	7-9-7-21	1.55V-1.75V	*	*	*
A-DATA	AM2U16BC4P2	4GB	DS	A-DATA	3CCD-1509A EL1126T	-	-	*	*	*
A-DATA	AX3U1600GC4G9-2G(XMP)	8GB(2 x 4GB)	DS	-	-	9-9-9-24	1.55V-1.75V	*	*	*
A-DATA	AX3U1600XC4G79-2X(XMP)	8GB(2 x 4GB)	DS	-	-	7-9-7-21	1.55V-1.75V	*	*	*
CORSAIR	TR3X3G1600C8D(XMP)	3GB(3 x 1GB)	SS	-	-	8-8-8-24	1.65V	*	*	*
CORSAIR	CMD12GX3M6A1600C8(XMP)	12GB(6 x 2GB)	DS	-	-	8-8-8-24	1.65V	*	*	*
CORSAIR	CMP4GX3M2A1600C8(XMP)	4GB(2 x 2GB)	DS	-	-	8-8-8-24	1.65V	*	*	*
CORSAIR	CMP4GX3M2A1600C9(XMP)	4GB(2 x 2GB)	DS	-	-	9-9-9-24	1.65V	*	*	*
CORSAIR	CMP4GX3M2C1600C7(XMP)	4GB(2 x 2GB)	DS	-	-	7-8-7-20	1.65V	*	*	*
CORSAIR	CMP4GX3M2A1600C9(XMP)	4GB(2 x 2GB)	DS	-	-	9-9-9-24	1.65V	*	*	*
CORSAIR	CMP4GX3M2A1600C9(XMP)	4GB(2 x 2GB)	DS	-	-	9-9-9-24	1.65V	*	*	*
CORSAIR	TR3X6G1600C8 G(XMP)	6GB(3 x 2GB)	DS	-	-	8-8-8-24	1.65V	*	*	*
CORSAIR	TR3X6G1600C8D G(XMP)	6GB(3 x 2GB)	DS	-	-	8-8-8-24	1.65V	*	*	*
CORSAIR	TR3X6G1600C9 G(XMP)	6GB(3 x 2GB)	DS	-	-	9-9-9-24	1.65V	*	*	*
CORSAIR	CMP8GX3M2A1600C9(XMP)	8GB(2 x 4GB)	DS	-	-	9-9-9-24	1.65V	*	*	*
CORSAIR	CMZ8GX3M2A1600C7(XMP)	8GB(2 x 4GB)	DS	-	-	7-8-7-20	1.50V	*	*	*
CORSAIR	CMX8GX3M4A1600C9(XMP)	8GB(4 x 2GB)	DS	-	-	9-9-9-24	1.65V	*	*	*
Crucial	BL25664BN1608.16FF(XMP)	6GB(3 x 2GB)	DS	-	-	-	-	*	*	*
G.SKILL	F3-12800CL9D-2GBNQ(XMP)	2GB(2 x 1GB)	SS	-	-	9-9-9-24	1.5V	*	*	*
G.SKILL	F3-12800CL7D-4GBRHX(XMP)	4GB(2 x 2GB)	SS	-	-	7-7-7-24	1.6V	*	*	*
G.SKILL	F3-12800CL7D-4GBRHX(XMP)	4GB(2 x 2GB)	DS	-	-	7-8-7-24	1.6V	*	*	*
G.SKILL	F3-12800CL8D-4GBRHX(XMP)	4GB(2 x 2GB)	DS	-	-	8-8-8-24	1.60V	*	*	*
G.SKILL	F3-12800CL9D-4GBECC(XMP)	4GB(2 x 2GB)	DS	-	-	9-9-9-24	1.35V	*	*	*
G.SKILL	F3-12800CL9D-4GBRLL(XMP)	4GB(2 x 2GB)	DS	-	-	9-9-9-24	1.5V	*	*	*
G.SKILL	F3-12800CL9T-6GBNQ(XMP)	6GB(3 x 2GB)	DS	-	-	9-9-9-24	1.5V-1.6V	*	*	*
G.SKILL	F3-12800CL7D-8GBRHX(XMP)	8GB(2 x 4GB)	DS	-	-	7-8-7-24	1.6V	*	*	*
G.SKILL	F3-12800CL8D-8GBECC(XMP)	8GB(2 x 4GB)	DS	-	-	8-8-8-24	XMP 1.35V	*	*	*
G.SKILL	F3-12800CL9D-8GBRLL(XMP)	8GB(2 x 4GB)	DS	-	-	9-9-9-24	1.5V	*	*	*
GEIL	GET316GB1600C9QC(XMP)	16GB(4 x 4GB)	DS	-	-	9-9-9-28	1.6V	*	*	*
GEIL	GV34GB1600C8DC(XMP)	2GB	DS	-	-	8-8-8-28	1.6V	*	*	*
KINGMAX	FLGD45F-B8MF7 MAEH(XMP)	1GB	SS	-	-	7	-	*	*	*
KINGMAX	FLGE85F-B8KJ9A FEIS(XMP)	2GB	DS	-	-	-	-	*	*	*
KINGMAX	FLGE85F-B8MF7 MEEH(XMP)	2GB	DS	-	-	7	-	*	*	*
KINGSTON	KHX1600C9D3P1K2/4G	4GB(2 x 2GB)	SS	-	-	-	1.5V	*	*	*
KINGSTON	KHX1600C9D3K3/12GX(XMP)	12GB(3 x 4GB)	DS	-	-	9-9-9-27	1.65V	*	*	*
KINGSTON	KHX1600C9D3T1BK3/12GX(XMP)	12GB(3 x 4GB)	DS	-	-	9-9-9-27	1.65V	*	*	*
KINGSTON	KHX1600C9D3K4/16GX(XMP)	16GB(4 x 4GB)	DS	-	-	-	1.65V	*	*	*
KINGSTON	KHX1600C9AD3/2G	2GB	DS	-	-	-	1.65V	*	*	*
KINGSTON	KVR1600D3N11/2G-ES	2GB	DS	KTC	D1288JPNP DPLD9U	11-11-11-28	1.35V-1.5V	*	*	*
KINGSTON	KHX1600C7D3K2/4GX(XMP)	4GB(2 x 2GB)	DS	-	-	-	1.65V	*	*	*
KINGSTON	KHX1600C8D3K2/4GX(XMP)	4GB(2 x 2GB)	DS	-	-	8	1.65V	*	*	*
KINGSTON	KHX1600C8D3T1K2/4GX(XMP)	4GB(2 x 2GB)	DS	-	-	8	1.65V	*	*	*
KINGSTON	KHX1600C9D3K2/4GX(XMP)	4GB(2 x 2GB)	DS	-	-	9	1.65V	*	*	*
KINGSTON	KHX1600C9D3LK2/4GX(XMP)	4GB(2 x 2GB)	DS	-	-	9	XMP 1.35V	*	*	*
KINGSTON	KHX1600C9D3X2K2/4GX(XMP)	4GB(2 x 2GB)	DS	-	-	9-9-9-27	1.65V	*	*	*
KINGSTON	KHX1600C9D3T1K3/6GX(XMP)	6GB(3x 2GB)	DS	-	-	-	1.65V	*	*	*
KINGSTON	KHX1600C9D3K3/6GX(XMP)	6GB(3 x 2GB)	DS	-	-	9	1.65V	*	*	*
KINGSTON	KHX1600C9D3T1BK3/6GX(XMP)	6GB(3 x 2GB)	DS	-	-	9-9-9-27	1.65V	*	*	*
KINGSTON	KHX1600C9D3K2/8GX(XMP)	8GB(2 x 4GB)	DS	-	-	9-9-9-27	1.65V	*	*	*

## P8H77-M PRO Motherboard Qualified Vendors Lists (QVL) DDR3 1600 MHz capability (continued)

Vendors	Part No.	Size	SS/ DS	Chip Brand	Chip NO.	Timing	Voltage	DIMM socket support (Optional)		
								1 DIMM	2 DIMMs	4 DIMMs
KINGSTON	KHX1600C9D3P1K2/8G	8GB(2 x 4GB)	DS	-	-	-	1.5V	*	*	*
Super Talent	WA160UX6G9	6GB(3 x 2GB)	DS	-	-	9	-	*	*	*
Transcend	JM1600KLN-8GK	8GB(2 x 4GB)	DS	Transcend	TK483PCW3	-	-	*	*	*
Asint	SLZ3128M8-EGJ1D(XMP)	2GB	DS	Asint	3128M8- GJ1D	9-9-9-24	1.6V	*	*	*
Asint	SLA302G08-EGG1C(XMP)	4GB	DS	Asint	302G08- GG1C	-	-	*	*	*
Asint	SLA302G08-EGJ1C(XMP)	4GB	DS	Asint	302G08- GJ1C	-	-	*	*	*
Elixir	M2P2G64C8B8HC9N-DG(XMP)	2GB	DS	-	-	-	-	*	*	*
Kingtiger	KTG2G1600PG3	2GB	DS	-	-	-	-	*	*	*
Mushkin	998659(XMP)	6GB(3 x 2GB)	DS	-	-	9-9-9-24	-	*	*	*
Mushkin	998659(XMP)	6GB(3 x 2GB)	DS	-	-	9-9-9-24	1.5~1.6V	*	*	*
PATRIOT	PGS34G1600LLKA	4GB(2 x 2GB)	DS	-	-	7-7-7-20	1.7V	*	*	*
SanMax	SMD-4G68HP-16KZ	4GB	DS	HYNIX	H5TQ2G83B FR PBC	-	-	*	*	*

## P8H77-M PRO Motherboard Qualified Vendors Lists (QVL) DDR3 1333 MHz capability

Vendors	Part No.	Size	SS/ DS	Chip Brand	Chip NO.	Timing	Voltage	DIMM socket support (Optional)		
								1 DIMM	2 DIMMs	4 DIMMs
A-DATA	AD31333001GOU	1GB	SS	A-Data	AD30908C8D-151C E0906	-	-	*	*	*
A-DATA	AD3U1333C2G9	2GB	SS	A-DATA	3CCD- 1509HNA1126L	-	-	*	*	*
A-DATA	AD631B0823EV	2GB	SS	A-Data	3CCA-1509A	-	-	*	*	*
A-DATA	AM2U139C2P1	2GB	SS	ADATA	3CCD-1509A EL1127T	-	-	*	*	*
A-DATA	AX3U1333C2G9-BP	2GB	SS	-	-	-	-	*	*	*
A-DATA	AD31333G001GOU	3GB(3 x 1GB)	SS	-	-	8-8-8-24	1.65-1.85V	*	*	*
A-DATA	AXDU1333GC2G9-2G (XMP)	4GB(2 x 2GB)	SS	-	-	9-9-9-24	1.25V-1.35V (low voltage)	*	*	*
A-DATA	AD31333G002GMU	2GB	DS	-	-	8-8-8-24	1.65-1.85V	*	*	*
A-DATA	AD6311C1624EV	4GB	DS	A-Data	3CCA-1509A	-	-	*	*	*
A-DATA	AM2U139C4P2	4GB	DS	ADATA	3CCD-1509A EL1127T	-	-	*	*	*
A-DATA	SU3U1333W8G9-B	8GB	DS	ELPIDA	J4208BASE-DJ-F	-	-	*	*	*
Apacer	78.A1GC6.9L1	2GB	DS	Apacer	AM5D5808D EWSBG	-	-	*	*	*
Apacer	78.A1GC6.9L1	2GB	DS	Apacer	AM5D5808F EQSBG	9	-	*	*	*
Apacer	AU02GFA33C9NBGC	2GB	DS	Apacer	AM5D5808 APQSBG	-	-	*	*	*
Apacer	78.B1GDE.9L10C	4GB	DS	Apacer	AM5D5908 CEHSBG	-	-	*	*	*
CORSAIR	CM3X1024-1333C9	1GB	SS	-	-	9-9-9-24	1.60V	*	*	*
CORSAIR	TR3X3G1333C9 G	3GB(3 x 1GB)	SS	-	-	9-9-9-24	1.50V	*	*	*
CORSAIR	TR3X6G1333C9 G	6GB(3 x 2GB)	SS	-	-	9-9-9-24	1.50V	*	*	*
CORSAIR	CMD24GX3M6A1333C9 (XMP)	24GB (6 x 4GB)	DS	-	-	9-9-9-24	1.60V	*	*	*
CORSAIR	TW3X4G1333C9D G	4GB(2 x 2GB)	DS	-	-	9-9-9-24	1.50V	*	*	*
CORSAIR	CM3X4GA1333C9N2	4GB	DS	CORSAIR	256MBDCJGE LC0401136	9-9-9-24	-	*	*	*
CORSAIR	CMX4GX3M1A1333C9	4GB	DS	-	-	9-9-9-24	1.50V	*	*	*
CORSAIR	CMD8GX3M4A1333C7	8GB(4 x 2GB)	DS	-	-	7-7-7-20	1.60V	*	*	*
Crucial	CT12864BA1339.8FF	1GB	SS	Micron	9FF22D9KPT	9	-	*	*	*
Crucial	CT25664BA1339.16FF	2GB	DS	Micron	9KF27D9KPT	9	-	*	*	*
Crucial	BL25664BN1337.16FF (XMP)	6GB(3 x 2GB)	DS	-	-	7-7-7-24	1.65V	*	*	*



## P8H77-M PRO Motherboard Qualified Vendors Lists (QVL) DDR3 1333 MHz capability (continued)

Vendors	Part No.	Size	SS/ DS	Chip Brand	Chip NO.	Timing	Voltage	DIMM socket support (Optional)		
								1 DIMM	2 DIMMs	4 DIMMs
ELPIDA	EBJ10UE8EDF0-DJ-F	1GB	SS	ELPIDA	J1108EDSE-DJ-F	-	1.35V (low voltage)	*	*	*
ELPIDA	EBJ21UE8EDF0-DJ-F	2GB	DS	ELPIDA	J1108EDSE-DJ-F	-	1.35V (low voltage)	*	*	*
G.SKILL	F3-10600CL8D-2GBHK (XMP)	1GB	SS	G.SKILL	-	-	-	*	*	*
G.SKILL	F3-10600CL9D-2GBNQ	2GB(2 x 1GB)	SS	-	-	9-9-9-24	1.5V	*	*	*
G.SKILL	F3-10666CL7T-3GBPK (XMP)	3GB(3 x 1GB)	SS	-	-	7-7-7-18	1.5~1.6V	*	*	*
G.SKILL	F3-10666CL8D- 4GBECO(XMP)	4GB(2 x 2GB)	DS	-	-	8-8-8-8-24	XMP 1.35V	*	*	*
G.SKILL	F3-10666CL7T-6GBPK (XMP)	6GB(3 x 2GB)	DS	-	-	7-7-7-18	1.5~1.6V	*	*	*
G.SKILL	F3-10666CL7D-8GBRH (XMP)	8GB(2 x 4GB)	DS	-	-	7-7-7-21	1.5V	*	*	*
GEIL	GV32GB1333C9DC	2GB(2 x 1GB)	DS	-	-	9-9-9-24	1.5V	*	*	*
GEIL	GG34GB1333C9DC	4GB(2 x 2GB)	DS	GEIL	GL1L128M88BA12N	9-9-9-24	1.3V (low voltage)	*	*	*
GEIL	GV34GB1333C9DC	4GB(2 x 2GB)	DS	-	-	9-9-9-24	1.5V	*	*	*
GEIL	GVP34GB1333C7DC	4GB(2 x 2GB)	DS	-	-	7-7-7-24	1.5V	*	*	*
Hynix	HMT112U6TFR8A-H9	1GB	SS	Hynix	H5TC1G83TFRH9A	-	1.35V (low voltage)	*	*	*
Hynix	HMT325U6BFR8C-H9	2GB	SS	Hynix	H5TQ2G83BFRH9C	-	-	*	*	*
Hynix	HMT125U6TFR8A-H9	2GB	DS	Hynix	H5TC1G83TFRH9A	-	1.35V (low voltage)	*	*	*
Hynix	HMT351U6BFR8C-H9	4GB	DS	Hynix	H5TQ2G83BFRH9C	-	-	*	*	*
KINGMAX	FLFD45F-B8KL9 NAES	1GB	SS	KINGMAX	KKB8FNWBFGNX- 27A	-	-	*	*	*
KINGMAX	FLFE85F-C8KF9 CAES	2GB	SS	KINGMAX	KFC8FMFXF-DXX- 15A	-	-	*	*	*
KINGMAX	FLFE85F-C8KL9 NAES	2GB	SS	KINGMAX	KFC8FNLXF-DXX- 15A	-	-	*	*	*
KINGMAX	FLFE85F-C8KM9 NAES	2GB	SS	KINGMAX	KFC8FNMXF-BXX- 15A	-	-	*	*	*
KINGMAX	FLFE85F-B8KL9 NEES	2GB	DS	KINGMAX	KKB8FNWBFGNX- 26A	-	-	*	*	*
KINGMAX	FLFF65F-C8KL9 NEES	4GB	DS	KINGMAX	KFC8FNLXF-DXX- 15A	-	-	*	*	*
KINGMAX	FLFF65F-C8KM9 NEES	4GB	DS	KINGMAX	KFC8FNMXF-BXX- 15A	-	-	*	*	*
KINGSTON	KVR1333D3N9/1G (low profile)	1GB	SS	ELPIDA	J1108BDBG-DJ-F	9	1.5V	*	*	*
KINGSTON	KVR1333D3N9/2G (low profile)	2GB	SS	Hynix	H5TQ2G83AFRH9C	9	-	*	*	*
KINGSTON	KVR1333D3S8N9/2G	2GB	SS	Micron	ID77 D9LJK	-	1.5V	*	*	*
KINGSTON	KVR1333D3S8N9/2G-SP (low profile)	2GB	SS	ELPIDA	J2108BCSE-DJ-F	-	1.5V	*	*	*
KINGSTON	KVR1333D3N9/2G (low profile)	2GB	DS	ELPIDA	J1108BFBG-DJ-F	9	1.5V	*	*	*
KINGSTON	KVR1333D3N9/2G	2GB	DS	KTC	D1288JPNPLD9U	9	1.5V	*	*	*
KINGSTON	KVR1333D3N9/2G	2GB	DS	ELPIDA	J1108BDSE-DJ-F	9	1.5V	*	*	*
KINGSTON	KVR1333D3N9/2G-SP (low profile)	2GB	DS	KTC	D1288JEMFNGD9U	-	1.5V	*	*	*
KINGSTON	KVR1333D3N9/2G-SP (low profile)	2GB	DS	KINGSTON	D1288JPSFPGD9U	-	1.5V	*	*	*
KINGSTON	KHX1333C7D3K2/4GX (XMP)	4GB(2 x 2GB)	DS	-	-	7	1.65V	*	*	*
KINGSTON	KHX1333C9D3UK2/4GX (XMP)	4GB(2 x 2GB)	DS	-	-	9	XMP 1.25V	*	*	*
KINGSTON	KVR1333D3N9/4G (low profile)	4GB	DS	ELPIDA	J2108BCSE-DJ-F	9	1.5V	*	*	*
KINGSTON	KVR1333D3N9/4G (low profile)	4GB	DS	ELPIDA	J2108BCSE-DJ-F	-	1.5V	*	*	*
KINGSTON	KVR1333D3N9/4G	4GB	DS	KTC	D2568JENCNGD9U	-	1.5V	*	*	*
KINGSTON	KVR1333D3N9/4G	4GB	DS	Hynix	H5TQ2G83AFR	-	-	*	*	*

## P8H77-M PRO Motherboard Qualified Vendors Lists (QVL) DDR3 1333 MHz capability (continued)

Vendors	Part No.	Size	SS/ DS	Chip Brand	Chip NO.	Timing	Voltage	DIMM socket support (Optional)		
								1 DIMM	2 DIMMs	4 DIMMs
KINGSTON	KVR1333D3N9/4G-SP (low profile)	4GB	DS	KINGSTON	D2568JENCPGD9U	-	1.5V	*	*	*
Micron	MT4JTF12864AZ-1G4D1	1GB	SS	Micron	OJD12D9LGQ	-	-	*	*	*
Micron	MT8JTF12864AZ-1G4F1	1GB	SS	Micron	9FF22D9KPT	9	-	*	*	*
Micron	MT8JTF25664AZ-1G4D1	2GB	SS	Micron	OJD12D9LGK	-	-	*	*	*
Micron	MT8JTF25664AZ-1G4M1	2GB	SS	MICRON	IJM22 D9PFJ	-	-	*	*	*
Micron	MT16JTF25664AZ-1G4F1	2GB	DS	Micron	9KF27D9KPT	9	-	*	*	*
Micron	MT16JTF51264AZ-1G4D1	4GB	DS	Micron	OLD22D9LGK	-	-	*	*	*
NANYA	NT4GC64B8HG0NF-CG	4GB	DS	NANYA	NT5CB256M8GN-CG	-	-	*	*	*
PSC	AL7F8G73F-DJ2	1GB	SS	PSC	A3P1GF3FGF	-	-	*	*	*
PSC	AL8F8G73F-DJ2	2GB	DS	PSC	A3P1GF3FGF	-	-	*	*	*
SAMSUNG	M378B2873FHS-CH9	1GB	SS	SAMSUNG	K4B1G0846F	-	-	*	*	*
SAMSUNG	M378B5773DH0-CH9	2GB	SS	SAMSUNG	K4B2G0846D	-	-	*	*	*
SAMSUNG	M378B5673FH0-CH9	2GB	DS	SAMSUNG	K4B1G0846F	-	-	*	*	*
SAMSUNG	M378B5273CH0-CH9	4GB	DS	SAMSUNG	K4B2G0846C	-	-	*	*	*
SAMSUNG	M378B1G73AH0-CH9	8GB	DS	SAMSUNG	K4B4G0846A-HCH9	-	-	*	*	*
Super Talent	W1333UA1GH	1GB	SS	Hynix	H5TQ1G83TFR	9	-	*	*	*
Super Talent	W1333UX2G8(XMP)	2GB(2x 1GB)	SS	-	-	8	-	*	*	*
Super Talent	W1333UB2GS	2GB	DS	SAMSUNG	K4B1G0846F	9	-	*	*	*
Super Talent	W1333UB4GS	4GB	DS	SAMSUNG	K4B2G0846C	-	-	*	*	*
Super Talent	W1333UX6GM	6GB(3x 2GB)	DS	Micron	0BF27D9KPT	9-9-9-24	1.5V	*	*	*
Transcend	JM1333KLN-2G	2GB	SS	Micron	0YD77D9LGK	-	-	*	*	*
Transcend	JM1333KLN-2G	2GB	SS	Hynix	H5TQ2G83BZRH9C	-	-	*	*	*
Transcend	TS256MLK64V3U	2GB	DS	Micron	9GF27D9KPT	-	-	*	*	*
Century	PC3-10600 DDR3-1333 9-9-9	1GB	SS	NANYA	NT5CB128M8DN-CF	-	-	*	*	*
Elixir	M2F2G64CB88B7N-CG	2GB	SS	Elixir	N2CB2G80BN-CG	-	-	*	*	*
Elixir	M2F2G64CB88D7N-CG	2GB	SS	Elixir	N2CB2G80DN-CG	-	-	*	*	*
Elixir	M2F2G64CB88G7N-CG	2GB	SS	Elixir	N2CB2G80GN-CG	-	-	*	*	*
Elixir	M2F4G64CB88B5N-CG	4GB	DS	Elixir	N2CB2G80BN-CG	-	-	*	*	*
Elixir	M2F4G64CB88D5N-CG	4GB	DS	Elixir	N2CB2G80DN-CG	-	-	*	*	*
KINGSHARE	KSRPCD313332G	2GB	DS	PATRIOT	PM128M8D385-15	-	-	*	*	*
KINGSTEK	KSTD3PC-10600	2GB	SS	MICRON	PE911-125E	-	-	*	*	*
Kingtiger	2GB DIMM PC3-10666	2GB	DS	SAMSUNG	SEC 904 HC99 K4B1G0846D	-	-	*	*	*
Kingtiger	KTG2G1333PG3	2GB	DS	-	-	-	-	*	*	*
MARKVISION	BMD32048M1333C9-1123	2GB	DS	MARKVISION	M3D1288P-13	-	-	*	*	*
MARKVISION	BMD34096M1333C9-1124	4GB	DS	MARKVISION	M3D2568E-13	-	-	*	*	*
PATRIOT	PSD31G13332H	1GB	DS	-	-	9	-	*	*	*
PATRIOT	PSD31G13332	1GB	DS	PATRIOT	PM64M8D38U-15	-	-	*	*	*
PATRIOT	PSD32G13332H	2GB	DS	-	-	-	-	*	*	*
PATRIOT	PG38G1333EL(XMP)	8GB	DS	-	-	9-9-9-24	1.5V	*	*	*
RAMAXEL	RMR1870ED48E8F-1333	2GB	DS	ELPIDA	J1108BDBG-DJ-F	-	-	*	*	*
RAMAXEL	RMR1870EC58E9F-1333	4GB	DS	ELPIDA	J2108BCE-DJ-F	-	-	*	*	*
RiDATA	E304459CB1AG32Cf	4GB	DS	RiDATA	N/A	9	-	*	*	*
SanMax	SMD-4G668H1P-13HZ	4GB	DS	HYNIX	H5TQ2G83BFR H9C	-	-	*	*	*
SILICON POWER	SP001GBLTU133S01	1GB	SS	NANYA	NT5CB128M8AN-CG	9	-	*	*	*
SILICON POWER	SP001GBLTU133S02	1GB	SS	Elixir	N2CB1680AN-C6	9	-	*	*	*
SILICON POWER	SP002GBLTU133S02	2GB	DS	Elixir	N2CB1680AN-C6	9	-	*	*	*
TAKEMS	TMS1GB364D081-107EY	1GB	SS	-	-	7-7-7-20	1.5V	*	*	*
TAKEMS	TMS1GB364D081-138EY	1GB	SS	-	-	8-8-8-24	1.5V	*	*	*
TAKEMS	TMS2GB364D081-107EY	2GB	DS	-	-	7-7-7-20	1.5V	*	*	*
TAKEMS	TMS2GB364D081-138EY	2GB	DS	-	-	8-8-8-24	1.5V	*	*	*
TAKEMS	TMS2GB364D082-138EW	2GB	DS	-	-	8-8-8-24	1.5V	*	*	*
UMAX	E41302GP0-73BDB	2GB	DS	UMAX	U2S24D30TP-13	-	-	*	*	*
WINTEC	3WVS31333-2G-CNR	2GB	DS	AMPO	AM3420803-13H	-	-	*	*	*

## P8H77-M PRO Motherboard Qualified Vendors Lists (QVL) DDR3 1066 MHz capability

Vendors	Part No.	Size	SS/ DS	Chip Brand	Chip NO.	Timing	Voltage	DIMM socket support (Optional)		
								1 DIMM	2 DIMMs	4 DIMMs
Crucial	CT12864BA1067.8FF	1GB	SS	Micron	9GF22D9KPT	7	-	•	•	•
Crucial	CT25664BA1067.16FF	2GB	DS	Micron	9HF22D9KPT	7	-	•	•	•
ELPIDA	EBJ10UE8EDF0-AE-F	1GB	SS	ELPIDA	J1108EDSE-DJ-F	-	1.35V(low voltage)	•	•	•
ELPIDA	EBJ21UE8EDF0-AE-F	2GB	DS	ELPIDA	J1108EDSE-DJ-F	-	1.35V(low voltage)	•	•	•
KINGSTON	KVR1066D3N71G(low profile)	1GB	SS	ELPIDA	J1108BFSE-DJ-F	7	1.5V	•	•	•
KINGSTON	KVR1066D3N72G	2GB	DS	ELPIDA	J1108BDSE-DJ-F	7	1.5V	•	•	•
KINGSTON	KVR1066D3N74G	4GB	DS	Hynix	H5TQ2G83AFR	7	1.5V	•	•	•
Micron	MT8JTF12864AZ-1G1F1	1GB	SS	Micron	9GF22D9KPT	7	-	•	•	•
Micron	MT16JTF25664AZ-1G1F1	2GB	DS	Micron	9HF22D9KPT	7	-	•	•	•
Kingtiger	2GB DIMM PC3-8500	2GB	DS	Hynix	H5TQ1G83AFP G7C	-	-	•	•	•



- Due to the CPU behavior, DDR3 2133/1866MHz memory module will run at DDR3 2000/1800MHz frequency as default.
- DDR3 1600 MHz and higher memory frequency is supported by Intel® 3rd generation processors.



### Side(s): SS - Single-sided DS - Double-sided DIMM support:

- **1 DIMM:** Supports one (1) module inserted into any slot as Single-channel memory configuration. **We suggest that you install the module into A2 slot.**
- **2 DIMMs:** Supports two (2) modules inserted into either the blue slots or the black slots as one pair of Dual-channel memory configuration. **We suggest that you install the modules into slots A2 and B2 for better compatibility.**
- **4 DIMMs:** Supports four (4) modules inserted into both the blue and black slots as two pairs of Dual-channel memory configuration.



- ASUS exclusively provides hyper DIMM support function.
- Hyper DIMM support is subject to the physical characteristics of individual CPUs. Load the X.M.P. or D.O.C.P. settings in the BIOS for the hyper DIMM support.
- Visit the ASUS website for the latest QVL.

## 2.2.4 Expansion slots



Unplug the power cord before adding or removing expansion cards. Failure to do so may cause you physical injury and damage motherboard components.

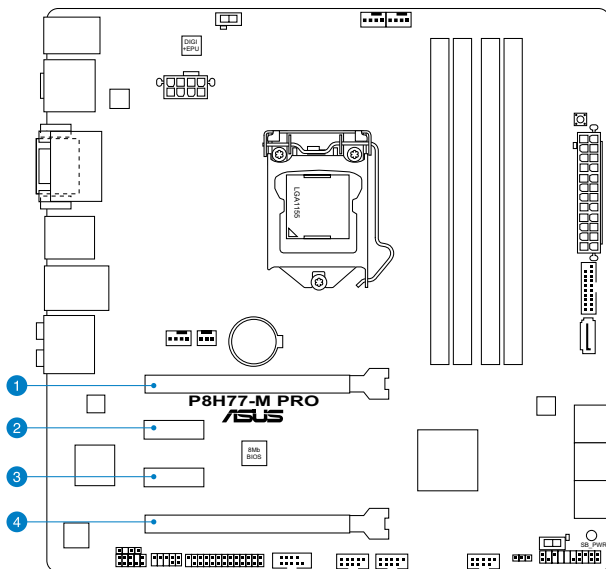

Slot No.	Slot Description
1	PCIe 3.0/2.0 x16_1 slot [blue] (at x16 mode)
2	PCIe 2.0 x1_1 slot
3	PCIe 2.0 x1_2 slot
4	PCIe 2.0 x16_2 slot [black] (at x4 mode, compatible with PCIe x1 and x4 devices)

VGA configuration	PCI Express operating mode	
	PCIe 3.0/2.0 x16_1	PCIe 2.0 x16_2
Single VGA/PCIe card	x16 (Recommend for single VGA)	N/A
Dual VGA/PCIe card	x16	x4



- PCIe 3.0 support depends on the CPU type and requires a PCIe 3.0 VGA card.
- In single VGA card mode, use the PCIe 3.0/2.0 x16\_1 slot (blue) for a PCI Express x16 graphics card to get better performance.
- In CrossFireX™ mode, use the PCIe 3.0/2.0 x16\_1 and PCIe 2.0 x16\_2 slots for PCI Express x16 graphics cards to get better performance.
- We recommend that you provide sufficient power when running CrossFireX™ mode.
- Connect a chassis fan to the motherboard connector labeled CHA\_FAN1/2 when using multiple graphics cards for better thermal environment. See page 2-24 for details.

## IRQ assignments for this motherboard

	A	B	C	D	E	F	G	H
LAN	shared	-	-	-	-	-	-	-
Marvell 9172	-	-	shared	-	-	-	-	-
PCIe x16_1	shared	-	-	-	-	-	-	-
PCIe x16_2	shared	-	-	-	-	-	-	-
PCIe x1_1	-	shared	-	-	-	-	-	-
PCIe x1_2	-	-	-	shared	-	-	-	-
Intel PCH SATA Controller	-	-	-	shared	-	-	-	-
HD Audio	-	-	-	-	-	-	shared	-
USB 2.0_1	-	-	-	-	-	-	-	shared
USB 2.0_2	-	-	-	-	-	-	-	shared
USB 3.0	shared	-	-	-	-	-	-	-

## 2.2.5 Jumper

### Clear RTC RAM (3-pin CLRRTC)

This jumper allows you to clear the Real Time Clock (RTC) RAM in CMOS. You can clear the CMOS memory of date, time, and system setup parameters by erasing the CMOS RTC RAM data. The onboard button cell battery powers the RAM data in CMOS, which include system setup information such as system passwords.

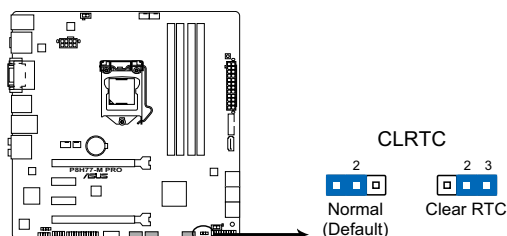

### P8H77-M PRO Clear RTC RAM

To erase the RTC RAM

1. Turn OFF the computer and unplug the power cord.
2. Move the jumper cap from pins 1-2 (default) to pins 2-3. Keep the cap on pins 2-3 for about 5–10 seconds, then move the cap back to pins 1-2.
3. Plug the power cord and turn ON the computer.
4. Hold down the <Del> key during the boot process and enter BIOS setup to re-enter data.



---

Except when clearing the RTC RAM, never remove the cap on CLRRTC jumper default position. Removing the cap will cause system boot failure!

---



- If the steps above do not help, remove the onboard battery and move the jumper again to clear the CMOS RTC RAM data. After clearing the CMOS, reinstall the battery.
  - You do not need to clear the RTC when the system hangs due to overclocking. For system failure due to overclocking, use the C.P.R. (CPU Parameter Recall) feature. Shut down and reboot the system so the BIOS can automatically reset parameter settings to default values.
-

## 2.2.6 Onboard switches

Onboard switches allow you to fine-tune performance when working on a bare or open-case system. This is ideal for overclockers and gamers who continually change settings to enhance system performance.

### 1. MemOK! switch

Installing DIMMs that are incompatible with the motherboard may cause system boot failure, and the DRAM\_LED near the MemOK! to switch lights continuously. Press and hold the MemOK! switch until the DRAM\_LED starts blinking to begin automatic memory compatibility tuning for successful boot.

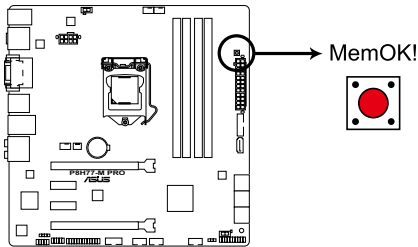

**P8H77-M PRO MemOK! switch**



- Refer to section **2.2.7 Onboard LEDs** for the exact location of the DRAM\_LED.
- The DRAM\_LED also lights up when the DIMM is not properly installed. Turn off the system and reinstall the DIMM before using the MemOK! function.
- The MemOK! switch does not function under the Windows™ OS environment.
- During the tuning process, the system loads and tests failsafe memory settings. It takes about 30 seconds for the system to test one set of failsafe settings. If the test fails, the system reboots and test the next set of failsafe settings. The blinking speed of the DRAM\_LED increases, indicating different test processes.
- Due to memory tuning requirement, the system automatically reboots when each timing set is tested. If the installed DIMMs still fail to boot after the whole tuning process, the DRAM\_LED remains lit. Replace the DIMMs with ones recommended in the Memory QVL (Qualified Vendors Lists) in this user manual or on the ASUS website at [www.asus.com](http://www.asus.com).
- If you turn off the computer and replace DIMMs during the tuning process, the system continues memory tuning after turning on the computer. To stop memory tuning, turn off the computer and unplug the power cord for about 5–10 seconds.
- If your system fail to boot due to BIOS overclocking, press the MemOK! switch to boot and load BIOS default settings. A message will appear during POST reminding you that the BIOS has been restored to its default settings.
- We recommend that you download and update to the latest BIOS version from the ASUS website at [www.asus.com](http://www.asus.com) after using the MemOK! function.

## 2. EPU switch

Turning this switch to **Enable** will automatically detect the current PC loadings and intelligently moderate power consumption.



For ensuring the system performance, turn the switch setting to **Enable** when the system is powered off.

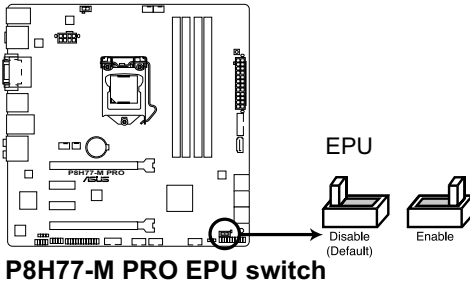

- The EPU LED near the EPU switch lights up when the switch setting is turned to **Enable**. Refer to section 2.2.7 **Onboard LEDs** for the exact location of the EPU LED.
- If you change the switch setting to **Enable** under the OS environment, the EPU function will be activated after the next system bootup.
- You may change or enable the EPU settings from the software application or in the BIOS setup program. However, the system will use the last settings you made.

## 3. GPU Boost switch

This switch allows you to enable or disable the GPU Boost function.

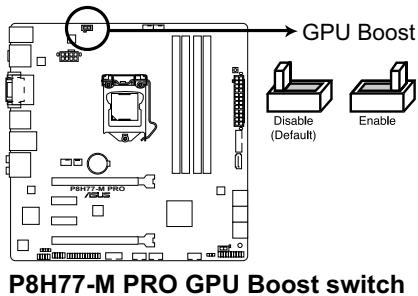



## 2.2.7 Onboard LEDs

### 1. Standby Power LED

The motherboard comes with a standby power LED that lights up to indicate that the system is ON, in sleep mode, or in soft-off mode. This is a reminder that you should shut down the system and unplug the power cable before removing or plugging in any motherboard component. The illustration below shows the location of the onboard LED.

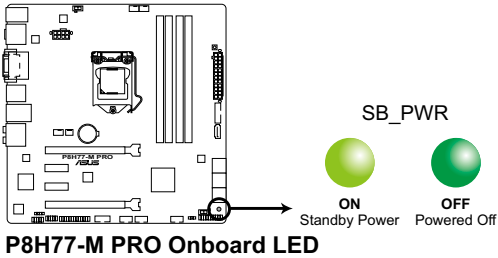

### 2. DRAM LED

The DRAM LED checks the DRAM in sequence during the motherboard boot process. If an error is found, the LED next to the error device will remain lit until the problem is solved. This user-friendly design provides an easy way to identify problems related to the DRAM.

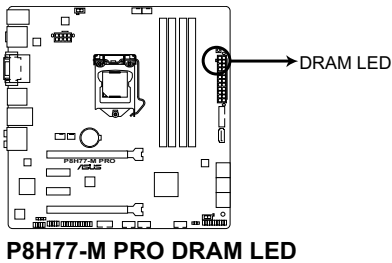

### 3. EPU LED

The EPU LED lights up when the EPU switch is changed to **Enable**.

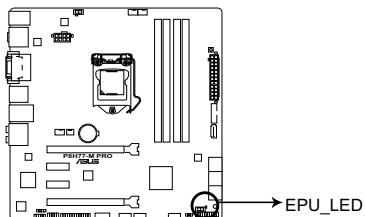

**P8H77-M PRO EPU LED**

### 4. GPU Boost LED

The GPU Boost LED lights up when the GPU Boost switch is changed to **Enable**.

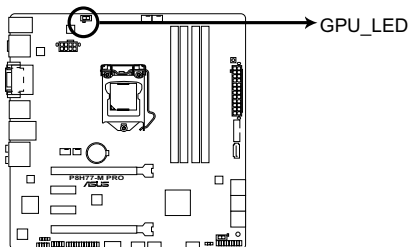

**P8H77-M PRO GPU Boost LED**

## 2.2.8 Internal connectors

### 1. Intel® H77 Serial ATA 6.0Gb/s connectors (7-pin SATA6G\_1/2 [gray])

These connectors connect to Serial ATA 6.0 Gb/s hard disk drives via Serial ATA 6.0 Gb/s signal cables.

If you installed Serial ATA hard disk drives, you can create a RAID 0, 1, 5, and 10 configuration with the Intel® Rapid Storage Technology through the onboard Intel® H77 chipset.

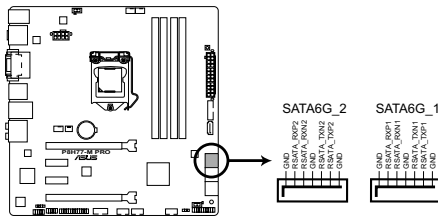

**P8H77-M PRO Intel® SATA 6.0Gb/s connectors**

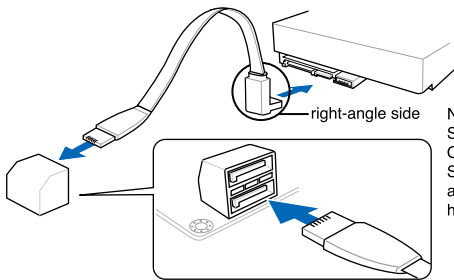

**NOTE:** Connect the right-angle side of SATA signal cable to SATA device. Or you may connect the right-angle side of SATA cable to the onboard SATA port to avoid mechanical conflict with huge graphics cards.



- These connectors are set to [AHCI Mode] by default. If you intend to create a Serial ATA RAID set using these connectors, set the **SATA Mode** item in the BIOS to [RAID Mode]. Refer to section **3.5.3 SATA Configuration** for details.
- Before creating a RAID set, refer to section **4.5 RAID configurations** or the manual bundled in the motherboard support DVD.
- When using NCQ, set the **SATA Mode** in the BIOS to [AHCI Mode]. Refer to section **3.5.3 SATA Configuration** for details.
- You must install Windows® XP Service Pack 3 or later versions before using Serial ATA hard disk drives. The Serial ATA RAID feature is available only if you are using Windows® XP SP3 or later versions.

## 2. Intel® H77 Serial ATA 3.0Gb/s connectors (7-pin SATA3G\_1~4 [blue])

These connectors connect to Serial ATA 3.0 Gb/s hard disk drives and optical drives via Serial ATA 3.0 Gb/s signal cables.

If you installed Serial ATA hard disk drives, you can create a RAID 0, 1, 5, and 10 configuration with the Intel® Rapid Storage Technology through the onboard Intel® H77 chipset.

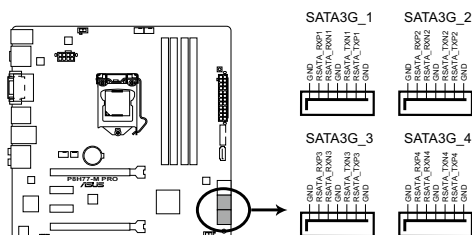

**P8H77-M PRO Intel® SATA 3.0Gb/s connectors**



- These connectors are set to [AHCI Mode] by default. If you intend to create a Serial ATA RAID set using these connectors, set the **SATA Mode** item in the BIOS to [RAID Mode]. Refer to section **3.5.3 SATA Configuration** for details.
- Before creating a RAID set, refer to section **4.5 RAID configurations** or the manual bundled in the motherboard support DVD.
- When using NCQ, set the **SATA Mode** in the BIOS to [AHCI Mode]. Refer to section **3.5.3 SATA Configuration** for details.
- You must install Windows® XP Service Pack 3 or later versions before using Serial ATA hard disk drives. The Serial ATA RAID feature is available only if you are using Windows® XP SP3 or later versions.

### 3. Marvell® Serial ATA 6.0Gb/s connectors (7-pin SATA6G\_E1 [navy blue])

This connector connects to Serial ATA 6.0 Gb/s hard disk drives via Serial ATA 6.0 Gb/s signal cables.

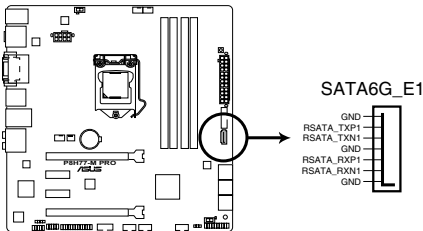

#### P8H77-M PRO Marvell® SATA 6.0 Gb/s connectors



- The SATA6G\_E1 (navy blue) connectors are for data drives only. ATAPI devices are not supported.
- You must install Windows® XP Service Pack 3 or later versions before using Serial ATA hard disk drives.
- When using NCQ, set the **Marvell Storage Controller** item in the BIOS to [Enabled]. Refer to section 3.5.6 **Onboard Devices Configuration** for details.

### 4. USB 3.0 connector (20-1 pin USB3\_34)

This connector is for additional USB 3.0 ports, and complies with the USB 3.0 specification that supports up to 4.8Gbps connection speed. If the USB 3.0 front panel cable is available on your system chassis, this USB 3.0 connector can be used to install USB 3.0 ports on the front panel.

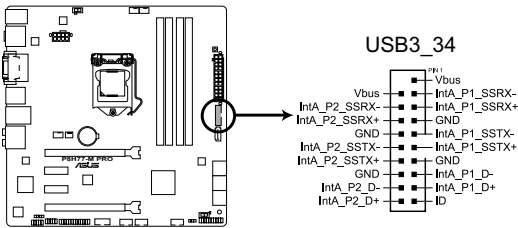

#### P8H77-M PRO USB3.0 Front panel connector



You can connect the ASUS front panel USB 3.0 bracket to this connector.



The USB 3.0 bracket is purchased separately.

## 5. USB 2.0 connectors (10-1 pin USB 5 ~ 10)

These connectors are for USB 2.0 ports. Connect the USB module cable to any of these connectors, then install the module to a slot opening at the back of the system chassis. These USB connectors comply with USB 2.0 specification supporting up to 480 Mbps connection speed.

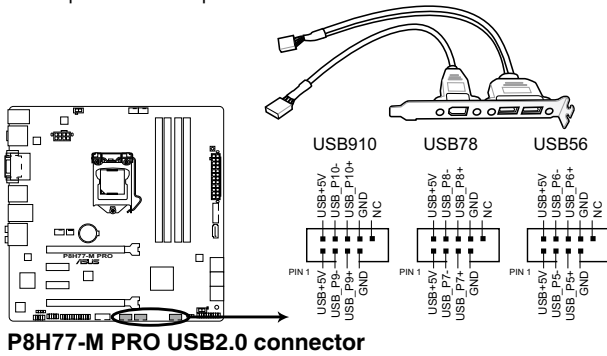

Never connect a 1394 cable to the USB connectors. Doing so will damage the motherboard!



You can connect the front panel USB cable to the ASUS Q-Connector (USB, blue) first, and then install the Q-Connector (USB) to the USB connector onboard if your chassis supports front panel USB ports.



The USB 2.0 module is purchased separately.

## 6. Digital audio connector (4-1 pin SPDIF\_OUT)

This connector is for an additional Sony/Philips Digital Interface (S/PDIF) port(s). Connect the S/PDIF Out module cable to this connector, then install the module to a slot opening at the back of the system chassis.

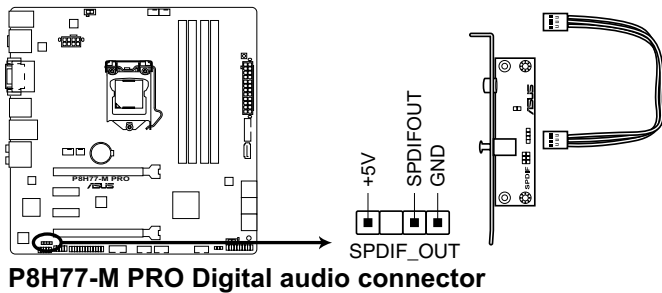

The S/PDIF module is purchased separately.

## 7. Front panel audio connector (10-1 pin AAFP)

This connector is for a chassis-mounted front panel audio I/O module that supports either HD Audio or legacy AC'97 audio standard. Connect one end of the front panel audio I/O module cable to this connector.

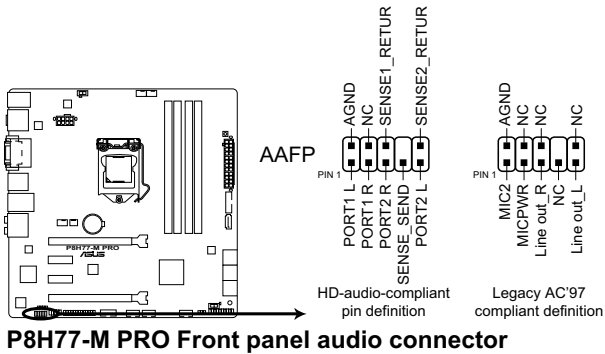

- We recommend that you connect a high-definition front panel audio module to this connector to avail of the motherboard's high-definition audio capability.
- If you want to connect a high-definition front panel audio module to this connector, set the **Front Panel Type** item in the BIOS setup to **[HD]**; if you want to connect an AC'97 front panel audio module to this connector, set the item to **[AC97]**. By default, this connector is set to **[HD]**.

## 8. CPU, chassis, and power fan connectors (4-pin CPU\_FAN; 4-pin CHA\_FAN1/2; 3-pin PWR\_FAN)

Connect the fan cables to the fan connectors on the motherboard, ensuring that the black wire of each cable matches the ground pin of the connector.

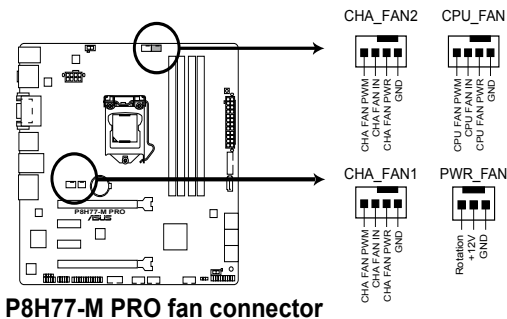



Do not forget to connect the fan cables to the fan connectors. Insufficient air flow inside the system may damage the motherboard components. These are not jumpers! Do not place jumper caps on the fan connectors!



- The CPU\_FAN connector supports the CPU fan maximum of 1A (12 W) fan power.
- Only the CPU\_FAN, CHA\_FAN 1 and CHA\_FAN 2 connectors support the ASUS FAN Xpert feature.
- If you install two VGA cards, we recommend that you plug the rear chassis fan cable to the motherboard connector labeled CHA\_FAN1 or CHA\_FAN2 for better thermal environment.

## 9. LPT connector (26-pin LPT)

The LPT (Line Printing Terminal) connector supports devices such as a printer. LPT standardizes as IEEE 1284, which is the parallel port interface on IBM PC-compatible computers.

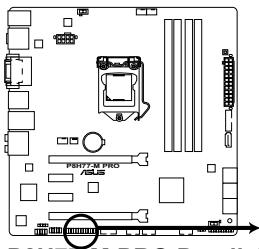

### LPT

GND	SLCT
PE	PE
GND	BUSY
ACK#	ACK#
GND	PD7
PD6	PD6
GND	PD5
PD4	PD4
GND	PD3
PD2	PD2
SLIN#	PD1
INIT#	PD0
ERR#	STB#
AFD	

PIN 1

### P8H77-M PRO Parallel Port Connector



## 10. Serial port connectors (10-1 pin COM1)

The connector is for a serial (COM) port. Connect the serial port module cable to the connector, then install the module to a slot opening at the back of the system chassis.



The serial port bracket (COM1) is purchased separately.

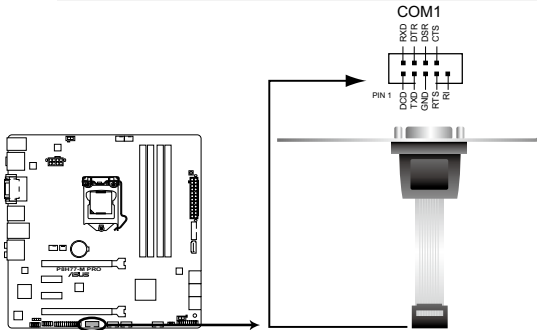

**P8H77-M PRO Serial port (COM1) connector**

## 11. ATX power connectors (24-pin EATXPWR; 8-pin EATX12V)

These connectors are for ATX power supply plugs. The power supply plugs are designed to fit these connectors in only one orientation. Find the proper orientation and push down firmly until the connectors completely fit.

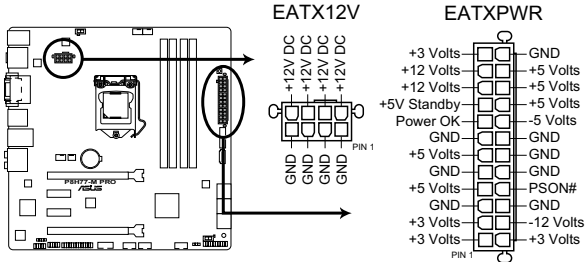

**P8H77-M PRO EATX power connectors**



- For a fully configured system, we recommend that you use a power supply unit (PSU) that complies with ATX 12 V Specification 2.0 (or later version) and provides a minimum power of 350 W.
- DO NOT forget to connect the 4-pin / 8-pin ATX +12V power plug. Otherwise, the system will not boot up.



- We recommend that you use a PSU with higher power output when configuring a system with more power-consuming devices or when you intend to install additional devices. The system may become unstable or may not boot up if the power is inadequate.
- If you are uncertain about the minimum power supply requirement for your system, refer to the Recommended Power Supply Wattage Calculator at <http://support.asus.com/PowerSupplyCalculator/PSCalculator.aspx?SLanguage=en-us> for details.

## 12. System panel connector (20-pin PANEL)

This connector supports several chassis-mounted functions.

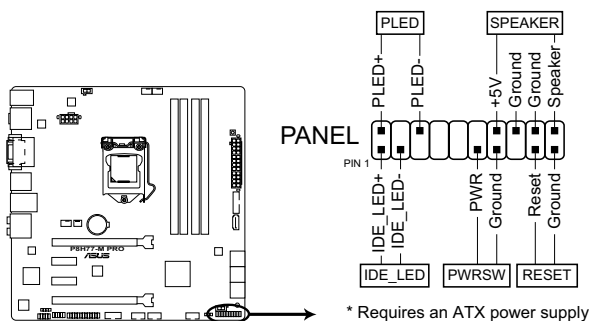

### P8H77-M PRO System panel connector

- **System power LED (2-pin PLED)**

This 2-pin connector is for the system power LED. Connect the chassis power LED cable to this connector. The system power LED lights up when you turn on the system power, and blinks when the system is in sleep mode.

- **Hard disk drive activity LED (2-pin IDE\_LED)**

This 2-pin connector is for the HDD Activity LED. Connect the HDD Activity LED cable to this connector. The IDE LED lights up or flashes when data is read from or written to the HDD.

- **System warning speaker (4-pin SPEAKER)**

This 4-pin connector is for the chassis-mounted system warning speaker. The speaker allows you to hear system beeps and warnings.

- **ATX power button/soft-off button (2-pin PWRSW)**



This connector is for the system power button. Pressing the power button turns the system on or puts the system in sleep or soft-off mode depending on the BIOS settings. Pressing the power switch for more than four seconds while the system is ON turns the system OFF.

- **Reset button (2-pin RESET)**

This 2-pin connector is for the chassis-mounted reset button for system reboot without turning off the system power.

## 2.3 Building your computer system

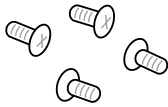
### 2.3.1 Additional tools and components to build a PC system

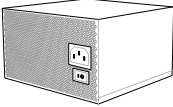
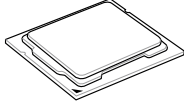
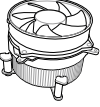
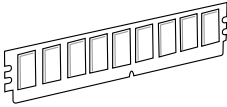
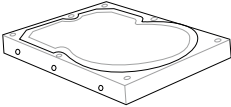
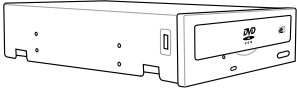
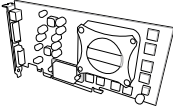
	
<b>1 bag of screws</b>	<b>Philips (cross) screwdriver</b>
	
<b>PC chassis</b>	<b>Power supply unit</b>
	
<b>Intel LGA 1155 CPU</b>	<b>Intel LGA 1155 compatible CPU Fan</b>
	
<b>DIMM</b>	<b>SATA hard disk drive</b>
	
<b>SATA optical disc drive (optional)</b>	<b>Graphics card (optional)</b>



The tools and components in the table above are not included in the motherboard package.

### 2.3.2 CPU installation



The LGA1156 CPU is incompatible with the LGA1155 socket. DO NOT install a LGA1156 CPU on the LGA1155 socket.

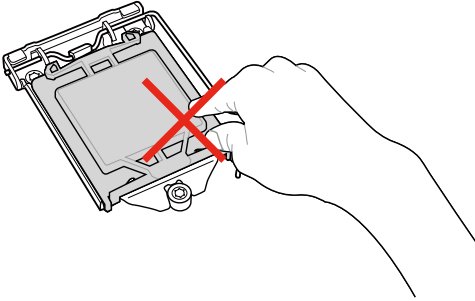

1

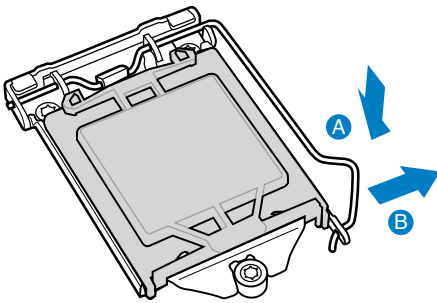

2

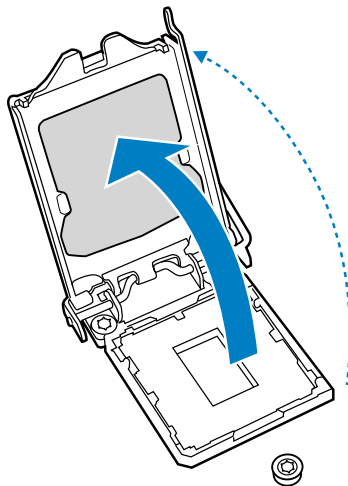

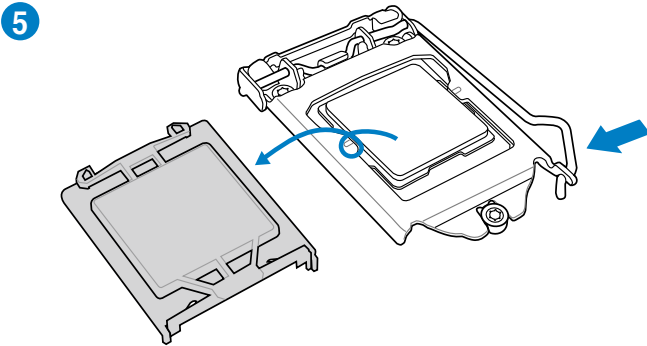
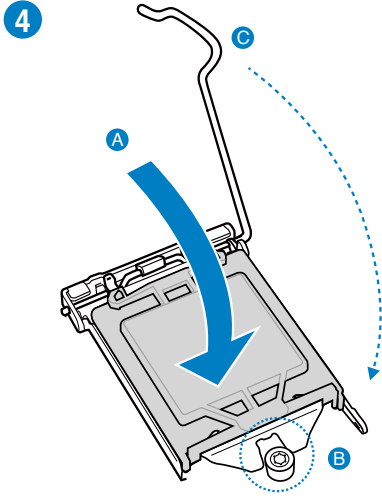
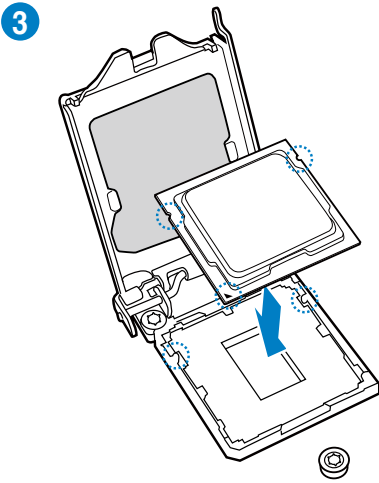

### 2.3.3 CPU heatsink and fan assembly installation

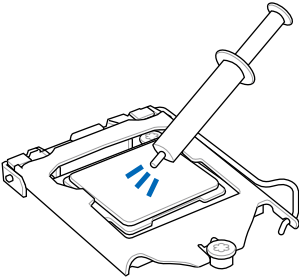

Apply the Thermal Interface Material to the CPU heatsink and CPU before you install the heatsink and fan if necessary.

#### To install the CPU heatsink and fan assembly

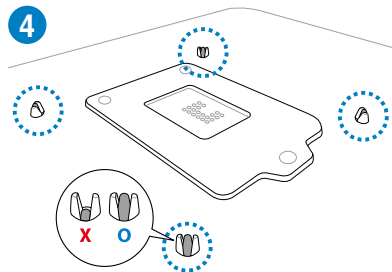
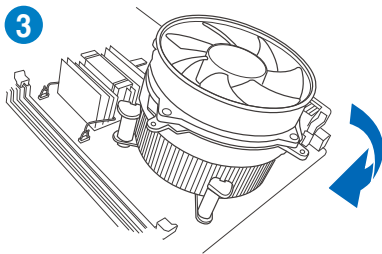
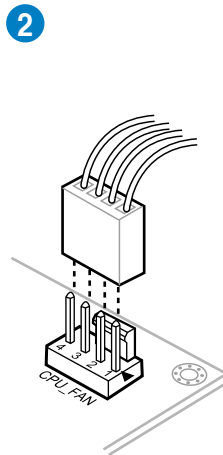
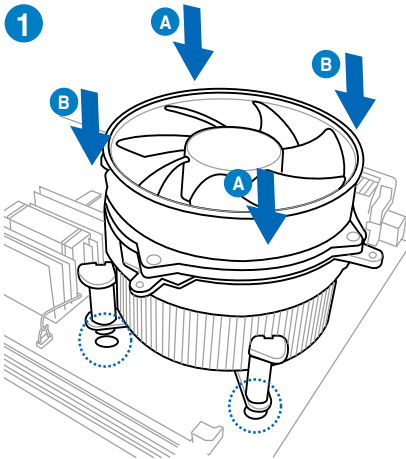

## To uninstall the CPU heatsink and fan assembly

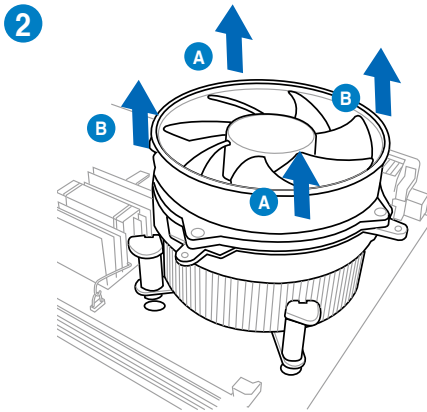
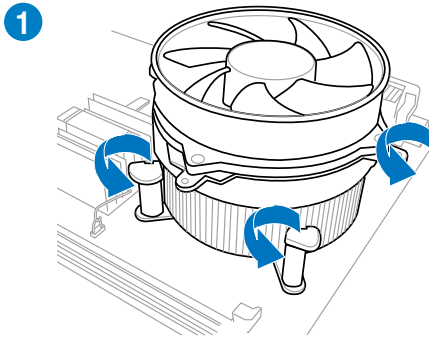

### 2.3.4 DIMM installation

1

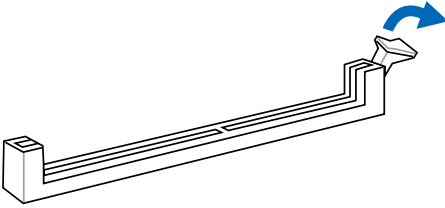

2

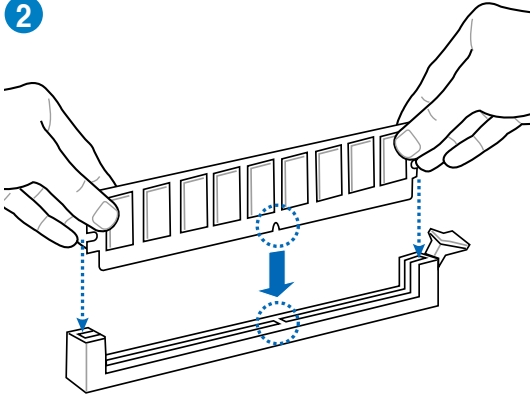

3

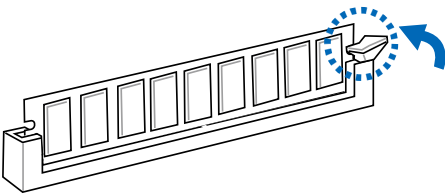

### To remove a DIMM

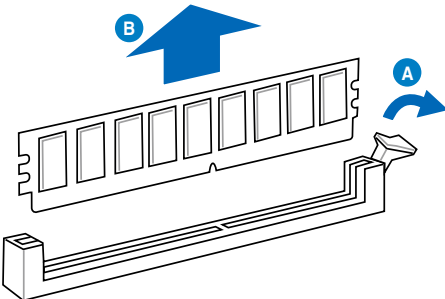



## 2.3.5 Motherboard installation



The diagrams in this section are for reference only. The motherboard layout may vary between models, but the installation steps remain the same.

1

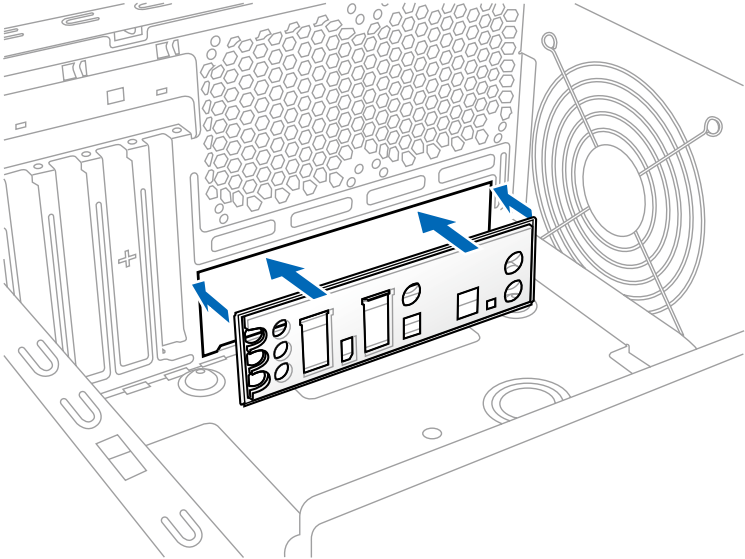

2

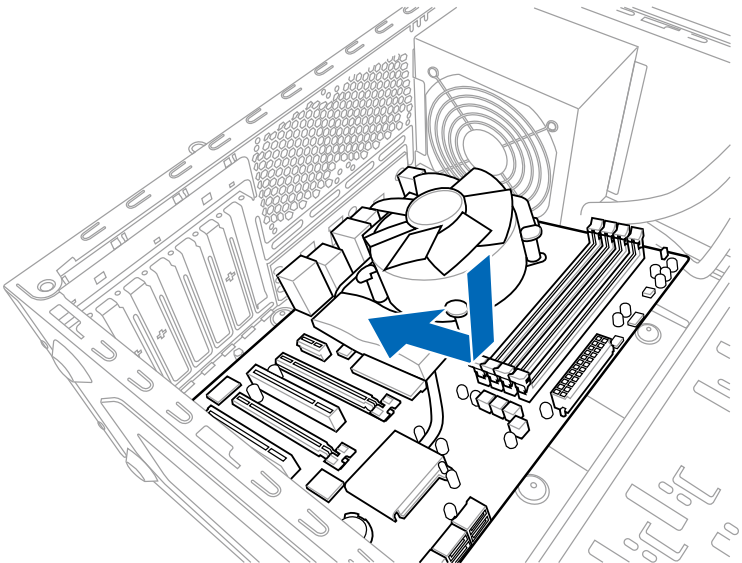

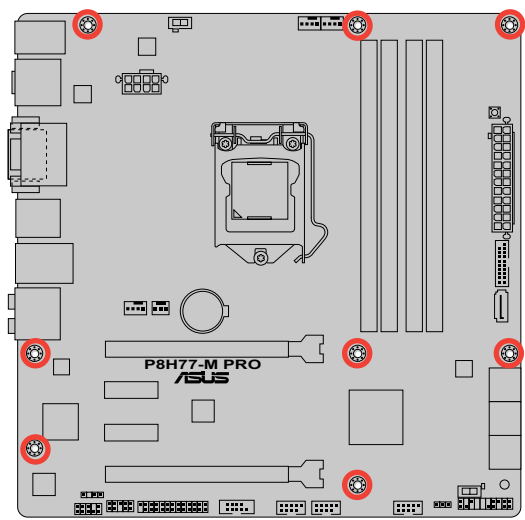
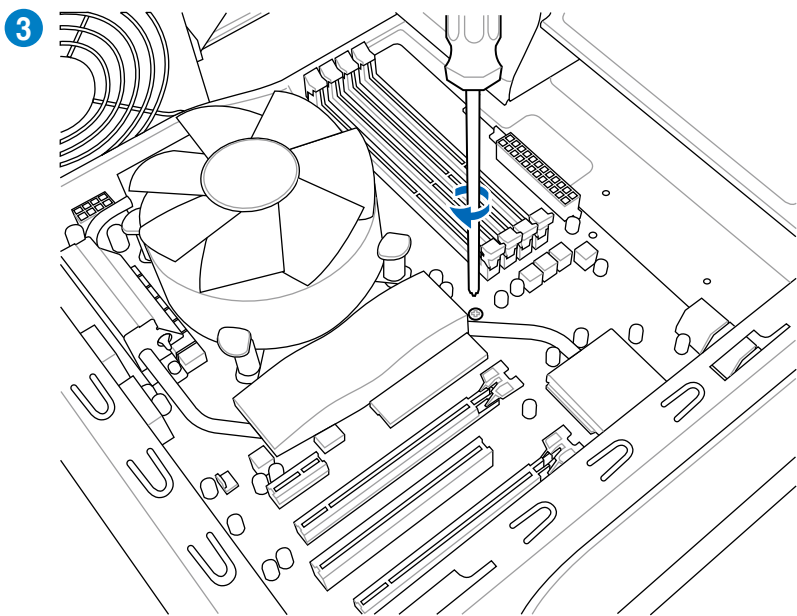

DO NOT overtighten the screws! Doing so can damage the motherboard.

### 2.3.6 ATX Power connection

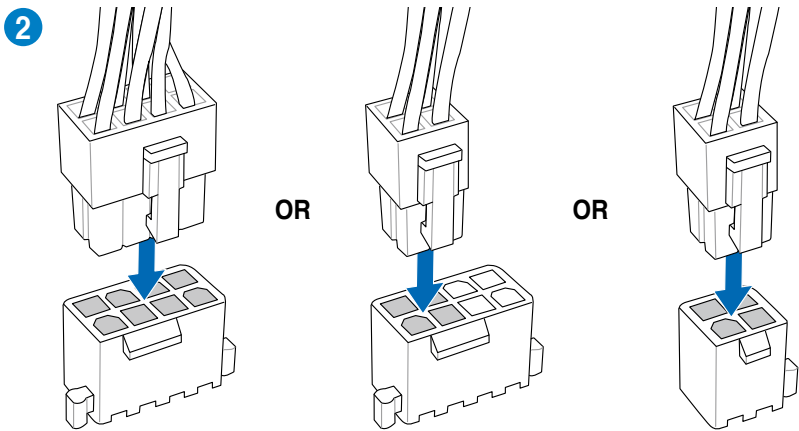
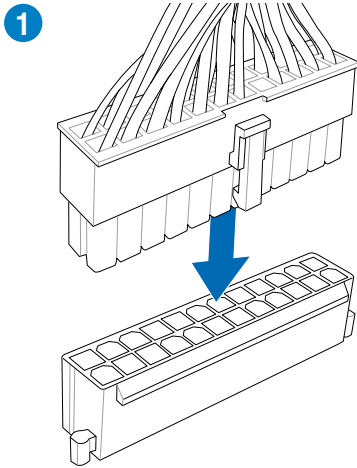

### 2.3.7 SATA device connection

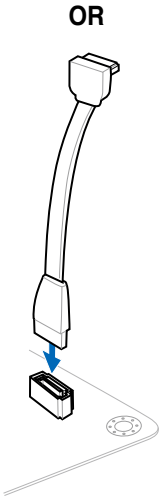
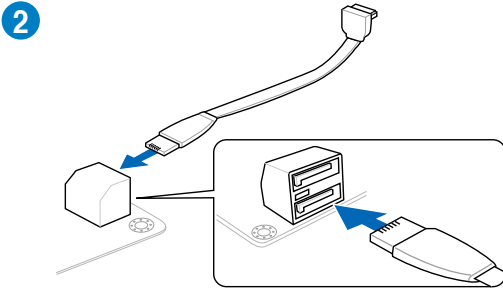
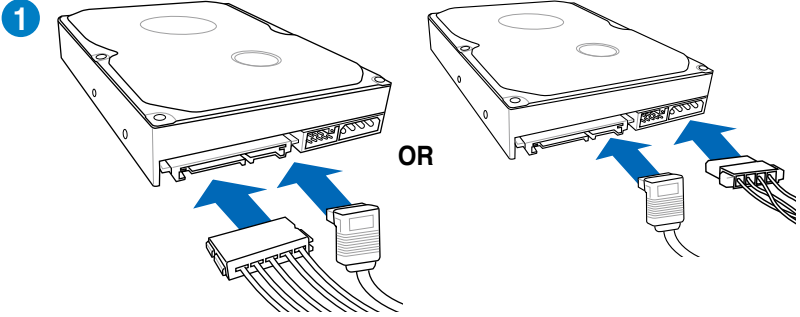

## 2.3.8 Front I/O Connector

### To install ASUS Q-Connector

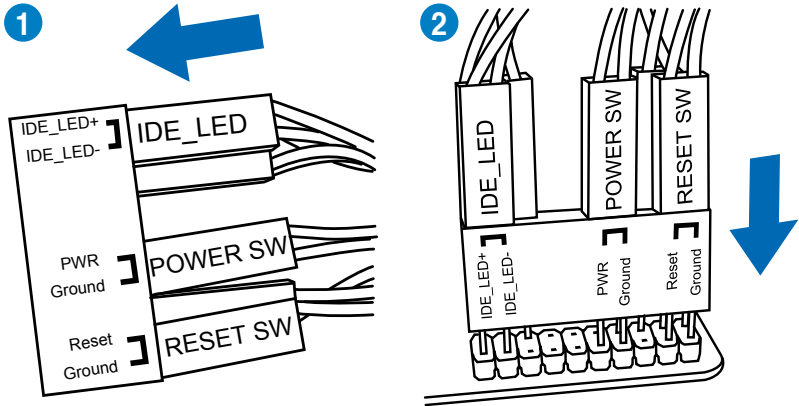

### To install USB 2.0 Connector

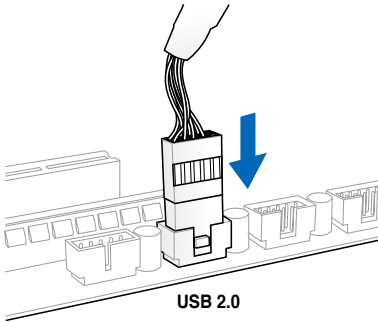

### To install front panel audio connector

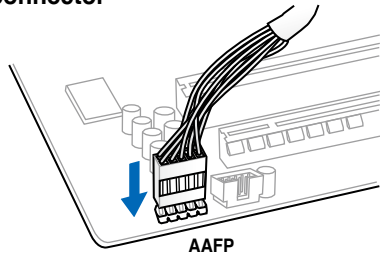

### To install USB 3.0 Connector

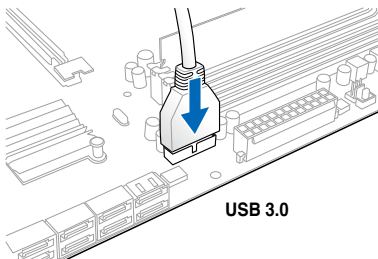

## 2.3.9 Expansion Card installation

### To install PCIe x16 cards

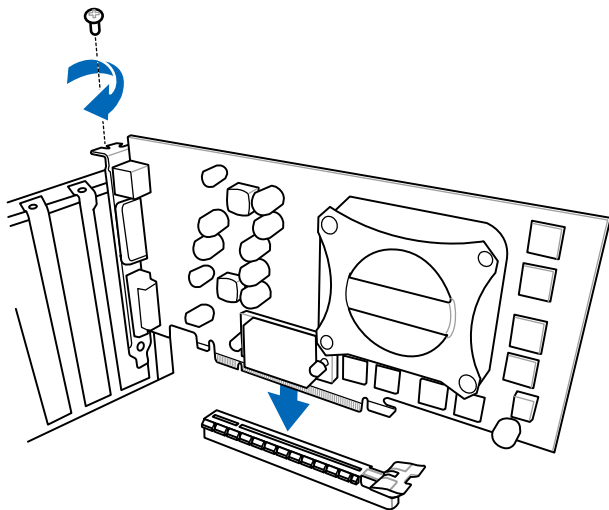

### To install PCIe x1 cards

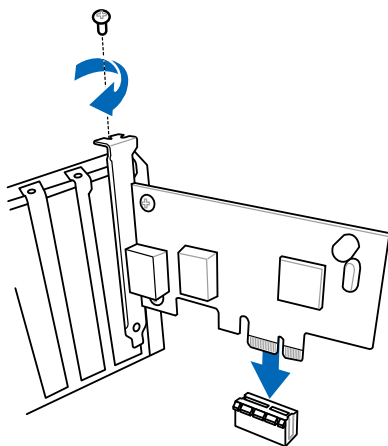

### 2.3.10 Rear panel connection

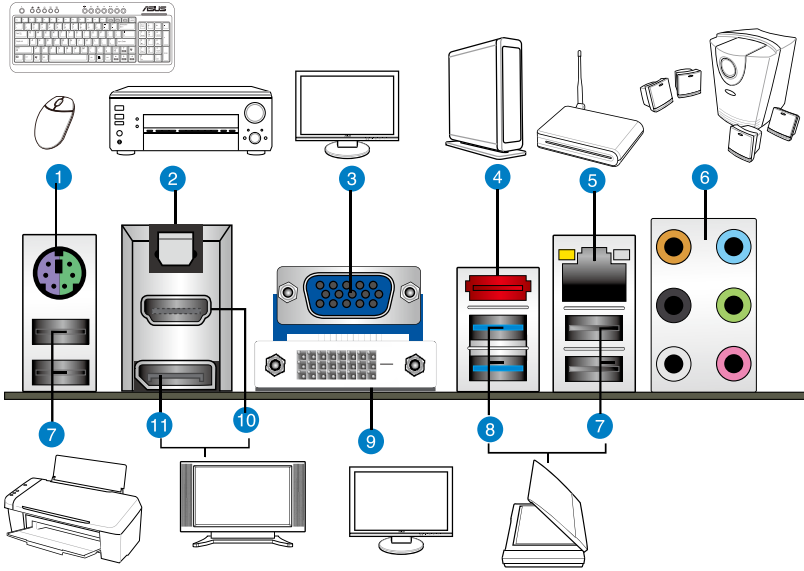

Rear panel connectors	
1. PS/2 Keyboard/Mouse COMBO port	7. USB 2.0 ports 1, 2, 3, 4
2. Optical S/PDIF Out port	8. USB 3.0 ports 1 and 2
3. Video Graphics Adapter (VGA) port	9. DVI port
4. External SATA 6G ports	10. HDMI port
5. LAN (RJ-45) port*	11. DisplayPort
6. Audio I/O ports**	

\* and \*\*: Refer to the tables on the next page for LAN port LED, and audio port definitions.



- DO NOT insert a different connector to the external SATA port.
- Due to USB 3.0 controller limitation, USB 3.0 devices can only be used under Windows® OS environment and after the USB 3.0 driver installation.
- USB 3.0 devices can only be used as data storage only.
- We strongly recommend that you connect USB 3.0 devices to USB 3.0 ports for faster and better performance for your USB 3.0 devices.

**\* LAN ports LED indications**

Activity Link LED		Speed LED	
Status	Description	Status	Description
OFF	No link	OFF	10 Mbps connection
ORANGE	Linked	ORANGE	100 Mbps connection
BLINKING	Data activity	GREEN	1 Gbps connection

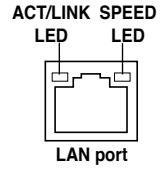

**\*\*Audio 2, 4, 6, or 8-channel configuration**

Port	Headset 2-channel	4-channel	6-channel	8-channel
Light Blue	Line In	Line In	Line In	Line In
Lime	Line Out	Front Speaker Out	Front Speaker Out	Front Speaker Out
Pink	Mic In	Mic In	Mic In	Mic In
Orange	–	–	Center/Subwoofer	Center/Subwoofer
Black	–	Rear Speaker Out	Rear Speaker Out	Rear Speaker Out
Gray	–	–	–	Side Speaker Out



## 2.3.11 Audio I/O connections

### Audio I/O ports

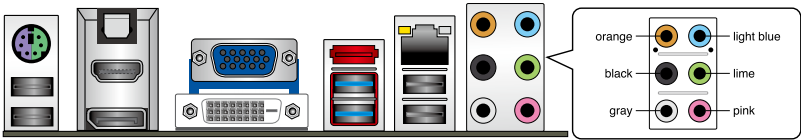

### Connect to Headphone and Mic

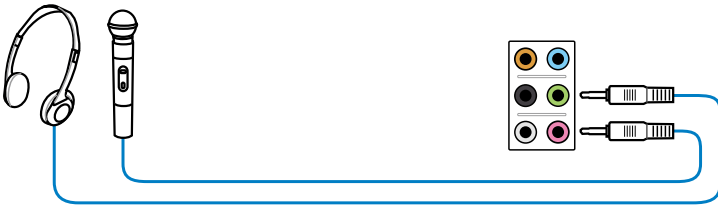

### Connect to Stereo Speakers

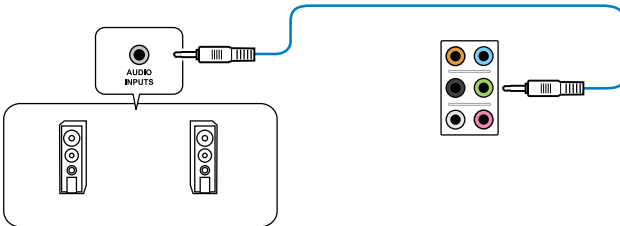

### Connect to 2.1 channel Speakers

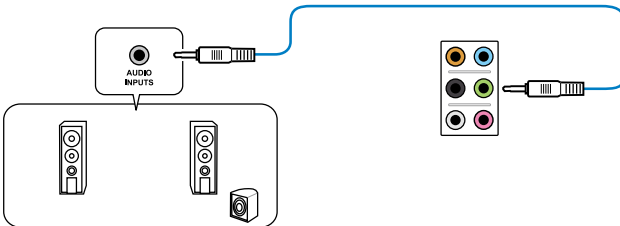

## Connect to 4.1 channel Speakers

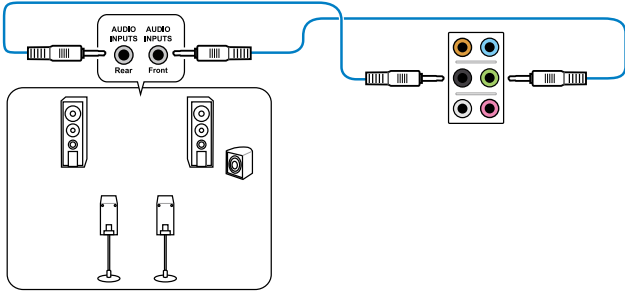

## Connect to 5.1 channel Speakers

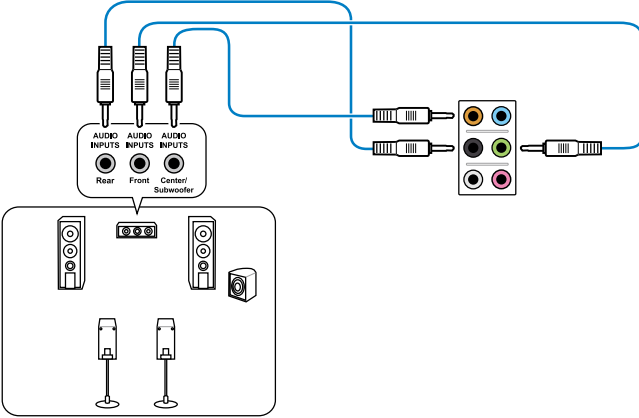

## Connect to 7.1 channel Speakers

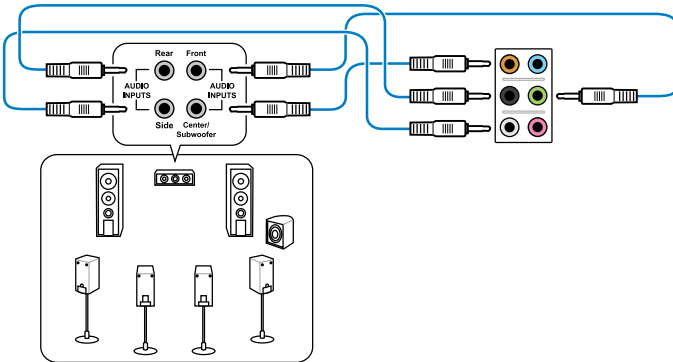

## 2.4 Starting up for the first time

1. After making all the connections, replace the system case cover.
2. Be sure that all switches are off.
3. Connect the power cord to the power connector at the back of the system chassis.
4. Connect the power cord to a power outlet that is equipped with a surge protector.
5. Turn on the devices in the following order:
  - a. Monitor
  - b. External SCSI devices (starting with the last device on the chain)
  - c. System power
6. After applying power, the system power LED on the system front panel case lights up. For systems with ATX power supplies, the system LED lights up when you press the ATX power button. If your monitor complies with the “green” standards or if it has a “power standby” feature, the monitor LED may light up or change from orange to green after the system LED turns on.

The system then runs the power-on self tests or POST. While the tests are running, the BIOS beeps (refer to the BIOS beep codes table below) or additional messages appear on the screen. If you do not see anything within 30 seconds from the time you turned on the power, the system may have failed a power-on test. Check the jumper settings and connections or call your retailer for assistance.

BIOS Beep	Description
One short beep	VGA detected Quick boot set to disabled No keyboard detected
One continuous beep followed by two short beeps then a pause (repeated)	No memory detected
One continuous beep followed by three short beeps	No VGA detected
One continuous beep followed by four short beeps	Hardware component failure

7. At power on, hold down the <Delete> key to enter the BIOS Setup. Follow the instructions in Chapter 3.

## 2.5 Turning off the computer

While the system is ON, pressing the power switch for less than four seconds puts the system on sleep mode or soft-off mode, depending on the BIOS setting. Pressing the power switch for more than four seconds lets the system enter the soft-off mode regardless of the BIOS setting.



# Chapter 3

## 3.1 Knowing BIOS



The ASUS UEFI BIOS offers a user-friendly interface that goes beyond traditional keyboard-only BIOS controls to enable more flexible and convenient mouse input. Users can easily navigate the UEFI BIOS with the same smoothness as their operating system. The term “BIOS” in this user manual refers to “UEFI BIOS” unless otherwise specified.

BIOS (Basic Input and Output System) stores system hardware settings such as storage device configuration, overclocking settings, advanced power management, and boot device configuration that are needed for system startup in the motherboard CMOS. In normal circumstances, the default BIOS settings apply to most conditions to ensure optimum performance. **We recommend that you not change the default BIOS settings** except in the following circumstances:

- An error message appears on the screen during the system bootup and requests you to run the BIOS Setup.
- You have installed a new system component that requires further BIOS settings or update.



Incorrect settings on the BIOS may result in instability or failure to boot. **We strongly recommend that you change the BIOS settings only with the help of a trained service personnel.**

## 3.2 BIOS setup program

A BIOS setup program is provided for BIOS item modification. When you start up the computer, the system provides you with the opportunity to run this program. Press <Del> during the Power-On Self-Test (POST) to enter the Setup utility. Otherwise, POST continues with its test routines.

If you wish to enter Setup after POST, press <Ctrl> + <Alt> + <Delete>, or press the reset button on the system chassis to restart the system. You can also turn the system off and then turn it back on to restart the system. Do this last option only if the first two failed.



- The BIOS setup screens shown in this section are for reference purposes only, and may not exactly match what you see on your screen.
- Ensure that a USB mouse is connected to your motherboard if you want to use the mouse to control the BIOS setup program.
- If the system becomes unstable after changing any BIOS setting, load the default settings to ensure system compatibility and stability. Select the **Load Optimized Defaults** item under the **Exit** menu. See section **3.9 Exit Menu** for details.
- If the system fails to boot after changing any BIOS setting, try to clear the CMOS and reset the motherboard to the default value. See section **2.2.5 Jumper** for information on how to erase the RTC RAM.
- The BIOS setup program does not support the bluetooth devices.

The BIOS setup program is designed to make it as easy to use as possible. Being a menu-driven program, it lets you scroll through the various submenus and select from the available options using a keyboard or a USB mouse.

The BIOS setup program can be used under two modes: **EZ Mode** and **Advanced Mode**. You can change modes from the **Exit** menu or from the **Exit/Advanced Mode** button in the **EZ Mode/Advanced Mode** screen.

### 3.2.1 EZ Mode

By default, the EZ Mode screen appears when you enter the BIOS setup program. The EZ Mode provides you an overview of the basic system information, and allows you to select the display language, system performance mode and boot device priority. To access the Advanced Mode, click **Exit/Advanced Mode**, then select **Advanced Mode**.



The default screen for entering the BIOS setup program can be changed. Refer to the **Setup Mode** item in section 3.7 **Boot menu** for details.

**ASUS UEFI BIOS Utility - EZ Mode**

P8H77-M PRO  
 BIOS Version : 0311  
 CPU Type : Intel(R) Core(TM) i5-2400 CPU @ 3.10GHz Speed : 3100 MHz  
 Total Memory : 1024 MB (DDR3 1033MHz)

Monday 9/13/2010

**Temperature**  
 CPU +113.0°F/+45.0°C  
 MB +75.2°F/+40.0°C

**Voltage**  
 CPU 1.248V 5V 5.160V  
 3.3V 3.344V 12V 12.248V

**Fan Speed**  
 CPU\_FAN 3325RPM CHA\_FAN1 N/A  
 CHA\_FAN2 N/A PWR\_FAN N/A

**System Performance**  
 Quiet Performance Energy Saving Normal

**Boot Priority**  
 Use the mouse to drag or keyboard to navigate to decide the boot priority.

Shortcut (F3) Advanced Mode (F7) Boot Menu (F8) Default (F5)

**Annotations:**

- Selects the display language of the BIOS setup program
- Clicks to display all fan speeds if available
- Displays the CPU/motherboard temperature, CPU/5V/3.3V/12V voltage output, CPU/chassis/power fan speed
- Exits the BIOS setup program without saving the changes, saves the changes and resets the system, or enters the Advanced Mode
- Displays the Advanced mode menus
- Selects the boot device priority
- Power Saving mode
- Normal mode
- Selects the boot device priority
- Loads optimized default
- ASUS Optimal mode
- Selects the Advanced mode functions
- Displays the system properties of the selected mode on the right hand side



- The boot device options vary depending on the devices you installed to the system.
- The **Boot Menu(F8)** button is available only when the boot device is installed to the system.

### 3.2.2 Advanced Mode

The Advanced Mode provides advanced options for experienced end-users to configure the BIOS settings. The figure below shows an example of the Advanced Mode. Refer to the following sections for the detailed configurations.



To access the Advanced Mode, click **Exit**, then select **Advanced Mode**.



#### Menu bar

The menu bar on top of the screen has the following main items:

<b>Main</b>	For changing the basic system configuration
<b>Ai Tweaker</b>	For changing the overclocking settings
<b>Advanced</b>	For changing the advanced system settings
<b>Monitor</b>	For displaying the system temperature, power status, and changing the fan settings.
<b>Boot</b>	For changing the system boot configuration
<b>Tool</b>	For configuring options for special functions
<b>Exit</b>	For selecting the exit options and loading default settings

## Menu items

The highlighted item on the menu bar displays the specific items for that menu. For example, selecting **Main** shows the Main menu items.

The other items (Ai Tweaker, Advanced, Monitor, Boot, Tool, and Exit) on the menu bar have their respective menu items.

## Back button

This button appears when entering a submenu. Press <Esc> or use the USB mouse to click this button to return to the previous menu screen.

## Submenu items

A greater than sign (>) before each item on any menu screen means that the item has a submenu. To display the submenu, select the item and press <Enter>.

## Pop-up window

Select a menu item and press <Enter> to display a pop-up window with the configuration options for that item.

## Scroll bar

A scroll bar appears on the right side of a menu screen when there are items that do not fit on the screen. Press the Up/Down arrow keys or <Page Up> / <Page Down> keys to display the other items on the screen.

## Navigation keys

At the bottom right corner of the menu screen are the navigation keys for the BIOS setup program. Use the navigation keys to select items on the menu and change the settings.

## General help

At the top right corner of the menu screen is a brief description of the selected item. Use <F12> key to capture the BIOS screen and save it to the removable storage device.

## Configuration fields

These fields show the values for the menu items. If an item is user-configurable, you can change the value of the field opposite the item. You cannot select an item that is not user-configurable.

A configurable field is highlighted when selected. To change the value of a field, select it and press <Enter> to display a list of options.



### 3.3 Main menu

The Main menu screen appears when you enter the Advanced Mode of the BIOS Setup program. The Main menu provides you an overview of the basic system information, and allows you to set the system date, time, language, and security settings.



### Security

The Security menu items allow you to change the system security settings.

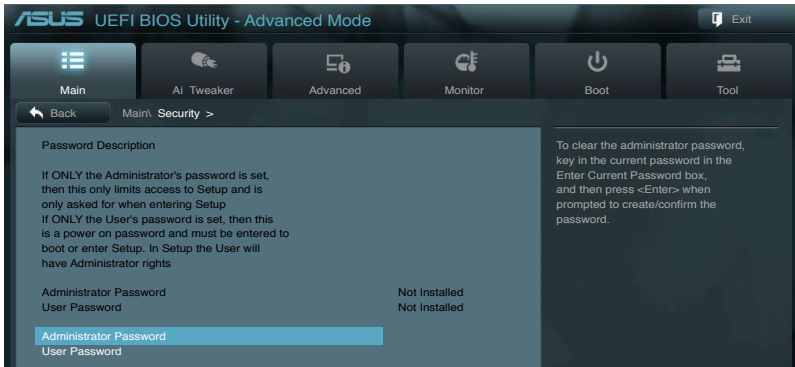

- If you have forgotten your BIOS password, erase the CMOS Real Time Clock (RTC) RAM to clear the BIOS password. See section 2.2.5 Jumper for information on how to erase the RTC RAM.
- The **Administrator** or **User Password** items on top of the screen show the default **Not Installed**. After you set a password, these items show **Installed**.

## Administrator Password

If you have set an administrator password, we recommend that you enter the administrator password for accessing the system. Otherwise, you might be able to see or change only selected fields in the BIOS setup program.

To set an administrator password:

1. Select the **Administrator Password** item and press <Enter>.
2. From the **Create New Password** box, key in a password, then press <Enter>.
3. Confirm the password when prompted.

To change an administrator password:

1. Select the **Administrator Password** item and press <Enter>.
2. From the **Enter Current Password** box, key in the current password, then press <Enter>.
3. From the **Create New Password** box, key in a new password, then press <Enter>.
4. Confirm the password when prompted.

To clear the administrator password, follow the same steps as in changing an administrator password, but press <Enter> when prompted to create/confirm the password. After you clear the password, the **Administrator Password** item on top of the screen shows **Not Installed**.

## User Password

If you have set a user password, you must enter the user password for accessing the system. The **User Password** item on top of the screen shows the default **Not Installed**. After you set a password, this item shows **Installed**.

To set a user password:

1. Select the **User Password** item and press <Enter>.
2. From the **Create New Password** box, key in a password, then press <Enter>.
3. Confirm the password when prompted.

To change a user password:

1. Select the **User Password** item and press <Enter>.
2. From the **Enter Current Password** box, key in the current password, then press <Enter>.
3. From the **Create New Password** box, key in a new password, then press <Enter>.
4. Confirm the password when prompted.

To clear the user password, follow the same steps as in changing a user password, but press <Enter> when prompted to create/confirm the password. After you clear the password, the **User Password** item on top of the screen shows **Not Installed**.

## 3.4 Ai Tweaker menu

The Ai Tweaker menu items allow you to configure overclocking-related items.



Be careful when changing the settings of the Ai Tweaker menu items. Incorrect field values can cause the system to malfunction.



The configuration options for this section vary depending on the CPU and DIMM model you installed on the motherboard.

ASUS UEFI BIOS Utility - Advanced Mode

Main | **Ai Tweaker** | Advanced | Monitor | Boot | Tool

Target CPU Turbo-Mode Speed: xxxMHz  
Target DRAM Speed: xxxMHz

**Ai Overclock Tuner** Auto

CPU bus speed: DRAM speed ratio mode Auto

Memory Frequency Auto

iGPU Max. Frequency Auto

EPU Power Saving Mode Disabled

> GPU Boost  
> DRAM Timing Control  
> CPU Power Management  
> DIGI + VRM

CPU Voltage 1.072V Offset Mode

Offset Mode Sign +

[X.M.P.] When XMP is enabled BCLK frequency, CPU ratio and memory parameters will be auto optimized.

←→: Select Screen  
↑↓: Select Item  
Enter: Select  
+/-: Change Opt.  
F1: General Help  
F2: Previous Values  
F3: Shortcut  
F5: Optimized Defaults  
F10: Save ESC: Exit  
F12: Print Screen

Version 2.10.1208. Copyright (C) 2012 American Megatrends, Inc.

Scroll down to display the following items:

CPU Offset Voltage Auto

iGPU Voltage Offset Mode

iGPU Offset Mode Sign +

iGPU Offset Voltage Auto

DRAM Voltage 1.500V Auto

VCCSA Voltage 0.925V Auto

PCH Voltage 1.050V Auto

CPU PLL Voltage Auto

←→: Select Screen  
↑↓: Select Item  
Enter: Select  
+/-: Change Opt.  
F1: General Help  
F2: Previous Values  
F3: Shortcut  
F5: Optimized Defaults  
F10: Save ESC: Exit  
F12: Print Screen

Version 2.10.1208. Copyright (C) 2012 American Megatrends, Inc.

## Ai Overclock Tuner [Auto]

Allows you to select the CPU overclocking options to achieve the desired CPU internal frequency. Select any of these preset overclocking configuration options:

- [Auto] Loads the optimal settings for the system.
- [Manual] Allows you to individually set overclocking parameters.

## BCLK/PEG Frequency [XXX]

Allows you to adjust the CPU and VGA frequency to enhance the system performance. Use the <+> and <-> keys to adjust the value. You can also key in the desired value using the numeric keypad. The values range from 80.0MHz to 300.0MHz at 1MHz increment.

## CPU bus speed: DRAM speed ratio mode [Auto]

Allows you to set the CPU bus speed to DRAM speed ratio mode. Configuration options: [Auto] [100:100] [100:133]

## iGPU Max. Frequency [xxx]

Allows you to set the iGPU maximum frequency. The values range from xxxMHz (by CPU) to 3000MHz with a 50MHz interval. Use <+> / <-> to adjust the value.

## EPU Power Saving MODE [Disabled]

Allows you to enable or disable the EPU power saving function.  
Configuration options: [Disabled] [Enabled]

## EPU Setting [Auto]

This item appears only when you set the **EPU Power Saving MODE** item to [Enabled.] and allows you to select the EPU power saving mode. Configuration options: [Auto] [Light Power Saving Mode] [Medium Power Saving Mode] [Max Power Saving Mode]

## GPU Boost

GPU Boost automatically overclocks the frequency and voltage of CPU and DRAM for enhancing the system performance. Configuration options: [OK] [Cancel]

## DRAM Timing Control

The sub-items in this menu allow you to set the DRAM timing control features. Use the <+> and <-> keys to adjust the value. To restore the default setting, type [auto] using the keyboard and press the <Enter> key.



---

Changing the values in this menu may cause the system to become unstable! If this happens, revert to the default settings.

---

## CPU Power Management

The sub-items in this menu allow you to set the CPU ratio and features.

### *CPU Ratio [Auto]*

Allows you to manually adjust the maximum non-turbo CPU ratio. Use <+> and <-> keys to adjust the value. The valid value ranges vary according to your CPU model.

Enhanced Intel SpeedStep Technology [Enabled]

Allows you to enable or disable the Enhanced Intel® SpeedStep Technology (EIST).

[Disabled] Disables this function.

[Enabled] The operating system dynamically adjusts the processor voltage and core frequency which may result in decreased average consumption and decreased average heat production.

Turbo Mode [Enabled]

This item appears only when you set the **EIST** item to [Enabled].

[Enabled] Allows processor cores to run faster than marked frequency in specific conditions.

[Disabled] Disables this function.



---

The following three items appear only when you set the **Turbo Mode** items to [Enabled].

---

Long Duration Power Limit [Auto]

Use the <+> and <-> keys to adjust the value.

Long Duration Maintained [Auto]

Use the <+> and <-> keys to adjust the value.

Short Duration Power Limit [Auto]

Use the <+> and <-> keys to adjust the value.

Primary Plane Current Limit [Auto]

Maximum instantaneous current allowed at any given time for CPU cores

Use <+> and <-> key to adjust the value at 0.125A increment. .

Secondary Plane Current Limit [Auto]

Maximum instantaneous current allowed at any given time for Internal Graphics cores.

Use <+> and <-> key to adjust the value at 0.125A increment.

## DIGI+ VRM

### CPU Load-Line Calibration [Auto]

Load-line is defined by Intel VRM spec and affects CPU voltage. The CPU working voltage will decrease proportionally to CPU loading. Higher value gets a higher voltage and better overclocking performance, but increases the CPU and VRM thermal. This item allows you to adjust the voltage range from the following percentages to boost the system performance: 0% (Regular), 25% (Medium), 50% (High), 75% (Ultra High) and 100% (Extreme).

Configuration options: [Auto] [Regular] [Medium] [High] [Ultra High] [Extreme]



---

The actual performance boost may vary depending on your CPU specification.

---

## CPU Fixed Frequency [xxx]

Switching frequency will affect the VRM transient response and component thermal. Setting a higher frequency gets faster transient response. The values range from 200K to 350K with a 50K interval. Use <+>/<-> to adjust the value.

## CPU Power Phase Control [Standard]

Phase number is the number of working VRM phase. Increasing phase number under heavy system loading to get more transient and better thermal performance. Reducing phase number under light system loading to increase VRM efficiency.

[Standard]	Proceeds phase control depending on the CPU loading.
[Optimized]	Loads the ASUS optimized phase tuning profile.
[Extreme]	Proceeds the full phase mode.
[Manual Adjustment]	Allows manual adjustment.



---

DO NOT remove the thermal module when switching to [Manual Adjustment]. The thermal conditions should be monitored.

---

## Manual Adjustment [Medium]

This item appears only when you set the previous item to [Manual Adjustment] and allows you to select manual adjustment mode. Configuration options: [Ultra Fast] [Fast] [Medium] [Regular].

## CPU Power Duty Control [T.Probe]

DIGI + VRM Duty control adjusts the current and thermal conditions of every component's phase. Configuration options:

[T. Probe] - Select to maintain the VRM thermal balance.

[Extreme] - Select to maintain the current VRM balance.

## CPU Current Capability [100%]

Allows you to configure the total power range, and extends the overclocking frequency range simultaneously. Configuration options: [100%] [110%] [120%]



---

Choose a higher value when overclocking, or under a high CPU loading for extra power support.

---

## iGPU Load-line Calibration [Auto]

Load-line Calibration is defined by Intel VRM specifications and affects iGPU voltage. The iGPU working voltage will decrease proportionally to the integrated graphics loading. Higher load-line calibration would get higher voltage and better overclocking performance, but increase the CPU and VRM thermal. This item allows you to adjust the voltage range from the following percentages to boost the system performance: 0% (Regular), 50% (High) and 100% (Extreme). Configuration options: [Auto] [Regular] [High] [Extreme]

## iGPU Current Capability [100%]

Allows you to set the iGPU Current Capability. Configuration options: [100%] [110%] [120%]



Do not remove the thermal module while changing the DIGI+ VRM related parameters . The thermal conditions should be monitored.



Some of the following items are adjusted by typing the desired values using the numeric keypad and press the <Enter> key. You can also use the <+> and <-> keys to adjust the value. To restore the default setting, type [auto] using the keyboard and press the <Enter> key.

## CPU Voltage [Offset Mode]

[Manual Mode] Allows you to set a fixed CPU voltage.

[Offset Mode] Allows you to set the Offset voltage.

### Offset Mode Sign [+]

This item appears only when you set the **CPU Voltage** item to [Offset Mode].

[+] To offset the voltage by a positive value.

[-] To offset the voltage by a negative value.

#### CPU Offset Voltage [Auto]

This item appears only when you set the **CPU Voltage** item to [Offset Mode] and allows you to set the Offset voltage. The values range from 0.005V to 0.635V with a 0.005V interval.

## CPU Manual Voltage [Auto]

This item appears only when you set the **CPU Voltage** item to [Manual Mode] and allows you to set a fixed CPU voltage. The values range from 0.800V to 1.990V with a 0.005V interval.



Refer to the CPU documentation before setting the CPU voltage. Setting a high voltage may damage the CPU permanently, and setting a low voltage may make the system unstable.

## iGPU Voltage [Offset Mode]

[Offset Mode] To offset the voltage by a positive or negative value.

[Manual Mode] Allows you to set a fixed iGPU voltage.

### iGPU Offset Mode Sign [+]

This item appears only when you set the **iGPU Voltage** item to [Offset Mode].

[+] To offset the voltage by a positive value.

[-] To offset the voltage by a negative value.

#### iGPU Offset Voltage [Auto]

This item appears only when you set the **iGPU Voltage** item to [Offset Mode] and allows you to set the iGPU Offset voltage. The values range from 0.005V to 0.635V with a 0.005V interval.

## iGPU Manual Voltage [Auto]

This item appears only when you set the **iGPU Voltage** item to [Manual Mode] and allows you to set a fixed iGPU voltage. Use the <+> and <-> keys to adjust the value. The values range from 0.800V to 1.990V with a 0.005V interval.

## DRAM Voltage [Auto]

Allows you to set the DRAM voltage. The values range from 1.185V to 2.135V with a 0.005V interval.



According to Intel CPU spec, DIMMs with voltage requirement over 1.65V may damage the CPU permanently. We recommend you install the DIMMs with the voltage requirement below 1.65V.

	Black	Yellow	Pink	Red
<b>CPU Offset Voltage</b>	0.005V– 0.065V	0.070V– 0.125V	0.130V– 0.185V	0.190V– 0.635V
<b>iGPU Mode Voltage</b>	0.005V– 0.035V	0.040V– 0.065V	0.070V– 0.095V	0.100V– 0.635V
<b>DRAM Voltage</b>	1.185V– 1.575V	1.580V– 1.650V	1.655V– 1.725V	1.730V– 2.135V
<b>VCCSA Voltage</b>	0.610V– 0.970V	0.975V– 1.015V	1.020V– 1.060V	1.065V– 1.560V
<b>PCH Voltage</b>	0.735V– 1.100V	1.105V– 1.155V	1.160V– 1.205V	1.210V– 1.7685V



## 3.5 Advanced menu

The Advanced menu items allow you to change the settings for the CPU and other system devices.



Be cautious when changing the settings of the Advanced menu items. Incorrect field values can cause the system to malfunction.

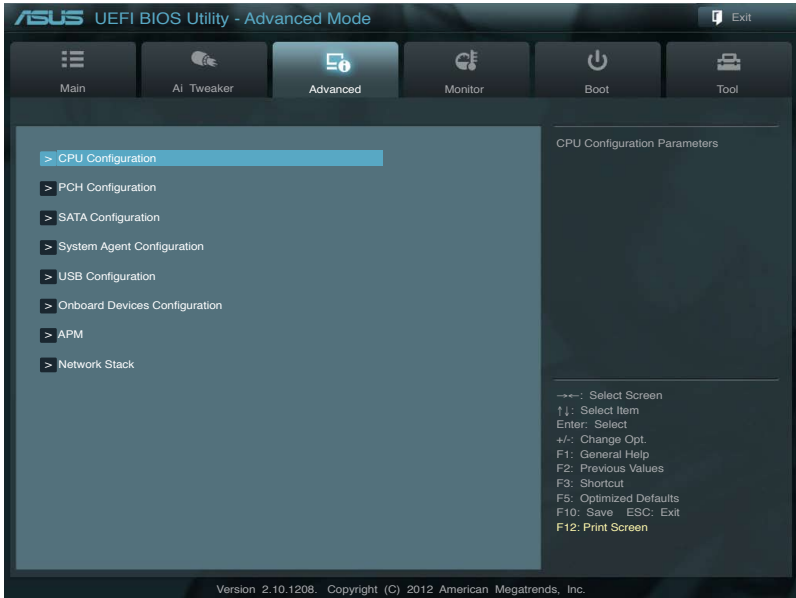

### 3.5.1 CPU Configuration

The items in this menu show the CPU-related information that the BIOS automatically detects.



The items shown in this screen may be different due to the CPU you installed.



Scroll down to display the following items:



#### Intel Adaptive Thermal Monitor [Enabled]

- [Enabled] Enables the overheated CPU to throttle its clock speed to cool down.
- [Disabled] Disables the CPU thermal monitor function.

#### Active Processor Cores [All]

Allows you to choose the number of CPU cores to activate in each processor package. Configuration options: [All] [1] [2] [3]

#### Limit CPUID Maximum [Disabled]

- [Enabled] Allows legacy operating systems to boot even without support for CPUs with extended CPUID functions.
- [Disabled] Disables this function.

**Execute Disable Bit [Enabled]**

[Enabled] Enables the No-Execution Page Protection Technology.

[Disabled] Forces the XD feature flag to always return to zero (0).

**Intel® Virtualization Technology [Disabled]**

[Enabled] Allows a hardware platform to run multiple operating systems separately and simultaneously, enabling one system to virtually function as several systems.

[Disabled] Disables this function.

**Hardware Prefetcher [Enabled]**

[Enabled] Allows a hardware platform to run multiple operating systems separately and simultaneously, enabling one system to virtually function as several systems.

[Disabled] Disables this function.

**Adjacent Cache Line Prefetch [Enabled]**

[Enabled] Allows a hardware platform to perform adjacent cache line prefetching.

[Disabled] Disables this function.

**CPU Power Management Configuration****CPU Ratio [Auto]**

Allows you to set the ratio between the CPU Core Clock and the BCLK Frequency. Use <+> and <-> keys to adjust the ratio. The valid value ranges vary according to your CPU model.

**Enhanced Intel SpeedStep Technology [Enabled]**

Allows you to enable or disable the Enhanced Intel® SpeedStep Technology (EIST).

[Disabled] The CPU runs at its default speed.

[Enabled] The operating system controls the CPU speed.

**Turbo Mode [Enabled]**

This item appears only when you set the **Enhanced Intel SpeedStep Technology** item to **[Enabled]** and allows you to enable or disable the Intel® Turbo Mode Technology.

[Enabled] Allows processor cores to run faster than marked frequency in specific condition.

[Disabled] Disables this function.

**CPU C1E [Auto]**

[Enabled] Enables the C1E support function. This item should be enabled in order to enable the Enhanced Halt State.

[Disabled] Disables this function.

## CPU C3 Report [Auto]

Allows you to disable or enable the CPU C3 report to OS.

## CPU C6 Report [Auto]

Allows you to disable or enable the CPU C6 report to OS.

### 3.5.2 PCH Configuration

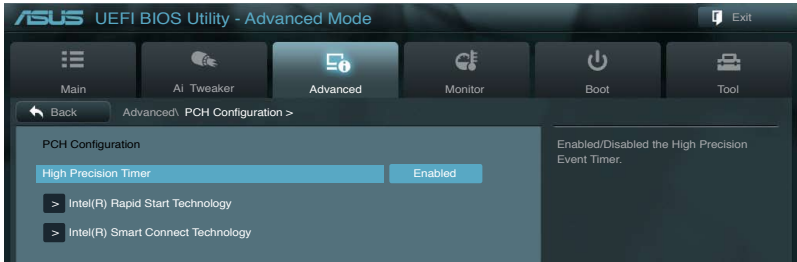

#### High Precision Timer [Enabled]

Allows you to enable or disable the High Precision Event Timer. Configuration options: [Enabled] [Disabled]

#### Intel(R) Rapid Start Technology

##### Intel(R) Rapid Start Technology [Disabled]

Allows you to enable or disable the Intel(R) Rapid Start Technology. Configuration options: [Enabled] [Disabled]



The following three items appear only when you set the **Intel(R) Rapid Start Technology** to [Enabled].

##### Entry on S3 RTC Wake [Enabled]

Allows you to enable or disable the iFFS invocation upon S3 RTC wake. Configuration options: [Enabled] [Disabled]

##### Entry After [10 Minutes]

This item appears only when you set the **Entry on S3 RTC Wake** to [Enabled] and allows you to set the RTC wake timer at S3 entry. Configuration options: [Immediately] [1 minute] [2 minute] [5 minute] [10 minute] [15 minute] [30 minute] [1 hour] [2 hours]

### Active Page Threshold Support [Disbaled]

Allows you to enable or disable the Active Page Threshold Support. Configuration options: [Enabled] [Disabled]

### Active Memory Threshold [x]

This item appears only when you set the **Active Page Threshold Support** to [Enabled] and allows you to set the Active Memory Threshold. When the partition size is larger than the Active Page Threshold size, the system will try to support the Intel(R) Rapid Start Technology. When the item is set to zero, the system automatically checks whether the partition size is enough at S3 entry. Key in the desired value using the numeric keypad.

## **Intel(R) Smart Connect Technology**

### **ISCT Configuration [Disabled]**

Allows you to enable or disable the ISCT configuration. Configuration options: [Enabled] [Disabled]

### 3.5.3 SATA Configuration

While entering Setup, the BIOS automatically detects the presence of SATA devices. The SATA Port items show **Not Present** if no SATA device is installed to the corresponding SATA port.

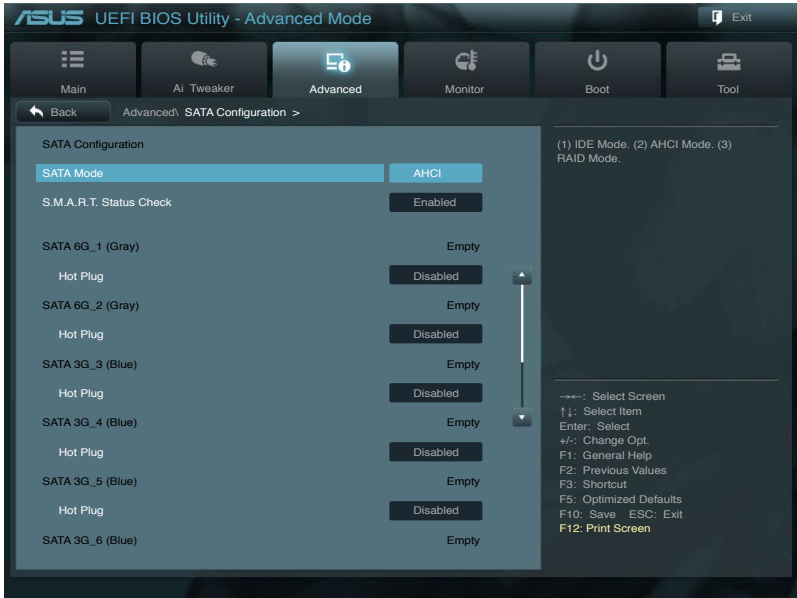

Scroll down to display the following items:

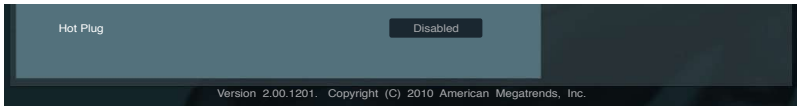

#### SATA Mode Selection [IDE Mode]

Allows you to set the SATA configuration.

[IDE Mode] Set to [IDE Mode] when you want to use the Serial ATA hard disk drives as Parallel ATA physical storage devices.

[AHCI Mode] Set to [AHCI Mode] when you want the SATA hard disk drives to use the AHCI (Advanced Host Controller Interface). The AHCI allows the onboard storage driver to enable advanced Serial ATA features that increases storage performance on random workloads by allowing the drive to internally optimize the order of commands.

[RAID Mode] Set to [RAID Mode] when you want to create a RAID configuration from the SATA hard disk drives.

## S.M.A.R.T. Status Check [Enabled]

S.M.A.R.T. (Self-Monitoring, Analysis and Reporting Technology) is a monitor system. When read/write of your hard disk errors occur, this feature allows the hard disk to report warning messages during the POST. Configuration options: [Enabled] [Disabled]

## Hot Plug [Disabled]

These items appear only when you set the **SATA mode** item to [AHCI Mode] or [RAID Mode], and allow you to enable/disable SATA Hot Plug Support. Configuration options: [Disabled] [Enabled]

### 3.5.4 System Agent Configuration

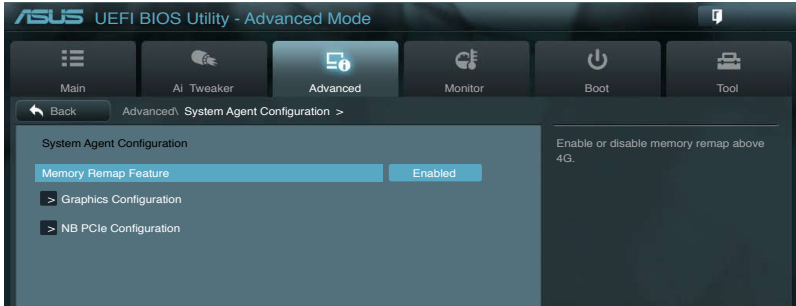

## Memory Remap Feature [Enabled]

[Enabled] Allow you to enable remapping the memory above 4GB.

[Disabled] Disables this function.

## Graphics Configuration

### Primary Display [Auto]

Allows you to decide which graphics controller to use as the primary boot device.

Configuration options: [Auto] [iGFX] [PEG]

### iGPU Memory [64M]

Allows you to set the iGPU memory size. Configuration options: [32M] [64M] [96M]

[128M] ~ [448M] [480M] [512M]

### Render Standby [Enabled]

Allows you to enable or disable Render Standby by internal graphics devices.

Configuration options: [Enabled] [Disabled]

### Initiate iGPU [Enabled]

Allows you to enable or disable the Lucid Virtu support for both the integrated and discrete graphics. The iGPU shared memory size will be fixed at 64MB. Configuration options: [Disabled] [Enabled]

## NB PCIe Configuration

Allows you to configure the NB PCI Express settings.

### PCIE X16\_1 Link Speed [Auto]

Allows you to configure the PCIE X16\_1 link speed. Configuration options: [Auto] [Gen1] [Gen2]

## 3.5.5 USB Configuration

The items in this menu allow you to change the USB-related features.

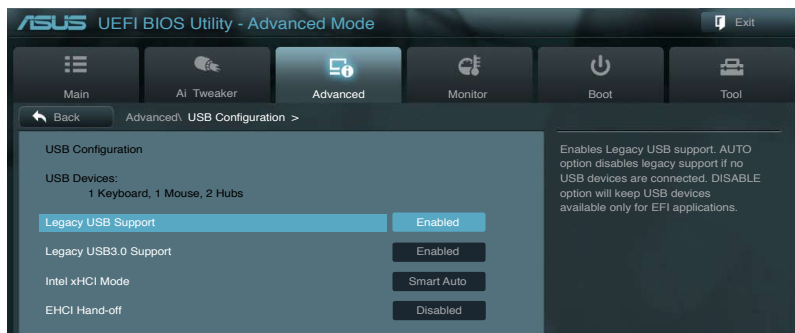

The **USB Devices** item shows the auto-detected values. If no USB device is detected, the item shows **None**.

### Legacy USB Support [Enabled]

- [Enabled] Enables the support for USB devices on legacy operating systems (OS).
- [Disabled] The USB devices can be used only for the BIOS setup program.
- [Auto] Allows the system to detect the presence of USB devices at startup. If detected, the USB controller legacy mode is enabled. If no USB device is detected, the legacy USB support is disabled.

### Legacy USB3.0 Support [Enabled]

This item appears only when you set the previous item to [Enabled] or [Auto] and allows you to enable or disable the legacy USB3.0 support. Configuration options: [Enabled] [Disabled]

- [Enabled] Enables the support for USB 3.0 devices on legacy operating systems (OS).
- [Disabled] Disables the function.

### Intel xHCI Mode [Smart Auto]

Allows you to select an operation mode for the Intel xHCI controller. Configuration options: [Smart Auto] [Auto] [Enabled] [Disabled]

### EHCI Hand-off [Disabled]

- [Enabled] Enables the support for operating systems without an EHCI hand-off feature.
- [Disabled] Disables the function.



## 3.5.6 Onboard Devices Configuration

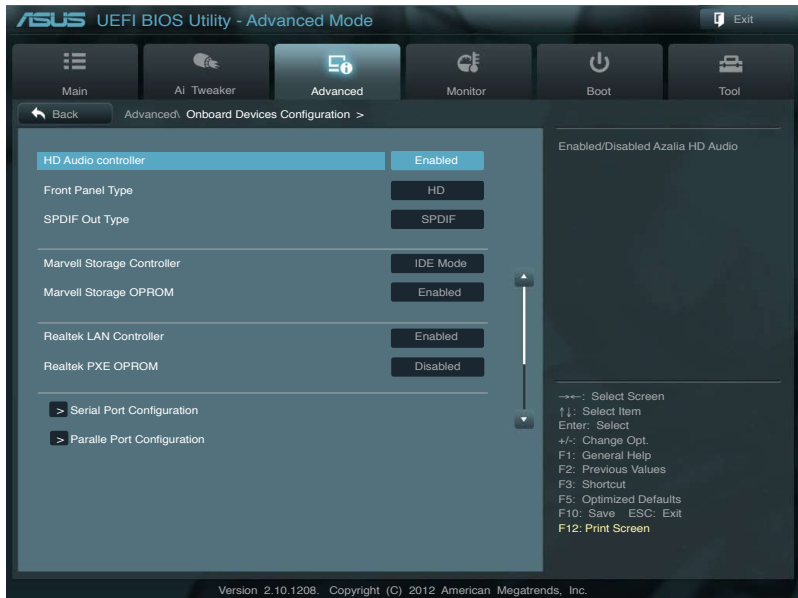

### HD Audio Controller [Enabled]

[Enabled] Enables the High Definition Audio Controller.

[Disabled] Disables the controller.



The following two items appear only when you set the **HD Audio Controller** item to [Enabled].

### Front Panel Type [HD]

Allows you to set the front panel audio connector (AAFP) mode to legacy AC'97 or high-definition audio depending on the audio standard that the front panel audio module supports.

[HD] Sets the front panel audio connector (AAFP) mode to high definition audio.

[AC97] Sets the front panel audio connector (AAFP) mode to legacy AC'97

### SPDIF Out Type [SPDIF]

[SPDIF] Sets to [SPDIF] for SPDIF audio output.

[HDMI] Sets to [HDMI] for HDMI audio output.

### Marvell Storage Controller [IDE Mode]

[Disabled] Disables the Marvell storage controller.

[IDE Mode] Sets the Marvell storage controller to IDE mode.

[AHCI Mode] Sets the Marvell storage controller to AHCI mode.

## Marvell Storage OPROM [Enabled]

This item appears only when the **Marvell Storage Controller** item is set to [IDE Mode] or [AHCI Mode] and allows you to enable or disable the Marvell Storage OPROM.

[Enabled] Enables the Marvell Storage OPROM.

[Disabled] Disables the Marvell Storage OPROM.

## Realtek LAN Controller [Enabled]

[Enabled] Enables the Realtek LAN controller.

[Disabled] Disables the controller.

## Realtek PXE OPROM [Disabled]

This item appears only when you set the previous item to [Enabled] and allows you to enable or disable the PXE OptionRom of the Realtek LAN controller.

Configuration options: [Enabled] [Disabled]

## Serial Port Configuration

The sub-items in this menu allow you to set the serial port configuration.

### Serial Port [Enabled]

Allows you to enable or disable the serial port (COM). Configuration options: [Enabled] [Disabled]

### Change Settings [IO=3F8h; IRQ=4]

This item appears only when you set the **Serial Port** to [Enabled] and allows you to select the Serial Port base address. Configuration options: [IO=3F8h; IRQ=4] [IO=2F8h; IRQ=3] [IO=3E8h; IRQ=4] [IO=2E8h; IRQ=3]

## Parallel Port Configuration

The sub-items in this menu allow you to set the parallel port configuration.

### Parallel Port [Enabled]

Allows you to enable or disable the parallel port (LPT). Configuration options: [Enabled] [Disabled]



---

The following two items appear only when you set the **Parallel Port** item to [Enabled].

---

### Change Settings [Auto]

Allows you to select the Parallel Port base address. Configuration options: [Auto] [IO=378h; IRQ=5] [IO=378h; IRQ=5,6,7,9,10,11,12] [IO=278h; IRQ=5,6,7,9,10,11,12] [IO=3BCh; IRQ= 5,6,7,9,10,11,12]

### Device Mode [STD Printer Mode]

Allows you to change the printer port mode. Configuration options: [STD Printer Mode] [SPP Mode] [EPP-1.9 and SPP Mode] [EPP-1.7 and SPP Mode] [ECP Mode] [ECP and EPP 1.9 Mode] [ECP and EPP 1.7 Mode]

## 3.5.7 APM

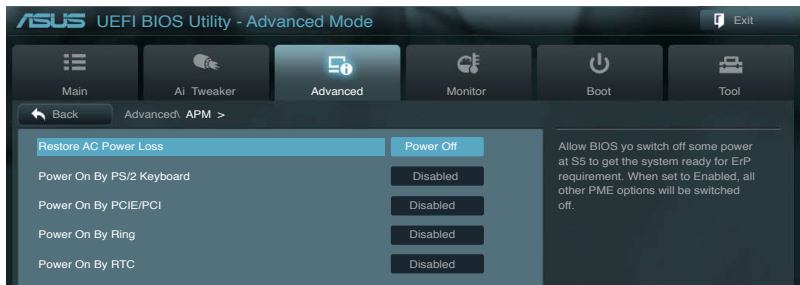

### Restore AC Power Loss [Power Off]

- [Power On] The system goes into on state after an AC power loss.
- [Power Off] The system goes into off state after an AC power loss.
- [Last State] The system goes into either off or on state, whatever the system state was before the AC power loss.

### Power On By PS/2 Keyboard [Disabled]

- [Disabled] Disables the Power On by a PS/2 keyboard.
- [Space Bar] Sets the Space Bar on the PS/2 keyboard to turn on the system.
- [Ctrl-Esc] Sets the Ctrl+Esc key on the PS/2 keyboard to turn on the system.
- [Power Key] Sets Power key on the PS/2 keyboard to turn on the system. This feature requires an ATX power supply that provides at least 1A on the +5VSB lead.

### Power On By PCIE/PCI [Disabled]

- [Disabled] Disables the PCIE/PCI devices to generate a wake-on-LAN feature of the Intel/Realtek LAN device.
- [Enabled] Enables the PCIE/PCI devices to generate a wake-on-LAN feature of the Intel/Realtek LAN device.

### Power On By Ring [Disabled]

- [Disabled] Disables Ring to generate a wake event.
- [Enabled] Enables Ring to generate a wake event.

### Power On By RTC [Disabled]

- [Disabled] Disables RTC to generate a wake event.
- [Enabled] When set to [Enabled], the items **RTC Alarm Date (Days)** and **Hour/Minute/Second** will become user-configurable with set values.

### 3.5.8 Network Stack

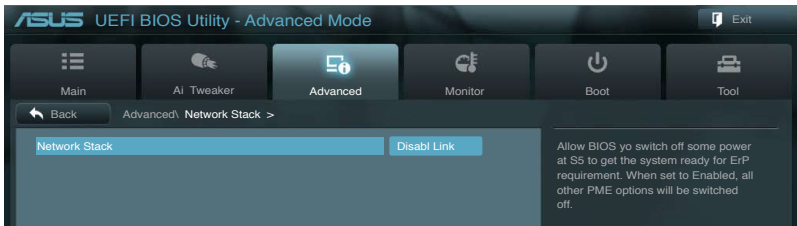

#### Network Stack [Disable Link]

Enables or disables the network stack (Pxe and UEFI). Configuration options: [Disable Link] [Enable]

## 3.6 Monitor menu

The Monitor menu displays the system temperature/power status, and allows you to change the fan settings.

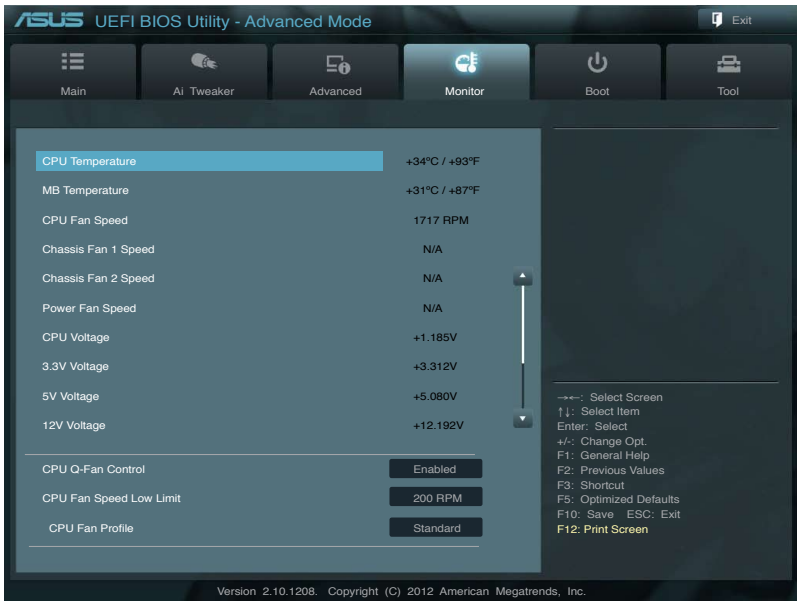

Scroll down to display the following items:

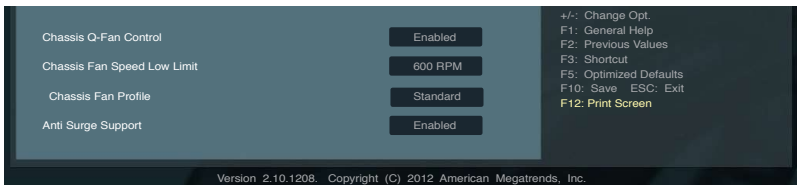

## CPU Temperature / MB Temperature [xxx°C/xxx°F]

The onboard hardware monitor automatically detects and displays the CPU and motherboard temperatures. Select **Ignore** if you do not wish to display the detected temperatures.

## CPU Fan Speed [xxxx RPM] or [Ignore] or [N/A]

## Chasis Fan 1/2 Speed [xxxx RPM] or [Ignore] or [N/A]

## Power Fan Speed [xxxx RPM] or [Ignore] or [N/A]

The onboard hardware monitor automatically detects and displays the CPU, chassis, and power fan speed in rotations per minute (RPM). If the fan is not connected to the motherboard, the field shows **N/A**. Select **Ignore** if you do not wish to display the detected speed.

## CPU Voltage, 3.3V Voltage, 5V Voltage, 12V Voltage

The onboard hardware monitor automatically detects the voltage output through the onboard voltage regulators. Select **Ignore** if you do not want to detect this item.

## Anti Surge Support [Enabled]

This item allows you to enable or disable the Anti Surge function.

Configuration options: [Disabled] [Enabled]

## CPU Q-Fan Control [Enabled]

[Disabled] Disables the CPU Q-Fan control feature.

[Enabled] Enables the CPU Q-Fan control feature.

## CPU Fan Speed Low Limit [200 RPM]

This item appears only when you enable the **CPU Q-Fan Control** feature and allows you to disable or set the CPU fan warning speed.

Configuration options: [Ignore] [200 RPM] [300 RPM] [400 RPM] [500 RPM] [600 RPM]

### *CPU Fan Profile [Standard]*

This item appears only when you enable the **CPU Q-Fan Control** feature and allows you to set the appropriate performance level of the CPU fan.

[Standard] Sets to [Standard] to make the CPU fan automatically adjust depending on the CPU temperature.

[Silent] Sets to [Silent] to minimize the fan speed for quiet CPU fan operation.

[Turbo] Sets to [Turbo] to achieve maximum CPU fan speed.

[Manual] Sets to [Manual] to assign detailed fan speed control parameters.



---

The following four items appear only when you set **CPU Fan Profile** to [Manual].

---

### **CPU Upper Temperature [70]**

Use the <+> and <-> keys to adjust the upper limit of the CPU temperature. The values range from 40°C to 90°C.

### **CPU Fan Max. Duty Cycle(%) [100]**

Use the <+> and <-> keys to adjust the maximum CPU fan duty cycle. The values range from 20% to 100%. When the CPU temperature reaches the upper limit, the CPU fan will operate at the maximum duty cycle.

### **CPU Lower Temperature [20]**

Displays the lower limit of the CPU temperature.

### **CPU Fan Min. Duty Cycle(%) [20]**

Use the <+> and <-> keys to adjust the minimum CPU fan duty cycle. The values range from 0% to 100%. When the CPU temperature is under 40°C, the CPU fan will operate at the minimum duty cycle.

## **Chassis Q-Fan Control 1/2 [Enabled]**

[Disabled] Disables the Chassis Q-Fan control feature.

[Enabled] Enables the Chassis Q-Fan control feature.

## **Chassis Fan Speed Low Limit [600 RPM]**

This item appears only when you enable the **Chassis Q-Fan Control** feature and allows you to disable or set the chassis fan warning speed.

Configuration options: [Ignore] [200 RPM] [300 RPM] [400 RPM] [500 RPM] [600 RPM]

### Chassis Fan Profile [Standard]

This item appears only when you enable the **Chassis Q-Fan Control** feature and allows you to set the appropriate performance level of the chassis fan.

[Standard] Sets to [Standard] to make the chassis fan automatically adjust depending on the chassis temperature.

[Silent] Sets to [Silent] to minimize the fan speed for quiet chassis fan operation.

[Turbo] Sets to [Turbo] to achieve maximum chassis fan speed.

[Manual] Sets to [Manual] to assign detailed fan speed control parameters.



---

The following four items appear only when you set **Chassis Fan Profile** to [Manual].

---

### **Chassis Upper Temperature [70]**

Use the <+> and <-> keys to adjust the upper limit of the CPU temperature. The values range from 40°C to 90°C.

### **Chassis Fan Max. Duty Cycle(%) [100]**

Use the <+> and <-> keys to adjust the maximum chassis fan duty cycle. The values range from 20% to 100%. When the chassis temperature reaches the upper limit, the chassis fan will operate at the maximum duty cycle.

### **Chassis Lower Temperature [40]**

Displays the lower limit of the chassis temperature.

### **CPU Fan Min. Duty Cycle(%) [60]**

Use the <+> and <-> keys to adjust the minimum chassis fan duty cycle. The values range from 0% to 100%. When the chassis temperature is under 40°C, the chassis fan will operate at the minimum duty cycle.

## 3.7 Boot menu

The Boot menu items allow you to change the system boot options.

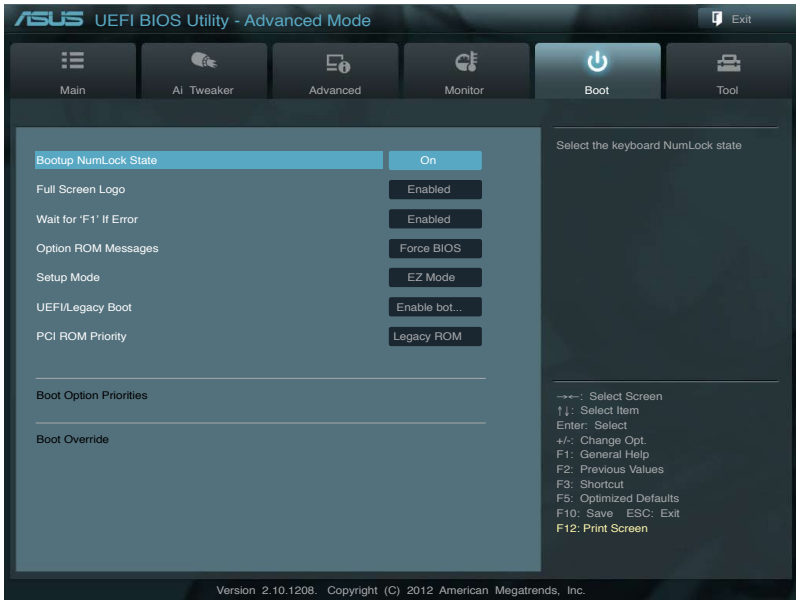

### Bootup NumLock State [On]

[On] Sets the power-on state of the NumLock to [On].

[Off] Sets the power-on state of the NumLock to [Off].

### Full Screen Logo [Enabled]

[Enabled] Enables the full screen logo display feature.

[Disabled] Disables the full screen logo display feature.



Set this item to [Enabled] to use the ASUS MyLogo 2™ feature.

### Wait For 'F1' If Error [Enabled]

[Disabled] Disables this function.

[Enabled] The system waits for the <F1> key to be pressed when error occurs.

### Option ROM Messages [Force BIOS]

[Force BIOS] The third-party ROM messages will be forced to display during the boot sequence.

[Keep Current] The third-party ROM messages will be displayed only if the third-party manufacturer had set the add-on device to do so.

## Setup Mode [EZ Mode]

[Advanced Mode] Sets Advanced Mode as the default screen for entering the BIOS setup program.

[EZ Mode] Sets EZ Mode as the default screen for entering the BIOS setup program.

## UEFI/Legacy Boot [Enable both UEFI and Legacy]

[Enable both UEFI and Legacy] Enables both UEFI and Legacy boot.

[Disable UEFI] Enables the Legacy boot, and disables the UEFI boot.

[Disable Legacy] Enables the UEFI boot, and disables the Legacy boot.

## PCI ROM Priority [Legacy ROM]

This item specifies the PCI Option ROM launch priority when multiple Option ROMs are available. Configuration options: [Legacy ROM] [EFI Compatible ROM]

## Boot Option Priorities

These items specify the boot device priority sequence from the available devices. The number of device items that appears on the screen depends on the number of devices installed in the system.



- 
- To select the boot device during system startup, press <F8> when ASUS Logo appears.
  - To access Windows OS in Safe Mode, do any of the following:
    - Press <F5> when ASUS Logo appears.
    - Press <F8> after POST.
- 

## Boot Override

These items displays the available devices. The number of device items that appears on the screen depends on the number of devices installed in the system. Click an item to start booting from the selected device.



## 3.8 Tools menu

The Tools menu items allow you to configure options for special functions. Select an item then press <Enter> to display the submenu.

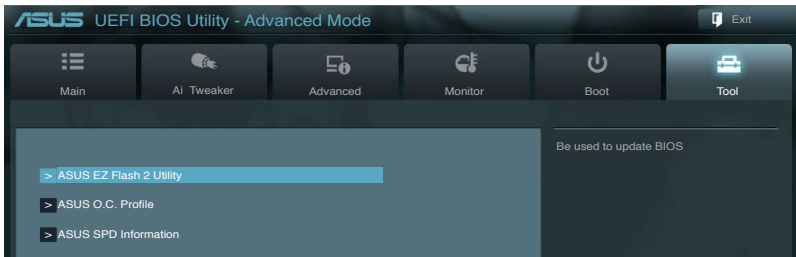

### 3.8.1 ASUS EZ Flash 2 Utility

Allows you to run ASUS EZ Flash 2. When you press <Enter>, a confirmation message appears. Use the left/right arrow key to select between [Yes] or [No], then press <Enter> to confirm your choice.



For more details, refer to **section 3.10.2 ASUS EZ Flash 2 utility**.

### 3.8.2 ASUS O.C. Profile

This item allows you to store or load multiple BIOS settings.

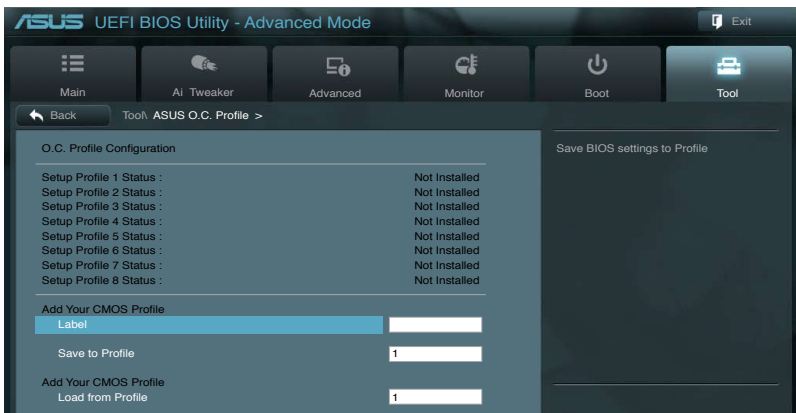

The **Setup Profile Status** items show **Not Installed** if no profile is created.

## Save to Profile

Allows you to save the current BIOS settings to the BIOS Flash, and create a profile. Key in a profile number from one to eight, press <Enter>, and then select **Yes**.

## Load from Profile

Allows you to load the previous BIOS settings saved in the BIOS Flash. Key in the profile number that saved your BIOS settings, press <Enter>, and then select **Yes**.



- 
- DO NOT shut down or reset the system while updating the BIOS to prevent the system boot failure!
  - We recommend that you update the BIOS file only coming from the same memory/CPU configuration and BIOS version.
- 

### 3.8.3 ASUS SPD Information

#### DIMM Slot # [Slot 1]

Displays the Serial Presence Detect (SPD) information of the DIMM module installed on the selected slot. Configuration options: [Slot 1] [Slot 2] [Slot 3] [Slot 4]

## 3.9 Exit menu

The Exit menu items allow you to load the optimal default values for the BIOS items, and save or discard your changes to the BIOS items. You can access the **EZ Mode** from the Exit menu.

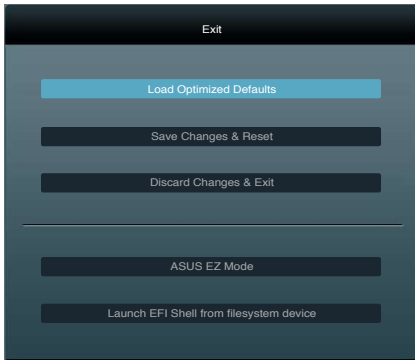

### Load Optimized Defaults

This option allows you to load the default values for each of the parameters on the Setup menus. When you select this option or if you press <F5>, a confirmation window appears. Select **Yes** to load the default values.

### Save Changes & Reset

Once you are finished making your selections, choose this option from the Exit menu to ensure the values you selected are saved. When you select this option or if you press <F10>, a confirmation window appears. Select **Yes** to save changes and exit.

### Discard Changes & Exit

This option allows you to exit the Setup program without saving your changes. When you select this option or if you press <Esc>, a confirmation window appears. Select **Yes** to discard changes and exit.

### ASUS EZ Mode

This option allows you to enter the EZ Mode screen.

### Launch EFI Shell from filesystem device

This option allows you to attempt to launch the EFI Shell application (shellx64.efi) from one of the available filesystem devices.

## 3.10 Updating BIOS

The ASUS website publishes the latest BIOS versions to provide enhancements on system stability, compatibility, or performance. However, BIOS updating is potentially risky. If there is no problem using the current version of BIOS, **DO NOT manually update the BIOS**. Inappropriate BIOS updating may result in the system's failure to boot. Carefully follow the instructions of this chapter to update your BIOS if necessary.



---

Visit the ASUS website ([www.asus.com](http://www.asus.com)) to download the latest BIOS file for this motherboard.

---

The following utilities allow you to manage and update the motherboard BIOS setup program.

1. **ASUS Update:** Updates the BIOS in Windows® environment.
2. **ASUS EZ Flash 2:** Updates the BIOS using a USB flash drive.
3. **ASUS CrashFree BIOS 3:** Restores the BIOS using the motherboard support DVD or a USB flash drive when the BIOS file fails or gets corrupted.
4. **ASUS BIOS Updater:** Updates and backups the BIOS in DOS environment using the motherboard support DVD and a USB flash disk drive.

Refer to the corresponding sections for details on these utilities.



---

Save a copy of the original motherboard BIOS file to a USB flash disk in case you need to restore the BIOS in the future. Copy the original motherboard BIOS using the **ASUS Update** or **BIOS Updater** utilities.

---

### 3.10.1 ASUS Update utility

The ASUS Update is a utility that allows you to manage, save, and update the motherboard BIOS in Windows® environment. The ASUS Update utility allows you to:

- Update the BIOS directly from the Internet
- Download the latest BIOS file from the Internet
- Update the BIOS from an updated BIOS file
- View the BIOS version information

This utility is available in the support DVD that comes with the motherboard package.



---

ASUS Update requires an Internet connection either through a network or an Internet Service Provider (ISP).

---

### Launching ASUS Update

After installing AI Suite II from the motherboard support DVD, launch ASUS Update by clicking **Update > ASUS Update** on the AI Suite II main menu bar.



---

Quit all Windows® applications before you update the BIOS using this utility.

---

## Updating the BIOS through the Internet

To update the BIOS through the Internet:

1. From the ASUS Update screen, select **Update BIOS from Internet**, and then click **Next**.

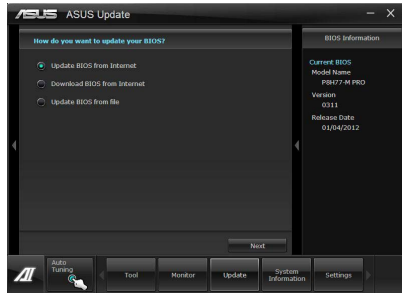

2. Select the ASUS FTP site nearest you to avoid network traffic.  
If you want to enable the BIOS downgradable function and auto BIOS backup function, check the checkboxes before the two items on the screen.

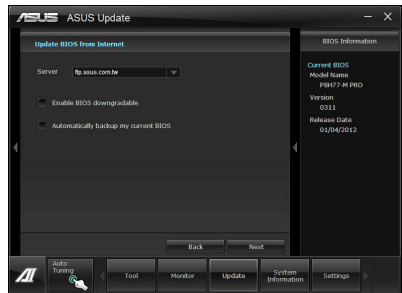

3. Select the BIOS version that you want to

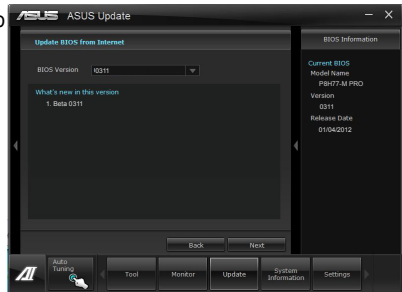

4. You can decide whether to change the BIOS boot logo, which is the image appearing on screen during the Power-On Self-Tests (POST). Click **Yes** if you want to change the boot logo or **No** to continue.
5. Follow the onscreen instructions to complete the update process.

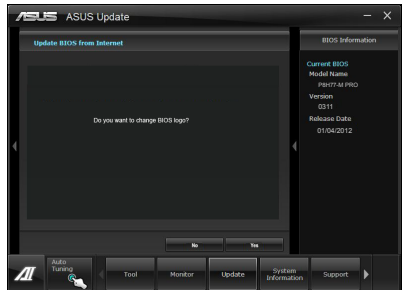

## Updating the BIOS through a BIOS file

To update the BIOS through a BIOS file:

1. From the ASUS Update screen, select **Update BIOS from file**, and then click **Next**.

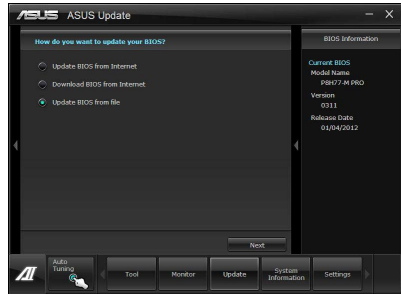

2. Locate the BIOS file from the Open window, click **Open**, and click **Next**.

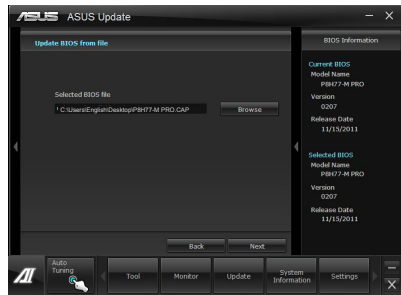

3. You can decide whether to change the BIOS boot logo. Click **Yes** if you want to change the boot logo or **No** to continue.
4. Follow the onscreen instructions to complete the update process.

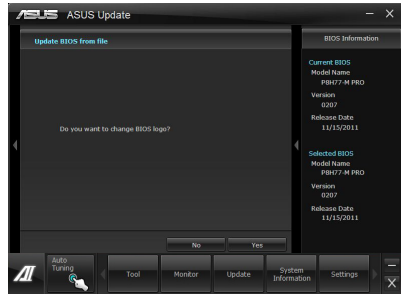

- The screenshots in this section are for reference only. The actual BIOS information vary by models.
- Refer to the software manual in the support DVD or visit the ASUS website at [www.asus.com](http://www.asus.com) for detailed software configuration.

### 3.10.2 ASUS EZ Flash 2 utility

The ASUS EZ Flash 2 feature allows you to update the BIOS without having to use a bootable floppy disk or an OS-based utility.



Before you start using this utility, download the latest BIOS from the ASUS website at [www.asus.com](http://www.asus.com).

To update the BIOS using EZ Flash 2:

1. Insert the USB flash disk that contains the latest BIOS file to the USB port.
2. Enter the Advanced Mode of the BIOS setup program. Go to the **Tool** menu to select **ASUS EZ Flash Utility** and press <Enter> to enable it.

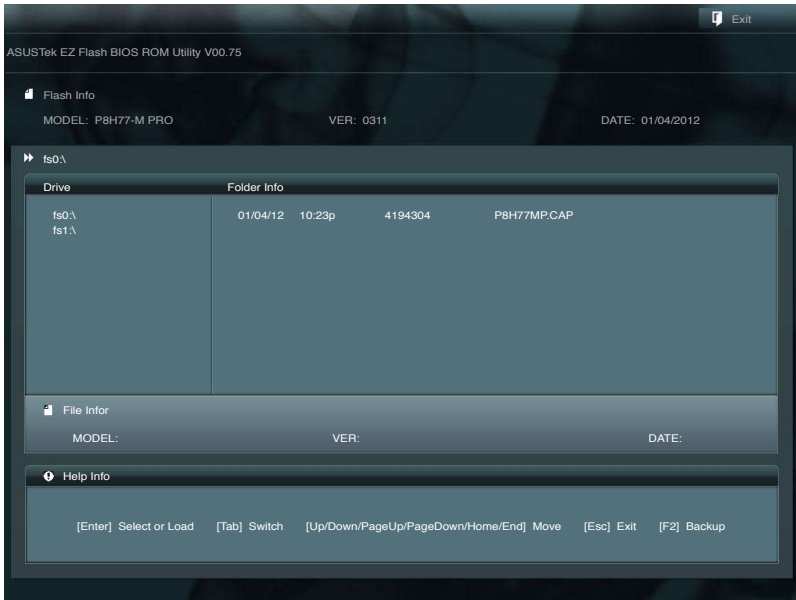

3. Press <Tab> to switch to the Drive field.
4. Press the Up/Down arrow keys to find the USB flash disk that contains the latest BIOS, and then press <Enter>.
5. Press <Tab> to switch to the Folder Info field.
6. Press the Up/Down arrow keys to find the BIOS file, and then press <Enter> to perform the BIOS update process. Reboot the system when the update process is done.



- 
- This function can support devices such as a USB flash disk with FAT 32/16 format and single partition only.
  - DO NOT shut down or reset the system while updating the BIOS to prevent system boot failure!
- 



---

Ensure to load the BIOS default settings to ensure system compatibility and stability. Select the **Load Optimized Defaults** item under the **Exit** menu. See section 3.9 **Exit Menu** for details.

---

### 3.10.3 ASUS CrashFree BIOS 3 utility

The ASUS CrashFree BIOS 3 utility is an auto recovery tool that allows you to restore the BIOS file when it fails or gets corrupted during the updating process. You can restore a corrupted BIOS file using the motherboard support DVD or a USB flash drive that contains the BIOS file.



- 
- The BIOS file in the motherboard support DVD may be older than the BIOS file published on the ASUS official website. If you want to use the newer BIOS file, download the file at [support.asus.com](http://support.asus.com) and save it to a USB flash drive.
  - Before using this utility, rename the BIOS file in the removable device into **P8H77MP.CAP**.
- 

## Recovering the BIOS

To recover the BIOS:

1. Turn on the system.
2. Insert the motherboard support DVD to the optical drive, or the USB flash drive containing the BIOS file to the USB port.
3. The utility automatically checks the devices for the BIOS file. When found, the utility reads the BIOS file and enters ASUS EZ Flash 2 utility automatically.
4. The system requires you to enter BIOS Setup to recover BIOS setting. To ensure system compatibility and stability, we recommend that you press <F5> to load default BIOS values.



---

DO NOT shut down or reset the system while updating the BIOS! Doing so can cause system boot failure!

---



### 3.10.4 ASUS BIOS Updater

The ASUS BIOS Updater allows you to update BIOS in DOS environment. This utility also allows you to copy the current BIOS file that you can use as a backup when the BIOS fails or gets corrupted during the updating process.



The succeeding utility screens are for reference only. The actual utility screen displays may not be same as shown.

#### Before updating BIOS

1. Prepare the motherboard support DVD and a USB flash drive in FAT32/16 format and single partition.
2. Download the latest BIOS file and BIOS Updater from the ASUS website at <http://support.asus.com> and save them on the USB flash drive.



- NTFS is not supported under DOS environment. Do not save the BIOS file and BIOS Updater to a hard disk drive or USB flash drive in NTFS format.
- Do not save the BIOS file to a floppy disk due to low disk capacity.

3. Turn off the computer and disconnect all SATA hard disk drives (optional).

#### Booting the system in DOS environment

1. Insert the USB flash drive with the latest BIOS file and BIOS Updater to the USB port.
2. Boot your computer. When the ASUS Logo appears, press <F8> to show the **BIOS Boot Device Select Menu**. Insert the support DVD into the optical drive and select the optical drive as the boot device.

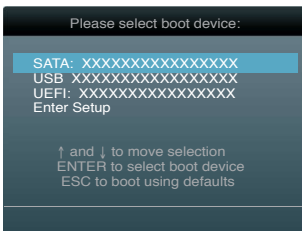

3. When the **Make Disk** menu appears, select the **FreeDOS command prompt** item by pressing the item number.
4. At the FreeDOS prompt, type **d:** and press <Enter> to switch the disk from Drive C (optical drive) to Drive D (USB flash drive).

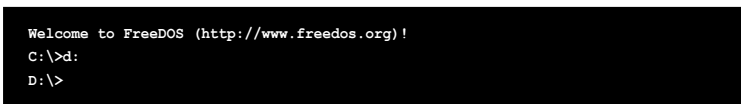

## Updating the BIOS file

To update the BIOS file using BIOS Updater

1. At the FreeDOS prompt, type `bupdater /pc /g` and press <Enter>.

```
D:\>bupdater /pc /g
```

2. The BIOS Updater screen appears as below.

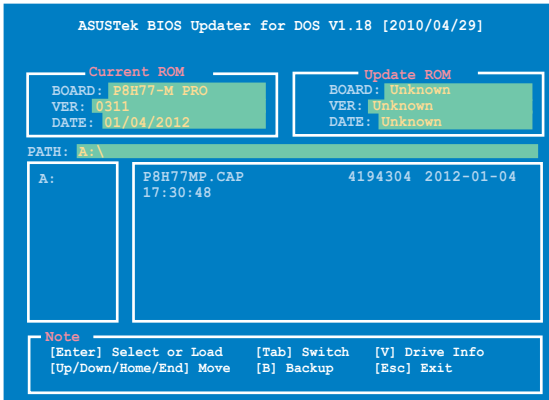

3. Press <Tab> to switch between screen fields and use the <Up/Down/Home/End> keys to select the BIOS file and press <Enter>. BIOS Updater checks the selected BIOS file and prompts you to confirm BIOS update.



4. Select **Yes** and press <Enter>. When BIOS update is done, press <ESC> to exit BIOS Updater. Restart your computer.



DO NOT shut down or reset the system while updating the BIOS to prevent system boot failure!



- For BIOS Updater version 1.04 or later, the utility automatically exits to the DOS prompt after updating BIOS.
- Ensure to load the BIOS default settings to ensure system compatibility and stability. Select the **Load Optimized Defaults** item under the **Exit** BIOS menu. See Chapter 3 of your motherboard user manual for details.
- Ensure to connect all SATA hard disk drives after updating the BIOS file if you have disconnected them.

# Chapter 4

## 4.1 Installing an operating system

This motherboard supports Windows® XP / 64-bit XP / 7 / 64-bit 7 operating systems (OS). Always install the latest OS version and corresponding updates to maximize the features of your hardware.



- Motherboard settings and hardware options vary. Use the setup procedures presented in this chapter for reference only. Refer to your OS documentation for detailed information.
- Ensure that you install the Windows® XP Service Pack 3 or Windows® 64-bit XP / 7 / 64-bit 7 / operating systems before installing the drivers for better compatibility and system stability.

## 4.2 Support DVD information

The support DVD that comes with the motherboard package contains the drivers, software applications, and utilities that you can install to avail all motherboard features.



The contents of the support DVD are subject to change at any time without notice. Visit the ASUS website at [www.asus.com](http://www.asus.com) for updates.

### 4.2.1 Running the support DVD

Place the support DVD into the optical drive. The DVD automatically displays the Drivers menu if Autorun is enabled in your computer. Click each menu tab and select the items you want to install.

The Drivers menu shows the available device drivers if the system detects installed devices. Install the necessary drivers to use the devices.

The Make Disk menu contains items to create the RAID/AHCI driver disk.

The Manual menu contains the list of supplementary user manuals. Click an item to open the folder of the user manual.

The Utilities menu shows the applications and other software that the motherboard supports.

Click an item to install

Click to show more items



Click the Contact tab to display the ASUS contact information.

Click an icon to display DVD/motherboard information



If Autorun is NOT enabled in your computer, browse the contents of the support DVD to locate the file ASSETUP.EXE from the BIN folder. Double-click the ASSETUP.EXE to run the DVD.

## 4.2.2 Obtaining the software manuals

The software manuals are included in the support DVD. Follow the instructions below to get the necessary software manuals.



The software manual files are in Portable Document Format (PDF). Install the Adobe® Acrobat® Reader from the Utilities menu before opening the files.

1. Click the **Manual** tab. Click **ASUS Motherboard Utility Guide** from the manual list on the left.



2. The **Manual** folder of the support DVD appears. Double-click the folder of your selected software.

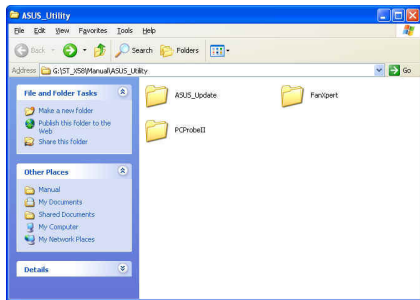

3. Some software manuals are provided in different languages. Double-click the language to show the software manual.

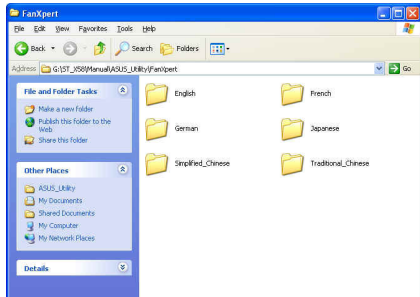

The screenshots in this section are for reference only. The actual software manuals containing in the support DVD vary by models.

## 4.3 Software information

Most of the applications in the support DVD have wizards that will conveniently guide you through the installation. View the online help or readme file that came with the software application for more information.

### 4.3.1 AI Suite II

AI Suite II is an all-in-one interface that integrates several ASUS utilities and allows users to launch and operate these utilities simultaneously.

#### Installing AI Suite II

To install AI Suite II on your computer

1. Place the support DVD to the optical drive. The Drivers installation tab appears if your computer has enabled the Autorun feature.
2. Click the Utilities tab, then click **AI Suite II**.
3. Follow the onscreen instructions to complete installation.

#### Using AI Suite II

AI Suite II automatically starts when you enter the Windows® operating system (OS). The AI Suite II icon appears in the Windows® notification area. Click the icon to open the AI Suite II main menu bar.

Click each button to select and launch a utility, to monitor the system, to update the motherboard BIOS, to display the system information, and to customize the settings of AI Suite II.

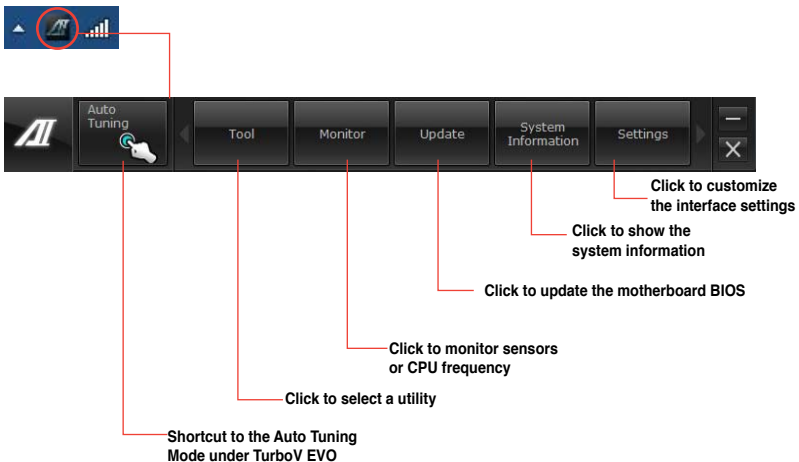

- The **Auto Tuning** button appears only on models with the TurboV EVO function.
- The applications in the Tool menu vary with models.
- The screenshots of AI Suite II in this user manual are for reference only. The actual screenshots vary with models.
- Refer to the software manual in the support DVD or visit the ASUS website at [www.asus.com](http://www.asus.com) for detailed software configuration.

### 4.3.2 TurboV EVO

ASUS TurboV EVO introduces **TurboV** that allows you to manually adjust the CPU frequency and related voltages as well as **Auto Tuning** function that offers automatic and easy overlocking and system level up. After installing AI Suite II from the motherboard support DVD, launch TurboV EVO by clicking **Tool > TurboV EVO** on the AI Suite II main menu bar.



Refer to the software manual in the support DVD or visit the ASUS website at [www.asus.com](http://www.asus.com) for detailed software configuration.

### TurboV

**TurboV** allows you to overclock the BCLK frequency, CPU voltage, DDR voltage, VCCSA Voltage and PCH Voltage in Windows® environment and takes effect in real-time without exiting and rebooting the OS.



Refer to the CPU documentation before adjusting CPU voltage settings. Setting a high voltage may damage the CPU permanently, and setting a low voltage may make the system unstable.



For system stability, all changes made in **TurboV** will not be saved to BIOS settings and will not be kept on the next system boot. Use the **Save Profile** function to save your customized overclocking settings and manually load the profile after Windows starts.

The screenshot shows the ASUS TurboV EVO software interface. On the left, there are tabs for 'Manual Mode', 'Auto Tuning', and 'GPU Boost'. The 'Manual Mode' is selected, showing a table of settings:

Profile	Save Profile
BCLK Frequency: 103.0000 / 103.0000 MHz	
CPU Voltage: 1.160 / 1.160 (V)	
DDR Voltage: 1.500 / 1.500 (V)	

Below this is the 'Advanced Mode' section with 'GPU Boost' settings:

VCCSA Voltage: 0.925 / 0.925 (V)	
PCH Voltage: 1.050 / 1.050 (V)	

On the right side, there are 'CPU' and 'GPU' sections. The CPU section shows 'CPU Frequency' at 1648.0 MHz and 'CPU Usage' at 2%. The GPU section shows 'GPU Frequency' at 0850.0 MHz and 'GPU Usage' at 1%.

Annotations on the left side of the screenshot include:

- Click to select Mode
- Load profile
- Target values
- Current values
- GPU Boost
- Advanced Mode
- Click to restore all start-up settings

Annotations on the right side include:

- Save the current settings as a new profile
- Voltage Adjustment bars
- Undoes all changes without applying
- Applies all changes immediately

At the bottom of the interface, there are buttons for 'OS Default Settings', 'Undo', and 'Apply', along with a navigation bar containing 'Auto Tuning', 'Tool', 'Monitor', 'Update', 'System Information', and 'Settings'.

## Using Advanced Mode

Click **More Settings**, and then click the **Advanced Mode** tab to adjust the advanced voltage settings.



The screenshot shows the ASUS TurboV EVO interface. The 'Advanced Mode' tab is selected, displaying various voltage settings with sliders and numerical values. On the right, a 'CPU' section shows real-time frequency and usage. Red callout boxes and arrows point to specific elements: 'Advanced mode Target values' points to the 'Advanced Mode' tab; 'Current values' points to the numerical values of the sliders; 'Click to restore all start-up settings' points to the 'OS Default Settings' button; 'Voltage Adjustment bars' points to the sliders; 'Undoes all changes without applying' points to the 'Undo' button; and 'Applies all changes immediately' points to the 'Apply' button.

## GPU Boost

Allows you to manually set the GPU Boost.



The first time you use **GPU Boost**, go to **AI Tweaker** in BIOS and set the **iGPU voltage** item to **[Manual Mode]**.

1. Click the **GPU Boost** tab.
2. Slide the bar to adjust the iGPU Max Frequency or the iGPU Voltage.
3. Click **Apply** to make the change take effect.



The screenshot shows the ASUS TurboV EVO interface with the 'GPU Boost' tab selected. It displays settings for iGPU Max Frequency and iGPU Offset Voltage. Red callout boxes and arrows point to: 'GPU Boost' pointing to the 'GPU Boost' tab; 'Click to restore all start-up settings' pointing to the 'OS Default Settings' button; 'Applies all changes immediately' pointing to the 'Apply' button; and 'Undoes all changes without applying' pointing to the 'Undo' button.

## Auto Tuning

ASUS TurboV EVO provides the most flexible auto-tuning options.



- The overclocking result varies with the CPU model and the system configuration.
- To prevent overheating from damaging the motherboard, a better thermal environment is strongly recommended.

1. Click the **Auto Tuning GPU Boost**.
2. Click **Start** to start auto-overclocking.



3. TurboV automatically overclocks the CPU, saves BIOS settings and restarts the system. After re-entering Windows, a message appears indicating auto tuning success. Click **OK** to exit.



### 4.3.3 DIGI+ VRM

ASUS DIGI+ VRM allows you to adjust VRM voltage and frequency modulation to enhance reliability and stability. It also provides the highest power efficiency, generating less heat to longer component lifespan and minimize power loss.

After installing AI Suite II from the motherboard support DVD, launch DIGI+ VRM by clicking **Tool > DIGI+ VRM** on the AI Suite II main menu bar.

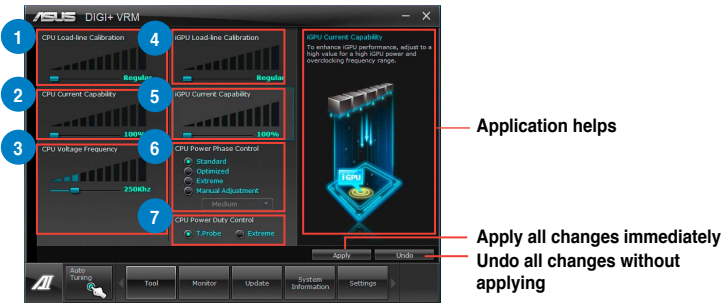



Items	Function description
1	<b>CPU Load-line Calibration</b> It allows you to adjust the voltage settings and control the system temperature. Higher load-line calibration could get higher voltage and good overclocking performance but increases the CPU and VRM thermal.
2	<b>CPU Current Capability</b> CPU Current Capability provides wider total power range for overclocking. A higher value setting gets higher VRM power consumption delivery.
3	<b>CPU Voltage Frequency</b> Switching frequency will affect the VRM transient response and component thermal. Higher frequency gets quicker transient response.
4	<b>iGPU Load-line Calibration</b> Load-line is defined by Intel VRM specifications, and affects the iGPU voltage. The iGPU working voltage will decrease proportionally to integrated graphics loading. A higher value can get a higher iGPU voltage, and a good performance, but increases the CPU and VRM thermal conditions.
5	<b>iGPU Current Capability</b> A higher value brings a wider total iGPU power range and extends the overclocking frequency range simultaneously to enhance the iGPU performance.
6	<b>CPU Power Phase Control</b> Increase phase number under heavy system loading to get more transient and better thermal performance. Reduce phase number under light system loading to increase VRM efficiency.
7	<b>CPU Power Duty Control</b> CPU Power Duty Control adjusts the current of every VRM phase and the thermal of every phase component.



- The actual performance boost may vary depending on your CPU specification.
- Do not remove the thermal module. The thermal conditions should be monitored.



Refer to the software manual in the support DVD or visit the ASUS website at [www.asus.com](http://www.asus.com) for detailed software configuration.

### 4.3.4 EPU

EPU is an energy-efficient tool that satisfies different computing needs. This utility provides several modes that you can select to save system power. Selecting Auto mode will have the system shift modes automatically according to current system status. You can also customize each mode by configuring settings like CPU frequency, GPU frequency, vCore Voltage, and Fan Control.

#### Launching EPU

After installing AI Suite II from the motherboard support DVD, launch EPU by clicking **Tool > EPU** on the AI Suite II main menu bar.

**Multiple system operating modes**

**Displays the following message if no VGA power saving engine is detected.**

**Displays current mode**

**The items lighting up means power saving engine is activated**

**Displays the amount of CO2 reduced**

**Shifts between the display of Total and Current CO2 reduced**

**Displays the current CPU power**

**Advanced settings for each mode**

**Displays the system properties of each mode**



- \* Select **From EPU Installation** to show the CO2 that has been reduced since you installed EPU.
- \* Select **From the Last Reset** to show the total CO2 that has been reduced since you click the **Clear** button.
- Refer to the software manual in the support DVD or visit the ASUS website at [www.asus.com](http://www.asus.com) for detailed software configuration.

### 4.3.5 FAN Xpert

Fan Xpert intelligently allows you to adjust both the CPU and chassis fan speeds according to different ambient temperatures caused by different climate conditions in different geographic regions and your PC's system loading. The built-in variety of useful profiles offer flexible controls of fan speed to achieve a quiet and cool environment.

#### Launching FAN Xpert

After installing AI Suite II from the motherboard support DVD, launch FAN Xpert by clicking **Tool > Fan Xpert** on the AI Suite II main menu bar.

#### Using FAN Xpert

Click **Fan Name** to select a fan and then click **Setting** to select a preset mode for your selected fan.

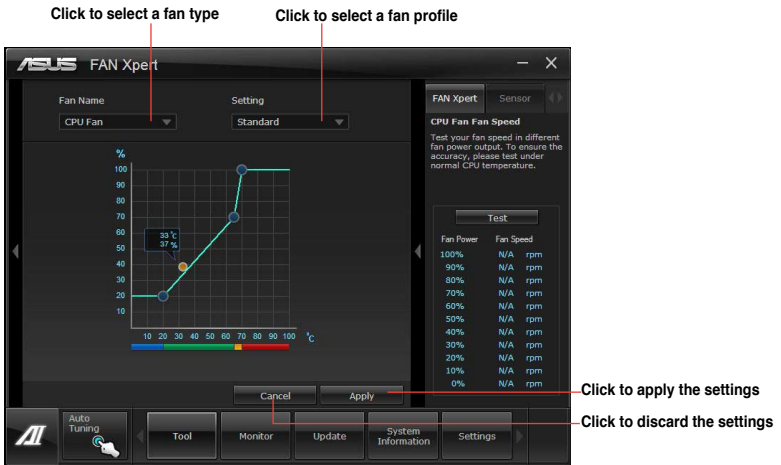

#### Fan setting

- **Disable:** disables the Fan Xpert function.
- **Standard:** adjusts fan speed in a moderate pattern.
- **Silent:** minimizes fan speed for quiet fan operation.
- **Turbo:** maximizes the fan speed for the best cooling effect.
- **User:** Allows you to configure the CPU fan profile under certain limitations.



Refer to the software manual in the support DVD or visit the ASUS website at [www.asus.com](http://www.asus.com) for detailed software configuration.

### 4.3.6 Probe II

Probe II is a utility that monitors the computer's vital components, and detects and alerts you of any problem with these components. Probe II senses fan rotations, CPU temperature, and system voltages, among others. With this utility, you are assured that your computer is always at a healthy operating condition.

#### Launching Probe II

After installing AI Suite II from the motherboard support DVD, launch Probe II by clicking **Tool > Probe II** on the AI Suite II main menu bar.

#### Configuring Probe II

Click the **Voltage/Temperature/Fan Speed** tabs to activate the sensors or to adjust the sensor threshold values. The **Preference** tab allows you to customize the time interval of sensor alerts, or change the temperature unit.

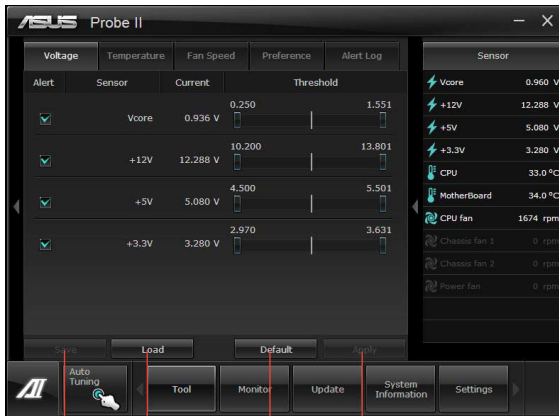

Saves your configuration

Loads your saved configuration

Loads the default threshold values for each sensor

Applies your changes



Refer to the software manual in the support DVD or visit the ASUS website at [www.asus.com](http://www.asus.com) for detailed software configuration.

### 4.3.7 USB 3.0 Boost

The ASUS exclusive USB 3.0 Boost provides speed boost for USB 3.0 devices and the up-to-date support of USB Attached SCSI Protocol (UASP). With USB 3.0 Boost, you can accelerate the transfer speed of your USB 3.0 devices with ease.

#### Launching USB 3.0 Boost

After installing AI Suite II from the motherboard support DVD, launch USB 3.0 Boost by clicking **Tool > USB 3.0 Boost** on the AI Suite II main menu bar.

#### Configuring USB 3.0 Boost

1. Connect a USB 3.0 device to the USB 3.0 port.
2. USB 3.0 Boost automatically detects the property of the connected device and switches to **Turbo** mode or **UASP** mode (if UASP is supported by the connected device).
3. You can manually switch the USB 3.0 mode back to **Normal** mode at any time.



- Refer to the software manual in the support DVD or visit the ASUS website at [www.asus.com](http://www.asus.com) for detailed software configuration.
- Due to Intel® chipset limitation, Intel® USB 3.0 ports do not support ASUS 3.0 Boost in Windows® XP operating system.
- Use the USB 3.0 devices for high performance. The data transfer speed varies with USB devices.

### 4.3.8 MyLogo2

This MyLogo utility lets you customize the boot logo. The boot logo is the image that appears on screen during the Power-On-Self-Tests (POST). Personalize your computer from the very beginning!

#### Launching ASUS Update

After installing AI Suite II from the motherboard support DVD, launch MyLogo by clicking **Update> MyLogo** on the AI Suite II main menu bar.

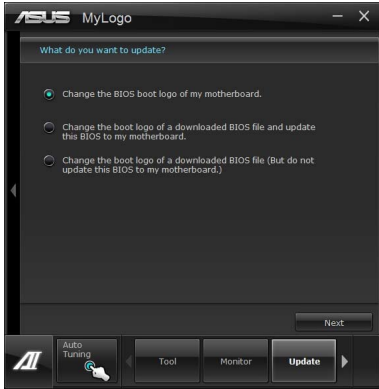

#### Using MyLogo

Select the way you would like to do update your boot logo. Then click Next and follow the given instructions.

##### Change the BIOS boot logo of my motherboard

1. Under Current BIOS, click **Browse** and choose the desired image for your boot logo. Then click on Next.

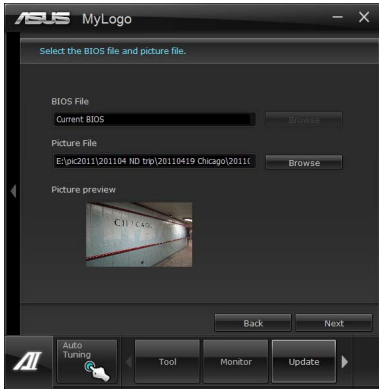

2. Click on **Auto Tune** to adjust image size compatibility or adjust the resolution bar.
3. You can click on Booting Preview to preview the boot image. Then click Next.
4. Click on Flash to start updating the image to the boot logo.
5. Click on Yes to reboot or you can also see the new logo next time you restart your computer.

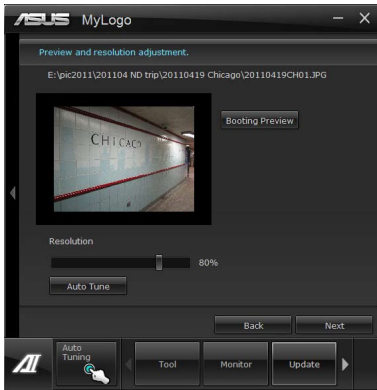

### Change the boot logo of a downloaded BIOS file and update (or do not update) this BIOS to the motherboard

1. At BIOS File, **Browse** to download the requested BIOS file to your system. This utility will help you detect the compatibility of the BIOS version.
2. Then at Picture File, Browse to select the desired image for boot logo. Click Next.
3. Follow steps 2-5 in **Change the BIOS boot logo of my motherboard** to complete logo update.

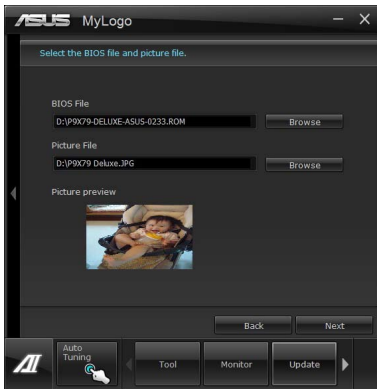

The fullscreen logo application in BIOS utility must be enabled for MyLogo to take effect.

### 4.3.9 Audio configurations

The Realtek® audio CODEC provides 8-channel audio capability to deliver the ultimate audio experience on your computer. The software provides Jack-Detection function, S/PDIF Out support, and interrupt capability. The CODEC also includes the Realtek® proprietary UAJ® (Universal Audio Jack) technology for all audio ports, eliminating cable connection errors and giving users plug and play convenience.

Follow the installation wizard to install the Realtek® Audio Driver from the support DVD that came with the motherboard package.

If the Realtek audio software is correctly installed, you will find the **Realtek HD Audio Manager** icon on the taskbar. Double-click on the icon to display the Realtek HD Audio Manager.



Realtek HD Audio Manager

#### A. Realtek HD Audio Manager for Windows® 7

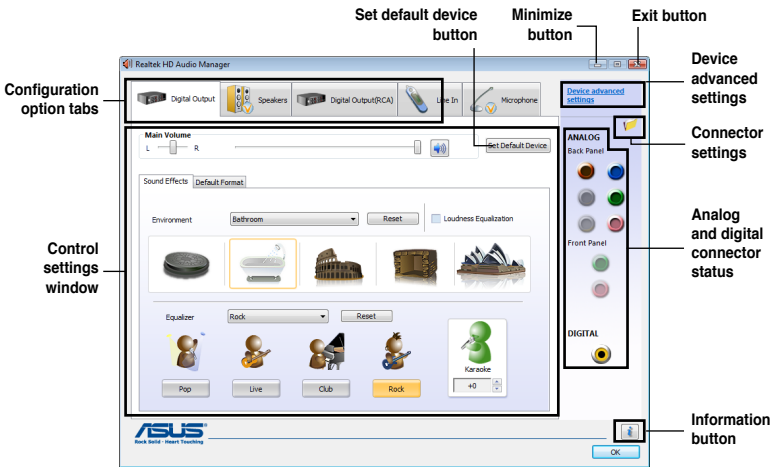

#### B. Realtek HD Audio Manager for Windows XP







---

Refer to the software manual in the support DVD or visit the ASUS website at [www.asus.com](http://www.asus.com) for detailed software configuration.

---

## 4.4 Introduction to Intel® 2012 Desktop responsiveness technologies

This document details the overview of the installation and configuration procedures of the Intel® 2012 Desktop responsiveness technologies.

Intel® 2012 Desktop responsiveness technologies feature the three technologies:

- Intel® Smart Response Technology
- Intel® Rapid Start Technology
- Intel® Smart Connect Technology

### 4.4.1 System Requirements for Intel® 2012 Desktop responsiveness technologies

In order for the system to run smoothly for the Intel® 2012 Desktop responsiveness, you must meet the following requirements:

1. CPU: Intel® 3rd/2nd generation Core Processor family
2. OS: Windows® 7 operating systems
3. SSD: One dedicated SSD (Solid State Disk) to support Intel® Smart Response and Intel® Rapid Start Technology is necessary.



---

Refer to the **SSD Capacity Requirements** table for the information of SSD size, partition capacity, and system memory requirements.

---

4. HDD: At least one HDD (Hard Disk Drive) for the system OS drive.
5. DRAM: To enable Intel® Rapid Start Technology, DRAM size smaller than 8GB is required.



---

**Ensure to enable the acceleration of Intel® Smart Response Technology** before creating the partition for the Intel® Rapid Start Technology.

---

## SSD Capacity Requirements

SSD Partition Capacity Requirements		System DRAM		
		2GB	4GB	8GB
Intel® storage combinations	Intel® Rapid Start	2GB	4GB	8GB
	Intel® Smart Response	20GB	20GB	20GB
	Intel® Smart Response and Intel® Rapid Start	Separate 20GB and 2GB partition (SSD size > 22GB)	Separate 20GB and 4GB partition (SSD size > 24GB)	Separate 20GB and 8GB partition (SSD size > 28GB)
	Intel® Smart Response, Intel® Rapid Start, and Intel® Smart Connect	Separate 20GB and 2GB partition (SSD size > 22GB)	Separate 20GB and 4GB partition (SSD size > 24GB)	Separate 20GB and 8GB partition (SSD size > 28GB)



- The SSD used for Intel® Rapid Start and Intel® Smart Response is not allowed for creating RAID.
- Due to OS behavior, Intel® Rapid Start Technology works inefficiently with over 4G system memory under Windows® 7 32-bit operating system.
- Only Intel® internal SATA ports (gray and blue) support Intel® 2012 Desktop responsiveness technologies.
- The performance of Intel® Smart Response Technology and Intel® Rapid Storage Technology vary by the installed SSD.

## 4.4.2 Intel® Smart Response Technology

Intel® Smart Response Technology boosts overall system performance. It uses an installed fast SSD (min. 18.6GB available) as a cache for frequently accessed operations, speeding up hard drive/main memory interaction. Key benefits are expedited hard drive speeds, reduced load and wait times, and maximized storage utilization. Power consumption also goes down by reducing unnecessary hard drive spin.



Before applying Intel® Smart Response Technology, setting the SATA Mode BIOS item to [RAID mode] in BIOS setup is necessary. Refer to section 3.5.3 **SATA Configuration** for details

### Installing Intel® Smart Response Technology

1. Place the support DVD to the optical drive. The Drivers installation tab appears if your computer has enabled the Autorun feature.
2. Click the **Drivers** tab, then click **Intel® Rapid Storage Technology Driver** software.
3. Follow the onscreen instructions to complete the installation.

### Using the Intel® Smart Response Technology

1. Click **Accelerate** to launch Smart Response Technology settings.



2. Select the SSD you want to use to accelerate your storage system.
  - a. Select the size allocated for SSD caching.
  - b. Select which HDD for caching.
  - c. **Enhanced mode**: WRITE THROUGH, write to SSD and HDD at the same time.
  - d. **Maximized mode**: WRITE BACK, write to SSD and write back to HDD in a later time.

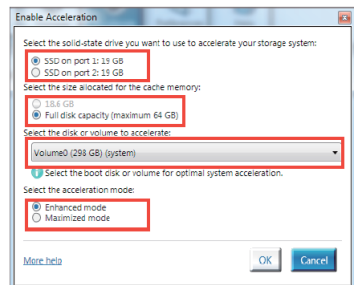

3. Select **Disable Acceleration** to disable this function, and select **Change Mode** to switch acceleration mode to Enhanced/Maximized.

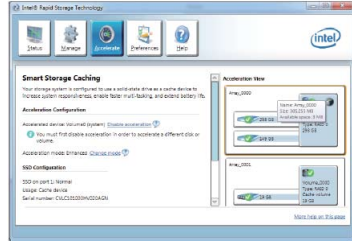

- To enable Intel® Smart Response Technology, you need at least one SSD ( $\geq 20\text{GB}$ ) and a HDD, and only one SSD can be assigned for caching.
- If you want to restore the OS, go to **BIOS Option ROM > Acceleration Options** and remove the **Disks/Volume Acceleration** to disable Intel® Smart Response Technology. Refer to Chapter 4, section Installing Serial ATA hard disk for the entry of BIOS Option ROM.
- The maximum caching size on the SSD is 64GB. If it exceeds, the storage capacity left out for caching can still be identified by the system for normal storage.

#### 4.4.3 Intel® Rapid Start Technology

Intel® Rapid Start Technology allows you to quickly resume your computer from sleeping mode. Saving your computer's system memory to the configured SSD provides a faster wake-up response time, but keeps the energy in a low profile.



- Before applying Intel® Rapid Start Technology, go to **Advanced Mode > Advanced > PCH Configuration** in BIOS item, and enable Intel® Rapid Start Technology.
- Ensure to follow the procedure **Creating a partition** precisely to enable the Intel Rapid Start function. Error message appears if you install the Intel® Rapid Start Utility before creating a partition.

#### Creating a partition



- Ensure to backup your data before using the Microsoft partition tool. Incorrect partitioning process will result to data loss.
- Adjusting the DRAM to a high frequency will result to unstable system performance.

1. Go to Start, right-click **Computer > Manage > Disk Management**.
2. Select the SSD that you want to create the partition.

3. Right click the **New Volume** that you want to shrink from, and select **Shrink Volume**.

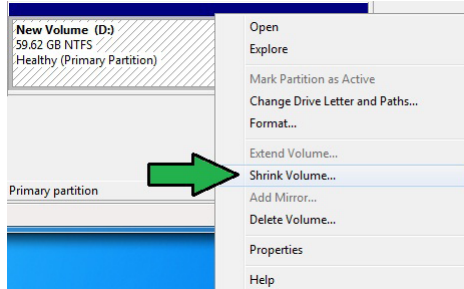

4. If your SSD is not initialized and unformatted:
  - a. Right click the disk that you want to create the partition, and select **Initialize**.
  - b. Right click the unallocated volume, select **New Simple Volume**, and follow the remaining steps.

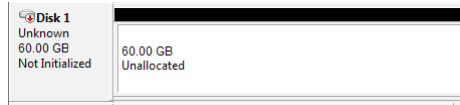

If your SSD is smaller than 64GB, and is set to **Full disk capacity** caching option for Intel® Smart Response, you can not see any volume in the Disk Management. Ensure to set your cache memory value of **18.6GB** in Intel® Smart Response to allow enough capacity for the Intel® Rapid Start partition.

5. Key in the required partition size, and must be equal to the system DRAM memory (1GB = 1024MB). Click **Shrink**.

Go to **Start > Control Panel > System and Security > System**, and check the DRAM size information.

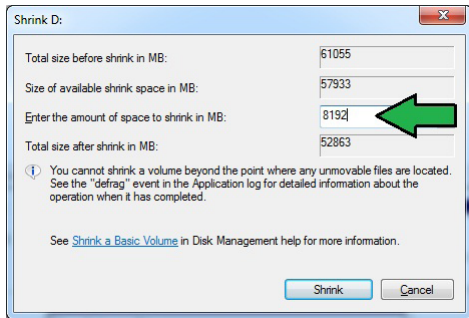

The unallocated volume is allocated to the selected disk.

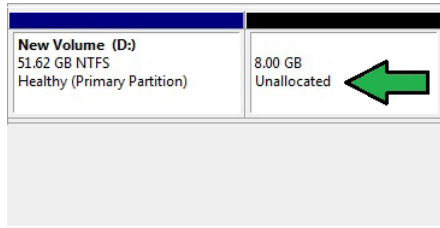

- To launch the disk partitioning tool, click **Start > Programs > Accessories > Command Prompt** tool.
- Type `diskpart` and press **Enter**.
- In the diskpart prompt, type `list disk` after DISKPART, and press **Enter**. Select the disk with the unallocated volume by typing `select disk x` (x = disk number), and press **Enter**.

```
DISKPART> list disk

Disk ###        Status             Size         Free          Dyn          Gpt
-----
Disk 0          Online              2794 GB      1024 KB
Disk 1          Online               59 GB         8 GB

DISKPART> select disk 1
Disk 1 is now the selected disk.
```



- The value "x" refers to a disk number where you created the unallocated partition.
- Refer to step 5 for details about the unallocated disk space in the SSD.

- Type `create partition primary`, and press **Enter**.

```
DISKPART> create partition primary
DiskPart succeeded in creating the specified partition.
DISKPART>
```

- After creating a primary partition, type `detail disk`, and press **Enter** to view the details of the partitioned disk.

```
DISKPART> detail disk
M-C0804332
Disk ID: 316F874
Type : MBR
Status : Online
Path : 0
LARGE : 1
LUN ID : 0
Location Path : PCIROOT(0)ATA(0)01L00
Current Read-only State : No
Read-only : No
Bad Disk : No
PageFile Disk : No
Hibernation File Disk : No
Crashdump Disk : No
Clustered Disk : No

Volume ### Ltr Label Fs Type Size Status Info
-----
Volume 2 D New Volume NTFS Partition 54 GB Healthy
* Volume 3 RAW Partition 8 GB Healthy
```

- Select the RAW volume which has the same size as the shrunk volume, type `select volume x` (x = number), and press **Enter** to store the Intel® Rapid Start partition.

```
DISKPART> select volume 3
Volume 3 is the selected volume.
DISKPART>
```



- The value "x" refers to a disk number where you want to create the store partition.

12. Type `set id=84 override`, press **Enter**, and wait for the “shrinking process” until the Disk Management utility identifies a new partition called **Hibernation Partition**.

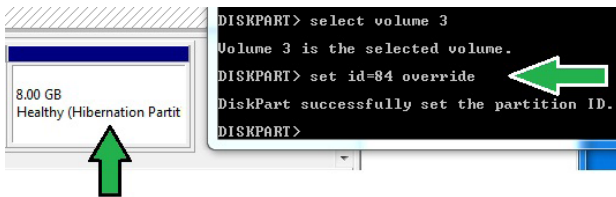

The **Hibernation Partition** does not appear when you choose “GPT (GUID Partition Table store type)”. Ensure the “Unallocated” disappears from the volume, and a new partition is identified.

13. Reboot the system after creating the partition.



The partition for Intel® Rapid Start Technology is incomplete if the computer is not rebooted, and this results to function failure of Intel® Rapid Start Technology.

## Enabling and disabling the Intel® Rapid Start Technology under the OS



Install the Intel® Rapid Start Technology first from your support DVD in order to launch the Intel® Rapid Start Manager.

After creating the partition, launch the Intel® Rapid Start Manager to enable or disable the Intel® Rapid Start Technology.

1. Click the **Show hidden icons** arrow from the right side of the task bar, and click **Intel® Rapid Start Technology Manager** icon.

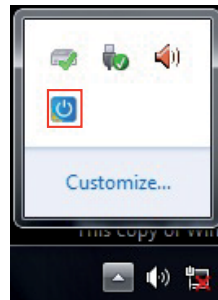

2. Tick **On** in the Status field to enable the function, and click **Save**.

Select and click to enable or disable the function

Click to enable or disable battery saving mode. This function only applies to notebooks.

Click to enable or disable the timer. When enabled, move the scroll bar to the desired time. When the system is idle for more than the time period you set, the system automatically goes into the Intel® Rapid Start mode. Default time is 10 minutes.

Click to save the settings made. Click to cancel the settings made.

## Recovering the partition

This procedure allows you to delete the Intel® Rapid Start Technology from your system, and recover the partition you made for the Intel Rapid® Start Technology installation.

1. Run the **Command Prompt** tool.
2. Type `diskpart` and press **Enter**.
3. At the diskpart prompt, type `list disk` after DISKPART, and press **Enter**.

```
DISKPART> list disk
Disk ###  Status  Size  Free  Dyn  Gpt
-----  -
Disk 0    Online  2794 GB  1024 KB  Dyn  *
Disk 1    Online  59 GB   0 B      0 B
DISKPART>
```

4. Select the disk (SSD) where the Intel® Rapid Start Technology is installed for volume recovery, type `select disk x` (x = number), and press **Enter**.

```
DISKPART> select disk 1
Disk 1 is now the selected disk.
DISKPART>
```



The value "x" refers to a disk number where you want to delete the store partition.



- Type **list partition**, press **Enter**, and select the partition where the Intel® Rapid Start Technology is installed by typing **select partition x** (x = number), and press **Enter**.

```
DISKPART> list partition

Partition ###  Type              Size      Offset
-----
Partition 1   Primary           51 GB     1024 KB
Partition 2   OEM                8 GB      51 GB

DISKPART> select partition 2
Partition 2 is now the selected partition.
DISKPART>
```



The value "x" refers to a disk number where you want to delete the store partition.

- Type **delete partition override**, and press **Enter**. The diskpart utility deletes the selected partition.

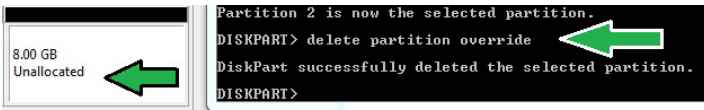

- In the desktop, click **Start**, right-click **Computer**, and click **Manage**.
- In the Computer Management window, click **Disk Management**, right click the shrunk new volume, and select **Extend Volume**.

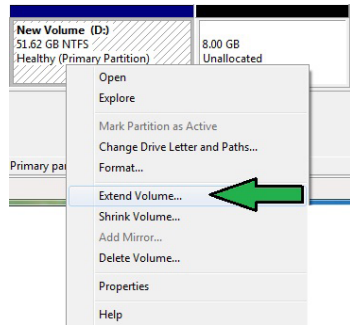

- As the Extend Volume Wizard appears, click **Next**.

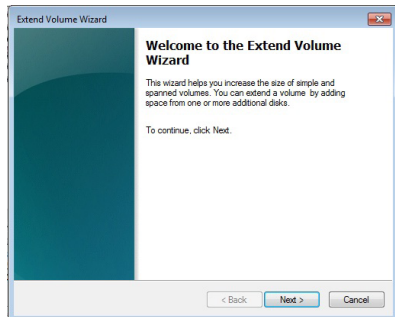

10. Click **Next** after selecting the default selected disk.

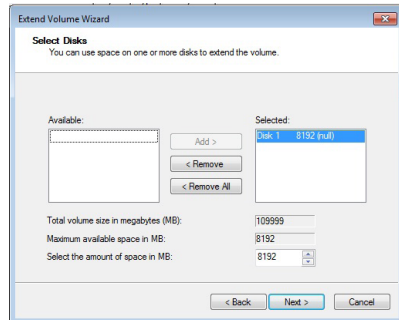

11. Extend volume setup is completed. Click **Finish** to recover the Intel® Rapid Start Technology partition.
12. Reboot the system after deleting the partition.
13. Go to **Start > Control Panel > Programs > Programs and Features >** to remove the Intel® Rapid Start Manager for the complete deletion of Intel® Rapid Start Technology.

#### 4.4.4 Intel® Smart Connect Technology

The Intel® Smart Connect Technology is a feature that provides the latest content updates and energy efficiency to your computer's platform.

Once installed and activated, the Intel® Smart Connect Technology periodically wakes up the system from sleeping mode, performs user state gathering, and initiates re-entry to sleeping mode to wake-up after a set time interval.



- Intel® Smart Connect Technology supports Windows® Live Mail, Microsoft Outlook, and Seismic applications.
- It is necessary to enable the items of the PCH Configuration in the BIOS before applying the Intel® Smart Connect Technology. Go to **Advanced Mode > Advanced > PCH Configuration**, and enable the Intel® Smart Connect Technology.

#### Installing the Intel® Smart Connect Technology

1. Place the support DVD to the optical drive.
2. Go to **Utilities**, and click **Intel® Smart Connect Technology**.
3. As the setup wizard appears, click **Next** to begin the setup.
4. Tick **I accept the terms in the License Agreement**, and click **Next**.

5. Select all and click **Next** for **Custom Setup**.

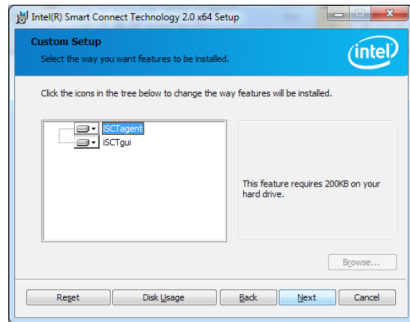

6. Click **Install** to proceed the installation.
7. Click **Yes** to restart your system, and for the newly installed Intel® Smart Connect Technology to take effect.

## Using the Intel® Smart Connect Technology



- Before the system goes to sleep mode, ensure to keep your applications on the desktop, and enter the applications, passwords.
- Ensure that the internet is in connection when enabling the Intel® Smart Connect Technology.

1. Click **Start > All Programs > Intel > Intel® Smart Connect Technology**.
2. In the **Basic** tab, click **Enable Updating**. When enabled, the **Advanced** tab is available for advanced function settings.

The Advanced tab is activated when updating is enabled

Click to view version information and help topics

Click to configure the basic settings

Click to enable or disable the function

When the scroll bar is activated, adjust the waking up time period for Internet data update.

When updating is enabled, click to reset all settings to default.

- To disable the updating function, click **Disable Updating**. Clicking this button automatically disables the configuration in the **Advanced** tab. To reset to defaults, click **Reset All to Defaults**.

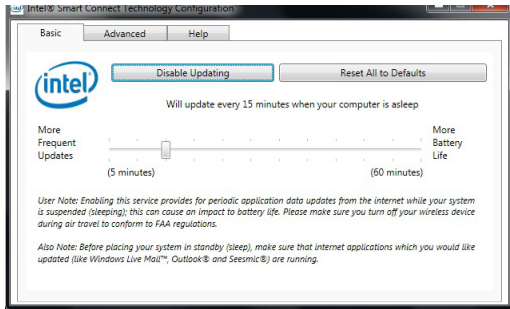

- In the **Advanced** tab, set up the schedule during low power usage time period for power saving. This setting only applies to the assigned time period.

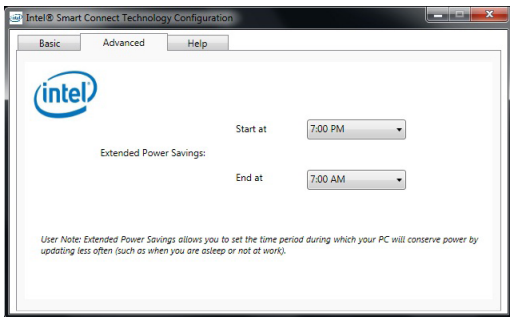

- In the **Help** tab, click **About** to view the feature's version. Click **Topics** to learn more about the Intel® Smart Connect Technology and its configuration.

## 4.5 RAID configurations

The motherboard supports the following SATA RAID solutions:

- **Intel® Rapid Storage Technology** with RAID 0, RAID 1, RAID 10 and RAID 5 support.



- You must install Windows® XP Service Pack 3 or Windows® 64-bit XP / 7 / 64-bit 7 operating systems (OS) before using Serial ATA hard disk drives. The Serial ATA RAID feature is available only if you are using Windows® XP SP3 / Windows® 64-bit XP / 7 / 64-bit 7 operating systems (OS).
- Due to Windows® XP limitation, a RAID array with the total capacity over 2TB cannot be set as a boot disk. A RAID array over 2TB can only be set as a data disk only.
- If you want to install a Windows® operating system to a hard disk drive included in a RAID set, you have to create a RAID driver disk and load the RAID driver during OS installation. Refer to section 4.5 **Creating a RAID driver disk** for details.

### 4.5.1 RAID definitions

**RAID 0 (Data striping)** optimizes two identical hard disk drives to read and write data in parallel, interleaved stacks. Two hard disks perform the same work as a single drive but at a sustained data transfer rate, double that of a single disk alone, thus improving data access and storage. Use of two new identical hard disk drives is required for this setup.

**RAID 1 (Data mirroring)** copies and maintains an identical image of data from one drive to a second drive. If one drive fails, the disk array management software directs all applications to the surviving drive as it contains a complete copy of the data in the other drive. This RAID configuration provides data protection and increases fault tolerance to the entire system. Use two new drives or use an existing drive and a new drive for this setup. The new drive must be of the same size or larger than the existing drive.

**RAID 5** stripes both data and parity information across three or more hard disk drives. Among the advantages of RAID 5 configuration include better HDD performance, fault tolerance, and higher storage capacity. The RAID 5 configuration is best suited for transaction processing, relational database applications, enterprise resource planning, and other business systems. Use a minimum of three identical hard disk drives for this setup.

**RAID 10** is data striping and data mirroring combined without parity (redundancy data) having to be calculated and written. With the RAID 10 configuration you get all the benefits of both RAID 0 and RAID 1 configurations. Use four new hard disk drives or use an existing drive and three new drives for this setup.

## 4.5.2 Installing Serial ATA hard disks

The motherboard supports Serial ATA hard disk drives. For optimal performance, install identical drives of the same model and capacity when creating a disk array.

To install the SATA hard disks for a RAID configuration:

1. Install the SATA hard disks into the drive bays.
2. Connect the SATA signal cables.
3. Connect a SATA power cable to the power connector on each drive.

## 4.5.3 Setting the RAID item in BIOS

You must enable the RAID function in the BIOS Setup before creating RAID set(s) using SATA HDDs. To do this:

1. Enter the BIOS Setup during POST.
2. Go to the **Advanced** menu > **SATA Configuration**, and then press <Enter>.
3. Set the **SATA Mode** item to [RAID Mode].
4. Save your changes, and then exit the BIOS Setup.



Refer to Chapter 3 for details on entering and navigating through the BIOS Setup.



Due to chipset limitation, when set any of SATA ports to RAID mode, all SATA ports run at RAID mode together.

## 4.5.4 Intel® Rapid Storage Technology Option ROM utility

To enter the Intel® Rapid Storage Technology Option ROM utility:

1. Turn on the system.
2. During POST, press <Ctrl> + <I> to display the utility main menu.

```
Intel(R) Rapid Storage Technology - Option ROM - v10.5.1.1070
Copyright(C) 2003-10 Intel Corporation. All Rights Reserved.

[ MAIN MENU ]
1. Create RAID Volume
2. Delete RAID Volume
3. Reset Disks to Non-RAID
4. Recovery Volume Options
5. Acceleration Options
6. Exit

[ DISK/VOLUME INFORMATION ]

RAID Volumes:
None defined.

Physical Devices:
Port Device Model Serial # Size Type/Status (Vol ID)
0 ST3160812AS 9LS0HJA4 149.0GB Non-RAID Disk
1 ST3160812AS 9LS0F4HL 149.0GB Non-RAID Disk
2 ST3160812AS 3LS0JYL8 149.0GB Non-RAID Disk
3 ST3160812AS 9LS0BJ5H 149.0GB Non-RAID Disk

[↑↓]-Select [ESC]-Exit [ENTER]-Select Menu
```

The navigation keys at the bottom of the screen allow you to move through the menus and select the menu options.



The RAID BIOS setup screens shown in this section are for reference only and may not exactly match the items on your screen.



The utility supports maximum four hard disk drives for RAID configuration.

## Creating a RAID set

To create a RAID set:

1. From the utility main menu, select **1. Create RAID Volume** and press <Enter>. The following screen appears:

```
Intel(R) Rapid Storage Technology - Option ROM - v10.5.1.1070
Copyright(C) 2003-10 Intel Corporation. All Rights Reserved.

[ CREATE VOLUME MENU ]
Name: Volume1
RAID Level: RAID0(Stripe)
Disks: Select Disks
Strip Size: 128KB
Capacity: 0.0 GB
Sync: N/A
Create Volume

[ HELP ]

Enter a unique volume name that has no special characters and is
16 characters or less.

[↑,↓]Change [TAB]-Next [ESC]-Previous Menu [ENTER]-Select
```

2. Enter a name for the RAID set and press <Enter>.
3. When the **RAID Level** item is selected, press the up/down arrow key to select a RAID level to create, and then press <Enter>.
4. When the **Disks** item is selected, press <Enter> to select the hard disk drives you want to include in the RAID set. The **SELECT DISKS** screen appears:

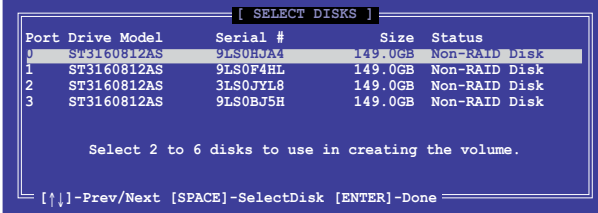

5. Use the up/down arrow key to select a drive, and then press <Space> to select. A small triangle marks the selected drive. Press <Enter> after completing your selection.
6. Use the up/down arrow key to select the stripe size for the RAID array (for RAID 0, 10 and 5 only), and then press <Enter>. The available stripe size values range from 4KB to 128KB. The following are typical values:  
RAID 0: 128KB  
RAID 10: 64KB  
RAID 5: 64KB



We recommend a lower stripe size for server systems, and a higher stripe size for multimedia computer systems used mainly for audio and video editing.

7. When the **Capacity** item is selected, enter the RAID volume capacity that you want and press <Enter>. The default value indicates the maximum allowed capacity.
8. When the **Create Volume** item is selected, press <Enter>. The following warning message appears:



9. Press <Y> to create the RAID volume and return to the main menu, or <N> to go back to the **CREATE VOLUME** menu.

## Deleting a RAID set



Take caution when deleting a RAID set. You will lose all data on the hard disk drives when you delete a RAID set.

To delete a RAID set:

1. From the utility main menu, select **2. Delete RAID Volume** and press <Enter>. The following screen appears:



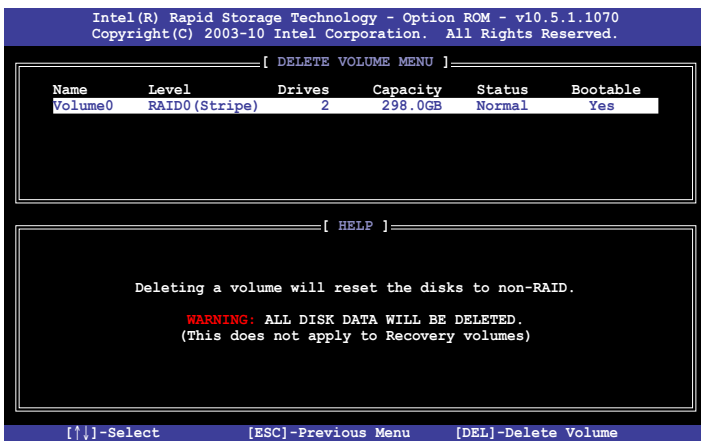

2. Use the up/down arrow key to select the RAID set you want to delete, and then press <Del>. The following warning message appears:

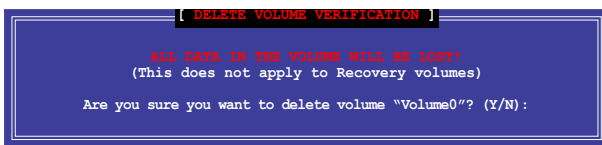

3. Press <Y> to delete the RAID set and return to the utility main menu, or press <N> to return to the **DELETE VOLUME** menu.

## Exiting the Intel® Rapid Storage Technology Option ROM utility

To exit the utility:

1. From the utility main menu, select **5. Exit**, and then press <Enter>. The following warning message appears:

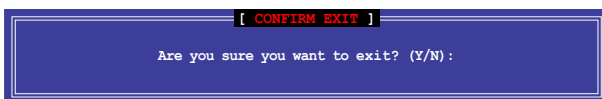

2. Press <Y> to exit or press <N> to return to the utility main menu.

## 4.6 Creating a RAID driver disk

A floppy disk with the RAID driver is required when installing a Windows® operating system on a hard disk drive that is included in a RAID set.



- **The motherboard does not provide a floppy drive connector.** You have to use a USB floppy disk drive when creating a **SATA** RAID driver disk.
- Windows® XP may not recognize the USB floppy disk drive due to Windows® XP limitation. To work around this OS limitation, refer to section **4.5.4 Using a USB floppy disk drive.**

### 4.6.1 Creating a RAID driver disk without entering the OS

To create a RAID driver disk without entering the OS:

1. Boot your computer.
2. Press <Del> during POST to enter the BIOS setup utility.
3. Set the optical drive as the primary boot device.
4. Insert the support DVD into the optical drive.
5. Save changes and exit BIOS.
6. When the **Make Disk** menu appears, press <1> to create a RAID driver disk.
7. Insert a formatted floppy disk into the USB floppy disk drive, then press <Enter>.
8. Follow the succeeding screen instructions to complete the process.

### 4.6.2 Creating a RAID driver disk in Windows®

To create a RAID driver disk in Windows®:

1. Start Windows®.
2. Plug the USB floppy disk drive and insert a floppy disk.
3. Place the motherboard support DVD into the optical drive.
4. Go to the **Make Disk** menu, and then click **Intel AHCI/RAID Driver Disk** to create a RAID driver disk.
5. Select USB floppy disk drive as the destination disk.
6. Follow the succeeding screen instructions to complete the process.



Write-protect the floppy disk to avoid a computer virus infection.

### 4.6.3 Installing the RAID driver during Windows® OS installation

To install the RAID driver in Windows® XP:

1. During the OS installation, the system prompts you to press the F6 key to install third-party SCSI or RAID driver.
2. Press <F6>, and then insert the floppy disk with RAID driver into the USB floppy disk drive.
3. When prompted to select the SCSI adapter to install, select the RAID driver for the corresponding OS version.
4. Follow the succeeding screen instructions to complete the installation.

To install the RAID driver for Windows® 7 or later OS:

1. During the OS installation, click **Load Driver** to allow you to select the installation media containing the RAID driver.
2. Insert the USB flash drive with RAID driver into the USB port or the support DVD into the optical drive, and then click **Browse**.
3. Click the name of the device you've inserted, go to **Drivers > RAID**, and then select the RAID driver for the corresponding OS version. Click **OK**.
4. Follow the succeeding screen instructions to complete the installation.



---

Before loading the RAID driver from a USB flash drive, you have to use another computer to copy the RAID driver from the support DVD to the USB flash drive.

---

## 4.6.4 Using a USB floppy disk drive

Due to OS limitations, Windows® XP may not recognize the USB floppy disk drive when you install the RAID driver from a floppy disk during the OS installation.

To solve this issue, add the USB floppy disk drive's Vendor ID (VID) and Product ID (PID) to the floppy disk containing the RAID driver. Refer to the steps below:

1. Using another computer, plug the USB floppy disk drive, and insert the floppy disk containing the RAID driver.
2. Right-click **My Computer** on the Windows® desktop or **start** menu, and then select **Manage** from the pop-up window.

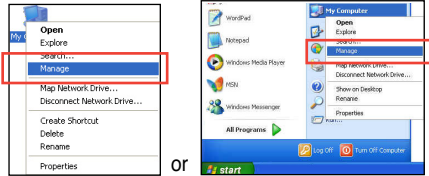

3. Select **Device Manager**. From the **Universal Serial Bus controllers**, right-click **xxxxxx USB Floppy**, and then select **Properties** from the pop-up window.



The name of the USB floppy disk drive varies with different vendors.

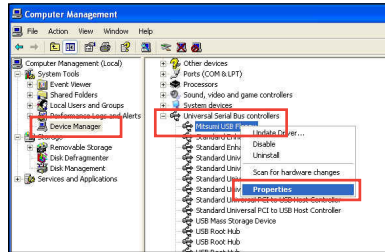

4. Click **Details** tab. The Vendor ID (VID) and Product ID (PID) are displayed.

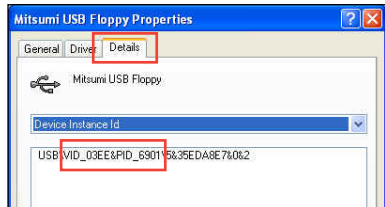

5. Browse the contents of the RAID driver disk to locate the file **txtsetup.oem**.
6. Double-click the file. A window appears, allowing you to select the program for opening the oem file.

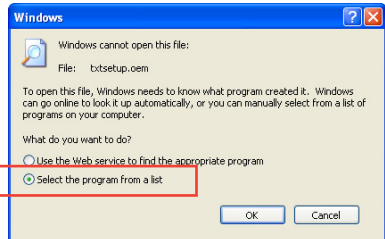

7. Use Notepad to open the file.

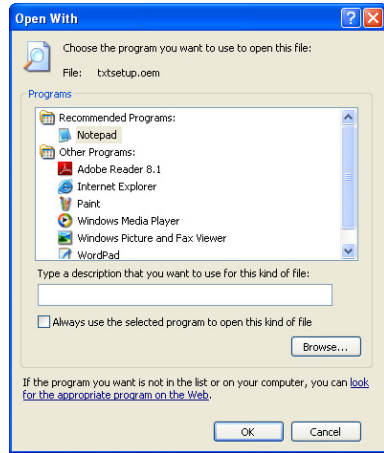

8. Find the `[HardwareIds.scsi.iaAHCI_DesktopWorkstationServer]` and `[HardwareIds.scsi.iaStor_DesktopWorkstationServer]` sections in the `txtsetup.oem` file.
9. Type the following line to the bottom of the two sections:  
`id = "USB\VID_XXXX&PID_XXXX", "usbstor"`

```
[HardwareIds.scsi.iaAHCI_DesktopWorkstationServer]
id= "PCI\VEN_8086&DEV_1C02&CC_0106", "iaStor"
id= "USB\VID_03EE&PID_6901", "usbstor"

[HardwareIds.scsi.iaStor_DesktopWorkstationServer]
id= "PCI\VEN_8086&DEV_2822&CC_0104", "iaStor"
id= "USB\VID_03EE&PID_6901", "usbstor"
```



\_\_\_\_\_

Add the same line to both sections.

\_\_\_\_\_



\_\_\_\_\_

The VID and PID vary with different vendors.

\_\_\_\_\_

10. Save and exit the file.



## 5.1 ATI® CrossFireX™ technology

The motherboard supports the ATI® CrossFireX™ technology that allows you to install multi-graphics processing units (GPU) graphics cards. Follow the installation procedures in this section.

### 5.1.1 Requirements

- In Dual CrossFireX mode, you should have two identical CrossFireX-ready graphics cards or one CrossFireX-ready dual-GPU graphics card that are ATI® certified.
- Ensure that your graphics card driver supports the ATI CrossFireX technology. Download the latest driver from the AMD website ([www.amd.com](http://www.amd.com)).
- Ensure that your power supply unit (PSU) can provide at least the minimum power required by your system. See Chapter 2 for details.



- 
- We recommend that you install additional chassis fans for better thermal environment.
  - Visit the ATI Game website (<http://game.amd.com>) for the latest certified graphics card and the supported 3D application list.
- 

### 5.1.2 Before you begin

For ATI CrossFireX to work properly, you have to uninstall all existing graphics card drivers before installing ATI CrossFireX graphics cards to your system.

To uninstall existing graphics card drivers:

1. Close all current applications.
2. For Windows XP, go to **Control Panel > Add/Remove Programs**.
3. Select your current graphics card driver/s.
4. For Windows XP, select **Add/Remove**.
5. Turn off your computer.

### 5.1.3 Installing two CrossFire™ graphics cards



The following pictures are for reference only. The graphics cards and the motherboard layout may vary with models, but the installation steps remain the same.

1. Prepare two CrossFireX-ready graphics cards.
2. Insert the two graphics card into the PCIE x16 slots. If your motherboard has more than two PCIE x16 slots, refer to Chapter 2 in this user manual for the locations of the PCIE x16 slots recommended for multi-graphics card installation.
3. Ensure that the cards are properly seated on the slots.
4. Align and firmly insert the CrossFireX bridge connector to the goldfingers on each graphics card. Ensure that the connector is firmly in place.

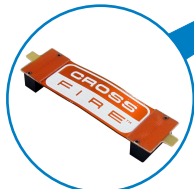
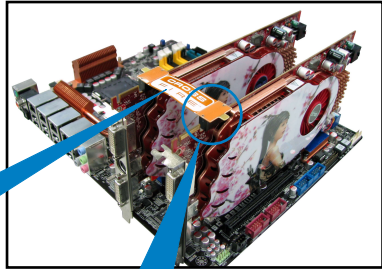
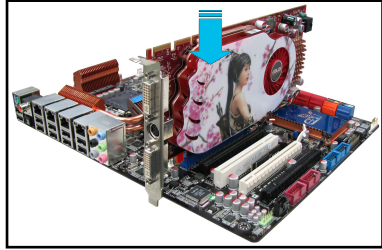

CrossFireX bridge  
(bundled with  
graphics cards)

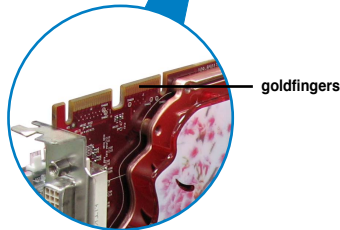

5. Connect two independent auxiliary power sources from the power supply to the two graphics cards separately.
6. Connect a VGA or a DVI cable to the graphics card.

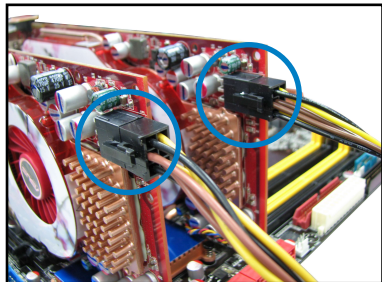



### 5.1.4 Installing the device drivers

Refer to the documentation that came with your graphics card package to install the device drivers.



Ensure that your PCI Express graphics card driver supports the ATI® CrossFireX™ technology. Download the latest driver from the AMD website ([www.amd.com](http://www.amd.com)).

### 5.1.5 Enabling the ATI® CrossFireX™ technology

After installing your graphics cards and the device drivers, enable the CrossFireX™ feature through the ATI Catalyst™ Control Center in Windows environment.

#### Launching the ATI Catalyst Control Center

To launch the ATI Catalyst Control Center:

1. Right-click on the Windows® desktop and select **Catalyst(TM) Control Center**. You can also right-click the ATI icon in the Windows notification area and select **Catalyst Control Center**.

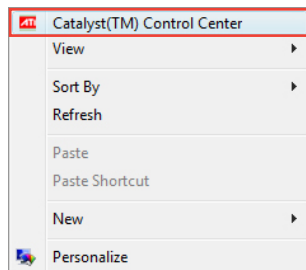

2. The **Catalyst Control Center Setup Assistant** appears when the system detects the existence of multi-graphics cards. Click **Go** to continue to the **Catalyst Control Center Advanced View** window.

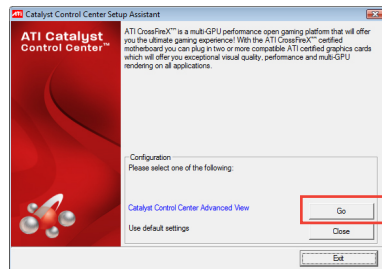

#### Enabling Dual CrossFireX technology

1. In the Catalyst Control Center window, click **Graphics Settings > CrossFireX > Configure**.
2. From the Graphics Adapter list, select the graphics card to act as the display GPU.
3. Select **Enable CrossFireX**.
4. Click **Apply**, and then click **OK** to exit the window.

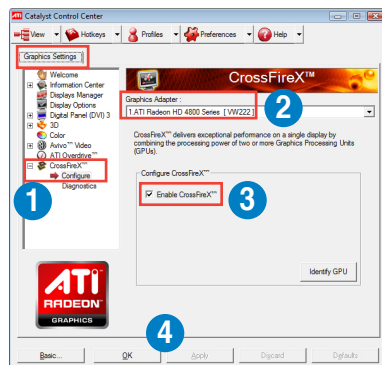

## 5.2 LucidLogix Virtu MVP

LucidLogix Virtu MVP allows your computer's VGA output and discrete graphic cards to perform better, respond faster and process media files smoother within a low power environment. Its GPU virtualization assigns tasks to the best available graphic source while the newly-designed Virtual Vsync gives you a smoother gaming experience.



- 
- LucidLogix Virtu MVP supports Windows 7® operating systems.
  - Intel® Quick Sync Video feature is supported by the 3rd/2nd generation Intel® Core™ processor family.
  - iGPU Multi-Monitor support option must be enabled in BIOS and install both Intel® Graphics Accelerator, and graphics card driver before installing LucidLogix Virtu MVP from ASUS support DVD. Refer to **3.5.4 System Configuration** for details.
  - Hyperformance® and Virtual Sync are enabled when using more than one discrete GPU at the same time.
  - Supports NVIDIA® GF4xx/5xx series and AMD® HD5xxx/6xxx series graphic cards.
  - We do not recommended to use LucidLogix Virtu MVP under RAID mode.
- 

### Installing LucidLogix Virtu MVP

To install LucidLogix Virtu MVP:

1. Insert the support DVD in the optical drive. The **ASUS Support Wizard** appears if your computer has enabled the Autorun feature.
2. Click the **Utilites** tab, then click **LucidLogix Virtu MVP Software**.
3. Follow the succeeding onscreen instructions to complete the installation.



---

After you successfully installed the LucidLogix Virtu MVP, the LucidLogix Virtu MVP icon appears in the notification area.

---

## Setting up your display

LucidLogix Virtu MVP solution comes with two distinct modes that allows you to enjoy better graphics either from your built-in video output (i-Mode) or from a discrete graphics card (d-Mode).

### i-Mode

To use LucidLogix Virtu MVP in i-Mode, the display must be connected to the onboard video output.



---

Ensure to set the Primary Display to iGPU in BIOS to activate i-Mode support.

---

### d-Mode

To use LucidLogix Virtu MVP in d-Mode, the display must be connected to the installed graphics card.



- Ensure to set the Primary Display to PCIe or PCIe/PCI in BIOS to enable d-Mode support.
  - d-Mode is recommended for an enhanced 3D gaming performance.
- 

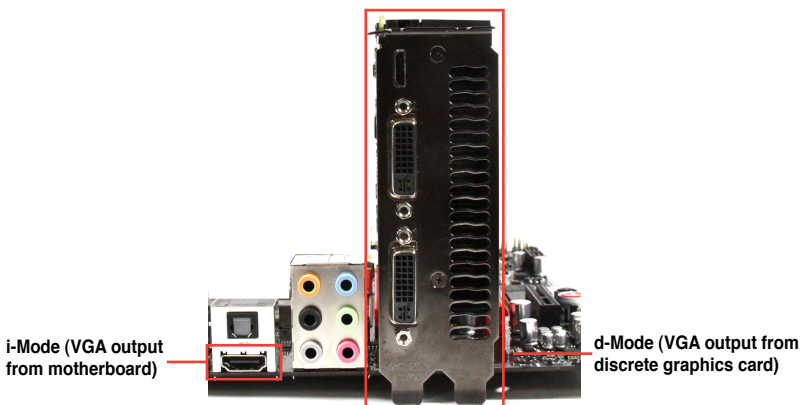

---

The motherboard's IO ports and discrete graphic card is for reference only and may vary in different models.

---

## Configuring LucidLogix Virtu MVP

Launch the Virtu MVP Control Panel to allow you to configure the main features, adjust the performance settings and select applications for graphical virtualization.

To open the control panel, right-click LucidLogix Virtu MVP icon in the notification area and select **Open Virtu MVP Control Panel**.

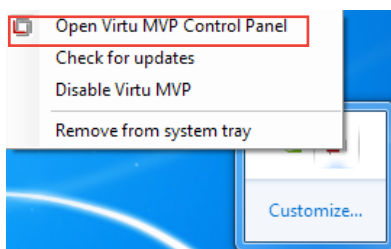

LucidLogix Virtu MVP is automatically activated when your system is powered on. Select **Remove from system tray** if you want to remove LucidLogix Virtu MVP icon from the notification area.

### Main

Allows you to turn ON/OFF the GPU virtualization. Also from the Main tab, you can set to show or hide the In-Game icon.



## Performance

Allows you to turn ON/OFF the Hyperformance® or Virtual Vsync function.

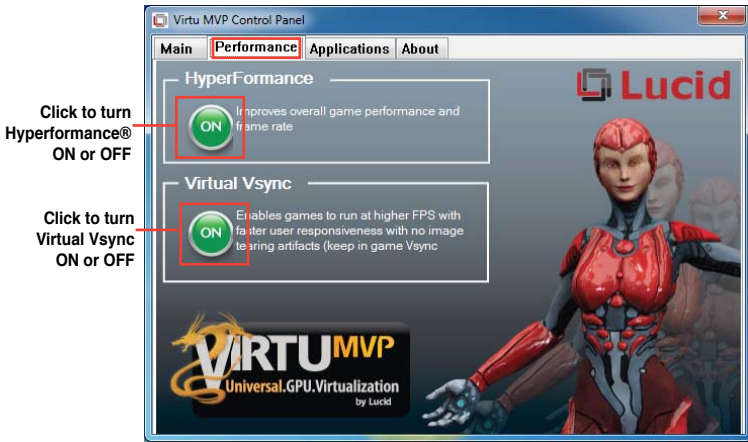



# Appendices

## Notices

### Federal Communications Commission Statement

This device complies with Part 15 of the FCC Rules. Operation is subject to the following two conditions:

- This device may not cause harmful interference.
- This device must accept any interference received including interference that may cause undesired operation.

This equipment has been tested and found to comply with the limits for a Class B digital device, pursuant to Part 15 of the FCC Rules. These limits are designed to provide reasonable protection against harmful interference in a residential installation. This equipment generates, uses and can radiate radio frequency energy and, if not installed and used in accordance with manufacturer's instructions, may cause harmful interference to radio communications. However, there is no guarantee that interference will not occur in a particular installation. If this equipment does cause harmful interference to radio or television reception, which can be determined by turning the equipment off and on, the user is encouraged to try to correct the interference by one or more of the following measures:

- Reorient or relocate the receiving antenna.
- Increase the separation between the equipment and receiver.
- Connect the equipment to an outlet on a circuit different from that to which the receiver is connected.
- Consult the dealer or an experienced radio/TV technician for help.



---

The use of shielded cables for connection of the monitor to the graphics card is required to assure compliance with FCC regulations. Changes or modifications to this unit not expressly approved by the party responsible for compliance could void the user's authority to operate this equipment.

---

### IC: Canadian Compliance Statement

Complies with the Canadian ICES-003 Class B specifications. This device complies with RSS 210 of Industry Canada. This Class B device meets all the requirements of the Canadian interference-causing equipment regulations.

This device complies with Industry Canada license exempt RSS standard(s). Operation is subject to the following two conditions: (1) this device may not cause interference, and (2) this device must accept any interference, including interference that may cause undesired operation of the device.

Cet appareil numérique de la Classe B est conforme à la norme NMB-003 du Canada. Cet appareil numérique de la Classe B respecte toutes les exigences du Règlement sur le matériel brouilleur du Canada.

Cet appareil est conforme aux normes CNR exemptes de licence d'Industrie Canada. Le fonctionnement est soumis aux deux conditions suivantes :

- (1) cet appareil ne doit pas provoquer d'interférences et
- (2) cet appareil doit accepter toute interférence, y compris celles susceptibles de provoquer un fonctionnement non souhaité de l'appareil.

## Canadian Department of Communications Statement

This digital apparatus does not exceed the Class B limits for radio noise emissions from digital apparatus set out in the Radio Interference Regulations of the Canadian Department of Communications.

This class B digital apparatus complies with Canadian ICES-003.

## VCCI: Japan Compliance Statement

### VCCI Class B Statement

情報処理装置等電波障害自主規制について

この装置は、情報処理装置等電波障害自主規制協議会（VCCI）の基準に基づくクラスB情報技術装置です。この装置は家庭環境で使用されることを目的としていますが、この装置がラジオやテレビジョン受信機に近接して使用されると、受信障害を引き起こすことがあります。

取扱説明書に従って正しい取り扱いをして下さい。

## KC: Korea Warning Statement

B급 기기 (가정용 방송통신기자재)

이 기기는 가정용(B급) 전자파적합기기로서 주로 가정에서 사용하는 것을 목적으로 하며, 모든 지역에서 사용할 수 있습니다.

\*당해 무선설비는 전파혼신 가능성이 있으므로 인명안전과 관련된 서비스는 할 수 없습니다.

## REACH

Complying with the REACH (Registration, Evaluation, Authorisation, and Restriction of Chemicals) regulatory framework, we published the chemical substances in our products at ASUS REACH website at <http://csr.asus.com/english/REACH.htm>.



DO NOT throw the motherboard in municipal waste. This product has been designed to enable proper reuse of parts and recycling. This symbol of the crossed out wheeled bin indicates that the product (electrical and electronic equipment) should not be placed in municipal waste. Check local regulations for disposal of electronic products.



DO NOT throw the mercury-containing button cell battery in municipal waste. This symbol of the crossed out wheeled bin indicates that the battery should not be placed in municipal waste.

## ASUS Recycling/Takeback Services

ASUS recycling and takeback programs come from our commitment to the highest standards for protecting our environment. We believe in providing solutions for you to be able to responsibly recycle our products, batteries, other components as well as the packaging materials. Please go to <http://csr.asus.com/english/Takeback.htm> for detailed recycling information in different regions.



## RF Equipment Notices

### CE: European Community Compliance Statement

The equipment complies with the RF Exposure Requirement 1999/519/EC, Council Recommendation of 12 July 1999 on the limitation of exposure of the general public to electromagnetic fields (0–300 GHz). This wireless device complies with the R&TTE Directive.

### Wireless Radio Use

This device is restricted to indoor use when operating in the 5.15 to 5.25 GHz frequency band.

### Exposure to Radio Frequency Energy

The radiated output power of the Wi-Fi technology is below the FCC radio frequency exposure limits. Nevertheless, it is advised to use the wireless equipment in such a manner that the potential for human contact during normal operation is minimized.

### FCC Bluetooth Wireless Compliance

The antenna used with this transmitter must not be colocated or operated in conjunction with any other antenna or transmitter subject to the conditions of the FCC Grant.

### Bluetooth Industry Canada Statement

This Class B device meets all requirements of the Canadian interference-causing equipment regulations.

Cet appareil numérique de la Class B respecte toutes les exigences du Règlement sur le matériel brouilleur du Canada.

### BSMI: Taiwan Wireless Statement

#### 無線設備的警告聲明

經型式認證合格之低功率射頻電機，非經許可，公司、商號或使用者均不得擅自變更射頻、加大功率或變更原設計之特性及功能。低功率射頻電機之使用不得影響飛航安全及干擾合法通信；經發現有干擾現象時，應立即停用，並改善至無干擾時方得繼續使用。前項合法通信指依電信法規定作業之無線通信。低功率射頻電機須忍受合法通信或工業、科學及醫療用電波輻射性電機設備之干擾。

於 5.25GHz 至 5.35GHz 區域內操作之  
無線設備的警告聲明

工作頻率 5.250 ~ 5.350GHz 該頻段限於室內使用。

### Japan RF Equipment Statement

この製品は、周波数帯域5.15～5.35GHzで動作しているときは、屋内においてのみ使用可能です。

### KC (RF Equipment)

대한민국 규정 및 준수

방통위 고시에 따른 고지사항

해당 무선설비는 운용 중 전파혼신 가능성이 있음,

이 기기는 인명안전과 관련된 서비스에 사용할 수 없습니다.

## ASUS contact information

### ASUSTeK COMPUTER INC.

Address	15 Li-Te Road, Peitou, Taipei, Taiwan 11259
Telephone	+886-2-2894-3447
Fax	+886-2-2890-7798
E-mail	info@asus.com.tw
Web site	www.asus.com.tw

#### *Technical Support*

Telephone	+86-21-38429911
Online support	support.asus.com

### ASUS COMPUTER INTERNATIONAL (America)

Address	800 Corporate Way, Fremont, CA 94539, USA
Telephone	+1-812-282-3777
Fax	+1-510-608-4555
Web site	usa.asus.com

#### *Technical Support*

Telephone	+1-812-282-2787
Support fax	+1-812-284-0883
Online support	support.asus.com

### ASUS COMPUTER GmbH (Germany and Austria)

Address	Harkort Str. 21-23, D-40880 Ratingen, Germany
Fax	+49-2102-959911
Web site	www.asus.de
Online contact	www.asus.de/sales

#### *Technical Support*

Telephone	+49-1805-010923*
Support Fax	+49-2102-9599-11
Online support	support.asus.com

\* EUR 0.14/minute from a German fixed landline; EUR 0.42/minute from a mobile phone.

# DECLARATION OF CONFORMITY

Per FCC Part 2 Section 2.1077(a)



Responsible Party Name: **Asus Computer International**

Address: **800 Corporate Way, Fremont, CA 94539.**

Phone/Fax No: **(510)739-3777/(510)608-4555**

hereby declares that the product

**Product Name : Motherboard**

**Model Number : P8H77-M PRO**

Conforms to the following specifications:

- FCC Part 15, Subpart B, Unintentional Radiators
- FCC Part 15, Subpart C, Intentional Radiators
- FCC Part 15, Subpart E, Intentional Radiators

### Supplemental Information:

Representative Person's Name : Steve Chang / President

*Steve Chang*

Signature :

Date : Jan. 06, 2012

Ver. 110101

# EC Declaration of Conformity



Leading Innovation. Persistent Perfection

We, the undersigned,

Manufacturer: ASUSTek COMPUTER INC.  
 Address, City: No. 156, LI-TE RD., FEITOU, TAIPEI 112, TAIWAN R.O.C.  
 Country: TAIWAN  
 Authorized representative in Europe: ASUS COMPUTER GmbH  
 Address, City: HARKORT STR. 21-23, 40880 RATINGEN  
 Country: GERMANY

declare the following apparatus:

Product name : Motherboard  
 Model name : P8H77-M PRO

conform with the essential requirements of the following directives:

EN 55022:2006+A1:2007  
 EN 61000-3-2:2006  
 EN 55013:2001+A1:2003+A2:2006  
 EN 55024:1988+A1:2001+A2:2003  
 EN 61000-3-3:2008  
 EN 55020:2007

**1999/5/EC-R & TTE Directive**

EN 300 328 V1.7.1 (2006-10)  
 EN 300 328 V1.7.1 (2006-10)  
 EN 300 440-2 V1.2 (2008-03)  
 EN 301 488-1 V1.3.1 (2005-08)  
 EN 301 488-7 V1.3.1 (2005-11)  
 EN 301 488-9 V1.4.1 (2007-11)  
 EN 301 488-10 V1.4.1 (2007-11)  
 EN 301 488-11 V1.4.1 (2007-11)  
 EN 301 488-12 V1.4.1 (2007-11)  
 EN 301 488-13 V1.4.1 (2007-11)  
 EN 301 488-14 V1.4.1 (2007-11)  
 EN 301 488-15 V1.4.1 (2007-11)  
 EN 302 328-2 V1.2.2 (2007-09)  
 EN 302 328-3 V1.3.1 (2007-09)  
 EN 301 357-2 V1.3.1 (2006-05)  
 EN 301 357-3 V1.3.1 (2006-05)  
 EN 302 323 V1.1.1 (2005-01)

**2006/95/EC-LVD Directive**

EN 60950-1 /A1:2009  
 EN 60950-1 /A12:2011  
 EN 60065:2002/A1:2006  
 EN 60065:2002 /A12:2011

**2009/125/EC-ERP Directive**

Regulation (EC) No. 1275/2008  
 EN 62301:2005  
 EN 62301:2005  
 EN 62301:2005  
 EN 62301:2005

Ver. 111121



(EC conformity marking)

Position : **CEO**  
 Name : **Jerry Shen**

Signature :

Declaration Date: **Jan. 06, 2012**  
 Year to begin affixing CE marking: **2012**

Blank lined page for writing.