

SABERTOOTH X99



Motherboard

Copyright© 2015 ASUSTeK COMPUTER INC. All Rights Reserved.

No part of this manual, including the products and software described in it, may be reproduced, transmitted, transcribed, stored in a retrieval system, or translated into any language in any form or by any means, except documentation kept by the purchaser for backup purposes, without the express written permission of ASUSTeK COMPUTER INC. ("ASUS").

Product warranty or service will not be extended if: (1) the product is repaired, modified or altered, unless such repair, modification of alteration is authorized in writing by ASUS; or (2) the serial number of the product is defaced or missing.

ASUS PROVIDES THIS MANUAL "AS IS" WITHOUT WARRANTY OF ANY KIND, EITHER EXPRESS OR IMPLIED, INCLUDING BUT NOT LIMITED TO THE IMPLIED WARRANTIES OR CONDITIONS OF MERCHANTABILITY OR FITNESS FOR A PARTICULAR PURPOSE. IN NO EVENT SHALL ASUS, ITS DIRECTORS, OFFICERS, EMPLOYEES OR AGENTS BE LIABLE FOR ANY INDIRECT, SPECIAL, INCIDENTAL, OR CONSEQUENTIAL DAMAGES (INCLUDING DAMAGES FOR LOSS OF PROFITS, LOSS OF BUSINESS, LOSS OF USE OR DATA, INTERRUPTION OF BUSINESS AND THE LIKE), EVEN IF ASUS HAS BEEN ADVISED OF THE POSSIBILITY OF SUCH DAMAGES ARISING FROM ANY DEFECT OR ERROR IN THIS MANUAL OR PRODUCT.

SPECIFICATIONS AND INFORMATION CONTAINED IN THIS MANUAL ARE FURNISHED FOR INFORMATIONAL USE ONLY, AND ARE SUBJECT TO CHANGE AT ANY TIME WITHOUT NOTICE, AND SHOULD NOT BE CONSTRUED AS A COMMITMENT BY ASUS. ASUS ASSUMES NO RESPONSIBILITY OR LIABILITY FOR ANY ERRORS OR INACCURACIES THAT MAY APPEAR IN THIS MANUAL, INCLUDING THE PRODUCTS AND SOFTWARE DESCRIBED IN IT.

Products and corporate names appearing in this manual may or may not be registered trademarks or copyrights of their respective companies, and are used only for identification or explanation and to the owners' benefit, without intent to infringe.

Offer to Provide Source Code of Certain Software

This product contains copyrighted software that is licensed under the General Public License ("GPL"), under the Lesser General Public License Version ("LGPL") and/or other Free Open Source Software Licenses. Such software in this product is distributed without any warranty to the extent permitted by the applicable law. Copies of these licenses are included in this product.

Where the applicable license entitles you to the source code of such software and/or other additional data, you may obtain it for a period of three years after our last shipment of the product, either

(1) for free by downloading it from <http://support.asus.com/download>

or

(2) for the cost of reproduction and shipment, which is dependent on the preferred carrier and the location where you want to have it shipped to, by sending a request to:

ASUSTeK Computer Inc.
Legal Compliance Dept.
15 Li Te Rd.,
Beitou, Taipei 112
Taiwan

In your request please provide the name, model number and version, as stated in the About Box of the product for which you wish to obtain the corresponding source code and your contact details so that we can coordinate the terms and cost of shipment with you.

The source code will be distributed WITHOUT ANY WARRANTY and licensed under the same license as the corresponding binary/object code.

This offer is valid to anyone in receipt of this information.

ASUSTeK is eager to duly provide complete source code as required under various Free Open Source Software licenses. If however you encounter any problems in obtaining the full corresponding source code we would be much obliged if you give us a notification to the email address gpl@asus.com, stating the product and describing the problem (please DO NOT send large attachments such as source code archives, etc. to this email address).

Contents

Safety information.....	vi
About this guide.....	vii
SABERTOOTH X99	
specifications summary	ix
Package contents.....	xiv
Installation tools and components	xv
Chapter 1: Product Introduction	
1.1 Special features.....	1-1
1.1.1 Product highlights.....	1-1
1.1.2 “Ultimate COOL” Thermal Solutions	1-2
1.1.3 “TUF Engine” Power Design	1-3
1.1.4 “Safe & Stable!” Guardian Angel.....	1-3
1.1.5 ASUS EZ DIY.....	1-4
1.1.6 ASUS Exclusive Features.....	1-5
1.1.7 Other special features.....	1-6
1.2 Motherboard overview.....	1-7
1.2.1 Before you proceed.....	1-7
1.2.2 Motherboard layout.....	1-8
1.2.3 Central Processing Unit (CPU)	1-10
1.2.4 System memory	1-11
1.2.5 Expansion slots.....	1-22
1.2.6 Onboard buttons	1-24
1.2.7 Jumpers	1-25
1.2.8 Onboard LEDs	1-27
1.2.9 Internal connectors.....	1-28
Chapter 2: Basic installation	
2.1 Building your PC system.....	2-1
2.1.1 Motherboard installation.....	2-1
2.1.2 CPU installation.....	2-3
2.1.3 CPU heatsink and fan assembly installation	2-4
2.1.4 DIMM installation.....	2-6
2.1.5 ATX Power connection.....	2-7
2.1.6 SATA device connection	2-8
2.1.7 Front I/O Connector	2-9
2.1.8 Expansion Card installation.....	2-10
2.2 BIOS update utility.....	2-11

2.3	Motherboard rear and audio connections	2-12
2.3.1	Rear I/O connection	2-12
2.3.2	Audio I/O connections	2-14
2.4	Starting up for the first time	2-16
2.5	Turning off the computer	2-16

Chapter 3: BIOS setup

3.1	Knowing BIOS	3-1
3.2	BIOS setup program	3-2
3.2.1	EZ Mode.....	3-3
3.2.2	Advanced Mode	3-4
3.2.3	Q-Fan Control	3-7
3.2.4	EZ Tuning Wizard	3-9
3.3	My Favorites	3-11
3.4	Main menu	3-13
3.5	Ai Tweaker menu	3-15
3.6	Advanced menu	3-34
3.6.1	CPU Configuration	3-35
3.6.2	PCH Configuration	3-38
3.6.3	PCH Storage Configuration.....	3-39
3.6.4	System Agent Configuration	3-41
3.6.5	USB Configuration	3-43
3.6.6	Platform Misc Configuration.....	3-45
3.6.7	Onboard Devices Configuration	3-46
3.6.8	APM Configuration	3-49
3.6.9	Network Stack Configuration.....	3-50
3.6.10	NVMe Configuration.....	3-50
3.7	Monitor menu	3-51
3.8	Boot menu	3-56
3.9	Tool menu	3-62
3.9.1	ASUS EZ Flash 2 Utility	3-62
3.9.2	ASUS O.C. Profile.....	3-63
3.9.3	ASUS DRAM SPD Information	3-64

3.10	Exit menu	3-65
3.11	Updating BIOS	3-66
3.11.1	EZ Update	3-66
3.11.2	ASUS EZ Flash 2.....	3-67
3.11.3	ASUS CrashFree BIOS 3.....	3-68

Chapter 4: Software support

4.1	Installing an operating system	4-1
4.2	Support DVD information	4-1
4.2.1	Running the support DVD	4-1
4.2.2	Obtaining the software manuals.....	4-3
4.3	Software information	4-4
4.4	AI Suite 3.....	4-4
4.4.1	Ai Charger+.....	4-10
4.4.2	EZ Update	4-11
4.4.3	USB BIOS Flashback.....	4-13
4.4.4	Push Notice.....	4-15
4.4.5	USB 3.1 Boost.....	4-18
4.4.6	System Information	4-19
4.4.7	USB Charger+.....	4-21
4.4.8	Version	4-22
4.5	Turbo LAN.....	4-23
4.6	TUF Detective	4-24
4.6.1	Post.....	4-24
4.6.2	Control.....	4-25
4.6.3	Monitor	4-26
4.6.4	Information	4-27
4.7	Audio configurations	4-28

Chapter 5: RAID support

5.1	RAID configurations	5-1
5.1.1	RAID definitions	5-1
5.1.2	Installing Serial ATA hard disks	5-2
5.1.3	Setting the RAID item in BIOS	5-2
5.1.4	Intel® Rapid Storage Technology Option ROM utility.....	5-3
5.2	Installing the RAID driver during Windows® OS installation	5-7

Appendices

Notices	A-1
ASUS contact information.....	A-5

Safety information

Electrical safety

- To prevent electrical shock hazard, disconnect the power cable from the electrical outlet before relocating the system.
- When adding or removing devices to or from the system, ensure that the power cables for the devices are unplugged before the signal cables are connected. If possible, disconnect all power cables from the existing system before you add a device.
- Before connecting or removing signal cables from the motherboard, ensure that all power cables are unplugged.
- Seek professional assistance before using an adapter or extension cord. These devices could interrupt the grounding circuit.
- Ensure that your power supply is set to the correct voltage in your area. If you are not sure about the voltage of the electrical outlet you are using, contact your local power company.
- If the power supply is broken, do not try to fix it by yourself. Contact a qualified service technician or your retailer.

Operation safety

- Before installing the motherboard and adding devices on it, carefully read all the manuals that came with the package.
- Before using the product, ensure all cables are correctly connected and the power cables are not damaged. If you detect any damage, contact your dealer immediately.
- To avoid short circuits, keep paper clips, screws, and staples away from connectors, slots, sockets and circuitry.
- Avoid dust, humidity, and temperature extremes. Do not place the product in any area where it may become wet.
- Place the product on a stable surface.
- If you encounter technical problems with the product, contact a qualified service technician or your retailer.

About this guide

This user guide contains the information you need when installing and configuring the motherboard.

How this guide is organized

This guide contains the following parts:

- **Chapter 1: Product introduction**
This chapter describes the features of the motherboard and the new technology it supports. It includes description of the switches, jumpers, and connectors on the motherboard.
- **Chapter 2: Basic installation**
This chapter lists the hardware setup procedures that you have to perform when installing system components.
- **Chapter 3: BIOS setup**
This chapter tells how to change system settings through the BIOS Setup menus. Detailed descriptions of the BIOS parameters are also provided.
- **Chapter 4: Software support**
This chapter describes the contents of the support DVD that comes with the motherboard package and the software.
- **Chapter 5: RAID support**
This chapter describes the RAID configurations.

Where to find more information

Refer to the following sources for additional information and for product and software updates.

1. **ASUS websites**
The ASUS website provides updated information on ASUS hardware and software products. Refer to the ASUS contact information.
2. **Optional documentation**
Your product package may include optional documentation, such as warranty flyers, that may have been added by your dealer. These documents are not part of the standard package.

Conventions used in this guide

To ensure that you perform certain tasks properly, take note of the following symbols used throughout this manual.



DANGER/WARNING: Information to prevent injury to yourself when trying to complete a task.



CAUTION: Information to prevent damage to the components when trying to complete a task



IMPORTANT: Instructions that you **MUST** follow to complete a task.



NOTE: Tips and additional information to help you complete a task.

Typography

Bold text

Indicates a menu or an item to select.

Italics

Used to emphasize a word or a phrase.

<Key>

Keys enclosed in the less-than and greater-than sign means that you must press the enclosed key.

Example: <Enter> means that you must press the Enter or Return key.

<Key1> + <Key2> + <Key3>

If you must press two or more keys simultaneously, the key names are linked with a plus sign (+).

SABERTOOTH X99

specifications summary

CPU	<p>New Intel® Core™ i7 Processors on LGA 2011-v3 Socket Supports 22nm CPU Supports Intel® Turbo Boost Technology 2.0*</p> <p>* The support of these features depends on the CPU types. ** Refer to www.asus.com for the complete CPU support list.</p>
Chipset	Intel® X99 Express Chipset
Memory	<p>8 x DIMM, max. 64 GB, DDR4 2400/2133 MHz, non-ECC, unbuffered Memory Quad channel memory architecture Supports Intel® Extreme Memory Profile (XMP)</p> <p>* Hyper DIMM support is subject to the physical characteristics of individual CPUs. Please refer to Memory QVL (Qualified Vendors List) for details. * Refer to www.asus.com or this user guide for the complete the Memory QVL (Qualified Vendors List).</p>
Expansion slots	<p>40-Lane CPU- 3 x PCI Express 3.0/2.0 x16 slots (single@x16 or dual@x16/x16, triple@x16/x16/x8) 1 x PCI Express 2.0 x4 slot (max. at x2 mode, compatible with PCIe x1 and x2 devices) 1 x PCI Express 2.0 x1 slots</p> <p>28-Lane CPU- 3 x PCI Express 3.0/2.0 x16 slots* (single@x16, dual@x16/x8, triple@x16/x8/x4) 1 x PCI Express 2.0 x4 slot (max. at x2 mode, compatible with PCIe x1 and x2 devices) 2 x PCI Express 2.0 x1 slot</p> <p>* The PCIe x16_3 slot shares bandwidth with M.2 x4. When M.2 socket is occupied, the PCIe x16_3 slot will be disabled.</p>
Multi-GPU support	<p>Supports NVIDIA® 3-Way/Quad-GPU SLI™ Technology (with 2 PCIe x16 graphics card) Supports AMD® 3-Way/Quad-GPU CrossFireX™ Technology</p>

(continued on the next page)

SABERTOOTH X99

specifications summary

LAN	<p>Dual Gigabit LAN controller - 802.3az Energy Efficient Ethernet (EEE) appliance</p> <p>Intel® I218-V Gigabit LAN controller - Dual interconnect between the integrated LAN controller and physical layer (PHY)</p> <p>Realtek® 8111GR Gigabit LAN controller</p>
Storage	<p>New Intel® Core™ i7 Processors</p> <ul style="list-style-type: none"> - 1 x M.2 x4 Socket 3 with M Key, type 2242/2260/2280/22110 storage devices support (Support PCIE SSD only) <p>Intel® X99 Express Chipset with RAID 0, 1, 5, 10 and Intel Rapid Storage Technology 13 support</p> <ul style="list-style-type: none"> - 1 x SATA Express Port (gray, compatible with 2 x SATA 6.0 Gb/s ports) - 8 x SATA 6.0 Gb/s ports* (4 x beige/gray from controller 1, 4 x black from controller 2) - Supports Intel® Smart Response Technology, Intel® Rapid Recovery Technology** <p>* Due to chipset behavior, the SATA6G_78, SATA6G_910 ports (black) do not support IRST including RAID</p> <p>** These functions will work depending on the CPU installed.</p>
Audio	<p>Realtek® ALC1150 8-channel High definition audio CODEC</p> <ul style="list-style-type: none"> - Audio shielding ensures precision analog/digital separation and greatly reduced multi-lateral interference - Separate layer for left and right track, ensuring both sound deliver equal quality - Top notch audio sensation delivers according to the audio configuration - Audio Amplifier to enhance the highest quality sound for headphone and speakers - High Quality 112dB SNR stereo playback output (Line-out at rear) and 104dB SNR recording input (Line-in) support - Absolute pitch 192khz/24bit true BD lossless sound - BD Audio Layer Content Protection - Supports Jack-Detection, Multi-streaming, and Front Panel Jack-Retasking - Optical S/PDIF out ports at rear I/O
USB	<p>Intel® X99 Express Chipset - supports ASUS USB 3.1 Boost</p> <ul style="list-style-type: none"> - 4 x USB 3.0/2.0 ports at mid-board for front panel support - 4 x USB 3.0/2.0 ports at rear panel (blue) - 8 x USB 2.0/1.1 ports (4 ports at mid-board, 4 ports at rear panel) <p>1 x ASMedia® USB 3.1 controller - supports ASUS USB 3.1 Boost</p> <ul style="list-style-type: none"> - 2 x USB 3.1/3.0 ports at back panel (teal blue)

(continued on the next page)

SABERTOOTH X99

specifications summary

<p>Exclusive TUF Features</p>	<p>“Ultimate COOL!” Thermal Solution</p> <ul style="list-style-type: none"> - TUF Thermal Armor - TUF Thermal Radar 2 with Thermistors - TUF ICe <p>“We Got Your Back” Shape Force</p> <ul style="list-style-type: none"> - TUF Fortifier <p>“TUF ENGINE” Power Design</p> <ul style="list-style-type: none"> - 8+2 Digital Phase Power Design - TUF Components (10K Ti-Cap, Choke & MOSFET; certified by military-standard) - ASUS DIGI+ Power Control Utility <p>“SAFE & Stable!” Guardian Angel</p> <ul style="list-style-type: none"> - TUF Detective - TUF ESD Guards 2 - Dust Defenders with connector caps and rear I/O dust filter - MemOK!
<p>Other Special Features</p>	<ul style="list-style-type: none"> - USB 3.1 Boost featuring speedy USB 3.1 transmission - USB BIOS Flashback with USB BIOS Flashback Wizard for EZ BIOS download scheduling - USB Charger+ featuring quick-charging function for all smart devices - ASUS Remote GO! with Cloud GO! Remote Desktop, Remote Keyboard and Mouse, and File Transfer - ASUS UEFI BIOS EZ Mode featuring user-friendly graphics user interface - Turbo LAN to experience smooth online gaming with lower pings and less lags - Push Notice monitors your PC status with smart devices in real time - AI Suite 3 - ASUS Q-Connector - ASUS Q-Shield - ASUS Q-LED (CPU, DRAM, VGA, Boot Device LED) - ASUS Q-Slot - ASUS Q-DIMM - ASUS O.C. Profile - ASUS CrashFree BIOS 3 - ASUS EZ Update - Disk Unlocker - ASUS EZ Flash 2 - Multi-language BIOS

(continued on the next page)

SABERTOOTH X99

specifications summary

<p>Back Panel I/O Ports</p>	<ul style="list-style-type: none"> 1 x Optical S/PDIF Output 1 x USB BIOS Flashback button 2 x LAN (RJ45) port 2 x USB 3.1/3.0 ports (teal blue, supports ASUS USB 3.1 Boost) 4 x USB 3.0/2.0 ports (blue, 1 supports USB BIOS Flashback) 4 x USB 2.0/1.1 ports 8-channel Audio I/O ports
<p>Internal I/O connectors</p>	<ul style="list-style-type: none"> 2 x USB 3.0/2.0 connector support additional 4 USB 3.0/2.0 ports (19-pin; beige) 2 x USB 2.0/1.1 connectors support additional 4 USB 2.0/1.1 ports 8 x SATA 6 Gb/s connectors (2 x beige; 2 x gray at beneath of SATA Express connector; 4 x black) 1 x CPU Fan connector (4-pin white) for both 4-pin (PWM mode) and 3-pin (DC mode) CPU coolers control with auto detection support 1 x CPU OPT Fan connector (4-pin black) for both 4-pin(PWM mode) and 3-pin(DC mode) CPU coolers control 4 x Chassis Fan connectors (4-pin Black) for both 4-pin (PWM mode) and 3-pin (DC mode) CPU coolers control 5 x Assistant Fan connectors (4 x 4-pin [beige]; 1 x 4-pin for dust de-fan [white]) Front panel audio connector (AAFP) 24-pin EATX Power connector 8 + 4-pin EATX Power connector System panel (Q-Connector) 1 x MemOK! button 1 x DRCT (DirectKey) connector 3 x Thermal Sensor (T_Sensor) headers 1 x chassis intrusion header 1 x S/PDIF Out header 1 x TPM header 1 x Thunderbolt header (5-pin) for ASUS ThunderboltEX series support 1 x Clear CMOS jumper

SABERTOOTH X99

specifications summary

BIOS Features	128 Mb Flash ROM, UEFI AMI BIOS, PnP, DMI 2.7, WfM 2.0, SM BIOS 2.7, ACPI 5.0, Multi-language BIOS, ASUS EZ Flash 2, CrashFree BIOS 3, F11 EZ Tuning Wizard, F6 Qfan Control, F3 My Favorites, Quick Note, Last Modified Log, F12 PrintScreen function, F3 Shortcut functions, and ASUS DRAM SPD (Serial Presence Detect) memory information
Manageability	WfM 2.0, DMI 2.7, WOL by PME, PXE
Support DVD contents	Drivers Anti-virus software (OEM version) ASUS/TUF CPU-Z ASUS Utilities
Form factor	ATX form factor: 12.0 in. x 9.6 in. (30.5 cm x 24.4 cm)



Specifications are subject to change without notice.

Package contents

Check your motherboard package for the following items

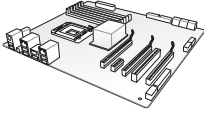

ASUS SABERTOOTH X99 motherboard



Technical documentations, certification and warranty card



Support DVD

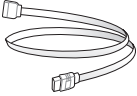

6 x Serial ATA 6.0 Gb/s cables



1 x ASUS SLI™ bridge connector (12 cm)

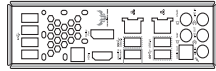

1 x ASUS Q-Shield



1 x 2-in-1 ASUS Q-Connector kit

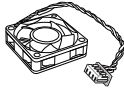

1 x 40 mm Assistant fan

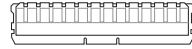

4 x DRAM slot covers

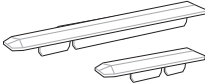

**2 x PCIe x16 slot covers
1 x PCIe x1 slot covers**



1 x PCIe x4 slot covers



3 x Thermistor cables



TUF Accessory Installation Guide

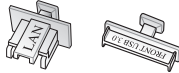

1 x Connector cap set (LAN cap and Front USB 3.0 cap)



5 x Audio connector caps



**9 x SATA connector caps
1 x SATA Express connector cap
11 x Back I/O USB connector caps**



2 x Onboard USB 2.0 connector caps



- If any of the above items is damaged or missing, contact your retailer.
- The illustrated items above are for reference only. Actual product specifications may vary with different models.

Installation tools and components

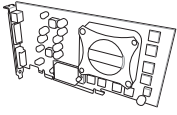

Graphics card (optional)



Philips (cross) screwdriver



PC chassis

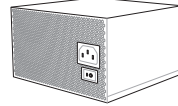

Power supply unit

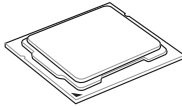

Intel® LGA2011-v3 CPU

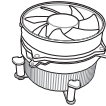

Intel® LGA2011-v3 compatible CPU Fan

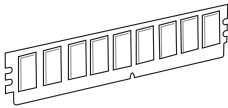

DIMM

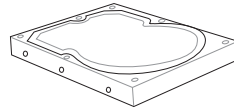

SATA hard disk drive

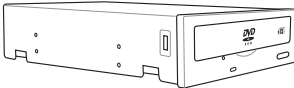

SATA optical disc drive (optional)



The tools and components in the table above are not included in the motherboard package.

Product introduction

1

1.1 Special features

1.1.1 Product highlights

LGA2011-v3 socket for Intel® Core™ i7 processors

This motherboard supports Intel® Core™ i7 processors in the LGA 2011 -v3 package. It provides great graphics and system performance with its GPU, quad-Channel DDR4 memory slots and PCI Express 2.0/3.0 expansion slots.

Intel® X99 Express Chipset

Intel® X99 Express Chipset is a single chipset that supports the LGA2011-v3 socket for the Intel® Core™ i7 processors. It utilizes the serial point-to-point links, which increases bandwidth and enhances the system's performance. It natively supports up to eight (8) USB 3.0 ports, fourteen (14) SATA 6Gb/s ports, and M.2 support for faster data retrieval. It also enables the iGPU function for Intel® integrated graphics performance.

PCI Express® 3.0

PCI Express® 3.0 (PCIe 3.0) is the PCI Express bus standard that provides twice the performance and speed of PCIe 2.0. It provides an optimal graphics performance, unprecedented data speed and seamless transition with its complete backward compatibility to PCIe 1.0/2.0 devices.

3-WAY/QUAD-GPU SLI and 3-WAY CrossFireX™ Support

The motherboard features NVIDIA 3 WAY/Quad SLI and 3-Way AMD CrossfireX support that enables multi-GPU setup, giving you the full power of the latest graphics technologies.

SATA Express support

SATA Express provides faster data transfer speeds of up to 10Gb/s, allowing your system to catch up with the speed of the SSDs. It also features backward compatibility with up to two SATA drives of the same speed.

Dual PCIe 3.0 x 4 M.2 Support

With a 4 x PCL Express 3.0/2.0 bandwidth, the M.2 can support up to 32GBit/s of data transfer speed. It is a perfect choice for the operating system or application drive, making your system and its installed apps work in a faster pace.

Complete USB 3.1 integration

This motherboard has the latest USB 3.1 connectivity built in with dual Type-A ports for the very fastest USB data transfers — that's up to 10Gb/s, or twice as fast as USB 3.0. The next-generation standard is completely backward-compatible with your existing USB devices, and you'll be all set for USB 3.1's breakneck speeds.

1.1.2 “Ultimate COOL” Thermal Solutions

Thermal Armor

The Thermal Armor is the world's first ever thermal design for the entire motherboard, not just for select critical areas. It safeguards the system against hot air generated by connected cards and components, keeping temps down. With its sophisticated and agile integrated shunt design, the Thermal Armor improves cool air circulation, directing it towards every important part for a complete motherboard cool down. It effectively conducts hot air away and out of the case through special airflow channels, contributing to enhanced system stability and extending component lifespan.

Thermal Radar 2

Thermal Radar 2 uses multiple sensors to control motherboard temperatures, automatically adjusting fan speeds for better system stability and power efficiency. It also provides customizable fan management that displays real-time motherboard, CPU and VGA zone cooling status, and promotes extended system longevity, power saving solution, and noise reduction.

1.1.3 “TUF Engine” Power Design

Digital Power Control

ASUS DIGI+ Power Control features the revolutionary and innovative digital VRM, DRAM, and CPU Voltage controllers. These controllers offers ultra-precise memory and voltage tuning for optimal system efficiency, stability and performance.

TUF Components (Choke, 10K Ti-Cap. & MOSFET; certified by military-standard)

The motherboard’s TUF components features military-standard robust TUF new chokes, titanium solid state capacitors, and MOSFETS. These TUF components support up to a massive 40A rated current, eliminates buzzing noise and vibration, and delivers better performance, and durability during the most extreme usage.

1.1.4 “Safe & Stable!” Guardian Angel

TUF Fortifier

The metal base TUF Fortifier strengthens the base of the motherboard and secures the Thermal Armor and the motherboard in place. It reinforces the motherboard’s PCB to support the Thermal Armor, CPU, VGA card, additional expansion cards, and other peripherals. It also makes the motherboard easier to handle and helps protect your hands.

Dust Defenders

Dust Defenders provides rear I/O filter and special shields that help reduce dust build-up on critical points within slots and connectors, minimizing any harm to the components’ optimal functions, data transfer efficiency, and system performance.

TUF ESD Guards 2

TUF ESD (Electrostatic Discharge) Guards provides protection against electrostatic discharges, which can damage the motherboard’s components. The ASUS exclusive Anti-Static chip and circuit design, and the I/O shield provide four times better protection and ensure the motherboard’s lifespan.

MemOK!

MemOK!, the remarkable memory rescue tool, allows you to simply press a button to patch memory issues, ensure memory boot compatibility, determine fail-safe settings, and dramatically improve the system’s bootup.

1.1.5 ASUS EZ DIY

ASUS UEFI BIOS (EZ Mode)

ASUS UEFI BIOS, a UEFI compliant architecture, offers the first mouse-controlled intuitive graphical BIOS interface that goes beyond the traditional keyboard-only BIOS controls, providing you with more flexibility, convenience, and easy to navigate UEFI BIOS than the traditional BIOS versions. It offers you with dual selectable modes and native support for hard drives larger than 2.2 TB.

ASUS UEFI BIOS includes the following new features:

- New My Favorites function allows you to quickly access the frequently used items
- New quick Note function allows you to take notes in the BIOS environment
- New Last Modified log allows you to view all your modified settings
- F12 BIOS snapshot hotkey
- ASUS DRAM SPD (Serial Presence Detect) information detecting faulty DIMMs, and helping with difficult POST situations.

ASUS Q-Design

ASUS q-Design enhances your DIY experience. All of q-Slot and q-Shield design speed up and simplify the DIY process.

ASUS Q-shield

ASUS Q-Shield's special design makes it convenient and easy to install on your motherboard. With better electric conductivity, it ideally protects your motherboard against static electricity and shields it against EMI (Electronic Magnetic Interference).

ASUS Q-connector

ASUS q-Connector is a unique adapter that allows you to easily connect or disconnect the chassis front panel cables to one module, eliminating the hassle of plugging one cable at a time and making the connection quick and accurate.

1.1.6 ASUS Exclusive Features

Remote GO!

ASUS Remote GO! leads the way to a more enjoyable home entertainment. With ASUS Remote GO!, you can wirelessly stream media files to DLNA devices, remotely control and access your computer using your smart device and easily transfer files between your computer and smart device.

Conveniently use and enjoy these ASUS Remote GO! functions:

- **Cloud GO!:** Allows you to control files and sync them all across cloud services in a few clicks.
- **ASUS Media Streamer:** Allows you to stream media files to a DLNA-supported devices.
- **Remote Desktop:** Allows you to view your computer's desktop and remotely operate your computer in real-time from your smart device.
- **File Transfer:** Allows you to transfer files between your computer and smart device.

USB Charger+

With a dedicated onboard controller, quick-charge all your smart devices such as smartphones, tablets and more, all up to three times faster, even when the system is powered off, in sleep or hibernation mode.

USB BIOS Flashback

USB BIOS Flashback offers a hassle-free updating solution for your ultimate convenience. Install a USB storage device containing the BIOS file, press the BIOS Flashback button for about three seconds, and the UEFI BIOS is automatically updated even without entering the existing BIOS or operating system. It also allows you to regularly check for UEFI BIOS updates, and download the latest BIOS automatically.

AI Suite 3

With its user-friendly interface, ASUS AI Suite 3 consolidates all the exclusive ASUS features into one simple-to-use software package. It allows you to supervise fan speed control, voltage and sensor readings. This all-in-one software offers diverse and ease to use functions, with no need to switch back and forth between different utilities.

1.1.7 Other special features

ErP Ready

The motherboard is European Union's Energy-related Products (ErP) ready, and ErP requires products to meet certain energy efficiency requirement in regards to energy consumptions. This is in line with ASUS vision of creating environment-friendly and energy-efficient products through product design and innovation to reduce carbon footprint of the product and thus mitigate environmental impacts.

1.2 Motherboard overview

1.2.1 Before you proceed

Take note of the following precautions before you install motherboard components or change any motherboard settings.



-
- Unplug the power cord from the wall socket before touching any component.
 - Before handling components, use a grounded wrist strap or touch a safely grounded object or a metal object, such as the power supply case, to avoid damaging them due to static electricity.
 - Hold components by the edges to avoid touching the ICs on them.
 - Whenever you uninstall any component, place it on a grounded antistatic pad or in the bag that came with the component.
 - Before you install or remove any component, ensure that the ATX power supply is switched off or the power cord is detached from the power supply. Failure to do so may cause severe damage to the motherboard, peripherals, or components.
-

1.2.2 Motherboard layout

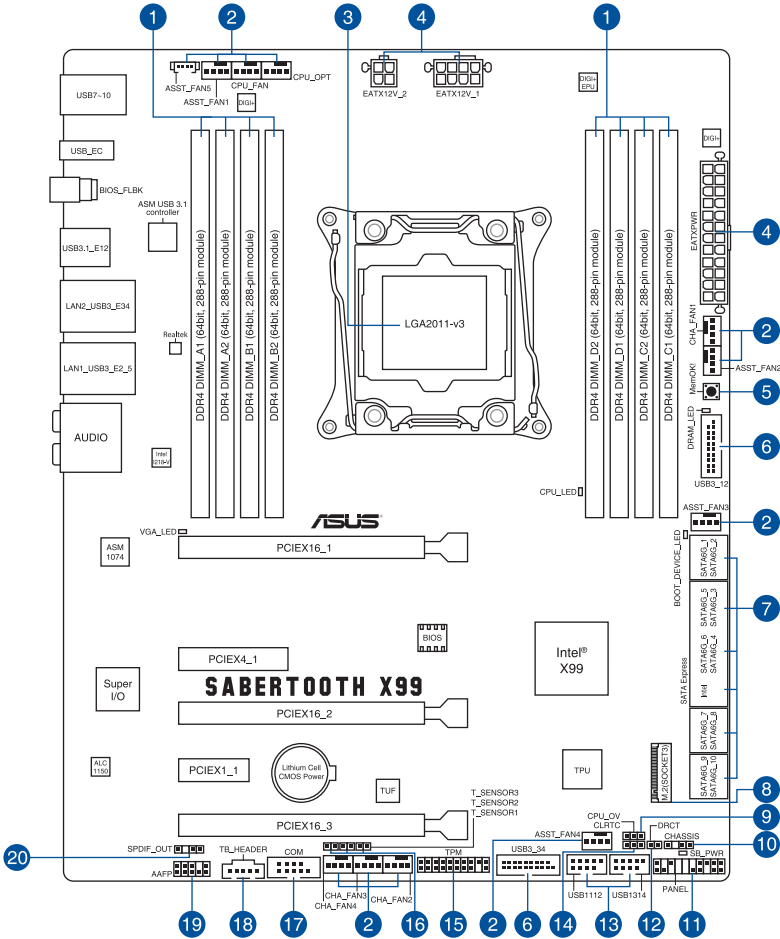

Refer to 1.2.9 Internal connectors and 2.3.1 Rear I/O connection for more information about rear panel connectors and internal connectors.

Layout contents

Connectors/Jumpers/Slots		Page
1.	DDR4 DIMM slots	1-11
2.	CPU, optional, chassis, and assistant fan connectors (4-pin CPU_FAN; 4-pin CPU_OPT; 4-pin CHA_FAN1-4; 4-pin ASST_FAN1-5)	1-32
3.	LGA2011-v3 socket	1-10
4.	ATX power connectors (24-pin EATXPWR, 12-pin EATX12V)	1-34
5.	MemOK! button	1-24
6.	USB 3.0 connector (20-1 pin USB3_12, USB3_34)	1-29
7.	Intel® X99 Serial ATA 6.0Gb/s connectors (7-pin SATA6G_1-2 [beige]; SATA6G_3-4 [gray] SATA Express [gray at the top]); SATA6G_7-10 [black]	1-28
8.	M.2 Socket 3	1-37
9.	CPU Over Voltage jumper (3-pin CPU_OV)	1-26
10.	Chassis intrusion connector (4-1 pin CHASSIS)	1-38
11.	System panel connector (20-8 pin PANEL)	1-38
12.	DirectKey connector (2-pin DRCT)	1-36
13.	USB 2.0 connectors (10-1 pin USB1112, USB1314)	1-34
14.	Clear RTC RAM (3-pin CLRRTC)	1-27
15.	TPM connector (20-1 pin TPM)	1-37
16.	T Sensor connectors (2-pin T_SENSOR1, T_SENSOR2, T_SENSOR3)	1-33
17.	Serial port connector (10-1 pin COM)	1-38
18.	Thunderbolt header (5-pin TB_HEADER)	1-37
19.	Front panel audio connector (10-1 pin AAFP)	1-33
20.	Digital audio connector (4-1 pin SPDIF_OUT)	1-30

1.2.3 Central Processing Unit (CPU)

The motherboard comes with a surface mount LGA2011 socket designed Intel® Core™ i7 processors.

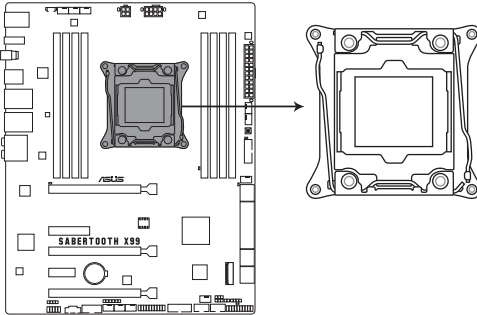

SABERTOOTH X99 CPU LGA2011-v3 Socket



-
- Ensure that all power cables are unplugged before installing the CPU.
 - Upon purchase of the motherboard, ensure that the PnP cap is on the socket and the socket contacts are not bent. Contact your retailer immediately if the PnP cap is missing, or if you see any damage to the PnP cap/socket contacts/motherboard components. ASUS will shoulder the cost of repair only if the damage is shipment/transit-related.
 - Keep the cap after installing the motherboard. ASUS will process Return Merchandise Authorization (RMA) requests only if the motherboard comes with the cap on the LGA2011-v3 socket.
 - The product warranty does not cover damage to the socket contacts resulting from incorrect CPU installation/removal, or misplacement/loss/incorrect removal of the PnP cap.
-

1.2.4 System memory

The motherboard comes with eight Double Data Rate 4 (DDR4) Quad Inline Memory Modules (DIMM) slots.



A DDR4 module is notched differently from a DDR, DDR2, or DDR3 module. DO NOT install a DDR, DDR2, or DDR3 memory module to the DDR4 slot.

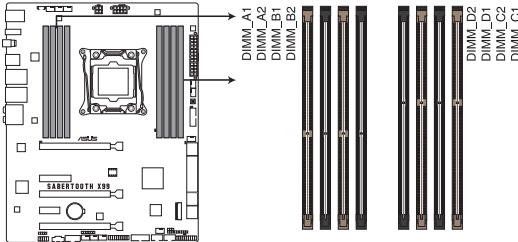

SABERTOOTH X99 288-pin DDR4 DIMM socket

Recommended memory configurations

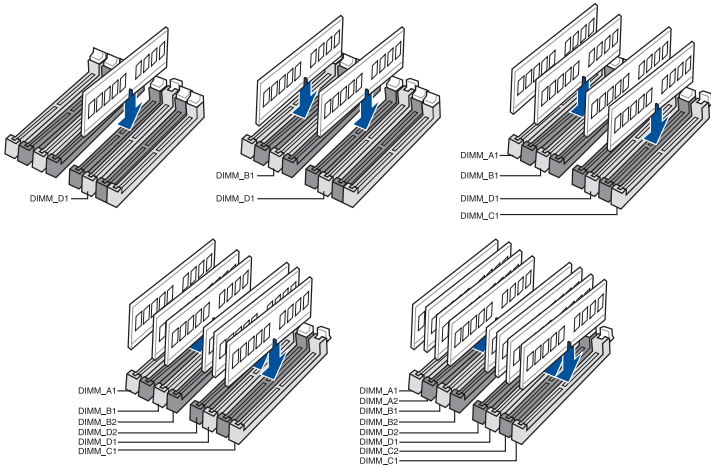

Memory configurations

You may install 2GB, 4GB and 8GB unbuffered and non-ECC DDR4 DIMMs into the DIMM sockets.



-
- You may install varying memory sizes in Channel A, Channel B, Channel C, and Channel D. The system maps the total size of the lower-sized channel for the quad-channel configuration. Any excess memory from the higher-sized channel is then mapped for single-channel operation.
 - According to Intel® CPU spec, DIMM voltage below 1.65 V is recommended to protect the CPU.
 - Due to the memory address limitation on 32-bit Windows® OS, when you install 4GB or more memory on the motherboard, the actual usable memory for the OS can be about 3GB or less. For effective use of memory, we recommend that you do any of the following:
 - a) Use a maximum of 3GB system memory if you are using a 32-bit Windows® OS.
 - b) Install a 64-bit Windows® OS when you want to install 4 GB or more on the motherboard.
 - c) For more details, refer to the Microsoft® support site at <http://support.microsoft.com/kb/929605/en-us>.
-



-
- The default memory operation frequency is dependent on its Serial Presence Detect (SPD), which is the standard way of accessing information from a memory module. Under the default state, some memory modules for overclocking may operate at a lower frequency than the vendor-marked value. To operate at the vendor-marked or at a higher frequency, refer to section **3.5 Ai Tweaker menu** for manual memory frequency adjustment.
 - For system stability, use a more efficient memory cooling system to support a full memory load (8 DIMMs) or overclocking condition.
 - Memory modules with memory frequency higher than 2133MHz and their corresponding timing or the loaded XMP profile is not the JEDEC memory standard. The stability and compatibility of the memory modules depend on the CPU's capabilities and other installed devices.
 - Always install the DIMMS with the same CAS Latency. For an optimum compatibility, we recommend that you install memory modules of the same version or data code (D/C) from the same vendor. Check with the vendor to get the correct memory modules.
-

SABERTOOTH X99 Motherboard Qualified Vendors Lists (QVL)

DDR4 3333 MHz capability

Vendors	Part No.	Size	SS/ DS	Chip Brand	Chip NO.	Timing	Voltage	DIMM socket support (Optional)		
								2	4	8
G.SKILL	F4-3333C16Q-16GRK	16GB(4GB*4)	SS	SK hynix	H5AN4G8NMFR	16-16-16-36	1.35V	•	•	

DDR4 3300 MHz capability

Vendors	Part No.	Size	SS/ DS	Chip Brand	Chip NO.	Timing	Voltage	DIMM socket support (Optional)		
								2	4	8
G.SKILL	F4-3300C16Q-16GRK	16GB(4GB*4)	SS	SK hynix	H5AN4G8NMFR	16-16-16-36	1.35V	•	•	

DDR4 3200 MHz capability

Vendors	Part No.	Size	SS/ DS	Chip Brand	Chip NO.	Timing	Voltage	DIMM socket support (Optional)		
								2	4	8
G.SKILL	F4-3200C16Q-16GRR	16GB(4GB*4)	SS	SK hynix	H5AN4G8NMFR	16-16-16-36	1.35V	•	•	
G.SKILL	F4-3200C16Q-16GRB	16GB(4GB*4)	SS	SK hynix	H5AN4G8NMFR	16-16-16-36	1.35V	•	•	
G.SKILL	F4-3200C16Q-16GRRK	16GB(4GB*4)	SS	SK hynix	H5AN4G8NMFR	16-16-16-36	1.35V	•	•	
AVEXIR	AVD4U32001604G-4BZ1	16GB(4GB*4)	SS	SK hynix	H5AN4G8NMFR	16-18-18-36	1.35V	•	•	
CORSAIR	CMD16GX4M4A3200C16	16GB(4GB*4)	SS	SK hynix	H5AN4G8NMFR	16-18-18-36	1.35V	•	•	
KINGSTON	HX432C16PBK4/16	16GB(4GB*4)	SS	SK hynix	H5AN4G8NMFR	16-16-16-39	1.35V	•	•	
GEIL	GPR416GB3200C15QC	16GB(4GB*4)	SS	SK hynix	H5AN4G8NMFR	15-15-15-35	1.35V	•	•	

DDR4 3000 MHz capability

Vendors	Part No.	Size	SS/ DS	Chip Brand	Chip NO.	Timing	Voltage	DIMM socket support (Optional)		
								2	4	8
G.SKILL	F4-3000C15Q-32GRR	32GB(8GB*4)	DS	SK hynix	H5AN4G8NMFR	15-15-15-35	1.35V	•	•	
G.SKILL	F4-3000C15Q-32GRB	32GB(8GB*4)	DS	SK hynix	H5AN4G8NMFR	15-15-15-35	1.35V	•	•	
G.SKILL	F4-3000C15Q-32GRK	32GB(8GB*4)	DS	SK hynix	H5AN4G8NMFR	15-15-15-35	1.35V	•	•	
G.SKILL	F4-3000C16Q-32GRR	32GB(8GB*4)	DS	SK hynix	H5AN4G8NMFR	16-16-16-36	1.35V	•	•	
G.SKILL	F4-3000C16Q-32GRB	32GB(8GB*4)	DS	SK hynix	H5AN4G8NMFR	16-16-16-36	1.35V	•	•	
G.SKILL	F4-3000C16Q-32GRK	32GB(8GB*4)	DS	SK hynix	H5AN4G8NMFR	16-16-16-36	1.35V	•	•	
G.SKILL	F4-3000C15Q-16GRR	16GB(4GB*4)	SS	SK hynix	H5AN4G8NMFR	15-15-15-35	1.35V	•	•	
G.SKILL	F4-3000C15Q-16GRB	16GB(4GB*4)	SS	SK hynix	H5AN4G8NMFR	15-15-15-35	1.35V	•	•	
G.SKILL	F4-3000C15Q-16GRK	16GB(4GB*4)	SS	SK hynix	H5AN4G8NMFR	15-15-15-35	1.35V	•	•	
G.SKILL	F4-3000C15Q2-32GRK	32GB(4GB*8)	SS	SK hynix	H5AN4G8NMFR	15-15-15-35	1.35V	•	•	•
AVEXIR	AVD4U30001604G-4CI	16GB(4GB*4)	SS	SK hynix	H5AN4G8NMFR	16-18-18-36	1.35V	•	•	
AVEXIR	AVD4U30001504G-4BZ1	16GB(4GB*4)	SS	SK hynix	H5AN4G8NMFR	15-15-15-35	1.35V	•	•	
AVEXIR	AVD4U30001608G-4CI	32GB(8GB*4)	DS	SK hynix	H5AN4G8NMFR	16-18-18-36	1.35V	•	•	
Kingston	HX430C15PB2K4/16	16GB(4GB*4)	SS			15-16-16-39	1.35V	•	•	
CORSAIR	CMD16GX4M4B3000 C15	16GB(4GB*4)	SS	Samsung	K4A4G085WD	15-17-17-35	1.35V	•	•	

DDR4 2800 MHz capability

Vendors	Part No.	Size	SS/ DS	Chip Brand	Chip NO.	Timing	Voltage	DIMM socket support (Optional)		
								2	4	8
A_DATA	AX4U2800W8G17-DRZ	8GB	DS	SK hynix	H5AN4G8NMFR	17-18-18-36	1.2V	•	•	
A_DATA	AX4U2800W4G17	16GB(4GB*4)	SS	SK hynix	H5AN4G8NMFR	17-17-17-36	1.2V	•	•	
A_DATA	AX4U2800W4G17	32GB(4GB*8)	SS	SK hynix	H5AN4G8NMFR	17-17-17-36	1.2V	•	•	•
A_DATA	AX4U2800W8G17	32GB(8GB*4)	DS	SK hynix	H5AN4G8NMFR	17-17-17-36	1.2V	•	•	
AVEXIR	AVD4U28001604G-4CI	16GB(4GB*4)	SS	SK hynix	H5AN4G8NMFR	16-16-16-36	1.2V	•	•	
AVEXIR	AVD4U28001504G-4BZ1	16GB(4GB*4)	SS	SK hynix	H5AN4G8NMFR	15-15-15-35	1.35V	•	•	
AVEXIR	AVD4U28001608G-4CI	32GB(8GB*4)	DS	SK hynix	H5AN4G8NMFR	16-16-16-36	1.2V	•	•	
AVEXIR	AVD4U28001508G-4BZ1	32GB(8GB*4)	DS	SK hynix	H5AN4G8NMFR	15-15-15-35	1.35V	•	•	
Apacer	78.B1GM8.AF20B	4GB	SS	-	-	17-17-17-36	1.2V	•	•	
Apacer	78.C1GM8.AF30B	8GB	DS	-	-	17-17-17-36	1.2V	•	•	
CORSAIR	CMD16GX4M4A2800C16	16GB(4GB*4)	SS	-	-	16-18-18-36	1.2V	•	•	
CORSAIR	CMD32GX4M4A2800C16	32GB(8GB*4)	DS	-	-	16-18-18-36	1.2V	•	•	
CORSAIR	CMD64GX4M8A2800C16	64GB(8GB*8)	DS	-	-	16-18-18-36	1.2V	•	•	•
CORSAIR	CMD16GX4M4A2800C15	16GB(4GB*4)	SS	-	-	15-17-17-36	1.2V	•	•	
CORSAIR	CMD32GX4M4A2800C15	32GB(8GB*4)	DS	-	-	15-17-17-36	1.2V	•	•	
CORSAIR	CMK16GX4M4A2800C16	16GB(4GB*4)	SS	-	-	16-18-18-36	1.2V	•	•	
CORSAIR	CMK32GX4M4A2800C16	32GB(8GB*4)	DS	-	-	16-18-18-36	1.2V	•	•	
CORSAIR	CMK64GX4M8A2800C16	64GB(8GB*8)	DS	-	-	16-18-18-36	1.2V	•	•	•
CORSAIR	CMK16GX4M4A2800C15R	16GB(4GB*4)	SS	-	-	15-17-17-36	1.2V	•	•	
CORSAIR	CMK32GX4M4A2800C15R	32GB(8GB*4)	DS	-	-	15-17-17-36	1.2V	•	•	
CORSAIR	CMK16GX4M4A2800C16	16GB(4GB*4)	SS	Samsung	K4A4G085WD	16-18-18-36	1.2V	•	•	
G.SKILL	F4-2800C16Q-16GRR	16GB(4GB*4)	SS	-	-	16-16-16-36	1.2V	•	•	
G.SKILL	F4-2800C16Q-16GRB	16GB(4GB*4)	SS	-	-	16-16-16-36	1.2V	•	•	
G.SKILL	F4-2800C16Q-16GRK	16GB(4GB*4)	SS	-	-	16-16-16-36	1.2V	•	•	
G.SKILL	F4-2800C16Q-32GRR	32GB(8GB*4)	DS	-	-	16-16-16-36	1.2V	•	•	
G.SKILL	F4-2800C16Q-32GRB	32GB(8GB*4)	DS	-	-	16-16-16-36	1.2V	•	•	
G.SKILL	F4-2800C16Q-32GRK	32GB(8GB*4)	DS	-	-	16-16-16-36	1.2V	•	•	
Kingston	HX428C14PB2K4/16	16GB(4GB*4)	SS	-	-	14-15-15-40	1.35V	•	•	

DDR4 2666 MHz capability

Vendors	Part No.	Size	SS/ DS	Chip Brand	Chip NO.	Timing	Voltage	DIMM socket support (Optional)		
								2	4	8
CORSAIR	CMD16GX4M4A2666C14	16GB(4GB*4)	SS	-	-	14-16-16-35	1.2V	•	•	
CORSAIR	CMD32GX4M4A2666C14	32GB(8GB*4)	DS	-	-	14-16-16-35	1.2V	•	•	
CORSAIR	CMK16GX4M4A2666C15	16GB(4GB*4)	SS	-	-	15-17-17-35	1.2V	•	•	
CORSAIR	CMK32GX4M4A2666C15	32GB(8GB*4)	DS	-	-	15-17-17-35	1.2V	•	•	
CORSAIR	CMK16GX4M4A2666C14R	16GB(4GB*4)	SS	-	-	14-16-16-35	1.2V	•	•	
CORSAIR	CMK32GX4M4A2666C14R	32GB(8GB*4)	DS	-	-	14-16-16-35	1.2V	•	•	
CORSAIR	CMK16GX4M4A2666C16 (Ver5.29)	16GB (4x 4GB)	SS	-	-	16-18-18-35	1.2V	•	•	
CORSAIR	CMD16GX4M4A2666C16 (Ver5.29)	16GB (4x 4GB)	SS	-	-	16-18-18-35	1.2V	•	•	
CORSAIR	CMK32GX4M4A2666C16 (Ver5.29)	32GB(8GB*4)	DS	-	-	16-18-18-35	1.2V	•	•	
CORSAIR	CMD32GX4M4A2666C16 (Ver4.23)	32GB(8GB*4)	DS	-	-	16-18-18-35	1.2V	•	•	
CORSAIR	CMK32GX4M4A2666C15 (Ver5.29)	32GB(8GB*4)	DS	-	-	15-17-17-35	1.2V	•	•	
CORSAIR	CMK32GX4M4A2666C16R	32GB (4x 8GB)	DS	-	-	16-18-18-35	1.2V	•	•	
AVEXIR	AVD4U26661704G-4M	16GB(4GB*4)	SS	SK hynix	H5AN4G8NMFR	17-17-17-43	1.2V	•	•	
AVEXIR	AVD4U26661504G-4C1	16GB(4GB*4)	SS	SK hynix	H5AN4G8NMFR	15-15-15-35	1.2V	•	•	
AVEXIR	AVD4U26661708G-4M	32GB(8GB*4)	DS	SK hynix	H5AN4G8NMFR	17-17-17-43	1.2V	•	•	
AVEXIR	AVD4U26661508G-4C1	32GB(8GB*4)	DS	SK hynix	H5AN4G8NMFR	15-15-15-35	1.2V	•	•	
Apacer	78.B1GM7.AF20B	4GB	SS	-	-	16-16-16-36	1.2V	•	•	
Apacer	78.C1GM7.AF30B	8GB	DS	-	-	16-16-16-36	1.2V	•	•	
Kingston	HX426C13PB2K4/16	16GB(4GB*4)	SS	-	-	13-14-14-39	1.35V	•	•	
G.SKILL	F4-2666C15Q-16GRR	16GB(4GB*4)	SS	-	-	15-15-15-35	1.2V	•	•	
G.SKILL	F4-2666C15Q-16GRB	16GB(4GB*4)	SS	-	-	15-15-15-35	1.2V	•	•	
G.SKILL	F4-2666C15Q-16GRK	16GB(4GB*4)	SS	-	-	15-15-15-35	1.2V	•	•	
G.SKILL	F4-2666C15Q-32GRR	32GB(8GB*4)	DS	-	-	15-15-15-35	1.2V	•	•	
G.SKILL	F4-2666C15Q-32GRB	32GB(8GB*4)	DS	-	-	15-15-15-35	1.2V	•	•	
G.SKILL	F4-2666C15Q-32GRK	32GB(8GB*4)	DS	-	-	15-15-15-35	1.2V	•	•	
ISDT	IMA41GU6MFR8N-CF0	8GB	DS	-	-	15-15-15-35	1.2V	•	•	•
ISDT	IMA451U6MFR8N-CF0	4GB	SS	-	-	15-15-15-35	1.2V	•	•	•

DDR4 2400 MHz capability

Vendors	Part No.	Size	SS/ DS	Chip Brand	Chip NO.	Timing	Voltage	DIMM socket support (Optional)		
								2	4	8
A_DATA	AX4U2400W8G16-DRZ	8GB	SS	SK hynix	H5AN4G8NMFR	16-16-16-39	1.2V	•	•	
AVEXIR	AVD4U24001604G-4M	16GB(4GB*4)	SS	SK hynix	H5AN4G8NMFR	16-16-16-39	1.2V	•	•	•
AVEXIR	AVD4U24001504G-4CI	16GB(4GB*4)	SS	SK hynix	H5AN4G8NMFR	15-15-15-35	1.2V	•	•	•
AVEXIR	AVD4U24001608G-4M	32GB(8GB*4)	DS	SK hynix	H5AN4G8NMFR	16-16-16-39	1.2V	•	•	
AVEXIR	AVD4U24001508G-4CI	32GB(8GB*4)	DS	SK hynix	H5AN4G8NMFR	15-15-15-35	1.2V	•	•	
Apacer	78.B1GM6.AF20B	4GB	SS	-	-	16-16-16-36	1.2V	•	•	•
Apacer	78.C1GM6.AF30B	8GB	DS	-	-	16-16-16-36	1.2V	•	•	
CORSAIR	CMD16GX4M4A2400C14	16GB(4GB*4)	SS	-	-	14-16-16-31	1.2V	•	•	
CORSAIR	CMD32GX4M4A2400C14	32GB(8GB*4)	DS	-	-	14-16-16-31	1.2V	•	•	
CORSAIR	CMD64GX4M8A2400C14	64GB(8GB*8)	DS	-	-	14-16-16-31	1.2V	•	•	•
CORSAIR	CMD16GX4M4A2400C13	16GB(4GB*4)	SS	-	-	13-15-15-31	1.2V	•	•	
CORSAIR	CMD32GX4M4A2400C13	32GB(8GB*4)	DS	-	-	13-15-15-31	1.2V	•	•	
CORSAIR	CMK16GX4M4A2400C14B	16GB(4GB*4)	SS	-	-	14-16-16-31	1.2V	•	•	
CORSAIR	CMK16GX4M4A2400C14R	16GB(4GB*4)	SS	-	-	14-16-16-31	1.2V	•	•	
CORSAIR	CMK16GX4M4A2400C14	16GB(4GB*4)	SS	-	-	14-16-16-31	1.2V	•	•	
CORSAIR	CMK32GX4M4A2400C14	32GB(8GB*4)	DS	-	-	14-16-16-31	1.2V	•	•	
CORSAIR	CMK64GX4M8A2400C14	64GB(8GB*8)	DS	-	-	14-16-16-31	1.2V	•	•	•
CORSAIR	CMK16GX4M4A2400C13R	16GB(4GB*4)	SS	-	-	13-15-15-31	1.2V	•	•	
CORSAIR	CMK32GX4M4A2400C13R	32GB(8GB*4)	DS	-	-	13-15-15-31	1.2V	•	•	
G.SKILL	F4-2400C15Q-32GRR	32GB(8GB*4)	DS	-	-	15-15-15-35	1.2V	•	•	
G.SKILL	F4-2400C15Q-32GRB	32GB(8GB*4)	DS	-	-	15-15-15-35	1.2V	•	•	
G.SKILL	F4-2400C15Q-32GRK	32GB(8GB*4)	DS	-	-	15-15-15-35	1.2V	•	•	
G.SKILL	F4-2400C15Q-16GRR	16GB(4GB*4)	SS	-	-	15-15-15-35	1.2V	•	•	
G.SKILL	F4-2400C15Q-16GRB	16GB(4GB*4)	SS	-	-	15-15-15-35	1.2V	•	•	
G.SKILL	F4-2400C15Q-16GRK	16GB(4GB*4)	SS	-	-	15-15-15-35	1.2V	•	•	
G.SKILL	F4-2400C15Q-32GNT	32GB(8GB*4)	DS	-	-	15-15-15-35	1.2V	•	•	
G.SKILL	F4-2400C15Q-16GNT	16GB(4GB*4)	SS	-	-	15-15-15-35	1.2V	•	•	
Crucial	BLS4G4D240FSA.8FAD	4GB	SS	-	-	16-16-16-40	1.2V	•	•	•

(continued on the next page)

DDR4 2400 MHz capability

Vendors	Part No.	Size	SS/ DS	Chip Brand	Chip NO.	Timing	Voltage	DIMM socket support (Optional)		
								2	4	8
Crucial	BLS8G4D240FSA.16FAD	8GB	DS	-	-	16-16- 16-40	1.2V	•	•	
Crucial	BLS4G4D240FSA.8FAR	4GB	SS			16-16- 16-40	1.2V	•	•	•
Crucial	BLS8G4D240FSA.16FAR	8GB	DS			16-16- 16-40	1.2V	•	•	•
Kingston	HX424C12PB2K4/16	16GB (4GB*4)	SS	-	-	12-13- 13-35	1.35V	•	•	
Team	TED44GM2400C16BK	4GB	SS	SAMSUNG	K4A4G085WD	16-16- 16-39	1.2V	•	•	•
Team	TED48GM2400C16BK	8GB	DS	SAMSUNG	K4A4G085WD	16-16- 16-39	1.2V	•	•	•
panram	PUD42400C154GNJK	4GB	SS	-	-	15-15- 15-36	1.2V	•	•	
panram	PUD42400C158GNJK	8GB	DS	-	-	15-15- 15-36	1.2V	•	•	
panram	PUD42400C154G2NJK	8GB (4GB*2)	SS	-	-	15-15- 15-36	1.2V	•	•	
panram	PUD42400C158G2NJK	16GB (8GB*2)	DS	-	-	15-15- 15-36	1.2V	•	•	

DDR4 2133 MHz capability

Vendors	Part No.	Size	SS/ DS	Chip Brand	Chip NO.	Timing	Voltage	DIMM socket support (Optional)		
								1	2	4
Micron	MTA8ATF51264AZ-2G1A1	4GB	SS	Micron	D9RGQ	15-15-15-37	1.2V	*	*	*
Micron	MTA16ATF1G64AZ-2G1A1	8GB	DS	Micron	D9RGQ	15-15-15-37	1.2V	*	*	*
Crucial	CT4G4DFS8213.8FA1	4GB	SS	Micron	D9RGQ	15-15-15-37	1.2V	*	*	*
Crucial	CT8G4DFD8213.16FA1	8GB	DS	Micron	D9RGQ	15-15-15-37	1.2V	*	*	*
Samsung	M378A5143DB0-CPB	4GB	SS	Samsung	K4A4G085WD	15-15-15-36	1.2V	*	*	*
Samsung	M378A1G43DB0-CPB	8GB	DS	Samsung	K4A4G085WD	15-15-15-36	1.2V	*	*	*
SK hynix	HMA451U6MFR8N-TF	4GB	SS	SK hynix	H5AN4G8NMFRFTFC	15-15-15-37	1.2V	*	*	*
SK hynix	HMA41GU6MFR8N-TF	8GB	DS	SK hynix	H5AN4G8NMFRFTFC	15-15-15-37	1.2V	*	*	*
A_DATA	AX4U2133W4G13-DRZ	4GB	SS	SK hynix	H5AN4G8NMFR	13-13-13-36	1.2V	*	*	
A_DATA	AX4U2133W8G13-DRZ	8GB	DS	SK hynix	H5AN4G8NMFR	13-13-13-36	1.2V	*	*	
A_DATA	AX4U2133W4G15-DRZ	4GB	SS	SK hynix	H5AN4G8NMFR	15-15-15-37	1.2V	*	*	
A_DATA	AX4U2133W8G15-DRZ	8GB	DS	SK hynix	H5AN4G8NMFR	15-15-15-37	1.2V	*	*	
A_DATA	AD4U2133W4G15-B	4GB	SS	SK hynix	H5AN4G8NMFRFTFC	15-15-15-36	1.2V	*	*	*
AVEXIR	AVD4U21331504G-4M	16GB	SS	SK hynix	H5AN4G8NMFR	15-15-15-35	1.2V	*	*	
	(4GB*4)									
AVEXIR	AVD4U21331508G-4M	32GB	DS	SK hynix	H5AN4G8NMFR	15-15-15-35	1.2V	*	*	*
	(8GB*4)									
Apacer	78.B1GM3.AF00B	4GB	SS	SK hynix	H5AN4G8NMFRFTFC	15-15-15-36	1.2V	*	*	*
Apacer	78.C1GM3.AF10B	8GB	DS	SK hynix	H5AN4G8NMFRFTFC	15-15-15-36	1.2V	*	*	
CORSAIR	CMK8GX4M2A2133C15	8GB	SS	-	-	15-15-15-36	1.2V	*	*	
	(4GB*2)									
CORSAIR	CMK16GX4M2A2133C15	16GB	DS	-	-	15-15-15-36	1.2V	*	*	
	(8GB*2)									
CORSAIR	CMK8GX4M2A2133C15R	8GB	SS	-	-	15-15-15-36	1.2V	*	*	
	(4GB*2)									
CORSAIR	CMK16GX4M4A2133C13B	16GB	SS	-	-	13-15-15-28	1.2V	*	*	
	(4GB*4)									
CORSAIR	CMK16GX4M4A2133C13R	16GB	SS	-	-	13-15-15-28	1.2V	*	*	
	(4GB*4)									
CORSAIR	CMK16GX4M4A2133C13	16GB	SS	-	-	13-15-15-28	1.2V	*	*	
	(4GB*4)									
CORSAIR	CMK32GX4M4A2133C13	32GB	DS	-	-	13-15-15-28	1.2V	*	*	
	(8GB*4)									
CORSAIR	CMK64GX4M8A2133C13	64GB	DS	-	-	13-15-15-28	1.2V	*	*	*
	(8GB*8)									
CORSAIR	CMK16GX4M4A2133C12R	16GB	SS	-	-	12-14-14-27	1.2V	*	*	
	(4GB*4)									
CORSAIR	CMK32GX4M4A2133C12R	32GB	DS	-	-	12-14-14-27	1.2V	*	*	
	(8GB*4)									
CORSAIR	CMD16GX4M4A2133C12	16GB	SS	-	-	12-14-14-27	1.2V	*	*	
	(4GB*4)									

(continued on the next page)

DDR4 2133 MHz capability

Vendors	Part No.	Size	SS/ DS	Chip Brand	Chip NO.	Timing	Voltage	DIMM socket support (Optional)		
								1	2	4
CORSAIR	CMD32GX4M4A2133C12	32GB(8GB*4)	DS	-	-	12-14- 14-27	1.2V	•	•	
G.SKILL	F4-2133C15Q-16GRR	16GB(4GB*4)	SS	-	-	15-15- 15-35	1.2V	•	•	
G.SKILL	F4-2133C15Q-16GRB	16GB(4GB*4)	SS	-	-	15-15- 15-35	1.2V	•	•	
G.SKILL	F4-2133C15Q-16GRK	16GB(4GB*4)	SS	-	-	15-15- 15-35	1.2V	•	•	
G.SKILL	F4-2133C15Q-32GRR	32GB(8GB*4)	DS	-	-	15-15- 15-35	1.2V	•	•	
G.SKILL	F4-2133C15Q-32GRB	32GB(8GB*4)	DS	-	-	15-15- 15-35	1.2V	•	•	
G.SKILL	F4-2133C15Q-32GRK	32GB(8GB*4)	DS	-	-	15-15- 15-35	1.2V	•	•	
G.SKILL	F4-2133C15Q2-64GRR	64GB(8GB*8)	DS	-	-	15-15- 15-35	1.2V	•	•	•
G.SKILL	F4-2133C15Q-16GNT	16GB(4GB*4)	SS	-	-	15-15- 15-35	1.2V	•	•	
G.SKILL	F4-2133C15Q-32GNT	32GB(8GB*4)	DS	-	-	15-15- 15-35	1.2V	•	•	
Kingston	HX421C13PBK4/16	16GB(4GB*4)	DS	-	-	13-13- 13-36	1.2V	•	•	
panram	PUD42133C154GNJK	4GB	SS	-	-	15-15- 15-36	1.2V	•	•	
panram	PUD42133C158GNJK	8GB	DS	-	-	15-15- 15-36	1.2V	•	•	
panram	PUD42133C154G2NJK	8GB(4GB*2)	SS	-	-	15-15- 15-36	1.2V	•	•	
panram	PUD42133C158G2NJK	16GB(8GB*2)	DS	-	-	15-15- 15-36	1.2V	•	•	
SUPER TALENT	FBU2B008GM	8GB	DS	-	-	15-15- 15-36	1.2V	•	•	•
SanMax	SMD-4G28HP-21P	4GB	SS	SK hynix	H5AN4G8NMFRFTFC	15-15- 15-36	1.2V	•	•	•
SanMax	SMD-4G28HP-21P	8GB	DS	SK hynix	H5AN4G8NMFRFTFC	15-15- 15-36	1.2V	•	•	•
Transcend	TS512MLH64V1H	4GB	SS	Micron	Z9RGR	15-15- 15-36	1.2V	•	•	•
Transcend	TS1GLH64V1H	8GB	DS	Micron	Z9RGR	15-15- 15-36	1.2V	•	•	
ISDT	IMA451U6MFR8N-TF0	4GB	SS	ISDT	I5AN4G8NMFR	15-15- 15-35	1.2V	•	•	•
ISDT	IMA41GU6MFR8N-TF0	8GB	DS	ISDT	I5AN4G8NMFR	15-15- 15-35	1.2V	•	•	•
UMAX	84G48G93MC- 21OMCGNGF15	4GB	SS	Micron	D9RGQ	15-15- 15-36	1.2V	•	•	•
UMAX	84G44G93MC- 21OMCALGF15	8GB	DS	Micron	D9RGQ	15-15- 15-36	1.2V	•	•	•
Team	TED48GM2133C15BK	8GB	DS	Micron	D9RGQ	15-15- 15-36	1.2V	•	•	•
Team	TED44GM2133C15ABK	4GB	SS	SK hynix	H5AN4G8NMFRFTFC	15-15- 15-36	1.2V	•	•	•



-
- Side(s): SS - Single-sided DS - Double-sided DIMM support:
 - 1 Supports one (1) module inserted into any slot as Single-channel memory configuration. We suggest that you install the module into D1 slot.
 - 2 Supports two (2) modules inserted into one pair of the beige slots as one pair of dual-channel memory configuration. We suggest that you install the modules into slots B1 and D1 for better compatibility.
 - 4 Supports four (4) modules inserted into both the beige slots and black slots as two pairs of quad-channel memory configuration. We suggest that you install the modules into slots A1, B1, C1, and D1 for better compatibility.
 - 6 Supports six (6) modules inserted into four beige slots and two black slots as three pairs of quad-channel memory configuration. We suggest that you install the modules into slots A1, B1, B2, C1, D1, and D2 for better compatibility.
 - 8 Supports eight (8) modules inserted into all slots as fully-loaded quad-channel memory configurations.
-



-
- ASUS exclusively provides hyper DIMM support function.
 - Hyper DIMM support is subject to the physical characteristics of individual CPUs. Load the X.M.P. or D.O.C.P. settings in the BIOS for the hyper DIMM support.
 - Visit the ASUS website for the latest QVL.
-

1.2.5 Expansion slots



Unplug the power cord before adding or removing expansion cards. Failure to do so may cause you physical injury and damage motherboard components.

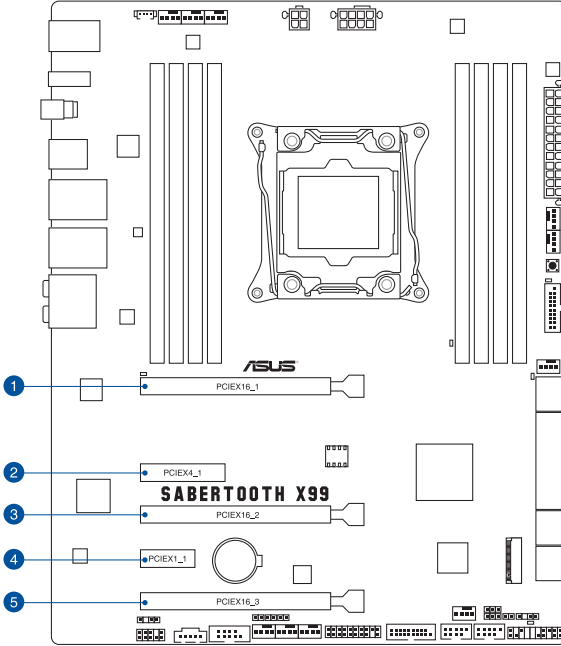

Slot No.	Slot Description
1	PCIe 3.0/2.0 x16_1 slot
2	PCIe 2.0 x4_1 slot
3	PCIe 3.0/2.0 x16_2 slot
4	PCIe 2.0 x1_1 slot
5	PCIe 3.0/2.0 x16_3 slot

40-LANE CPU		PCI Express 3.0 operating mode		
VGA configuration	PCIe 3.0/2.0 x16_1	PCIe 3.0/2.0 x16_2	PCIe 3.0/2.0 x16_3	
Single VGA/PCIe card	x16 (single VGA recommended)	N/A	N/A	
Dual VGA/PCIe cards	x16	x16	N/A	
Triple VGA/PCIe cards	x16	x16	x8	

28-LANE CPU		PCI Express 3.0 operating mode		
VGA configuration	PCIe 3.0/2.0 x16_1	PCIe 3.0/2.0 x16_2	PCIe 3.0/2.0 x16_3	
Single VGA/PCIe card	x16 (single VGA recommended)	N/A	N/A	
Dual VGA/PCIe cards	x16	x8	N/A	
Triple VGA/PCIe cards	x16	x8	x4	



- We recommend that you provide sufficient power when running CrossFireX™ or SLI™ mode.
- Connect a chassis fan to the motherboard connector labeled CHA_FAN1-4 when using multiple graphics cards for better thermal environment.

	A	B	C	D	E	F	G	H
PCIe x16_1	shared	-	-	-	-	-	-	-
PCIe x16_2	shared	-	-	-	-	-	-	-
PCIe x16_3	shared	-	-	-	-	-	-	-
PCIe x1_1	-	-	-	shared	-	-	-	-
PCIe x4_1	-	-	shared	-	-	-	-	-
ASM 1142	shared	-	-	-	-	-	-	-
SMBus Controller	-	-	shared	-	-	-	-	-
SATA #0	-	shared	-	-	-	-	-	-
GbE Controller	-	-	-	-	shared	-	-	-
EHCI #0	-	-	-	-	-	-	-	shared
EHCI #1	-	-	shared	-	-	-	-	-
XHCI Controller	-	-	-	-	-	-	-	shared
RTL 8111GR	-	-	-	shared	-	-	-	-
Intel® LAN I218	-	-	shared	-	-	-	-	-
High Definition Audio	-	-	-	-	-	-	shared	-

1.2.6 Onboard buttons

Onboard buttons allow you to fine-tune performance when working on a bare or open-case system. This is ideal for overclockers and gamers who continually change settings to enhance system performance.

1. MemOK! button

Installing DIMMs that are not compatible with the motherboard may cause system boot failure, and the DRAM_LED near the MemOK! switch lights continuously. Press and hold the MemOK! button until the DRAM_LED starts blinking to begin automatic memory compatibility tuning for successful boot.

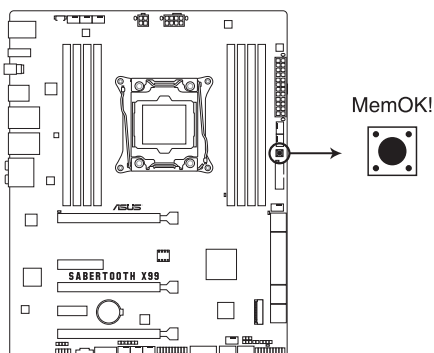

SABERTOOTH X99 MemOK! button



- Refer to section **Onboard LEDs** for the exact location of the DRAM_LED.
- The DRAM_LED also lights up when the DIMM is not properly installed. Turn off the system and reinstall the DIMM before using the MemOK! function.
- The MemOK! button does not function under Windows® OS environment.
- During the tuning process, the system loads and tests failsafe memory settings. It takes about 30 seconds for the system to test one set of failsafe settings. If the test fails, the system reboots and test the next set of failsafe settings. The blinking speed of the DRAM_LED increases, indicating different test processes.
- Due to memory tuning requirement, the system automatically reboots when each timing set is tested. If the installed DIMMs still fail to boot after the whole tuning process, the DRAM_LED lights continuously. Replace the DIMMs with ones recommended in the Memory QVL (Qualified Vendors Lists) in this user manual or on the ASUS website at www.asus.com.
- If you turn off the computer and replace DIMMs during the tuning process, the system continues memory tuning after turning on the computer. To stop memory tuning, turn off the computer and unplug the power cord for about 5–10 seconds.
- If your system fails to boot up due to BIOS overclocking, press the MemOK! button to boot and load the BIOS default settings. A message will appear during POST reminding you that the BIOS has been restored to its default settings.
- We recommend that you download and update to the latest BIOS version from the ASUS website at www.asus.com after using the MemOK! function.

1.2.7 Jumpers

1. Clear RTC RAM (3-pin CLRTC)

This jumper allows you to clear the Real Time Clock (RTC) RAM in CMOS. You can clear the CMOS memory of date, time, and system setup parameters by erasing the CMOS RTC RAM data. The onboard button cell battery powers the RAM data in CMOS, which include system setup information such as system passwords.

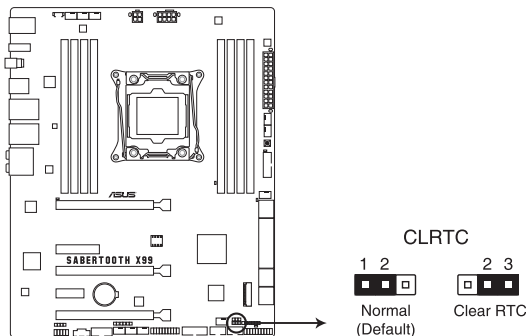

SABERTOOTH X99 Clear RTC RAM

To erase the RTC RAM:

1. Turn OFF the computer and unplug the power cord.
2. Move the jumper cap from pins 1-2 (default) to pins 2-3. Keep the cap on pins 2-3 for about 5-10 seconds, then move the cap back to pins 1-2.
3. Plug the power cord and turn ON the computer.
4. Hold down the <Delete> key during the boot process and enter BIOS setup to re-enter data.



Except when clearing the RTC RAM, never remove the cap on CLRTC jumper default position. Removing the cap will cause system boot failure!



- If the steps above do not help, remove the onboard battery and move the jumper again to clear the CMOS RTC RAM data. After the CMOS clearance, reinstall the battery.
- You do not need to clear the RTC when the system hangs due to overclocking. For system failure due to overclocking, use the C.P.R. (CPU Parameter Recall) feature. Shut down and reboot the system so the BIOS can automatically reset parameter settings to default values.
- Due to the chipset behavior, AC power off is required to enable C.P.R. function. You must turn off and on the power supply or unplug and plug the power cord before rebooting the system.

2. CPU Over Voltage jumper (3-pin CPU_OV)

The CPU Over Voltage jumper allows you to set a higher CPU voltage for a flexible overclocking system, depending on the type of the installed CPU. To gain more CPU voltage setting, insert the jumper to pins 2-3. To go back to its default CPU voltage setting, insert the jumper to pins 1-2.

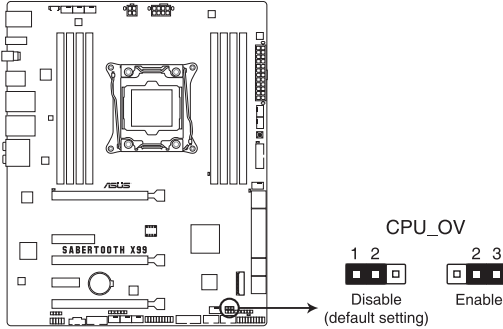

SABERTOOTH X99 CPU_OV setting

1.2.8 Onboard LEDs

1. POST State LEDs

The POST State LEDs provide the status of these key components during POST (Power-On-Self Test): CPU, memory modules, VGA card, and hard disk drives. If an error is found, the critical component's LED stays lit up until the problem is solved.

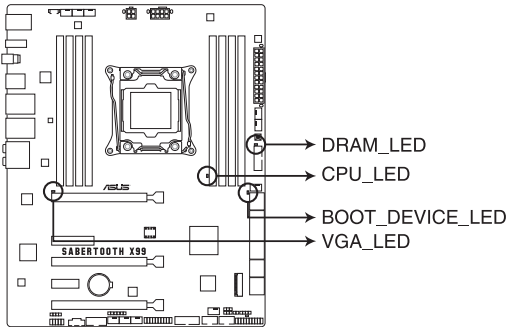

**SABERTOOTH X99 CPU/ DRAM/
BOOT_DEVICE/ VGA LED**

1.2.9 Internal connectors

1. Intel® X99 Serial ATA 6.0 Gb/s connectors (7-pin SATA6G_1-2 [beige]; SATA6G_3-6 [gray]; SATA Express [gray at the top]); SATA6G_7-10 [black]

These connectors connect to Serial ATA 6.0 Gb/s hard disk drives via Serial ATA 6.0 Gb/s signal cables.

If you installed Serial ATA hard disk drives, you can create a RAID 0, 1, 5, and 10 configuration with the Intel® Rapid Storage Technology through the onboard Intel® X99 chipset.

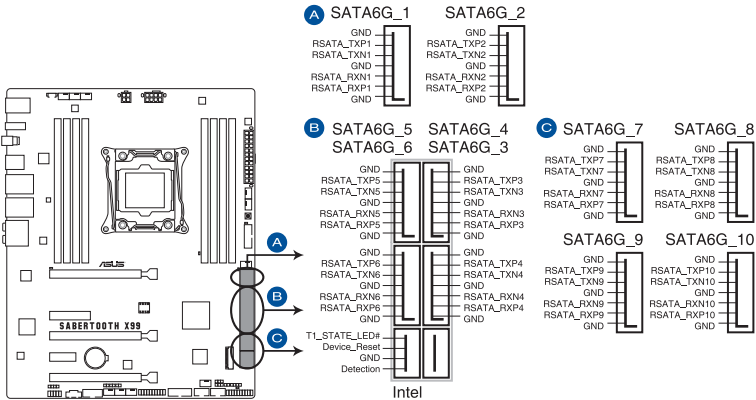

SABERTOOTH X99 Intel® SATA 6 Gb/s connectors

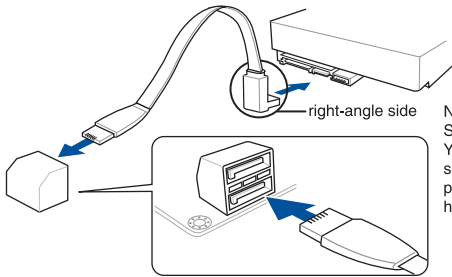

NOTE: Connect the right-angle side of SATA signal cable to SATA device. You may also connect the right-angle side of SATA cable to the onboard SATA port to avoid mechanical conflict with huge graphics cards.



- These connectors are set to **[AHCI Mode]** by default. If you intend to create a Serial ATA RAID set using these connectors, set the SATA Mode item in the BIOS to **[RAID Mode]**. Refer to section **3.6.3 SATA Configuration** for details.
- Before creating a RAID set, refer to section **5.1 RAID configurations** or the manual bundled in the motherboard support DVD.

2. USB 3.0 connector (20-1 pin USB3_12, USB3_34)

These connectors allow you to connect a USB 3.0 module for additional USB 3.0 front or rear panel ports. With an installed USB 3.0 module, you can enjoy all the benefits of USB 3.0 including faster data transfer speeds of up to 5 Gb/s, faster charging time for USB-chargeable devices, optimized power efficiency, and backward compatibility with USB 2.0.

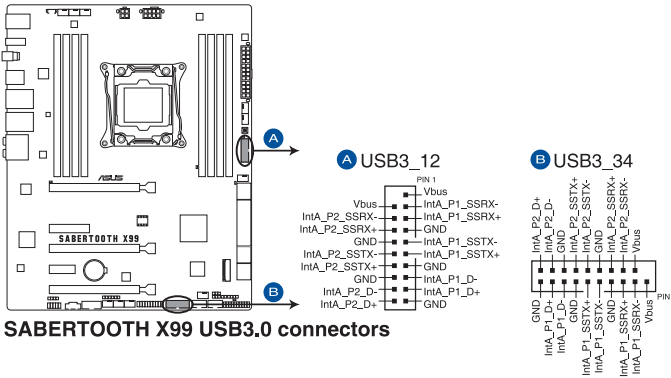

SABERTOOTH X99 USB3.0 connectors



The USB 3.0 module is purchased separately.



- Ensure to install the related driver to fully use the USB 3.0 ports under Windows® 7.
- The plugged USB 3.0 device may run on xHCI or EHCI mode depending on the operating system's setting.
- These USB 3.0 ports support native UASP transfer standard in Windows® 8 / Windows® 8.1 and Turbo Mode when using USB 3.1 Boost feature.

3. Digital audio connector (4-1 pin SPDIF_OUT)

This connector is for an additional Sony/Philips Digital Interface (S/PDIF) port. Connect the S/PDIF Out module cable to this connector, then install the module to a slot opening at the back of the system chassis.

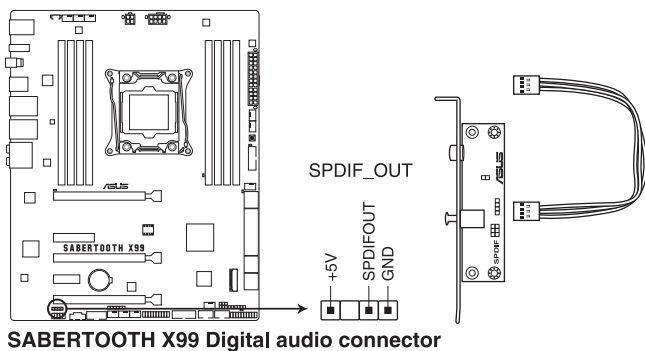

SABERTOOTH X99 Digital audio connector



The S/PDIF module is purchased separately.

4. USB 2.0 connectors (10-1 pin USB1112; USB1314)

These connectors are for USB 2.0 ports. Connect the USB module cable to any of these connectors, then install the module to a slot opening at the back of the system chassis. These USB connectors comply with USB 2.0 specification that supports up to 48 MBps connection speed.

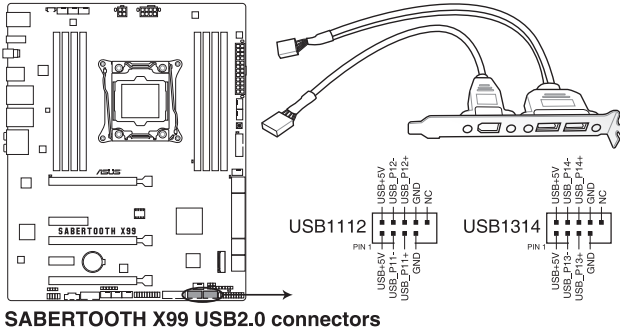

SABERTOOTH X99 USB2.0 connectors



DO NOT connect a 1394 cable to the USB connectors. Doing so will damage the motherboard!



You can connect the front panel USB cable to the ASUS Q-Connector (USB, dark brown) first, and then install the Q-Connector (USB) to the USB connector onboard if your chassis supports front panel USB ports.



The USB 2.0 module is purchased separately.

5. CPU, optional, chassis, and assistant fan connectors (4-pin CPU_FAN; 4-pin CPU_OPT; 4-pin CHA_FAN1-4; 3-pin ASST_FAN1-5)

Connect the fan cables to the fan connectors on the motherboard.

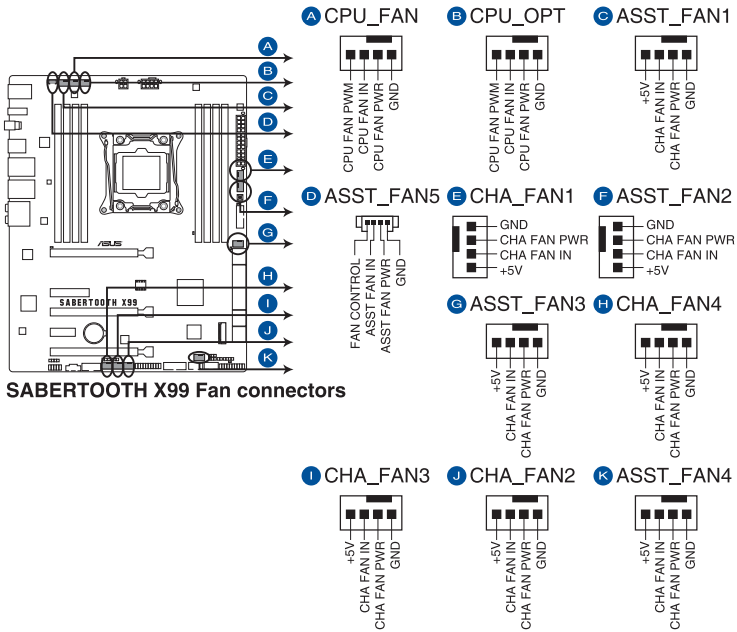

SABERTOOTH X99 Fan connectors



- DO NOT forget to connect the fan cables to the fan connectors. Insufficient air flow inside the system may damage the motherboard components. These are not jumpers! Do not place jumper caps on the fan connectors!
- Ensure that the CPU FAN cable is securely installed to the CPU fan connector.



- The CPU_FAN connector supports the CPU fan of maximum 1A (12 W) fan power.
- The CPU_FAN, CHA_FAN and ASST_FAN connectors support the TUF Thermal Radar 2 feature.
- To fully use the fan control function, ensure that you connect only an assistant fan to the ASST_FAN connectors.

6. Front panel audio connector (10-1 pin AAFP)

This connector is for a chassis-mounted front panel audio I/O module that supports either HD Audio or legacy AC'97 audio standard. Connect one end of the front panel audio I/O module cable to this connector.

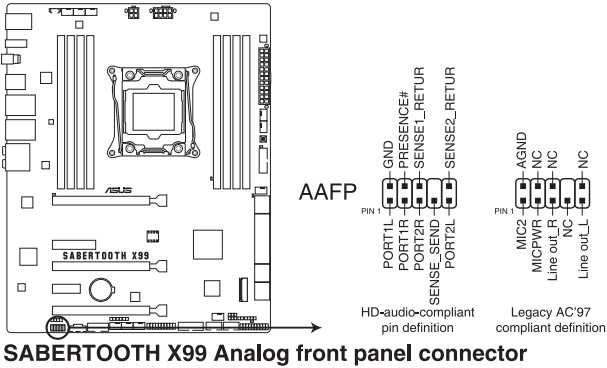

SABERTOOTH X99 Analog front panel connector



- We recommend that you connect a high-definition front panel audio module to this connector to avail of the motherboard's high-definition audio capability.
- If you want to connect a high-definition or an AC'97 front panel audio module to this connector, set the Front Panel Type item in the BIOS setup to **[HD]** or **[AC97]**.

7. Thermal Sensor connectors (2-pin T_SENSOR1; T_SENSOR2;T_SENSOR3)

These connectors are for the thermistor cables that monitor the temperature of the devices and the critical components inside the motherboard. Connect the thermistor cable and place the sensor on the device or the motherboard's component to detect its temperature.

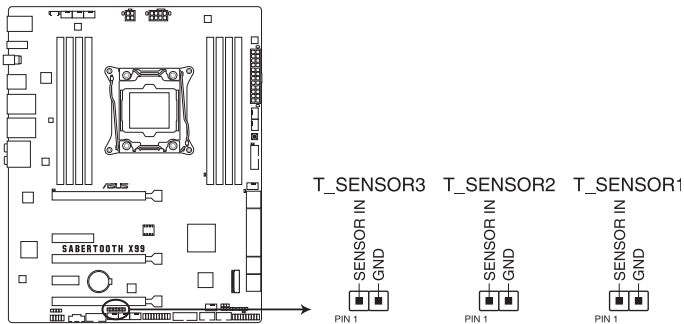

SABERTOOTH X99 T_SENSOR connectors

8. ATX power connectors (24-pin EATXPWR; 8-pin EATX12V)

These connectors are for ATX power supply plugs. The power supply plugs are designed to fit these connectors in only one orientation. Find the proper orientation and push down firmly until the connectors completely fit.

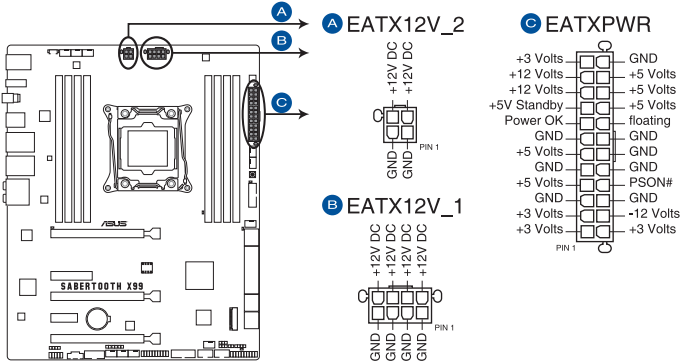

SABERTOOTH X99 ATX power connectors



- For a fully configured system, we recommend that you use a power supply unit (PSU) that complies with ATX 12 V Specification 2.0 (or later version) and provides a minimum power of 350 W.
- DO NOT forget to connect the 4-pin/8-pin EATX12 V power plug. Otherwise, the system will not boot.
- We recommend that you use a PSU with a higher power output when configuring a system with more power-consuming devices. The system may become unstable or may not boot up if the power is inadequate.
- If you want to use two or more high-end PCI Express x16 cards, use a PSU with 1000W power or above to ensure the system stability.

9. System panel connector (20-8 pin PANEL)

This connector supports several chassis-mounted functions.

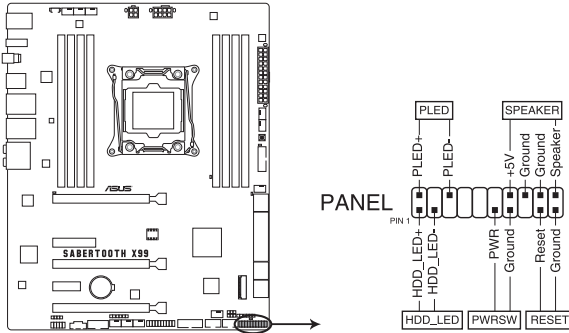

SABERTOOTH X99 System panel connector

- **System power LED (2-pin PLED)**

This 2-pin connector is for the system power LED. Connect the chassis power LED cable to this connector. The system power LED lights up when you turn on the system power, and blinks when the system is in sleep mode.

- **Hard disk drive activity LED (2-pin IDE_LED)**

This 2-pin connector is for the HDD Activity LED. Connect the HDD Activity LED cable to this connector. The IDE LED lights up or flashes when data is read from or written to the HDD.

- **System warning speaker (4-pin SPEAKER)**

This 4-pin connector is for the chassis-mounted system warning speaker. The speaker allows you to hear system beeps and warnings.

- **ATX power button/soft-off button (2-pin PWRSW)**

This connector is for the system power button. Pressing the power button turns the system on or puts the system in sleep or soft-off mode depending on the operating system settings. Pressing the power switch for more than four seconds while the system is ON turns the system OFF.

- **Reset button (2-pin RESET)**

This 2-pin connector is for the chassis-mounted reset button for system reboot without turning off the system power.

10. TPM connector (20-1 pin TPM)

This connector supports a Trusted Platform Module (TPM) system, which securely store keys, digital certificates, passwords and data. A TPM system also helps enhance the network security, protects digital identities, and ensures platform integrity.

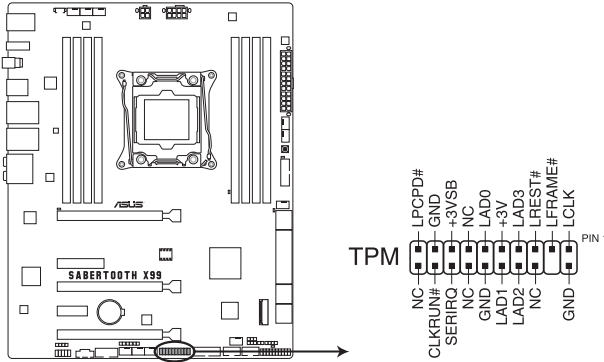

SABERTOOTH X99 TPM connector

11. DirectKey connector (2-pin DRCT)

This connector is for the chassis-mounted button that supports the DirectKey function. Connect the button cable that supports DirectKey, from the chassis to this connector on the motherboard.

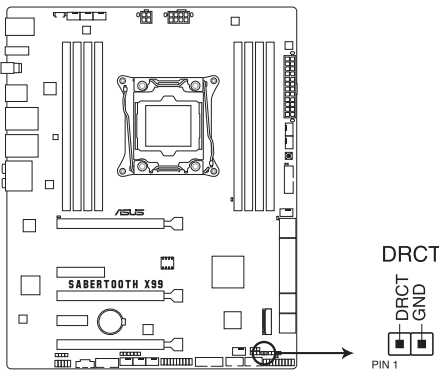

SABERTOOTH X99 DRCT connector



Ensure that your chassis comes with the extra button cable that supports the DirectKey feature. Refer to the technical documentation that came with the chassis for details.

12. Thunderbolt header (5-pin TB_HEADER)

This connector is for the add-on Thunderbolt I/O card that supports Intel®'s Thunderbolt Technology, allowing you to connect up to six Thunderbolt-enabled devices and a DisplayPort-enabled display in a daisy-chain configuration.

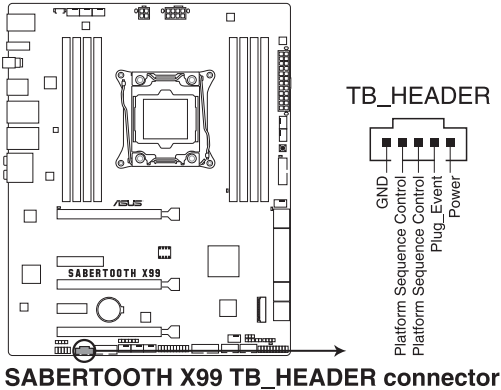

The add-on Thunderbolt I/O card and Thunderbolt cables are purchased separately.

13. M.2 socket 3

This socket allows you to install an M.2 (NGFF) SSD module.

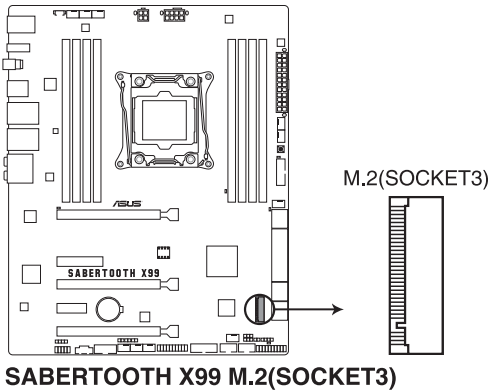

- This socket supports M Key and type 2242/2260/2280 storage devices.
- The M.2 Socket 3 shares bandwidth with PCIe x16_3 slot. Refer to section **3.6.3 PCH Storage Configuration** of this user guide for more details.



The M.2 (NGFF) SSD module is purchased separately.

14. Chassis intrusion connector (4-1 pin CHASSIS)

This connector is for a chassis-mounted intrusion detection sensor or switch. Connect one end of the chassis intrusion sensor or switch cable to this connector. The chassis intrusion sensor or switch sends a high-level signal to this connector when a chassis component is removed or replaced. The signal is then generated as a chassis intrusion event.

By default, the pin labeled “Chassis Signal” and “Ground” are shorted with a jumper cap. Remove the jumper caps and enable the related options in BIOS if you intend to use the chassis intrusion detection feature.

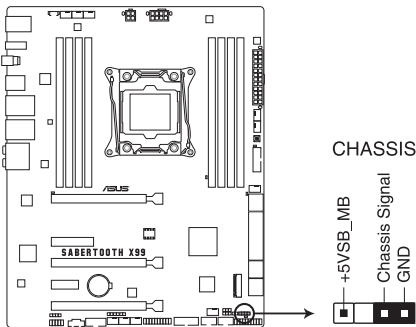

SABERTOOTH X99 Chassis intrusion connector



A message appears when you connect the sensor or switch at the first time or when you reconnect the sensor or switch to this connector. Reset the system to exit the message.

15. Serial port connector (10-1 pin COM)

These connectors are for the serial (COM) port. Connect the serial port module cable to one of these connectors, then install the module to a slot opening at the back of the system chassisS/PDIF Out module cable to this connector, then install the module to a slot opening at the back of the system chassis.

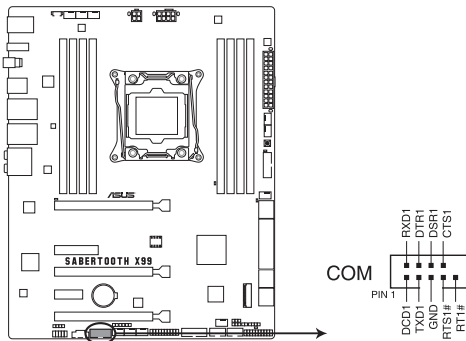

SABERTOOTH X99 Serial port connector



The S/PDIF module is purchased separately.

Basic installation

2

2.1 Building your PC system

2.1.1 Motherboard installation



The diagrams in this section are for reference only. The motherboard layout may vary with models, but the installation steps are the same for all models.

1. Install the ASUS Q-Shield to the chassis rear I/O panel.

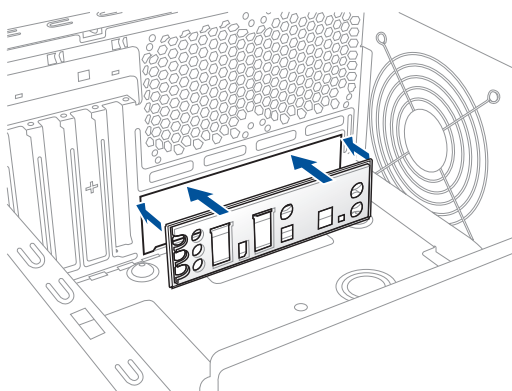

2. Place the motherboard into the chassis, ensuring that its rear I/O ports are aligned to the chassis' rear I/O panel.

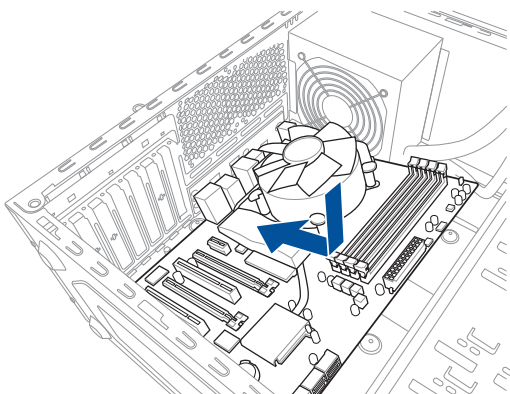

- Place nine screws into the holes indicated by circles to secure the motherboard to the chassis.

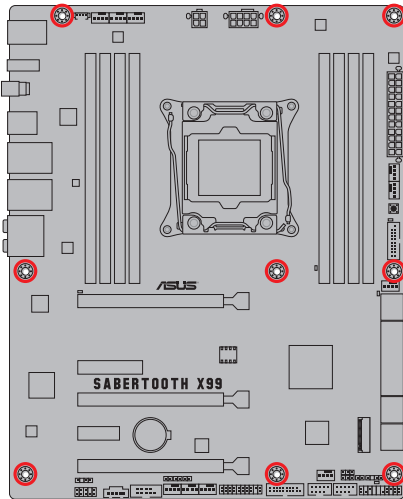
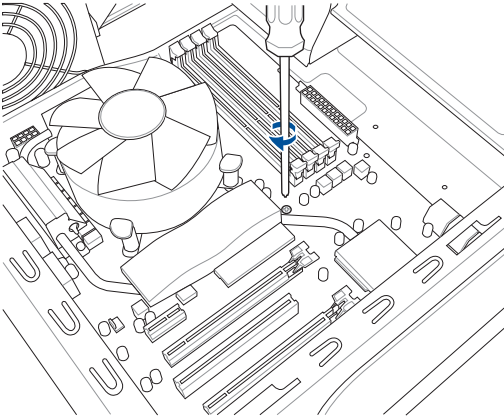

DO NOT over tighten the screws! Doing so can damage the motherboard.

2.1.2 CPU installation



Please note the order in opening/ closing the double latch. Follow the instructions printed on the metal sealing hatch or the illustrations shown below in this manual. The plastic cap will pop up automatically once the CPU is in place and the hatch properly sealed down.

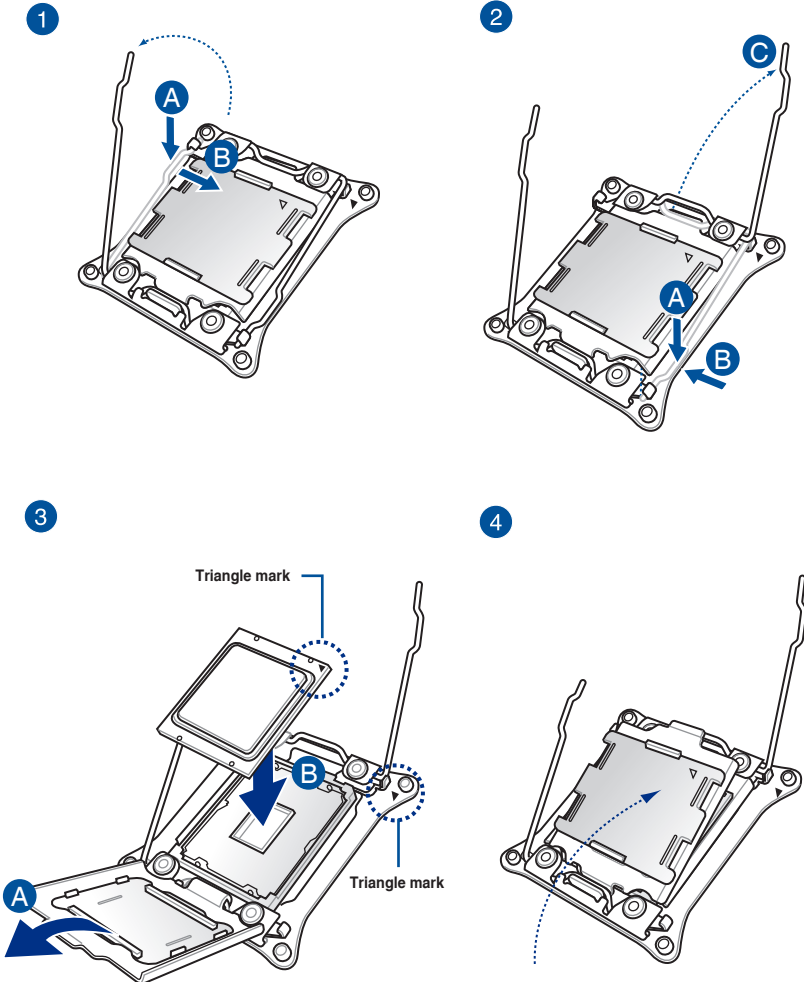

5

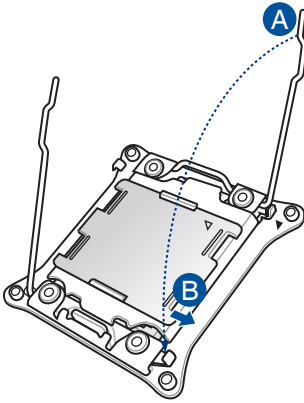

6

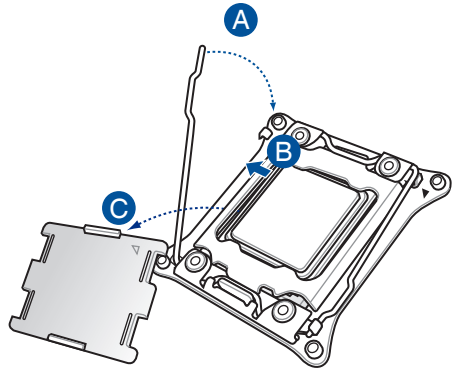

2.1.3 CPU heatsink and fan assembly installation

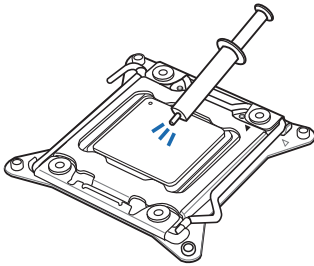

Apply the Thermal Interface Material to the CPU heatsink and CPU before you install the heatsink and fan, if necessary.

To install the CPU heatsink and fan assembly

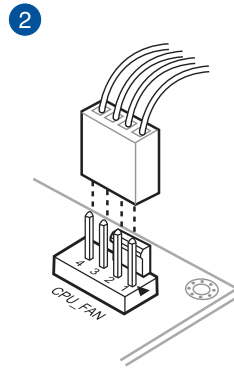
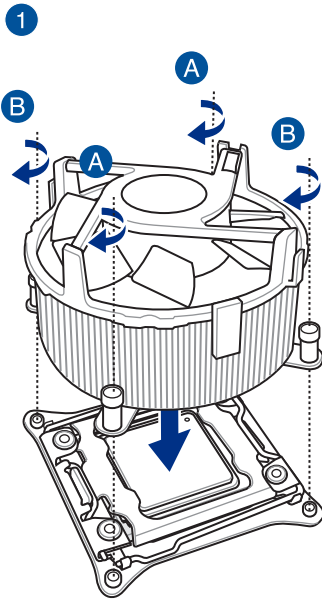

2.1.4 DIMM installation

1

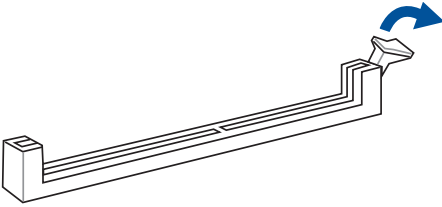

2

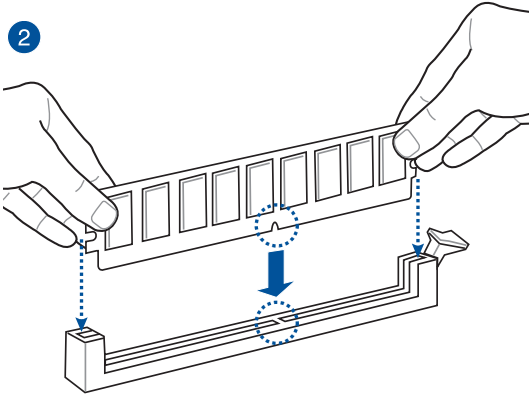

3

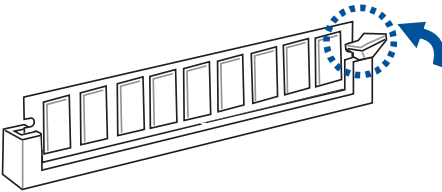

To remove a DIMM

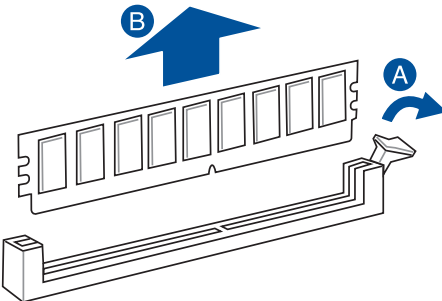

2.1.5 ATX Power connection

1

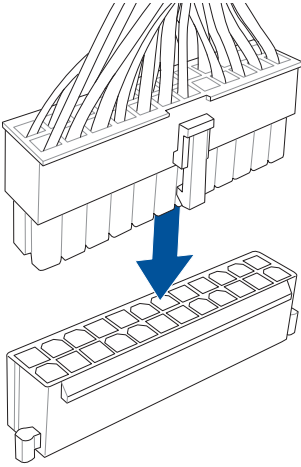

2

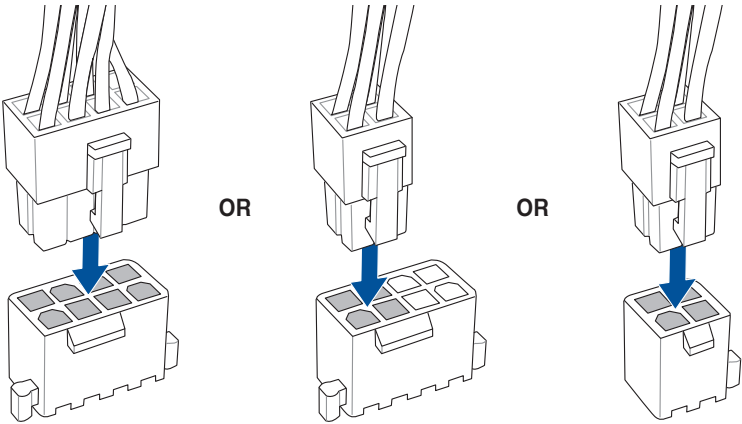

2.1.6 SATA device connection

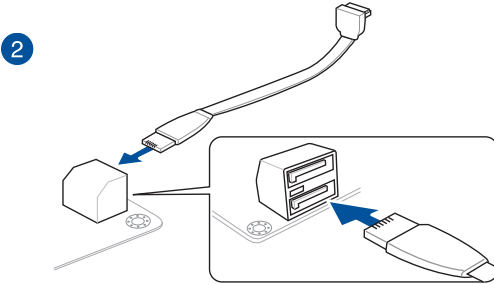
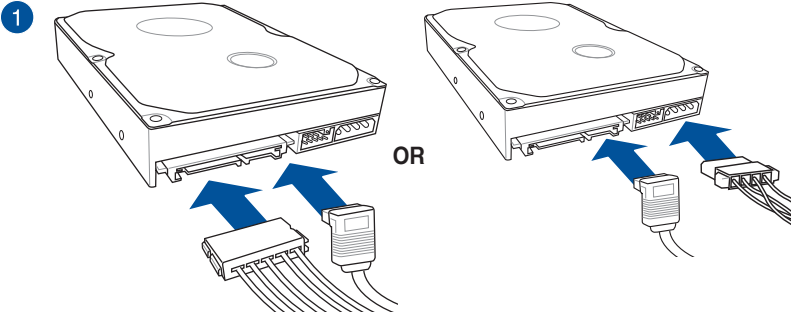

OR

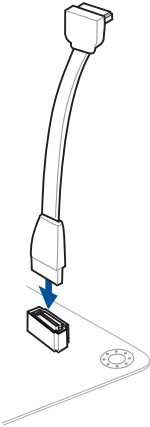

2.1.7 Front I/O Connector

To install ASUS Q-Connector

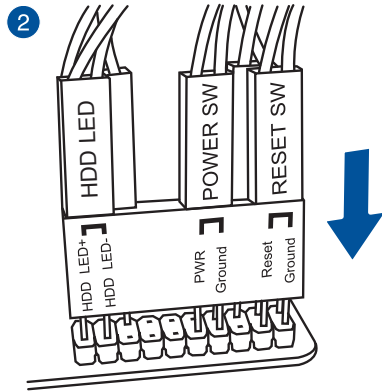
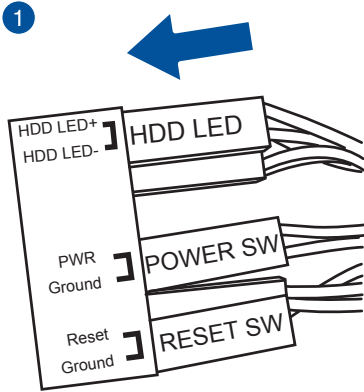

To install USB 2.0 connector

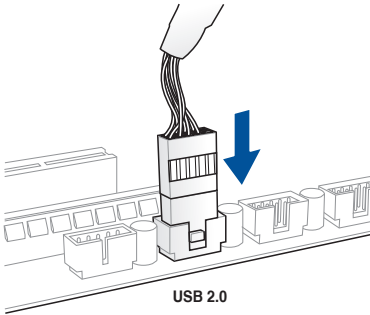

To install front panel audio connector

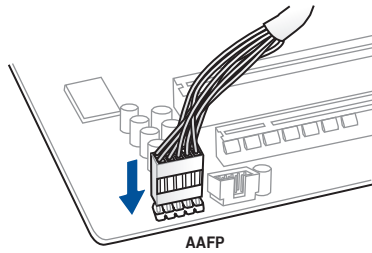

To install USB 3.0 connector

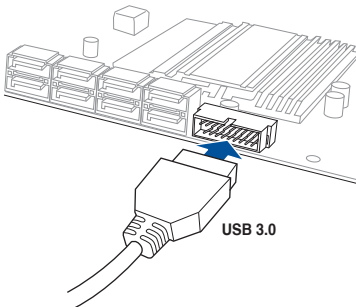

2.1.8 Expansion Card installation

To install PCIe x16 cards

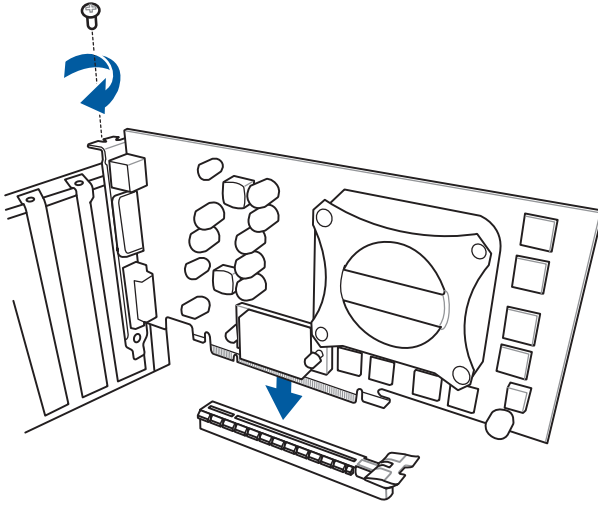

To install PCIe x1 cards

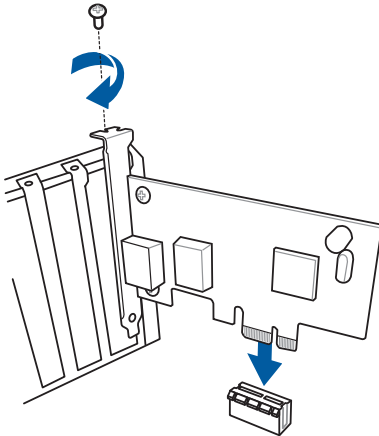

2.2 BIOS update utility

USB BIOS Flashback

USB BIOS Flashback allows you to easily update the BIOS without entering the existing BIOS or operating system. Simply insert a USB storage device to the USB port, press the USB BIOS Flashback button for three seconds, and the BIOS is updated automatically.

To use USB BIOS Flashback:

1. Place the bundled support DVD to the optical drive and install the USB BIOS Flashback Wizard. Follow the onscreen instructions to complete the installation.
2. Insert the USB storage device to the USB Flashback port.



- We recommend you to use a USB 2.0 storage device to save the latest BIOS version for better compatibility and stability.
- Please ensure to use the BIOS file named X99ST.CAP. Please refer to Chapter 3: BIOS setup for more information.

3. Launch the USB BIOS Flashback Wizard to automatically download the latest BIOS version.
4. Press the BIOS Flashback button for three seconds until a flashing light appears, which indicates that the BIOS Flashback function is enabled.
5. Wait until the light goes out, indicating that the BIOS updating process is completed.

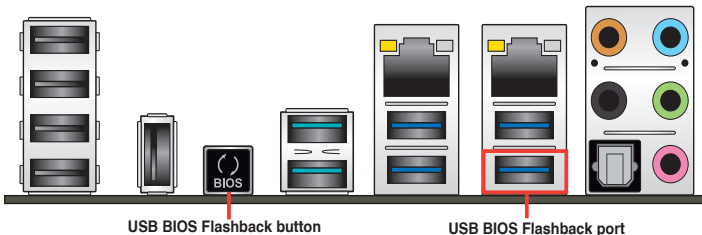

For more BIOS update utilities in BIOS setup, refer to the section **Updating BIOS** in Chapter 3.



- Do not unplug portable disk, power system, or use the CLR_CMOS jumper while BIOS update is ongoing, otherwise update will be interrupted. In case of interruption, please follow the steps again.
- If the light flashes for five seconds and turns into a solid light, this means that the BIOS Flashback is not operating properly. This may be caused by improper installation of the USB storage device and filename/file format error. If this scenario happens, please restart the system to turn off the light.
- Updating BIOS may have risks. If the BIOS program is damaged during the process and results to the system's failure to boot up, please contact your local ASUS Service Center.

2.3 Motherboard rear and audio connections

2.3.1 Rear I/O connection

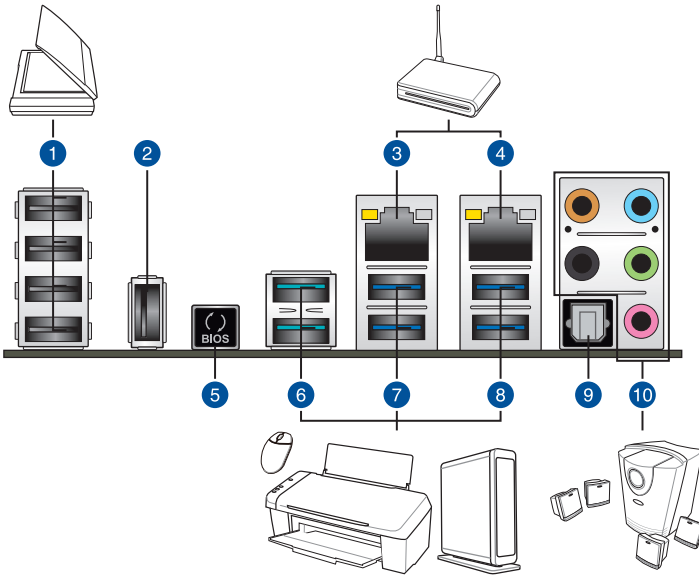

Rear panel connectors

1. USB 2.0 ports 7-10	6. USB 3.1 ports (support ASUS USB 3.1 Boost)
2. TUF Detective	7. USB 3.0 ports (support ASUS USB 3.1 Boost)
3. Intel LAN port*	8. USB 3.0 ports (support ASUS USB 3.1 Boost, bottom port supports USB BIOS Flashback)
4. Realtek LAN port*	9. Optical S/PDIF Out port
5. USB BIOS Flashback button	10. Audio I/O ports**

*and **: Refer to the tables on the next page for LAN port LEDs, and audio port definitions.



- USB 3.1/3.0 devices can only be used as data storage only.
- We strongly recommend that you connect your devices to ports with matching data transfer rate. Please connect your USB 3.0 devices to USB 3.0 ports and your USB 3.1 devices to USB 3.1 ports for faster and better performance for your devices.
- Due to the design of the Intel®9 series chipset, all USB devices connected to the USB 2.0 and USB 3.0 ports are controlled by the xHCI controller. Some legacy USB devices must update their firmware for better compatibility.

* LAN ports LED indications

Activity Link LED		Speed LED	
Status	Description	Status	Description
Off	No link	Off	10 Mbps connection
Orange	Linked	Orange	100 Mbps connection
Orange (Blinking)	Data activity	Green	1 Gbps connection
Orange (Blinking then steady)	Ready to wake up from S5 mode		

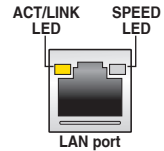

** Audio 2, 4, 6, or 8-channel configuration

Port	Headset 2-channel	4-channel	6-channel	8-channel
Light Blue	Line In	Line In	Line In	Line In
Lime	Line Out	Front Speaker Out	Front Speaker Out	Front Speaker Out
Pink	Mic In	Mic In	Mic In	Mic In
Orange	–	–	Center/Subwoofer	Center/Subwoofer
Black	–	Rear Speaker Out	Rear Speaker Out	Rear Speaker Out

2.3.2 Audio I/O connections

Audio I/O ports

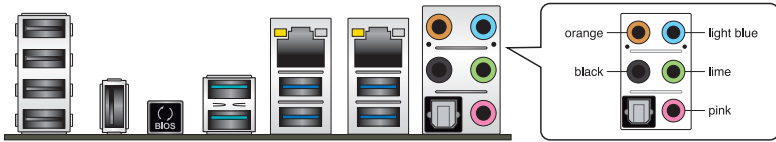

Connect to Headphone and Mic



Connect to Stereo Speakers

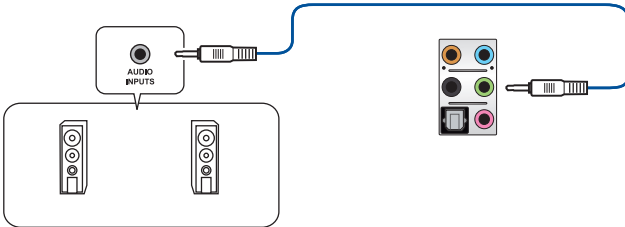

Connect to 2.1 channel Speakers

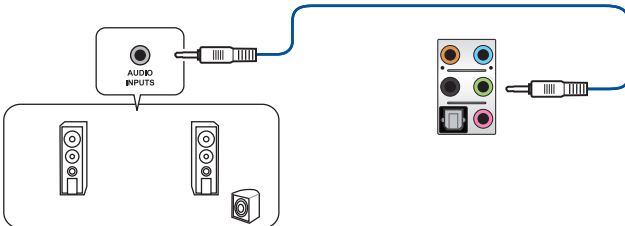

Connect to 4.1 channel Speakers

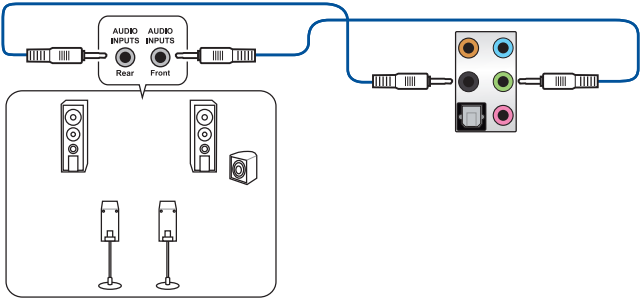

Connect to 5.1 channel Speakers

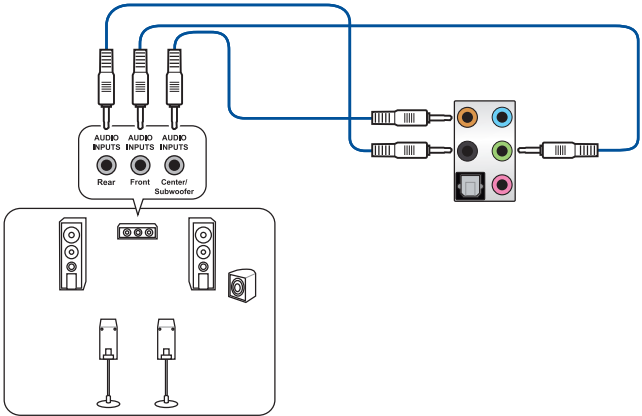

Connect to 7.1 channel Speakers

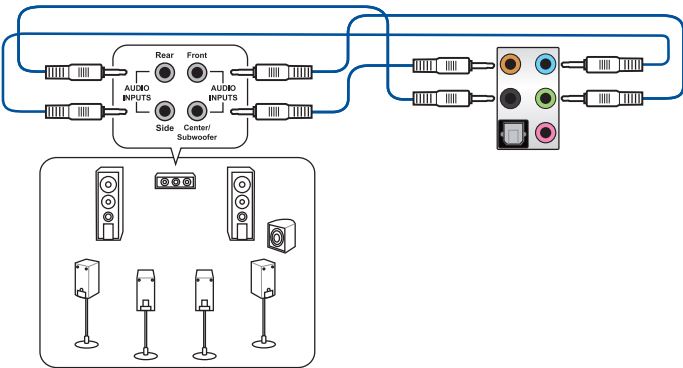

2.4 Starting up for the first time

1. After making all the connections, replace the system case cover.
2. Ensure that all switches are off.
3. Connect the power cord to the power connector at the back of the system chassis.
4. Connect the power cord to a power outlet that is equipped with a surge protector.
5. Turn on the devices in the following order:
 - a. Monitor
 - b. External SCSI devices (starting with the last device on the chain)
 - c. System power
6. After applying power, the system power LED on the system front panel case lights up. For systems with ATX power supplies, the system LED lights up when you press the ATX power button. If your monitor complies with the “green” standards or if it has a “power standby” feature, the monitor LED may light up or change from orange to green after the system LED turns on.

The system then runs the power-on self tests (POST). While the tests are running, the BIOS beeps (refer to the BIOS beep codes table) or additional messages appear on the screen. If you do not see anything within 30 seconds from the time you turned on the power, the system may have failed a power-on test. Check the jumper settings and connections or call your retailer for assistance.

BIOS Beep	Description
One short beep	VGA detected
	Quick boot set to disabled
	No keyboard detected
One continuous beep followed by two short beeps then a pause (repeated)	No memory detected
One continuous beep followed by three short beeps	No VGA detected
One continuous beep followed by four short beeps	Hardware component failure

7. At power on, hold down the <Delete> key to enter the BIOS Setup. Follow the instructions in Chapter 3.

2.5 Turning off the computer

While the system is ON, press the power button for less than four seconds to put the system on sleep mode or soft-off mode, depending on the BIOS setting. Press the power switch for more than four seconds to let the system enter the soft-off mode regardless of the BIOS setting.

BIOS setup

3

3.1 Knowing BIOS



The new ASUS UEFI BIOS is a Unified Extensible Interface that complies with UEFI architecture, offering a user-friendly interface that goes beyond the traditional keyboard-only BIOS controls to enable a more flexible and convenient mouse input. You can easily navigate the new UEFI BIOS with the same smoothness as your operating system. The term "BIOS" in this user manual refers to "UEFI BIOS" unless otherwise specified.

BIOS (Basic Input and Output System) stores system hardware settings such as storage device configuration, overclocking settings, advanced power management, and boot device configuration that are needed for system startup in the motherboard CMOS. In normal circumstances, the default BIOS settings apply to most conditions to ensure optimal performance. **DO NOT change the default BIOS settings** except in the following circumstances:

- An error message appears on the screen during the system bootup and requests you to run the BIOS Setup.
- You have installed a new system component that requires further BIOS settings or update.



Inappropriate BIOS settings may result in instability or boot failure. **We strongly recommend that you change the BIOS settings only with the help of a trained service personnel.**



When downloading or updating the BIOS file, rename it as **X99ST.CAP** for this motherboard.

3.2 BIOS setup program

Use the BIOS Setup to update the BIOS or configure its parameters. The BIOS screen include navigation keys and brief onscreen help to guide you in using the BIOS Setup program.

Entering BIOS at startup

To enter BIOS Setup at startup, press <Delete> during the Power-On Self Test (POST). If you do not press <Delete>, POST continues with its routines.

Entering BIOS Setup after POST

To enter BIOS Setup after POST:

- Press <Ctrl>+<Alt>+<Delete> simultaneously.
- Press the reset button on the system chassis.
- Press the power button to turn the system off then back on. Do this option only if you failed to enter BIOS Setup using the first two options.

After doing either of the three options, press <Delete> key to enter BIOS.



-
- The BIOS setup screens shown in this section are for reference purposes only, and may not exactly match what you see on your screen.
 - Ensure that a USB mouse is connected to your motherboard if you want to use the mouse to control the BIOS setup program.
 - If the system becomes unstable after changing any BIOS setting, load the default settings to ensure system compatibility and stability. Select the **Load Optimized Defaults** item under the **Exit** menu or press hotkey <F5>. See section 3.10 **Exit Menu** for details.
 - If the system fails to boot after changing any BIOS setting, try to clear the CMOS and reset the motherboard to the default value. See section 1.2.6 **Onboard buttons and switches** for information on how to erase the RTC RAM via the Clear CMOS button.
 - The BIOS setup program does not support the Bluetooth devices.
-

BIOS menu screen

The BIOS Setup program can be used under two modes: **EZ Mode** and **Advanced Mode**. You can change modes from the **Exit** menu or from the **Exit/Advanced Mode** screen.

3.2.1 EZ Mode

By default, the EZ Mode screen appears when you enter the BIOS setup program. The EZ Mode provides you an overview of the basic system information, and allows you to select the display language, system performance mode and boot device priority. To access the Advanced Mode, click **Exit/Advanced Mode**, then select **Advanced Mode** or press <F7> hot key for the advanced BIOS settings.



The default screen for entering the BIOS setup program can be changed between EZ Mode or Advanced Mode. Refer to the Setup Mode item in section 3.8 **Boot menu** for details.

The screenshot shows the UEFI BIOS Utility in EZ Mode. The interface is divided into several sections:

- Information:** Displays system properties like BIOS Ver. 0210, CPU (Intel(R) Core(TM) i7-5930K @ 3.50GHz), Speed (3500 Mhz), and Memory (4096 MB).
- CPU Temperature:** Shows a graph of CPU temperature, currently at 38°C.
- CPU Core Voltage:** Shows 1.024 V.
- Motherboard Temperature:** Shows 30°C.
- DRAM Status:** Lists DIMM slots A1 through D2, with slot C1 containing a 4GB 2133MHz module.
- SATA Information:** Lists SATA ports P1 through P7, all currently as N/A.
- Intel Rapid Storage Technology:** A toggle switch set to 'On'.
- CPU FAN:** A graph showing fan speed percentage over time, with a 'QFan Control' button below it.
- FAN Profile:** Lists various fans (CPU FAN, CHA1-4, CPU OPT, ASST2) and their current speeds (e.g., ASST1 FAN at 1581 RPM).
- EZ System Tuning:** A section for selecting system performance modes (Performance, Quiet, Energy Saving) with a 'Normal' mode selected.
- Boot Priority:** A section for selecting boot device priority, with a 'Switch all' button.
- Navigation:** Bottom buttons for 'Default(F5)', 'Save & Exit(F10)', and 'Advanced Mode(F7)'. A 'Boot Menu(F8)' icon is also present.

Callouts from the image provide the following explanations:

- Displays the system properties of the selected mode. Click < or > to switch EZ System Tuning modes** (points to EZ System Tuning)
- Displays the CPU/motherboard temperature, CPU voltage output, CPU/chassis/power fan speed, and SATA information** (points to Information, CPU Temperature, CPU Core Voltage, Motherboard Temperature, and SATA Information)
- Selects the display language of the BIOS setup program** (points to the language dropdown)
- Creates storage RAID and configures system overlocking** (points to Intel Rapid Storage Technology)
- Enables or disables the SATA RAID mode for Intel Rapid Storage Technology** (points to the SATA RAID mode dropdown)
- Displays the CPU Fan's speed. Click the button to manually tune the fans** (points to the QFan Control button)
- Shows the bootable devices** (points to the Boot Menu(F8) icon)
- Saves the changes and resets the system** (points to the Save & Exit(F10) button)
- Displays the Advanced mode menu** (points to the Advanced Mode(F7) button)
- Selects the boot device priority** (points to the Boot Priority section)
- Loads optimized default settings** (points to the Default(F5) button)



The boot device options vary depending on the devices you installed to the system.

3.2.2 Advanced Mode

The Advanced Mode provides advanced options for experienced end-users to configure the BIOS settings. The figure below shows an example of the Advanced Mode. Refer to the following sections for the detailed configurations.



To switch from EZ Mode to Advanced Mode, click **Advanced Mode** or press F7 hotkey.

The screenshot shows the 'UEFI BIOS Utility — Advanced Mode' interface. At the top, there is a 'Menu bar' with options: My Favorites, Main, Ai Tweaker, **Advanced**, Monitor, Boot, Tool, and Exit. Below the menu bar, the 'Language' is set to English. The 'MyFavorite' section lists several settings: Intel Adaptive Thermal Monitor, Limit CPUID Maximum, Execute Disable Bit, Intel Virtualization Technology, Hardware Prefetcher, Adjacent Cache Line Prefetcher, Boot Performance Mode, and Maximum CPU Core Temperature. The 'Q-Fan control' section shows a scroll bar with settings: Enabled, Enabled, Disabled, Enabled, Disabled, Enabled, Enabled, Max Performance, and Auto. The 'EZ Tuning Wizard' section shows a scroll bar with settings: Enabled, Enabled, Disabled, Enabled, Disabled, Enabled, Max Performance, and Auto. The 'Quick Note' section shows a scroll bar with settings: Enabled, Enabled, Disabled, Enabled, Disabled, Enabled, Max Performance, and Auto. The 'Hot Keys' section shows a scroll bar with settings: Enabled, Enabled, Disabled, Enabled, Disabled, Enabled, Max Performance, and Auto. The 'Hardware Monitor' section displays CPU, Memory, and Voltage information. The 'CPU' section shows Frequency (3500 MHz), Temperature (37°C), BCLK (100.0 MHz), Core Voltage (1.008 V), and Ratio (35x). The 'Memory' section shows Frequency (2133 MHz), Vol_CHAB (1.228 V), Capacity (4096 MB), and Vol_CHCD (1.225 V). The 'Voltage' section shows +12V (+5V), 12.096 V (5.040 V), +3.3V, and 3.296 V. The bottom of the screen shows 'Last Modified' and 'EzMode(F7) | [Esc]'.

Labels in the image include: Menu bar, Language, MyFavorite, Q-Fan control, EZ Tuning Wizard, Quick Note, Hot Keys, Sub-menu item, Item description, Configuration fields, Scroll bar, Last modified settings, Goes back to EZ Mode, Displays the CPU/motherboard temperature, CPU and memory voltage output, and Menu items.

Menu bar

The menu bar on top of the screen has the following main items:

My Favorites	For saving the frequently-used system settings and configuration.
Main	For changing the basic system configuration
Ai Tweaker	For changing the overclocking settings
Advanced	For changing the advanced system settings
Monitor	For displaying the system temperature, power status, and changing the fan settings.
Boot	For changing the system boot configuration
Tool	For configuring options for special functions
Exit	For selecting the exit options and loading default settings

Menu items

The highlighted item on the menu bar displays the specific items for that menu. For example, selecting **Main** shows the Main menu items.

The other items (My Favorites, Ai Tweaker, Advanced, Monitor, Boot, Tool, and Exit) on the menu bar have their respective menu items.

Submenu items

A greater than sign (>) before each item on any menu screen means that the item has a submenu. To display the submenu, select the item and press <Enter>.

Language

This button above the menu bar contains the languages that you can select for your BIOS. Click this button to select the language that you want to display in your BIOS screen.

MyFavorites (F3)

This button above the menu bar shows all BIOS items in a Tree Map setup. Select frequently-used BIOS settings and save it to MyFavorites menu.



Refer to section **3.3 My Favorites** for more information.

Q-Fan Control (F6)

This button above the menu bar displays the current settings of your fans. Use this button to manually tweak the fans to your desired settings.



Refer to section **3.2.3 QFan Control** for more information.

EZ Tuning Wizard (F11)

This button above the menu bar allows you to view and tweak the overclocking settings of your system. It also allows you to change the motherboard's SATA mode from AHCI to RAID mode.



Refer to section **3.2.4 EZ Tuning Wizard** for more information.

Quick Note (F9)

This button above the menu bar allows you to key in notes of the activities that you have done in BIOS.



-
- The Quick Note function does not support the following keyboard functions: delete, cut, copy and paste.
 - You can only use the alphanumeric characters to enter your notes.
-

Hot keys

This button above the menu bar contains the navigation keys for the BIOS setup program. Use the navigation keys to select items in the menu and change the settings.

Scroll bar

A scroll bar appears on the right side of a menu screen when there are items that do not fit on the screen. Press the Up/Down arrow keys or <Page Up> / <Page Down> keys to display the other items on the screen.

General help

At the top right corner of the menu screen is a brief description of the selected item. Use <F12> key to capture the BIOS screen and save it to the removable storage device.

Configuration fields

These fields show the values for the menu items. If an item is user-configurable, you can change the value of the field opposite the item. You cannot select an item that is not user-configurable.

A configurable field is highlighted when selected. To change the value of a field, select it and press <Enter> to display a list of options.

Last Modified button

This button shows the items that you last modified and saved in BIOS Setup.

3.2.3 Q-Fan Control

The Q-Fan Control allows you to set a fan profile or manually configure the operating speed of your CPU and chassis fans.



Configuring fans manually

Select **Manual** from the list of profiles to manually configure your fans' operating speed.

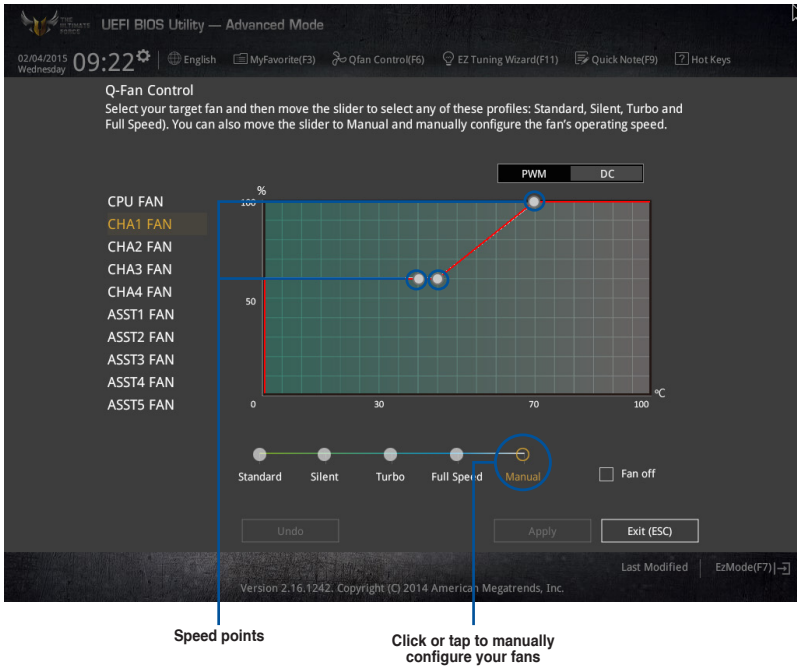

To configure your fans:

1. Select the fan that you want to configure and to view its current status.
2. Click and drag the speed points to adjust the fans' operating speed.
3. Click **Apply** to save the changes then click **Exit (ESC)**.

3.2.4 EZ Tuning Wizard

EZ Tuning Wizard allows you to overclock your CPU and DRAM, computer usage, and CPU fan to their best settings. You can also easily set RAID in your system using this feature.

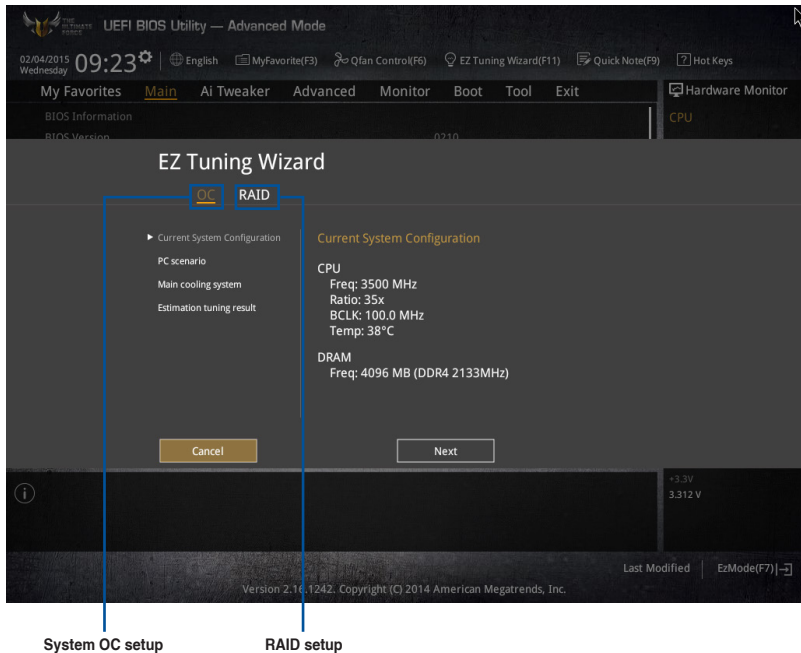

Tuning your system settings

To tune your settings:

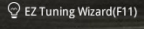
1. Press <F11> on your keyboard or click  from the BIOS screen to open EZ Tuning Wizard screen, then click **Next**.
2. Select a PC scenario **Daily Computing** or **Gaming/Media Editing**, then click **Next**.
3. Select the CPU fan type (**Box cooler**, **Tower cooler**, or **Water cooler**) that you installed then click **Next**.



If you are not sure of the CPU fan type, click **I'm not sure**. The system automatically detects the CPU fan type.

4. Click **Next** then click **Yes** to confirm auto-tuning.

Creating RAID

To create RAID:

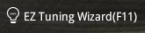
1. Press <F11> on your keyboard or click  from the BIOS screen to open EZ Tuning Wizard screen.
2. Click **RAID** then click **Next**.



- Ensure that your HDDs have no existing RAID volumes.
- Ensure to connect your HDDs to Intel® SATA connectors.

3. Select the type of storage for your RAID **Easy Backup** or **Super Speed**, then click **Next**.
 - a. For Easy Backup, click **Next** then select from **Easy Backup (RAID1)** or **Easy Backup (RAID10)**.



You can only select Easy Backup (RAID 10) if you connect four (4) HDDs.

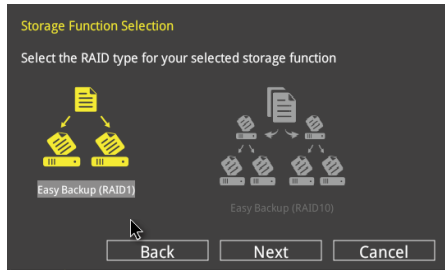

- b. For Easy Backup, click **Next** then select from **Super Speed (RAID0)** or **Super Speed (RAID5)**.

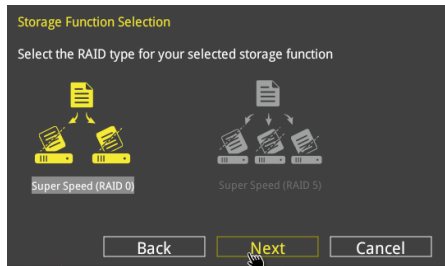

4. After selecting the type of RAID, click **Next** then click **Yes** to continue the RAID setup.
5. After the RAID setup is done, click **Yes** to exit the setup then click **OK** to reset your system.

3.3 My Favorites

My Favorites is your personal space where you can easily save and access your favorite BIOS items.



Adding items to My Favorites

To add BIOS items:

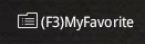
1. Press <F3> on your keyboard or click  from the BIOS screen to open Setup Tree Map screen.
2. On the Setup Tree Map screen, select the BIOS items that you want to save in MyFavorites screen.

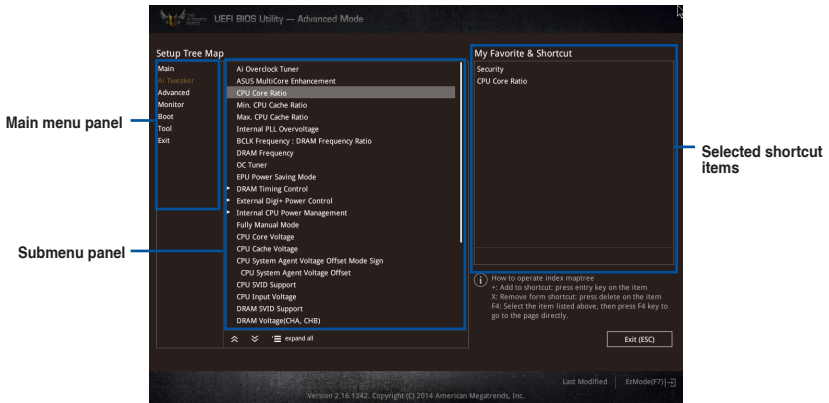

3. Select an item from main menu panel, then click the submenu that you want to save as favorite from the submenu panel and tap or click  or press <Enter> on your keyboard.



You cannot add the following items to My Favorite items:

- Items with submenu options
- User-managed items such as language and boot order
- Configuration items such as Memory SPD Information, system time and date.

4. Click **Exit (ESC)** or press <esc> key to close Setup Tree Map screen.
5. Go to My Favorites menu to view the saved BIOS items.

3.4 Main menu

The Main menu screen appears when you enter the Advanced Mode of the BIOS Setup program. The Main menu provides you an overview of the basic system information, and allows you to set the system date, time, language, and security settings.

The screenshot shows the UEFI BIOS Utility in Advanced Mode. The top bar displays the date and time (02/04/2015, 09:30), language (English), and various utility shortcuts. The main menu is divided into several sections: My Favorites, Main (selected), Ai Tweaker, Advanced, Monitor, Boot, Tool, and Exit. The Main menu lists system information such as BIOS Version (0210), Build Date (01/23/2015), and CPU Information (Intel(R) Core(TM) i7-5930K CPU @ 3.50GHz). The System Language is set to English, and the System Date is 02/04/2015. A Hardware Monitor section on the right shows CPU, Memory, and Voltage details.

Security

The Security menu items allow you to change the system security settings.

The screenshot shows the UEFI BIOS Utility in Advanced Mode, specifically the MainSecurity menu. The top bar is identical to the previous screenshot. The MainSecurity menu provides a Password Description and instructions for setting passwords. It lists the password length range (3 to 20 characters) and shows that both the Administrator Password and User Password are currently 'Not Installed'.



- If you have forgotten your BIOS password, erase the CMOS Real Time Clock (RTC) RAM to clear the BIOS password. See section 1.2.6 Onboard buttons and switches for information on how to erase the RTC RAM via the Clear CMOS button.
- The Administrator or User Password items on top of the screen show the default **[Not Installed]**. After you set a password, these items show **[Installed]**.

Administrator Password

If you have set an administrator password, we recommend that you enter the administrator password for accessing the system. Otherwise, you might be able to see or change only selected fields in the BIOS setup program.

To set an administrator password:

1. Select the **Administrator Password** item and press <Enter>.
2. From the **Create New Password** box, key in a password, then press <Enter>.
3. Confirm the password when prompted.

To change an administrator password:

1. Select the **Administrator Password** item and press <Enter>.
2. From the **Enter Current Password** box, key in the current password, then press <Enter>.
3. From the **Create New Password** box, key in a new password, then press <Enter>.
4. Confirm the password when prompted.

To clear the administrator password, follow the same steps as in changing an administrator password, but press <Enter> when prompted to create/confirm the password. After you clear the password, the **Administrator Password** item on top of the screen shows **Not Installed**.

User Password

If you have set a user password, you must enter the user password for accessing the system. The User Password item on top of the screen shows the default Not Installed. After you set a password, this item shows Installed.

To set a user password:

1. Select the **User Password** item and press <Enter>.
2. From the **Create New Password** box, key in a password, then press <Enter>.
3. Confirm the password when prompted.

To change a user password:

1. Select the **User Password** item and press <Enter>.
2. From the **Enter Current Password** box, key in the current password, then press <Enter>.
3. From the **Create New Password** box, key in a new password, then press <Enter>.
4. Confirm the password when prompted.

To clear the user password, follow the same steps as in changing a user password, but press <Enter> when prompted to create/confirm the password. After you clear the password, the **User Password** item on top of the screen shows **Not Installed**.

3.5 Ai Tweaker menu

The Ai Tweaker menu items allow you to configure overclocking-related items.



Be cautious when changing the settings of the Ai Tweaker menu items. Incorrect field values can cause the system to malfunction.



The configuration options for this section vary depending on the CPU and DIMM model you installed on the motherboard.

Scroll down to display other BIOS items.

UEFI BIOS Utility — Advanced Mode

03/04/2015 Wednesday 09:31 English MyFavorite(F3) Qfan Control(F6) EZ Tuning Wizard(F11) Quick Note(F9) Hot Keys

My Favorites Main **Ai Tweaker** Advanced Monitor Boot Tool Exit

Target CPU Turbo-Mode Frequency : 3700MHz
Target DRAM Frequency : 2133MHz
Target Cache Frequency : 3000MHz
Target DMI/PEG Frequency : 100MHz

Ai Overclock Tuner Auto

ASUS MultiCore Enhancement Auto

CPU Core Ratio Auto

Min. CPU Cache Ratio Auto

Max. CPU Cache Ratio Auto

Internal PLL Overvoltage Auto

BCLK Frequency : DRAM Frequency Ratio Auto

DRAM Frequency Auto

OC Tuning Auto

Hardware Monitor

CPU

Frequency	Temperature
3500 MHz	38°C

BCLK Core Voltage

100.0 MHz	1.024 V
-----------	---------

Ratio

35x

Memory

Frequency	Vol_CHAB
2133 MHz	1.231 V

Capacity	Vol_CHCD
4096 MB	1.234 V

Voltage

+12V	+5V
12.096 V	5.080 V
+3.3V	
3.312 V	

[i] (Manual): When the manual mode is selected, the BCLK(base clock) frequency can be assigned manually.
(XMP): When the XMP(extreme memory profile) mode is selected, the BCLK frequency and memory parameters will be optimized automatically.

Version 2.16.1242. Copyright (C) 2014 American Megatrends, Inc.

Last Modified | EzMode(F7) |

Ai Overclock Tuner [Auto]

This item allows you to select the CPU overclocking options to achieve the desired CPU internal frequency. Select any of these preset overclocking configuration options:

- [Auto] Loads the optimal settings for the system.
[Manual] Automatically optimizes the CPU ratio and BCLK frequency.



The following item appears only when you set the Ai Overclocking Tuner to **[Manual]**.

CPU Strap [Auto]

This item allows you to select a strap close to your target BCLK (base clock) for an extreme overclocking, or leave it at **[Auto]** for the BIOS to upgrade.

Configuration options: [Auto] [100MHz] [125MHz] [166MHz] [250MHz]



The following item appears only when you set the CPU Strap to **[100MHz]**, **[125MHz]**, **[167MHz]**, or **[250MHz]**.

Source Clock Tuner [Auto]

This item allows you to select the source clock based on the assigned CPU strap for a better overclocking capability.

Configuration options: [8Ohm db] [7Ohm db] [6Ohm db] [5Ohm db] [4Ohm db] [3Ohm db] [2Ohm db]

PLL Selection [Auto]

This item is set to LC PLL by default for better stability. Select SB PLL when the BCLK (base clock) frequency is far away from 100 MHz. This may affect the function of other devices that need precise clock jitters.

Configuration options: [Auto] [LC PLL] [SB PLL]

Filter PLL [Auto]

Set this item to high BCLK (base clock) mode when using a very high BCLK to improve overclocking capability.

Configuration options: [Auto] [Low BCLK mode] [High BCLK mode]

BCLK Frequency [100]

This item allows you to set the BCLK (base clock) frequency to enhance the system performance. Use the <+> or <-> to adjust the value. The values range from 80.0 MHz to 300.0 MHz.



We recommend you to set the value based on the CPU specification, as high BCLK frequencies may damage the CPU permanently.

Initial BCLK Frequency [Auto]

This item allows you to start overclocking the system from the initial BCLK (base clock) frequency to the assigned BCLK frequency. Use the <+> or <-> to adjust the value.

The value ranges depend on the value you set on BCLK Frequency.

ASUS MultiCore Enhancement [Auto]

[Auto] This item allows you to maximize the overclocking performance optimized by ASUS core ratio settings.

[Disabled] This item allows you to set to default core ratio settings.

CPU Core Ratio [Auto]

This item allows you to set the CPU core ratio limit per core or synchronize automatically to all cores.

Configuration options: [Auto] [Sync All Cores] [Per Core]

When the CPU Core Ratio is set to [Per Core], the following items appear:

1-Core Ratio Limit [Auto]

Select [Auto] to apply the CPU default Turbo Ratio setting or manually assign a 1-Core Limit value that must be higher than or equal to the 2-Core Ratio Limit.

2-Core Ratio Limit [Auto]

Select [Auto] to apply the CPU default Turbo Ratio setting or manually assign a 2-Core Limit value that must be higher than or equal to the 3-Core Ratio Limit.



If you assign a value for 2-Core Ratio Limit, do not set the 1-Core Ratio Limit to [Auto].

3-Core Ratio Limit [Auto]

Select [Auto] to apply the CPU default Turbo Ratio setting or manually assign a 3-Core Limit value that must be higher than or equal to the 4-Core Ratio Limit.



If you assign a value for 3-Core Ratio Limit, do not set the 1-Core Ratio Limit and 2-Core Ratio Limit to [Auto].

4-Core Ratio Limit [Auto]

Select [Auto] to apply the CPU default Turbo Ratio setting or manually assign a 4-Core Limit value that must be higher than or equal to the 3-Core Ratio Limit.



If you assign a value for 4-Core Ratio Limit, do not set the 1-Core Ratio Limit, 2-Core Ratio Limit, and 3-Core Ratio to [Auto].

5-Core Ratio Limit [Auto]

Select **[Auto]** to apply the CPU default Turbo Ratio setting or manually assign a 5-Core Limit value that must be higher than or equal to the 4-Core Ratio Limit.



If you assign a value for 5-Core Ratio Limit, do not set the 1-Core Ratio Limit, 2-Core Ratio Limit, 3-Core Ratio, and 4-Core Ratio to **[Auto]**.

6-Core Ratio Limit [Auto]

Select **[Auto]** to apply the CPU default Turbo Ratio setting or manually assign a 6-Core Limit value that must be higher than or equal to the 4-Core Ratio Limit.



If you assign a value for 6-Core Ratio Limit, do not set the 1-Core Ratio Limit, 2-Core Ratio Limit, 3-Core Ratio, 4-Core Ratio, and 5-Core Ratio to **[Auto]**.

Min. CPU Cache Ratio [Auto]

This item allows you to set the minimum possible ratio on the Uncore part of the processor. Use the <+> or <-> keys to adjust the value. The values depend on the CPU installed.

Max. CPU Cache Ratio [Auto]

This item allows you to set the maximum possible ratio on the Uncore part of the processor. Use the <+> or <-> keys to adjust the value. The values depend on the CPU installed.

Internal PLL Overvoltage [Auto]

This item allows you to enable the internal PLL Overvoltage for K-SKU CPUs to get the extreme overclocking capability.

Configuration options: [Auto] [Enabled] [Disabled]

BCLK Frequency: DRAM Frequency Ratio [Auto]

[Auto] The BCLK frequency to DRAM frequency ratio is set to the optimized setting.

[100:133] The BCLK frequency to DRAM frequency ratio is set to 100:133.

[100:100] The BCLK frequency to DRAM frequency ratio is set to 100:100.

DRAM Frequency [Auto]

This item allows you to set the memory operating frequency. The configurable options vary with the BCLK (base clock) frequency setting. Select the auto mode to apply the optimized setting.

Configuration options: [Auto] [DDR4-800MHz] [DDR4-1000MHz] [DDR4-1067MHz] [DDR4-1200MHz] [DDR4-1333MHz] [DDR4-1400MHz] [DDR4-1600MHz] [DDR4-1800MHz] [DDR4-1866MHz] [DDR4-2000MHz] [DDR4-2133MHz] [DDR4-2200MHz] [DDR4-2400MHz] [DDR4-2600MHz] [DDR4-2666MHz] [DDR4-2800MHz] [DDR4-2933MHz] [DDR4-3000MHz] [DDR4-3200MHz] [DDR4-3400MHz] [DDR4-3467MHz] [DDR4-3600MHz] [DDR4-3733MHz] [DDR4-3800MHz] [DDR4-4000MHz]

OC Tuner [Keep Current Settings]

This item allows you to automatically overclock the CPU and DRAM frequencies and voltage for an enhanced system performance. It also accelerates the CPU graphics performance to the extreme depending on the CPU graphics loading.

Configuration options: [Keep Current Settings] [Ratio First] [BCLK First]



Ensure that you installed an efficient CPU fan for CPU and graphics loading before selecting either **[BCLK First]** or **[Ratio First]**. To keep the current overclocking tuner status, select **[Keep Current Settings]**.

EPU Power Saving Mode [Disabled]

The ASUS EPU (Energy Processing Unit) sets the CPU in its minimum power consumption settings. Enable this item to set lower CPU VCCIN and Vcore voltages and achieve the best energy saving condition.

Configuration options: [Disabled] [Enabled]

DRAM Timing Control

The subitems in this menu allow you to set the DRAM timing control features. Use the <+> or <-> keys to adjust the value. To restore the default setting, type [auto] using the keyboard and press the <Enter> key.



Changing the values in this menu may cause the system to become unstable! If this happens, revert to the default settings.

Primary Timings

DRAM CAS# Latency [Auto]

Configuration options: [Auto] [1] – [31]

DRAM RAS# to CAS# Delay [Auto]

Configuration options: [Auto] [1] – [31]

DRAM RAS# PRE Time [Auto]

Configuration options: [Auto] [1] – [31]

DRAM RAS# ACT Time [Auto]

Configuration options: [Auto] [1] – [63]

DRAM Command Rate [Auto]

Configuration options: [Auto] [Timing T1] – [Timing T3]

Secondary Timings

DRAM RAS# to RAS# Delay [Auto]

Configuration options: [Auto] [1] – [7]

DRAM RAS# to RAS# Delay L [Auto]

Configuration options: [Auto] [1] – [7]

DRAM REF Cycle Time [Auto]

Configuration options: [Auto] [1] – [1023]

DRAM Refresh Interval [Auto]

Configuration options: [Auto] [1] – [32767]

DRAM WRITE Recovery Time [Auto]

Configuration options: [Auto] [1] – [31]

DRAM READ to PRE Time [Auto]

Configuration options: [Auto] [1] – [15]

DRAM FOUR ACT WIN Time [Auto]

Configuration options: [Auto] [1] – [63]

Secondary Timings

DRAM WRITE to READ Delay [Auto]

Configuration options: [Auto] [1] – [15]

DRAM WRITE to READ Delay(tWTR_L) [Auto]

Configuration options: [Auto] [1] – [15]

DRAM CKE Minimum Pulse Width [Auto]

Configuration options: [Auto] [5] – [8]

DRAM Write Latency [Auto]

Configuration options: [Auto] [1] – [31]

Third Timings

tRRDR [Auto]

Configuration options: [Auto] [1] - [7]

tRRDD [Auto]

Configuration options: [Auto] [1] - [7]

tWWDR [Auto]

Configuration options: [Auto] [1] - [7]

tWWDD [Auto]

Configuration options: [Auto] [1] - [7]

tRWDR [Auto]

Configuration options: [Auto] [1] - [7]

tWRDR [Auto]

Configuration options: [Auto] [1] - [7]

tWRDD [Auto]

Configuration options: [Auto] [1] - [7]

tRWSR [Auto]

Configuration options: [Auto] [1] - [7]

tCCD [Auto]

Configuration options: [Auto] [1] - [7]

Third Timings

tUWRDR [Auto]

Configuration options: [Auto] [1] - [3]

tRWDR2 [Auto]

Configuration options: [Auto] [0] - [31]

tRWDD [Auto]

Configuration options: [Auto] [0] - [31]

tRWSR2 [Auto]

Configuration options: [Auto] [0] - [31]

tWRDD2 [Auto]

Configuration options: [Auto] [0] - [31]

tCCDWR [Auto]

Configuration options: [Auto] [0] - [7]

tCCD_L [Auto]

Configuration options: [Auto] [0] - [7]

RTL IOL control

DRAM RTL INIT Value [Auto]

Configuration options: [Auto] [1] - [127]

DRAM RTL (CHA D0 R0) [Auto]

Configuration options: [Auto] [1] - [127]

DRAM RTL (CHA D0 R1) [Auto]

Configuration options: [Auto] [1] - [127]

DRAM RTL (CHA D1 R0) [Auto]

Configuration options: [Auto] [1] - [127]

DRAM RTL (CHA D1 R1) [Auto]

Configuration options: [Auto] [1] - [127]

DRAM RTL (CHB D0 R0) [Auto]

Configuration options: [Auto] [1] - [127]

DRAM RTL (CHB D0 R1) [Auto]

Configuration options: [Auto] [1] - [127]

DRAM RTL (CHB D1 R0) [Auto]

Configuration options: [Auto] [1] - [127]

DRAM RTL (CHB D1 R1) [Auto]

Configuration options: [Auto] [1] - [127]

DRAM RTL (CHC D0 R0) [Auto]

Configuration options: [Auto] [1] - [127]

DRAM RTL (CHC D0 R1) [Auto]

Configuration options: [Auto] [1] - [127]

RTL IOL control

- DRAM RTL (CHC D1 R0) [Auto]**
Configuration options: [Auto] [1] - [127]
- DRAM RTL (CHC D1 R1) [Auto]**
Configuration options: [Auto] [1] - [127]
- DRAM RTL (CHD D0 R0) [Auto]**
Configuration options: [Auto] [1] - [127]
- DRAM RTL (CHD D0 R1) [Auto]**
Configuration options: [Auto] [1] - [127]
- DRAM RTL (CHD D1 R0) [Auto]**
Configuration options: [Auto] [1] - [127]
- DRAM RTL (CHD D1 R1) [Auto]**
Configuration options: [Auto] [1] - [127]
- DRAM IO-L (CHA D0 R0) [Auto]**
Configuration options: [Auto] [1] - [255]
- DRAM IO-L (CHA D0 R1) [Auto]**
Configuration options: [Auto] [1] - [255]
- DRAM IO-L (CHA D1 R0) [Auto]**
Configuration options: [Auto] [1] - [255]
- DRAM IO-L (CHA D1 R1) [Auto]**
Configuration options: [Auto] [1] - [255]
- DRAM IO-L (CHB D0 R0) [Auto]**
Configuration options: [Auto] [1] - [255]
- DRAM IO-L (CHB D0 R1) [Auto]**
Configuration options: [Auto] [1] - [255]
- DRAM IO-L (CHB D1 R0) [Auto]**
Configuration options: [Auto] [1] - [255]
- DRAM IO-L (CHB D1 R1) [Auto]**
Configuration options: [Auto] [1] - [255]
- DRAM IO-L (CHC D0 R0) [Auto]**
Configuration options: [Auto] [1] - [255]
- DRAM IO-L (CHC D0 R1) [Auto]**
Configuration options: [Auto] [1] - [255]
- DRAM IO-L (CHC D1 R0) [Auto]**
Configuration options: [Auto] [1] - [255]
- DRAM IO-L (CHC D1 R1) [Auto]**
Configuration options: [Auto] [1] - [255]
- DRAM IO-L (CHD D0 R0) [Auto]**
Configuration options: [Auto] [1] - [255]
- DRAM IO-L (CHD D0 R1) [Auto]**
Configuration options: [Auto] [1] - [255]
- DRAM IO-L (CHD D1 R0) [Auto]**
Configuration options: [Auto] [1] - [255]
- DRAM IO-L (CHD D1 R1) [Auto]**
Configuration options: [Auto] [1] - [255]

IO control

MC Vref(CHA) [Auto]

Configuration options: [Auto] [50] - [99.911]

MC Vref(CHB) [Auto]

Configuration options: [Auto] [50] - [99.911]

MC Vref(CHC) [Auto]

Configuration options: [Auto] [50] - [99.911]

MC Vref(CHD) [Auto]

Configuration options: [Auto] [50] - [99.911]

DRAM Vref (CHA) [Auto]

Configuration options: [Auto] [60] - [99]

DRAM Vref (CHB) [Auto]

Configuration options: [Auto] [60] - [99]

DRAM Vref (CHC) [Auto]

Configuration options: [Auto] [60] - [99]

DRAM Vref (CHD) [Auto]

Configuration options: [Auto] [60] - [99]

CTL Vref (CHAB) Sign [+]

Configuration options: [+] [-]

CTL Vref (CHAB) [Auto]

Configuration options: [Auto] [0.00] - [0.20]

CTL Vref (CHCD) Sign [+]

Configuration options: [+] [-]

CTL Vref (CHCD) [Auto]

Configuration options: [Auto] [0.00] - [0.20]

Receiver DQ Pre-emphasis [Auto]

Configuration options: [Auto] [0.90] - [1.60]

Receiver DQ De-emphasis [Auto]

Configuration options: [Auto] [0.90] - [1.60]

Transmitter DQ Pre-emphasis [Auto]

Configuration options: [Auto] [0.90] - [1.60]

Receiver DQS Pre-emphasis [Auto]

Configuration options: [Auto] [0.90] - [1.60]

Receiver DQS De-emphasis [Auto]

Configuration options: [Auto] [0.90] - [1.60]

Transmitter DQS Pre-emphasis [Auto]

Configuration options: [Auto] [0.90] - [1.60]

Receiver CMD Pre-emphasis [Auto]

Configuration options: [Auto] [0.90] - [1.60]

Receiver CMD De-emphasis [Auto]

Configuration options: [Auto] [0.90] - [1.60]

Transmitter CMD Pre-emphasis [Auto]

Configuration options: [Auto] [0.90] - [1.60]

Receiver CLK Pre-emphasis [Auto]

Configuration options: [Auto] [1.00] - [2.00]

Receiver CLK De-emphasis [Auto]
Configuration options: [Auto] [1.00] - [1.60]

Transmitter CLK De-emphasis [Auto]
Configuration options: [Auto] [1.00] - [1.60]

Receiver CTL Pre-emphasis [Auto]
Configuration options: [Auto] [1.00] - [1.60]

Receiver CTL De-emphasis [Auto]
Configuration options: [Auto] [1.00] - [1.60]

Transmitter CTL De-emphasis [Auto]
Configuration options: [Auto] [1.00] - [1.60]

Receiver ODT Pre-emphasis [Auto]
Configuration options: [Auto] [1.00] - [1.60]

Receiver ODT De-emphasis [Auto]
Configuration options: [Auto] [1.00] - [1.60]

Transmitter ODT De-emphasis [Auto]
Configuration options: [Auto] [1.00] - [1.60]

MISC

DRAM Eventual Voltage (CHA/CHB/CHC/CHD) [Auto]

Use <+> or <-> to adjust the eventual voltages of the DIMM slots. The values range from 0.8 V to 1.9 V with a 0.10 increment.

DRAM CLK Period [Auto]

This item allows you to set a DRAM clock period.

Configuration options: [Auto] [1] – [19]

Memory Optimize Control [Auto]

This item allows you to optimize the memory control.

Configuration options: [Auto] [Enabled] [Disabled]

Enhanced Training (CHA/CHB/CHC/CHD) [Auto]

Configuration options: [Auto] [Enabled] [Disabled]

MemTest [Auto]

This item allows you to enable or disable the memory testing.

Configuration options: [Enabled] [Disabled]

Attempt Fast Boot [Auto]

This item allows the portion of the memory reference code to be skipped when possible to increase boot speed.

Configuration options: [Auto] [Enabled] [Disabled]

Attempt Fast Cold Boot [Auto]

This item allows the portion of the memory reference code to be skipped when possible to increase boot speed.

Configuration options: [Auto] [Enabled] [Disabled]

DRAM Training [Auto]

This item allows your system to set DRAM training test function.

DRAM SPD Write

This item is for advanced DRAM programming only. It allows you to enable DRAM SPD write to enable memory SMBus programming.

External Digi+ Power Control

CPU Input Boot Voltage [Auto]

This item allows you to set a higher CPU input boot voltage for better overclocking capability. Use the <+> or <-> to adjust the value. The values range from 0.80 V to 2.7 V with an interval of 10 V.

CPU Load-line Calibration [Auto]

Load-line is defined by Intel® specification and affects CPU power voltage. The CPU working voltage decreases proportionally to CPU loading. Higher load-line calibration could get higher voltage and good overclocking performance, but increases the CPU and VRM thermal conditions. Select from levels 1 to 9 to adjust the CPU power voltage from 0% to 125%.

Configuration options [Auto] [Level 1] - [Level 9]



The actual performance boost may vary depending on your CPU specification.



DO NOT remove the thermal module. The thermal conditions should be monitored.

CPU VRM Switching Frequency [Auto]

This item affects the VRM transient response speed and the component thermal production. Select [Manual] to configure a higher frequency for a quicker transient response speed.

Configuration options: [Auto] [Manual]



DO NOT remove the thermal module. The thermal conditions should be monitored.



The following item appears only when you set the CPU VRM Switching Frequency to [Manual].

Fixed CPU VRM Switching Frequency (KHz) [300]

This item allows you to set a higher frequency for a quicker transient response speed. Use the <+> or <-> to adjust the value. The values range from 300 KHz to 500 KHz with an interval of 50 KHz.

VRM Spread Spectrum [Disabled]

This item allows to enhance the system stability.

Configuration options: [Disabled] [Enabled]

Active Frequency Mode [Disabled]

This item allows to enhance the power saving condition of your system.

Configuration options: [Disabled] [Enabled]

CPU Power Phase Control [Auto]

This item allows you to set the power phase control of the CPU.

Configuration options: [Auto] [Standard] [Optimized] [Extreme] [Power Phase Response]



DO NOT remove the thermal module when setting this item to **[Power Phase Response]**. The thermal conditions should be monitored.



The following item appears only when you set the CPU Power Phase Control to **[Power Phase Response]**.

Power Phase Response [Fast]

This item allows you to set a faster phase response for the CPU to increase system performance or to slower phase response to decrease DRAM power efficiency.

Configuration options: [Ultra Fast] [Fast] [Medium] [Regular]

CPU Power Duty Control [T.Probe]

DIGI + VRM Duty Control adjusts the current of every VRM phase and the thermal conditions of every phase component.

[T. Probe] Select to maintain the VRM thermal balance.
[Extreme] Select to maintain the current VRM balance.



DO NOT remove the thermal module. The thermal conditions should be monitored.

CPU Current Capability [Auto]

This item provides a total power range for CPU overclocking. A higher value setting provides higher power consumption delivery and extends the overclocking frequency range simultaneously.

Configuration options: [Auto] [100%] [110%] [120%] [130%] [140%]

CPU Power Thermal Control [120]

A higher temperature brings a wider CPU power thermal range and extends the overclocking tolerance to enlarge the overclocking potential. Use the <+> or <-> keys to adjust the value. The values depend on the CPU installed.



DO NOT remove the thermal module. The thermal conditions should be monitored.

DRAM AB/CD Current Capability (CHA, CHB, CHC, CHD) [100%]

This item adjusts the total power range for DRAM overclocking. Set a higher value to provide a wider total power range and extends the overclocking frequency range simultaneously.

Configuration options: [100%] [110%] [120%] [130%]

DRAM AB/CD Switching Frequency (CHA, CHB, CHC, CHD) [Auto]

This item affects the overclocking range and system stability. Set this item to **[Manual]** to manually set a fixed DRAM switching frequency for an increased overclocking range or enhanced system stability.



The following item appears only when you set the DRAM Switching Frequency to **[Manual]**.

Fixed DRAM Switching Frequency (KHz) [300]

This item allows you to set a higher frequency for an increased overclocking range or a lower frequency for an enhanced system stability. Use the <+> or <-> to adjust the value. The values range from 300 KHz to 500 KHz with an interval of 50 KHz.

DRAM Power Phase Control (CHA, CHB, CHC, CHD) [Auto]

[Optimized] Set to the ASUS optimized phase tuning profile.

[Extreme] Set to the full phase mode.



DO NOT remove the thermal module when setting this item to **[Extreme]**. The thermal conditions should be monitored.

Internal CPU Power Management

The subitems in this menu allow you to set the CPU ratio and their features.

Enhanced Intel SpeedStep Technology [Enabled]

This item allows the operating system to dynamically adjust the processor voltage and cores frequency, resulting to a decreased average power consumption and decreased average heat production.

Configuration options: [Disabled] [Enabled]

Turbo Mode [Enabled]

This item allows you to enable your core processor's speed to run faster than the base operating frequency when it is below operating power, current and temperature specification limit.

Configuration options: [Disabled] [Enabled]



The following items appear only when you set the Turbo Mode to **[Enabled]**.

Turbo Mode Parameters

Long Duration Package Power Limit [Auto]

Allows you to limit the Turbo Ratio's time duration that exceeds the TDP (Thermal Design Power) for maximum performance. Use the <+> or <-> keys to adjust the value. The values range from 1 W to 4096 W.

Package Power Time Window [Auto]

Also known as Power Limit 1, this item allows you to maintain the time window for Turbo Ratio over TDP (Thermal Design Power). Use the <+> or <-> keys to adjust the value. The values range from 1 to 127 in seconds.

Short Duration Package Power Limit [Auto]

Also known as Power Limit 2, this item allows you to provide rapid protection when the package power exceeds the Power Limit 1. Use the <+> or <-> keys to adjust the value. The values range from 1 W to 4096 W.

CPU Integrated VR Current Limit [Auto]

Allows you to set a higher current limit to prevent frequency and power throttling when overclocking. Use the <+> or <-> keys to adjust the value. The values range from 0.125 to 1023.875 with a 0.125 interval.

CPU Integrated VR Fault Management [Auto]

Disable this item to prevent tripping the Fully Integrated Voltage Regulator when doing over-voltage. We recommend you to disable this item when overclocking.

Configuration options: [Auto] [Disabled] [Enabled]

CPU Integrated VR Efficiency Management [Auto]

This item allows you to improve the power rating when the CPU is in low power state, or make the FIVR (fully integrated voltage regulator) work in high performance at all times.

Configuration options: [Auto] [High Performance] [Balanced]

Fully Manual Mode [Disabled]

This item allows you to improve the power rating when the CPU is in low power state, or make the FIVR (fully integrated voltage regulator work in high performance at all times.

Configuration options: [Enable] [Balanced]

CPU Core Voltage [Auto]

This item allows you to configure the amount of voltage fed to the CPU cores. Increase the voltage when setting a high Core Frequency value.

Configuration options: [Auto] [Manual Mode] [Offset Mode]



The following item appears only when you set the CPU Core Voltage to **[Manual Mode]**.

CPU Core Voltage Override [Auto]

This item allows you to set the CPU Core Voltage override. Use the <+> or <-> keys to adjust the value, The values range from 0.001V to 1.920 V with a 0.001 V interval.



The following items appear only when you set the CPU Core Voltage to **[Offset Mode]**.

Offset Mode Sign [+]

[+] To offset the voltage by a positive value.

[-] To offset the voltage by a negative value.

CPU Core Voltage Offset

Use the <+> or <-> keys to adjust the value. The values range from 0.001 V to 0.999 V with a 0.001 V interval.

CPU Cache Voltage [Auto]

This item allows you to set the amount of voltage fed to the CPU uncores including its cache. Increase the voltage when setting a high CPU cache frequency.

Configuration options: [Auto] [Manual Mode] [Offset Mode]



The following item appears only when you set the CPU Cache Voltage to **[Manual Mode]**.

CPU Cache Voltage Override [Auto]

This item allows you to set the CPU Cache Voltage override. By default, this item takes the standard value of the installed CPU. You can use the <+> or <-> keys to adjust the value. The values range from 0.001 V to 1.920 V with a 0.001 V interval.



The following items appear only when you set the CPU Core Voltage to **[Offset Mode]**.

Offset Mode Sign [+]

- [+] To offset the voltage by a positive value.
- [-] To offset the voltage by a negative value.

CPU Cache Voltage Offset

Allows you to set the CPU cache voltage offset. By default, this item takes the standard value of the installed CPU. You can use the <+> or <-> keys to adjust the value. The values range from 0.001 V to 0.999 V with a 0.001 V interval.

CPU System Agent Voltage Offset Mode Sign [+]

- [+] To offset the voltage by a positive value.
- [-] To offset the voltage by a negative value.

CPU System Agent Voltage Offset [Auto]

This item allows you to set the amount of voltage fed to the system agent of the CPU including its PCIE controller and the PCU (power control unit). Increase the voltage to enhance the overclocking capability.

You can use the <+> or <-> keys to adjust the value. The values range from 0.001 V to 0.999 V with a 0.001 V interval.

CPU SVID Support [Auto]

Set this item to **[Enabled]** when overclocking your system. Disabling this item stops the CPU from communicating with the external voltage regulator.

Configuration options: [Auto] [Disabled] [Enabled]



The following item appears only when you set SVID Support to **[Enabled]**.

SVID Voltage Override [Auto]

This item allows you to set the SVID Voltage override. By default, this item takes the standard value of the installed CPU. You can use the <+> or <-> keys to adjust the value. The values range from 0.001V to 2.440 V with a 0.001 V interval.

CPU Input Voltage [Auto]

This item allows you to set an input voltage for the CPU by the external voltage regulator. By default, this item takes the standard value of the installed CPU. You can use the <+> or <-> keys to adjust the value. The values range from 0.800 V to 2.700 V with a 0.010 V interval.

DRAM Voltage [Auto]

This item allows you to set the DRAM voltage. You can use the <+> or <-> keys to adjust the value. The values range from 1.20 V to 1.92 V with a 0.005 V interval.



According to Intel® CPU specifications, DIMMs with voltage requirement over 1.65 V may damage the CPU permanently. We recommend that you install the DIMMs with the voltage requirement below 1.65 V.

PCH Core Voltage [Auto]

This item allows you to set the Core voltage for the PCH (Platform Controller Hub). You can use the <+> or <-> keys to adjust the value. The values range from 0.70 V to 1.80 V with a 0.0125 V interval.



- The values of the CPU PLL Voltage, CPU Manual Voltage, CPU Offset Voltage, iGPU Manual Voltage, iGPU Offset Voltage, DRAM Voltage, VCCSA Voltage, VCCIO Voltage, and PCH Voltage items are labeled in different color, indicating the risk levels of high voltage settings.
 - The system may need better cooling system for a more stable performance under high voltage settings.
-

PCH I/O Voltage [Auto]

This item allows you to set the I/O voltage on the PCH (Platform Controller Hub). You can use the <+> or <-> keys to adjust the value. The values range from 1.2000 V to 2.0000 V with a 0.0125 V interval.

VCCIO CPU 1.05V Voltage [Auto]

This item allows you to set the main power supply for the CPU REF. Use the <+> or <-> key to adjust the value. The values range from 0.7000 V to 1.8000 V at 0.0625 V increment.

VCCIO PCH 1.05V Voltage

This item allows you to set the main power supply for the PCH REF. Use the <+> or <-> key to adjust the value. The values range from 0.7000 V to 1.8000 V at 0.0625 V increment.

VTTDDR Voltage (CHA, CHB, CHC, CHD) [Auto]

This item allows you to set the termination voltage for the system memory. You can use the <+> or <-> keys to adjust the value. The values range from 0.6000 V to 1.0000 V with a 0.0125 V interval.

PLL Termination Voltage [Auto]

This item allows you to terminate the PLL Voltage. You can use the <+> or <-> keys to adjust the value. The values range from 0.20000 V to 3.098278 V with a 0.006602 V interval.

PLL Reference Offset Mode Sign

- [+] To offset the voltage by a positive value.
- [-] To offset the voltage by a negative value.

PLL Reference Offset Value [Auto]

This item allows you to configure the PLL reference value. You can use the <+> or <-> keys to adjust the value.

Configuration options: [Auto] [1] - [20]

CPU Spread Spectrum [Auto]

This item allows you to enhance the BCLK overclocking capability or reduce the EMI (electromagnetic disturbance) generated by the BCLK. Set this item to [Enabled] for EMI reduction, or set this item to [Disabled] to enhance BCLK overclocking.

Configuration options: [Auto] [Disabled] [Enabled]

3.6 Advanced menu

The Advanced menu items allow you to change the settings for the CPU and other system devices.



Be cautious when changing the settings of the Advanced menu items. Incorrect field values can cause the system to malfunction.

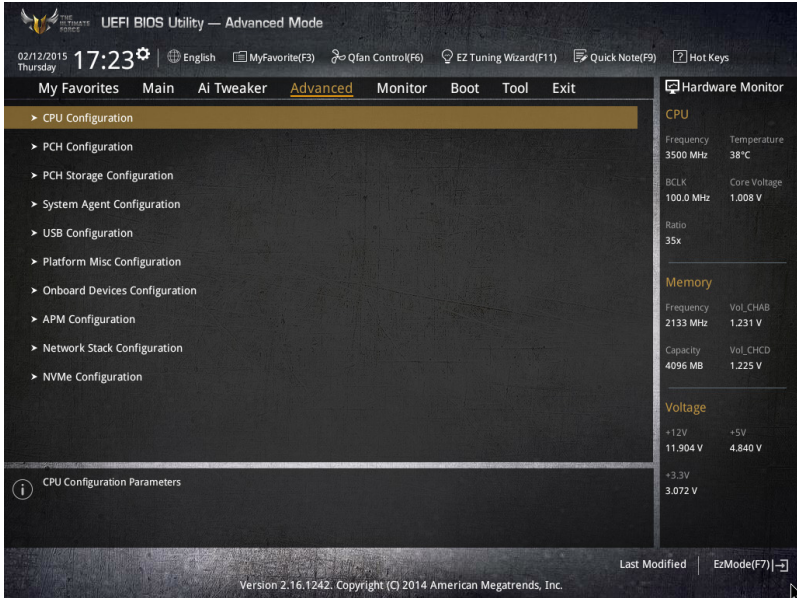

3.6.1 CPU Configuration

The items in this menu show the CPU-related information that the BIOS automatically detects.



The items in this menu may vary based on the CPU installed.

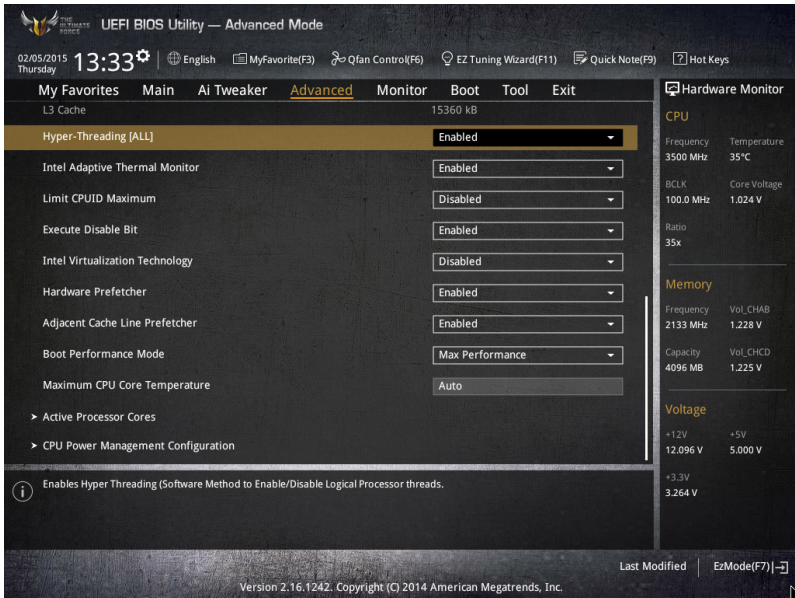

Hyper-Threading [ALL] [Enabled]

This item allows you to enable/disable the Hyper-Threading for logical processor threads.

Configuration options: [Enabled] [Disabled]

Intel Adaptive Thermal Monitor [Enabled]

This item allows you to protect the CPU by decreasing its frequency as it reaches the thermal throttle point. The thermal monitor includes TM1 (Thermal monitor 1), TM2 (Thermal monitor 2), and EMTTM (Enhanced Multi-threaded Thermal Monitoring).

Configuration options: [Disabled] [Enabled]

Limit CPUID Maximum [Disabled]

When set to [Enabled], this item allows the legacy OS to boot even without support for CPUs with extended CPUID functions.

Configuration options: [Disabled] [Enabled]

Execute Disable Bit [Enabled]

Execute Disable prevents certain classes of malicious buffer overflow attacks when combined with a supporting OS (SuSE Linux 9.2, RedHat Enterprise 3 Update 3).

Configuration options: [Disabled] [Enabled]

Intel Virtualization Technology [Disabled]

When set to **[Enabled]**, a VMM can utilize the additional hardware capabilities provided by Vanderpool Technology.

Configuration options: [Disabled] [Enabled]

Hardware Prefetcher [Enabled]

This item allows the CPU to prefetch commands and data in the L2 cache, reduces the DRAM loading time and improves the system performance.

Configuration options: [Disabled] [Enabled]

Adjacent Cache Line Prefetcher [Enabled]

This item allows the mid level cache (L2) to prefetch adjacent cache lines, reducing the DRAM loading time and improves the system performance.

Configuration options: [Disabled] [Enabled]

Boot Performance Mode [Max Performance]

This item allows you to select the CPU performance state during system boot before the operating system takes control. The CPU runs at a selected performance ratio based on CPU configuration.

Configuration options: [Max Non-Turbo Performance] [Max Battery] [Turbo Performance]

Maximum CPU Core Temperature

This item allows you to set the maximum allowable temperature for CPU cores. The CPU will throttle or shutdown when it reaches this temperature to prevent damaging the cores.



It is strongly recommended not to set this temperature above 105°C. High temperature may damage the CPU permanently.

Active Processor Cores

The items in this menu allow you to enable/disable the cores of your CPU.

Active Processor Core (0-5) [Enabled]

Configuration options: [Enabled] [Disabled]

CPU Power Management Configuration

This item allows you to manage and configure the CPU's power.

Enhanced Intel SpeedStep Technology [Enabled]

This item allows your system to adjust the CPU's voltage and cores frequency, resulting in decreased power consumption and heat production.

[Disabled] The CPU runs at its default speed.

[Enabled] The system controls the CPU speed.

Turbo Mode [Enabled]

This item allows you to automatically set the CPU cores to run faster than the base operating frequency when it is below the operating power, current and temperature specification limit.

Configuration options: [Enabled] [Disabled]

CPU C-states [Auto]

This item allows you to set the power saving of the CPU states.

Configuration options: [Auto] [Disabled] [Enabled]



The following items appear only when you set the CPU states to **[Enabled]**.

Enhanced C1 state [Enabled]

This item allows your CPU to reduce power consumption when the system is in idle mode.

Configuration options: [Enabled] [Disabled]

CPU C3 Report [Enabled]

This item allows you to disable or enable the CPU C3 report to the operating system.

Configuration options: [Enabled] [Disabled]

CPU C6 Report [Enabled]

This item allows you to disable or enable the CPU C6 report to the operating system.

Configuration options: [Enabled] [Disabled]

Package C State Support [Auto]

This item allows you to set the a C-state support for the CPU package.

Configuration options: [Auto] [Enabled] [C0/C1] [C2] [C3] [C6] [CPU C7] [CPU C7s]

3.6.2 PCH Configuration

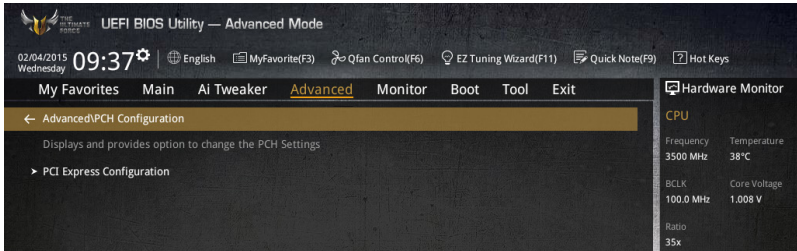

PCI Express Configuration

This item allows you to configure the PCI Express slots.

PCIEX4_1 Speed [Auto]

This item allows your system to automatically select the PCI Express port speed. When set to [Gen1], the PCI-E port runs at PCI-E 1.0 speed. When set to [Gen2], the PCI-E port runs at PCI-E 2.0 speed.

Configuration options: [Auto] [Gen1] [Gen2]

PCIEX1_1 Speed [Auto]

This item allows your system to automatically select the PCI Express port speed. When set to [Gen1], the PCI-E port runs at PCI-E 1.0 speed. When set to [Gen2], the PCI-E port runs at PCI-E 2.0 speed.

Configuration options: [Auto] [Gen1] [Gen2]

3.6.3 PCH Storage Configuration

While entering Setup, the BIOS automatically detects the presence of SATA devices. The SATA Port items show **Not Present** if no SATA device is installed to the corresponding SATA port.

Scroll down to display the other BIOS items.

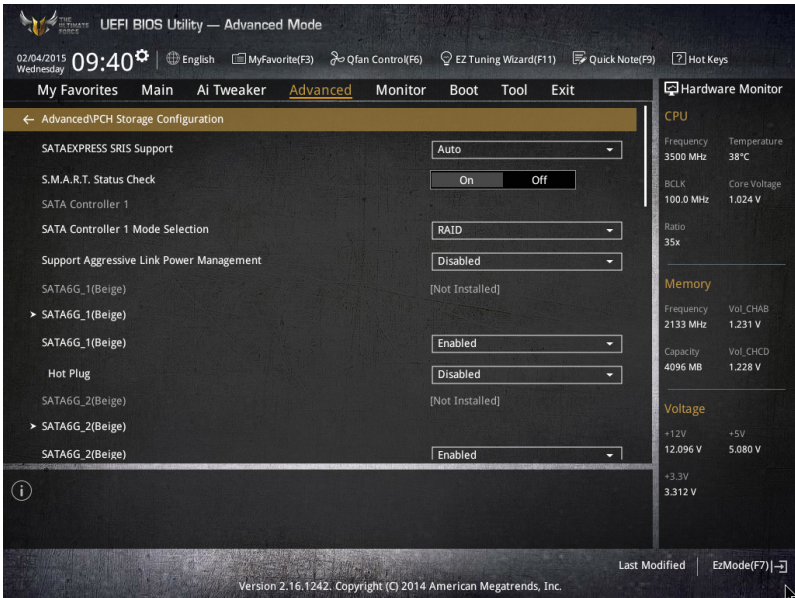

SATAExpress_1 SRIS Support [Auto]

When set to **[Auto]**, this item allows the system to automatically adjust the SRIS (Separate Reference Clock Independent Spread Spectrum Clocking Architecture) support for connected SATA Express devices. Set this item to **[Disabled]** to activate ASUS RUNWAY SATA Express bridge card

Configuration options: [Auto] [Disabled]

S.M.A.R.T. Status Check [On]

S.M.A.R.T. (Self-Monitoring, Analysis and Reporting Technology) is a monitoring system that shows a warning message during POST (Power-on Self Test) when an error occurs in the hard disks.

Configuration options: [On] [Off]

SATA Controller 1 Mode Selection [AHCI]

This item allows you to set the SATA configuration.

- [Disabled] Disables the SATA function.
- [IDE Mode] Set to [IDE Mode] when you want to use the Serial ATA hard disk drives as Parallel ATA physical storage devices.
- [AHCI Mode] Set to [AHCI Mode] when you want the SATA hard disk drives to use the AHCI (Advanced Host Controller Interface). The AHCI allows the onboard storage driver to enable advanced Serial ATA features that increases storage performance on random workloads by allowing the drive to internally optimize the order of commands.
- [RAID Mode] Set to [RAID Mode] when you want to create a RAID configuration from the SATA hard disk drives.



The following item appears only when you set the SATA Mode Selection to [IDE].

SATA6G_1-2 (beige), SATA6G_3-6 (gray)

These items display all connected devices to SATA6G ports. If some ports are not used, these items show **[Not Installed]**.

SATA Controller 2 Mode Selection [AHCI]

This item allows you to set the SATA configuration.

- [Disabled] Disables the SATA function.
- [IDE Mode] Set to [IDE Mode] when you want to use the Serial ATA hard disk drives as Parallel ATA physical storage devices.
- [AHCI Mode] Set to [AHCI Mode] when you want the SATA hard disk drives to use the AHCI (Advanced Host Controller Interface). The AHCI allows the onboard storage driver to enable advanced Serial ATA features that increases storage performance on random workloads by allowing the drive to internally optimize the order of commands.



Due to Intel® chipset specification, the SATA ports from controller 2 does not support Intel® Rapid Storage Technology including RAID configuration.



The following item appears only when you set the SATA Mode Selection to [IDE].

SATA6G_7-10 (Black)

These items display all connected devices to SATA6G ports. If some ports are not used, these items show **[Not Installed]**.

Support Aggressive Link Power Management [Disabled]

This item is designed for LPM (link power management) support with a better energy saving conditions. When disabled, the hot plug function of SATA ports are disabled.

Configuration options: [Disabled] [Enabled]

Hot Plug [Disabled] (SATA6G_1-2 (beige), SATA6G_3-6 (gray) / SATA6G_7-10 (Black))

These items allow you to enable/disable SATA Hot Plug Support.

Configuration options: [Disabled] [Enabled]

3.6.4 System Agent Configuration

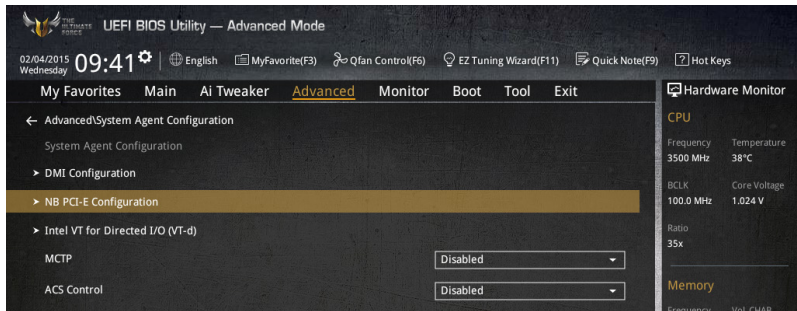

DMI Configuration

This item in this menu allows your DMI (direct media interface) to run at PCI-E 2.0 speed.

DMI Gen 2

Configuration options: [Disabled] [Enabled]

NB PCIe Configuration

This item allows you to configure the NB PCI Express settings.

PCIEX16_1 Link Speed [Auto]

This item allows you to select the operating speed of the PCIEX16_1.

Configuration options: [Auto] [Gen1] [Gen2] [Gen3]

PCIEX16_2 Link Speed [Auto]

This item allows you to select the operating speed of the PCIEX16_2.

Configuration options: [Auto] [Gen1] [Gen2] [Gen3]

PCIEX16_3 Link Speed [Auto]

This item allows you to select the operating speed of the PCIEX16_3.

Configuration options: [Auto] [Gen1] [Gen2] [Gen3]

Intel VT for Directed I/O

The items in this menu allow you to configure the Intel® Virtualization Technology for Directed I/O (VT-d).

Intel VT for Directed I/O (VT-d) [Disabled]

This item allows you to enable/disable the Intel Virtualization Technology for Directed I/O (VT-d) by reporting the I/O device assignment to VMM through DMAR ACPI Tables.

Configuration options: [Enabled] [Disabled]

MCTP

This item allows you to Enable/Disable MCTP.

ACS Control

This item allows you to use ACS Control.



The following items appear only when you set the Intel VT for Directed I/O (VT-d) to **[Enabled]**.

Interrupt Remapping [Enabled]

This item allows you to enable/disable the VT-D Interrupt Remapping Support.

Configuration options: [Enabled] [Disabled]

Coherency Support (Non-Isch) [Enabled]

This item allows you to enable/disable the Non-Isch VT_D Engine Coherency Support.

Configuration options: [Enabled] [Disabled]

Coherency Support (Isch) [Enabled]

This item allows you to enable/disable the Isch VT_D Engine Coherency Support.

Configuration options: [Enabled] [Disabled]

3.6.5 USB Configuration

The items in this menu allow you to change the USB-related features.

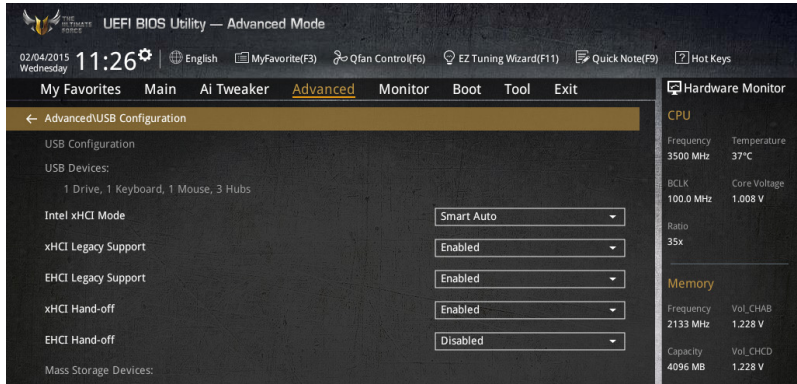

The **Mass Storage Devices** item shows the auto-detected values. If no USB device is detected, the item shows **None**.

Intel xHCI Mode [Smart Auto]

- [Auto] The xHCI is automatically enabled and runs at USB 3.0 mode when the xHCI driver is installed in the operating system.
- [Smart Auto] Upon detection, the xHCI driver supports the USB 3.0 mode during both POST and operating system.
- [Enabled] Enables the xHCI controller.
- [Disabled] Disables the xHCI controller.

xHCI Legacy USB Support [Enabled]

- [Enabled] Your system supports the USB 3.0 devices in legacy operating systems.
- [Disabled] Your USB 3.0 devices can be used for BIOS setup only and cannot be recognized in the boot devices list.
- [Auto] Your system automatically detects the presence of USB3.0 devices at startup. If any USB 3.0 devices are detected, the xHCI legacy USB support is enabled.

EHCI Legacy USB Support [Enabled]

- [Enabled] Your system supports the USB 2.0 devices in legacy operating systems.
- [Disabled] Your USB 2.0 devices can be used for BIOS setup only and cannot be recognized in the boot devices list.
- [Auto] Your system automatically detects the presence of USB 2.0 devices at startup. If any USB 2.0 devices are detected, the xHCI legacy USB support is enabled.

xHCI Hand-off [Disabled]

[Enabled] Enables the support for operating systems without an xHCI hand-off feature.

[Disabled] Disables the xHCI Hand-off support.

EHCI Hand-off [Disabled]

[Enabled] Enables the support for operating systems without an EHCI hand-off feature.

[Disabled] Disables the EHCI Hand-off support.

USB Single Port Control

This item allows you to enable or disable the individual USB ports.



Refer to section **1.2.2 Motherboard layout** for the location of the USB ports.

3.6.6 Platform Misc Configuration

The items in this menu allow you to configure the platform-related features.

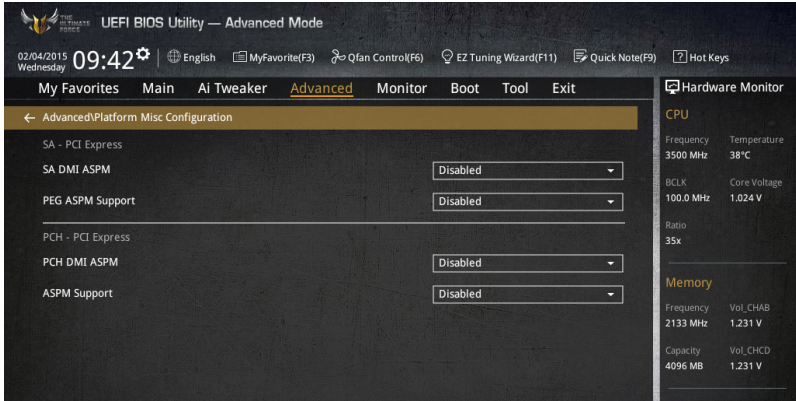

SA - PCI Express

SA DMI ASPM [Disabled]

This item allows you to enable/disable the ASPM (L1) support for the downstream devices.

Configuration options: [Auto] [Disabled] [L1 only]

PEG ASPM Support [Disabled]

This item allows you to enable/disable the ASPM support for the downstream devices.

Configuration options: [Disabled] [L1 only]

PCH - PCI Express

PCH DMI ASPM [Disabled]

This item allows you to enable/disable the PCH DMI ASPM Setting.

Configuration options: [Disabled] [Enabled]

ASPM Support [Disabled]

This item allows you to enable/disable the ASPM support for all downstream devices.

Configuration options: [Disabled] [L1 only]

3.6.7 Onboard Devices Configuration

Scroll down to view the other BIOS items.

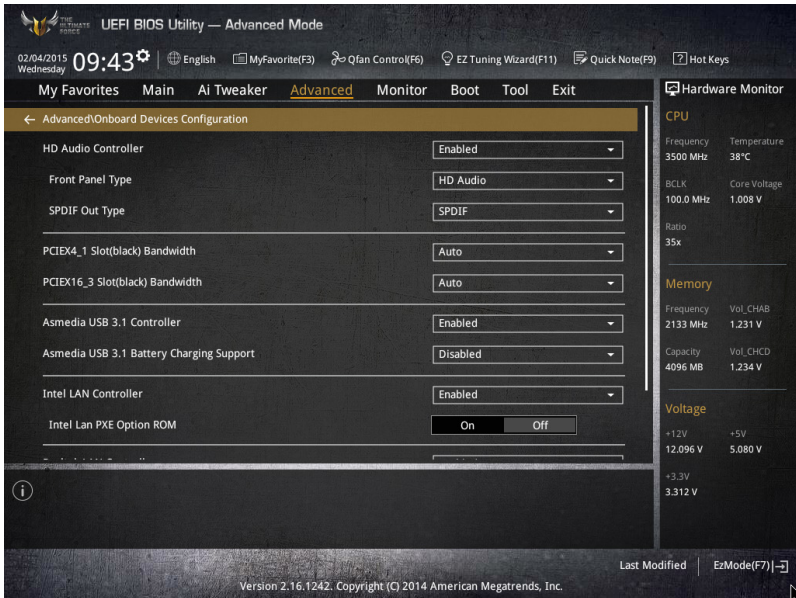

HD Audio Controller [Enabled]

This item allows you to use the Azalia High Definition Audio Controller

Configuration options: [Disabled] [Enabled]



The following items appear only when you set the HD Audio Controller to **[Enabled]**.

Front Panel Type [HD Audio]

This item allows you to set the front panel audio connector (AAFP) mode to legacy AC'97 or high-definition audio depending on the audio standard that the front panel audio module supports.

[HD Audio] Sets the front panel audio connector (AAFP) mode to high definition audio.

[AC97] Sets the front panel audio connector (AAFP) mode to legacy AC'97

SPDIF Out Type [SPDIF]

[SPDIF] Sets to an SPDIF audio output.

[HDMI] Sets to an HDMI audio output.

PCI-EX4_1 Slot (Black) Bandwidth [Audio]

- [Auto] Run at AUTO mode with PCIEEX4_1 enabled and PCIEEX1_1 slot enable.
- [X1 Mode] Run at x1 mode with PCIEEX4_1 enabled and PCIEEX1_1 slot enable.
- [X2 Mode] Run at X2 mode for high performance support with PCIEEX4_1 and PCIEEX1_1 slot disabled.

PCI-EX16_3 Slot (Black) Bandwidth [X4 Mode]

- [Auto] Disable PCIEEX16_3 slot when a M.2 device is detected.
- [X8 Mode] Run at x8 mode for high performance support with M.2 disabled.



Set the PCIEEX16_3 slot bandwidth to X8 mode for a higher performance of the 3-WAY configuration.

Asmedia USB 3.1 Controller [Enabled]

This item allows you to enable/disable the ASMedia® USB 3.1 controller of your system.

Configuration options: [Disabled] [Enabled]



The following item appears only when you set the ASMedia USB 3.1 Controller to [Enabled].

Asmedia USB 3.1 Battery Charging Support [Disabled]

This item allows you to enable/disable the Asmedia® USB 3.1 battery charging support of your system.

Configuration options: [Disabled] [Enabled]

Intel LAN Controller [Enabled]

This item allows you to enable or disable the Intel LAN1/2 controllers.

Configuration options: [Disabled] [Enabled]



The following item appears only when you set the Intel LAN Controller to **[Enabled]**.

Intel Lan PXE Option ROM [Disabled]

This item allows you to enable or disable the PXE Option Rom of the Intel® LAN controller.

Configuration options: [Enabled] [Disabled]

Realtek LAN Controller [Enabled]

This item allows you to enable or disable the Intel LAN1/2 controllers.

Configuration options: [Disabled] [Enabled]



The following item appears only when you set the Intel LAN Controller to **[Enabled]**.

Intel PXE Option ROM [Disabled]

This item allows you to enable or disable the PXE OptionRom of the Intel® LAN controller.

Configuration options: [Enabled] [Disabled]

Serial Port Configuration

This item allows you to set parameters of Serial Port.



This item function only if there is a serial port (COM1) connector on a motherboard.

Serial Port [On] [Off]

This item allows you to enable or disable serial port.

Change Settings

This item allows you to select an optimal setting for Super IO device.

3.6.8 APM Configuration

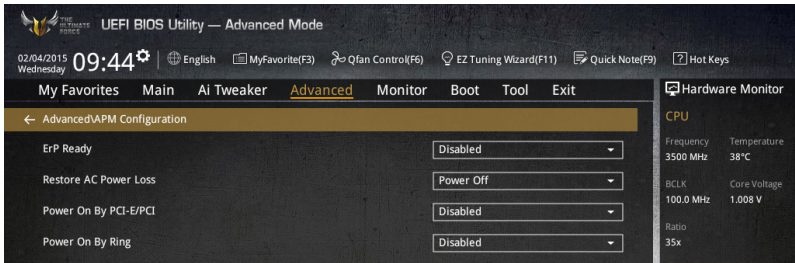

ErP Ready [Disabled]

This item allows you to switch off some power at S4+S5 or S5 to get the system ready for ErP requirement. When set to **[Enabled]**, all other PME options are switched off.

Configuration options: [Disabled] [Enabled (S4+S5)] [Enabled (S5)]

Restore AC Power Loss [Power Off]

This item allows your system to go to ON state, OFF state, or both states after an AC power loss. When setting your system to [Last State], it goes to the previous state before the AC power loss.

Configuration options: [Power Off] [Power On] [Last State]

Power On By PCI-E/PCI [Disabled]

This item allows you to enable/disable the Wake-on-LAN function of the onboard LAN controller or other installed PCI-E LAN cards.

Configuration options: [Disabled] [Enabled]

Power On By RTC [Disabled]

This item allows you to enable/disable the RTC (Real-Time Clock) to generate a wake event and configure the RTC alarm date. When enabled, you can set the days, hours, minutes, or seconds to schedule an RTC alarm date.

Configuration options: [Disabled] [Enabled]

3.6.9 Network Stack Configuration

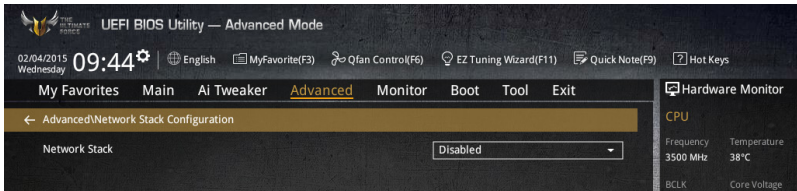

Network stack [Disabled]

This item allows you to disable/enable the UEFI network stack.

Configuration options: [Disabled] [Enabled]



The following item appears only when you set the Network Stack to **[Enabled]**.

Ipv4 PXE Support [Enabled]

This item allows you to enable/disable the Ipv4 PXE Boot Support.

Configuration options: [Disabled] [Enabled]

Ipv6 PXE Support [Enabled]

This item allows you to enable/disable the Ipv6 PXE Boot Support.

Configuration options: [Disabled] [Enabled]

3.6.10 NVMe Configuration

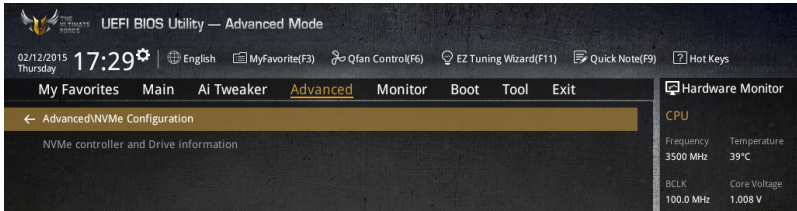

NVMe Configuration

This item allows you to use NVMe controller and Drive information.

3.7 Monitor menu

The Monitor menu displays the system temperature/power status, and allows you to change the fan settings.

Scroll down to display the other BIOS items.

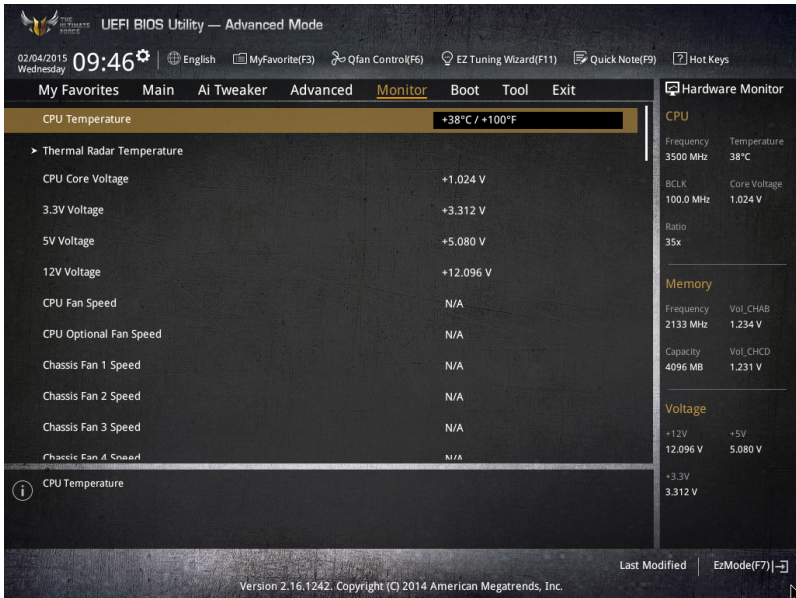

CPU Temperature / Thermal Rader Temperature

The onboard hardware monitor automatically detects and displays the CPU, and Thermal Rader temperatures. Select **[Ignore]** if you do not wish to display the detected temperatures.

CPU Core Voltage, 3.3V Voltage, 5V Voltage, 12V Voltage

The onboard hardware monitor automatically detects the voltage output through the onboard voltage regulators. Select **[Ignore]** if you do not want to detect this item.

CPU Fan Speed [xxxx RPM] or **[Ignore]** / **[N/A]**, CPU Optional Fan Speed [xxxx RPM] or **[Ignore]** / **[N/A]**, Chassis Fan 1/4 Speed [xxxx RPM] or **[Ignore]** / **[N/A]**, ASST Fan 1/5 Speed [xxxx RPM] or **[Ignore]** / **[N/A]**

The onboard hardware monitor automatically detects and displays the CPU, chassis, and assistant fan speed in rotations per minute (RPM). If the fan is not connected to the motherboard, the field shows N/A. Select **[Ignore]** if you do not wish to display the detected speed.

Qfan Tuning

Click this item to automatically detect the lowest speed and configure the minimum duty cycle for each fan.

CPU Q-Fan Control [Auto]

This item allows you to set the CPU Q-Fan operating mode.

- [Auto] Detects the type of CPU fan installed and automatically switches the control modes.
- [PWM Mode] Enables the CPU Q-Fan control feature in PWM mode for 4-pin CPU fan.
- [DC Mode] Enables the CPU Q-Fan control feature in DC mode for 3-pin CPU fan.
- [Disabled] Disables the Q-Fan control.



The following items appear only when you set the CPU Q-Fan Control to **[Auto]**, **[PWM Mode]**, and **[DC Mode]**.

CPU Fan Speed Low Limit [300 RPM]

This item allows you to set the low limit warning for CPU Fan speed.

Configuration options: [Ignore] [200 RPM] [300 RPM] [400 RPM] [500 RPM] [600 RPM]

CPU Fan Profile [Standard]

This item allows you to set the appropriate performance level of the CPU fan.

- [Standard] Set to make the CPU fan adjust automatically depending on the CPU temperature.
- [Silent] Set to minimize the fan speed for quiet CPU fan operation.
- [Turbo] Set to achieve maximum CPU fan speed.
- [Manual] Set to assign the detailed fan speed control parameters.



The following items appear only when you set the CPU Fan Profile to **[Manual]**.

CPU Upper Temperature [70]

Use the <+> or <-> keys to adjust the upper limit of the CPU temperature. The values range from 20°C to 75°C.

CPU Fan Max. Duty Cycle(%) [100]

Use the <+> or <-> keys to adjust the maximum CPU fan duty cycle. The values may differ via Qfan tuning.

CPU Middle Temperature [45]

Use the <+> or <-> keys to set the value for CPU Middle Temperature. The range of the values depends on the CPU installed.

CPU Fan Middle Duty Cycle(%) [60]

Use the <+> or <-> keys to adjust the CPU fan middle duty cycle. The values may differ via Qfan tuning.

CPU Lower Temperature [40]

Use the <+> or <-> keys to adjust the CPU fan's lower temperature. The values range from 20% to 75%.

CPU Fan Min. Duty Cycle(%) [60]

Use the <+> or <-> keys to adjust the minimum CPU fan duty cycle. The values may differ via Qfan tuning.

Chassis Fan 1/4 Q-Fan Control [DC Mode]

These items allow you to set the chassis fans' Q-Fan control feature into DC Mode, PWM Mode, or disable these Q-Fan controls from your motherboard.

Configuration options: [Disabled] [DC Mode] [PWM Mode]



The following items appear only when you set the Chassis Fan 1/4 Q-Fan Control to **[PWM Mode]** or **[DC Mode]**.

Chassis Fan 1/4 Q-Fan Source [CPU]

This item controls the assigned fan according to the selected temperature source.

Configuration options: [CPU] [MB] [VRM] [PCH] [T_SENSOR1] [EXT_SENSOR1] [EXT_SENSOR2] [EXT_SENSOR3]



If you select T_SENSOR1, plug a thermistor cable to T_SENSOR1 header and stick the thermistor cable's head to the desired component as the temperature source.

Chassis Fan 1/4 Speed Low Limit 1/4 [300 RPM]

This item allows you to disable or set the chassis fans' warning speed.

Configuration options: [Ignore] [200 RPM] [300 RPM] [400 RPM] [500 RPM] [600 RPM]

Chassis Fan 1/4 Profile [Standard]

This item allows you to set the appropriate performance level of the chassis fan.

[Standard] Set to make the chassis fan adjust automatically depending on the chassis temperature.

[Silent] Set to minimize the fan speed for quiet chassis fan operation.

[Turbo] Set to achieve maximum chassis fan speeds.

[Manual] Set to assign detailed fan speed control parameters.



The following items appear only when you set the Chassis Fan Profile to **[Manual]**.

Chassis Fan 1/4 Upper Temperature [70]

Use the <+> or <-> keys to adjust the upper limit of the CPU temperature. The values range from 40°C to 90°C.

Chassis Fan 1/4 Max. Duty Cycle(%) [100]

Use the <+> or <-> keys to adjust the maximum chassis fan duty cycle. The values may differ via Qfan tuning.

Chassis Fan 1/4 Middle Temperature [45]

Use the <+> or <-> keys to set the value for Chassis Fan Middle Temperature.

Chassis Fan 1/4 Middle Duty Cycle(%) [60]

Use the <+> or <-> keys to adjust the chassis fan middle duty cycle. The values may differ via Qfan tuning.

Chassis Fan 1/4 Lower Temperature [40]

Use the <+> or <-> keys to adjust the chassis fans' lower temperature. The values may differ via Qfan tuning.

Chassis Fan 1/4 Min. Duty Cycle(%) [60]

Use the <+> or <-> keys to adjust the minimum chassis fan duty cycle. The values may differ via Qfan tuning.

ASST Fan 1/5 Q-Fan Control [DC Mode]

These items allow you to set the extension fans' Q-Fan control feature into DC Mode, PWM Mode, or disable these extension Q-Fan controls from your motherboard.

Configuration options: [Disabled] [DC Mode] [PWM Mode]



The following items appear only when you set the ASST Fan 1/5 Q-Fan Control to **[PWM Mode]** or **[DC Mode]**.

ASST Fan 1/5 Q-Fan Source [CPU]

This item controls the assigned fan according to the selected temperature source.

Configuration options: [CPU] [MB] [VRM] [PCH] [T_SENSOR1] [EXT_SENSOR1] [EXT_SENSOR2] [EXT_SENSOR3]



If you select T_SENSOR1, plug a thermistor cable to T_SENSOR1 header and stick the thermistor cable's head to the desired component as the temperature source.

ASST Fan 1/5 Speed Low Limit [300 RPM]

This item allows you to disable or set the assistant fans' warning speeds.

Configuration options: [Ignore] [200 RPM] [300 RPM] [400 RPM] [500 RPM] [600 RPM]

ASST Fan 1/5 Profile [Standard]

This item allows you to set the appropriate performance level of the assistant fan.

[Standard] Set to make the assistant fan adjust automatically depending on the assistant temperature.

[Silent] Set to minimize the fan speed for quiet assistant fan operation.

[Turbo] Set to achieve maximum assistant fan speed.

[Manual] Set to assign detailed fan speed control parameters.



The following items appear only when you set the ASST Fan Profile to **[Manual]**.

ASST Fan 1/5 Upper Temperature [70]

Use the <+> or <-> keys to adjust the upper limit of the assistant fan 1/5 temperature. The values range from 40°C to 90°C.

ASST Fan 1/5 Max. Duty Cycle(%) [100]

Use the <+> or <-> keys to adjust the maximum assistant fan duty cycle. The values may differ via Qfan tuning.

ASST Fan 1/5 Middle Temperature [45]

Use the <+> or <-> keys to set the value for assistant fan Middle Temperature.

ASST Fan 1/5 Middle Duty Cycle(%) [60]

Use the <+> or <-> keys to adjust the assistant fan middle duty cycle. The values may differ via Qfan tuning.

ASST Fan 1/5 Lower Temperature [40]

Use the <+> or <-> keys to adjust the assistant fans' lower temperature. The values may differ via Qfan tuning.

ASST Fan 1/5 Min. Duty Cycle(%) [60]

Use the <+> or <-> keys to adjust the minimum assistant fan duty cycle. The values may differ via Qfan tuning.

Allow Fan Stop [Disabled]

This item allows your fans to run at 0% duty cycle when the temperature of the source drops below the lower temperature.

Configuration options: [Disabled] [Enabled]

Fan Overtime

Configuration options: [Disabled] [1 minute] [3 minute] [5 minute] [10 minute]

EC FAN Inverse

Configuration options: [Disabled] [15 Seconds] [30 Seconds] [45 Seconds]

Inverse rotate periodically Hour

Configuration options: [Disabled] [1 Hour] [2 Hour] [4 Hour]

Inverse rotate periodically Second

Configuration options: [Disabled] [15 Seconds] [30 Seconds] [45 Seconds]

Anti Surge Support [ON]

This item allows you to on/off the OVP (Over Voltage Protection) and UVP (Under Voltage Protection) functions. This causes the system to automatically shut down when the voltage exceeds the safe range that protects the motherboard's components.

Configuration options: [ON] [OFF]

Chassis Intrude Detect Support [ON]

This item allows you to on/off the chassis intrude detect feature.

Configuration options: [ON] [OFF]

3.8 Boot menu

The Boot menu items allow you to change the system boot options.

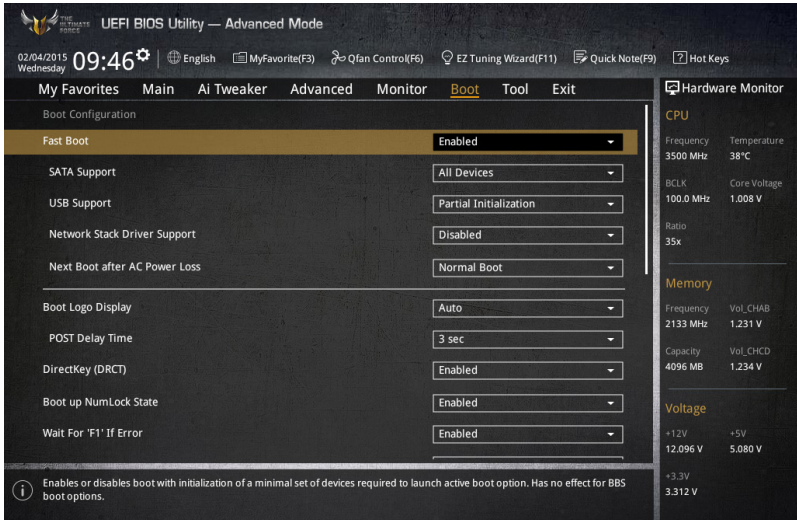

Boot Configuration

Fast Boot [Enabled]

- [Disabled] This item allows your system to go back to its normal boot speed.
- [Enabled] This item allows your system to accelerate the boot speed.



The following items appear only when you set the Fast Boot to **[Enabled]**.

SATA Support [All Devices]

- [All Devices] All devices connected to SATA ports are available during POST. This process extends the POST time.
- [Hard Drive Only] Only hard drives connected to SATA ports are detected during POST.
- [Boot Drive Only] Only boot drives connected to a SATA ports are detected during POST.

USB Support [Partial Initialization]

- [Disabled] All USB devices will not be available until OS boot up for a fastest POST time.
- [Full Initialization] All USB devices will be available during POST. This process will extend the POST time.
- [Partial Initialization] For a faster POST time, only USB ports with keyboard and mouse connections will be detected.

Network Stack Driver Support [Disabled]

- [Disabled] Select to skip the network stack driver from loading during POST.
- [Enabled] Select to load the network stack driver during POST.

Next Boot after AC Power Loss [Normal Boot]

- [Normal Boot] Returns to normal boot on the next boot after an AC power loss.
- [Fast Boot] Accelerates the boot speed on the next boot after an AC power loss.

DirectKey (DRCT) [Enabled]

- [Disabled] Disables the DirectKey button. The system will only power on or off when you press the DirectKey button.
- [Enabled] Allows the system to power on and go to the BIOS Setup directly when you press the Reset button. Connect the 2-pin connector of the chassis reset button cable to the onboard DRCT header.

Boot Logo Display [Auto]

- [Auto] Sets the boot logo to display during POST.
- [Full Screen] Sets the boot logo display in full screen during POST.
- [Disabled] Disables the boot logo display during POST.



The following item appears only when you set the Boot Logo Display to **[Auto]** and **[Full Screen]**.

Post Delay Time [3 sec]

This item allows you to select a desired additional POST waiting time to easily enter the BIOS Setup. You can only execute the POST delay time during normal boot. The values range from 0 to 10 seconds.



This feature only works when set under normal boot.



The following items appear only when you set the Boot Logo Display to **[Disabled]**.

Post Report [5 sec]

This item allows you to select a desired POST report waiting time.
Configuration options: [1 sec] - [10 sec] [Until Press ESC]

Bootup NumLock State [Enabled]

This item allows you to enable or disable power-on state of the NumLock.
Configuration options: [Disabled] [Enabled]

Wait For 'F1' If Error [Enabled]

This item allows your system to wait for the <F1> key to be pressed when error occurs.
Configuration options: [Disabled] [Enabled]

Option ROM Messages [Enabled]

- [Enabled] The third-party ROM messages will be displayed during POST.
- [Disabled] Disables the ROM messages and displays only the ASUS logo during POST.

Interrupt 19 Capture [Disabled]

This item allows you to trap Interrupt 19 by the option ROMs.

Configuration options: [Disabled] [Enabled]

Above 4G Decoding [Disabled]

This item allows you to decode the 64-bit capable devices above 4G address space. Ensure that your system supports 64-bit PCI decoding.

Configuration options: [Disabled] [Enabled]

Setup Mode [EZ Mode]

[Advanced Mode] This item allows you to go to Advanced Mode of the BIOS after POST.

[EZ Mode] This item allows you to go to EZ Mode of the BIOS after POST.

CSM (Compatibility Support Module)

This item allows you to configure the CSM (Compatibility Support Module) items to fully support the various VGA, bootable devices and add-on devices for better compatibility.

Launch CSM [Enabled]

- [Auto] The system automatically detects the bootable devices and the add-on devices.
- [Enabled] For better compatibility, enable the CSM to fully support the non-UEFI driver add-on devices or the Windows® UEFI mode.
- [Disabled] Disables the CSM to fully support the non-UEFI driver add-on devices or the Windows® UEFI mode.



The following items appear only when you set the Launch CSM to **[Enabled]**.

Boot Devices Control [UEFI and Legacy OpROM]

This item allows you to select the type of devices that you want to boot.

Configuration options: [UEFI and Legacy OpROM] [Legacy OpROM only] [UEFI only]

Boot from Network Devices [Legacy OpROM first]

This item allows you to select the type of network devices that you want to launch.

Configuration options: [Legacy OpROM first] [UEFI driver first] [Ignore]

Boot from Storage Devices [Legacy OpROM first]

This item allows you to select the type of storage devices that you want to launch.

Configuration options: [Both, Legacy OpROM first] [Both, UEFI first]
[Legacy OpROM first] [UEFI driver first] [Ignore]

Boot from PCI-E/PCI Expansion Devices [Legacy OpROM first]

This item allows you to select the type of PCIe/PCI expansion devices that you want to launch.

Configuration options: [Legacy OpROM first] [UEFI driver first]

Secure Boot

This item allows you to configure the Windows® Secure Boot settings and manage its keys to protect the system from unauthorized access and malwares during POST.

OS Type [Windows UEFI Mode]

- | | |
|---------------------|--|
| [Windows UEFI Mode] | This item allows you to select your installed operating system. Execute the Microsoft® Secure Boot check. Only select this option when booting on Windows® UEFI mode or other Microsoft® Secure Boot compliant OS. |
| [Other OS] | Get the optimized function when booting on Windows® non-UEFI mode. Microsoft® Secure Boot only supports Windows® UEFI mode. |



The following item appears only when you set the OS Type to **[Windows UEFI mode]**.

Key Management

This allows you to manage the Secure Boot keys.

Install Default Secure Boot keys

This item allows you to immediately load the default Security Boot keys, Platform key (PK), Key-exchange Key (KEK), Signature database (db), and Revoked Signatures (dbx). When the default Secure boot keys are loaded, the PK state will change from Unloaded mode to loaded mode.

Clear Secure Boot keys

This item appears only when you load the default Secure Boot keys. This item allows you to clear all default Secure Boot keys.

Save Secure Boot Keys

This item allows you to save the PK (Platform Keys) to a USB storage device.

PK Management

The Platform Key (PK) locks and secures the firmware from any permissible changes. The system verifies the PK before your system enters the OS.

Delete PK

This item allows you to delete the PK from your system. Once the PK is deleted, all the system's Secure Boot keys will not be active.

Configuration options: [Yes] [No]

Load Default PK

This item allows you to load the downloaded PK from a USB storage device.



The PK file must be formatted as a UEFI variable structure with time-based authenticated variable.

KEK Management

The KEK (Key-exchange Key or Key Enrollment Key) manages the Signature database (db) and Revoked Signature database (dbx).



Key-exchange Key (KEK) refers to Microsoft® Secure Boot Key-Enrollment Key (KEK).

Delete KEK

This item allows you to delete the KEK from your system.

Configuration options: [Yes] [No]

Load Default KEK

This item allows you to load the downloaded KEK from a USB storage device.

Append Default KEK

This item allows you to load the additional KEK from a storage device for an additional db and dbx loaded management.



The KEK file must be formatted as a UEFI variable structure with time-based authenticated variable.

DB Management

The db (Authorized Signature database) lists the signers or images of UEFI applications, operating system loaders, and UEFI drivers that you can load on the single computer.

Delete db

This item allows you to delete the db file from your system.

Configuration options: [Yes] [No]

Load Default db

This item allows you to load the downloaded db from a USB storage device.

Append Default db

This item allows you to load the additional db from a storage device so that more images can be loaded securely.



The db file must be formatted as a UEFI variable structure with time-based authenticated variable.

DBX Management

The dbx (Revoked Signature database) lists the forbidden images of db items that are no longer trusted and cannot be loaded.

Delete dbx

This item allows you to delete the dbx file from your system.

Load Default dbx

This item allows you to load the downloaded dbx from a USB storage device.

Configuration options: [Yes] [No]

Append Default

This item allows you to load the additional dbx from a storage device so that more db's images cannot be loaded.



The dbx file must be formatted as a UEFI variable structure with time-based authenticated variable.

Boot Option Priorities

These items specify the boot device priority sequence from the available devices. The number of device items that appears on the screen depends on the number of devices installed in the system.



- To access Windows® OS in Safe Mode, press <F8 > after POST (Windows® 8 not supported).
 - To select the boot device during system startup, press <F8> when ASUS Logo appears.
-

Boot Override

These item displays the available devices. The number of device items that appear on the screen depends on the number of devices installed in the system. Click an item to start booting from the selected device.

3.9 Tool menu

The Tool menu items allow you to configure options for special functions. Select an item then press <Enter> to display the submenu.



GPU Post

This item shows the installed graphics cards in your motherboard. It also shows the recommended number of graphics cards to install in your motherboard for best performance.

3.9.1 ASUS EZ Flash 2 Utility

This item allows you to run ASUS EZ Flash 2. When you press <Enter>, a confirmation message appears. Use the left/right arrow key to select between [Yes] or [No], then press <Enter> to confirm your choice.



For more details, refer to section [3.11.2 ASUS EZ Flash 2](#).

3.9.2 ASUS O.C. Profile

This item allows you to store or load multiple BIOS settings.

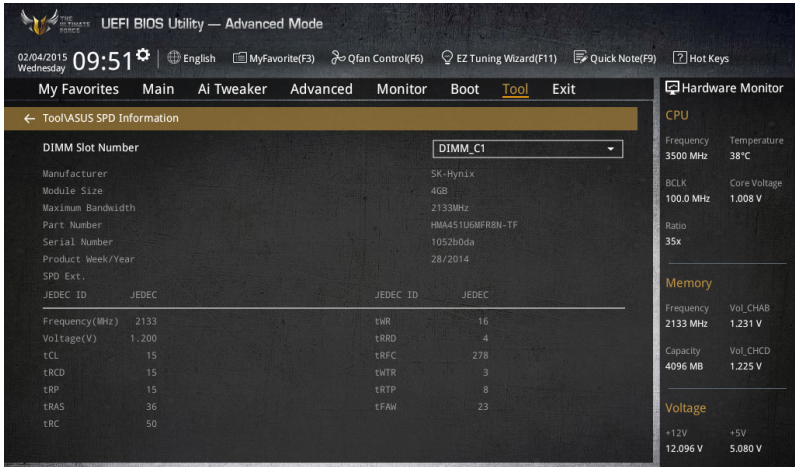

Load from Profile

This item allows you to load the previous BIOS settings saved in the BIOS Flash. Key in the profile number that saved your BIOS settings, press <Enter>, and then select **Yes**.



- DO NOT shut down or reset the system while updating the BIOS to prevent the system boot failure!
- We recommend that you update the BIOS file only coming from the same memory/CPU configuration and BIOS version.

Profile Name

This item allows you to key in a profile name.

Save to Profile

This item allows you to save the current BIOS settings to the BIOS Flash, and create a profile. Key in a profile number from one to eight, press <Enter>, and then select **Yes**.

Load/Save Profile from/to USB Drive

This item allows you to load or save profile from your USB drive, load and save profile to your USB drive.

3.9.3 ASUS DRAM SPD Information

This item allows you to view the DRAM SPD information.



3.10 Exit menu

The Exit menu items allow you to load the optimal default values for the BIOS items, and save or discard your changes to the BIOS items. You can access the EZ Mode from the Exit menu.

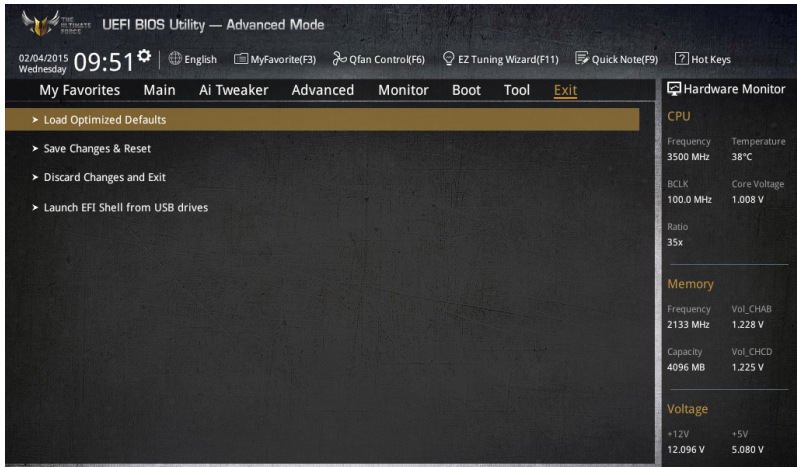

Load Optimized Defaults

This option allows you to load the default values for each of the parameters on the Setup menus. When you select this option or if you press <F5>, a confirmation window appears. Select **OK** to load the default values.

Save Changes & Reset

Once you are finished making your selections, choose this option from the Exit menu to ensure the values you selected are saved. When you select this option or if you press <F10>, a confirmation window appears. Select **OK** to save changes and exit.

Discard Changes & Exit

This option allows you to exit the Setup program without saving your changes. When you select this option or if you press <Esc>, a confirmation window appears. Select **Yes** to discard changes and exit.

Launch EFI Shell from USB drives

This option allows you to attempt to launch the EFI Shell application (shellx64.efi) from one of the available filesystem devices.

3.11 Updating BIOS

The ASUS website publishes the latest BIOS versions to provide enhancements on system stability, compatibility, and performance. However, BIOS updating is potentially risky. If there is no problem using the current version of BIOS, DO NOT manually update the BIOS. Inappropriate BIOS updating may result to system's failure to boot. Carefully follow the instructions in this chapter to update your BIOS when necessary.



Visit <http://www.asus.com> to download the latest BIOS file for this motherboard.

The following utilities allow you to manage and update the motherboard BIOS setup program.

1. EZ Update: Updates the BIOS in Windows® environment.
2. ASUS EZ Flash 2: Updates the BIOS using a USB flash drive.
3. ASUS CrashFree BIOS 3: Restores the BIOS using the motherboard support DVD or a USB flash drive when the BIOS file fails or gets corrupted.
4. ASUS BIOS Updater: Updates the BIOS in DOS environment using the motherboard support DVD and a USB flash disk drive.

3.11.1 EZ Update

The EZ Update is a utility that allows you to update the motherboard BIOS in Windows® environment.



- EZ Update requires an Internet connection either through a network or an ISP (Internet Service Provider).
 - This utility is available in the support DVD that comes with the motherboard package.
 - Refer to section **4.4.3 EZ Update** of this user guide for more information.
-

3.11.2 ASUS EZ Flash 2

ASUS EZ Flash 2 allows you to update the BIOS without having to use a bootable floppy disk or an OS-based utility.



Before you start using this utility, download the latest BIOS from the ASUS website at www.asus.com.

To update the BIOS using EZ Flash 2:

1. Insert the USB flash disk that contains the latest BIOS file to the USB port.
2. Enter the Advanced Mode of the BIOS setup program. Go to the Tool menu to select ASUS EZ Flash Utility and press <Enter> to enable it.

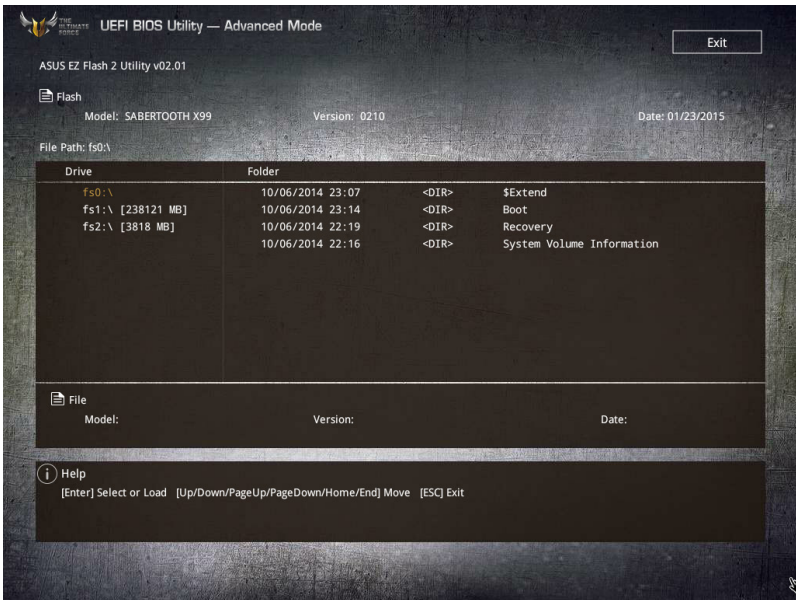

3. Press <Tab> to switch to the Drive field.
4. Press the Up/Down arrow keys to find the USB flash disk that contains the latest BIOS, and then press <Enter>.
5. Press <Tab> to switch to the Folder Info field.
6. Press the Up/Down arrow keys to find the BIOS file, and then press <Enter> to perform the BIOS update process. Reboot the system when the update process is done.



-
- This function can support devices such as a USB flash disk with FAT 32/16 format and single partition only.
 - DO NOT shut down or reset the system while updating the BIOS to prevent system boot failure!
-



Ensure to load the BIOS default settings to ensure system compatibility and stability. Select the Load Optimized Defaults item under the Exit menu. See section **3.10 Exit Menu** for details.

3.11.3 ASUS CrashFree BIOS 3

The ASUS CrashFree BIOS 3 utility is an auto recovery tool that allows you to restore the BIOS file when it fails or gets corrupted during the updating process. You can restore a corrupted BIOS file using the motherboard support DVD or a USB flash drive that contains the BIOS file.



The BIOS file in the motherboard support DVD may be older than the BIOS file published on the ASUS official website. If you want to use the newer BIOS file, download the file at <http://support.asus.com> and save it to a USB flash drive.

Recovering the BIOS

To recover the BIOS:

1. Turn on the system.
2. Insert the motherboard support DVD to the optical drive, or the USB flash drive containing the BIOS file to the USB port.
3. The utility automatically checks the devices for the BIOS file. When found, the utility reads the BIOS file and enters ASUS EZ Flash 2 automatically.
4. The system requires you to enter BIOS Setup to recover the BIOS setting. To ensure system compatibility and stability, we recommend that you press <F5> to load default BIOS values.



DO NOT shut down or reset the system while updating the BIOS! Doing so can cause system boot failure!

3.11.4 ASUS BIOS Updater

ASUS BIOS Updater allows you to update the BIOS in DOS environment.



The screen captures used in this section are for reference only and may not be exactly the same as actually shown on your computer screen.

Before updating BIOS

- Prepare the motherboard support DVD and a USB flash drive.
- Download the latest BIOS file and BIOS Updater from <http://support.asus.com> and save them in your USB flash drive.



NTFS is not supported under DOS environment. Ensure that your USB flash drive is in single partition and in FAT32/16 format.

- Turn off the computer.
- Ensure that your computer has a DVD optical drive.

Booting the system in DOS environment

To boot the system in DOS:

1. Insert the USB flash drive with the latest BIOS file and BIOS Updater to the USB port.
2. Boot your computer then press <F8> to launch the select boot device screen.
3. When the select boot device screen appears, insert the Support DVD into the optical drive then select the optical drive as the boot device.

```
Please select boot device:
-----
E1:  ASUS DVD-E818A6T  (4069MB)
     USB DISK 2.0  (3824MB)
UEFI: (FAT)  USB DISK 2.0  (3824MB)
Enter Setup
-----

  ↑ and ↓ to move selection
  ENTER to select boot device
  ESC to boot using defaults
```

- When the booting message appears, press <Enter> within five (5) seconds to enter FreeDOS prompt.

```
ISOLINUX 3.20 2006-08-26 Copyright (C) 1994-2005 H. Peter Anvin
A Bootable DVD/CD is detected. Press ENTER to boot from the DVD/CD.
If no key is pressed within 5 seconds, the system will boot next priority
device automatically. boot:
```

- On the FreeDOS prompt, type **d:** then press <Enter> to switch the disk from Drive C (optical drive) to Drive D (USB flash drive).

```
Welcome to FreeDOS (http://www.freedos.org)!
C:> d:
D:>
```

Updating the BIOS file

To update the BIOS file:

- On the FreeDOS prompt, type **bupdater /pc /g** and press <Enter>.

```
D:> bupdater /pc /g
```

- On the BIOS Updater screen, press <Tab> to switch from Files panel to Drives panel then select **D:**.

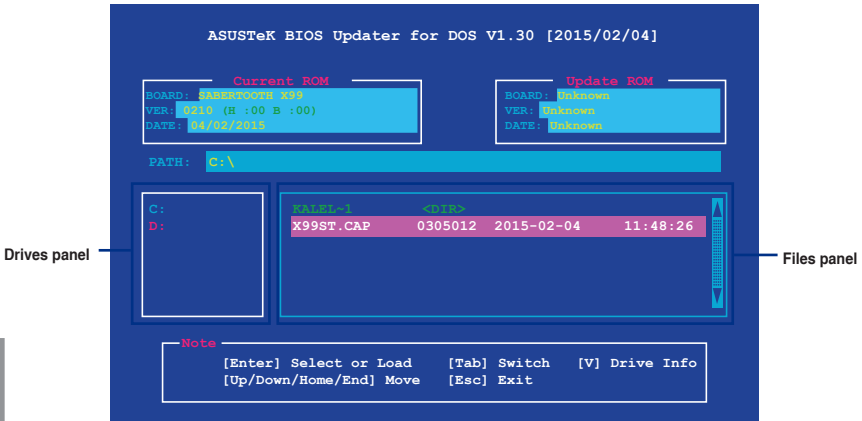

- Press <Tab> to switch from Drives panel to Files panel then press <Up/Down or Home/End> keys to select the BIOS file and press <Enter>.

4. After the BIOS Updater checks the selected BIOS file, select **Yes** to confirm the BIOS update.



The BIOS Backup feature is not supported due to security regulations.

5. Select **Yes** then press <Enter>. When BIOS update is done, press <ESC> to exit BIOS Updater.
6. Restart your computer.



DO NOT shut down or reset the system while updating the BIOS to prevent system boot failure.



Ensure to load the BIOS default settings to ensure system compatibility and stability. Select **Load Optimized Defaults** item under the **Exit BIOS** menu. See section **3.10 Exit menu** for details.

Software support

4

4.1 Installing an operating system



- This motherboard supports 32-bit/64-bit Windows® 7, 32-bit/64-bit Windows® 8, and 32-bit/64-bit Windows® 8.1 operating systems (OS).
- Motherboard settings and hardware options vary. The setup procedures presented in this chapter are for reference only. Refer to Windows® operating system documentation for detailed information.

4.2 Support DVD information



The contents of the support DVD are subject to change at any time without notice. Visit the ASUS website at www.asus.com for updates.

4.2.1 Running the support DVD



Ensure that you have an Administrator account before running the support DVD in Windows® 7, Windows® 8, or Windows® 8.1 operating systems.

To run the support DVD:

1. Place the Support DVD into the optical drive.
2. In the **AutoPlay** dialog box, click or tap **Run ASSETUP.EXE**.

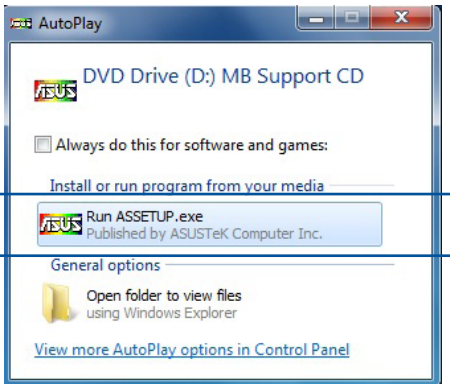

If the **AutoPlay** dialog box does not appear, browse the contents of the support DVD and double-click or tap `\\bin\ASSETUP.EXE` to launch the **ASUS motherboard support DVD** main menu.

Support DVD main menu

The Drivers menu shows the available device drivers if the system detects installed devices. Install the necessary drivers to use the devices.

The AHCI/RAID Driver menu contains the RAID/AHCI driver disk.

The Manual menu contains the list of supplementary user guides. Click or tap an item to open the folder of the user guide.

The Utilities menu shows the applications and other software that the motherboard supports.

Click or tap an item to install

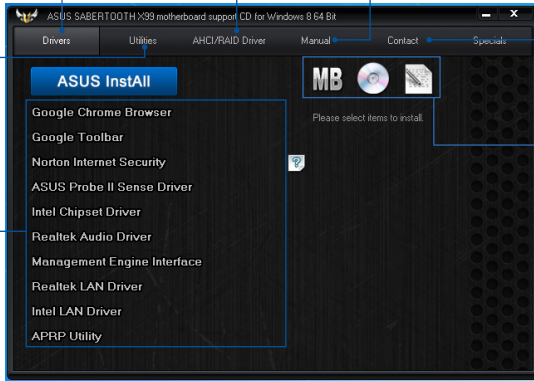

Click or tap to display the ASUS contact information.

Click or tap an icon to display DVD/motherboard information

4.2.2 Obtaining the software manuals

The software manuals are included in the support DVD. Follow the instructions below to get the necessary software manuals.



The software manual files are in Portable Document Format (PDF). Install the Adobe® Acrobat® Reader from the **Utilities** tab before opening the files.

To read about your motherboard's utility guide:

1. Click or tap **Manual** tab > **ASUS Motherboard Utility Guide**.

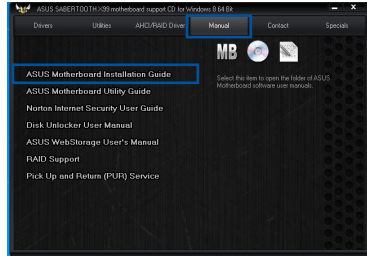

2. From the **Manual** folder, open the folder of the software manual that you wish to read.

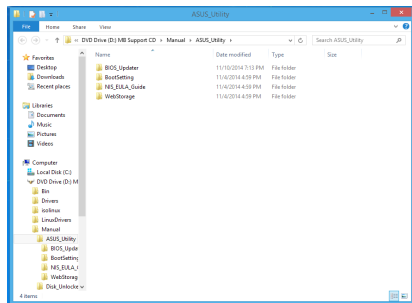

3. Some software manuals are provided in different languages. Open the language's folder to view the software manual.

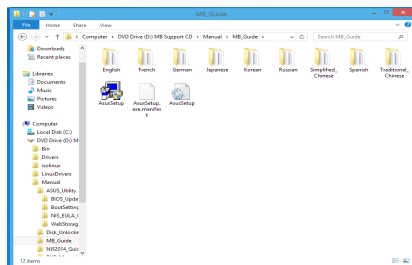

The screenshots in this section are for reference only. The actual software manuals containing in the support DVD vary by models.

4.3 Software information

Most of the applications in the support DVD have wizards that will conveniently guide you through the installation. View the online help or readme file that came with the software application for more information.

4.4 AI Suite 3

AI Suite 3 is an all-in-one interface that integrates several ASUS utilities and allows you to launch and operate these utilities simultaneously.

Installing AI Suite 3



Ensure that you have an Administrator account before installing AI Suite 3 in Windows® 7, Windows® 8, or Windows® 8.1 operating systems.

To install AI Suite 3 on your computer:

Windows® 7 OS

1. Place the Support DVD into the optical drive.
2. In the **AutoPlay** dialog box, click or tap **Run ASSETUP.exe** then select the **Utilities** tab.

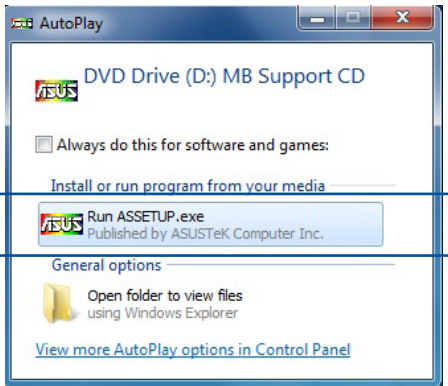

3. From the **Utilities** tab, click or tap **AI Suite 3** then follow the succeeding onscreen instructions.

Windows® 8 and Windows® 8.1 OS

1. Place the Support DVD into the optical drive then follow onscreen instructions.
2. From the **ASUS motherboard support DVD** main menu, select the Utilities tab and click or tap **AI Suite 3**.
3. Follow the succeeding onscreen instructions.

If the **ASUS motherboard support DVD** main menu did not appear, try the following:

- a. Go to the **Start Screen** then click or tap the **Desktop** app.
- b. On the lower left corner of the Desktop, click or tap **File Explorer**  then select your DVD drive and tap or double-click or tap the **Setup** application.

Launching AI Suite 3

Windows® 7 OS

From the Desktop, click or tap **Start > All Programs > ASUS > AI Suite 3 > AI Suite 3**.

You can also launch AI Suite in Windows® 7 by clicking or tapping  on the Notification area.

Windows® 8 and Windows® 8.1 OS

To launch AI Suite 3 in Windows® 8 or Windows® 8.1, tap the AI Suite 3 app on the Start Screen (or if you're using a mouse, click or tap the AI Suite 3 app on the Start Screen).

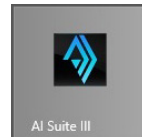

AI Suite 3 Main menu

The AI Suite 3 main menu gives you easy-access controls and insight to what's going on with your computer - allowing you to optimize performance settings while at the same time ensuring system stability.

The AI Suite main menu includes a quick-access menu bar that allows you to swiftly launch any of the integrated ASUS utilities. Click or tap  on the top-right corner of the menu to launch the menu bar.

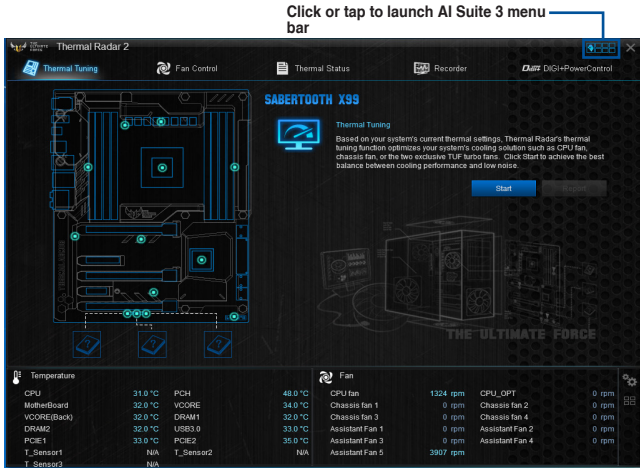

The AI Suite 3 screenshots in this section are for reference only and can vary depending on motherboard model.

AI Suite 3 main menu bar

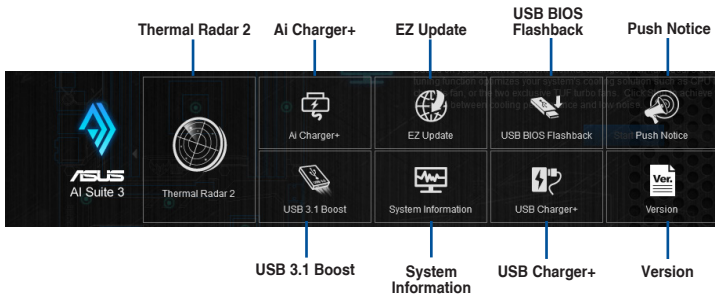

- Some functions in the AI Suite 3 main menu in this user guide may vary depending on the motherboard model.
- Refer to the software manual in the support DVD or visit the ASUS website at www.asus.com for detailed software configuration.

Thermal Radar 2

Thermal Radar 2 lets you control fans, monitor your graphics card temperature and other key components in real time, or auto-tune your thermal settings.

Thermal Tuning

This function optimizes your system's cooling solution based on your system's current thermal settings. It allows you to configure your CPU, chassis, and the exclusive TUF Turbo fan to achieve the best balance between cooling performance and low noise.

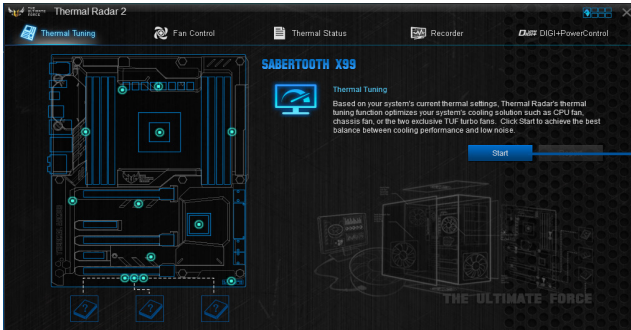

Click or tap to automatically start the Thermal Tuning process

Thermal Status

Displays the current status of the thermal condition of your system.

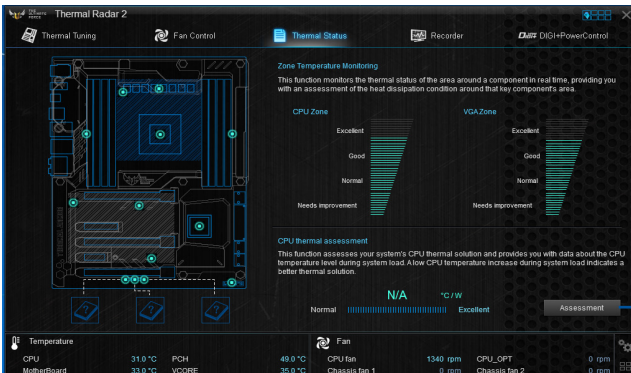

Click or tap to run the assessment report of your current thermal settings.

Recorder

Displays and monitors the status of the thermal setting and condition of your system.

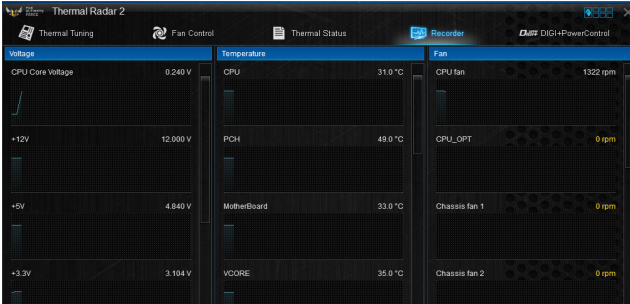

Click or tap to scroll down/up

Fan Control

Allows you to configure the settings of the fans installed on your system. You can also load or save a fan's profile to tune the thermal condition of your system.

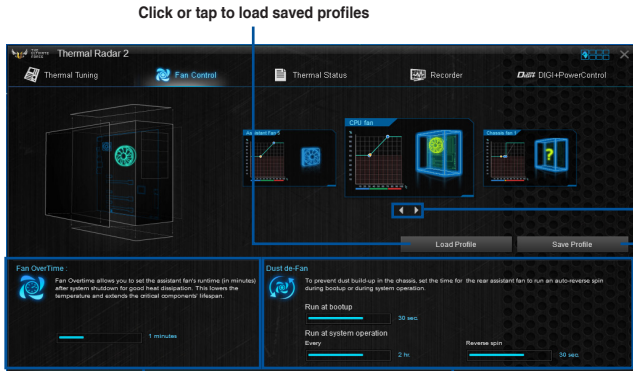

Click or tap to load saved profiles

Click or tap to switch between items

Click or tap to save the settings of the new profile

Fan Overtime settings

Dust de-Fan settings

DIGI+ Power Control

ASUS DIGI+ Power Control features the revolutionary and innovative digital VRM and DRAM Voltage controllers. These controllers offers ultra-precise memory and voltage tuning for optimal system efficiency, stability and performance.



Click or tap to go the CPU configurations screen

Click or tap to go the DRAM configurations screen

DIGI+PowerControl - CPU

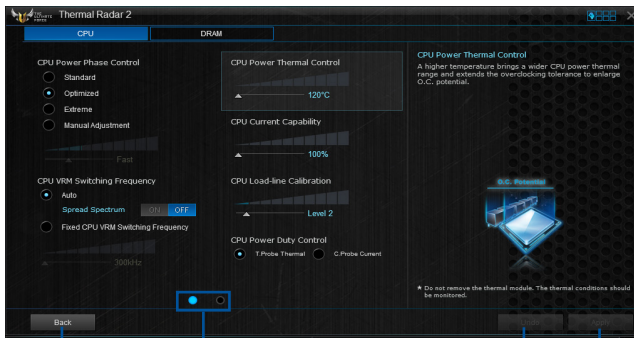

Click or tap to go back to the previous screen

Click or tap to switch between items

Click or tap to undo the changes

Click or tap to apply the changes

DIGI+PowerControl - DRAM

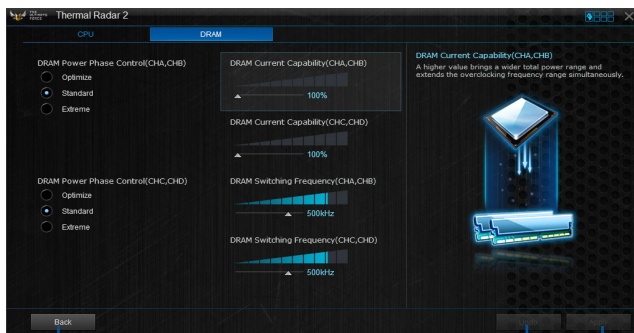

Click or tap to go back to the previous screen

Click or tap to undo the changes

Click or tap to apply the changes

4.4.1 Ai Charger+

Ai Charger+ allows you to fast-charge your portable BC 1.1* mobile devices on your computer's USB port three times faster than the standard USB devices**.

Launching Ai Charger+

To launch Ai Charger+, click or tap  on the top-right corner of the AI Suite 3 main menu, then select **Ai Charger+**.



Ai Charger+ is available only in selected motherboard models.

Ai Charger+ screen

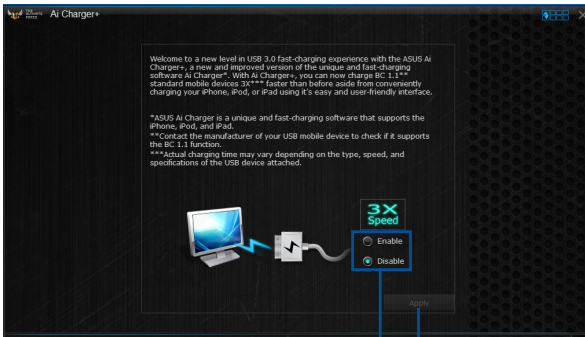

Tick to enable or
disable Ai Charger+

Click or tap to apply
the selection



- * Check the manufacturer if your USB device is a Battery Charging Specification 1.1 (BC 1.1) compliant or compatible device.
- ** Actual charging speeds may vary depending on the charging rate and specifications of your USB device.
- To ensure normal charging function, disconnect and reconnect your USB device every time you enable or disable Ai Charger+.
- Ai Charger+ does not support USB hubs, USB extension cables, and generic USB cables.

4.4.2 EZ Update

EZ Update is a utility that allows you to automatically update your motherboard's software, drivers and BIOS easily.

With this utility, you can also manually update the BIOS and select the boot logo that displays during POST.

Launching EZ Update

To launch EZ Update, click or tap  on the top-right corner of the AI Suite 3 main menu, then select **EZ Update**.

Using EZ Update

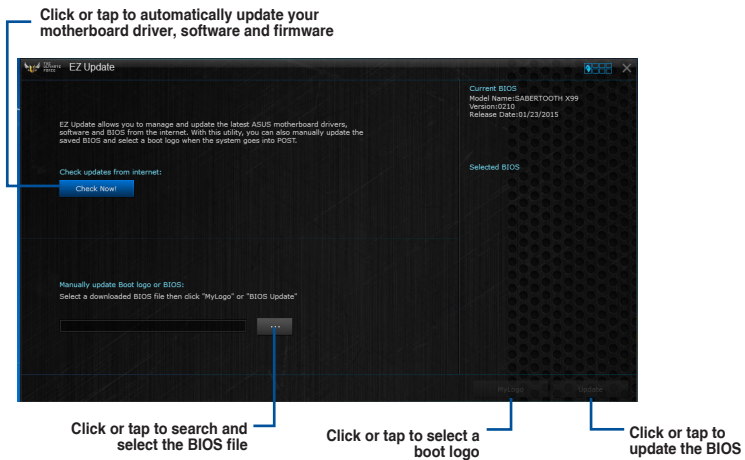

Manually update the BIOS and selecting a boot logo

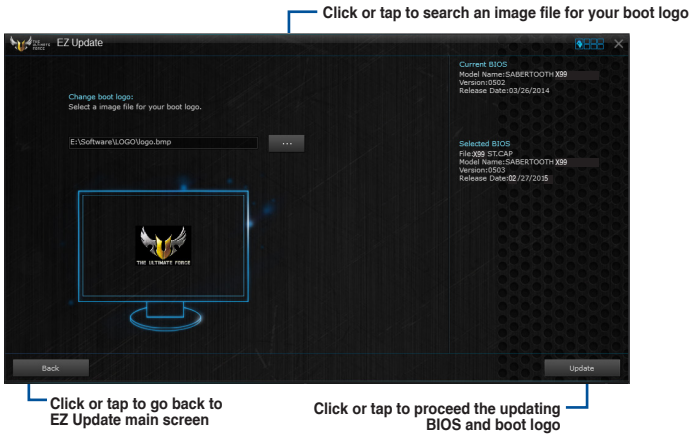

After you click or tap **BIOS Update** button, click or tap **Flash** to update the BIOS and upload the boot logo in your system.

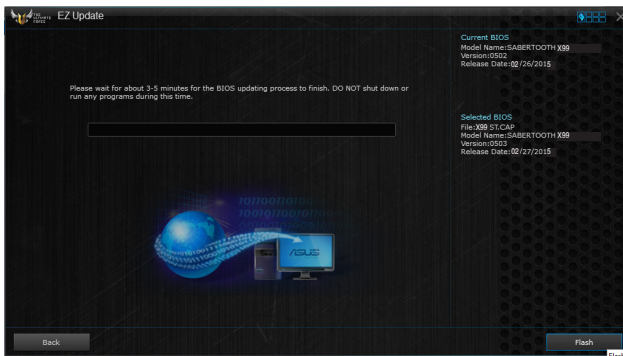

4.4.3 USB BIOS Flashback

USB BIOS Flashback allows you to check and save the latest BIOS version to a USB storage device. Use this utility to quickly check for the latest available BIOS and set the BIOS download schedule.

Launching USB BIOS Flashback

To launch USB BIOS Flashback, click or tap  on the top-right corner of the AI Suite 3 main menu, then select **USB BIOS Flashback**.



USB BIOS Flashback is available only in selected motherboard models.

Using USB BIOS Flashback

Set a schedule for the BIOS Update download

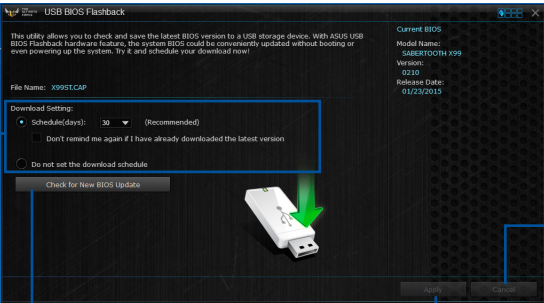

Click or tap to check for a new BIOS update available for download

Click or tap to cancel the download schedule setting

Click or tap to apply the download schedule setting

Scheduling the BIOS download

1. In the Download Setting field, tick **Schedule (days)** then select the number of days for the BIOS download schedule.
2. Click or tap **Apply** to save the BIOS download schedule. Click or tap **Cancel** to cancel the download schedule.

Downloading the latest BIOS





Before you start downloading, ensure that you have installed the USB storage device to your computer's USB port that supports USB BIOS Flashback. Refer to section **2.3.1 Rear I/O connection** of this user guide for more details.

To download the updated BIOS:

1. From the USB BIOS Flashback screen, click or tap **Check for New BIOS Update**.

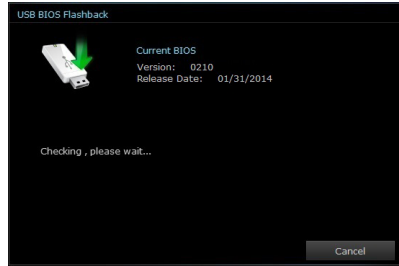
Wait for the system to check the latest BIOS version.



2. After the utility detects a new BIOS, click or tap  from the Save to: field, select the USB flash drive, then click or tap **Download**.

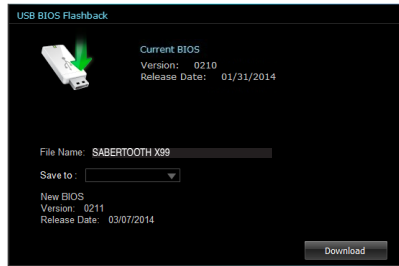

3. After the download is complete, click or tap **OK**.

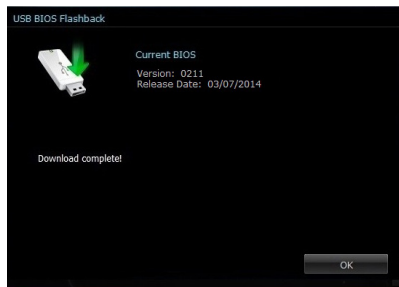

4.4.4 Push Notice

This utility allows you get the detailed status of your system to your smart device. You can also send messages to your smart device using this utility.



Before using this utility, ensure that you pair your computer with your smart device. For pairing information, refer to section **Pairing your computer and smart device**.

Launching Push Notice on your computer

To launch Push Notice, click or tap  on the top-right corner of the AI Suite 3 main menu, then select **Push Notice**.

Push Notice screen

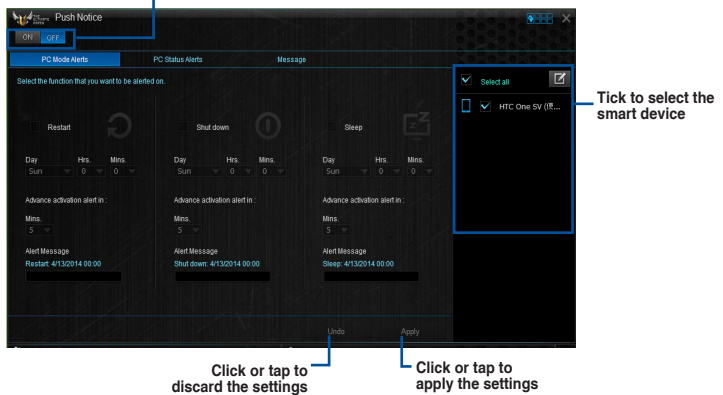

Click or tap to enable or disable Push Notice



Click or tap to discard the settings

Click or tap to apply the settings



You can also enable the Push Notice via the Push Notice shortcut on the lower-right corner of your screen. To do this, click or tap << then click or tap  then select .

Pairing your computer and smart device

To pair your computer and smart device:

1. On your smart device, tap  to launch Push Notice.
2. Tap **Push Scan** then tap the name of your computer that you want to pair with.



To pair your computer and smart device, ensure that both are connected to the same wireless network.

Setting up PC Mode alerts of your computer

This feature allows you to restart, shut down, or put your computer to sleep mode and sends an alert to your smart device.

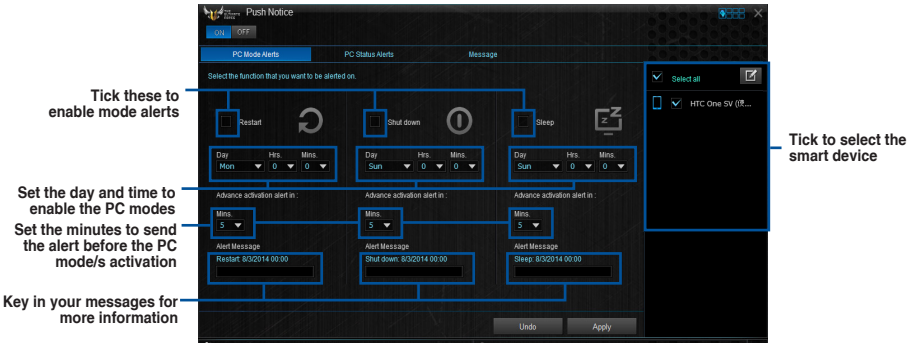

Setting up PC Status alerts

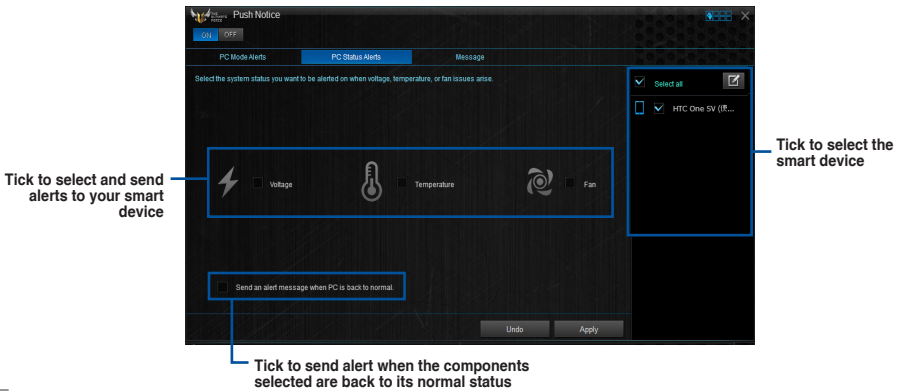

This feature allows you to send alerts of the unusual activities of the voltage, temperature, and fan settings of your computer to your smart device.



Sending messages to your smart device

This feature allows you to send messages to your smart device.



You can also send messages via the Push Notice messaging shortcut on the lower-right corner of your screen. To do this, click or tap << then click or tap  then select .



Viewing your computer status on your smart device

Tap  on your smart device to launch Push Notice.

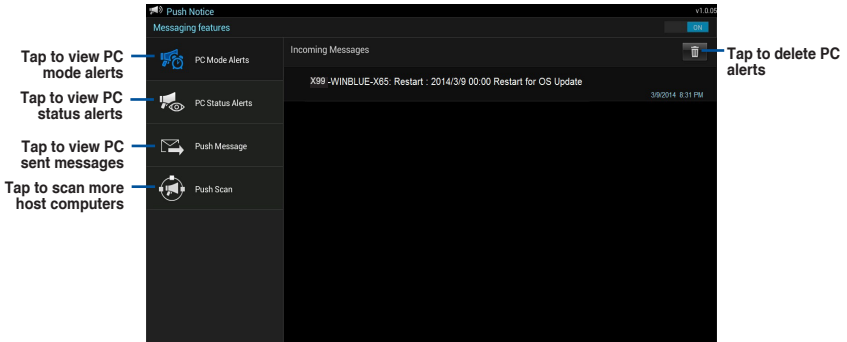

4.4.5 USB 3.1 Boost

USB 3.1 Boost technology supports UASP (USB Attached SCSI Protocol) that automatically speeds up the transfer rates of your USB storage devices.

Launching USB 3.1 Boost

To launch USB 3.1 Boost, click or tap  on the top-right corner of the AI Suite 3 main menu, then select **USB 3.1 Boost**.

Using the USB 3.1 Boost

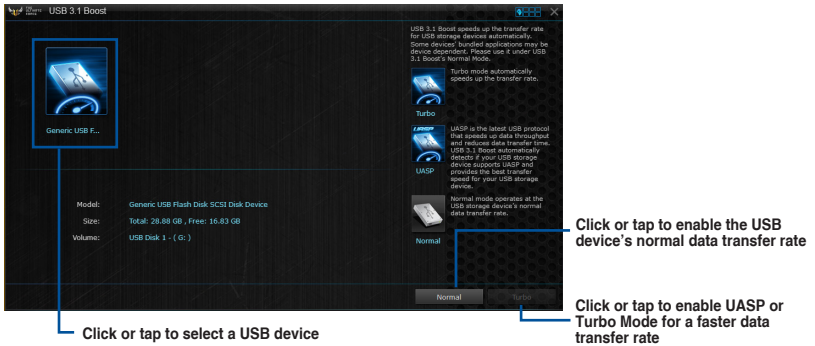

Ensure to connect your USB 3.1/3.0 device to the USB 3.1/3.0 ports that support USB 3.1 Boost. Refer to section 2.3.1 **Rear I/O connection** of your user guide for more details.



- USB 3.1 Boost automatically detects the USB 3.1/3.0 devices that support UASP.
- The data transfer speed varies with USB devices. For a higher data transfer performance, use a USB 3.1 device.

4.4.6 System Information

This utility allows you get the detailed information of the motherboard, CPU, and memory settings.

Launching the System Information

To launch System Information, click or tap  on the top-right corner of the AI Suite 3 main menu, then select **System Information**.

Viewing the motherboard information

Click or tap the **MB** tab to view the motherboard's information.

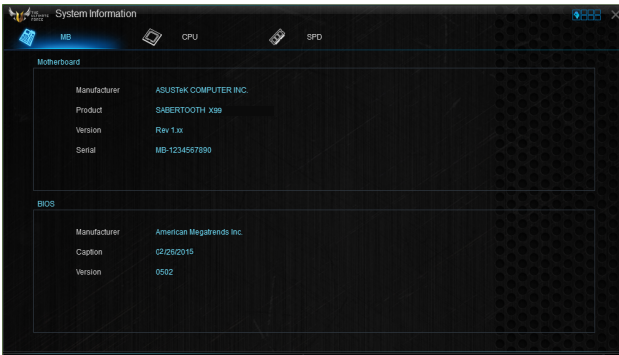

Viewing the CPU information

Click or tap the **CPU** tab to view the processor's information.



Viewing the SPD information

Click or tap the **SPD** tab to view the memory's information.



4.4.7 USB Charger+

USB Charger+ allows you to quick-charge your portable USB devices even if your computer is off, in sleep mode or hibernate mode.



Before using USB Charger+, ensure to disable the ErP Ready item from the **Advanced > APM > ErP Ready** in the Advanced mode of the BIOS Setup program.

Launching USB Charger+

To launch USB Charger+, click or tap  on the top-right corner of the AI Suite 3 main menu, then select **USB Charger+**.

USB Charger+ screen

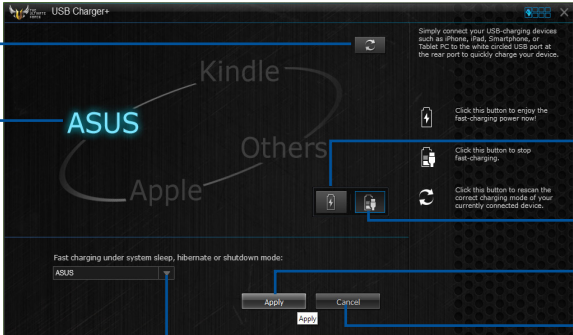

The screenshot shows the USB Charger+ utility window. It features a dark background with the ASUS logo and a list of device categories: Kindle, Apple, and Others. A progress bar at the bottom indicates the charging status, currently showing 'ASUS'. On the right side, there are three main control buttons: a lightning bolt icon for fast-charging, a power icon for stopping fast-charging, and a refresh icon for restoring the correct charging mode. Below these are 'Apply' and 'Cancel' buttons. Callouts point to various elements: the top-left refresh icon, the device list, the fast-charging button, the stop fast-charging button, the restore mode button, the 'Apply' button, the 'Cancel' button, and the device selection dropdown.

Click or tap to detect the connected USB device

Indicates that the connected USB device is in charging mode

Click or tap to fast-charge your USB device

Click or tap to stop charging your USB device

Click or tap to apply the settings

Click or tap to discard the settings

Click or tap to select the type of USB device that you wish to charge when the system is off



Ensure to connect your USB device into the USB port that supports this utility. Refer to section **2.3.1 Rear I/O connection** of your user guide for more details.



- The USB Charger+ does not support USB hubs and USB extension cables, and generic USB cables.
- The USB Charger+ may not recognize some ASUS devices due to a special design.

4.4.8 Version

Displays the installed software or utilities and their current version.



4.5 Turbo LAN

Turbo LAN is a network traffic shaping technology that lowers lag and helps reduce delays during data transfers or when playing online games. It allows you to set programs or application's network priorities to currently running games or applications.

Turbo LAN features an intuitive user interface and an Advance Mode that tweakers can use to configure hardcore controls or settings.

To launch Turbo LAN, click or tap  on the desktop.

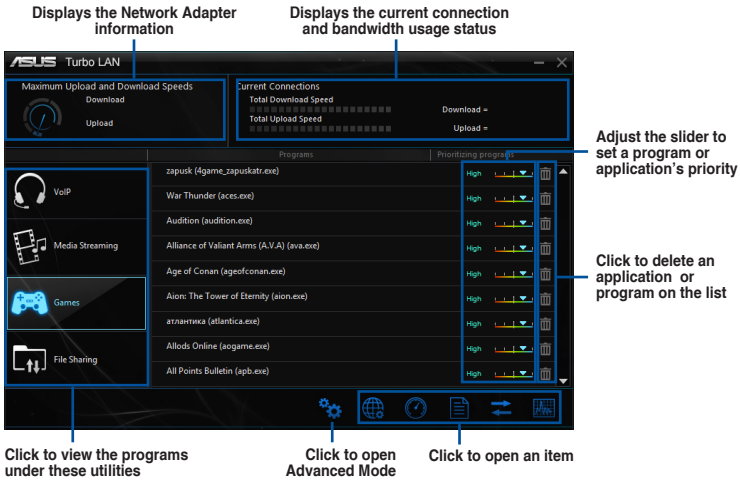

Using the Advance Mode

The Advance Mode allows you to configure the priorities of your programs or applications or configure your network device.

To go to the Advanced Mode, click or tap .

The Advanced Mode contains the following utilities:

- **Preferences:** Allows you to control the network's traffic to optimize the program's performance, favor ping time, and avoid packet loss.
- **Protocols:** Allows you to set priority to the network adapter and its protocol to reduce delay during data transfer, and maintain the speed of Internet access.
- **Programs:** Allows you to set priority to the programs or applications.
- **Traffic Shaping:** Allows you set the priority to the network adapter and its protocol to reduce delay during data transfer and speeds up the Internet access.
- **Adapter Info:** Displays the information about the installed network adapter in your system.
- **Online Budgets:** Allows you to set an online budget time to your network adapters.
- **Traffic Analysis:** Allows you to assign protocols and programs in one set.

4.6 TUF Detective

TUF Detective allows you to remotely manage and control your computer using your Android mobile device. It also provides relevant system information.

To use TUF Detective:

1. Connect your mobile device to the TUF Detective port located at the rear panel.
2. On your mobile device, download and install the TUF Detective app.



Download the TUF Detective app from Play Store or use the QR code to find the app.

3. Launch the TUF Detective app to remotely control and manage your computer.

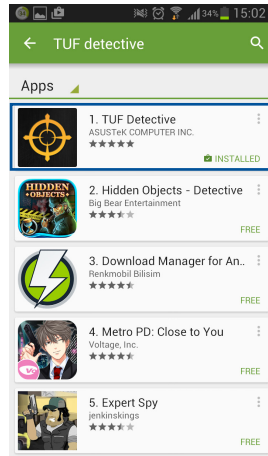

Select this App to install TUF Detective in your mobile phone.



Scan the QR code to find the app.

4.6.1 Post

The Post page provides the POST (Power-On Self Test) status..

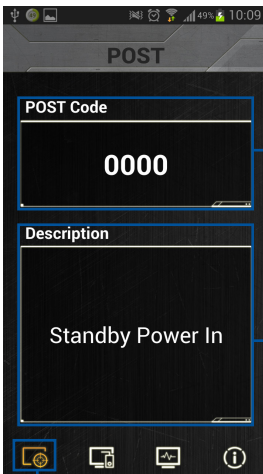

Code for the POST status

Details about the POST status.

Post

4.6.2 Control

The Control page allows you to remotely control the functions of your computer.

Tap the **POWER** button and select **Yes** to power your computer on or off.

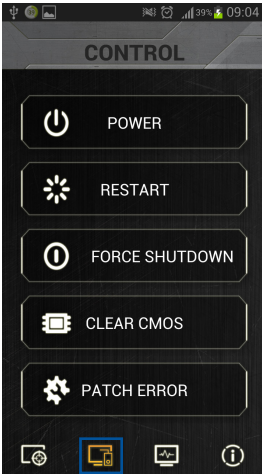

Control

Tap the **RESTART** button and select **Yes** to restart your computer.

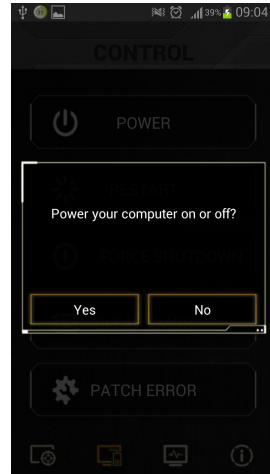

Tap **FORCE SHUTDOWN** to force the system to shutdown without saving data.

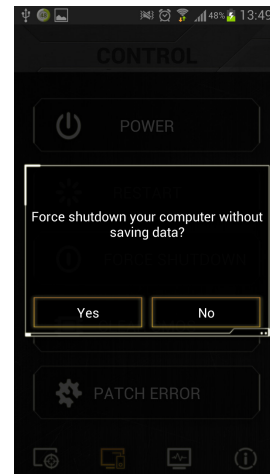

Tap **CLEAR CMOS** and select **Yes** to clear the CMOS RTC RAM data.



Tap **PATCH ERROR** and select **Yes** to automatically repair your computer.

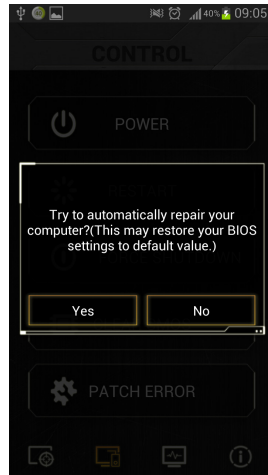

4.6.3 Monitor

The Monitor page allows you to monitor voltage, temperature, and fan speed.

Tap the triangle icon to monitor the voltage.

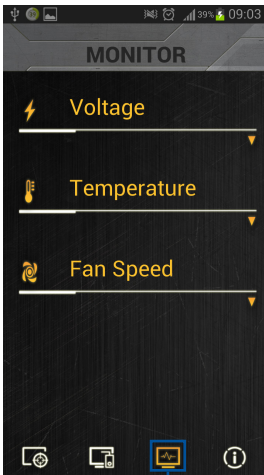

Monitor

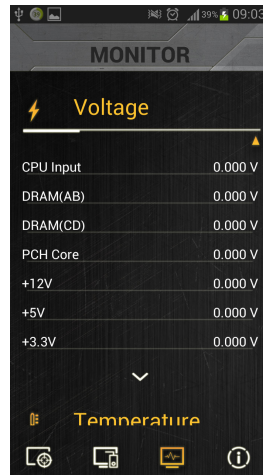

Tap the triangle icon to monitor the temperature.

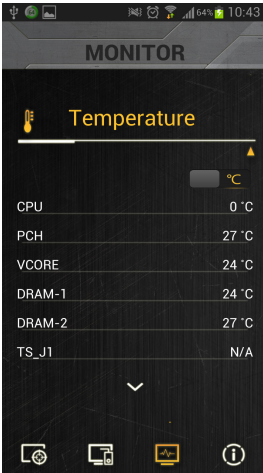

Tap the triangle icon to monitor the fan speed.

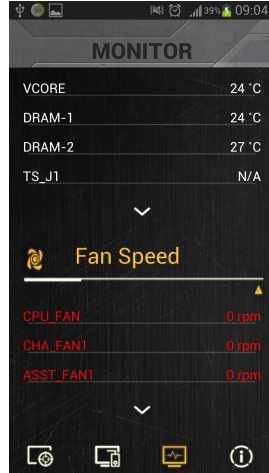

4.6.4 Information

The Information page provides you with important details about the system such as the model name, BIOS version, product number, operating time, CPU information, and DRAM information.



Information

4.7 Audio configurations

The Realtek® audio CODEC provides 8-channel audio capability to deliver the ultimate audio experience on your computer. The software provides Jack-Sensing function, S/PDIF Out support, and interrupt capability. The CODEC also includes the Realtek® proprietary UAJ® (Universal Audio Jack) technology for all audio ports, eliminating cable connection errors, and giving users plug and play convenience.

Follow the installation wizard to install the Realtek® Audio Driver from the support DVD that came with the motherboard package.

If the Realtek® audio software is correctly installed, you will find the Realtek® HD Audio Manager icon on the taskbar. Double-click or tap on the icon to display the Realtek® HD Audio Manager.



Realtek® HD Audio Manager

Realtek® HD Audio Manager



Selecting an audio output

Realtek HD Audio Manager allows you to select the type of audio output depending on the output device that you are using.

To select an audio output:

1. Insert the audio device's jack to the Line Out (lime) port. If the audio device's jack is already inserted to the corresponding port, click or tap  on the Realtek HD Audio Manager.
2. On the pop-up window, tick the audio device that you plugged to the Line Out port then click or tap **Next**.

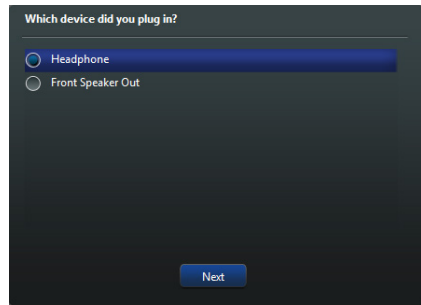

- a. If you select **Headphone**, click or tap to select the type of headphone installed then click or tap **OK**.

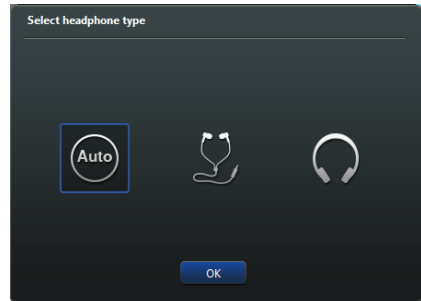

- b. If you select **Front Speaker Out**, click or tap to select the type of speaker installed then click or tap **OK**.

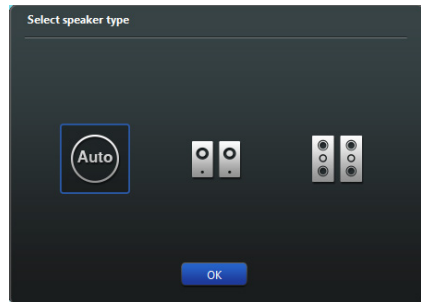

RAID support

5

5.1 RAID configurations

The motherboard comes with the Intel® Rapid Storage Technology that supports RAID 0, RAID 1, RAID 10 and RAID 5 configuration.

5.1.1 RAID definitions

RAID 0 (Data striping) optimizes two identical hard disk drives to read and write data in parallel, interleaved stacks. Two hard disks perform the same work as a single drive but at a sustained data transfer rate, double that of a single disk alone, thus improving data access and storage. Use of two new identical hard disk drives is required for this setup.

RAID 1 (Data mirroring) copies and maintains an identical image of data from one drive to a second drive. If one drive fails, the disk array management software directs all applications to the surviving drive as it contains a complete copy of the data in the other drive. This RAID configuration provides data protection and increases fault tolerance to the entire system. Use two new drives or use an existing drive and a new drive for this setup. The new drive must be of the same size or larger than the existing drive.

RAID 5 stripes both data and parity information across three or more hard disk drives. Among the advantages of RAID 5 configuration include better HDD performance, fault tolerance, and higher storage capacity. The RAID 5 configuration is best suited for transaction processing, relational database applications, enterprise resource planning, and other business systems. Use a minimum of three identical hard disk drives for this setup.

RAID 10 is data striping and data mirroring combined without parity (redundancy data) having to be calculated and written. With the RAID 10 configuration you get all the benefits of both RAID 0 and RAID 1 configurations. Use four new hard disk drives or use an existing drive and three new drives for this setup.

5.1.2 Installing Serial ATA hard disks

The motherboard supports Serial ATA hard disk drives. For optimal performance, install identical drives of the same model and capacity when creating a disk array.

To install the SATA hard disks for a RAID configuration:

1. Install the SATA hard disks into the drive bays.
2. Connect the SATA signal cables.
3. Connect a SATA power cable to the power connector on each drive.

5.1.3 Setting the RAID item in BIOS

You must enable the RAID function in the BIOS Setup before creating RAID sets using SATA HDDs. To do this:

1. Enter the BIOS Setup during POST.
2. Go to the **Advanced** menu > **SATA Configuration**, and then press <Enter>.
3. Set the SATA Mode item to [RAID Mode].
4. Save your changes, and then exit the BIOS Setup.



Refer to Chapter 3 for details on entering and navigating through the BIOS Setup



Due to chipset limitation, when SATA ports are set to RAID mode, all SATA ports run at RAID mode together.

5.1.4 Intel® Rapid Storage Technology Option ROM utility

To enter the Intel® Rapid Storage Technology Option ROM utility:

1. Turn on the system.
2. During POST, press <Ctrl> + <I> to display the utility main menu.

```
Intel(R) Rapid Storage Technology - Option ROM - v10.5.1.1070
Copyright(C) 2003-10 Intel Corporation. All Rights Reserved.

[ MAIN MENU ]
1. Create RAID Volume      4. Recovery Volume Options
2. Delete RAID Volume     5. Acceleration Options
3. Reset Disks to Non-RAID 6. Exit

[ DISK/VOLUME INFORMATION ]

RAID Volumes:
None defined.

Physical Devices:
Port Device Model      Serial #      Size  Type/Status (Vol ID)
0  ST3160812AS         9LS0HJA4    149.0GB Non-RAID Disk
1  ST3160812AS         9LS0F4HL    149.0GB Non-RAID Disk
2  ST3160812AS         3LS0JYL8    149.0GB Non-RAID Disk
3  ST3160812AS         9LS0B75H    149.0GB Non-RAID Disk

[↑↓]-Select      [ESC]-Exit      [ENTER]-Select Menu
```

The navigation keys at the bottom of the screen allow you to move through the menus and select the menu options.



The RAID BIOS setup screens shown in this section are for reference only and may not exactly match the items on your screen.



The utility supports maximum four hard disk drives for RAID configuration.

Creating a RAID set

To create a RAID set:

1. From the utility main menu, select **1. Create RAID Volume** and press <Enter>. The following screen appears:

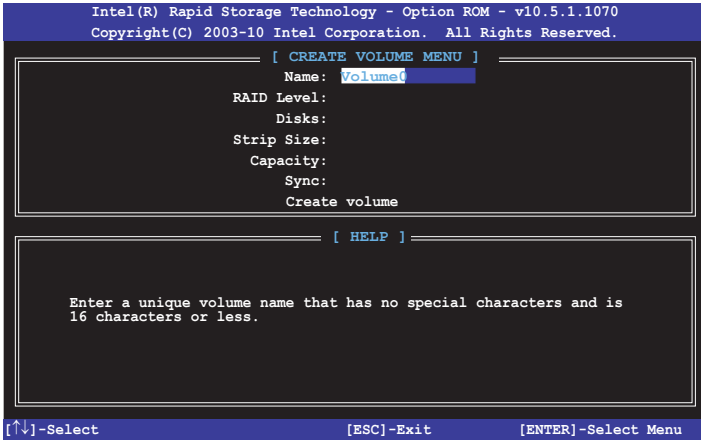

2. Enter a name for the RAID set and press <Enter>.
3. When the RAID Level item is selected, press the up/down arrow key to select a RAID level to create, and then press <Enter>.
4. When the Disks item is selected, press <Enter> to select the hard disk drives you want to include in the RAID set. The SELECT DISKS screen appears:

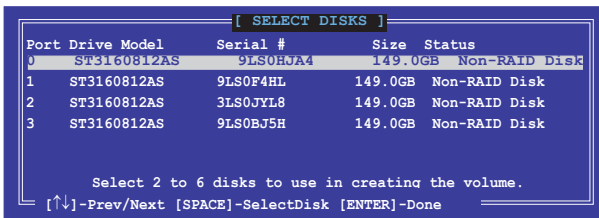

5. Use the up/down arrow key to select a drive, and then press <Space> to select. A small triangle marks the selected drive. Press <Enter> after completing your selection.
6. Use the up/down arrow key to select the stripe size for the RAID array (for RAID 0, 10 and 5 only), and then press <Enter>. The available stripe size values range from 4KB to 128KB. The following are typical values:
 - RAID 0: 128KB
 - RAID 10: 64KB
 - RAID 5: 64KB



We recommend a lower stripe size for server systems, and a higher stripe size for multimedia computer systems used mainly for audio and video editing.

7. When the **Capacity** item is selected, enter the RAID volume capacity that you want and press <Enter>. The default value indicates the maximum allowed capacity.
8. When the **Create Volume** item is selected, press <Enter>. The following warning message appears:

WARNING: ALL DATA ON SELECTED DISKS WILL BE LOST.
Are you sure you want to create this volume? (Y/N) :

9. Press <Y> to create the RAID volume and return to the main menu, or <N> to go back to the CREATE VOLUME menu.

Deleting a RAID set



Be cautious when deleting a RAID set. You will lose all data on the hard disk drives when you delete a RAID set.

To delete a RAID set:

1. From the utility main menu, select **2. Delete RAID Volume** and press <Enter>. The following screen appears:

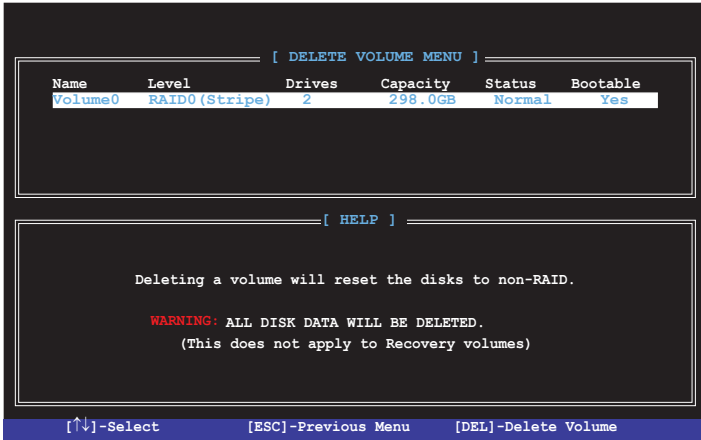

2. Use the up/down arrow key to select the RAID set you want to delete, and then press <Delete>. The following warning message appears:

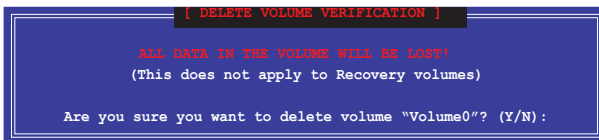

3. Press <Y> to delete the RAID set and return to the utility main menu, or press <N> to return to the DELETE VOLUME menu.

Exiting the Intel® Rapid Storage Technology Option ROM utility

To exit the utility:

1. From the utility main menu, select **5. Exit**, then press <Enter>. The following warning message appears:

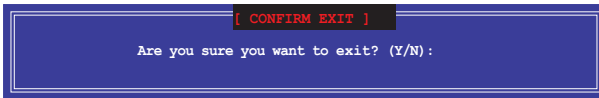

2. Press <Y> to exit or press <N> to return to the utility main menu.

5.2 Installing the RAID driver during Windows® OS installation

To install the RAID driver for Windows® OS:

1. During the OS installation, click **Load Driver** to allow you to select the installation media containing the RAID driver.
2. Insert the USB flash drive with RAID driver into the USB port or the support DVD into the optical drive, and then click **Browse**.
3. Click the name of the device you've inserted, go to **Drivers > RAID**, and then select the RAID driver for the corresponding OS version. Click **OK**.
4. Follow the succeeding screen instructions to complete the installation.



Before loading the RAID driver from a USB flash drive, you have to use another computer to copy the RAID driver from the support DVD to the USB flash drive.



To set up a Windows® UEFI operating system under RAID mode, ensure to load the UEFI driver for your optical drive.

Appendices

Notices

Federal Communications Commission Statement

This device complies with Part 15 of the FCC Rules. Operation is subject to the following two conditions:

- This device may not cause harmful interference.
- This device must accept any interference received including interference that may cause undesired operation.

This equipment has been tested and found to comply with the limits for a Class B digital device, pursuant to Part 15 of the FCC Rules. These limits are designed to provide reasonable protection against harmful interference in a residential installation. This equipment generates, uses and can radiate radio frequency energy and, if not installed and used in accordance with manufacturer's instructions, may cause harmful interference to radio communications. However, there is no guarantee that interference will not occur in a particular installation. If this equipment does cause harmful interference to radio or television reception, which can be determined by turning the equipment off and on, the user is encouraged to try to correct the interference by one or more of the following measures:

- Reorient or relocate the receiving antenna.
- Increase the separation between the equipment and receiver.
- Connect the equipment to an outlet on a circuit different from that to which the receiver is connected.
- Consult the dealer or an experienced radio/TV technician for help.



The use of shielded cables for connection of the monitor to the graphics card is required to assure compliance with FCC regulations. Changes or modifications to this unit not expressly approved by the party responsible for compliance could void the user's authority to operate this equipment.

IC: Canadian Compliance Statement

Complies with the Canadian ICES-003 Class B specifications. This device complies with RSS 210 of Industry Canada. This Class B device meets all the requirements of the Canadian interference-causing equipment regulations.

This device complies with Industry Canada license exempt RSS standard(s). Operation is subject to the following two conditions: (1) this device may not cause interference, and (2) this device must accept any interference, including interference that may cause undesired operation of the device.

Cet appareil numérique de la Classe B est conforme à la norme NMB-003 du Canada. Cet appareil numérique de la Classe B respecte toutes les exigences du Règlement sur le matériel brouilleur du Canada.

Cet appareil est conforme aux normes CNR exemptes de licence d'Industrie Canada. Le fonctionnement est soumis aux deux conditions suivantes :

- (1) cet appareil ne doit pas provoquer d'interférences et
- (2) cet appareil doit accepter toute interférence, y compris celles susceptibles de provoquer un fonctionnement non souhaité de l'appareil.

Canadian Department of Communications Statement

This digital apparatus does not exceed the Class B limits for radio noise emissions from digital apparatus set out in the Radio Interference Regulations of the Canadian Department of Communications.

This class B digital apparatus complies with Canadian ICES-003.

VCCI: Japan Compliance Statement

Class B ITE

この装置は、クラスB情報技術装置です。この装置は、家庭環境で使用することを目的としていますが、この装置がラジオやテレビジョン受信機に近接して使用されると、受信障害を引き起こすことがあります。

取扱説明書に従って正しい取り扱いをして下さい。

VCCI-B

KC: Korea Warning Statement

B급 기기 (가정용 방송통신기자재)

이 기기는 가정용(B급) 전자파적합기기로서 주로 가정에서 사용하는 것을 목적으로 하며, 모든 지역에서 사용할 수 있습니다.

*당해 무선설비는 전파혼신 가능성이 있으므로 인명안전과 관련된 서비스는 할 수 없습니다.

REACH

Complying with the REACH (Registration, Evaluation, Authorisation, and Restriction of Chemicals) regulatory framework, we published the chemical substances in our products at ASUS REACH website at <http://csr.asus.com/english/REACH.htm>.



DO NOT throw the motherboard in municipal waste. This product has been designed to enable proper reuse of parts and recycling. This symbol of the crossed out wheeled bin indicates that the product (electrical and electronic equipment) should not be placed in municipal waste. Check local regulations for disposal of electronic products.



DO NOT throw the mercury-containing button cell battery in municipal waste. This symbol of the crossed out wheeled bin indicates that the battery should not be placed in municipal waste.

ASUS Recycling/Takeback Services

ASUS recycling and takeback programs come from our commitment to the highest standards for protecting our environment. We believe in providing solutions for you to be able to responsibly recycle our products, batteries, other components as well as the packaging materials. Please go to <http://csr.asus.com/english/Takeback.htm> for detailed recycling information in different regions.

Google™ License Terms

Copyright© 2014 Google Inc. All Rights Reserved.

Licensed under the Apache License, Version 2.0 (the "License"); you may not use this file except in compliance with the License. You may obtain a copy of the License at:

<http://www.apache.org/licenses/LICENSE-2.0>

Unless required by applicable law or agreed to in writing, software distributed under the License is distributed on an "AS IS" BASIS, WITHOUT WARRANTIES OR CONDITIONS OF ANY KIND, either express or implied.

See the License for the specific language governing permissions and limitations under the License.

English AsusTek Inc. hereby declares that this device is in compliance with the essential requirements and other relevant provisions of CE Directives. Please see the CE Declaration of Conformity for more details.

Français AsusTek Inc. déclare par la présente que cet appareil est conforme aux critères essentiels et autres clauses pertinentes des directives européennes. Veuillez consulter la déclaration de conformité CE pour plus d'informations.

Deutsch AsusTek Inc. erklärt hiermit, dass dieses Gerät mit den wesentlichen Anforderungen und anderen relevanten Bestimmungen der CE-Richtlinien übereinstimmt. Weitere Einzelheiten entnehmen Sie bitte der CE-Konformitätserklärung.

Italiano AsusTek Inc. con la presente dichiara che questo dispositivo è conforme ai requisiti essenziali e alle altre disposizioni pertinenti alle direttive CE. Per maggiori informazioni fate riferimento alla dichiarazione di conformità CE.

Компания ASUS заявляет, что это устройство соответствует основным требованиям и другим соответствующим условиям европейских директив. Подробную информацию, пожалуйста, смотрите в декларации соответствия.

Български С настоящото AsusTek Inc. декларира, че това устройство е в съответствие със съществени изисквания и другите приложими постановления на директивите CE. Вижте CE декларацията за съвместимост за повече информация.

Hrvatski AsusTek Inc. ovim izjavljuje da je ovaj uređaj sukladan s bitnim zahtjevima i ostalim odgovarajućim odredbama CE direktiva. Više pojedinosti potražite u CE izvaji o sukladnosti.

Čeština Společnost AsusTek Inc. tímto prohlašuje, že toto zařízení splňuje základní požadavky a další příslušná ustanovení směrnice CE. Další podrobnosti viz Prohlášení o shodě CE.

Dansk AsusTek Inc. Erklærer hermed, at denne enhed er i overensstemmelse med hovedkravene and andre relevante bestemmelser i CE-direktiverne. Du kan læse mere i CE-overensstemmelseserklæring.

Nederlands AsusTek Inc. verklaart hierbij dat dit apparaat compatibel is met de essentiële vereisten en andere relevante bepalingen van CE-richtlijnen. Raadpleeg de CE-verklaring van conformiteit voor meer details.

Eesti Käesolevaga kinnitab AsusTek Inc., et see seade vastab CE direktiivide oluliste nõuetele ja teisteles asjakohastele sätetele. Vt üksikasju CE vastavusdeklaratsioonist.

Suomi AsusTek Inc. vakuuttaa täten, että tämä laite on CE-direktiivien olennaisten vaatimusten ja muiden asiaan kuuluvien lisäysten mukainen. Katso lisätietoja CE-vaatimustenmukaisuusvakuutuksesta.

Ελληνικά Με το παρόν, η AsusTek Inc. Δηλώνει ότι αυτή η συσκευή συμμορφώνεται με τις θεμελιώδεις απαιτήσεις και άλλες σχετικές διατάξεις των Οδηγιών της ΕΕ. Για περισσότερες λεπτομέρειες ανατρέξτε στην Δήλωση Συμμόρφωσης ΕΕ.

Magyar Az AsusTek Inc. ezennel kijelenti, hogy a készülék megfelel a CE-irányelvek alapvető követelményeinek és ide vonatkozó egyéb rendelkezéseinek. További részletekért tekintse meg a CE-megfelelőségi nyilatkozatot.

Latviski Lidz ar šo AsusTek Inc. paziņo, ka šī ierīce atbilst būtiskajām prasībām un citiem saistošajiem nosacījumiem, kas norādīti CE direktīvā. Lai uzzinātu vairāk, skatiet CE Atbilstības deklarāciju.

Lietuvių Šiuo dokumentu bendrovė „AsusTek Inc.“ pareiškia, kad šis įrenginys atitinka pagrindinius CE direktyvų reikalavimus ir kitas susijusias nuostatas. Daugiau informacijos rasite CE atitikties deklaracijoje.

Norsk AsusTek Inc. erklærer herved at denne enheten er i samsvar med hovedsaklige krav og andre relevante forskrifter i CE-direktiver. Du finner mer informasjon i CE-samsvarserklæringen.

Polski Niniejszym AsusTek Inc. deklaruje, że to urządzenie jest zgodne z istotnymi wymaganiami oraz innymi powiązanymi zaleceniami Dyrektywy CE. W celu uzyskania szczegółów, sprawdź Deklarację zgodności CE.

Português A AsusTek Inc. declara que este dispositivo está em conformidade com os requisitos essenciais e outras disposições relevantes das Diretivas da CE. Para mais detalhes, consulte a Declaração de Conformidade CE.

Română Prin prezenta, AsusTek Inc. declară faptul că acest dispozitiv respectă cerințele esențiale și alte prevederi relevante ale directivelor CE. Pentru mai multe detalii, consultați declarația de conformitate CE.

Srpski AsusTek Inc. ovim izjavljuje da je ovaj uređaj u saglasnosti sa ključnim zahtjevima i drugim relevantnim odredbama CE Direktiva. Molimo vas, pogledajte CE Deklaraciju o uskladenosti za više detalja.

Slovensky Spoločnosť ASUS týmto prehlasuje, že toto zariadenie vyhovuje príslušným požiadavkám a ďalším súvisiacim ustanoveniam smerníc ES. Viac podrobností si pozrite v prehlásení o zhode ES.

Slovenščina AsusTek Inc. tukaj izjavlja, da je ta naprava skladna s temeljnimi zahtevimi in drugimi relevantnimi določili direktiv CE. Za več informacij glejte izjavo CE o skladnosti.

Español Por la presente, AsusTek Inc. declara que este dispositivo cumple los requisitos básicos y otras disposiciones relevantes de las directivas de la CE. Consulte la Declaración de conformidad de la CE para obtener más detalles.

Svenska AsusTek Inc. förklarar härmed att denna enhet är i överensstämmelse med de grundläggande kraven och andra relevanta bestämmelser i CE-direktiven. Se CE-försäkran om överensstämmelse för mer information.

Українська AsusTek Inc. заявляє, що цей пристрій відповідає основним вимогам відповідних Директив ЄС. Будь ласка, див. більше подробиць у Декларації відповідності нормам ЄС.

Türkçe AsusTek Inc., bu aygıtın temel gereksinimleri ve CE Yönergelerinin diğer ilgili koşullarına uyumlu olduğunu beyan eder. Daha fazla ayrıntı için lütfen CE Uygunluk Beyanına bakın.

Bosanski AsusTek Inc. ovim potvrđuje da je ovaj uređaj uskladen s osnovnim zahtjevima i drugim relevantnim propisima Direktiva EK. Za više informacija molimo pogledajte Deklaraciju o uskladenosti EK.

ASUS contact information

ASUSTeK COMPUTER INC.

Address 15 Li-Te Road, Peitou, Taipei, Taiwan 11259
Telephone +886-2-2894-3447
Fax +886-2-2890-7798
E-mail info@asus.com.tw
Web site www.asus.com.com/

Technical Support

Telephone +86-21-38429911
Fax +86-21-5866-8722, ext. 9101#
Online support <http://www.asus.com/tw/support/>

ASUS COMPUTER INTERNATIONAL (America)

Address 800 Corporate Way, Fremont, CA 94539, USA
Telephone +1-510-739-3777
Fax +1-510-608-4555
Web site <http://www.asus.com/us/>

Technical Support

Support fax +1-812-284-0883
Telephone +1-812-282-2787
Online support <http://www.service.asus.com/>

ASUS COMPUTER GmbH (Germany and Austria)

Address Harkort Str. 21-23, D-40880 Ratingen, Germany
Fax +49-2102-959911
Web site <http://www.asus.com/de>
Online contact <http://eu-rma.asus.com/sales>

Technical Support

Telephone +49-1805-010923*
Support Fax +49-2102-9599-11
Online support <http://www.asus.com/de/support/>

DECLARATION OF CONFORMITY

Per FCC Part 2, Section 2.1077(a)



Responsible Party Name: Asus Computer International

Address: 800 Corporate Way, Fremont, CA 94539.

Phone/Fax No: (510)739-3777/(510)608-4555

hereby declares that the product

Product Name : Motherboard

Model Number : SABERTOOTH X99

Conforms to the following specifications:

- FCC Part 15, Subpart B, Unintentional Radiators

Supplementary Information:

This device complies with part 15 of the FCC Rules. Operation is subject to the following two conditions: (1) This device may not cause harmful interference, and (2) this device must accept any interference received, including interference that may cause undesired operation.

Representative Person's Name : Steve Chang / President

Signature :

Date : Feb. 26, 2015

Ver. 140331



EC Declaration of Conformity

We, the undersigned,

Manufacturer: ASUSTEK COMPUTER INC.
 Address: 4F, No. 150, LI-TE RD., PEITOU, TAIPEI 112, TAIWAN
 Authorized representative in Europe: ASUS COMPUTER GmbH
 Address, City: HARKORT STR. 21-23, 40880 RATINGEN
 Country: GERMANY

declares the following apparatus:

Production name: Motherboard
 Model name: SABERTOOTH X99

conform with the essential requirements of the following directives:

- 2004/108/EC EMC Directive
- EN 55022:2005/02/11
- EN 61000-3-2:2006/A2:2009
- EN 55013:2001/A1:2005/A2:2006
- 2006/95/EC LVD Directive
- EN 55024:2010
- EN 61000-3-3:2010
- EN 55020:2007/A1:2011

- EN 300 328 V1.8.1 (2012-06)
- EN 300 440-1 V1.6 (12/01-08)
- EN 300 511 V2.0.2 (2006-03)
- EN 301 908-1 V6.2.1 (2011-06)
- EN 301 908-2 V2.0.1 (2007-07)
- EN 301 883 V1.7.1 (2012-02-09)
- EN 302 554-2 V1.1 (20/09-01)
- EN 302 623 V1.1.1 (20/09-01)
- EN 302 623 V1.3 (12/07-09)
- EN 302 623 V1.4 (12/07-09)
- EN 62 709:2010
- EN 50 585:2002
- EN 62 317:2008
- EN 301 489-1 V1.9.2 (2011-09)
- EN 301 489-3 V1.4 (12/02-08)
- EN 301 489-4 V1.3 (12/05-11)
- EN 301 489-9 V1.4 (12/07-11)
- EN 301 489-10 V1.3 (12/07-07)
- EN 301 489-24 V1.5 (12/01-09)
- EN 302 326-2 V1.2.2 (20/07-08)
- EN 302 326-3 V1.3 (12/07-09)
- EN 302 291 V1.1.1 (12/05-07)
- EN 302 291 V1.1.1 (12/05-07)

- 2006/95/EC LVD Directive
- EN 60950-1 A12:2011
- 2006/125/EC RoHS Directive
- Regulation (EC) No. 1275/2008
- Regulation (EC) No. 642/2009

- 2011/65/EU RoHS Directive
- CE marking
- Regulation (EC) No. 276/2009
- Regulation (EC) No. 617/2013

Ver. 140331



(EC conformity marking)

Position : CEO
 Name : Lerry Shun

 Signature : _____

Declaration Date: 26/02/2015
 Year to begin affixing CE marking: 2015