

**X99-E WS/  
USB 3.1**

**ASUS®**

**Motherboard**

**Copyright© 2019 ASUSTeK COMPUTER INC. All Rights Reserved.**

No part of this manual, including the products and software described in it, may be reproduced, transmitted, transcribed, stored in a retrieval system, or translated into any language in any form or by any means, except documentation kept by the purchaser for backup purposes, without the express written permission of ASUSTeK COMPUTER INC. ("ASUS").

Product warranty or service will not be extended if: (1) the product is repaired, modified or altered, unless such repair, modification of alteration is authorized in writing by ASUS; or (2) the serial number of the product is defaced or missing.

ASUS PROVIDES THIS MANUAL "AS IS" WITHOUT WARRANTY OF ANY KIND, EITHER EXPRESS OR IMPLIED, INCLUDING BUT NOT LIMITED TO THE IMPLIED WARRANTIES OR CONDITIONS OF MERCHANTABILITY OR FITNESS FOR A PARTICULAR PURPOSE. IN NO EVENT SHALL ASUS, ITS DIRECTORS, OFFICERS, EMPLOYEES OR AGENTS BE LIABLE FOR ANY INDIRECT, SPECIAL, INCIDENTAL, OR CONSEQUENTIAL DAMAGES (INCLUDING DAMAGES FOR LOSS OF PROFITS, LOSS OF BUSINESS, LOSS OF USE OR DATA, INTERRUPTION OF BUSINESS AND THE LIKE), EVEN IF ASUS HAS BEEN ADVISED OF THE POSSIBILITY OF SUCH DAMAGES ARISING FROM ANY DEFECT OR ERROR IN THIS MANUAL OR PRODUCT.

SPECIFICATIONS AND INFORMATION CONTAINED IN THIS MANUAL ARE FURNISHED FOR INFORMATIONAL USE ONLY, AND ARE SUBJECT TO CHANGE AT ANY TIME WITHOUT NOTICE, AND SHOULD NOT BE CONSTRUED AS A COMMITMENT BY ASUS. ASUS ASSUMES NO RESPONSIBILITY OR LIABILITY FOR ANY ERRORS OR INACCURACIES THAT MAY APPEAR IN THIS MANUAL, INCLUDING THE PRODUCTS AND SOFTWARE DESCRIBED IN IT.

Products and corporate names appearing in this manual may or may not be registered trademarks or copyrights of their respective companies, and are used only for identification or explanation and to the owners' benefit, without intent to infringe.

**Offer to Provide Source Code of Certain Software**

This product contains copyrighted software that is licensed under the General Public License ("GPL"), under the Lesser General Public License Version ("LGPL") and/or other Free Open Source Software Licenses. Such software in this product is distributed without any warranty to the extent permitted by the applicable law. Copies of these licenses are included in this product.

Where the applicable license entitles you to the source code of such software and/or other additional data, you may obtain it for a period of three years after our last shipment of the product, either

(1) for free by downloading it from <https://www.asus.com/support/>

or

(2) for the cost of reproduction and shipment, which is dependent on the preferred carrier and the location where you want to have it shipped to, by sending a request to:

ASUSTeK Computer Inc.  
Legal Compliance Dept.  
15 Li Te Rd.,  
Beitou, Taipei 112  
Taiwan

In your request please provide the name, model number and version, as stated in the About Box of the product for which you wish to obtain the corresponding source code and your contact details so that we can coordinate the terms and cost of shipment with you.

The source code will be distributed WITHOUT ANY WARRANTY and licensed under the same license as the corresponding binary/object code.

This offer is valid to anyone in receipt of this information.

ASUSTeK is eager to duly provide complete source code as required under various Free Open Source Software licenses. If however you encounter any problems in obtaining the full corresponding source code we would be much obliged if you give us a notification to the email address [gpl@asus.com](mailto:gpl@asus.com), stating the product and describing the problem (please DO NOT send large attachments such as source code archives, etc. to this email address).

# Contents

Safety information.....	vii
About this guide.....	viii
X99-E WS/USB 3.1 specifications summary.....	x
Package contents.....	xv
Installation tools and components.....	xvi
<b>Chapter 1: Product Introduction</b>	
<b>1.1 Special features.....</b>	<b>1-1</b>
1.1.1 Product highlights.....	1-1
1.1.2 Other special features.....	1-2
<b>1.2 Motherboard overview.....</b>	<b>1-3</b>
1.2.1 Before you proceed.....	1-3
1.2.2 Motherboard layout.....	1-4
1.2.3 Central Processing Unit (CPU).....	1-6
1.2.4 System memory.....	1-7
1.2.5 Expansion slots.....	1-9
1.2.6 Onboard buttons and switches.....	1-12
1.2.7 Jumpers.....	1-18
1.2.8 Onboard LEDs.....	1-19
1.2.9 Internal connectors.....	1-26
<b>Chapter 2: Basic Installation</b>	
<b>2.1 Building your PC system.....</b>	<b>2-1</b>
2.1.1 Motherboard installation.....	2-1
2.1.2 CPU installation.....	2-3
2.1.3 CPU heatsink and fan assembly installation.....	2-5
2.1.4 DIMM installation.....	2-6
2.1.5 ATX Power connection.....	2-7
2.1.6 SATA device connection.....	2-8
2.1.7 Front I/O Connector.....	2-9
2.1.8 Expansion Card installation.....	2-10
<b>2.2 BIOS update utility.....</b>	<b>2-11</b>
<b>2.3 Q-Code Logger utility.....</b>	<b>2-12</b>
2.3.1 Using the Q-Code Logger.....	2-12
<b>2.4 Motherboard rear and audio connections.....</b>	<b>2-13</b>
2.4.1 Rear I/O connection.....	2-13
2.4.2 Audio I/O connections.....	2-15
<b>2.5 Starting up for the first time.....</b>	<b>2-17</b>
<b>2.6 Turning off the computer.....</b>	<b>2-18</b>

## Chapter 3: BIOS Setup

<b>3.1</b>	<b>Knowing BIOS</b> .....	<b>3-1</b>
<b>3.2</b>	<b>BIOS setup program</b> .....	<b>3-2</b>
	3.2.1 EZ Mode.....	3-3
	3.2.2 Advanced Mode .....	3-4
	3.2.3 QFan Control.....	3-7
	3.2.4 EZ Tuning Wizard .....	3-9
<b>3.3</b>	<b>My Favorites</b> .....	<b>3-11</b>
<b>3.4</b>	<b>Main menu</b> .....	<b>3-13</b>
<b>3.5</b>	<b>Ai Tweaker menu</b> .....	<b>3-15</b>
<b>3.6</b>	<b>Advanced menu</b> .....	<b>3-32</b>
	3.6.1 CPU Configuration .....	3-33
	3.6.2 PCH Configuration .....	3-35
	3.6.3 PCH Storage Configuration.....	3-36
	3.6.4 System Agent Configuration .....	3-38
	3.6.5 USB Configuration .....	3-40
	3.6.6 Platform Misc Configuration.....	3-42
	3.6.7 Onboard Devices Configuration.....	3-43
	3.6.8 APM Configuration.....	3-46
	3.6.9 Network Stack Configuration.....	3-47
	3.6.10 Intel(R) Ethernet Connection (2) I218-LM 00:1E:99:00:00:37 ..	3-48
	3.6.11 Intel(R) I210 Gigabit Network Connection - 00:1E:99:00:00:38	3-49
<b>3.7</b>	<b>Monitor menu</b> .....	<b>3-50</b>
<b>3.8</b>	<b>Boot menu</b> .....	<b>3-54</b>
<b>3.9</b>	<b>Tool menu</b> .....	<b>3-60</b>
	3.9.1 ASUS EZ Flash 2 Utility .....	3-60
	3.9.2 ASUS O.C. Profile.....	3-61
	3.9.3 ASUS DRAM SPD Information .....	3-62
<b>3.10</b>	<b>Exit menu</b> .....	<b>3-63</b>
<b>3.11</b>	<b>Updating BIOS</b> .....	<b>3-64</b>
	3.11.1 EZ Update.....	3-64
	3.11.2 ASUS EZ Flash 2.....	3-64
	3.11.3 ASUS CrashFree BIOS 3.....	3-66



<b>Chapter 4: Software Support</b>	
<b>4.1</b>	<b>Installing an operating system ..... 4-1</b>
<b>4.2</b>	<b>Support DVD information ..... 4-1</b>
4.2.1	Running the support DVD ..... 4-1
4.2.2	Obtaining the software manuals ..... 4-3
<b>4.3</b>	<b>Software information ..... 4-4</b>
<b>4.4</b>	<b>AI Suite 3 ..... 4-4</b>
4.4.1	Ai Charger+ ..... 4-7
4.4.2	USB 3.1 Boost ..... 4-8
4.4.3	EZ Update ..... 4-9
4.4.4	USB BIOS Flashback ..... 4-11
4.4.5	USB Charger+ ..... 4-13
4.4.6	Push Notice ..... 4-14
4.4.7	System Information ..... 4-17
<b>4.5</b>	<b>Audio configurations ..... 4-18</b>
<b>4.6</b>	<b>ASUS Dr. Power Utility ..... 4-20</b>

<b>Chapter 5: RAID Support</b>	
<b>5.1</b>	<b>RAID configurations ..... 5-1</b>
5.1.1	RAID definitions ..... 5-1
5.1.2	Installing Serial ATA hard disks ..... 5-2
5.1.3	Setting the RAID item in BIOS ..... 5-2
5.1.4	Intel® Rapid Storage Technology Option ROM utility ..... 5-3
<b>5.2</b>	<b>Creating a RAID driver disk ..... 5-7</b>
5.2.1	Creating a RAID driver disk without entering the OS ..... 5-7
5.2.2	Creating a RAID driver disk in Windows® ..... 5-8
5.2.3	Installing the RAID driver during Windows® OS installation ..... 5-8

<b>Chapter 6: Multi GPU Support</b>	
<b>6.1</b>	<b>AMD® CrossFireX™ technology ..... 6-1</b>
6.1.1	Requirements ..... 6-1
6.1.2	Before you begin ..... 6-1
6.1.3	Installing two CrossFireX™ graphics cards ..... 6-2
6.1.4	Installing three CrossFireX™ graphics cards ..... 6-3
6.1.5	Installing four CrossFireX™ graphics cards ..... 6-4
6.1.6	Installing the device drivers ..... 6-5
6.1.7	Enabling the AMD® CrossFireX™ technology ..... 6-5

<b>6.2</b>	<b>NVIDIA® SLI™ technology .....</b>	<b>6-7</b>
6.2.1	Requirements.....	6-7
6.2.2	Installing two SLI-ready graphics cards .....	6-7
6.2.3	Installing three SLI-ready graphics cards.....	6-8
6.2.4	Installing four SLI-ready graphics cards.....	6-9
6.2.5	Installing the device drivers.....	6-10
6.2.6	Enabling the NVIDIA® SLI™ technology .....	6-10

**Appendices**

<b>X99-E WS/USB 3.1 block diagram (40-Lane) .....</b>	<b>A-1</b>
<b>X99-E WS/USB 3.1 block diagram (28-Lane) .....</b>	<b>A-2</b>
<b>Notices .....</b>	<b>A-3</b>
<b>ASUS contact information.....</b>	<b>A-7</b>

# Safety information

## Electrical safety

- To prevent electrical shock hazard, disconnect the power cable from the electrical outlet before relocating the system.
- When adding or removing devices to or from the system, ensure that the power cables for the devices are unplugged before the signal cables are connected. If possible, disconnect all power cables from the existing system before you add a device.
- Before connecting or removing signal cables from the motherboard, ensure that all power cables are unplugged.
- Seek professional assistance before using an adapter or extension cord. These devices could interrupt the grounding circuit.
- Ensure that your power supply is set to the correct voltage in your area. If you are not sure about the voltage of the electrical outlet you are using, contact your local power company.
- If the power supply is broken, do not try to fix it by yourself. Contact a qualified service technician or your retailer.

## Operation safety

- Before installing the motherboard and adding devices on it, carefully read all the manuals that came with the package.
- Before using the product, ensure all cables are correctly connected and the power cables are not damaged. If you detect any damage, contact your dealer immediately.
- To avoid short circuits, keep paper clips, screws, and staples away from connectors, slots, sockets and circuitry.
- Avoid dust, humidity, and temperature extremes. Do not place the product in any area where it may become wet.
- Place the product on a stable surface.
- If you encounter technical problems with the product, contact a qualified service technician or your retailer.

## About this guide

This user guide contains the information you need when installing and configuring the motherboard.

## How this guide is organized

This guide contains the following parts:

### 1. Chapter 1: Product Introduction

This chapter describes the features of the motherboard and the new technology it supports. It includes description of the switches, jumpers, and connectors on the motherboard.

### 2. Chapter 2: Basic Installation

This chapter lists the hardware setup procedures that you have to perform when installing system components.

### 3. Chapter 3: BIOS Setup

This chapter tells how to change system settings through the BIOS Setup menus. Detailed descriptions of the BIOS parameters are also provided.

### 4. Chapter 4: Software Support

This chapter describes the contents of the support DVD that comes with the motherboard package and the software.

### 5. Chapter 5: RAID Support

This chapter describes the RAID configurations.

### 6. Chapter 6: Multi GPU Support

This chapter describes how to install and configure multiple AMD® CrossFire™ and NVIDIA® SLI™ graphics cards.

## Where to find more information

Refer to the following sources for additional information and for product and software updates.

### 1. ASUS website

The ASUS website ([www.asus.com](http://www.asus.com)) provides updated information on ASUS hardware and software products.

### 2. Optional documentation

Your product package may include optional documentation, such as warranty flyers, that may have been added by your dealer. These documents are not part of the standard package.

## Conventions used in this guide

To make sure that you perform certain tasks properly, take note of the following symbols used throughout this manual.



**DANGER/WARNING:** Information to prevent injury to yourself when trying to complete a task.



**CAUTION:** Information to prevent damage to the components when trying to complete a task.



**IMPORTANT:** Instructions that you **MUST** follow to complete a task.



**NOTE:** Tips and additional information to help you complete a task.

## Typography

**Bold text**

Indicates a menu or an item to select.

*Italics*

Used to emphasize a word or a phrase.

<Key>

Keys enclosed in the less-than and greater-than sign means that you must press the enclosed key.

Example: <Enter> means that you must press the Enter or Return key.

<Key1>+<Key2>+<Key3>

If you must press two or more keys simultaneously, the key names are linked with a plus sign (+).

Example: <Ctrl>+<Alt>+<Del>

**Command**

Means that you must type the command exactly as shown, then supply the required item or value enclosed in brackets.

Example: At the DOS prompt, type the command line: **format A:/S**

## X99-E WS/USB 3.1 specifications summary

CPU	<p>LGA2011-v3 socket for the Next Generation Intel® Core™ i7 processors</p> <p>Intel® Socket 2011-v3 for Intel® Xeon® processor E5-1600 v3/2600 v3 product family</p> <p>Supports 22nm CPU, up to 20 MB Smart Cache*</p> <p>Supports Intel® Turbo Boost Technology 2.0*</p> <p>* The Intel® Turbo Boost Technology 2.0 support depends on the CPU types.</p>
Chipset	Intel® X99 Express Chipset
Memory	<p>8 x DIMM, Max. 128GB, DDR4 3200(O.C.)/3000(O.C.)/2800(O.C.)/2666(O.C.)/2400(O.C.)/2133 MHz Non-ECC, Un-buffered Memory *1</p> <p>8 x DIMM, Max. 128GB, DDR4 2133/1866 MHz ECC, Un-buffered, Register Memory *2</p> <p>*1 When installing Intel® Socket 2011-v3 Core™ i7 Processors</p> <p>*2 When installing Intel® Xeon® E5-1600 v3/2600 v3 Processor</p> <p>Quad channel memory architecture</p> <p>Supports Intel® Extreme Memory Profile (XMP)</p> <p>* Hyper DIMM support is subject to the physical characteristics of individual CPUs. Refer to <a href="http://www.asus.com">www.asus.com</a> for the memory QVL (Qualified Vendors Lists).</p>
Expansion slots	<p>40-LANE CPU</p> <p>7 x PCI Express 3.0/2.0 x16 slots (single at x16, dual at x16/x16, triple at x16/x16/x16, quad at x16/x16/x16/x16, seven at x16/x8/x8/x8/x8/x8/X8)</p> <p>28-LANE CPU</p> <p>7 x PCI Express 3.0/2.0 x16 slots* (single at x16, dual at x16/x16, triple at x16/x16/x16, quad at x16/x16/x16/x16, seven at x16/x8/x8/x8/x8/x8/X8)</p> <p>* The default setting of PCIe x16_2 slot is in Auto mode, which automatically optimizes the system bandwidth. ASUS Thunderbolt EX card is supported on PCIe16_2 slot (Gen 2) and automatically runs at x2 mode.</p>
Storage	<p><b>Intel® X99 Express Chipset with RAID 0, 1, 5, 10 and Intel® Rapid Storage Technology 13 support</b></p> <ul style="list-style-type: none"> <li>- 1 x SATA Express port (gray at upper, compatible with 2 x SATA 6.0 Gb/s ports)</li> <li>- 1 x M.2 Socket 3 with M Key, 2260/2280 storage devices support (PCIe mode only)</li> <li>- 8 x SATA 6.0 Gb/s ports* (4 x gray from controller 1, 4 x black from controller 2)</li> <li>- Supports Intel® Rapid Storage Technology** (Intel® Smart Response Technology, Intel® Rapid Start Technology, Intel® Smart Connect Technology)</li> </ul> <p><b>ASMedia® SATA Express controller***</b></p> <ul style="list-style-type: none"> <li>- 1 x SATA Express port (gray at bottom, compatible with 2 x SATA 6.0 Gb/s ports)</li> </ul> <p><b>ASMedia® SATA 6.0 Gb/s controller</b></p> <ul style="list-style-type: none"> <li>- 2 x eSATA 6 Gb/s ports</li> </ul> <p>* Due to chipset behavior, the SATA6G_78, SATA_910 ports (black) do not support Intel® Rapid Storage Technology including RAID configuration.</p> <p>** These functions work depending on the CPU installed.</p> <p>*** These SATA ports are for data hard drives only. ATAPI devices are not supported</p>

(continued on the next page)

## X99-E WS/USB 3.1 specifications summary

LAN	<p>1 x Intel® I210-AT Gigabit LAN controller            1 x Intel® I218-LM Gigabit LAN-Dual interconnect between the integrated LAN controller and physical layer (PHY)            ASUS Turbo LAN utility</p>
Multi-GPU support	<p>Supports AMD® 4-Way CrossFireX™ Technology            Supports NVIDIA® 4-Way SLI™ Technology</p>
Audio	<p>Realtek® ALC1150 8-channel high definition audio CODEC featuring Crystal Sound 2</p> <ul style="list-style-type: none"> <li>- Separate layer for left and right track, ensuring both sound deliver equal quality</li> <li>- Audio shielding ensures precision analog/digital separation and greatly reduced multi-lateral interference</li> <li>- Audio amplifier to enhance the highest quality sound for headphone and speakers</li> <li>- High quality 109 dB SNR stereo playback output (Line-out at back) and 104 dB SNR recording input (Line-in) support</li> <li>- Absolute Pitch 192khz/24bit True BD Lossless Sound</li> <li>- DTS UltraPC II</li> <li>- DTS Connect</li> <li>- Supports jack-detection, multi-streaming and front panel jack-retasking (MIC)</li> <li>- Optical S/PDIF out ports at rear I/O</li> </ul>
USB	<p><b>Intel® X99 Express Chipset - supports ASUS USB 3.0 Boost</b></p> <ul style="list-style-type: none"> <li>- 4 x USB 3.0/2.0 ports at rear panel</li> <li>- 4 x USB 2.0/1.1 ports (4 ports at mid-board)</li> </ul> <p><b>ASMedia® USB 3.1 controller - support ASUS USB 3.1 Boost</b></p> <ul style="list-style-type: none"> <li>- 2 x USB 3.1/3.0/2.0 ports at rear panel (teal blue)</li> </ul> <p><b>ASMedia® USB 3.0 Hubs - support ASUS USB 3.0 Boost</b></p> <ul style="list-style-type: none"> <li>- 8 x USB 3.0/2.0 ports (4 ports at rear panel, 4 ports at mid-board for front panel support)</li> </ul>
ASUS Exclusive Features	<p><b>High Performance</b></p> <p><b>5-Way Optimization by Dual Intelligent Processors 5</b></p> <ul style="list-style-type: none"> <li>- Whole system optimization with a single click! 5-Way Optimization tuning key perfectly consolidates TPU, EPU, DIGI+ Power Control, Fan Xpert 3, and Turbo APP together, providing better CPU performance, efficient power saving, precise digital power control, whole system cooling and even tailor your own app usages.</li> </ul> <p><b>DIGI+ Power Control</b></p> <p>CPU Power</p> <ul style="list-style-type: none"> <li>- Industry leading digital 8-phase power design</li> <li>- ASUS CPU power utility</li> </ul> <p>DRAM Power</p> <ul style="list-style-type: none"> <li>- Industry leading digital 2+2-phase DRAM power design</li> <li>- ASUS DRAM power utility</li> </ul> <p><b>TPU</b></p> <ul style="list-style-type: none"> <li>- Auto Tuning, TPU, GPU Boost, 2-level TPU switch</li> </ul>

*(continued on the next page)*

## X99-E WS/USB 3.1 specifications summary

### ASUS Exclusive Features

#### EPU

- EPU, EPU switch

#### ASUS Fan Xpert3

- Featuring Fan Auto Tuning function and multiple thermistors selection for optimized system cooling control.

#### Turbo App

- Featuring automatic system performance tuning, network priority, and audio scene configuration for selected applications.

#### UEFI BIOS

- Most advanced options with fast response time

#### M.2 and SATA Express onboard

- The latest transfer technology with up to 32 Gb/s data transfer speeds for M.2
- The ultra-fast transfer technology with up to 10 Gb/s data transfer speeds for SATA Express

#### Interactive HomeCloud

##### ASUS HomeCloud Server

##### Media Streamer

- Pipe music or movies from your PC to a smart TV, your entertainment goes wherever you go!
- Media Streamer app for portable smartphone/tablet, supporting iOS7 and Android 4.0 systems

#### Gaming Scenario

##### Turbo APP

- Perform each application with tailored performance, network priority, and audio configuration for your needs

##### Turbo LAN

- Experience smooth online gaming with lower pings and less lags

##### Crystal Sound 2

- Feel the sound power with different usage scenarios

##### Steam support

- Compatible with the most fun gaming platform under Windows® system

#### ASUS EZ DIY

##### Push Notice

- Monitor your PC status with smart devices in real time

##### USB BIOS Flashback

- with USB BIOS Flashback Wizard for EZ BIOS download scheduling

##### UEFI BIOS EZ Mode

- featuring friendly graphics user interface

*(continued on the next page)*



## X99-E WS/USB 3.1 specifications summary

<p><b>ASUS Exclusive Features</b></p>	<ul style="list-style-type: none"> <li>- ASUS O.C. Tuner</li> <li>- ASUS CrashFree BIOS 3</li> <li>- ASUS EZ Flash 2</li> </ul> <p><b>Q-Design</b></p> <ul style="list-style-type: none"> <li>- ASUS Q-Code</li> <li>- ASUS Q-Shield</li> <li>- ASUS Q-LED (DIAG_CPU, DIAG_DRAM, DIAG_VGA, DIAG_HDD)</li> <li>- ASUS Q-Slot</li> <li>- ASUS Q-DIMM</li> <li>- ASUS Q-Connector</li> </ul>
<p><b>ASUS Quiet Thermal Solution</b></p>	<p><b>Quiet Thermal Design</b></p> <ul style="list-style-type: none"> <li>- ASUS Fan Xpert 3</li> <li>- ASUS Fanless Design: Heat-pipe solution</li> </ul>
<p><b>Rear Panel I/O Ports</b></p>	<ul style="list-style-type: none"> <li>1 x BIOS Flashback button</li> <li>1 x Q-Code Logger button</li> <li>8 x USB 3.0/2.0 ports (blue)</li> <li>2 x USB 3.1/3.0/2.0 ports (teal blue)</li> <li>2 x eSATA ports</li> <li>1 x Optical S/PDIF Out port</li> <li>2 x LAN (RJ45) ports (2 x Intel® LAN)</li> <li>8 Audio I/O jacks</li> </ul>
<p><b>Internal I/O Connectors</b></p>	<ul style="list-style-type: none"> <li>2 x 19-pin USB 3.0/2.0 connectors support additional 4 USB ports</li> <li>2 x USB 2.0/1.1 connectors support additional 4 USB ports</li> <li>1 x M.2 Socket 3 (for M Key, type 2260/2280 devices)</li> <li>2 x SATA Express connectors (gray)</li> <li>8 x SATA 6.0 Gb/s connectors (4 x gray; 4 x black)</li> <li>1 x 4-pin CPU Fan connector for both 3-pin (DC Mode) and 4-pin (PWM Mode) CPU coolers control with auto detection support</li> <li>1 x 4-pin CPU OPT Fan connector</li> <li>4 x 4-pin Chassis Fan connectors for both 3-pin (DC Mode) and 4-pin (PWM Mode) fan control</li> <li>1 x Front panel audio connector(AAFP)</li> <li>1 x S/PDIF Out header</li> <li>1 x 5-pin Thunderbolt header for ASUS ThunderboltEX series support</li> <li>1 x TPM connector</li> <li>1 x 24-pin EATX Power connector</li> <li>2 x 8-pin EATX 12V Power connectors</li> <li>1 x 6-pin EATX 12V_1 Power connector</li> <li>1 x MemOK! button</li> <li>1 x Clear CMOS button</li> <li>1 x Chassis intrusion header</li> <li>1 x DRCT (DirectKey) connector</li> <li>1 x Dr. Power switch</li> <li>1 x TPU switch (advanced two-stage adjustments)</li> </ul>

(continued on the next page)

## X99-E WS/USB 3.1 specifications summary

<b>Internal I/O Connectors</b>	1 x EPU switch 1 x EZ XMP switch 1 x Power-on button 1 x Reset button 1 x 3-pin Chassis intrusion (CHASSIS) connector System Panel (Q-Connector)
<b>BIOS features</b>	128 Mb Flash ROM, UEFI AMI BIOS, PnP, DMI 2.7, WfM 2.0, SM BIOS 2.7, ACPI 5.0, Multi-language BIOS, ASUS EZ Flash 2, CrashFree BIOS 3, F11 EZ Tuning Wizard, F6 Qfan Control, F3 My Favorites, Quick Note, Last Modified Log, F12 PrintScreen function, F3 Shortcut function, and ASUS DRAM SPD (Serial Presence Detect) memory information
<b>Manageability</b>	WfM 2.0, DMI 2.7, WOL by PME, PXE
<b>Support DVD</b>	Drivers Anti-virus software (OEM version)
<b>Operating system</b>	Windows® 8.1 Windows® 8 Windows® 7
<b>Form Factors</b>	CEB Form Factor, 12 in. x 10.5 in. (30.5 cm x 26.7 cm)



---

Specifications are subject to change without notice.

---

# Package contents

Check your motherboard package for the following items

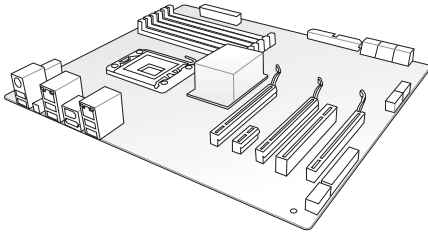

ASUS X99-E WS/USB 3.1 motherboard

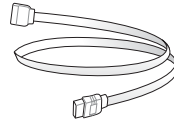

12 x Serial ATA 6 Gb/s cables

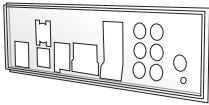

1 x ASUS Q-Shield

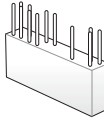

1 x 2-in-1 ASUS Q-Connector kit

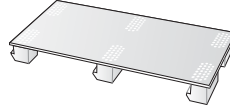

1 x 3-WAY SLI bridge connector



COM port bracket

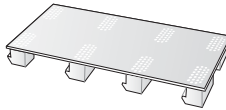

1 x 4-WAY SLI bridge connector



1 x ASUS SLI™ bridge connector

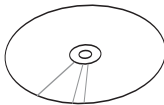

Support DVD



User Guide



- 
- If any of the above items is damaged or missing, contact your retailer.
  - The illustrated items above are for reference only. Actual product specifications may vary with different models.
-

# Installation tools and components

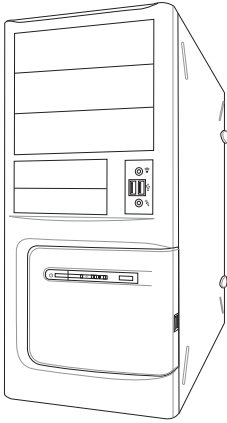

PC chassis

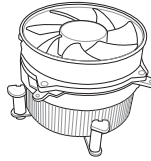

Intel® LGA2011-v3 compatible CPU Fan

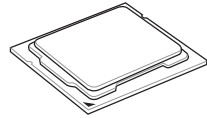

Intel® LGA2011-v3 CPU

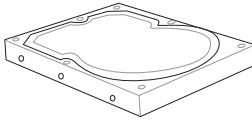

SATA hard disk drive



Phillips (cross) screwdriver

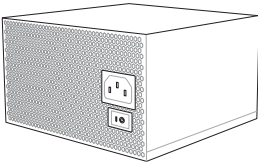

Power supply unit

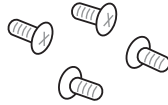

1 bag of screws

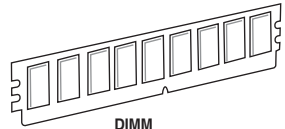

DIMM

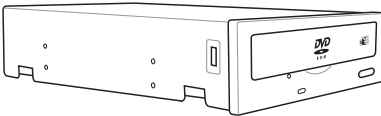

SATA optical disc drive (optional)

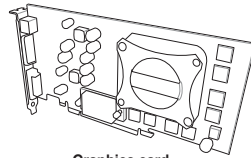

Graphics card



---

The tools and components in the table above are not included in the motherboard package.

---

# Product Introduction

# 1

## 1.1 Special features

### 1.1.1 Product highlights

#### **LGA2011-v3 socket for Intel® Core™ i7 processors**

This motherboard supports Intel® Core™ i7 processors in the LGA2011-v3 package. It provides great system performance, quad-channel DDR4 memory slots and PCI Express 2.0/3.0 expansion slots.

#### **Intel® X99 Express Chipset**

Intel® X99 Express Chipset is a single chipset that supports the LGA2011-v3 socket for Intel® Core™ i7 processors. It utilizes the serial point-to-point links, which increases bandwidth and enhances the system's performance. It natively supports up to six (6) USB 3.0 ports and ten (10) SATA 6 Gb/s ports.

#### **PCI Express® 3.0**

PCI Express® 3.0 (PCIe 3.0) is the PCI Express bus standard that provides twice the performance and speed of PCIe 2.0. It provides an optimal graphics performance, unprecedented data speed and seamless transition with its complete backward compatibility to PCIe 1.0/2.0 devices.

#### **4-WAY SLI and 4-Way CrossFireX™ Support**

This motherboard features NVIDIA 4-WAY SLI and AMD 4-Way CrossfireX support that enables multi-GPU setup, giving you the full power of the latest graphics technologies. It also features native support for 4K/UHD (ultra high definition) resolution of up to 4096 x 2160 via HDMI or DisplayPort, resulting to four times the number of pixels for incredible visual clarity, detail, and realism.

#### **SATA Express support**

SATA Express provides faster data transfer speeds of up to 10 Gb/s, allowing your system to catch up with the speed of the SSDs. It also features backward compatibility with up to two SATA drives of the same speed.

#### **Quad-Channel DDR4 2133 MHz Support**

The motherboard supports the quad-channel DDR4 memory that features data transfer rates of DDR4 2133 MHz to boost the system's performance, and to meet the higher bandwidth requirements of 3D graphics, multimedia and Internet applications.

#### **M.2 Support\***

This motherboard features the M.2 slot, which shares bandwidth with PCI Express 3.0 x4 slot to speed up data transfer up to 32 Gb/s. This helps enhance the performance of your SSD (Solid State Drive) that is dedicated only to the operating system.

\* Supports PCIe mode only.

## **Complete USB 3.1 integration**

This motherboard has the latest USB 3.1 connectivity built in with dual Type-A ports for the very fastest USB data transfers — that's up to 10 Gb/s, or twice as fast as USB 3.0. The next-generation standard is completely backward-compatible with your existing USB devices, and you'll be all set for USB 3.1's breakneck speeds.

### **1.1.2 Other special features**

#### **DTS Connect**

To get the most out of your audio entertainment across all formats and quality levels, DTS Connect combines two enabling technologies, DTS Neo:PC™ upmixes stereo sources (CDs, MP3s, WMAs, internet radio) into as many as 7.1 channels of incredible surround sound. Consumers can connect their PC to a home theater system. DTS Interactive is capable of performing mult-channel encoding of DTS bitstreams on personal computers, and sending encoded bitstreams out of a digital audio connection (such as S/PDIF or HDMI) designed to deliver audio to an external decoder.

#### **DTS UltraPC II**

DTS UltraPC II delivers a superior surround sound experience through your system's speakers and headphones while monitoring and balancing the loudness level difference between digital audio formats. It also enhances the audio settings through augmenting low and high frequencies of musical tones, restores compressed or re-mastered sounds, improves bass performance even without a subwoofer, and improves dialogues derived from DVD or Blu-ray Disc™.

## 1.2 Motherboard overview

### 1.2.1 Before you proceed

Take note of the following precautions before you install motherboard components or change any motherboard settings.



- 
- Unplug the power cord from the wall socket before touching any component.
  - Before handling components, use a grounded wrist strap or touch a safely grounded object or a metal object, such as the power supply case, to avoid damaging them due to static electricity.
  - Hold components by the edges to avoid touching the ICs on them.
  - Whenever you uninstall any component, place it on a grounded antistatic pad or in the bag that came with the component.
  - Before you install or remove any component, ensure that the ATX power supply is switched off or the power cord is detached from the power supply. Failure to do so may cause severe damage to the motherboard, peripherals, or components.
-

## 1.2.2 Motherboard layout

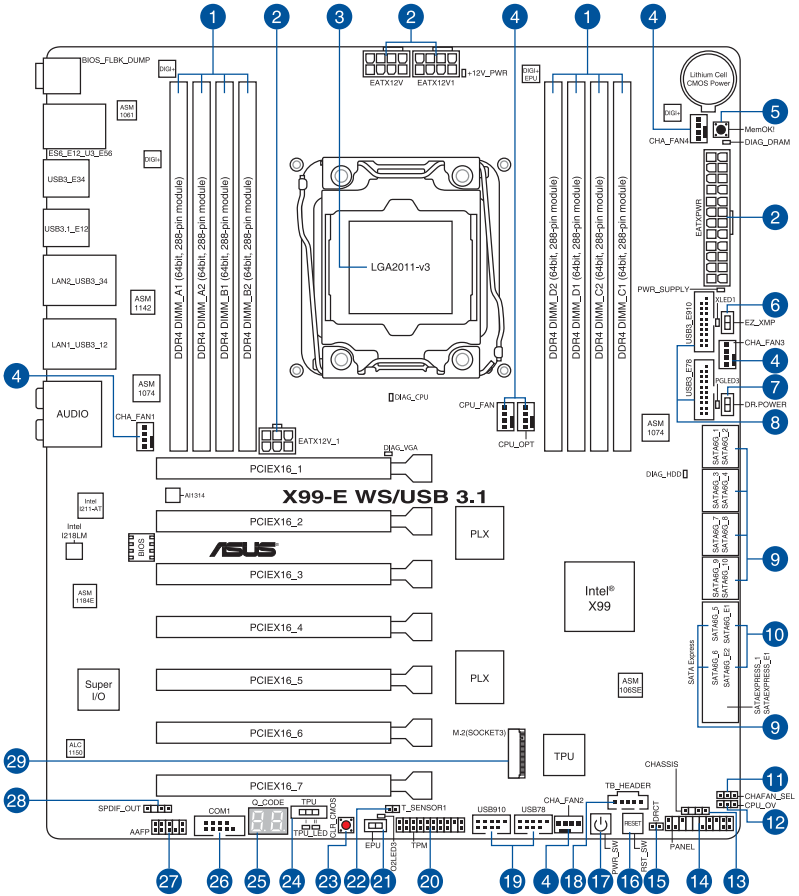

Refer to **1.2.9 Internal connectors** and **2.4.1 Rear I/O connection** for more information about rear panel connectors and internal connectors.



## Layout contents

Connectors/Jumpers/Buttons and switches/Slots	Page
1. DDR4 DIMM slots	1-7
2. ATX power connectors (24-pin EATXPWR; 8-pin EATX12V; 8-pin EATX12V1; 6-pin EATX12V_1)	1-32
3. LGA2011-v3 CPU socket	1-6
4. CPU, CPU optional, extension, and chassis fan connectors (4-pin CPU_FAN, 4-pin CPU_OPT, 4-pin CHA_FAN1-4 )	1-31
5. MemOK! button	1-13
6. EZ XMP switch	1-17
7. Dr. Power switch (DR_POWER)	1-16
8. USB 3.0 connectors (20-1 pin USB3_E78, USB3_E910)	1-29
9. Intel® Serial ATA 6 Gb/s connectors (7-pin SATA6G_12, SATA 6G_34, SATA 6G_56, SATA 6G_78, SATA6G_910)	1-27
10. ASMedia® Serial ATA 6 Gb/s connectors (7-pin SATA6G_E12/ SATAEXPRESS_E1)	1-26
11. Chassis Fan control setting jumper (3-pin CHAFAN_SEL)	1-18
12. CPU Over Voltage jumper (3-pin CPU_OV)	1-18
13. Chassis intrusion connector (4-1 pin CHASSIS)	1-36
14. System panel connector (20-8 pin PANEL)	1-33
15. DirectKey connector (2-pin DRCT)	1-34
16. Reset button	1-12
17. Power-on button	1-12
18. Thunderbolt header (5-pin TB_HEADER)	1-35
19. USB 2.0 connectors (10-1 pin USB910; USB78)	1-30
20. TPM connector (20-1 pin TPM)	1-34
21. EPU switch	1-15
22. T_Sensor connector (T_SENSOR1)	1-37
23. Clear CMOS button (CLR_CMOS)	1-16
24. TPU switch	1-14
25. Q-Code LEDs	1-22
26. Serial port connector (10-1 pin COM1)	1-26
27. Front panel audio connector (10-1 pin AAFP)	1-28
28. Digital audio connector (4-1 pin SPDIF_OUT)	1-28
29. M.2 Socket 3 connector	1-35

### 1.2.3 Central Processing Unit (CPU)

The motherboard comes with a surface mount LGA2011-v3 socket designed for Intel® Core™ i7 processors.

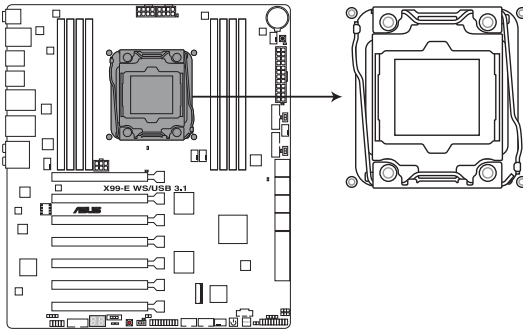

**X99-E WS/USB 3.1 CPU LGA2011-v3 Socket**



- Ensure that all power cables are unplugged before installing the CPU.
- Upon purchase of the motherboard, ensure that the PnP cap is on the socket and the socket contacts are not bent. Contact your retailer immediately if the PnP cap is missing, or if you see any damage to the PnP cap/socket contacts/motherboard components. ASUS will shoulder the cost of repair only if the damage is shipment/transit-related.
- Keep the cap after installing the motherboard. ASUS will process Return Merchandise Authorization (RMA) requests only if the motherboard comes with the cap on the LGA2011-v3 socket.
- The product warranty does not cover damage to the socket contacts resulting from incorrect CPU installation/removal, or misplacement/loss/incorrect removal of the PnP cap.

## 1.2.4 System memory

The motherboard comes with eight DDR 4 (Double Data Rate 4) Quad Inline Memory Modules (DIMM) slots.



A DDR4 module is notched differently from a DDR, DDR2, or DDR3 module. DO NOT install a DDR, DDR2, or DDR3 memory module to the DDR4 slot.

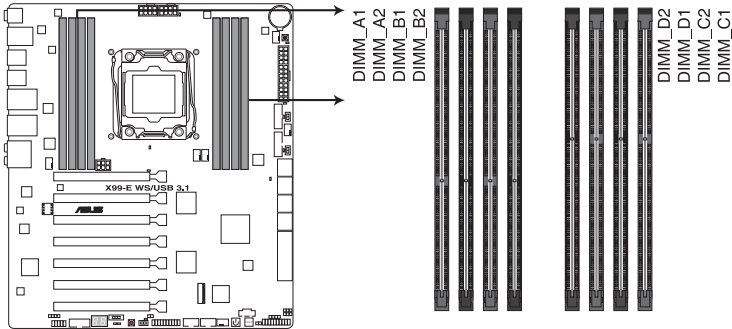

X99-E WS/USB 3.1 288-pin DDR4 DIMM socket

### Recommended memory configurations

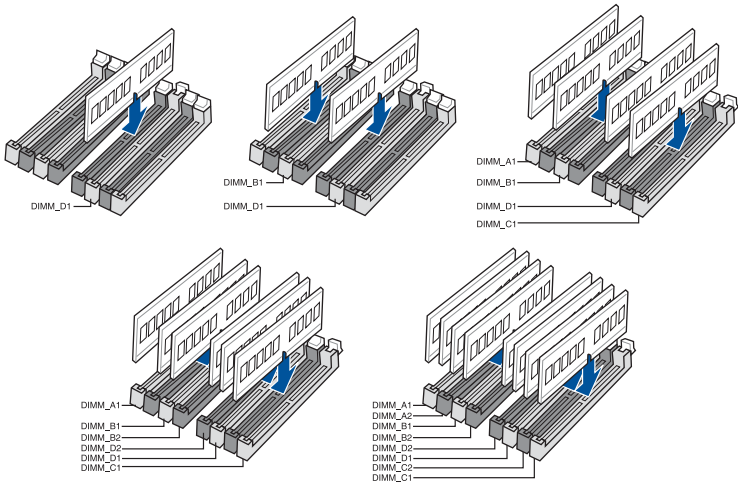

## Memory configurations

You may install 2 GB, 4 GB and 8 GB unbuffered and non-ECC DDR4 DIMMs into the DIMM sockets.



- 
- You may install varying memory sizes in Channel A, Channel B, Channel C, and Channel D. The system maps the total size of the lower-sized channel for the dual-channel configuration. Any excess memory from the higher-sized channel is then mapped for single-channel operation.
  - According to Intel® CPU spec, DIMM voltage below 1.65 V is recommended to protect the CPU.
  - Due to the memory address limitation on 32-bit Windows® OS, when you install 4GB or more memory on the motherboard, the actual usable memory for the OS can be about 3GB or less. For effective use of memory, we recommend that you do any of the following:
    - a) Use a maximum of 3GB system memory if you are using a 32-bit Windows® OS.
    - b) Install a 64-bit Windows® OS when you want to install 4 GB or more on the motherboard.
    - c) For more details, refer to the Microsoft® support site at <http://support.microsoft.com/kb/929605/en-us>.
- 



- 
- The default memory operation frequency is dependent on its Serial Presence Detect (SPD), which is the standard way of accessing information from a memory module. Under the default state, some memory modules for overclocking may operate at a lower frequency than the vendor-marked value. To operate at the vendor-marked or at a higher frequency, refer to section **3.5 Ai Tweaker menu** for manual memory frequency adjustment.
  - For system stability, use a more efficient memory cooling system to support a full memory load (8 DIMMs) or overclocking condition.
  - Memory modules with memory frequency higher than 2133MHz and their corresponding timing or the loaded XMP profile is not the JEDEC memory standard. The stability and compatibility of the memory modules depend on the CPU's capabilities and other installed devices.
  - Always install the DIMMS with the same CAS Latency. For an optimum compatibility, we recommend that you install memory modules of the same version or data code (D/C) from the same vendor. Check with the vendor to get the correct memory modules.
  - ASUS exclusively provides hyper DIMM support function.
  - Hyper DIMM support is subject to the physical characteristics of individual CPUs. Load the X.M.P. or D.O.C.P. settings in the BIOS for the hyper DIMM support.
  - Visit the ASUS website for the latest QVL.
-

## 1.2.5 Expansion slots



Unplug the power cord before adding or removing expansion cards. Failure to do so may cause you physical injury and damage motherboard components.

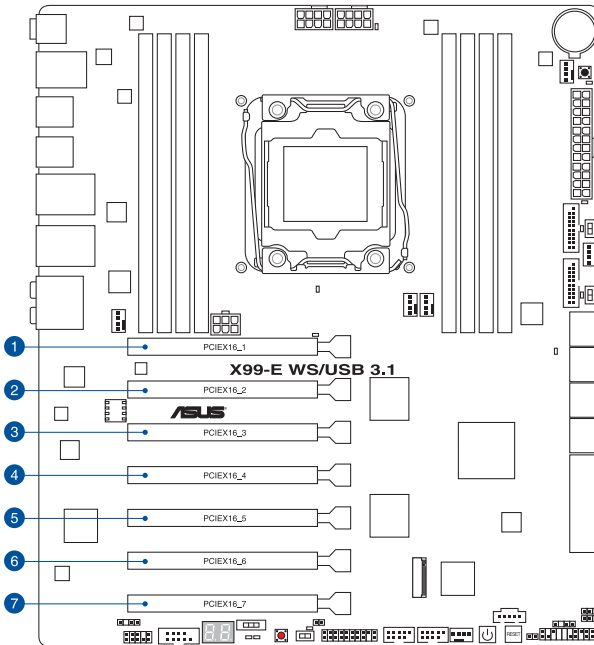

Slot No.	Slot Description	
	40-LANE	28-LANE
1	PCIe 3.0/2.0 x16_1 slot	PCIe 3.0/2.0 x16_1 slot
2	PCIe 3.0/2.0 x16_2 slot	PCIe 3.0/2.0 x16_2 slot
3	PCIe 3.0/2.0 x16_3 slot	PCIe 3.0/2.0 x16_3 slot
4	PCIe 3.0/2.0 x16_4 slot	PCIe 3.0/2.0 x16_4 slot
5	PCIe 3.0/2.0 x16_5 slot	PCIe 3.0/2.0 x16_5 slot
6	PCIe 3.0/2.0 x16_6 slot	PCIe 3.0/2.0 x16_6 slot
7	PCIe 3.0/2.0 x16_7 slot	PCIe 3.0/2.0 x16_7 slot



The default setting of PCIe x16\_2 slot is in Auto mode, which automatically optimizes the system bandwidth. ASUS Thunderbolt EX card is supported on PCIEX16\_2 slot (Gen 2) and automatically runs at x2 mode.

40-LANE/28 LANE CPU	PCI Express 3.0 operating mode						
VGA configuration	PCIe 3.0/2.0 x16_1	PCIe 3.0/2.0 x16_2	PCIe 3.0/2.0 x16_3	PCIe 3.0/2.0 x16_4	PCIe 3.0/2.0 x16_5	PCIe 3.0/2.0 x16_6	PCIe 3.0/2.0 x16_7
Single VGA/ PCIe card	x16 (single VGA recommended)	N/A	N/A	N/A	N/A	N/A	N/A
Dual VGA/PCIe cards	x16	N/A	x16	N/A	N/A	N/A	N/A
Triple VGA/ PCIe cards	x16	N/A	x16	N/A	x16	N/A	N/A
Quad VGA/ PCIe cards	x16	N/A	x16	N/A	x16	N/A	x16
Septuple VGA/ PCIe cards	x16	x8	x8	x8	x8	x8	x8



- 
- We recommend that you provide sufficient power when running CrossFireX™ or SLI™ mode.
  - Connect a chassis fan to the motherboard connector labeled CHA\_FAN1-4 when using multiple graphics cards for better thermal environment.
-

## IRQ assignments for this motherboard

	A	B	C	D	E	F	G	H
PCIe x16_1	shared	-	-	-	-	-	-	-
PCIe x16_2	-	shared	-	-	-	-	-	-
PCIe x16_3	-	shared	-	-	-	-	-	-
PCIe x16_4	shared	-	-	-	-	-	-	-
PCIe x16_5	shared	-	-	-	-	-	-	-
PCIe x16_6	shared	-	-	-	-	-	-	-
PCIe x16_7	shared	-	-	-	-	-	-	-
SMBUS Controller	-	-	shared	-	-	-	-	-
Intel® SATA Controller 1	-	-	-	shared	-	-	-	-
Intel® SATA Controller 2	shared	-	-	-	-	-	-	-
Intel® LAN1 (i218LM)	-	-	-	-	shared	-	-	-
Intel® LAN2 (i210)	shared	-	-	-	-	-	-	-
ASMedia SATA Controller (106SE)	shared	-	-	-	-	-	-	-
ASMedia SATA Controller (1061)	shared	-	-	-	-	-	-	-
Intel® xHCI	-	-	-	-	-	-	-	shared
Intel® EHCI 1	-	-	-	-	-	shared	-	-
Intel® EHCI 2	-	-	shared	-	-	-	-	-
HD Audio	-	-	-	-	-	-	shared	-
ASMedia Controller (1142)	-	-	shared	-	-	-	-	-

## 1.2.6 Onboard buttons and switches

Onboard buttons and switches allow you to fine-tune performance when working on a bare or open-case system. This is ideal for overclockers and gamers who continually change settings to enhance system performance.

### 1. Power-on button

The motherboard comes with a power-on button that allows you to power up or wake up the system. The button also lights up when the system is plugged to a power source indicating that you should shut down the system and unplug the power cable before removing or installing any motherboard component.

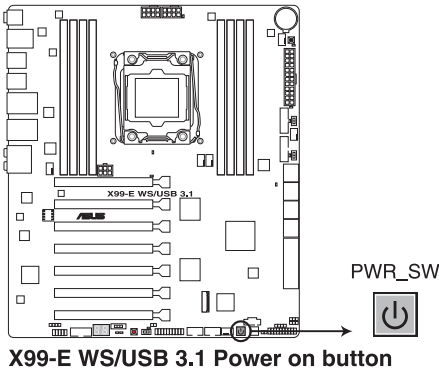

### 2. Reset button

Press the reset button to reboot the system.

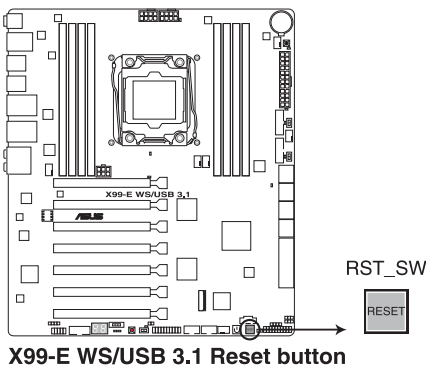



### 3. MemOK! button

Installing DIMMs that are not compatible with the motherboard may cause system boot failure, and the DIAG\_DRAM LED near the MemOK! button lights continuously. Press and hold the MemOK! button until the DIAG\_DRAM LED starts blinking to begin automatic memory compatibility tuning for successful boot.

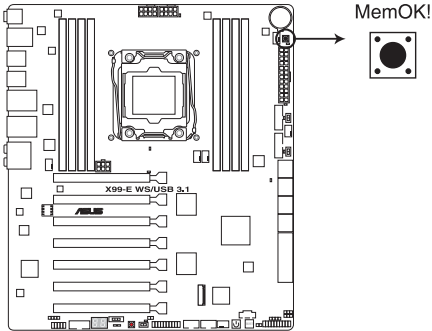

**X99-E WS/USB 3.1 MemOK! button**



- Refer to section **1.2.8 Onboard LEDs** for the exact location of the DIAG\_DRAM LED.
- The DIAG\_DRAM LED also lights up when the DIMM is not properly installed. Turn off the system and reinstall the DIMM before using the MemOK! function.
- The MemOK! button does not function under Windows® OS environment.
- During the tuning process, the system loads and tests failsafe memory settings. It takes about 30 seconds for the system to test one set of failsafe settings. If the test fails, the system reboots and test the next set of failsafe settings. The blinking speed of the DIAG\_DRAM LED increases, indicating different test processes.
- Due to memory tuning requirement, the system automatically reboots when each timing set is tested. If the installed DIMMs still fail to boot after the whole tuning process, the DIAG\_DRAM LED lights continuously. Replace the DIMMs with ones recommended in the Memory QVL (Qualified Vendors Lists) in this user manual or at [www.asus.com](http://www.asus.com).
- If you turn off the computer and replace DIMMs during the tuning process, the system continues memory tuning after turning on the computer. To stop memory tuning, turn off the computer and unplug the power cord for about 5–10 seconds.
- If your system fails to boot up due to BIOS overlocking, press the MemOK! button to boot and load the BIOS default settings. A message will appear during POST reminding you that the BIOS has been restored to its default settings.
- We recommend that you download and update to the latest BIOS version from [www.asus.com](http://www.asus.com) after using the MemOK! function.

#### 4. TPU switch

With its two-level adjustment functions, the TPU allows you to automatically adjust the CPU ratio and clock speed for an optimal system performance.



- Enable this switch when the system is powered off.
- When the TPU switch is set to Enabled (TPU\_I: CPU Ratio Boost), the system automatically adjusts the CPU ratio for an enhanced performance.
- When the TPU switch is set to Enabled (TPU\_II: CPU BCLK and Ratio Boost), the system automatically adjusts the base clock rate (BCLK) and the CPU ratio for a more enhanced performance.

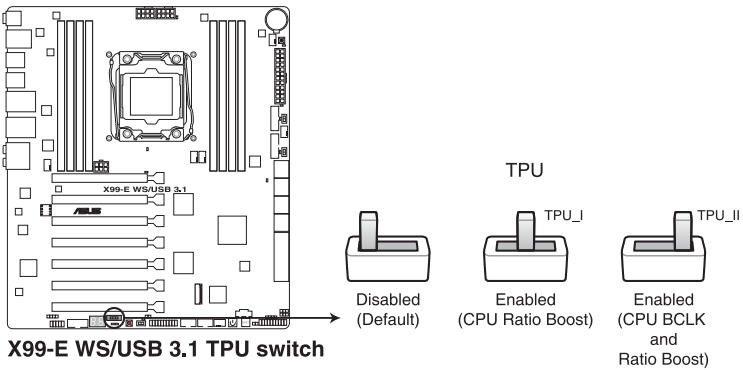

- The TPU LEDs (TPU\_LED) near the TPU switch light up when you set the TPU switch to TPU\_I mode or TPU\_II mode. Refer to section 1.2.8 Onboard LEDs for the exact location of the TPU LEDs.
- If you enable this switch under Windows® OS environment, the TPU function will be activated after the next system bootup.
- You may use the 5-Way Optimization and TPU feature in the AI Suite 3 application, adjust the BIOS setup program or enable the TPU switch at the same time. However, the system will use the last setting you have made.

## 5. EPU switch

Enable this switch to automatically detect the current PC loadings and intelligently moderate the power consumption.



---

Enable this switch when the system is powered off.

---

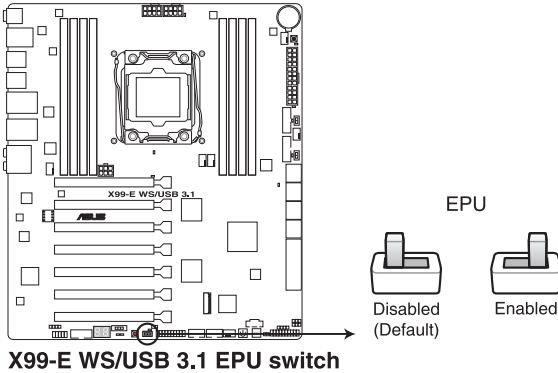

- The EPU LED (O2LED3) near the EPU switch lights up when you enable the EPU switch. Refer to section **1.2.8 Onboard LEDs** for the exact location of the EPU LED.
- If you enable this switch under Windows® OS environment, the EPU function will be activated after the next system bootup.
- You may change the EPU settings in the software application or BIOS setup program and enable the EPU function at the same time. However, the system will use the last setting you have made.

**6. Clear CMOS button (CLR\_CMOS)**

Press this button to clear the BIOS setup information only when the systems hangs due to overclocking.

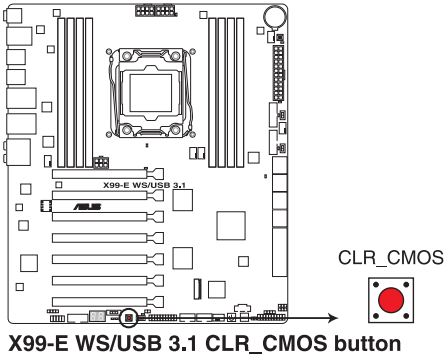

**7. Dr. Power switch (DR\_POWER)**

This switch allows you to enable or disable the ASUS Dr. Power feature. Install the bundled ASUS Dr. Power Utility then enable this switch to allow the system to display notification messages in your Windows screen if a problem is detected with your Power Supply Unit (PSU).

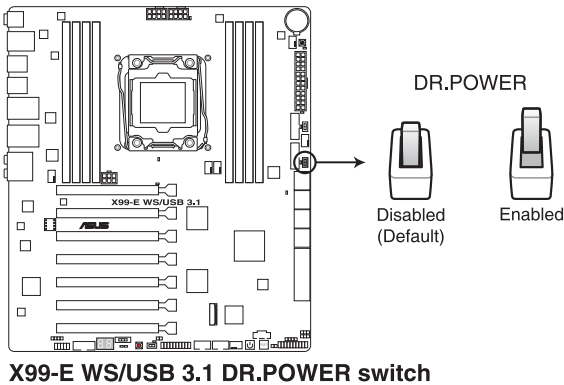

The PGLED3 LED near the Dr. Power switch lights up when you enable the Dr. Power switch. Refer to section 1.2.8 Onboard LEDs for the exact location of the PGLED3 LED.

## 8. EZ XMP switch

Enable this switch to overclock the installed DIMMs, allowing you to enhance the DIMM's speed and performance.

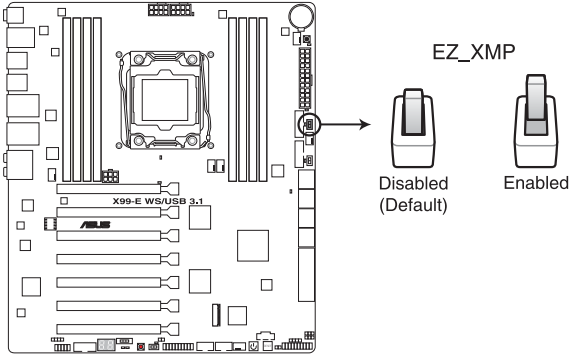

**X99-E WS/USB 3.1 EZ\_XMP switch**



The EZ XMP LED (XLED1) lights up when you enable the EZ XMP switch. For the location of the EZ XMP LED, refer to section 1.2.8 Onboard LEDs.

## 1.2.7 Jumpers

### 1. CPU Over Voltage jumper (3-pin CPU\_OV)

The CPU Over Voltage jumper allows you to set a higher CPU voltage for a flexible overclocking system, depending on the type of the installed CPU. To gain more CPU voltage setting, insert the jumper to pins 2-3. To go back to its default CPU voltage setting, insert the jumper to pins 1-2.

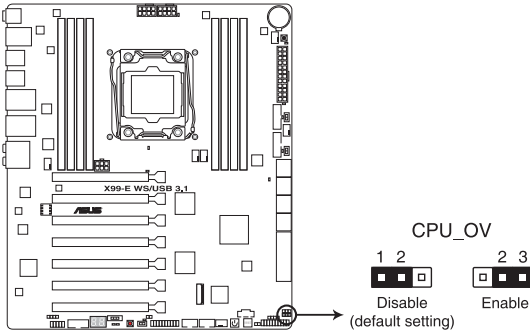

**X99-E WS/USB 3.1 CPU\_OV setting**

### 2. Chassis Fan control setting jumper (3-pin CHAFAN\_SEL)

These jumpers allow you to switch fan pin selection. The CHAFAN\_SEL jumper is for the front fans and rear fans control. Set pins 1-2 to let the BIOS control the settings of the chassis fans. Set pins 2-3 to control the settings of the 4-pin PWM fans.

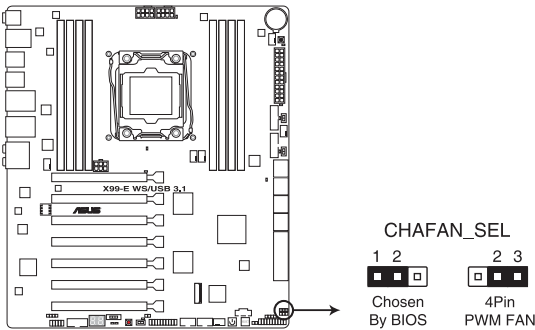

**X99-E WS/USB 3.1 CHAFAN setting**

## 1.2.8 Onboard LEDs

### 1. Diagnosis LEDs

The Diagnosis LEDs provide the status of these key components during POST (Power-On-Self Test): CPU, memory modules, VGA card, and hard disk drives. If an error is found, the critical component's LED stays lit up until the problem is solved.

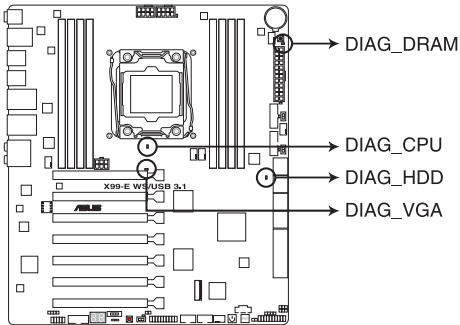

**X99-E WS/USB 3.1 Diagnosis LED**

### 2. TPU LED (TPU\_LED)

The TPU LED lights up when the TPU switch is enabled.

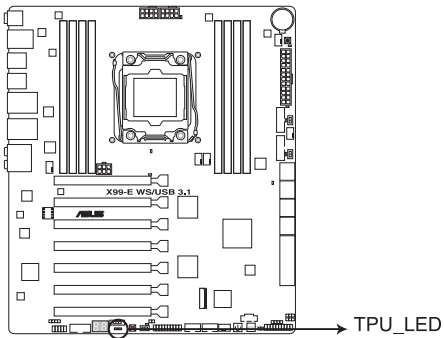

**X99-E WS/USB 3.1 TPU LED**

### 3. EPU LED (O2LED3)

The EPU LED lights up when the EPU switch is enabled.

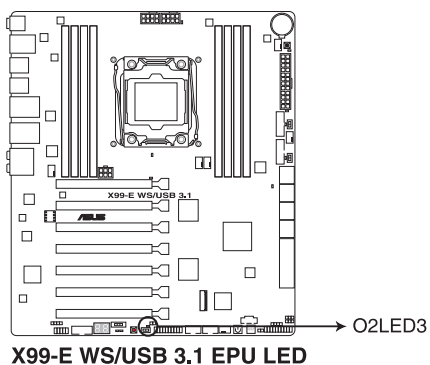

### 4. EZ XMP LED (XLED1)

This LED lights up when you enable the EZ XMP switch.

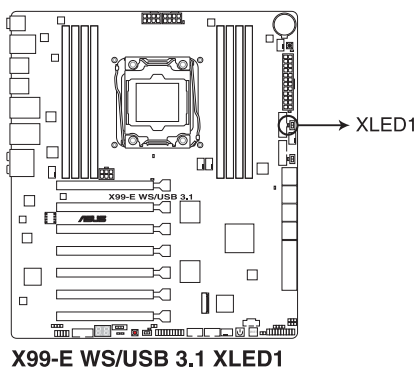



**5. ASUS Dr. Power LED (PGLED3)**

This LED near the Dr. Power switch lights up when the Dr. Power switch is enabled.

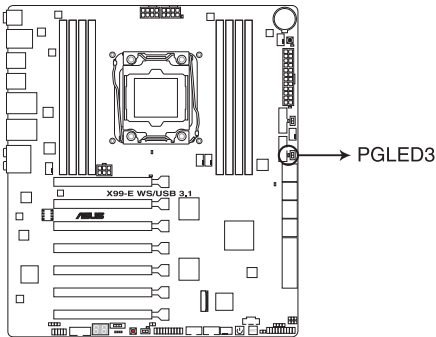

**X99-E WS/USB 3.1 PGLED3**

**6. PWR\_SUPPLY LED**

The ASUS Dr. Power LED near the EATX PWR connector lights up when the ASUS Dr. Power switch setting is on and the power supply unit has failed.

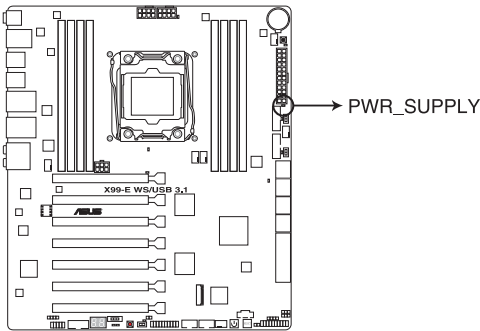

**X99-E WS/USB 3.1 PWR\_SUPPLY LED**

## 7. Power LED (+12V\_PWR LED)

The Power LED near the EATX12V1 connector lights up when you enable the ASUS Dr. Power switch and if there is no power detected on the 8-pin EATX12V connector.

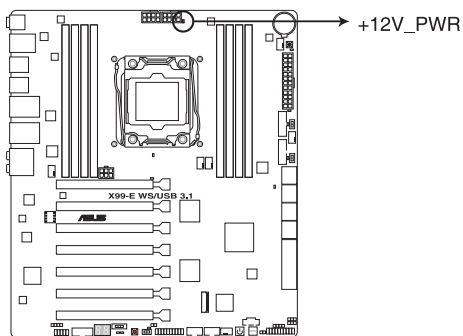

**X99-E WS/USB 3.1 +12V\_PWR LED**

## 8. Q-Code LEDs

The Q-Code LED design provides you with a 2-digit error code that displays the system status. Refer to the Q-Code table on the next page for details.

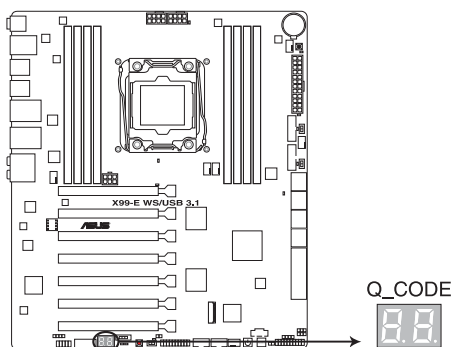

**X99-E WS/USB 3.1 Q-Code LED**

## Q-Code table

Code	Description
00	Not used
02	microcode
03	CACHE_ENABLED
04	PCH initialization
06	CPU_EARLY_INIT
10	PEI Core is started
11 – 14	Pre-memory CPU initialization is started
15 – 18	Pre-memory System Agent initialization is started
19 – 1C	Pre-memory PCH initialization is started
2B – 2F	Memory initialization
30	Reserved for ASL (see ASL Status Codes section below)
31	Memory Installed
32 – 36	CPU post-memory initialization
37 – 3A	Post-Memory System Agent initialization is started
3B – 3E	Post-Memory PCH initialization is started
4F	DXE IPL is started
50 – 53	Memory initialization error. Invalid memory type or incompatible memory speed
4F	DXE IPL is started
54	Unspecified memory initialization error
55	Memory not installed
56	Invalid CPU type or Speed
57	CPU mismatch
58	CPU self test failed or possible CPU cache error
59	CPU micro-code is not found or micro-code update is failed
5A	Internal CPU error
5B	Reset PPI is not available
5C – 5F	Reserved for future AMI error codes
E0	S3 Resume is started (S3 Resume PPI is called by the DXE IPL)
E1	S3 Boot Script execution
E2	Video repost
E3	OS S3 wake vector call
E4 – E7	Reserved for future AMI progress codes
E8	S3 Resume Failed
E9	S3 Resume PPI not Found
EA	S3 Resume Boot Script Error
EB	S3 OS Wake Error
EC – EF	Reserved for future AMI error codes
F0	Recovery condition triggered by firmware (Auto recovery)
F1	Recovery condition triggered by user (Forced recovery)
F2	Recovery process started
F3	Recovery firmware image is found
F4	Recovery firmware image is loaded
F5 – F7	Reserved for future AMI progress codes
F8	Recovery PPI is not available
F9	Recovery capsule is not found

(continued on the next page)

Code	Description
FA	Invalid recovery capsule
FB – FF	Reserved for future AMI error codes
60	DXE Core is started
61	NVRAM initialization
62	Installation of the PCH Runtime Services
63 – 67	CPU DXE initialization is started
68	PCI host bridge initialization
69	System Agent DXE initialization is started
6A	System Agent DXE SMM initialization is started
6B – 6F	System Agent DXE initialization (System Agent module specific)
70	PCH DXE initialization is started
71	PCH DXE SMM initialization is started
72	PCH devices initialization
73 – 77	PCH DXE Initialization (PCH module specific)
78	ACPI module initialization
79	CSM initialization
7A – 7F	Reserved for future AMI DXE codes
90	Boot Device Selection (BDS) phase is started
91	Driver connecting is started
92	PCI Bus initialization is started
93	PCI Bus Hot Plug Controller Initialization
94	PCI Bus Enumeration
95	PCI Bus Request Resources
96	PCI Bus Assign Resources
97	Console Output devices connect
98	Console input devices connect
99	Super IO Initialization
9A	USB initialization is started
9B	USB Reset
9C	USB Detect
9D	USB Enable
9E – 9F	Reserved for future AMI codes
A0	IDE initialization is started
A1	IDE Reset
A2	IDE Detect
A3	IDE Enable
A4	SCSI initialization is started
A5	SCSI Reset
A6	SCSI Detect
A7	SCSI Enable
A8	Setup Verifying Password
A9	Start of Setup
AA	Reserved for ASL (see ASL Status Codes section below)
AB	Setup Input Wait

(continued on the next page)

Code	Description
AC	Reserved for ASL (see ASL Status Codes section below)
AD	Ready To Boot event
AE	Legacy Boot event
AF	Exit Boot Services event
B0	Runtime Set Virtual Address MAP Begin
B1	Runtime Set Virtual Address MAP End
B2	Legacy Option ROM Initialization
B3	System Reset
B4	USB hot plug
B5	PCI bus hot plug
B6	Clean-up of NVRAM
B7	Configuration Reset (reset of NVRAM settings)
B8–BF	Reserved for future AMI codes
D0	CPU initialization error
D1	System Agent initialization error
D2	PCH initialization error
D3	Some of the Architectural Protocols are not available
D4	PCI resource allocation error. Out of Resources
D5	No Space for Legacy Option ROM
D6	No Console Output Devices are found
D7	No Console Input Devices are found
D8	Invalid password
D9	Error loading Boot Option (LoadImage returned error)
DA	Boot Option is failed (StartImage returned error)
DB	Flash update is failed
DC	Reset protocol is not available

#### ACPI/ASL Checkpoints (under OS)

Code	Description
03	System is entering S3 sleep state
04	System is entering S4 sleep state
05	System is entering S5 sleep state
30	System is waking up from the S3 sleep state
40	System is waking up from the S4 sleep state
AC	System has transitioned into ACPI mode. Interrupt controller is in PIC mode.
AA	System has transitioned into ACPI mode. Interrupt controller is in APIC mode.

## 1.2.9 Internal connectors

### 1. ASMedia® Serial ATA 6 Gb/s connectors (7-pin SATA6G\_E12/SATAEXPRESS\_E1)

These connectors connect to Serial ATA 6 Gb/s hard disk drives via Serial ATA 6 Gb/s signal cables.

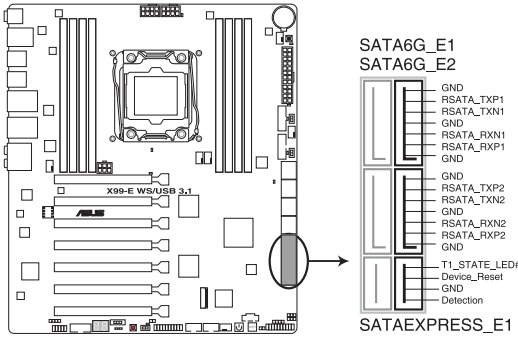

**X99-E WS/USB 3.1 ASMedia® SATA 6 Gb/s connectors**



- ASMedia storage controller can only support AHCI mode.
- These SATA ports are for data drives only.
- The SATAEXPRESS\_E1 connector can support one SATA Express device or two SATA devices.

### 2. Serial port connector (10-1 pin COM1)

This connector is for the serial (COM) port. Connect the serial port module cable to one of these connectors, then install the module to a slot opening at the back of the system chassis.

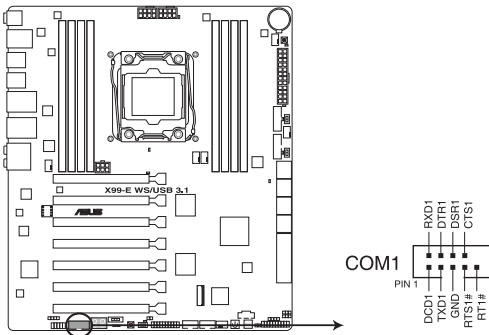

**X99-E WS/USB 3.1 Serial port connector**

### 3. Intel® X99 Serial ATA 6 Gb/s connectors (7-pin SATA6G\_12, SATA6G\_34, SATA6G\_56/SATAEXPRESS\_1, SATA6G\_78, SATA6G\_910)

These connectors connect to Serial ATA 6 Gb/s hard disk drives via Serial ATA 6 Gb/s signal cables.

If you installed Serial ATA hard disk drives, you can create a RAID 0, 1, 5, and 10 configuration with the Intel® Rapid Storage Technology through the onboard Intel® X99 chipset.

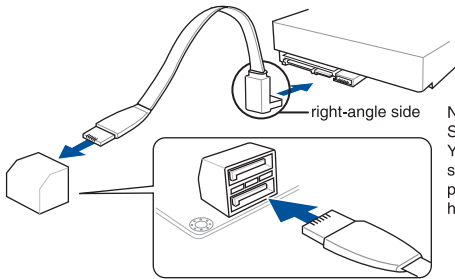
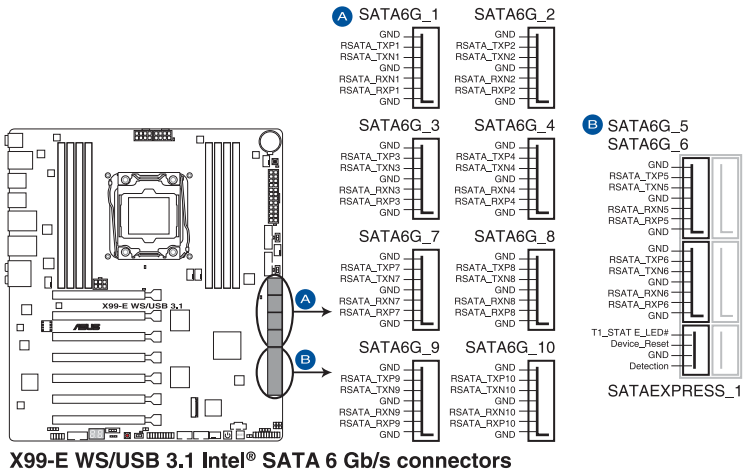

NOTE: Connect the right-angle side of SATA signal cable to SATA device. You may also connect the right-angle side of SATA cable to the onboard SATA port to avoid mechanical conflict with huge graphics cards.



- These connectors are set to **[AHCI Mode]** by default. If you intend to create a Serial ATA RAID set using these connectors, set the SATA Mode item in the BIOS to **[RAID Mode]**. Refer to section **3.6.3 PCH Storage Configuration** for details.
- Before creating a RAID set, refer to the manual bundled in the motherboard support DVD.



- The SATAEXPRESS\_1 connector can support one SATA Express device or two SATA devices.
- Due to chipset behavior, the SATA6G\_78 and SATA6G\_910 ports (black) do not support Intel® Rapid Storage Technology and RAID configuration.

#### 4. Digital audio connector (4-1 pin SPDIF\_OUT)

This connector is for an additional Sony/Philips Digital Interface (S/PDIF) port. Connect the S/PDIF Out module cable to this connector, then install the module to a slot opening at the back of the system chassis.

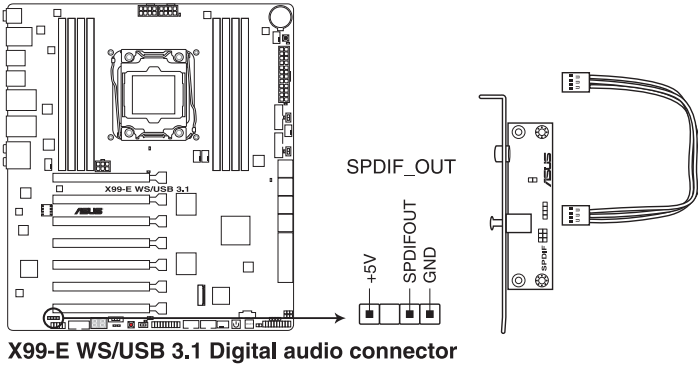

**X99-E WS/USB 3.1 Digital audio connector**



The S/PDIF module is purchased separately.

#### 5. Front panel audio connector (10-1 pin AAFP)

This connector is for a chassis-mounted front panel audio I/O module that supports either HD Audio or legacy AC '97 audio standard. Connect one end of the front panel audio I/O module cable to this connector.

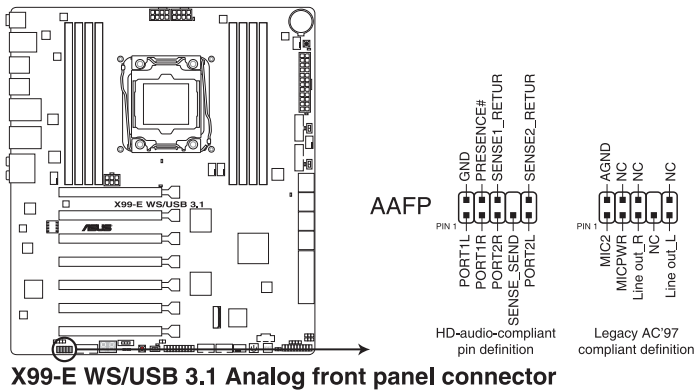

**X99-E WS/USB 3.1 Analog front panel connector**



- We recommend that you connect a high-definition front panel audio module to this connector to avail of the motherboard's high-definition audio capability.
- If you want to connect a high-definition or an AC'97 front panel audio module to this connector, set the Front Panel Type item in the BIOS setup to **[HD]** or **[AC97]**.



## 6. USB 3.0 connectors (20-pin USB3\_E910, USB3\_E78)

These connectors allow you to connect a USB 3.0 module for additional USB 3.0 front or rear panel ports. With an installed USB 3.0 module, you can enjoy all the benefits of USB 3.0 including faster data transfer speeds of up to 5 Gb/s, faster charging time for USB-chargeable devices, optimized power efficiency, and backward compatibility with USB 2.0.

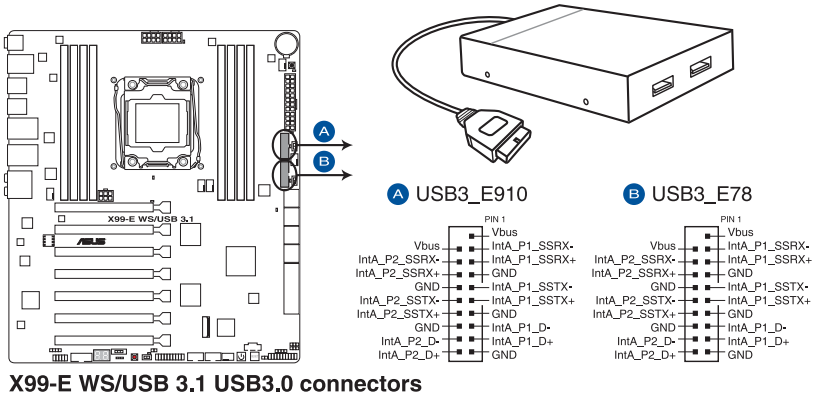

**X99-E WS/USB 3.1 USB3.0 connectors**



The USB 3.0 module is purchased separately.



- Ensure to install the related driver to fully use the USB 3.0 ports under Windows® 7.
- The plugged USB 3.0 device may run on xHCI or EHCI mode depending on the operating system's setting.
- These USB 3.0 ports support native UASP transfer standard in Windows® 8 / Windows® 8.1 and Turbo Mode when using USB 3.0 Boost feature.

## 7. USB 2.0 connectors (10-1 pin USB910; USB78)

These connectors are for USB 2.0 ports. Connect the USB module cable to any of these connectors, then install the module to a slot opening at the back of the system chassis. These USB connectors comply with USB 2.0 specification that supports up to 48 Mb/s connection speed.

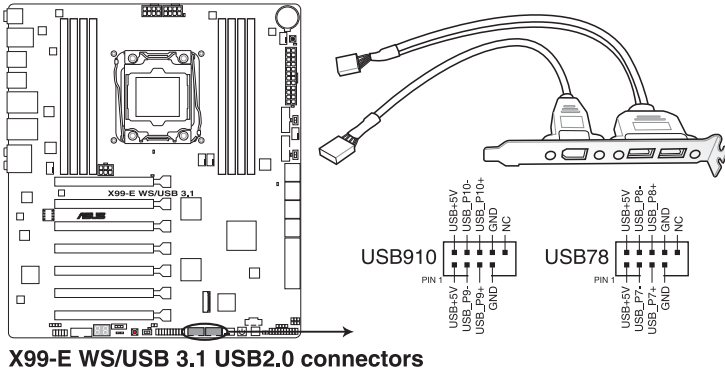

DO NOT connect a 1394 cable to the USB connectors. Doing so will damage the motherboard!



You can connect the front panel USB cable to the ASUS Q-Connector (USB) first, and then install the Q-Connector (USB) to the USB connector onboard if your chassis supports front panel USB ports.



The USB 2.0 module is purchased separately.

## 8. CPU, CPU optional, and chassis fan connectors (4-pin CPU\_FAN; 4-pin CPU\_OPT; 4-pin CHA\_FAN1-4)

Connect the fan cables to the fan connectors on the motherboard, ensuring that the black wire of each cable matches the ground pin of the connector.



- DO NOT forget to connect the fan cables to the fan connectors. Insufficient air flow inside the system may damage the motherboard components. These are not jumpers! Do not place jumper caps on the fan connectors!
- Ensure that the CPU fan cable is securely installed to the CPU fan connector.

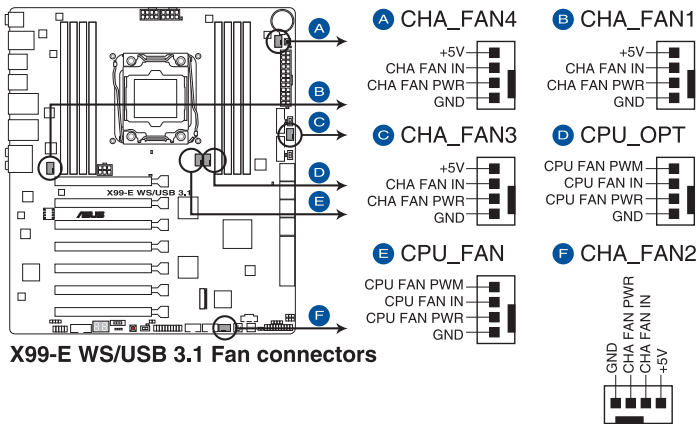

- The CPU\_FAN connector supports the CPU fan of maximum 1A (12 W) fan power.
- The CPU\_FAN and CHA\_FAN connectors support the ASUS FAN Xpert 3 feature on X99 platform.
- The CPU fan connector detects the type of CPU fan installed and automatically switches the control modes. To configure the CPU fan's control mode, go to **Advanced Mode > Monitor > CPU Q-Fan Control** item in BIOS.
- The chassis fan connectors support DC and PWM modes. To set these fans to DC or PWM, go to **Advanced Mode > Monitor > Chassis Fan 1/4 Q-Fan Control** items in BIOS.

**9. ATX power connectors (24-pin EATXPWR; 8-pin EATX12V; 8-pin EATX12V1; 6-pin EATX12V\_1)**

These connectors are for ATX power supply plugs. The power supply plugs are designed to fit these connectors in only one orientation. Find the proper orientation and push down firmly until the connectors completely fit.

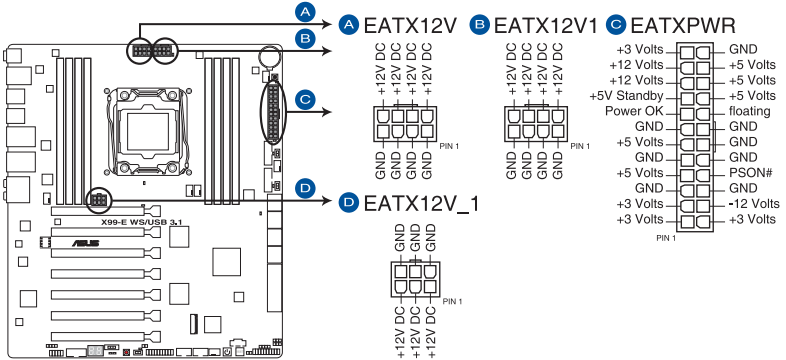

**X99-E WS/USB 3.1 ATX power connectors**



- For a fully configured system, we recommend that you use a power supply unit (PSU) that complies with ATX 12 V Specification 2.0 (or later version) and provides a minimum power of 350 W.
- DO NOT forget to connect the 4-pin/8-pin EATX12 V power plug. Otherwise, the system will not boot.
- We recommend that you use a PSU with a higher power output when configuring a system with more power-consuming devices. The system may become unstable or may not boot up if the power is inadequate.
- If you want to use two or more high-end PCI Express x16 cards, use a PSU with 1000W power or above to ensure the system stability.

## 10. System panel connector (20-8 pin PANEL)

This connector supports several chassis-mounted functions.

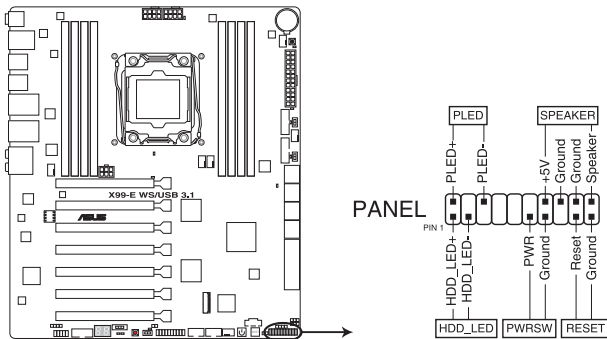

**X99-E WS/USB 3.1 System panel connector**

- **System power LED (2-pin PLED)**

This 2-pin connector is for the system power LED. Connect the chassis power LED cable to this connector. The system power LED lights up when you turn on the system power, and blinks when the system is in sleep mode.

- **Hard disk drive activity LED (2-pin HDD\_LED)**

This 2-pin connector is for the HDD Activity LED. Connect the HDD Activity LED cable to this connector. The HDD LED lights up or flashes when data is read from or written to the HDD.

- **System warning speaker (4-pin SPEAKER)**

This 4-pin connector is for the chassis-mounted system warning speaker. The speaker allows you to hear system beeps and warnings.

- **ATX power button/soft-off button (2-pin PWRSW)**

This connector is for the system power button. Pressing the power button turns the system on or puts the system in sleep or soft-off mode depending on the operating system settings. Pressing the power switch for more than four seconds while the system is ON turns the system OFF.

- **Reset button (2-pin RESET)**

This 2-pin connector is for the chassis-mounted reset button for system reboot without turning off the system power.

### 11. TPM connector (20-pin TPM)

This connector supports a Trusted Platform Module (TPM) system, which securely store keys, digital certificates, passwords and data. A TPM system also helps enhance network security, protect digital identities, and ensures platform integrity.

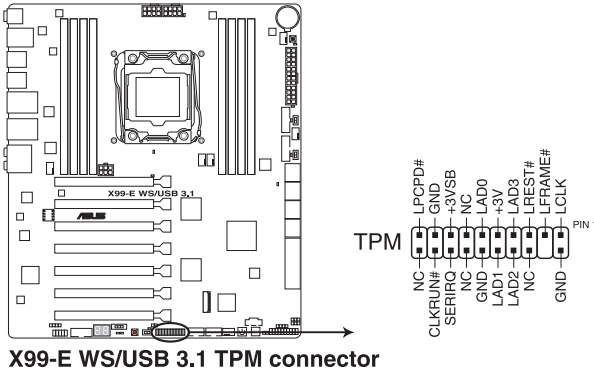

The TPM module is purchased separately.

### 12. DirectKey connector (2-pin DRCT)

This connector is for the chassis-mounted button that supports the DirectKey function. Connect the button cable that supports DirectKey, from the chassis to this connector on the motherboard.

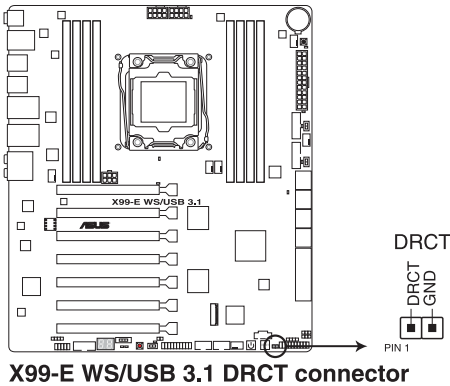

Ensure that your chassis comes with the extra button cable that supports the DirectKey feature. Refer to the technical documentation that came with the chassis for details.

### 13. Thunderbolt header (5-pin TB\_HEADER)

This connector is for the add-on Thunderbolt I/O card that supports Intel's Thunderbolt Technology, allowing you to connect up to six Thunderbolt-enabled devices and a DisplayPort-enabled display in a daisy-chain configuration.

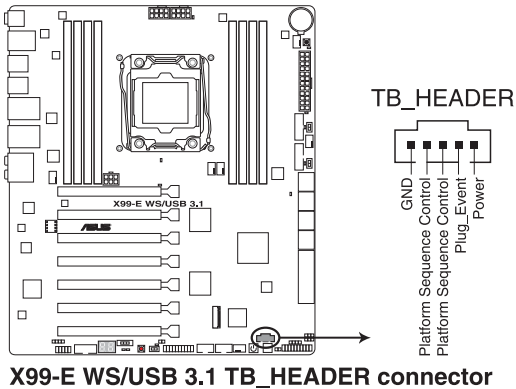

The add-on Thunderbolt I/O card and Thunderbolt cables are purchased separately.

### 14. M.2 socket 3

This socket allows you to install an M.2 (NGFF) SSD module.

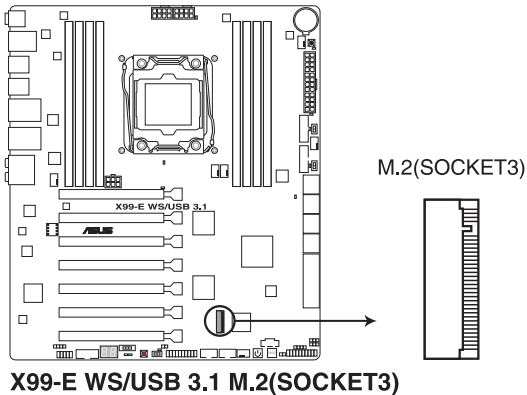

- This socket supports M Key and type 2260/2280 storage devices.
- This socket supports PCIe mode only.

### 15. Chassis intrusion connector (4-1 pin CHASSIS)

This connector is for a chassis-mounted intrusion detection sensor or switch. Connect one end of the chassis intrusion sensor or switch cable to this connector. The chassis intrusion sensor or switch sends a high-level signal to this connector when a chassis intrusion sensor is removed or replaced. The signal is then generated as a chassis intrusion event.

By default, the pin labeled “Chassis Signal” and “Ground” are shorted with a jumper cap. Remove the jumper caps and enable the related options in BIOS if you intend to use the chassis intrusion detection feature.

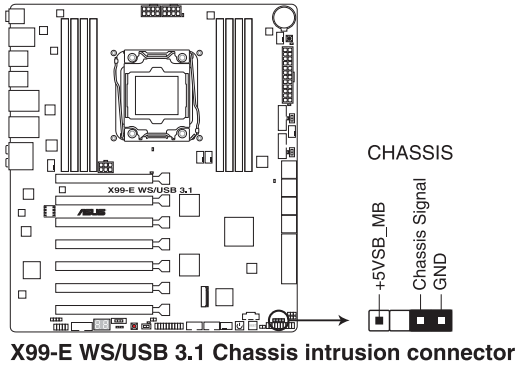

**X99-E WS/USB 3.1 Chassis intrusion connector**



---

A message appears when you connect the sensor or switch at the first time or when you reconnect the sensor or switch to this connector. Reset the system to exit the message.

---



## 16. T\_Sensor connector (2-pin T\_SENSOR1)

This connector is for the thermistor cable that allows you to monitor the temperature of your motherboard's critical components and connected devices.

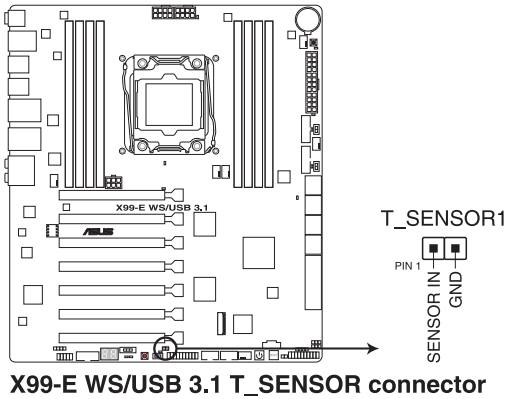

The thermistor cable is purchased separately.



# Basic Installation

# 2

## 2.1 Building your PC system



The diagrams in this section are for reference only. The motherboard layout may vary with models, but the installation steps are the same for all models.

### 2.1.1 Motherboard installation

1. Install the ASUS Q-Shield to the chassis rear I/O panel.

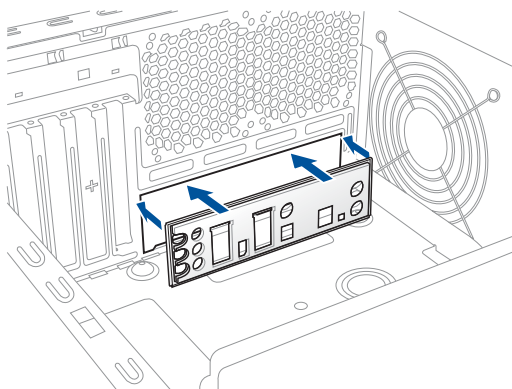

2. Place the motherboard into the chassis, ensuring that its rear I/O ports are aligned to the chassis' rear I/O panel.

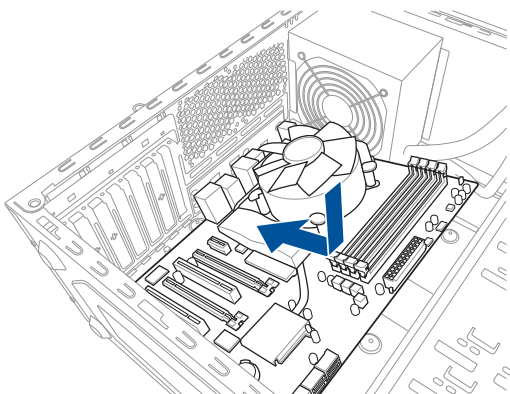

- Place nine screws into the holes indicated by circles to secure the motherboard to the chassis.

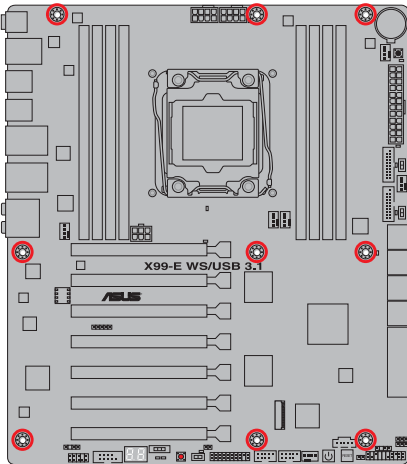
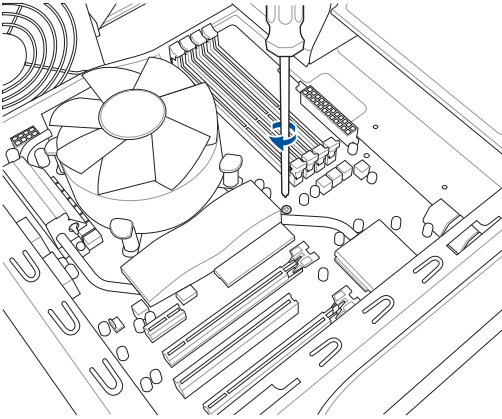

DO NOT overtighten the screws! Doing so can damage the motherboard.

## 2.1.2 CPU installation



Please note the order in opening/ closing the double latch. Follow the instructions printed on the metal sealing hatch or the illustrations shown below in this manual. The plastic cap will pop up automatically once the CPU is in place and the hatch properly sealed down.

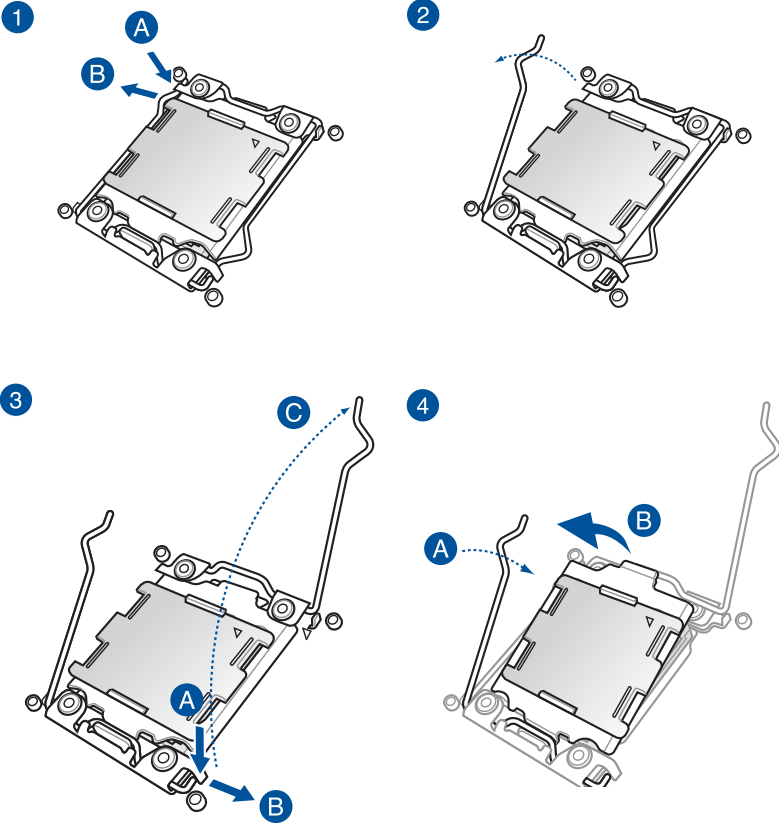

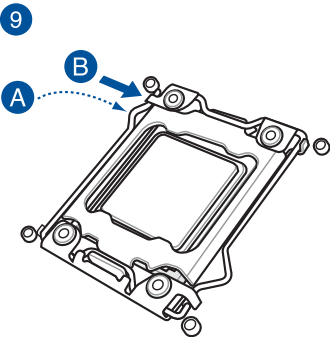
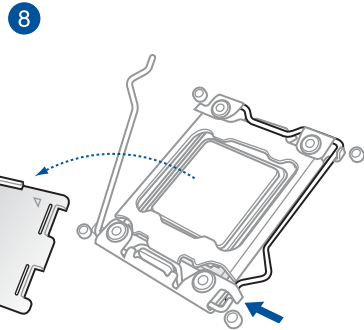
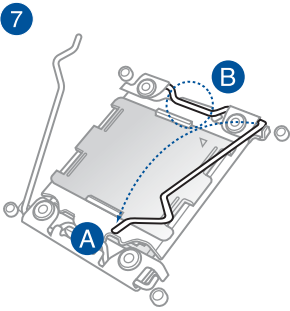
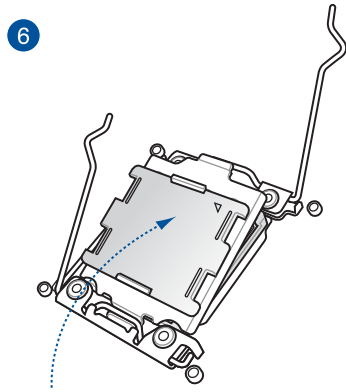
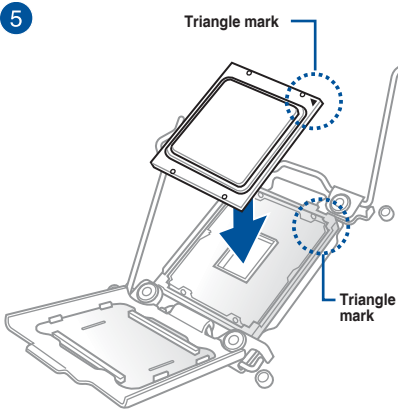

## 2.1.3 CPU heatsink and fan assembly installation

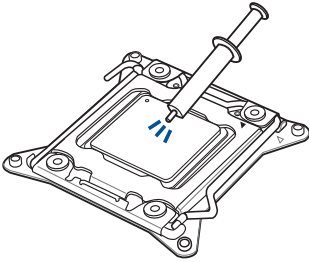

Apply the Thermal Interface Material to the CPU heatsink and CPU before you install the heatsink and fan, if necessary.

To install the CPU heatsink and fan assembly

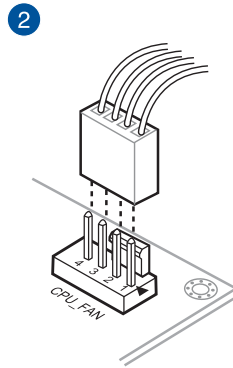
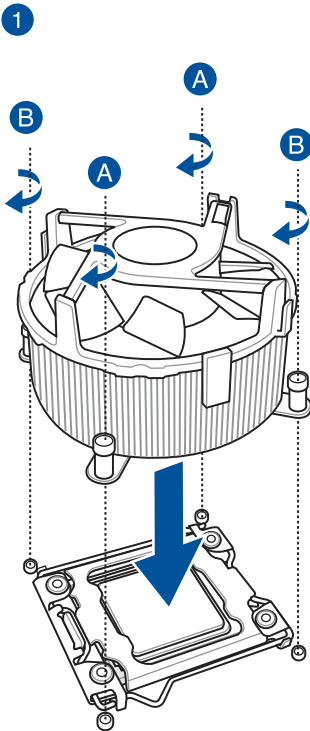

## 2.1.4 DIMM installation

1

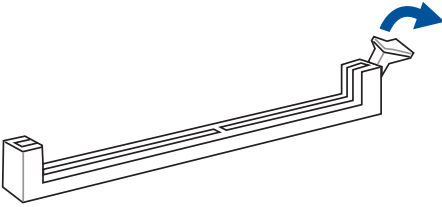

2

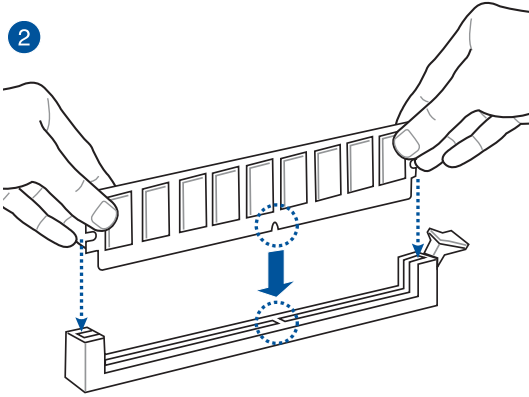

3

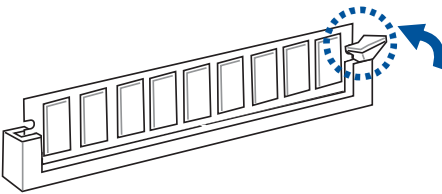

To remove a DIMM

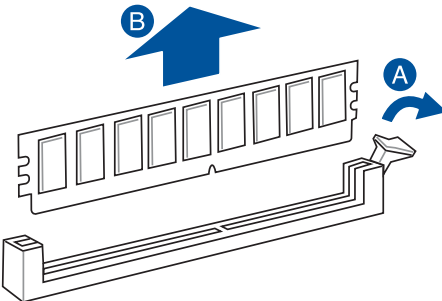



## 2.1.5 ATX Power connection

1

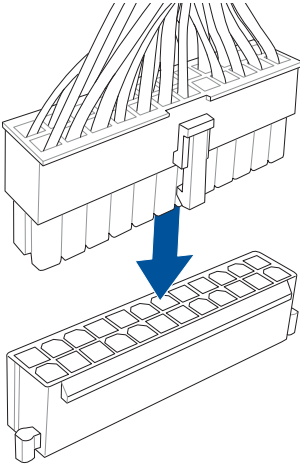

2

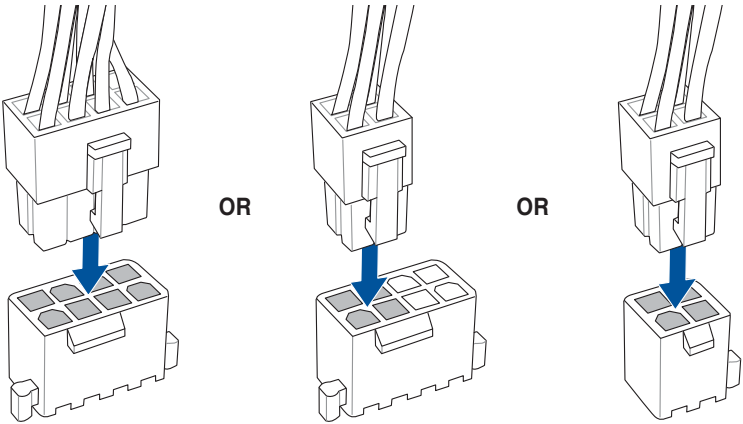

## 2.1.6 SATA device connection

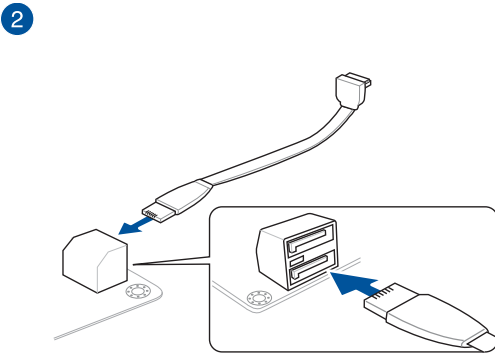
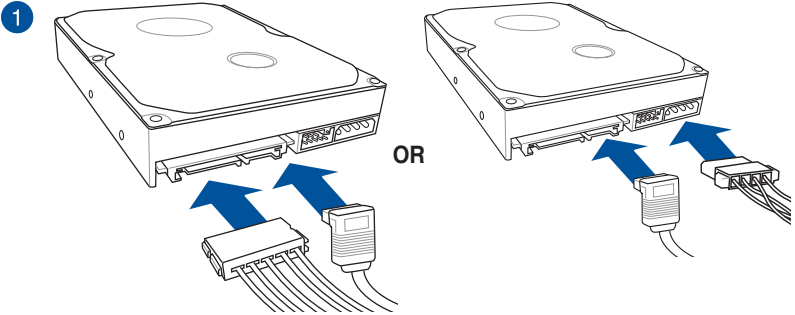

## 2.1.7 Front I/O Connector

### To install ASUS Q-Connector

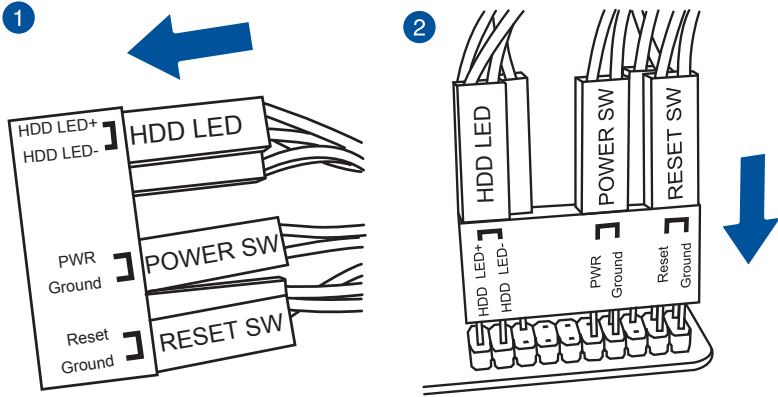

### To install USB 2.0 connector

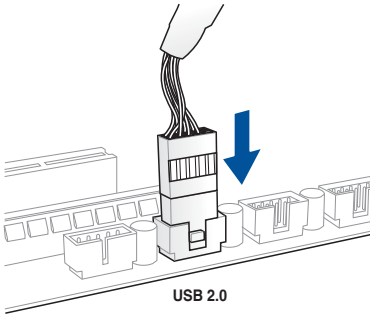

### To install front panel audio connector

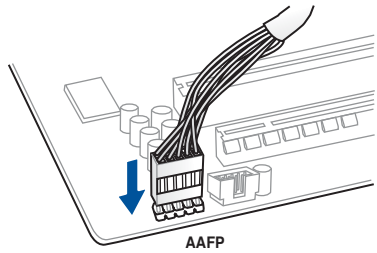

### To install USB 3.0 connector

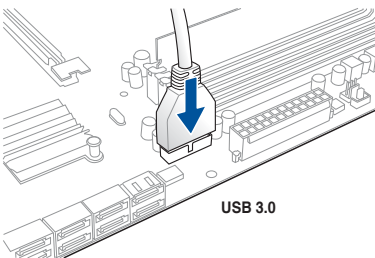

## 2.1.8 Expansion Card installation

To install PCIe x16 cards

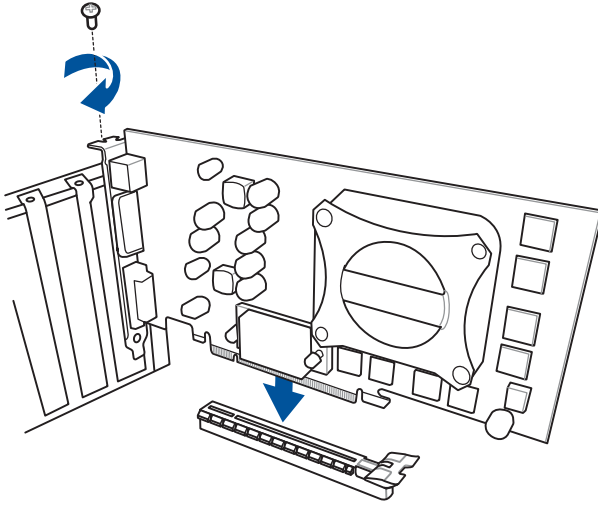

## 2.2 BIOS update utility

### USB BIOS Flashback

USB BIOS Flashback allows you to easily update the BIOS without entering the existing BIOS or operating system. Simply insert a USB storage device to the USB port (the USB port hole marked in green on the I/O shield) then press the USB BIOS Flashback button for three seconds to automatically update the BIOS.

To use USB BIOS Flashback:

1. Place the bundled support DVD to the optical drive and install the USB BIOS Flashback Wizard. Follow the onscreen instructions to complete the installation.
2. Insert the USB storage device to the USB Flashback port.



- We recommend you to use a USB 2.0 storage device to save the latest BIOS version for better compatibility and stability.
- Refer to section **2.4.1 Rear I/O connection** for the location of the USB port that supports USB BIOS Flashback.

3. Launch the USB BIOS Flashback Wizard to automatically download the latest BIOS version.
4. Shut down your computer.
5. Press the BIOS Flashback button for three seconds until the Flashback LED blinks three times, indicating that the BIOS Flashback function is enabled.

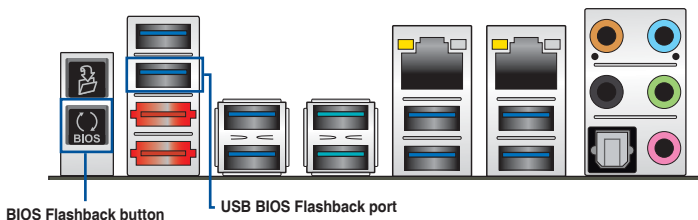

6. Wait until the light goes out, indicating that the BIOS updating process is completed.



For more BIOS update utilities in BIOS setup, refer to the section **3.11 Updating BIOS** in Chapter 3.



- Do not unplug portable disk, power system, or press the CLR\_CMOS button while BIOS update is ongoing, otherwise update will be interrupted. In case of interruption, please follow the steps again.
- If the light flashes for five seconds and turns into a solid light, this means that the BIOS Flashback is not operating properly. This may be caused by improper installation of the USB storage device and filename/file format error. If this scenario happens, please restart the system to turn off the light.
- Updating BIOS may have risks. If the BIOS program is damaged during the process and results to the system's failure to boot up, please contact your local ASUS Service Center.

## 2.3 Q-Code Logger utility

### 2.3.1 Using the Q-Code Logger

Q-Code Logger allows you to easily check Q-Code event logs without opening the system's case.

To use the Q-Code Logger:

1. Insert the USB storage device to the dedicated Q-Code Logger USB port.
2. Press the Q-Code Logger button for three seconds until the Q-Code Logger LED blinks three times, indicating that the Q-Code Logger function is enabled.

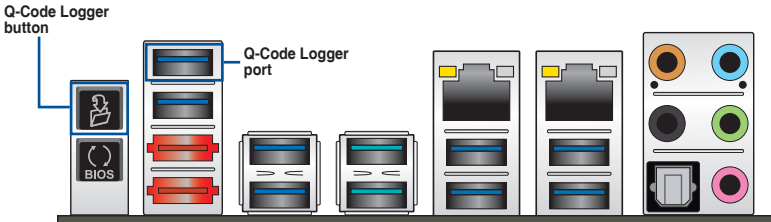

## 2.4 Motherboard rear and audio connections

### 2.4.1 Rear I/O connection

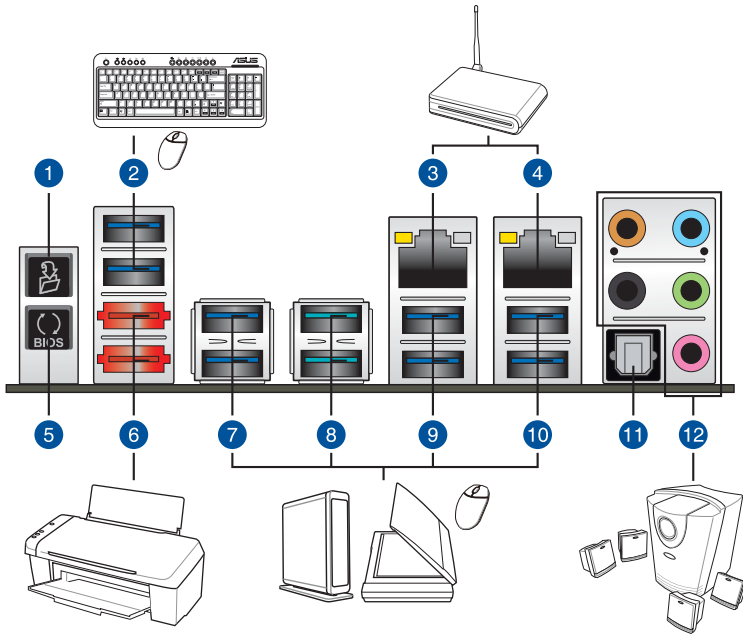

Rear panel connectors			
1.	Q-Code Logger button	7.	USB 3.0 ports E34 (Supports USB 3.0 Boost)
2.	USB 3.0 ports E56 (Support USB 3.0 Boost, upper port supports Q-Code Logger, lower port supports USB BIOS Flashback)	8.	USB 3.1 ports E12 (Supports USB 3.1 Boost)
3.	Intel® LAN port (LAN2)*	9.	USB 3.0 ports 34 (Support USB 3.0 Boost)
4.	Intel® LAN port (LAN1)*	10.	USB 3.0 ports 12 (Supports USB 3.0 Boost)
5.	USB BIOS Flashback	11.	Optical S/PDIF Out port
6.	eSATA ports 12	12.	Audio I/O ports***

\* and \*\*: Refer to the tables on the next page for the LAN port LEDs and audio port definitions.



- The plugged USB 3.0 device may run on xHCI mode or EHCI mode, depending on the operating system's setting.
- USB 3.0 devices can only be used as data storage only.
- We strongly recommend that you connect USB 3.0 devices to USB 3.0 ports for faster and better performance for your USB 3.0 devices.
- Due to the design of the Intel® X99 series chipset, all USB devices connected to the USB 2.0 and USB 3.0 ports are controlled by the xHCI controller. Some legacy USB devices must update their firmware for better compatibility.

### \* LAN ports LED indications

Activity Link LED		Speed LED	
Status	Description	Status	Description
Off	No link	Off	10 Mbps connection
Orange	Linked	Orange	100 Mbps connection
Orange (Blinking)	Data activity	Green	1 Gbps connection
Orange (Blinking then steady)	Ready to wake up from S5 mode		

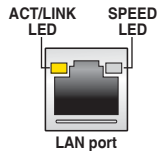

You can disable the LAN controllers in BIOS. Due to hardware design, the LAN1 port's LEDs may continue to blink even when disabled.

### \*\* Audio 2, 4, 6, or 8-channel configuration

Port	Headset 2-channel	4-channel	6-channel	8-channel
Light Blue	Line In	Line In	Line In	Side Speaker Out
Lime	Line Out	Front Speaker Out	Front Speaker Out	Front Speaker Out
Pink	Mic In	Mic In	Mic In	Mic In
Orange	–	–	Center/Subwoofer	Center/Subwoofer
Black	–	Rear Speaker Out	Rear Speaker Out	Rear Speaker Out



## 2.4.2 Audio I/O connections

### Audio I/O ports

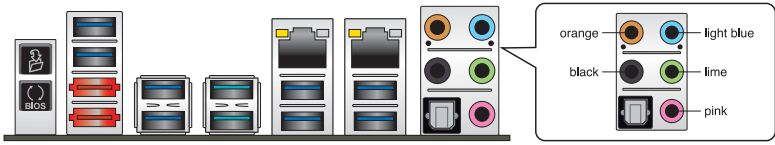

### Connect to Headphone and Mic



### Connect to Stereo Speakers

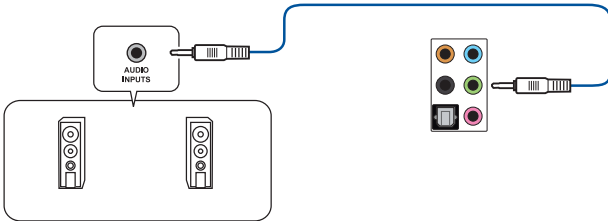

### Connect to 2.1 channel Speakers

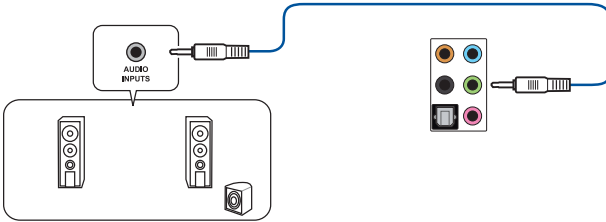

### Connect to 4.1 channel Speakers

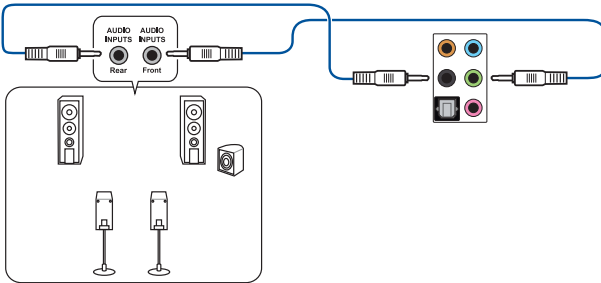

### Connect to 5.1 channel Speakers

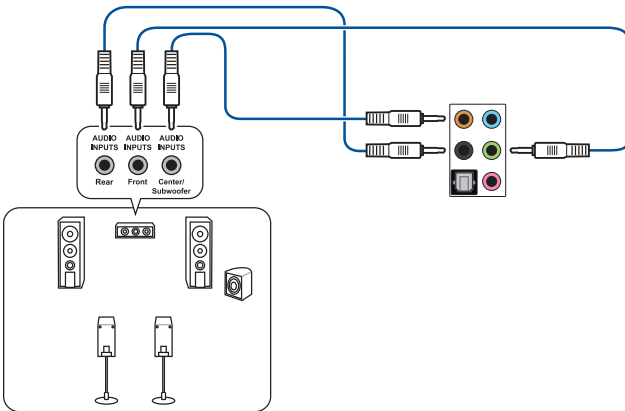

## Connect to 7.1 channel Speakers

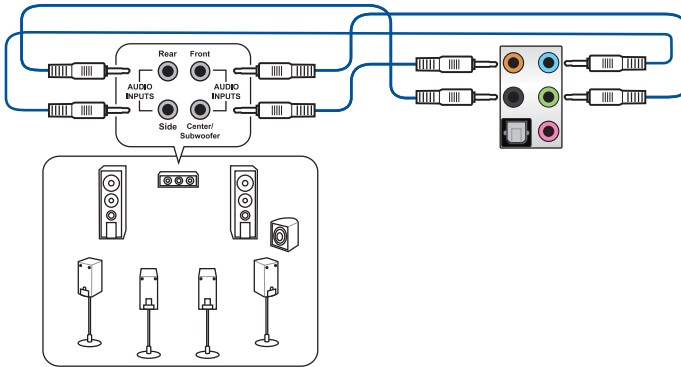

When the DTS UltraPC II function is enabled, ensure to connect the rear speaker to the light blue port.

## 2.5 Starting up for the first time

1. After making all the connections, replace the system case cover.
2. Ensure that all switches are off.
3. Connect the power cord to the power connector at the back of the system chassis.
4. Connect the power cord to a power outlet that is equipped with a surge protector.
5. Turn on the devices in the following order:
  - a. Monitor
  - b. External SCSI devices (starting with the last device on the chain)
  - c. System power
6. After applying power, the system power LED on the system front panel case lights up. For systems with ATX power supplies, the system LED lights up when you press the ATX power button. If your monitor complies with the “green” standards or if it has a “power standby” feature, the monitor LED may light up or change from orange to green after the system LED turns on.

The system then runs the power-on self tests (POST). While the tests are running, the BIOS beeps (refer to the BIOS beep codes table) or additional messages appear on the screen. If you do not see anything within 30 seconds from the time you turned on the power, the system may have failed a power-on test. Check the jumper settings and connections or call your retailer for assistance.

BIOS Beep	Description
One short beep	VGA detected Quick boot set to disabled No keyboard detected
One continuous beep followed by two short beeps then a pause (repeated)	No memory detected
One continuous beep followed by three short beeps	No VGA detected
One continuous beep followed by four short beeps	Hardware component failure

- At power on, hold down the <Delete> key to enter the BIOS Setup. Follow the instructions in Chapter 3.

## 2.6 Turning off the computer

While the system is ON, press the power button for less than four seconds to put the system on sleep mode or soft-off mode, depending on the BIOS setting. Press the power switch for more than four seconds to let the system enter the soft-off mode regardless of the BIOS setting.

# BIOS Setup

# 3

## 3.1 Knowing BIOS



---

The new ASUS UEFI BIOS is a Unified Extensible Interface that complies with UEFI architecture, offering a user-friendly interface that goes beyond the traditional keyboard-only BIOS controls to enable a more flexible and convenient mouse input. You can easily navigate the new UEFI BIOS with the same smoothness as your operating system. The term "BIOS" in this user manual refers to "UEFI BIOS" unless otherwise specified.

---

BIOS (Basic Input and Output System) stores system hardware settings such as storage device configuration, overclocking settings, advanced power management, and boot device configuration that are needed for system startup in the motherboard CMOS. In normal circumstances, the default BIOS settings apply to most conditions to ensure optimal performance. **DO NOT change the default BIOS settings** except in the following circumstances:

- An error message appears on the screen during the system bootup and requests you to run the BIOS Setup.
- You have installed a new system component that requires further BIOS settings or update.



---

Inappropriate BIOS settings may result in instability or boot failure. We strongly recommend that you change the BIOS settings only with the help of a trained service personnel.

---



---

When downloading or updating the BIOS file, rename it as **X99EU31.CAP** for this motherboard.

---

## 3.2 BIOS setup program

Use the BIOS Setup to update the BIOS or configure its parameters. The BIOS screen include navigation keys and brief onscreen help to guide you in using the BIOS Setup program.

### Entering BIOS at startup

To enter BIOS Setup at startup, press <Delete> during the Power-On Self Test (POST). If you do not press <Delete>, POST continues with its routines.

### Entering BIOS Setup after POST

To enter BIOS Setup after POST:

- Press <Ctrl>+<Alt>+<Delete> simultaneously.
- Press the reset button on the system chassis.
- Press the power button to turn the system off then back on. Do this option only if you failed to enter BIOS Setup using the first two options.

After doing either of the three options, press <Delete> key to enter BIOS.



- 
- The BIOS setup screens shown in this section are for reference purposes only, and may not exactly match what you see on your screen.
  - Ensure that a USB mouse is connected to your motherboard if you want to use the mouse to control the BIOS setup program.
  - If the system becomes unstable after changing any BIOS setting, load the default settings to ensure system compatibility and stability. Select the **Load Optimized Defaults** item under the **Exit** menu or press hotkey <F5>. See section 3.10 **Exit menu** for details.
  - If the system fails to boot after changing any BIOS setting, try to clear the CMOS and reset the motherboard to the default value. See section 1.2.6 **Onboard buttons and switches** for information on how to erase the RTC RAM via the Clear CMOS button.
  - The BIOS setup program does not support the Bluetooth devices.
- 

### BIOS menu screen

The BIOS Setup program can be used under two modes: **EZ Mode** and **Advanced Mode**. You can change modes from the **Exit** menu or from the **Exit/Advanced Mode** screen.

## 3.2.1 EZ Mode

By default, the EZ Mode screen appears when you enter the BIOS setup program. The EZ Mode provides you an overview of the basic system information, and allows you to select the display language, system performance mode and boot device priority. To access the Advanced Mode, click **Exit/Advanced Mode**, then select **Advanced Mode** or press <F7> hot key for the advanced BIOS settings.



The default screen for entering the BIOS setup program can be changed between EZ Mode or Advanced Mode. Refer to the Setup Mode item in section **3.8 Boot menu** for details.

The screenshot shows the ASUS UEFI BIOS Utility - EZ Mode interface. The top bar displays the date (02/26/2014), time (23:00), language (English), and EZ Tuning Wizard (F11). The main area is divided into several sections:

- Information:** Shows BIOS Ver. D402, Intel(R) Core(TM) i7-5930K CPU @ 3.50GHz, Speed: 3500 MHz, and Memory: 4096 MB (DDR4 2133MHz).
- CPU Temperature:** Displays 40°C.
- CPU Voltage:** Displays 1.008 V.
- Motherboard Temperature:** Displays 52°C.
- DRAM Status:** Lists DIMM\_A1 through DIMM\_D1, with DIMM\_D1 being Samsung 4GB 2133MHz.
- SATA Information:** Lists P1 through P7, all showing N/A.
- Intel Rapid Storage Technology:** A toggle switch is set to 'On'.
- FAN Profile:** Shows CPU FAN at 2184 RPM and four chassis fans (CHA1-CHA4) and CPU OPT FAN, all at N/A.
- EZ System Tuning:** Offers 'Performance' and 'Energy Saving' modes. 'Power Saving' is currently selected.
- Boot Priority:** A list of bootable devices including 'General USB Flash Disk 1100' and 'UEFI: General USB Flash Disk 1100'.
- Manual Fan Tuning:** A graph showing CPU FAN speed over time, with a 'Manual Fan Tuning' button below it.
- Bottom Bar:** Contains 'Default(F5)', 'Save & Exit(F10)', and 'Advanced Mode(F7)' options.

Callouts and their descriptions:

- Displays the system properties of the selected mode. Click < or > to switch EZ System Tuning modes** (points to the EZ System Tuning section).
- Displays the CPU/motherboard temperature, CPU voltage output, CPU/chassis/power fan speed, and SATA information** (points to the Information, CPU Temperature, CPU Voltage, Motherboard Temperature, and SATA Information sections).
- Selects the display language of the BIOS setup program** (points to the English language selector).
- Creates storage RAID and configures system overclocking** (points to the Intel Rapid Storage Technology section).
- Enables or disables the SATA RAID mode for Intel Rapid Storage Technology** (points to the On/Off toggle).
- Displays the CPU Fan's speed. Click the button to manually tune the fans** (points to the CPU FAN RPM and Manual Fan Tuning button).
- Shows the bootable devices** (points to the Boot Priority list).
- Loads optimized default settings** (points to the Default(F5) button).
- Saves the changes and resets the system** (points to the Save & Exit(F10) button).
- Displays the Advanced mode menus** (points to the Advanced Mode(F7) button).
- Selects the boot device priority** (points to the Boot Priority list).



The boot device options vary depending on the devices you installed to the system.

### 3.2.2 Advanced Mode

The Advanced Mode provides advanced options for experienced end-users to configure the BIOS settings. The figure below shows an example of the Advanced Mode. Refer to the following sections for the detailed configurations.



To switch from EZ Mode to Advanced Mode, click **Advanced Mode** or press F7 hotkey.

The screenshot shows the ASUS UEFI BIOS Utility in Advanced Mode. The interface includes a menu bar at the top with options like My Favorites, Main, Ai Tweaker, Advanced (highlighted), Monitor, Boot, Tool, and Exit. A sub-menu is open for CPU Power Management Configuration, showing various settings like Hyper-Threading, Intel Adaptive Thermal Monitor, and Intel Virtualization Technology. On the right, there is a Hardware Monitor section displaying CPU, Memory, and Voltage information. The bottom of the screen shows version information and a button to return to EZ Mode.

Labels in the image include:

- Menu bar
- Language
- MyFavorite
- Q-Fan control
- EZ Tuning Wizard
- Quick Note
- Hot Keys
- Sub-menu item
- Item description
- Configuration fields
- Scroll bar
- Last modified settings
- Goes back to EZ Mode
- Displays the CPU/motherboard temperature, CPU and memory voltage output



## Menu bar

The menu bar on top of the screen has the following main items:

<b>My Favorites</b>	For saving the frequently-used system settings and configuration.
<b>Main</b>	For changing the basic system configuration
<b>Ai Tweaker</b>	For changing the overclocking settings
<b>Advanced</b>	For changing the advanced system settings
<b>Monitor</b>	For displaying the system temperature, power status, and changing the fan settings.
<b>Boot</b>	For changing the system boot configuration
<b>Tool</b>	For configuring options for special functions
<b>Exit</b>	For selecting the exit options and loading default settings

## Menu items

The highlighted item on the menu bar displays the specific items for that menu. For example, selecting **Main** shows the Main menu items.

The other items (My Favorites, Ai Tweaker, Advanced, Monitor, Boot, Tool, and Exit) on the menu bar have their respective menu items.

## Submenu items

A greater than sign (>) before each item on any menu screen means that the item has a submenu. To display the submenu, select the item and press <Enter>.

## Language

This button above the menu bar contains the languages that you can select for your BIOS. Click this button to select the the language that you want to display in your BIOS screen.

## MyFavorites (F3)

This button above the menu bar shows all BIOS items in a Tree Map setup. Select frequently-used BIOS settings and save it to MyFavorites menu.



---

Refer to section **3.3 My Favorites** for more information.

---

## Q-Fan Control (F6)

This button above the menu bar displays the current settings of your fans. Use this button to manually tweak the fans to your desired settings.



---

Refer to section **3.2.3 QFan Control** for more information.

---

## EZ Tuning Wizard (F11)

This button above the menu bar allows you to view and tweak the overclocking settings of your system. It also allows you to change the motherboard's SATA mode from AHCI to RAID mode.



---

Refer to section **3.2.4 EZ Tuning Wizard** for more information.

---

### Quick Note (F9)

This button above the menu bar allows you to key in notes of the activities that you have done in BIOS.



- 
- The Quick Note function does not support the following keyboard functions: delete, cut, copy and paste.
  - You can only use the alphanumeric characters to enter your notes.
- 

### Hot keys

This button above the menu bar contains the navigation keys for the BIOS setup program. Use the navigation keys to select items in the menu and change the settings.

### Scroll bar

A scroll bar appears on the right side of a menu screen when there are items that do not fit on the screen. Press the Up/Down arrow keys or <Page Up> / <Page Down> keys to display the other items on the screen.

### General help

At the top right corner of the menu screen is a brief description of the selected item. Use <F12> key to capture the BIOS screen and save it to the removable storage device.

### Configuration fields

These fields show the values for the menu items. If an item is user-configurable, you can change the value of the field opposite the item. You cannot select an item that is not user-configurable.

A configurable field is highlighted when selected. To change the value of a field, select it and press <Enter> to display a list of options.

### Last Modified button

This button shows the items that you last modified and saved in BIOS Setup.

### 3.2.3 QFan Control

The QFan Control allows you to set a fan profile or manually configure the operating speed of your CPU and chassis fans.



## Configuring fans manually

Select **Manual** from the list of profiles to manually configure your fans' operating speed.

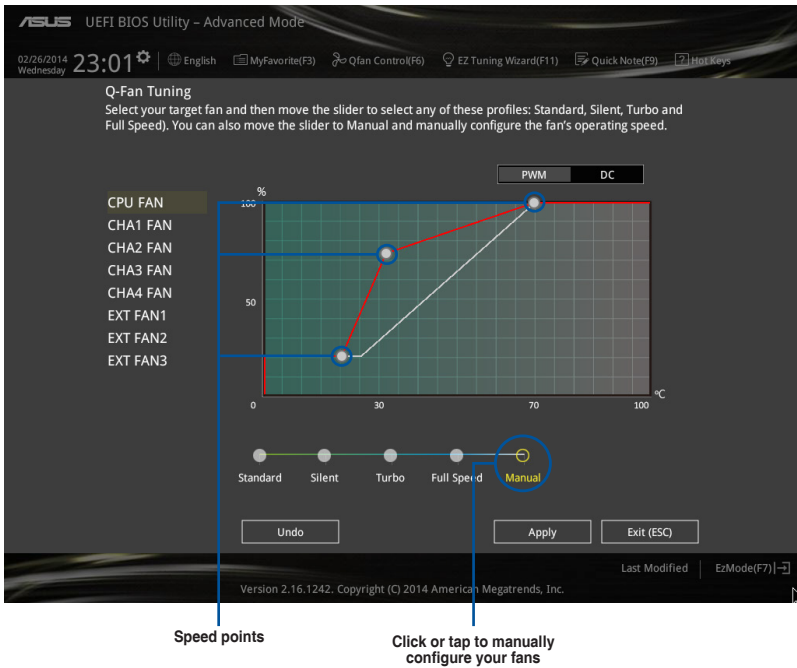

To configure your fans:

1. Select the fan that you want to configure and to view its current status.
2. Click and drag the speed points to adjust the fans' operating speed.
3. Click **Apply** to save the changes then click **Exit (ESC)**.

### 3.2.4 EZ Tuning Wizard

EZ Tuning Wizard allows you to overclock your CPU and DRAM, computer usage, and CPU fan to their best settings. You can also easily set RAID in your system using this feature.

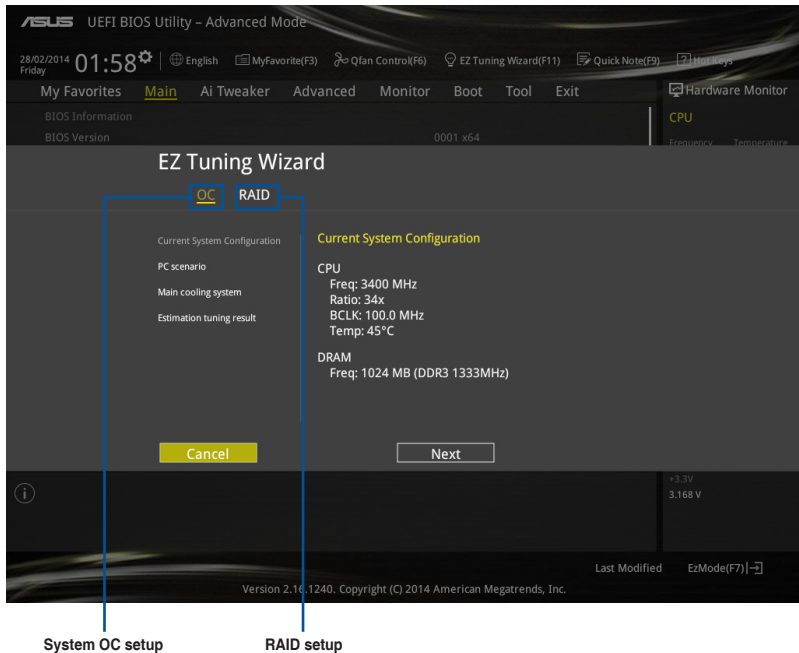

#### Tuning your system settings

To tune your settings:

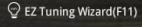
1. Press <F11> on your keyboard or click  from the BIOS screen to open EZ Tuning Wizard screen, then click **Next**.
2. Select a PC scenario **Daily Computing** or **Gaming/Media Editing**, then click **Next**.
3. Select the CPU fan type (**Box cooler**, **Tower cooler**, or **Water cooler**) that you installed then click **Next**.



If you are not sure of the CPU fan type, click **I'm not sure**. The system automatically detects the CPU fan type.

4. Click **Next** then click **Yes** to confirm auto-tuning.

## Creating RAID

To create RAID:

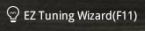
1. Press <F11> on your keyboard or click  from the BIOS screen to open EZ Tuning Wizard screen.
2. Click **RAID** then click **Next**.



- Ensure that your HDDs have no existing RAID volumes.
- Ensure to connect your HDDs to Intel® SATA connectors.

3. Select the type of storage for your RAID **Easy Backup** or **Super Speed**, then click **Next**.

- a. For Easy Backup, click **Next** then select from **Easy Backup (RAID1)** or **Easy Backup (RAID10)**.



You can only select Easy Backup (RAID 10) if you connect four (4) HDDs.

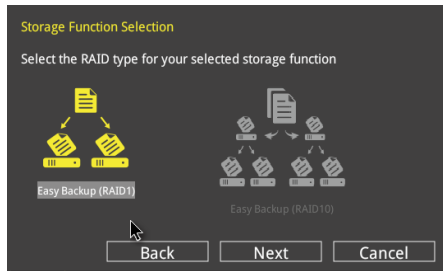

- b. For Easy Backup, click **Next** then select from **Super Speed (RAID0)** or **Super Speed (RAID5)**.



4. After selecting the type of RAID, click **Next** then click **Yes** to continue the RAID setup.
5. After the RAID setup is done, click **Yes** to exit the setup then click **OK** to reset your system.

### 3.3 My Favorites

MyFavorites is your personal space where you can easily save and access your favorite BIOS items.



## Adding items to My Favorites

To add BIOS items:

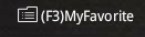
1. Press <F3> on your keyboard or click  from the BIOS screen to open Setup Tree Map screen.
2. On the Setup Tree Map screen, select the BIOS items that you want to save in MyFavorites screen.

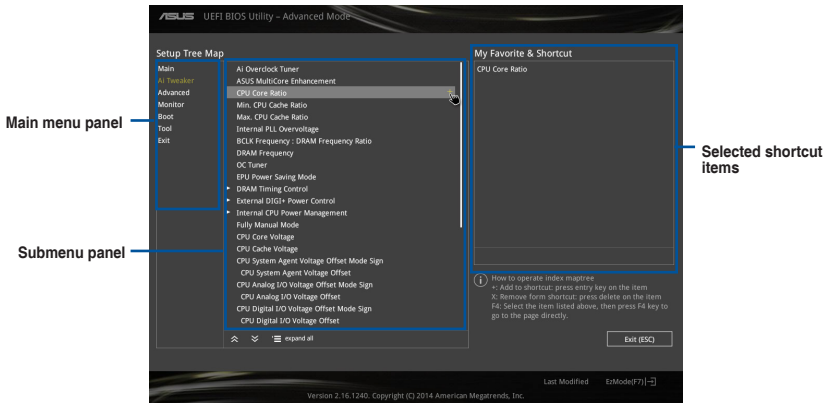

3. Select an item from main menu panel, then click the submenu that you want to save as favorite from the submenu panel and tap or click  or press <Enter> on your keyboard.



You cannot add the following items to My Favorite items:

- Items with submenu options
- User-managed items such as language and boot order
- Configuration items such as Memory SPD Information, system time and date.

4. Click **Exit (ESC)** or press <esc> key to close Setup Tree Map screen.
5. Go to My Favorites menu to view the saved BIOS items.



## 3.4 Main menu

The Main menu screen appears when you enter the Advanced Mode of the BIOS Setup program. The Main menu provides you an overview of the basic system information, and allows you to set the system date, time, language, and security settings.



## Security

The Security menu items allow you to change the system security settings.

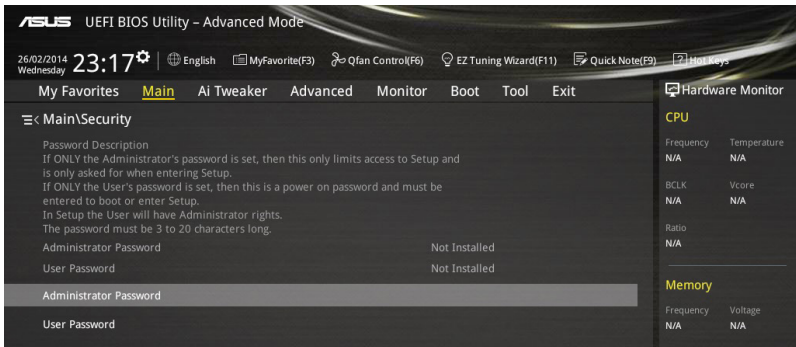

- If you have forgotten your BIOS password, erase the CMOS Real Time Clock (RTC) RAM to clear the BIOS password. See section 1.2.6 Onboard buttons and switches for information on how to erase the RTC RAM via the Clear CMOS button.
- The Administrator or User Password items on top of the screen show the default [Not Installed]. After you set a password, these items show [Installed].

## Administrator Password

If you have set an administrator password, we recommend that you enter the administrator password for accessing the system. Otherwise, you might be able to see or change only selected fields in the BIOS setup program.

To set an administrator password:

1. Select the **Administrator Password** item and press <Enter>.
2. From the **Create New Password** box, key in a password, then press <Enter>.
3. Confirm the password when prompted.

To change an administrator password:

1. Select the **Administrator Password** item and press <Enter>.
2. From the **Enter Current Password** box, key in the current password, then press <Enter>.
3. From the **Create New Password** box, key in a new password, then press <Enter>.
4. Confirm the password when prompted.

To clear the administrator password, follow the same steps as in changing an administrator password, but press <Enter> when prompted to create/confirm the password. After you clear the password, the **Administrator Password** item on top of the screen shows **Not Installed**.

## User Password

If you have set a user password, you must enter the user password for accessing the system. The User Password item on top of the screen shows the default Not Installed. After you set a password, this item shows Installed.

To set a user password:

1. Select the **User Password** item and press <Enter>.
2. From the **Create New Password** box, key in a password, then press <Enter>.
3. Confirm the password when prompted.

To change a user password:

1. Select the **User Password** item and press <Enter>.
2. From the **Enter Current Password** box, key in the current password, then press <Enter>.
3. From the **Create New Password** box, key in a new password, then press <Enter>.
4. Confirm the password when prompted.

To clear the user password, follow the same steps as in changing a user password, but press <Enter> when prompted to create/confirm the password. After you clear the password, the **User Password** item on top of the screen shows **Not Installed**.

## 3.5 Ai Tweaker menu

The Ai Tweaker menu items allow you to configure overclocking-related items.



Be cautious when changing the settings of the Ai Tweaker menu items. Incorrect field values can cause the system to malfunction.



The configuration options for this section vary depending on the CPU and DIMM model you installed on the motherboard.

Scroll down to display other BIOS items.



### Ai Overclock Tuner [Auto]

This item allows you to select the CPU overclocking options to achieve the desired CPU internal frequency. Select any of these preset overclocking configuration options:

- [Auto] Loads the optimal settings for the system.
- [Manual] Automatically optimizes the CPU ratio and BCLK frequency.



The following item appears only when you set the Ai Overclocking Tuner to [Manual].

### CPU Strap [Auto]

This item allows you to select a strap close to your target BCLK (base clock) for an extreme overclocking, or leave it at [Auto] for the BIOS to upgrade.

Configuration options: [Auto] [100MHz] [125MHz] [166MHz] [250MHz]



---

The following item appears only when you set the CPU Strap to **[100MHz]**, **[125MHz]**, **[167MHz]**, or **[250MHz]**.

---

#### **Source Clock Tuner [Auto]**

This item allows you to select the source clock based on the assigned CPU strap for a better overclocking capability.

Configuration options: [8Ohm db] [7Ohm db] [6Ohm db] [5Ohm db] [4Ohm db] [3Ohm db] [2Ohm db]

#### **PLL Selection [Auto]**

This item is set to LC PLL by default for better stability. Select SB PLL when the BCLK (base clock) frequency is far away from 100 MHz. This may affect the function of other devices that need precise clock jitters.

Configuration options: [Auto] [LC PLL] [SB PLL]

#### **Filter PLL [Auto]**

Set this item to high BCLK (base clock) mode when using a very high BCLK to improve overclocking capability.

Configuration options: [Auto] [Low BCLK mode] [High BCLK mode]

#### **BCLK Frequency [Auto]**

This item allows you to set the BCLK (base clock) frequency to enhance the system performance. Use the <+> or <-> to adjust the value. The values range from 80.0 MHz to 300.0 MHz.



---

We recommend you to set the value based on the CPU specification, as high BCLK frequencies may damage the CPU permanently.

---

#### **Initial BCLK Frequency [Auto]**

This item allows you to start overclocking the system from the initial BCLK (base clock) frequency to the assigned BCLK frequency. Use the <+> or <-> to adjust the value.

The value ranges depend on the value you set on BCLK Frequency.

#### **ASUS MultiCore Enhancement [Auto]**

[Auto] This item allows you to maximize the overlocking performance optimized by ASUS core ratio settings.

[Disabled] This item allows you to set to default core ratio settings.

#### **CPU Core Ratio [Per Core]**

This item allows you to set the CPU core ratio limit per core or synchronize automatically to all cores.

Configuration options: [Auto] [Sync All Cores] [Per Core]



---

The following item appears only when you set the CPU Core Ratio to **[Per Core]**.

---

#### **1-Core Ratio Limit [Auto]**

Select **[Auto]** to apply the CPU default Turbo Ratio setting or manually assign a 1-Core Limit value that must be higher than or equal to the 2-Core Ratio Limit.

### **2-Core Ratio Limit [Auto]**

Select **[Auto]** to apply the CPU default Turbo Ratio setting or manually assign a 2-Core Limit value that must be higher than or equal to the 3-Core Ratio Limit.



---

If you assign a value for 2-Core Ratio Limit, do not set the 1-Core Ratio Limit to **[Auto]**.

---

### **3-Core Ratio Limit [Auto]**

Select **[Auto]** to apply the CPU default Turbo Ratio setting or manually assign a 3-Core Limit value that must be higher than or equal to the 4-Core Ratio Limit.



---

If you assign a value for 3-Core Ratio Limit, do not set the 1-Core Ratio Limit and 2-Core Ratio Limit to **[Auto]**.

---

### **4-Core Ratio Limit [Auto]**

Select **[Auto]** to apply the CPU default Turbo Ratio setting or manually assign a 4-Core Limit value that must be higher than or equal to the 5-Core Ratio Limit.



---

If you assign a value for 4-Core Ratio Limit, do not set the 1-Core Ratio Limit, 2-Core Ratio Limit, and 3-Core Ratio to **[Auto]**.

---

### **5-Core Ratio Limit [Auto]**

Select **[Auto]** to apply the CPU default Turbo Ratio setting or manually assign a 5-Core Limit value that must be higher than or equal to the 6-Core Ratio Limit.



---

If you assign a value for 5-Core Ratio Limit, do not set the 1-Core Ratio Limit, 2-Core Ratio Limit, 3-Core Ratio, and 4-Core Ratio to **[Auto]**.

---

### **6-Core Ratio Limit [Auto]**

Select **[Auto]** to apply the CPU default Turbo Ratio setting or manually assign a 6-Core Limit value.



---

If you assign a value for 6-Core Ratio Limit, do not set the 1-Core Ratio Limit, 2-Core Ratio Limit, 3-Core Ratio, 4-Core Ratio, and 5-Core Ratio to **[Auto]**.

---

## **Min. CPU Cache Ratio [Auto]**

This item allows you to set the minimum possible ratio on the Uncore part of the processor. Use the <+> or <-> keys to adjust the value. The values depend on the CPU installed.

## **Max. CPU Cache Ratio [Auto]**

This item allows you to set the maximum possible ratio on the Uncore part of the processor. Use the <+> or <-> keys to adjust the value. The values depend on the CPU installed.

### Internal PLL Overvoltage [Auto]

This item allows you to enable the internal PLL Overvoltage for K-SKU CPUs to get the extreme overclocking capability.

Configuration options: [Auto] [Enabled] [Disabled]

### BCLK Frequency: DRAM Frequency Ratio [Auto]

This item allows you to set the base clock frequency of the DRAM frequency ratio.

[Auto] The DRAM ratio is set to its optimized settings.

[100:100] The DRAM ratio is set to 100:100.

[100:133] The DRAM ratio is set to 100:133.

### DRAM Frequency [Auto]

This item allows you to set the memory operating frequency. The configurable options vary with the BCLK (base clock) frequency setting. Select the auto mode to apply the optimized setting.

Configuration options: [DDR4-800MHz] [DDR4-1000MHz] [DDR4-1067MHz] [DDR4-1200MHz] [DDR4-1333MHz] [DDR4-1400MHz] [DDR4-1600MHz] [DDR4-1800MHz] [DDR4-1866MHz] [DDR4-2000MHz] [DDR4-2133MHz] [DDR4-2200MHz] [DDR4-2400MHz] [DDR4-2600MHz] [DDR4-2666MHz] [DDR4-2800MHz] [DDR4-2933MHz] [DDR4-3000MHz] [DDR4-3200MHz]

### OC Tuner [Keep Current Settings]

This item allows you to automatically overclock the CPU and DRAM frequencies and voltage for an enhanced system performance. It also accelerates the CPU graphics performance to the extreme depending on the CPU graphics loading.

Configuration options: [Keep Current Settings] [Ratio First] [BCLK First]



---

Ensure that you installed an efficient CPU fan for CPU and graphics loading before selecting either **[BCLK First]** or **[Ratio First]**. To keep the current overclocking tuner status, select **[Keep Current Settings]**.

---

### EPU Power Saving Mode [Disabled]

The ASUS EPU (Energy Processing Unit) sets the CPU in its minimum power consumption settings. Enable this item to set lower CPU VCCIN and Vcore voltages and achieve the best energy saving condition.

Configuration options: [Disabled] [Enabled]

### DRAM Timing Control

The subitems in this menu allow you to set the DRAM timing control features. Use the <+> or <-> keys to adjust the value. To restore the default setting, type [auto] using the keyboard and press the <Enter> key.



---

Changing the values in this menu may cause the system to become unstable! If this happens, revert to the default settings.

---

## Primary Timings

### **DRAM CAS# Latency [Auto]**

Configuration options: [Auto] [1] – [31]

### **DRAM RAS# to CAS# Delay [Auto]**

Configuration options: [Auto] [1] – [31]

### **DRAM RAS# PRE Time [Auto]**

Configuration options: [Auto] [1] – [31]

### **DRAM RAS# ACT Time [Auto]**

Configuration options: [Auto] [1] – [63]

### **DRAM Command Rate [Auto]**

Configuration options: [Auto] [Timing T1] – [Timing T3]

## Secondary Timings

### **DRAM RAS# to RAS# Delay [Auto]**

Configuration options: [Auto] [1] – [7]

### **DRAM RAS# to RAS# Delay L [Auto]**

Configuration options: [Auto] [1] – [7]

### **DRAM REF Cycle Time [Auto]**

Configuration options: [Auto] [1] – [1023]

### **DRAM Refresh Interval [Auto]**

Configuration options: [Auto] [1] – [32767]

### **DRAM WRITE Recovery Time [Auto]**

Configuration options: [Auto] [1] – [31]

### **DRAM READ to PRE Time [Auto]**

Configuration options: [Auto] [1] – [15]

### **DRAM FOUR ACT WIN Time [Auto]**

Configuration options: [Auto] [1] – [63]

### **DRAM WRITE to READ Delay [Auto]**

Configuration options: [Auto] [1] – [15]

### **DRAM WRITE to READ Delay(tWTR\_L) [Auto]**

Configuration options: [Auto] [1] – [15]

### **DRAM CKE Minimum Pulse Width [Auto]**

Configuration options: [Auto] [4] – [8]

### **DRAM Write Latency [Auto]**

Configuration options: [Auto] [1] – [31]

### Third Timings

#### **tRRDR [Auto]**

Configuration options: [Auto] [1] - [7]

#### **tRRDD [Auto]**

Configuration options: [Auto] [1] - [7]

#### **tWWDR [Auto]**

Configuration options: [Auto] [1] - [7]

#### **tWWDD [Auto]**

Configuration options: [Auto] [1] - [7]

#### **tRWDR [Auto]**

Configuration options: [Auto] [1] - [7]

#### **tWRDR [Auto]**

Configuration options: [Auto] [1] - [7]

#### **tWRDD [Auto]**

Configuration options: [Auto] [1] - [7]

#### **tRWSR [Auto]**

Configuration options: [Auto] [1] - [7]

#### **tCCD [Auto]**

Configuration options: [Auto] [1] - [7]

#### **tUWRDR [Auto]**

Configuration options: [Auto] [1] - [3]

#### **tRWDR2 [Auto]**

Configuration options: [Auto] [0] - [31]

#### **tRWDD [Auto]**

Configuration options: [Auto] [0] - [31]

#### **tRWSR2 [Auto]**

Configuration options: [Auto] [0] - [31]

#### **tWRDD2 [Auto]**

Configuration options: [Auto] [0] - [31]

#### **tCCDWR [Auto]**

Configuration options: [Auto] [0] - [7]

#### **tCCD\_L [Auto]**

Configuration options: [Auto] [1] - [3]

#### **RTL IOL control**

##### **DRAM RTL INIT Value [Auto]**

Configuration options: [Auto] [1] - [127]

##### **DRAM RTL (CHA D0 R0) [Auto]**

Configuration options: [Auto] [1] - [127]



**DRAM RTL (CHA D0 R1) [Auto]**  
Configuration options: [Auto] [1] - [127]

**DRAM RTL (CHA D1 R0) [Auto]**  
Configuration options: [Auto] [1] - [127]

**DRAM RTL (CHA D1 R1) [Auto]**  
Configuration options: [Auto] [1] - [127]

**DRAM RTL (CHB D0 R0) [Auto]**  
Configuration options: [Auto] [1] - [127]

**DRAM RTL (CHB D0 R1) [Auto]**  
Configuration options: [Auto] [1] - [127]

**DRAM RTL (CHB D1 R0) [Auto]**  
Configuration options: [Auto] [1] - [127]

**DRAM RTL (CHB D1 R1) [Auto]**  
Configuration options: [Auto] [1] - [127]

**DRAM RTL (CHC D0 R0) [Auto]**  
Configuration options: [Auto] [1] - [127]

**DRAM RTL (CHC D0 R1) [Auto]**  
Configuration options: [Auto] [1] - [127]

**DRAM RTL (CHC D1 R0) [Auto]**  
Configuration options: [Auto] [1] - [127]

**DRAM RTL (CHC D1 R1) [Auto]**  
Configuration options: [Auto] [1] - [127]

**DRAM RTL (CHD D0 R0) [Auto]**  
Configuration options: [Auto] [1] - [127]

**DRAM RTL (CHD D0 R1) [Auto]**  
Configuration options: [Auto] [1] - [127]

**DRAM RTL (CHD D1 R0) [Auto]**  
Configuration options: [Auto] [1] - [127]

**DRAM RTL (CHD D1 R1) [Auto]**  
Configuration options: [Auto] [1] - [127]

**DRAM IO-L (CHA D0 R0) [Auto]**  
Configuration options: [Auto] [1] - [255]

**DRAM IO-L (CHA D0 R1) [Auto]**  
Configuration options: [Auto] [1] - [255]

**DRAM IO-L (CHA D1 R0) [Auto]**  
Configuration options: [Auto] [1] - [255]

**DRAM IO-L (CHA D1 R1) [Auto]**  
Configuration options: [Auto] [1] - [255]

**DRAM IO-L (CHB D0 R0) [Auto]**  
Configuration options: [Auto] [1] - [255]

**DRAM IO-L (CHB D0 R1) [Auto]**  
Configuration options: [Auto] [1] - [255]

**DRAM IO-L (CHB D1 R0) [Auto]**  
Configuration options: [Auto] [1] - [255]

- DRAM IO-L (CHB D1 R1) [Auto]**  
Configuration options: [Auto] [1] - [255]
- DRAM IO-L (CHC D0 R0) [Auto]**  
Configuration options: [Auto] [1] - [255]
- DRAM IO-L (CHC D0 R1) [Auto]**  
Configuration options: [Auto] [1] - [255]
- DRAM IO-L (CHC D1 R0) [Auto]**  
Configuration options: [Auto] [1] - [255]
- DRAM IO-L (CHC D1 R1) [Auto]**  
Configuration options: [Auto] [1] - [255]
- DRAM IO-L (CHD D0 R0) [Auto]**  
Configuration options: [Auto] [1] - [255]
- DRAM IO-L (CHD D0 R1) [Auto]**  
Configuration options: [Auto] [1] - [255]
- DRAM IO-L (CHD D1 R0) [Auto]**  
Configuration options: [Auto] [1] - [255]
- DRAM IO-L (CHD D1 R1) [Auto]**  
Configuration options: [Auto] [1] - [255]

**IO control**

- MC Vref(CHA) [Auto]**  
Configuration options: [Auto] [50] - [99.911]
- MC Vref(CHB) [Auto]**  
Configuration options: [Auto] [50] - [99.911]
- MC Vref(ChC) [Auto]**  
Configuration options: [Auto] [50] - [99.911]
- MC Vref(ChD) [Auto]**  
Configuration options: [Auto] [50] - [99.911]
- DRAM Vref (CHA) [Auto]**  
Configuration options: [Auto] [60] - [99]
- DRAM Vref (CHB) [Auto]**  
Configuration options: [Auto] [60] - [99]
- DRAM Vref (CHC) [Auto]**  
Configuration options: [Auto] [60] - [99]
- DRAM Vref (CHD) [Auto]**  
Configuration options: [Auto] [60] - [99]
- CTL Vref (CHAB) Sign [+]**  
Configuration options: [+] [-]
- CTL Vref (CHAB) [Auto]**  
Configuration options: [Auto] [0.00] - [0.20]
- CTL Vref (CHCD) Sign [+]**  
Configuration options: [+] [-]
- CTL Vref (CHCD) [Auto]**  
Configuration options: [Auto] [0.00] - [0.20]

**Receiver DQ Pre-emphasis [Auto]**  
Configuration options: [Auto] [0.90] - [1.60]

**Receiver DQ De-emphasis [Auto]**  
Configuration options: [Auto] [0.90] - [1.60]

**Transmitter DQ Pre-emphasis [Auto]**  
Configuration options: [Auto] [0.90] - [1.60]

**Receiver DQS Pre-emphasis [Auto]**  
Configuration options: [Auto] [0.90] - [1.60]

**Receiver DQS De-emphasis [Auto]**  
Configuration options: [Auto] [0.90] - [1.60]

**Transmitter DQS Pre-emphasis [Auto]**  
Configuration options: [Auto] [0.90] - [1.60]

**Receiver CMD Pre-emphasis [Auto]**  
Configuration options: [Auto] [0.80] - [1.60]

**Receiver CMD De-emphasis [Auto]**  
Configuration options: [Auto] [0.80] - [1.60]

**Transmitter CMD De-emphasis [Auto]**  
Configuration options: [Auto] [0.80] - [1.60]

**Receiver CLK Pre-emphasis [Auto]**  
Configuration options: [Auto] [1.00] - [2.00]

**Receiver CLK De-emphasis [Auto]**  
Configuration options: [Auto] [1.00] - [2.00]

**Transmitter CLK Pre-emphasis [Auto]**  
Configuration options: [Auto] [1.00] - [2.00]

**Receiver CTL Pre-emphasis [Auto]**  
Configuration options: [Auto] [1.00] - [1.60]

**Receiver CTL De-emphasis [Auto]**  
Configuration options: [Auto] [1.00] - [1.60]

**Transmitter CTL Pre-emphasis [Auto]**  
Configuration options: [Auto] [1.00] - [1.60]

**Receiver ODT Pre-emphasis [Auto]**  
Configuration options: [Auto] [1.00] - [1.60]

**Transmitter ODT Pre-emphasis [Auto]**  
Configuration options: [Auto] [1.00] - [1.60]

**Transmitter ODT De-emphasis [Auto]**  
Configuration options: [Auto] [1.00] - [1.60]

## MISC

### DRAM Eventual Voltage (CHA/CHB/CHC/CHD) [Auto]

Use <+> or <-> to adjust the eventual voltages of the DIMM slots. The values range from 0.8 V to 1.9 V with a 0.10 V increment.

### DRAM CLK Period [Auto]

This item allows you to set a DRAM clock period.

Configuration options: [Auto] [1] – [19]

### Memory optimize Control [Auto]

This item allows you to optimize the memory control.

Configuration options: [Auto] [Enabled] [Disabled]

### Enhanced Training (CHA/CHB/CHC/CHD) [Auto]

Configuration options: [Auto] [Enabled] [Disabled]

### MemTest [Auto]

This item allows you to enable or disable the memory testing.

Configuration options: [Enabled] [Disabled]

### Attempt Fast Boot [Auto]

This item allows the portion of the memory reference code to be skipped when possible to increase boot speed.

Configuration options: [Auto] [Enabled] [Disabled]

### Attempt Fast Cold Boot [Auto]

This item allows the portion of the memory reference code to be skipped when possible to increase boot speed.

Configuration options: [Auto] [Enabled] [Disabled]

## External Digi+ Power Control

### CPU Input Boot Voltage [Auto]

This item allows you to set a higher CPU input boot voltage for better overclocking capability. Use the <+> or <-> to adjust the value. The values range from 0.80 V to 2.7 V with an interval of 10 V.

### CPU Load-line Calibration [Auto]

Load-line is defined by Intel® specification and affects CPU power voltage. The CPU working voltage decreases proportionally to CPU loading. Higher load-line calibration could get higher voltage and good overclocking performance, but increases the CPU and VRM thermal conditions. Select from levels 1 to 9 to adjust the CPU power voltage from 0% to 125%.

Configuration options [Auto] [Level 1] - [Level 9]



---

The actual performance boost may vary depending on your CPU specification.

---



---

DO NOT remove the thermal module. The thermal conditions should be monitored.

---

### CPU VRM Switching Frequency [Auto]

This item affects the VRM transient response speed and the component thermal production. Select [Manual] to configure a higher frequency for a quicker transient response speed.

Configuration options: [Auto] [Manual]



---

DO NOT remove the thermal module. The thermal conditions should be monitored.

---



---

The following item appears only when you set the CPU VRM Switching Frequency to [Manual].

---

#### Fixed CPU VRM Switching Frequency (KHz) [300]

This item allows you to set a higher frequency for a quicker transient response speed. Use the <+> or <-> to adjust the value. The values range from 300 KHz to 600 KHz with an interval of 50 KHz.

### VRM Spread Spectrum [Disabled]

This item allows to enhance the system stability.

Configuration options: [Disabled] [Enabled]

### Active Frequency Mode [Disabled]

This item allows to enhance the power saving condition of your system.

Configuration options: [Disabled] [Enabled]

### CPU Power Phase Control [Auto]

This item allows you to set the power phase control of the CPU.

Configuration options: [Auto] [Standard] [Optimized] [Extreme] [Power Phase Response]



---

DO NOT remove the thermal module when setting this item to [Power Phase Response]. The thermal conditions should be monitored.

---



---

The following item appears only when you set the CPU Power Phase Control to [Power Phase Response].

---

#### Power Phase Response [Fast]

This item allows you to set a faster phase response for the CPU to increase system performance or to slower phase response to decrease DRAM power efficiency.

Configuration options: [Ultra Fast] [Fast] [Medium] [Regular]

### CPU Power Duty Control [T.Probe]

DIGI + VRM Duty Control adjusts the current of every VRM phase and the thermal conditions of every phase component.

[T. Probe] Select to maintain the VRM thermal balance.

[Extreme] Select to maintain the current VRM balance.



---

DO NOT remove the thermal module. The thermal conditions should be monitored.

---

### **CPU Current Capability [Auto]**

This item provides a total power range for CPU overclocking. A higher value setting provides higher power consumption delivery and extends the overclocking frequency range simultaneously.

Configuration options: [Auto] [100%] [110%] [120%] [130%] [140%]

### **CPU Power Thermal Control [120]**

A higher temperature brings a wider CPU power thermal range and extends the overclocking tolerance to enlarge the overclocking potential. Use the <+> or <-> keys to adjust the value. The values depend on the CPU installed.



---

DO NOT remove the thermal module. The thermal conditions should be monitored.

---

### **DRAM AB/CD Current Capability [100%]**

This item adjusts the total power range for DRAM overclocking. Set a higher value to provide a wider total power range and extends the overclocking frequency range simultaneously.

Configuration options: [100%] [110%] [120%] [130%]

### **DRAM AB/CD Switching Frequency [Auto]**

This item affects the overclocking range and system stability. Set this item to **[Manual]** to manually set a fixed DRAM switching frequency for an increased overclocking range or enhanced system stability.



---

The following item appears only when you set the DRAM Switching Frequency to **[Manual]**.

---

#### **Fixed DRAM AB/CD Switching Frequency (KHz) [500]**

This item allows you to set a higher frequency for an increased overclocking range or a lower frequency for an enhanced system stability. Use the <+> or <-> to adjust the value. The values range from 300 KHz to 550 KHz with an interval of 50 KHz.

### **DRAM Power Phase Control (CHA-CHB/CHC-CHD) [Disabled]**

This item allows you to enable/disable the DRAM power phase control.

Configuration options: [Enabled] [Disabled]

## **Internal CPU Power Management**

The subitems in this menu allow you to set the CPU ratio and its features.

### **Enhanced Intel SpeedStep Technology [Enabled]**

This item allows the operating system to dynamically adjust the processor voltage and cores frequency which decreases the average power consumption the average heat production.

Configuration options: [Enabled] [Disabled]

### **Turbo Mode [Enabled]**

This item allows you to enable your core processor's speed to run faster than the base operating frequency when it is below operating power, current and temperature specification limit.

Configuration options: [Disabled] [Enabled]



---

The following items appear only when you set the Turbo Mode to **[Enabled]**.

---

#### **Turbo Mode Parameters**

##### **Long Duration Package Power Limit [Auto]**

Allows you to limit the Turbo Ratio's time duration that exceeds the TDP (Thermal Design Power) for maximum performance. Use the <+> or <-> keys to adjust the value. The values range from 1 W to 4095 W.

##### **Package Power Time Window [Auto]**

Also known as Power Limit 1, this item allows you to maintain the time window for Turbo Ratio over TDP (Thermal Design Power). Use the <+> or <-> keys to adjust the value. The values range from 1 to 127 in seconds.

##### **Short Duration Package Power Limit [Auto]**

Also known as Power Limit 2, this item allows you to provide rapid protection when the package power exceeds the Power Limit 1. Use the <+> or <-> keys to adjust the value. The values range from 1 W to 4095 W.

##### **CPU Integrated VR Current Limit [Auto]**

Allows you to set a higher current limit to prevent frequency and power throttling when overclocking. Use the <+> or <-> keys to adjust the value. The values range from 0.125 to 1023.875 with a 0.125 interval.

#### **CPU Internal Power Fault Control**

##### **CPU Integrated VR Fault Management [Auto]**

Disable this item to prevent tripping the Fully Integrated Voltage Regulator when doing over-voltage. We recommend you to disable this item when overclocking.

Configuration options: [Auto] [Disabled] [Enabled]

#### **CPU Internal Power Configuration**

##### **CPU Integrated VR Efficiency Management [Auto]**

This item allows you to improve the power rating when the CPU is in low power state, or make the FIVR (fully integrated voltage regulator work in high performance at all times.

Configuration options: [Auto] [High Performance] [Balanced]

#### **Fully Manual Mode [Disabled]**

Set this item to [Enabled] to support voltage control via ROG Connect and OC Panel.

Configuration options: [Disabled] [Enabled]



---

The following items appear only when you set Fully Manual Mode item to **[Enabled]**.

---

##### **Max VCore [Disabled]**

This item allows you to make the CPU Core Voltage as close to CPU Input Voltage as possible.

Configuration options: [Enabled] [Disabled]



---

The following item appears only when you set Max. Vcore item to **[Enabled]**.

---

##### **Max Cache Voltage [Disabled]**

This item allows the CPU Core Voltage as close to CPU Input Voltage as possible.

### CPU Core Voltage [Auto]

This item allows you to configure the amount of Voltage fed to the CPU cores. Increase the voltage when configuring a high CPU core frequency.

Configuration options: [Auto] [Manual Mode] [Offset Mode] [Adaptive Mode]

---



The following item appears only when you set the CPU Core Voltage to **[Manual Mode]**.

---

#### CPU Core Voltage Override [Auto]

This item allows you to configure the CPU core voltage. Use<+> or <-> key to adjust the value. The values range from 0.001V to 1.920 V at 0.001 V increment.

---



The following items appear only when you set the CPU Core Voltage to **[Offset Mode]**.

---

#### Offset Mode Sign [+]

[+] To offset the voltage by a positive value.

[-] To offset the voltage by a negative value.

#### CPU Core Voltage Offset [Auto]

This item allows you to configure the CPU core voltage offset value. Use<+> or <-> key to adjust the value. The values range from 0.001 V to 0.999V at 0.001 V increment.

---



The following items appear only when you set the CPU Core Voltage to **[Adaptive Mode]**.

---

#### Additional Turbo Mode CPU Core Voltage [Auto]

This item allows you to set the amount of voltage fed to the CPU cores when running in turbo mode. Increase the voltage when configuring a high CPU core frequency. The voltage you set is affected by the offset value. Use the <+> or <-> keys to adjust the value. The values range from 0.001 V to 1.920 V with a 0.001 V interval.

#### Total Adaptive Mode CPU Core Voltage [Auto]

This item sums up the voltages of the CPU Core Voltage offset and Additional Turbo Mode CPU Core Voltage options.

### CPU Cache Voltage [Auto]

This item allows you to configure the amount of voltage fed to the CPU uncores including it is cache. Increase the voltage when configuring a high CPU cache frequency.

Configuration options: [Auto] [Manual Mode] [Offset Mode] [Adaptive Mode]

---



The following item appears only when you set the CPU Cache Voltage to **[Manual Mode]**.

---

#### CPU Cache Voltage Override [Auto]

This item allows you to configure the CPU cache voltage. Use<+> or <-> key to adjust the value. The values range from 0.001 V to 1.920 V at 0.001 V increment.





---

The following items appear only when you set the CPU Core Voltage to **[Offset Mode]**.

---

#### **Offset Mode Sign [+]**

[+] To offset the voltage by a positive value.

[-] To offset the voltage by a negative value.

#### **CPU Cache Voltage Offset [Auto]**

This item allows you to configure the CPU cache voltage offset value. Use <+> or <-> key to adjust the value. The values range from 0.001 V to 0.999 V at 0.001 V increment.



---

The following items appear only when you set the CPU Core Voltage to **[Adaptive Mode]**.

---

#### **Additional Turbo Mode CPU Cache Voltage [Auto]**

This item allows you to set the amount of voltage fed to the CPU cores when running in turbo mode. Increase the voltage when configuring a high CPU core frequency. The voltage you set is affected by the offset value. Use the <+> or <-> keys to adjust the value. The values range from 0.001 V to 1.920 V with a 0.001 V interval.

#### **Total Adaptive Mode CPU Cache Voltage [Auto]**

This item sums up the voltages of the CPU Cache Voltage offset and Additional Turbo Mode CPU Cache Voltage options.

### **CPU System Agent Voltage Offset Mode Sign [+]**

[+] To offset the voltage by a positive value.

[-] To offset the voltage by a negative value.

#### **CPU System Agent Voltage Offset [Auto]**

This item allows you to set the amount of voltage fed to the system agent of the processor including its PCIe controller and power control unit (PCU). Setting a high system agent voltage may enhance the overclocking capability. Use the <+> or <-> key to adjust the value. The values range from 0.001 V to 0.999 V at 0.001 V increment.

### **CPU SVID Support [Auto]**

Set this item to [Enabled] when overclocking. Disabling this item prevents the CPU from communicating with the external voltage regulator.

Configuration options: [Auto] [Disabled] [Enabled]



---

The following items appear only when you set the CPU Core Voltage to **[Auto]** or **[Disabled]**.

---

#### **SVID Voltage Override[Auto]**

This item allows you to set a VCCIN for the CPU during initial part of POST. Use the <+> or <-> key to adjust the value. The values range from 0.001 V to 2.440 V at 0.001 V increment.

#### **SVID VDDQ Voltage Override [Auto]**

This item allows you to set a VCCIN for the CPU before OS loading. Use the <+> or <-> key to adjust the value. The values range from 0.001 V to 2.440 V at 0.001 V increment.

### **CPU Input Voltage [Auto]**

This item allows you to configure the input voltage for the CPU by the external voltage regulator. Use the <+> or <-> key to adjust the value. The values range from 0.80 V to 2.70 V at 0.010 V increment.

### **DRAM SVID Support [Auto]**

Set this item to [Disabled] to stop the CPU from communicating with the external voltage regulator. Disable this item when you overclock your system.

Configuration options: [Auto] [Disabled] [Enabled]

### **DRAM Voltage (CHA/CHB, CHC/CHD) [Auto]**

This item allows you to set the voltage for the system memory. Use the <+> or <-> key to adjust the value. The values range from 0.80 V to 1.90 V at 0.010 V increment.



---

According to Intel® CPU specifications, DIMMs with voltage requirement over 1.65 V may damage the CPU permanently. We recommend that you install the DIMMs with the voltage requirement below 1.65 V.

---

### **PCH Core Voltage [Auto]**

This item allows you to configure the core voltage for the PCH (platform controller hub). Use the <+> or <-> key to adjust the value. The values range from 0.70 V to 1.80 V at 0.00625 V increment.

### **PCH I/O Voltage [Auto]**

This item allows you to configure the I/O voltage for the PCH (platform controller hub). Use the <+> or <-> key to adjust the value. The values range from 1.20 V to 2.20 V at 0.00625 V increment.

### **VCCIO CPU 1.05V Voltage [Auto]**

This item allows you to set the main power supply for the CPU REF. Use the <+> or <-> key to adjust the value. The values range from 0.7000 V to 1.8000 V at 0.00625 V increment.

### **VCCIO PCH 1.05V Voltage [Auto]**

This item allows you to set the main power supply for the PCH REF. Use the <+> or <-> key to adjust the value. The values range from 0.7000 V to 1.8000 V at 0.00625 V increment.

### **VTTDR Voltage (CHA/CHB) [Auto]**

This item allows you to set the termination voltage for the DRAM on the left. Use the <+> or <-> key to adjust the value. The values range from 0.2000 V to 1.0000 V at 0.00625 V increment.

### **VTTDR Voltage (CHC/CHD) [Auto]**

This item allows you to set the termination voltage for the DRAM on the right. Use the <+> or <-> key to adjust the value. The values range from 0.2000 V to 1.0000 V at 0.00625 V increment.

### **PLL Termination Voltage [Auto]**

This item allows you to terminate the PLL Voltage. You can use the <+> or <-> keys to adjust the value. The values range from 0.20000 V to 3.098278 V with a 0.006602 V interval.

#### **PLL Reference Offset Mode Sign [+]**

[+] To offset the voltage by a positive value.

[-] To offset the voltage by a negative value.

#### **PLL Reference Offset Value [Auto]**

This item allows you to configure the PLL reference value. You can use the <+> or <-> keys to adjust the value.

Configuration options: [Auto] [1] - [20]

### **CPU Spread Spectrum [Auto]**

This item allows you to enhance the BCLK overclocking capability or reduce the EMI (electromagnetic disturbance) generated by the BCLK. Set this item to [Enabled] for EMI reduction, or set this item to [Disabled] to enhance BCLK overclocking.

Configuration options: [Auto] [Disabled] [Enabled]

### 3.6 Advanced menu

The Advanced menu items allow you to change the settings for the CPU and other system devices.



Be cautious when changing the settings of the Advanced menu items. Incorrect field values can cause the system to malfunction.

ASUS UEFI BIOS Utility - Advanced Mode

01/03/2000 Monday 04:02 English MyFavorite(F3) Qfan Control(F6) EZ Tuning Wizard(F11) Quick Note(F9) Hot Keys

My Favorites Main Ai Tweaker **Advanced** Monitor Boot Tool Exit

- > CPU Configuration
- > PCH Configuration
- > PCH Storage Configuration
- > System Agent Configuration
- > USB Configuration
- > Platform Misc Configuration
- > Onboard Devices Configuration
- > APM Configuration
- > Network Stack Configuration

Intel(R) Ethernet Connection (2) I218-LM - 88:88:88:88:87:88

Intel(R) I210 Gigabit Network Connection - 00:1E:99:00:00:70

Hardware Monitor

**CPU**

Frequency	Temperature
3500 MHz	39°C
BCLK	Vcore
100.0 MHz	1.008 V
Ratio	
35x	

**Memory**

Frequency	Vol_CHAB
2133 MHz	1.203 V
Capacity	Vol_CHCD
4096 MB	1.209 V

**Voltage**

+12V	+5V
11.808 V	4.800 V
+3.3V	
2.992 V	

Version 2.16.1242. Copyright (C) 2014 American Megatrends, Inc.

Last Modified | EzMode(F7)

## 3.6.1 CPU Configuration

The items in this menu show the CPU-related information that the BIOS automatically detects.



The items in this menu may vary based on the CPU installed.



### Hyper-Threading [ALL] [Enabled]

This item allows you to enable/disable the Hyper-Threading for logical processor threads.  
Configuration options: [Enabled] [Disabled]

### Intel Adaptive Thermal Monitor [Enabled]

This item allows you to protect the CPU by decreasing its frequency as it reaches the thermal throttle point. The thermal monitor includes TM1 (Thermal monitor 1), TM2 (Thermal monitor 2), and EMTTM (Enhanced Multi-threaded Thermal Monitoring).

Configuration options: [Disabled] [Enabled]

### Limit CPUID Maximum [Disabled]

When set to [Enabled], this item allows the legacy OS to boot even without support for CPUs with extended CPUID functions.

Configuration options: [Disabled] [Enabled]

### Execute Disable Bit [Enabled]

Execute Disable prevents certain classes of malicious buffer overflow attacks when combined with a supporting OS (SuSE Linux 9.2, RedHat Enterprise 3 Update 3).

Configuration options: [Disabled] [Enabled]

### **Intel Virtualization Technology [Disabled]**

When set to **[Enabled]**, a VMM can utilize the additional hardware capabilities provided by Vanderpool Technology.

Configuration options: [Disabled] [Enabled]

### **Hardware Prefetcher [Enabled]**

This item allows the CPU to prefetch commands and data in the L2 cache, reduces the DRAM loading time and improves the system performance.

Configuration options: [Disabled] [Enabled]

### **Adjacent Cache Line Prefetcher [Enabled]**

This item allows the mid level cache (L2) to prefetch adjacent cache lines, reducing the DRAM loading time and improves the system performance.

Configuration options: [Disabled] [Enabled]

### **Boot Performance Mode [Max Performance]**

This item allows you to select the CPU performance state during system boot before the operating system takes control. The CPU runs at a selected performance ratio based on CPU configuration.

Configuration options: [Max Efficient] [Turbo Performance]

### **Active Processor Cores**

The items in this menu allow you to enable/disable the cores of your CPU.

#### **Active Processor Core (0-5) [Enabled]**

Configuration options: [Enabled] [Disabled]

### **CPU Power Management Configuration**

The items in this menu allow you to manage and configure the CPU's power.

#### **Enhanced Intel SpeedStep Technology [Enabled]**

This item allows your system to adjust the CPU's voltage and cores frequency, resulting in decreased power consumption and heat production.

[Disabled]      The CPU runs at its default speed.

[Enabled]        The system controls the CPU speed.

#### **Turbo Mode [Enabled]**

This item allows you to automatically set the CPU cores to run faster than the base operating frequency when it is below the operating power, current and temperature specification limit.

Configuration options: [Enabled] [Disabled]

#### **CPU states [Auto]**

This item allows you to set the power saving of the CPU states.

Configuration options: [Auto] [Disabled] [Enabled]



The following items appear only when you set the CPU states to **[Enabled]**.

#### **Enhanced C1 state [Enabled]**

This item allows your CPU to reduce power consumption when the system is in idle mode.

Configuration options: [Enabled] [Disabled]

#### **CPU C3 Report [Enabled]**

This item allows you to disable or enable the CPU C3 report to the operating system.

Configuration options: [Enabled] [Disabled]

#### **CPU C6 Report [Enabled]**

This item allows you to disable or enable the CPU C6 report to the operating system.

Configuration options: [Enabled] [Disabled]

#### **Package C State Support [Auto]**

This item allows you to set the a C-state support for the CPU package.  
Configuration options: [Auto] [Enabled] [C0/C1] [C2] [C3] [C6] [CPU C7] [CPU C7s]

## 3.6.2 PCH Configuration

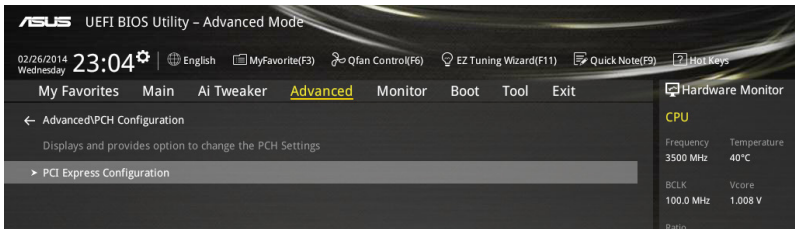

### PCI Express Configuration

This item allows you to configure the PCI Express slots.

#### **PCIe Speed [Auto]**

This item allows your system to automatically select the PCI Express port speed. When set to [Gen1], the PCI-E port runs at PCI-E 1.0 speed. When set to [Gen2], the PCI-E port runs at PCI-E 2.0 speed.

Configuration options: [Auto] [Gen1] [Gen2]

### 3.6.3 PCH Storage Configuration

While entering Setup, the BIOS automatically detects the presence of SATA devices. The SATA Port items show **Not Present** if no SATA device is installed to the corresponding SATA port.

Scroll down to display the other BIOS items.

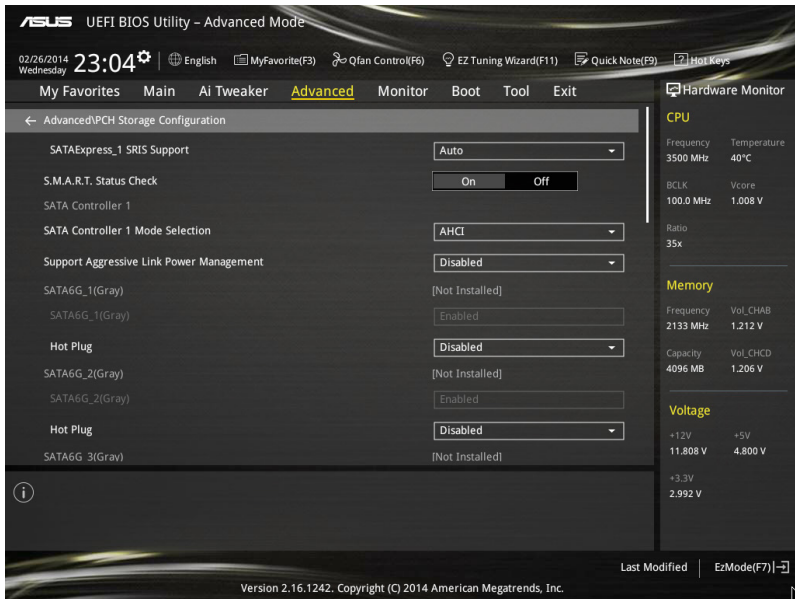

#### SATAExpress\_1 SRIS Support [Auto]

When set to **[Auto]**, this item allows the system to automatically adjust the SRIS (Separate Reference Clock Independent Spread Spectrum Clocking Architecture) support for connected SATA Express devices. Set this item to **[Disabled]** to activate ASUS RUNWAY SATA Express bridge card

Configuration options: [Auto] [Disabled]

#### S.M.A.R.T. Status Check [On]

S.M.A.R.T. (Self-Monitoring, Analysis and Reporting Technology) is a monitoring system that shows a warning message during POST (Power-on Self Test) when an error occurs in the hard disks.

Configuration options: [On] [Off]



## SATA Controller 1 Mode Selection [AHCI]

This item allows you to set the SATA configuration.

- [Disabled] Disables the SATA function.
- [IDE Mode] Set to [IDE Mode] when you want to use the Serial ATA hard disk drives as Parallel ATA physical storage devices.
- [AHCI Mode] Set to [AHCI Mode] when you want the SATA hard disk drives to use the AHCI (Advanced Host Controller Interface). The AHCI allows the onboard storage driver to enable advanced Serial ATA features that increases storage performance on random workloads by allowing the drive to internally optimize the order of commands.
- [RAID Mode] Set to [RAID Mode] when you want to create a RAID configuration from the SATA hard disk drives.



---

The following item appears only when you set the SATA Mode Selection to [IDE].

---

### SATA6G\_1-6 (Gray)

These items display all connected devices to SATA6G ports. If some ports are not used, these items show [Not Installed].

## SATA Controller 2 Mode Selection [AHCI]

This item allows you to set the SATA configuration.

- [Disabled] Disables the SATA function.
- [IDE Mode] Set to [IDE Mode] when you want to use the Serial ATA hard disk drives as Parallel ATA physical storage devices.
- [AHCI Mode] Set to [AHCI Mode] when you want the SATA hard disk drives to use the AHCI (Advanced Host Controller Interface). The AHCI allows the onboard storage driver to enable advanced Serial ATA features that increases storage performance on random workloads by allowing the drive to internally optimize the order of commands.



---

Due to Intel® chipset specification, the SATA ports from SATA controller 2 does not support Intel® Rapid Storage Technology including RAID configuration.

---



---

The following item appears only when you set the SATA Mode Selection to [IDE].

---

### SATA6G\_7-10 (Black)

These items display all connected devices to SATA6G ports. If some ports are not used, these items show [Not Installed].

## Support Aggressive Link Power Management [Disabled]

This item is designed for LPM (link power management) support with a better energy saving conditions. When disabled, the hot plug function of SATA ports are disabled.

Configuration options: [Disabled] [Enabled]

## Hot Plug [Disabled] (SATA6G\_1-6 (Gray) / SATA6G\_7-10 (Black))

These items allow you to enable/disable SATA Hot Plug Support.

Configuration options: [Disabled] [Enabled]

## 3.6.4 System Agent Configuration

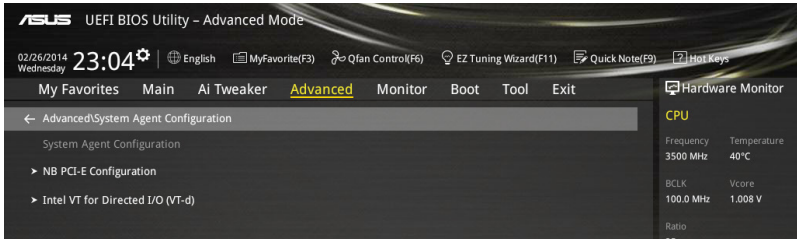

### NB PCI-E Configuration

The items in this menu allow you to select the operating speeds of the PCIe slots.

#### PCIEX16\_1 Link Speed [Auto]

This item allows you to select the operating speed of the PCIEX16\_1 slot.  
Configuration options: [Auto] [Gen1] [Gen2] [Gen3]

#### PCIEX16\_2 Link Speed [Auto]

This item allows you to select the operating speed of the PCIEX16\_2 slot.  
Configuration options: [Auto] [Gen1] [Gen2] [Gen3]

#### PCIEX16\_3 Link Speed [Auto]

This item allows you to select the operating speed of the PCIEX16\_3 slot.  
Configuration options: [Auto] [Gen1] [Gen2] [Gen3]

#### PCIEX16\_4 Link Speed [Auto]

This item allows you to select the operating speed of the PCIEX16\_4 slot.  
Configuration options: [Auto] [Gen1] [Gen2] [Gen3]

#### PCIEX16\_5 Link Speed [Auto]

This item allows you to select the operating speed of the PCIEX16\_5 slot.  
Configuration options: [Auto] [Gen1] [Gen2] [Gen3]

#### PCIEX16\_6 Link Speed [Auto]

This item allows you to select the operating speed of the PCIEX16\_6 slot.  
Configuration options: [Auto] [Gen1] [Gen2] [Gen3]

#### PCIEX16\_7 Link Speed [Auto]

This item allows you to select the operating speed of the PCIEX16\_7 slot.  
Configuration options: [Auto] [Gen1] [Gen2] [Gen3]

### Intel VT for Directed I/O (VT-d)

The items in this menu allow you to configure the Intel® Virtualization Technology for Directed I/O (VT-d).

#### VTd Azalea VcP Optimizations [Disabled]

This item allows you to enable/disable the Azalea VcP Optimizations.  
Configuration options: [Enabled] [Disabled]

### **Intel VT for Directed I/O (VT-d) [Disabled]**

This item allows you to enable/disable the Intel Virtualization Technology for Directed I/O (VT-d) by reporting the I/O device assignment to VMM through DMAR ACPI Tables.  
Configuration options: [Enabled] [Disabled]

---



The following items appear only when you set the Intel VT for Directed I/O (VT-d) to **[Enabled]**.

---

#### **Interrupt Remapping [Enabled]**

This item allows you to enable/disable the VT-D Interrupt Remapping Support.

Configuration options: [Enabled] [Disabled]

#### **Coherency Support (Non-Isoch) [Enabled]**

This item allows you to enable/disable the Non-Isoch VT\_D Engine Coherency Support.

Configuration options: [Enabled] [Disabled]

#### **Coherency Support (Isoch) [Enabled]**

This item allows you to enable/disable the Isoch VT\_D Engine Coherency Support.

Configuration options: [Enabled] [Disabled]

## 3.6.5 USB Configuration

The items in this menu allow you to change the USB-related features.

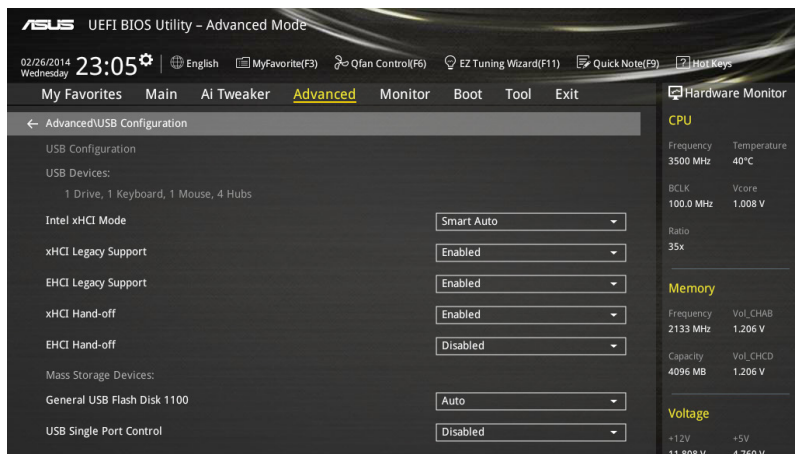

The **Mass Storage Devices** item shows the auto-detected values. If no USB device is detected, the item shows **None**.

### Intel xHCI Mode [Smart Auto]

- [Auto] The xHCI is automatically enabled and runs at USB 3.0 mode when the xHCI driver is installed in the operating system.
- [Smart Auto] Upon detection, the xHCI driver supports the USB 3.0 mode during both POST and operating system.
- [Enabled] Enables the xHCI controller.
- [Disabled] Disables the xHCI controller.

### xHCI Legacy USB Support [Enabled]

- [Enabled] Your system supports the USB 3.0 devices in legacy operating systems.
- [Disabled] Your USB 3.0 devices can be used for BIOS setup only and cannot be recognized in the boot devices list.
- [Auto] Your system automatically detects the presence of USB3.0 devices at startup. If any USB 3.0 devices are detected, the xHCI legacy USB support is enabled.

### EHCI Legacy USB Support [Enabled]

- [Enabled] Your system supports the USB 2.0 devices in legacy operating systems.
- [Disabled] Your USB 2.0 devices can be used for BIOS setup only and cannot be recognized in the boot devices list.
- [Auto] Your system automatically detects the presence of USB 2.0 devices at startup. If any USB 2.0 devices are detected, the xHCI legacy USB support is enabled.

### **xHCI Hand-off [Disabled]**

[Enabled] Enables the support for operating systems without an xHCI hand-off feature.

[Disabled] Disables the xHCI Hand-off support.

### **EHCI Hand-off [Disabled]**

[Enabled] Enables the support for operating systems without an EHCI hand-off feature.

[Disabled] Disables the EHCI Hand-off support.

### **USB Single Port Control**

This item allows you to enable or disable the individual USB ports.



---

Refer to section **1.2.2 Motherboard layout** for the location of the USB ports.

---

### 3.6.6 Platform Misc Configuration

The items in this menu allow you to configure the platform-related features.

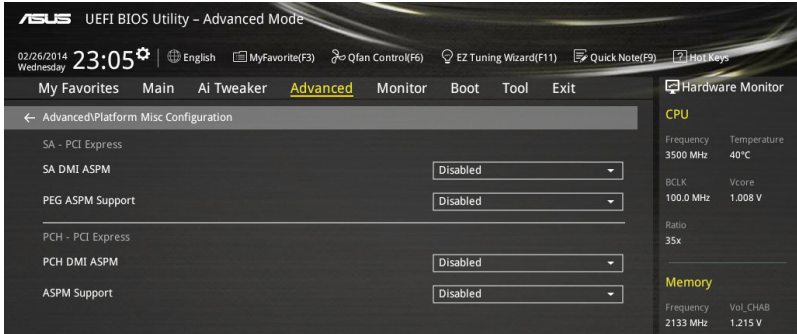

#### SA - PCI Express

##### SA SMI ASPM [Disabled]

This item allows you to enable/disable the ASPM (L1) support for the downstream devices.  
Configuration options: [Auto] [Disabled] [L1 only]

##### PEG ASPM Support [Disabled]

This item allows you to enable/disable the ASPM support for the downstream devices.  
Configuration options: [Disabled] [L1 only]

#### PCH - PCI Express

##### PCH DMI ASPM [Disabled]

This item allows you to enable/disable the PCH DMI ASPM Setting.  
Configuration options: [Disabled] [Enabled]

##### ASPM Support [Disabled]

This item allows you to enable/disable the ASPM support for all downstream devices.  
Configuration options: [Disabled] [L1 only]

## 3.6.7 Onboard Devices Configuration

Scroll down to view the other BIOS items.

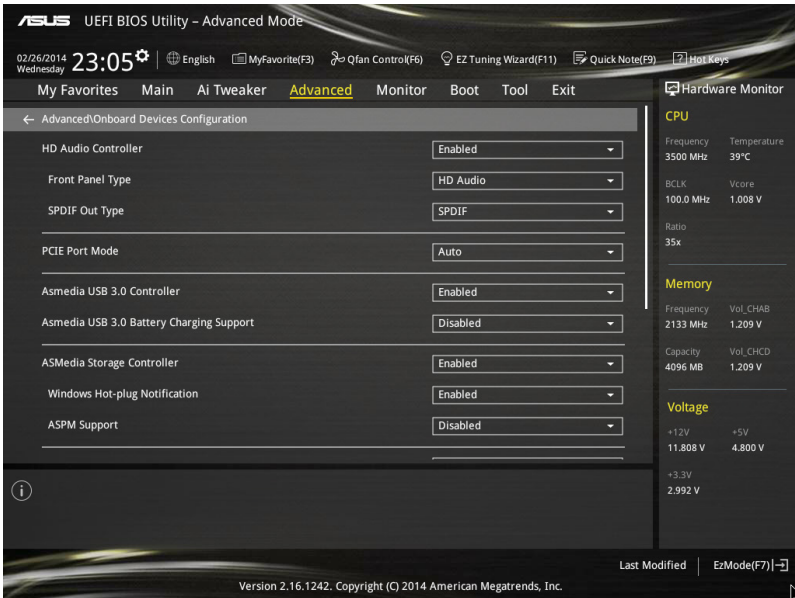

### HD Audio Controller [Enabled]

This item allows you to use the Azalia High Definition Audio Controller

Configuration options: [Disabled] [Enabled]



The following items appear only when you set the HD Audio Controller to **[Enabled]**.

#### Front Panel Type [HD Audio]

This item allows you to set the front panel audio connector (AAFP) mode to legacy AC'97 or high-definition audio depending on the audio standard that the front panel audio module supports.

[HD Audio] Sets the front panel audio connector (AAFP) mode to high definition audio.

[AC97] Sets the front panel audio connector (AAFP) mode to legacy AC'97.

#### SPDIF Out Type [SPDIF]

[SPDIF] Sets to an SPDIF audio output.

[HDMI] Sets to an HDMI audio output.

### PCI-EX16\_2 Slot (Black) Bandwidth [Audio]

- [Auto] Runs at x8 mode when the installed PCIe device is higher than x4 interface for high system performance.
- [X2 Mode] Runs at x2 mode with USB3.1\_E12 enabled. The SATAEXPRESS\_E1 is disabled.
- [X4 Mode] Runs at x4 mode for a high performance support with USB3.1\_E12 and the SATAEXPRESS\_E1 is disabled.
- [X8 Mode] Runs at x8 mode a high system performance.
- [Disabled] Disables the PCIEX16\_2 slot. The USB3.1\_E12 and SATAEXPRESS\_E1 are enabled.

### ASMedia USB 3.1 Controller [Enabled]

This item allows you to enable/disable the ASMedia® USB 3.1 controller of your system.

Configuration options: [Disabled] [Enabled]



---

The following item appears only when you set the ASMedia USB 3.1 Controller to **[Enabled]**.

---

### ASMedia USB 3.1 Battery Charging Support [Disabled]

This item allows you to enable/disable the ASMedia® USB 3.1 battery charging support of your system.

Configuration options: [Disabled] [Enabled]

### ASMedia Storage Controller [Enabled]

This item allows you to enable/disable the ASMedia storage Controller.

Configuration options: [Disabled] [Enabled]



---

The following items appear only when you set the ASMedia Storage Controller to **[Enabled]**.

---

### Windows Hot-plug Notification [Disabled]

This item allows you to enable/disable the Hot Plug notification in Windows® operating system.

Configuration options: [Disabled] [Enabled]

### ASPM Support [Enabled]

This item allows you to enable/disable the ASPM (active state power management) controller to save energy when using the ASM1060SE Storage Controller.

Configuration options: [Disabled] [Enabled]



## ASM106SE Storage Controller (SATAEXPRESS\_E1) [Enabled]

This item allows you to enable/disable the ASMedia storage Controller.

Configuration options: [Disabled] [Enabled]



---

The following items appear only when you set the ASM106SE Storage Controller (SATAEXPRESS\_E1) to **[Enabled]**.

---

### Windows Hot-plug Notification [Disabled]

This item allows you to enable/disable the Hot Plug notification in Windows® operating system.

Configuration options: [Disabled] [Enabled]

### ASPM Support [Enabled]

This item allows you to enable/disable the ASPM (active state power management) controller to save energy when using the ASM106SE Storage Controller.

Configuration options: [Disabled] [Enabled]

### SATAExpress\_E1 SRIS Support [Enabled]

[Auto] Automatically adjusts the SRIS (Separate Reference Clock Independent Spectrum Clocking Architecture) support for connected SATA Express devices.

[Disabled] Select for ASUS RUNWAY SATA Express bridge card.

## Intel LAN Controller (LAN1-LAN2) [Enabled]

This item allows you to enable or disable the Intel LAN1/2 controllers.

Configuration options: [Disabled] [Enabled]



---

The following item appears only when you set the Intel LAN Controller to **[Enabled]**.

---

### Intel PXE OPROM (LAN1-LAN2) [On]

This item allows you to turn on or turn off the PXE OptionRom of the Intel® LAN controller.

Configuration options: [On] [Off]

## 3.6.8 APM Configuration

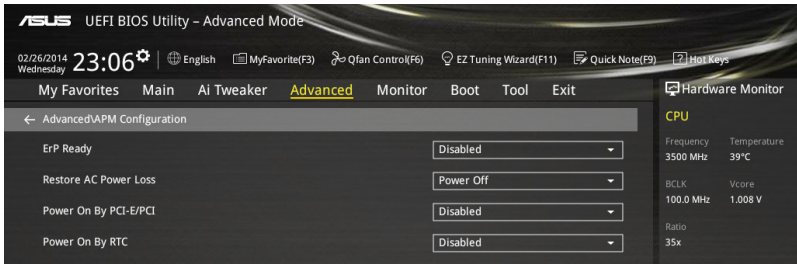

### ErP Ready [Disabled]

This item allows you to switch off some power at S4+S5 or S5 to get the system ready for ErP requirement. When set to **[Enabled]**, all other PME options are switched off.

Configuration options: [Disabled] [Enabled (S4+S5)] [Enabled (S5)]

### Restore AC Power Loss [Power Off]

This item allows your system to go to ON state, OFF state, or both states after an AC power loss. When setting your system to [Last State], it goes to the previous state before the AC power loss.

Configuration options: [Power Off] [Power On] [Last State]

### Power On By PCI-E/PCI [Disabled]

This item allows you to enable/disable the Wake-on-LAN function of the onboard LAN controller or other installed PCI-E LAN cards.

Configuration options: [Disabled] [Enabled]

### Power On By RTC [Disabled]

This item allows you to enable/disable the RTC (Real-Time Clock) to generate a wake event and configure the RTC alarm date. When enabled, you can set the days, hours, minutes, or seconds to schedule an RTC alarm date.

Configuration options: [Disabled] [Enabled]

## 3.6.9 Network Stack Configuration

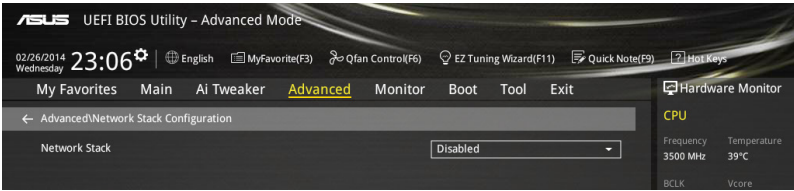

### Network stack [Disabled]

This item allows you to disable/enable the UEFI network stack.

Configuration options: [Disabled] [Enabled]



---

The following item appears only when you set the Network Stack to **[Enabled]**.

---

### Ipv4/Ipv6 PXE Support [Enabled]

This item allows you to enable/disable the Ipv4/Ipv6 PXE wake event.

Configuration options: [Disabled] [Enabled]

### PXE boot wait time [0]

This item allows you to set a wait time to press ESC key to abort the PXE boot. You can use the <+> or <-> keys to adjust the value. The values range from 0 to 5 seconds.

### 3.6.10 Intel(R) Ethernet Connection (2) I218-LM 00:1E:99:00:00:37

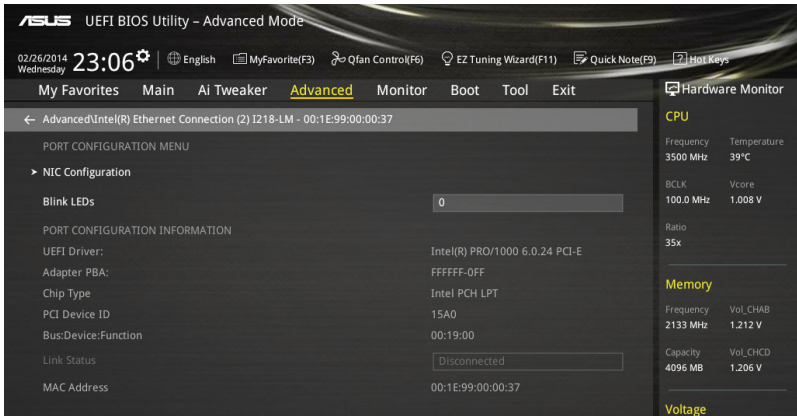

#### NIC Configuration

The items in this menu allow you to configure the boot protocol, Wake-on LAN, link speed, and virtual LAN.

##### Link Speed [Auto Negotiated]

This item allows you to specify the port speed used for the selected boot protocol. Configuration options: [Auto Negotiated] [10 Mbps Half] [10 Mbps Full] [100 Mbps Half] [100 Mbps Full]

##### Wake On LAN [Enabled]

This item allows you enable/disable the server to be powered on using an in-band magic packet.

##### Blink LEDs [0]

This item allows you to identify the physical network port with the blinking associated LEDs. Use the number keys to key in the number. The values range from 0 to 15.

## 3.6.11 Intel(R) I210 Gigabit Network Connection - 00:1E:99:00:00:38

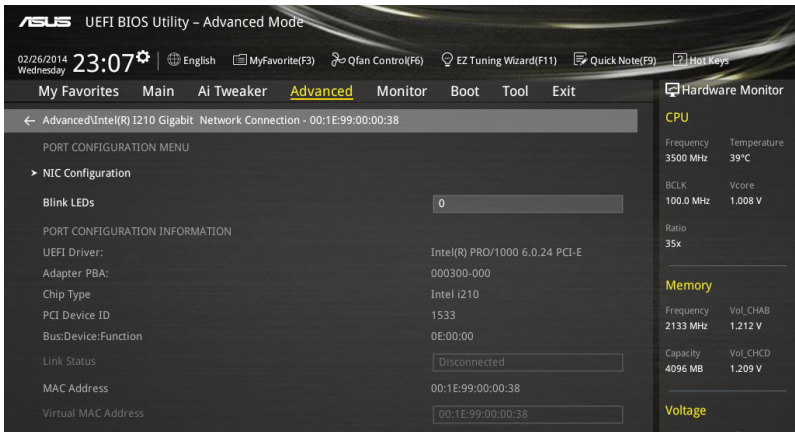

### NIC Configuration

The items in this menu allow you to configure the boot protocol, Wake-on LAN, link speed, and virtual LAN.

#### Link Speed [Auto Negotiated]

This item allows you to specify the port speed used for the selected boot protocol.  
Configuration options: [Auto Negotiated] [10 Mbps Half] [10 Mbps Full] [100 Mbps Half] [100 Mbps Full]

#### Wake On LAN [Enabled]

This item allows you enable/disable the server to be powered on using an in-band magic packet.

#### Blink LEDs [0]

This item allows you to identify the physical network port with the blinking associated LEDs. Use the number keys to key in the number. The values range from 0 to 15.

## 3.7 Monitor menu

The Monitor menu displays the system temperature/power status, and allows you to change the fan settings.

Scroll down to display the other BIOS items.



### CPU Temperature / MB Temperature / VRM Temperature / PCH Core Temperature / T-SENSOR1 Temperature [xxx°C/xxx°F]

The onboard hardware monitor automatically detects and displays the CPU, motherboard, VRM, PCH Core, and T-SENSOR1 temperatures. Select **[Ignore]** if you do not wish to display the detected temperatures.

### CPU Fan Speed [xxxx RPM] or **[Ignore]** / **[N/A]**, CPU Optional Fan Speed [xxxx RPM] or **[Ignore]** / **[N/A]**, Chassis Fan 1/4 Speed [xxxx RPM] or **[Ignore]** / **[N/A]**

The onboard hardware monitor automatically detects and displays the CPU, chassis, and power fan speed in rotations per minute (RPM). If the fan is not connected to the motherboard, the field shows N/A. Select **[Ignore]** if you do not wish to display the detected speed.

### CPU Core Voltage, 3.3V Voltage, 5V Voltage, 12V Voltage

The onboard hardware monitor automatically detects the voltage output through the onboard voltage regulators. Select **[Ignore]** if you do not want to detect this item.

### Qfan Tuning

Click this item to automatically detect the lowest speed and configure the minimum duty cycle for each fan.

## CPU Q-Fan Control [Auto]

This item allows you to set the CPU Q-Fan operating mode.

- |            |   |
|------------|---|
| [Auto]     | Detects the type of CPU fan installed and automatically switches the control modes. |
| [PWM Mode] | Enables the CPU Q-Fan control feature in PWM mode for 4-pin CPU fan.                |
| [DC Mode]  | Enables the CPU Q-Fan control feature in DC mode for 3-pin CPU fan.                 |
| [Disabled] | Disables the Q-Fan control.   |



---

The following items appear only when you set the CPU Q-Fan Control to **[Auto]**, **[PWM Mode]**, and **[DC Mode]**.

---

### CPU Fan Speed Low Limit [300 RPM]

This item allows you to set the low limit warning for CPU Fan speed.

Configuration options: [Ignore] [200 RPM] [300 RPM] [400 RPM] [500 RPM] [600 RPM]

### CPU Fan Profile [Standard]

This item allows you to set the appropriate performance level of the CPU fan.

- |            |  |
|------------|--|
| [Standard] | Set to make the CPU fan adjust automatically depending on the CPU temperature. |
| [Silent]   | Set to minimize the fan speed for quiet CPU fan operation.                     |
| [Turbo]    | Set to achieve maximum CPU fan speed.  |
| [Manual]   | Set to assign the detailed fan speed control parameters.                       |



---

The following items appear only when you set the CPU Fan Profile to **[Manual]**.

---

#### CPU Upper Temperature [70]

Use the <+> or <-> keys to adjust the upper limit of the CPU temperature. The values range from 25°C to 75°C.

#### CPU Fan Max. Duty Cycle(%) [100]

Use the <+> or <-> keys to adjust the maximum CPU fan duty cycle. The values may differ via Qfan tuning.

#### CPU Middle Temperature [25]

Use the <+> or <-> keys to set the value for CPU Middle Temperature. The range of the values depends on the CPU installed.

#### CPU Fan Middle Duty Cycle(%) [20]

Use the <+> or <-> keys to adjust the CPU fan middle duty cycle. The values may differ via Qfan tuning.

#### CPU Lower Temperature [20]

Use the <+> or <-> keys to adjust the CPU fan's lower temperature. The values range from 20% to 75%.

#### CPU Fan Min. Duty Cycle(%) [20]

Use the <+> or <-> keys to adjust the minimum CPU fan duty cycle. The values may differ via Qfan tuning.

## Chassis Fan 1/4 Q-Fan Control [DC Mode]

These items allow you to set the chassis fans' Q-Fan control feature into DC Mode, PWM Mode, or disable these Q-Fan controls from your motherboard.

Configuration options: [Disabled] [DC Mode] [PWM Mode]



---

The following items appear only when you set the Chassis Fan 1/4 Q-Fan Control to **[Disabled]**.

---

### Chassis Fan 1/4 Q-Fan Source [CPU]

This item controls the assigned fan according to the selected temperature source.

Configuration options: [CPU] [MB] [VRM] [PCH] [T\_SENSOR1] [EXT\_SENSOR1] [EXT\_SENSOR2] [EXT\_SENSOR3]



---

If you select T\_SENSOR1, plug a thermistor cable to T\_SENSOR1 header and stick the thermistor cable's head to the desired component as the temperature source.

---



---

The following items appear only when you set the Chassis Fan 1/4 Q-Fan Control to **[PWM Mode]** or **[DC Mode]**.

---

### Chassis Fan 1/4 Speed Low Limit 1/4 [300 RPM]

This item allows you to disable or set the chassis fans' warning speed.

Configuration options: [Ignore] [200 RPM] [300 RPM] [400 RPM] [500 RPM] [600 RPM]

### Chassis Fan 1/4 Profile [Standard]

This item allows you to set the appropriate performance level of the chassis fan.

[Standard] Set to make the chassis fan adjust automatically depending on the chassis temperature.

[Silent] Set to minimize the fan speed for quiet chassis fan operation.

[Turbo] Set to achieve maximum chassis fan speeds.

[Manual] Set to assign detailed fan speed control parameters.



---

The following items appear only when you set the Chassis Fan Profile to **[Manual]**.

---

### Chassis Fan 1/4 Upper Temperature [70]

Use the <+> or <-> keys to adjust the upper limit of the CPU temperature. The values range from 40°C to 90°C.

### Chassis Fan 1/4 Max. Duty Cycle(%) [100]

Use the <+> or <-> keys to adjust the maximum chassis fan duty cycle. The values may differ via Qfan tuning.

### Chassis Fan 1/4 Middle Temperature [45]

Use the <+> or <-> keys to set the value for Chassis Fan Middle Temperature.

### Chassis Fan 1/4 Middle Duty Cycle(%) [60]

Use the <+> or <-> keys to adjust the chassis fan middle duty cycle. The values may differ via Qfan tuning.



**Chassis Fan 1/4 Lower Temperature [40]**

Use the <+> or <-> keys to adjust the chassis fans' lower temperature. The values may differ via Qfan tuning.

**Chassis Fan 1/4 Min. Duty Cycle(%) [60]**

Use the <+> or <-> keys to adjust the minimum chassis fan duty cycle. The values may differ via Qfan tuning.

**Anti Surge Support [ON]**

This item allows you to on/off the OVP (Over Voltage Protection) and UVP (Under Voltage Protection) functions. This causes the system to automatically shut down when the voltage exceeds the safe range that protects the motherboard's components.

Configuration options: [ON] [OFF]

**Chassis Intrude Detect Support [ON]**

This item allows you to on/off the chassis intrude detect feature.

Configuration options: [ON] [OFF]

## 3.8 Boot menu

The Boot menu items allow you to change the system boot options.

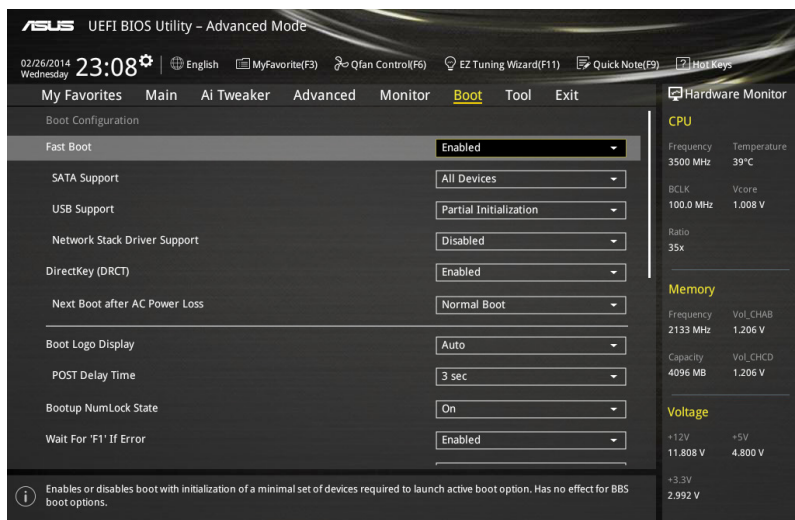

### Boot Configuration

#### Fast Boot [Enabled]

[Disabled] This item allows your system to go back to its normal boot speed.

[Enabled] This item allows your system to accelerate the boot speed.



The following items appear only when you set the Fast Boot to **[Enabled]**.

#### SATA Support [All Devices]

[All Devices] All devices connected to SATA ports are available during POST. This process extends the POST time.

[Hard Drive Only] Only hard drives connected to SATA ports are detected during POST.

[Boot Drive Only] Only boot drives connected to a SATA ports are detected during POST.

#### USB Support [Partial Initialization]

[Disabled] All USB devices will not be available until OS boot up for a fastest POST time.

[Full Initialization] All USB devices will be available during POST. This process will extend the POST time.

[Partial Initialization] For a faster POST time, only USB ports with keyboard and mouse connections will be detected.

### Network Stack Driver Support [Disabled]

- [Disabled] Select to skip the network stack driver from loading during POST.
- [Enabled] Select to load the network stack driver during POST.

### Next Boot after AC Power Loss [Normal Boot]

- [Normal Boot] Returns to normal boot on the next boot after an AC power loss.
- [Fast Boot] Accelerates the boot speed on the next boot after an AC power loss.

### DirectKey (DRCT) [Enabled]

- [Disabled] Disables the DirectKey button. The system will only power on or off when you press the DirectKey button.
- [Enabled] Allows the system to power on and go to the BIOS Setup directly when you press the Reset button. Connect the 2-pin connector of the chassis reset button cable to the onboard DRCT header.

### Boot Logo Display [Auto]

- [Auto] Sets the boot logo to display during POST.
- [Full Screen] Sets the boot logo display in full screen during POST.
- [Disabled] Disables the boot logo display during POST.



---

The following item appears only when you set the Boot Logo Display to **[Auto]** and **[Full Screen]**.

---

### Post Delay Time [3 sec]

This item allows you to select a desired additional POST waiting time to easily enter the BIOS Setup. You can only execute the POST delay time during normal boot. The values range from 0 to 10 seconds.



---

This feature only works when set under normal boot.

---



---

The following items appear only when you set the Boot Logo Display to **[Disabled]**.

---

### Post Report [5 sec]

This item allows you to select a desired POST report waiting time.  
Configuration options: [1 sec] - [10 sec] [Until Press ESC]

### Bootup NumLock State [On]

This item allows you to on/off power-on state of the NumLock.  
Configuration options: [On] [Off]

### Wait For 'F1' If Error [Enabled]

This item allows your system to wait for the <F1> key to be pressed when error occurs.  
Configuration options: [Disabled] [Enabled]

### Option ROM Messages [Force BIOS]

This item allows you to set the display mode for Option ROM.

Configuration options: [Force BIOS] [Keep Current]

### INT19 Trap Response [Immediate]

[Immediate] Executes the trap for INT19 immediately.

[Postponed] Executes the trap during legacy boot.

### Above 4G Decoding [Disabled]

This item allows you to decode the 64-bit capable devices above 4G address space. Ensure that your system supports 64-bit PCI decoding.

Configuration options: [Disabled] [Enabled]

### Setup Mode [EZ Mode]

[Advanced Mode] This item allows you to go to Advanced Mode of the BIOS after POST.

[EZ Mode] This item allows you to go to EZ Mode of the BIOS after POST.

### CSM (Compatibility Support Module)

This item allows you to configure the CSM (Compatibility Support Module) items to fully support the various VGA, bootable devices and add-on devices for better compatibility.

#### Launch CSM [Enabled]

[Auto] The system automatically detects the bootable devices and the add-on devices.

[Enabled] For better compatibility, enable the CSM to fully support the non-UEFI driver add-on devices or the Windows® UEFI mode.

[Disabled] Disables the CSM to fully support the non-UEFI driver add-on devices or the Windows® UEFI mode.



---

The following items appear only when you set the Launch CSM to **[Enabled]**.

---

#### Boot Device Control [UEFI and Legacy OpROM]

This item allows you to select the type of devices that you want to boot.

Configuration options: [UEFI and Legacy OpROM] [Legacy OpROM only] [UEFI only]

#### Boot from Network Devices [Legacy OpROM first]

This item allows you to select the type of network devices that you want to launch.

Configuration options: [Legacy OpROM first] [UEFI driver first] [Ignore]

#### Boot from Storage Devices [Legacy OpROM first]

This item allows you to select the type of storage devices that you want to launch.

Configuration options: [Both, Legacy OpROM first] [Both, UEFI first] [Legacy OpROM first] [UEFI driver first] [Ignore]

### **Boot from PCI-E/PCI Expansion Devices [Legacy OpROM first]**

This item allows you to select the type of PCIe/PCI expansion devices that you want to launch.

Configuration options: [Legacy OpROM first] [UEFI driver first]

## **Secure Boot**

This item allows you to configure the Windows® Secure Boot settings and manage its keys to protect the system from unauthorized access and malwares during POST.

### **OS Type [Windows UEFI Mode]**

- |                     |  |
|---------------------|--|
| [Windows UEFI Mode] | This item allows you to select your installed operating system. Execute the Microsoft® Secure Boot check. Only select this option when booting on Windows® UEFI mode or other Microsoft® Secure Boot compliant OS. |
| [Other OS]          | Get the optimized function when booting on Windows® non-UEFI mode. Microsoft® Secure Boot only supports Windows® UEFI mode.  |

### **Key Management**

This item allows you to manage the Secure Boot keys.

#### **Install Default Secure Boot keys**

This item allows you to immediately load the default Security Boot keys, Platform key (PK), Key-exchange Key (KEK), Signature database (db), and Revoked Signatures (dbx). When the default Secure boot keys are loaded, the PK state will change from Unloaded mode to loaded mode.

#### **Clear Secure Boot keys**

This item appears only when you load the default Secure Boot keys. This item allows you to clear all default Secure Boot keys.

#### **Save Secure Boot Keys**

This item allows you to save the PK (Platform Keys) to a USB storage device.

### **PK Management**

The Platform Key (PK) locks and secures the firmware from any permissible changes. The system verifies the PK before your system enters the OS.

#### **Delete PK**

This item allows you to delete the PK from your system. Once the PK is deleted, all the system's Secure Boot keys will not be active.

Configuration options: [Yes] [No]

#### **Load PK from File**

This item allows you to load the downloaded PK from a USB storage device.



---

The PK file must be formatted as a UEFI variable structure with time-based authenticated variable.

---

## KEK Management

The KEK (Key-exchange Key or Key Enrollment Key) manages the Signature database (db) and Revoked Signature database (dbx).



---

Key-exchange Key (KEK) refers to Microsoft® Secure Boot Key-Enrollment Key (KEK).

---

### Delete the KEK

This item allows you to delete the KEK from your system.

Configuration options: [Yes] [No]

### Load KEK from File

This item allows you to load the downloaded KEK from a USB storage device.

### Append KEK from File

This item allows you to load the additional KEK from a storage device for an additional db and dbx loaded management.



---

The KEK file must be formatted as a UEFI variable structure with time-based authenticated variable.

---

## DB Management

The db (Authorized Signature database) lists the signers or images of UEFI applications, operating system loaders, and UEFI drivers that you can load on the single computer.

### Delete the db

This item allows you to delete the db file from your system.

Configuration options: [Yes] [No]

### Load db from File

This item allows you to load the downloaded db from a USB storage device.

### Append db from File

This item allows you to load the additional db from a storage device so that more images can be loaded securely.



---

The db file must be formatted as a UEFI variable structure with time-based authenticated variable.

---

## DBX Management

The dbx (Revoked Signature database) lists the forbidden images of db items that are no longer trusted and cannot be loaded.

### Delete the dbx

This item allows you to delete the dbx file from your system.

### Load dbx from File

This item allows you to load the downloaded dbx from a USB storage device.

Configuration options: [Yes] [No]

### Append dbx from File

This item allows you to load the additional dbx from a storage device so that more db's images cannot be loaded.



---

The dbx file must be formatted as a UEFI variable structure with time-based authenticated variable.

---

### Boot Option Priorities

These items specify the boot device priority sequence from the available devices. The number of device items that appears on the screen depends on the number of devices installed in the system.



- To access Windows® OS in Safe Mode, press <F8 > after POST (Windows® 8 not supported).
  - To select the boot device during system startup, press <F8> when ASUS Logo appears.
- 

### Boot Override

These item displays the available devices. The number of device items that appear on the screen depends on the number of devices installed in the system. Click an item to start booting from the selected device.

## 3.9 Tool menu

The Tool menu items allow you to configure options for special functions. Select an item then press <Enter> to display the submenu.

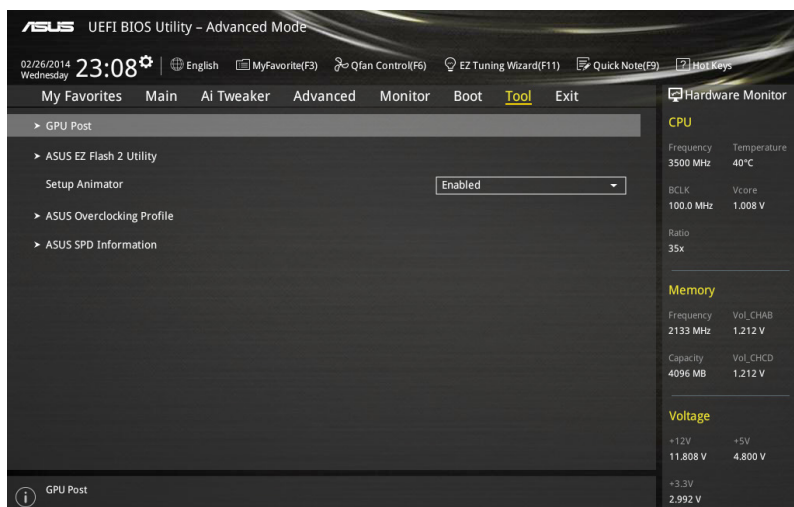

### GPU Post

This item shows the installed graphics cards in your motherboard. It also shows the recommended number of graphics card to install to your motherboard for best performance.

### Setup Animator

This item allows you to enable or disable the Setup animator.

Configuration options: [Disabled] [Enabled]

### 3.9.1 ASUS EZ Flash 2 Utility

This item allows you to run ASUS EZ Flash 2. When you press <Enter>, a confirmation message appears. Use the left/right arrow key to select between [Yes] or [No], then press <Enter> to confirm your choice.



For more details, refer to section [3.11.2 ASUS EZ Flash 2](#).



## 3.9.2 ASUS O.C. Profile

This item allows you to store or load multiple BIOS settings.

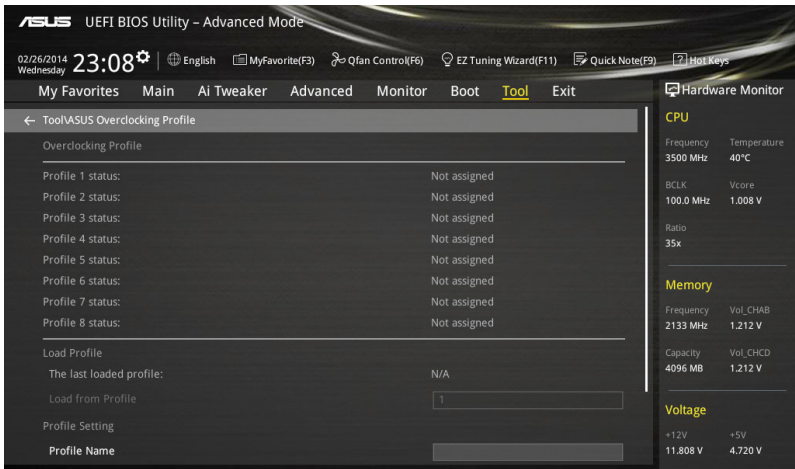

### Load from Profile

This item allows you to load the previous BIOS settings saved in the BIOS Flash. Key in the profile number that saved your BIOS settings, press <Enter>, and then select **Yes**.



- DO NOT shut down or reset the system while updating the BIOS to prevent the system boot failure!
- We recommend that you update the BIOS file only coming from the same memory/CPU configuration and BIOS version.

### Profile Name

This item allows you to key in a profile name.

### Save to Profile

This item allows you to save the current BIOS settings to the BIOS Flash, and create a profile. Key in a profile number from one to eight, press <Enter>, and then select **Yes**.

### Load/Save Profile from/to USB Drive

This item allows you to load or save profile from your USB drive, load and save profile to your USB drive.

### 3.9.3 ASUS DRAM SPD Information

This item allows you to view the DRAM SPD information.

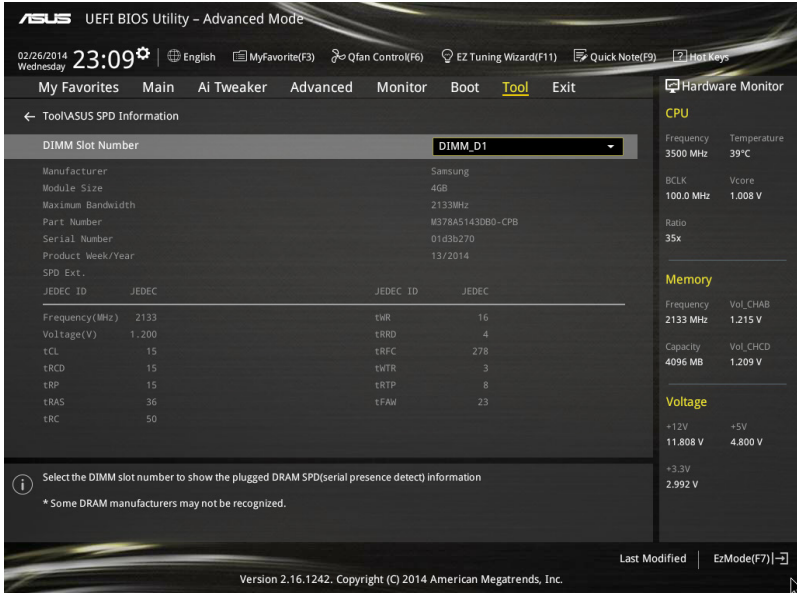

## 3.10 Exit menu

The Exit menu items allow you to load the optimal default values for the BIOS items, and save or discard your changes to the BIOS items. You can access the EZ Mode from the Exit menu.

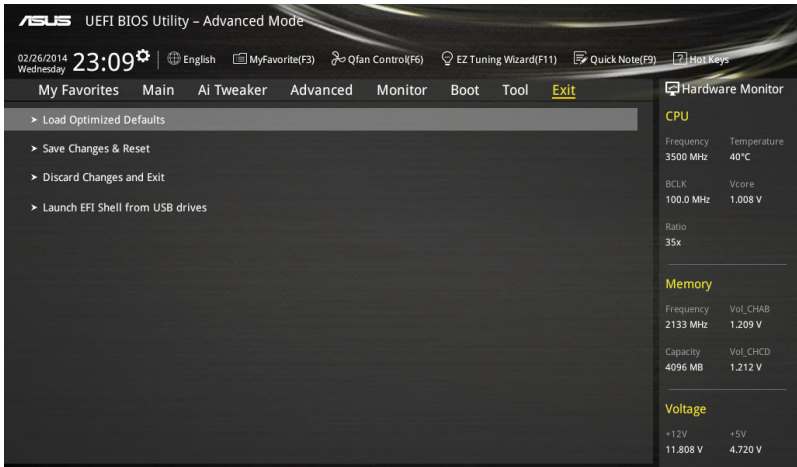

### Load Optimized Defaults

This option allows you to load the default values for each of the parameters on the Setup menus. When you select this option or if you press <F5>, a confirmation window appears. Select **OK** to load the default values.

### Save Changes & Reset

Once you are finished making your selections, choose this option from the Exit menu to ensure the values you selected are saved. When you select this option or if you press <F10>, a confirmation window appears. Select **OK** to save changes and exit.

### Discard Changes & Exit

This option allows you to exit the Setup program without saving your changes. When you select this option or if you press <Esc>, a confirmation window appears. Select **Yes** to discard changes and exit.

### Launch EFI Shell from USB drives

This option allows you to attempt to launch the EFI Shell application (shellx64.efi) from one of the available filesystem devices.

## 3.11 Updating BIOS

The ASUS website publishes the latest BIOS versions to provide enhancements on system stability, compatibility, and performance. However, BIOS updating is potentially risky. If there is no problem using the current version of BIOS, DO NOT manually update the BIOS. Inappropriate BIOS updating may result to system's failure to boot. Carefully follow the instructions in this chapter to update your BIOS when necessary.



---

Visit <http://www.asus.com> to download the latest BIOS file for this motherboard.

---

The following utilities allow you to manage and update the motherboard BIOS setup program.

1. EZ Update: Updates the BIOS in Windows® environment.
2. ASUS EZ Flash 2: Updates the BIOS using a USB flash drive.
3. ASUS CrashFree BIOS 3: Restores the BIOS using the motherboard support DVD or a USB flash drive when the BIOS file fails or gets corrupted.
4. ASUS BIOS Updater: Updates the BIOS in DOS environment using the motherboard support DVD and a USB flash disk drive.

### 3.11.1 EZ Update

The EZ Update is a utility that allows you to update the motherboard BIOS in Windows® environment.



- EZ Update requires an Internet connection either through a network or an ISP (Internet Service Provider).
  - This utility is available in the support DVD that comes with the motherboard package. Refer to the documentation that came with the support DVD.
- 

### 3.11.2 ASUS EZ Flash 2

ASUS EZ Flash 2 allows you to update the BIOS without having to use a bootable floppy disk or an OS-based utility.



---

Before you start using this utility, download the latest BIOS from the ASUS website at [www.asus.com](http://www.asus.com).

---

To update the BIOS using EZ Flash 2:

1. Insert the USB flash disk that contains the latest BIOS file to the USB port.
2. Enter the Advanced Mode of the BIOS setup program. Go to the Tool menu to select ASUS EZ Flash Utility and press <Enter> to enable it.

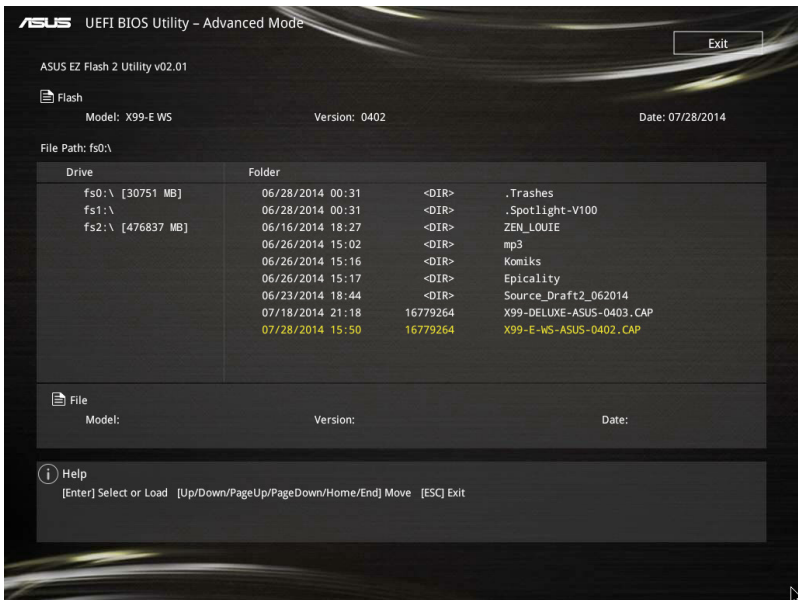

3. Press <Tab> to switch to the Drive field.
4. Press the Up/Down arrow keys to find the USB flash disk that contains the latest BIOS, and then press <Enter>.
5. Press <Tab> to switch to the Folder Info field.
6. Press the Up/Down arrow keys to find the BIOS file, and then press <Enter> to perform the BIOS update process. Reboot the system when the update process is done.



- This function can support devices such as a USB flash disk with FAT 32/16 format and single partition only.
- DO NOT shut down or reset the system while updating the BIOS to prevent system boot failure!



Ensure to load the BIOS default settings to ensure system compatibility and stability. Select the Load Optimized Defaults item under the Exit menu. See section 3.10 Exit Menu for details.

### 3.11.3 ASUS CrashFree BIOS 3

The ASUS CrashFree BIOS 3 utility is an auto recovery tool that allows you to restore the BIOS file when it fails or gets corrupted during the updating process. You can restore a corrupted BIOS file using the motherboard support DVD or a USB flash drive that contains the BIOS file.



---

The BIOS file in the motherboard support DVD may be older than the BIOS file published on the ASUS official website. If you want to use the newer BIOS file, download the file at <https://www.asus.com/support/> and save it to a USB flash drive.

---

#### Recovering the BIOS

To recover the BIOS:

1. Turn on the system.
2. Insert the motherboard support DVD to the optical drive, or the USB flash drive containing the BIOS file to the USB port.
3. The utility automatically checks the devices for the BIOS file. When found, the utility reads the BIOS file and enters ASUS EZ Flash 2 automatically.
4. The system requires you to enter BIOS Setup to recover the BIOS setting. To ensure system compatibility and stability, we recommend that you press <F5> to load default BIOS values.



---

DO NOT shut down or reset the system while updating the BIOS! Doing so can cause system boot failure!

---

### 3.11.4 ASUS BIOS Updater

ASUS BIOS Updater allows you to update the BIOS in DOS environment.



---

The screen captures used in this section are for reference only and may not be exactly the same as actually shown on your computer screen.

---

#### Before updating BIOS

- Prepare the motherboard support DVD and a USB flash drive.
- Download the latest BIOS file and BIOS Updater from <https://www.asus.com/support/> and save them in your USB flash drive.



---

NTFS is not supported under DOS environment. Ensure that your USB flash drive is in single partition and in FAT32/16 format.

---

- Turn off the computer.
- Ensure that your computer has a DVD optical drive.

## Booting the system in DOS environment

To boot the system in DOS:

1. Insert the USB flash drive with the latest BIOS file and BIOS Updater to the USB port.
2. Boot your computer then press <F8> to launch the select boot device screen.
3. When the select boot device screen appears, insert the Support DVD into the optical drive then select the optical drive as the boot device.

```
Please select boot device:
-----
E1:  ASUS DVD-E818A6T  (4069MB)
     USB DISK 2.0 (3824MB)
UEFI: (FAT)  USB DISK 2.0 (3824MB)
Enter Setup
-----
      ↑ and ↓ to move selection
      ENTER to select boot device
      ESC to boot using defaults
```

4. When the booting message appears, press <Enter> within five (5) seconds to enter FreeDOS prompt.

```
ISOLINUX 3.20 2006-08-26 Copyright (C) 1994-2005 H. Peter Anvin
A Bootable DVD/CD is detected. Press ENTER to boot from the DVD/CD.
If no key is pressed within 5 seconds, the system will boot next priority
device automatically. boot:
```

5. On the FreeDOS prompt, type **d**: then press <Enter> to switch the disk from Drive C (optical drive) to Drive D (USB flash drive).

```
Welcome to FreeDOS (http://www.freedos.org)!
C: /> d:
D: />
```

## Updating the BIOS file

To update the BIOS file:

1. On the FreeDOS prompt, type **bupdater /pc /g** and press <Enter>.

```
D: /> bupdater /pc /g
```

- On the BIOS Updater screen, press <Tab> to switch from Files panel to Drives panel then select **D:**.

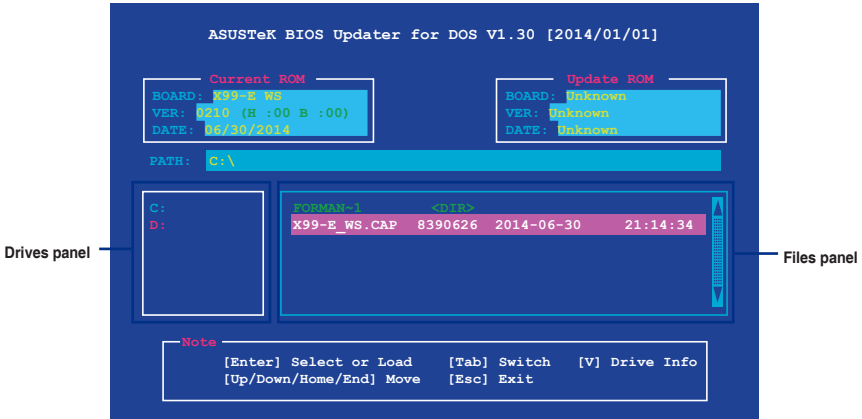

- Press <Tab> to switch from Drives panel to Files panel then press <Up/Down or Home/End> keys to select the BIOS file and press <Enter>.
- After the BIOS Updater checks the selected BIOS file, select **Yes** to confirm the BIOS update.



The BIOS Backup feature is not supported due to security regulations.

- Select **Yes** then press <Enter>. When BIOS update is done, press <ESC> to exit BIOS Updater.
- Restart your computer.



DO NOT shut down or reset the system while updating the BIOS to prevent system boot failure.



Ensure to load the BIOS default settings to ensure system compatibility and stability. Select **Load Optimized Defaults** item under the **Exit BIOS** menu. See section 3.10 **Exit menu** for details.



# Software Support

# 4

## 4.1 Installing an operating system



- This motherboard supports 32-bit/64-bit Windows® 7, 32-bit/64-bit Windows® 8, and 32-bit/64-bit Windows® 8.1 operating systems (OS).
- Motherboard settings and hardware options vary. The setup procedures presented in this chapter are for reference only. Refer to Windows® operating system documentation for detailed information.

## 4.2 Support DVD information



The contents of the support DVD are subject to change at any time without notice. Visit the ASUS website at [www.asus.com](http://www.asus.com) for updates.

### 4.2.1 Running the support DVD



Ensure that you have an Administrator account before running the support DVD in Windows® 7, Windows® 8, or Windows® 8.1 operating systems.

To run the support DVD:

1. Place the Support DVD into the optical drive.
2. In the **AutoPlay** dialog box, click or tap **Run ASSETUP.EXE**.

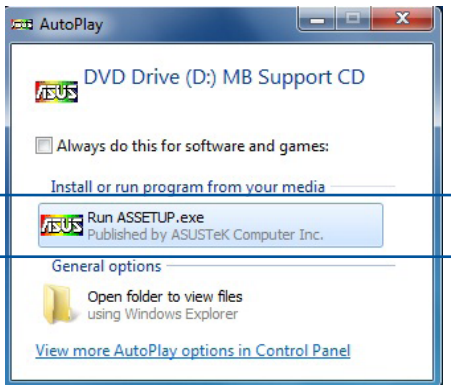

If the **AutoPlay** dialog box does not appear, browse the contents of the support DVD and double-click or tap `\\bin\ASSETUP.EXE` to launch the **ASUS motherboard support DVD** main menu.

# Support DVD main menu

The Drivers menu shows the available device drivers if the system detects installed devices. Install the necessary drivers to use the devices.

The AHCI/RAID Driver menu contains the RAID/AHCI driver disk.

The Manual menu contains the list of supplementary user guides. Click or tap an item to open the folder of the user guide.

The Utilities menu shows the applications and other software that the motherboard supports.

Click or tap an item to install

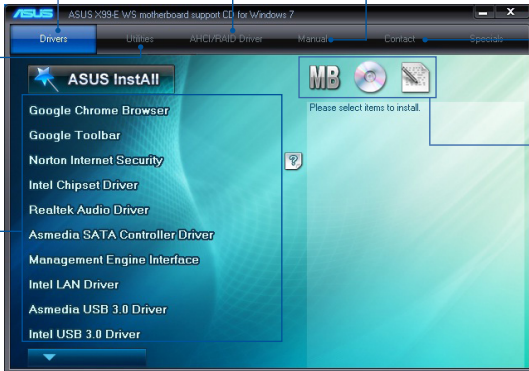

Click or tap to display the ASUS contact information.

Click or tap an icon to display DVD/motherboard information

## 4.2.2 Obtaining the software manuals

The software manuals are included in the support DVD. Follow the instructions below to get the necessary software manuals.



The software manual files are in Portable Document Format (PDF). Install the Adobe® Acrobat® Reader from the **Utilities** tab before opening the files.

To read about your motherboard's utility guide:

1. Click or tap **Manual** tab > **ASUS Motherboard Utility Guide**.



2. From the **Manual** folder, open the folder of the software manual that you wish to read.

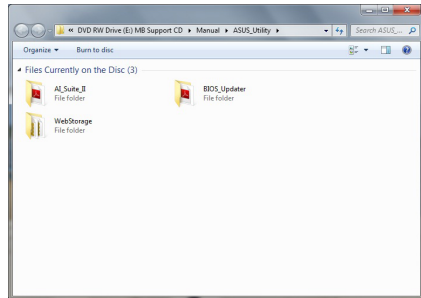

3. Some software manuals are provided in different languages. Open the language's folder to view the software manual.

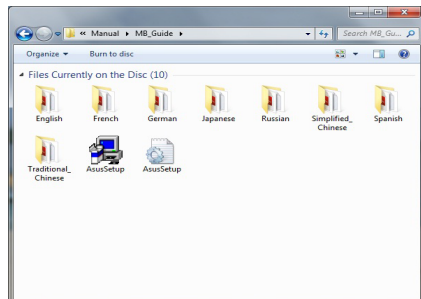

The screenshots in this section are for reference only. The actual software manuals containing in the support DVD vary by models.

## 4.3 Software information

Most of the applications in the support DVD have wizards that will conveniently guide you through the installation. View the online help or readme file that came with the software application for more information.

## 4.4 AI Suite 3

AI Suite 3 is an all-in-one interface that integrates several ASUS utilities and allows you to launch and operate these utilities simultaneously.

### Installing AI Suite 3



---

Ensure that you have an Administrator account before installing AI Suite 3 in Windows® 7, Windows® 8, or Windows® 8.1 operating systems.

---

To install AI Suite 3 on your computer:

#### Windows® 7 OS

1. Place the Support DVD into the optical drive.
2. In the **AutoPlay** dialog box, click or tap **Run ASSETUP.exe** then select the **Utilities** tab.

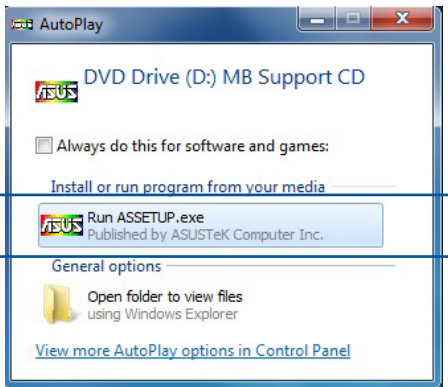

3. From the **Utilities** tab, click or tap **AI Suite 3** then follow the succeeding onscreen instructions.

## Windows® 8 and Windows® 8.1 OS

1. Place the Support DVD into the optical drive then follow onscreen instructions.
2. From the **ASUS motherboard support DVD** main menu, select the Utilities tab and click or tap **AI Suite 3**.
3. Follow the succeeding onscreen instructions.

If the **ASUS motherboard support DVD** main menu did not appear, try the following:

- a. Go to the **Start Screen** then click or tap the **Desktop** app.
- b. On the lower left corner of the Desktop, click or tap **File Explorer**  then select your DVD drive and tap or double-click or tap the **Setup** application.

## Launching AI Suite 3

### Windows® 7 OS

From the Desktop, click or tap **Start > All Programs > ASUS > AI Suite 3 > AI Suite 3**.

You can also launch AI Suite in Windows® 7 by clicking or tapping  on the Notification area.

### Windows® 8 and Windows® 8.1 OS

To launch AI Suite 3 in Windows® 8 or Windows® 8.1, tap the AI Suite 3 app on the Start Screen (or if you're using a mouse, click or tap the AI Suite 3 app on the Start Screen).

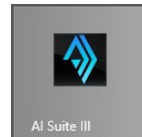

## AI Suite 3 Main menu

The AI Suite 3 main menu gives you easy-access controls and insight to what's going on with your computer - allowing you to optimize performance settings while at the same time ensuring system stability.

The AI Suite main menu includes a quick-access menu bar that allows you to swiftly launch any of the integrated ASUS utilities. Click or tap  on the top-right corner of the menu to launch the menu bar.

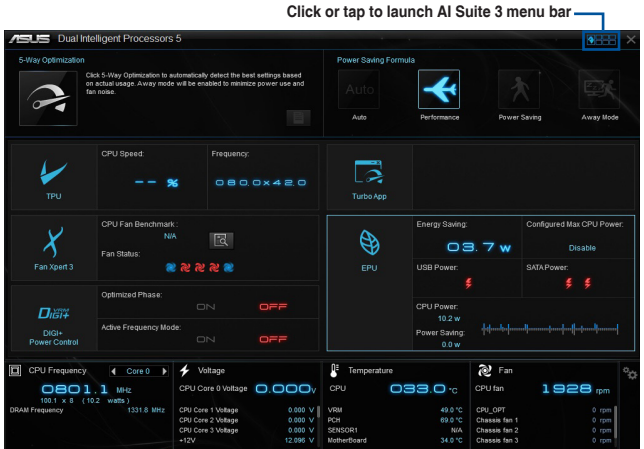

The AI Suite 3 screenshots in this section are for reference only and can vary depending on motherboard model.

## AI Suite 3 main menu bar

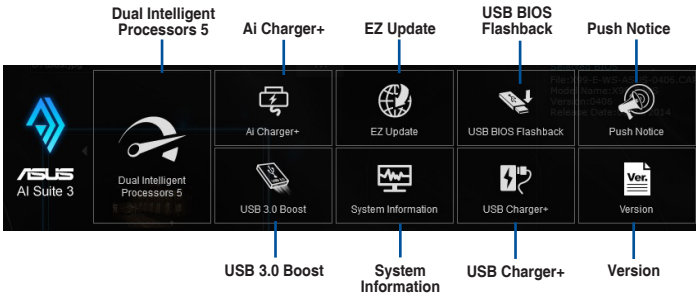

- Some functions in the AI Suite 3 main menu in this user guide may vary depending on the motherboard model.
- Refer to the software manual in the support DVD or visit the ASUS website at [www.asus.com](http://www.asus.com) for detailed software configuration.

## 4.4.1 Ai Charger+

Ai Charger+ allows you to fast-charge your portable BC 1.1\* mobile devices on your computer's USB port three times faster than the standard USB devices\*\*.

### Launching Ai Charger+

To launch Ai Charger+, click or tap  on the top-right corner of the AI Suite 3 main menu, then select **Ai Charger+**.



---

Ai Charger+ is available only in selected motherboard models.

---

### Ai Charger+ screen

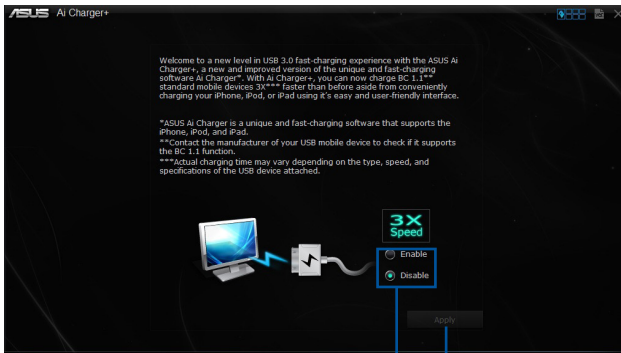

Tick to enable or  
disable Ai Charger+

Click or tap to apply  
the selection



- \* Check the manufacturer if your USB device is a Battery Charging Specification 1.1 (BC 1.1) compliant or compatible device.
- \*\* Actual charging speeds may vary depending on the charging rate and specifications of your USB device.
- To ensure normal charging function, disconnect and reconnect your USB device every time you enable or disable Ai Charger+.
- Ai Charger+ does not support USB hubs, USB extension cables, and generic USB cables.

## 4.4.2 USB 3.1 Boost

USB 3.1 Boost technology supports UASP (USB Attached SCSI Protocol) that automatically speeds up the transfer rates of your USB storage devices.

### Launching USB 3.1 Boost

To launch USB 3.1 Boost, click or tap  on the top-right corner of the AI Suite 3 main menu, then select **USB 3.1 Boost**.

### Using the USB 3.1 Boost



Click or tap to select a USB device

Click or tap to enable the USB device's normal data transfer rate

Click or tap to enable UASP or Turbo Mode for a faster data transfer rate



Ensure to connect your USB 3.1/3.0 devices to the USB 3.1/3.0 ports that support USB 3.1 Boost. Refer to section **2.3.1 Rear I/O connection** of your user guide for more details.



- USB 3.1 Boost automatically detects the USB 3.1/3.0 devices that support UASP.
- The data transfer speed varies with USB devices. For a higher data transfer performance, use a USB 3.1/3.0 device.



### 4.4.3 EZ Update

EZ Update is a utility that allows you to automatically update your motherboard's software, drivers and BIOS easily.

With this utility, you can also manually update the BIOS and select the boot logo that displays during POST.

#### Launching EZ Update

To launch EZ Update, click or tap  on the top-right corner of the AI Suite 3 main menu, then select **EZ Update**.

#### Using EZ Update

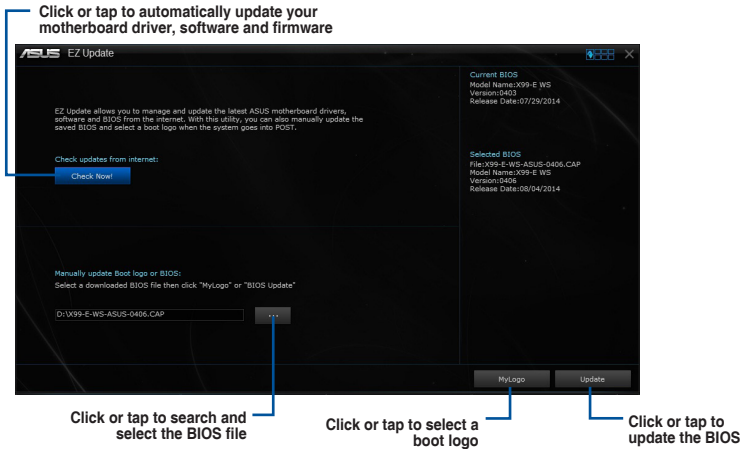

## Manually update the BIOS and selecting a boot logo

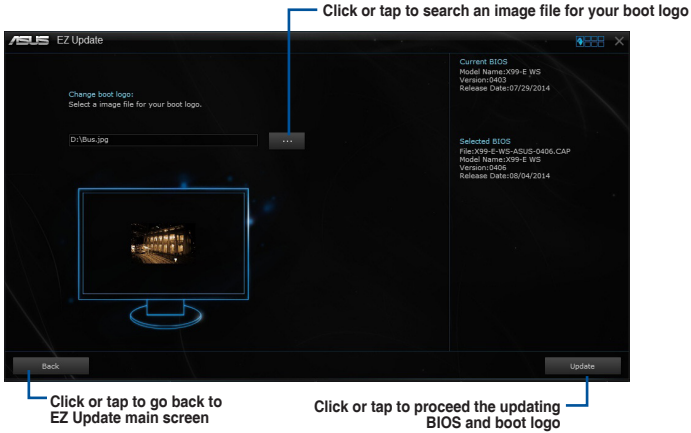

After you click or tap **BIOS Update** button, click or tap **Flash** to update the BIOS and upload the boot logo in your system.

## 4.4.4 USB BIOS Flashback

USB BIOS Flashback allows you to check and save the latest BIOS version to a USB storage device. Use this utility to quickly check for the latest available BIOS and set the BIOS download schedule.

### Launching USB BIOS Flashback

To launch USB BIOS Flashback, click or tap  on the top-right corner of the AI Suite 3 main menu, then select **USB BIOS Flashback**.



USB BIOS Flashback is available only in selected motherboard models.

### Using USB BIOS Flashback

Set a schedule for the BIOS Update download



Click or tap to check for a new BIOS update available for download

Click or tap to cancel the download schedule setting

Click or tap to apply the download schedule setting

### Scheduling the BIOS download

1. In the Download Setting field, tick **Schedule (days)** then select the number of days for the BIOS download schedule.
2. Click or tap **Apply** to save the BIOS download schedule. Click or tap **Cancel** to cancel the download schedule.

## Downloading the latest BIOS





Before you start downloading, ensure that you have installed the USB storage device to your computer's USB port that supports USB BIOS Flashback. Refer to section 2.4.1 **Rear I/O connection** of this user guide for more details.

To download the updated BIOS:

1. From the USB BIOS Flashback screen, click or tap **Check for New BIOS Update**.

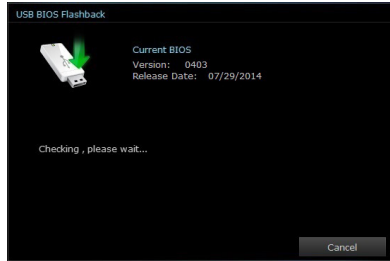
Wait for the system to check the latest BIOS version.



2. After the utility detects a new BIOS, click or tap  from the Save to: field, select the USB flash drive, then click or tap **Download**.

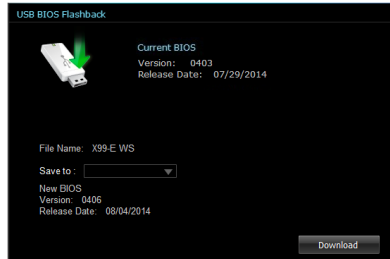

3. After the download is complete, click or tap **OK**.

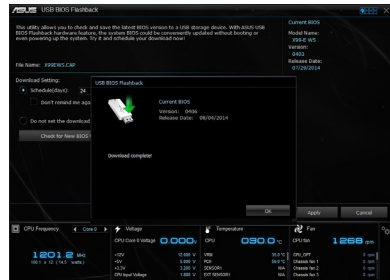

## 4.4.5 USB Charger+

USB Charger+ allows you to quick-charge your portable USB devices even if your computer is off, in sleep mode or hibernate mode.



Before using USB Charger+, ensure to disable the ErP Ready item from the **Advanced > APM > ErP Ready** in the Advanced mode of the BIOS Setup program.

### Launching USB Charger+

To launch USB Charger+, click or tap  on the top-right corner of the AI Suite 3 main menu, then select **USB Charger+**.

### USB Charger+ screen



The screenshot shows the ASUS USB Charger+ utility window. It features a dark background with the ASUS logo and a list of device brands: Kindle, Apple, and Others. There are three main buttons: a power icon for fast charging, a stop icon for stopping fast charging, and a refresh icon for rescan. At the bottom, there is a dropdown menu for 'Fast charging under system sleep, hibernate or shutdown mode' currently set to 'ASUS', and 'Apply' and 'Cancel' buttons.

Click or tap to detect the connected USB device

Indicates that the connected USB device is in charging mode

Click or tap to fast-charge your USB device

Click or tap to stop charging your USB device

Click or tap to apply the settings

Click or tap to discard the settings

Click or tap to select the type of USB device that you wish to charge when the system is off



Ensure to connect your USB device into the USB port that supports this utility. Refer to section **2.4.1 Rear I/O connection** of your user guide for more details.



- The USB Charger+ does not support USB hubs and USB extension cables, and generic USB cables.
- The USB Charger+ may not recognize some ASUS devices due to a special design.

## 4.4.6 Push Notice

This utility allows you get the detailed status of your system to your smart device. You can also send messages to your smart device using this utility.



Before using this utility, ensure that you pair your computer with your smart device. For pairing information, refer to section **Pairing your computer and smart device**.

### Launching Push Notice on your computer

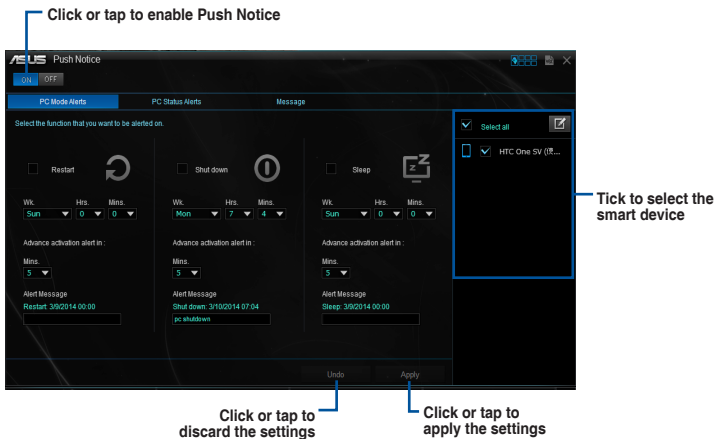

To launch Push Notice, click or tap  on the top-right corner of the AI Suite 3 main menu, then select **Push Notice**.

### Push Notice screen



The screenshot shows the Push Notice application window. At the top, there is a toggle switch for 'Push Notice' which is currently 'OFF'. Below this, there are three main sections: 'PC Mode Alerts', 'PC Status Alerts', and 'Message'. Each section has a 'Select the function that you want to be alerted on' area with icons for Restart, Shut down, and Sleep. Below these are fields for 'Advance activation alert in:' (with a dropdown menu), and 'Alert Message' (with a text input field). At the bottom right, there is a list of devices to select, with 'HTC One SV (IT...)' selected. At the bottom, there are 'Undo' and 'Apply' buttons. Annotations with arrows point to: 1. The 'ON/OFF' toggle switch with the text 'Click or tap to enable Push Notice'. 2. The device selection list with the text 'Tick to select the smart device'. 3. The 'Undo' button with the text 'Click or tap to discard the settings'. 4. The 'Apply' button with the text 'Click or tap to apply the settings'.



You can also enable the Push Notice via the Push Notice shortcut on the lower-right corner of your screen. To do this, click or tap << then click or tap  then select .

### Pairing your computer and smart device

To pair your computer and smart device:

1. On your smart device, tap  to launch Push Notice.
2. Tap **Push Scan** then tap the name of your computer that you want to pair with.



To pair your computer and smart device, ensure that both are connected to the same wireless network.

## Setting up PC Mode alerts of your computer

This feature allows you to restart, shut down, or put your computer to sleep mode and sends an alert to your smart device.

The screenshot shows the 'ASUS Push Notice' application window with the 'PC Mode Alerts' tab selected. The interface is divided into three columns for 'Restart', 'Shut down', and 'Sleep'. Each column has a 'Select the function that you want to be alerted on' section with a checked checkbox. Below this are 'Advance activation alert in:' settings, including 'Wk' (Weekday), 'Hrs' (Hours), and 'Mins' (Minutes) dropdowns. The 'Alert Message' field contains the respective mode name and time. A 'Message' panel on the right shows a checked checkbox for 'HTC One SV (R...)' and a 'Select all' button. Callout boxes with arrows point to these elements, providing instructions.

Tick these to enable mode alerts

Set the day and time to enable the PC modes

Set the minutes to send the alert before the PC mode/s activation

Key in your messages for more information

Tick to select the smart device

## Setting up PC Status alerts

This feature allows you to send alerts of the unusual activities of the voltage, temperature, and fan settings of your computer to your smart device.

The screenshot shows the 'ASUS Push Notice' application window with the 'PC Status Alerts' tab selected. The 'Select the system status you want to be alerted on.' section has three checked checkboxes for 'Voltage', 'Temperature', and 'Fan'. Below this is a checked checkbox for 'Send an alert notice when PC is back to normal'. The 'Message' panel on the right shows a checked checkbox for 'HTC One SV (R...)' and a 'Select all' button. Callout boxes with arrows point to these elements, providing instructions.

Tick to select and send alerts to your smart device



Tick to select the smart device

Tick to send alert when the components selected are back to its normal status

## Sending messages to your smart device

This feature allows you to send messages to your smart device.



You can also send messages via the Push Notice messaging shortcut on the lower-right corner of your screen. To do this, click or tap << then click or tap  then select .

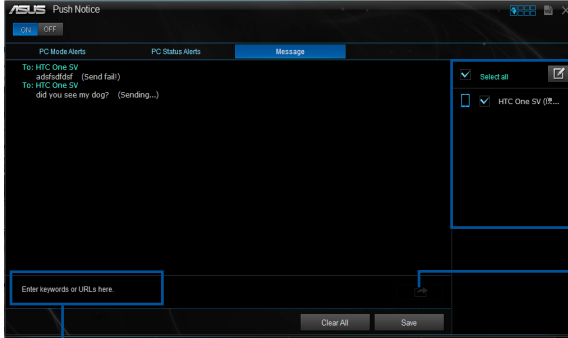

Tap to select the smart device

Click or tap to send your message

Click or tap to key in your message

## Viewing your computer status on your smart device

Tap  on your smart device to launch Push Notice.

Push Notice

- Tap to view PC mode alerts
- Tap to view PC status alerts
- Tap to view PC sent messages
- Tap to scan more host computers

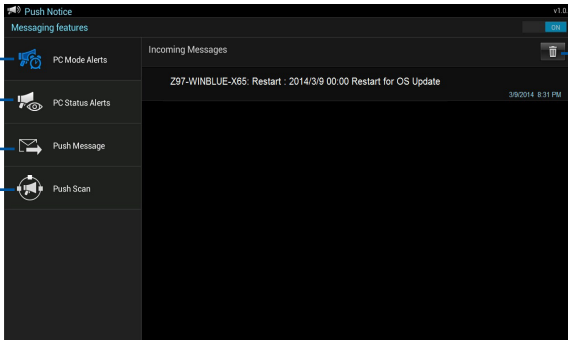

Tap to delete PC alerts



## 4.4.7 System Information

This utility allows you get the detailed information of the motherboard, CPU, and memory settings.

### Launching the System Information

To launch System Information, click or tap  on the top-right corner of the AI Suite 3 main menu, then select **System Information**.

### Viewing the motherboard information

Click or tap the **MB** tab to view the motherboard's information.

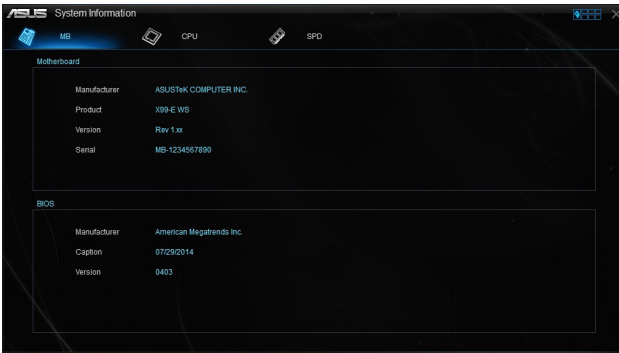

### Viewing the CPU information

Click or tap the **CPU** tab to view the processor's information.



## Viewing the SPD information

Click or tap the **SPD** tab to view the memory's information.



## 4.5 Audio configurations

The Realtek® audio CODEC provides 8-channel audio capability to deliver the ultimate audio experience on your computer. The software provides Jack-Sensing function, S/PDIF Out support, and interrupt capability. The CODEC also includes the Realtek® proprietary UAJ® (Universal Audio Jack) technology for all audio ports, eliminating cable connection errors, and giving users plug and play convenience.

Follow the installation wizard to install the Realtek® Audio Driver from the support DVD that came with the motherboard package.

If the Realtek® audio software is correctly installed, you will find the Realtek® HD Audio Manager icon on the taskbar. Double-click or tap on the icon to display the Realtek® HD Audio Manager.

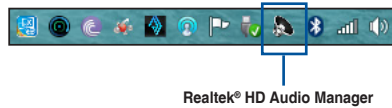

**A. Realtek® HD Audio Manager with DTS UltraPC II for Windows® 8.1 / Windows® 8 / Windows® 7**



## 4.6 ASUS Dr. Power Utility

ASUS Dr. Power is a monitoring utility that provides notifications when the power supply is unable to provide sufficient power to the system. You can choose to allow continuous notifications or stop messages from appearing until the next time you reboot your computer. The utility is used to monitor changes in the power supplied to the system that may affect performance and system stability.



---

ASUS Dr. Power Utility runs on your system only when the Dr. Power switch is enabled. (Please refer to **1.2.6 Onboard buttons and switches** for additional details). If the switch is disabled, the Dr. Power icon will not be available on the Windows® notification area.

---

### Installing Dr. Power Utility

To install Dr. Power on your computer:

1. Place the support DVD in the optical drive. The setup window will be displayed if Autorun is enabled on your system.
2. Select the **Drivers** tab and then click or tap **ASUS Dr. Power**.
3. Follow the instructions to complete installation.

### Using Dr. Power

After you complete installation, ASUS Dr. Power Utility will appear on the Windows® notification area. Place your mouse pointer over the Dr. Power icon to display current power status.

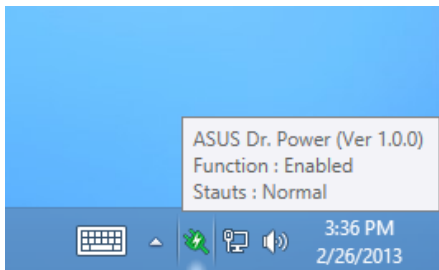

Right-click  on the notification area then click **Event Notification** to disable or enable messages from the utility.

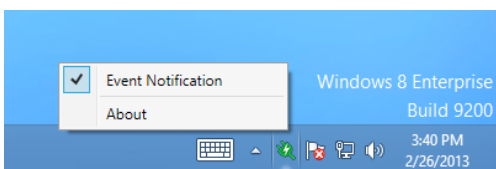

When ASUS Dr. Power detects that your system is running low on power, an event notification pops up to indicate that your power supply requires attention. The message will be displayed for 15 seconds or until you click the Close button. ASUS Dr. Power will notify you of the power status if the same conditions are present on your system.

ASUS Dr. Power can be configured to provide notifications at regular intervals:

- **15 minutes** - Messages will be displayed every 15 minutes.
- **4 hours** - Messages will be displayed every 4 hours.
- **Not showing** - Messages for any power issues will not be displayed.

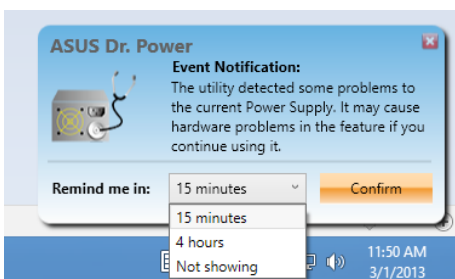



# RAID Support

# 5

## 5.1 RAID configurations

The motherboard supports Intel® Rapid Storage Technology with RAID 0, RAID 1, RAID 10, and RAID 5 solution.



---

If you want to install a Windows® operating system to a hard disk drive included in a RAID set, you have to create a RAID driver disk and load the RAID driver during OS installation. Refer to section **5.2 Creating a RAID driver disk** for details.

---

### 5.1.1 RAID definitions

**RAID 0 (Data striping)** optimizes two identical hard disk drives to read and write data in parallel, interleaved stacks. Two hard disks perform the same work as a single drive but at a sustained data transfer rate, double that of a single disk alone, thus improving data access and storage. Use of two new identical hard disk drives is required for this setup.

**RAID 1 (Data mirroring)** copies and maintains an identical image of data from one drive to a second drive. If one drive fails, the disk array management software directs all applications to the surviving drive as it contains a complete copy of the data in the other drive. This RAID configuration provides data protection and increases fault tolerance to the entire system. Use two new drives or use an existing drive and a new drive for this setup. The new drive must be of the same size or larger than the existing drive.

**RAID 5** stripes both data and parity information across three or more hard disk drives. Among the advantages of RAID 5 configuration include better HDD performance, fault tolerance, and higher storage capacity. The RAID 5 configuration is best suited for transaction processing, relational database applications, enterprise resource planning, and other business systems. Use a minimum of three identical hard disk drives for this setup.

**RAID 10** is data striping and data mirroring combined without parity (redundancy data) having to be calculated and written. With the RAID 10 configuration you get all the benefits of both RAID 0 and RAID 1 configurations. Use four new hard disk drives or use an existing drive and three new drives for this setup.

## 5.1.2 Installing Serial ATA hard disks

The motherboard supports Serial ATA hard disk drives. For optimal performance, install identical drives of the same model and capacity when creating a disk array.

To install the SATA hard disks for a RAID configuration:

1. Install the SATA hard disks into the drive bays.
2. Connect the SATA signal cables.
3. Connect a SATA power cable to the power connector on each drive.

## 5.1.3 Setting the RAID item in BIOS

You must enable the RAID function in the BIOS Setup before creating RAID sets using SATA HDDs.

To set the RAID item in BIOS:

1. Enter the BIOS Setup during POST.
2. Go to the **Advanced** menu > **PCH Storage Configuration > SATA Controller 1 Mode Selection**, then press <Enter>.
3. Set the SATA Mode item to **[RAID Mode]**.
4. Save your changes, and then exit the BIOS Setup.



---

Refer to Chapter 3 for details on entering and navigating through the BIOS Setup

---



---

Due to chipset limitation, when SATA ports are set to RAID mode, all SATA ports run at RAID mode together.

---



## 5.1.4 Intel® Rapid Storage Technology Option ROM utility

To enter the Intel® Rapid Storage Technology Option ROM utility:

1. Turn on the system.
2. During POST, press <Ctrl> + <I> to display the utility main menu.

```
Intel(R) Rapid Storage Technology - Option - v10.5.1.1070
Copyright(C) 2003-14 Intel Corporation. All Rights Reserved.

[ MAIN MENU ]

1. Create RAID Volume          4. Recovery Volume Options
2. Delete RAID Volume         5. Acceleration Options
3. Reset Disks to Non-RAID    6. Exit

[ DISK/VOLUME INFORMATION ]

RAID Volumes:
None defined.

Physical Devices:
Port  Device Model  Serial #      Size   Type/Status (Vol ID)
0      ST3160812AS      9LS0HJA4     149.0GB Non-RAID Disk
1      ST3160812AS      9LS0F4HL     149.0GB Non-RAID Disk
2      ST3160812AS      3LS0JYL8     149.0GB Non-RAID Disk
3      ST3160812AS      9LS0BJ5H     149.0GB Non-RAID Disk

[↑↓]-Select      [ESC]-Exit      [ENTER]-Select Menu
```

The navigation keys at the bottom of the screen allow you to move through the menus and select the menu options.



The RAID BIOS setup screens shown in this section are for reference only and may not exactly match the items on your screen.



The utility supports maximum four hard disk drives for RAID configuration.

## Creating a RAID set

To create a RAID set:

1. From the utility main menu, select **1. Create RAID Volume** and press <Enter>. The following screen appears:

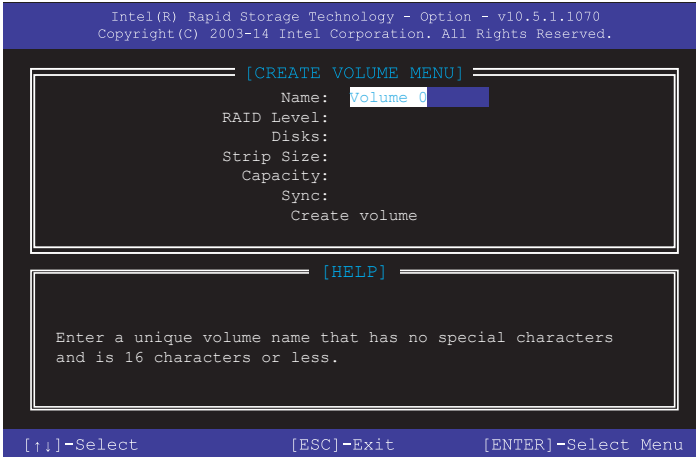

2. Enter a name for the RAID set and press <Enter>.
3. When the RAID Level item is selected, press the up/down arrow key to select a RAID level to create, and then press <Enter>.
4. When the Disks item is selected, press <Enter> to select the hard disk drives you want to include in the RAID set. The SELECT DISKS screen appears:

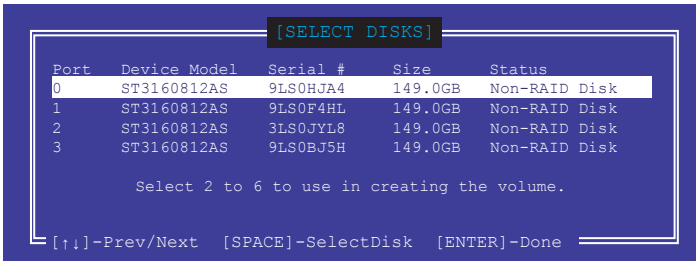

5. Use the up/down arrow key to select a drive, and then press <Space> to select. A small triangle marks the selected drive. Press <Enter> after completing your selection.
6. Use the up/down arrow key to select the stripe size for the RAID array (for RAID 0, 10 and 5 only), then press <Enter>. The available stripe size values range from 4 KB to 128 KB. The following are typical values:
  - RAID 0: 128 KB
  - RAID 10: 64 KB
  - RAID 5: 64 KB



---

We recommend a lower stripe size for server systems, and a higher stripe size for multimedia computer systems used mainly for audio and video editing.

---

7. When the **Capacity** item is selected, enter the RAID volume capacity that you want and press <Enter>. The default value indicates the maximum allowed capacity.
8. When the **Create Volume** item is selected, press <Enter>. The following warning message appears:

```
WARNING: ALL DATA ON SELECTED DISKS WILL BE LOST.  
Are you sure you want to create this volume? (Y/N)
```

9. Press <Y> to create the RAID volume and return to the main menu, or <N> to go back to the **CREATE VOLUME** menu.

## Deleting a RAID set



Be cautious when deleting a RAID set. You will lose all data on the hard disk drives when you delete a RAID set.

To delete a RAID set:

1. From the utility main menu, select **2. Delete RAID Volume** and press <Enter>. The following screen appears:

```
[DELETE VOLUME MENU]
Name      Level      Drives  Capacity  Status  Bootable
Volume0   RAID0 (Stripe)  2       298.0GB  Normal  Yes

[HELP]

Deleting a volume will reset the disks to non-RAID.

WARNING: ALL DISK DATA WILL BE DELETED.
(This does not apply to Recovery volumes)

[↑]-Select [ESC]-Previous Menu [DEL]-Delete Volume
```

2. Use the up/down arrow key to select the RAID set you want to delete, and then press <Delete>. The following warning message appears:

```
[DELETE VOLUME VERIFICATION]

ALL DATA IN THE VOLUME WILL BE LOST!
(This does not apply to Recovery volumes)

Are you sure you want to delete "Volume0"? (Y/N):
```

3. Press <Y> to delete the RAID set and return to the utility main menu, or press <N> to return to the DELETE VOLUME menu.

## Exiting the Intel® Rapid Storage Technology Option ROM utility

To exit the utility:

1. From the utility main menu, select **5. Exit**, then press <Enter>. The following warning message appears:

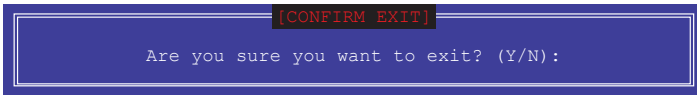

2. Press <Y> to exit or press <N> to return to the utility main menu.

## 5.2 Creating a RAID driver disk

A floppy disk with the RAID driver is required when installing a Windows® operating system on a hard disk drive that is included in a RAID set.



---

The motherboard does not provide a floppy drive connector. You have to use a USB floppy disk drive when creating a SATA RAID driver disk.

---

### 5.2.1 Creating a RAID driver disk without entering the OS

To create a RAID driver disk without entering the OS:

1. Boot your computer.
2. Press <Delete> during POST to enter the BIOS setup utility.
3. Set the optical drive as the primary boot device.
4. Insert the support DVD into the optical drive.
5. Save changes and exit BIOS.
6. When the Make Disk menu appears, press <1> to create a RAID driver disk.
7. Insert a formatted floppy disk into the USB floppy disk drive, then press <Enter>.
8. Follow the succeeding screen instructions to complete the process.

## 5.2.2 Creating a RAID driver disk in Windows®

To create a RAID driver disk in Windows®:

1. Start Windows®.
2. Plug the USB floppy disk drive and insert a floppy disk.
3. Place the motherboard support DVD into the optical drive.
4. Go to the **Intel AHCI/RAID Driver** menu then click **Intel AHCI/RAID Driver path** to open the RAID driver folder.
5. Select **32bit** or **64bit** folder depending on your operating system. Copy the files of the selected folder to the root path of your USB floppy disk drive.



---

Write-protect the floppy disk to avoid a computer virus infection.

---

## 5.2.3 Installing the RAID driver during Windows® OS installation

To install the RAID driver for Windows® 7:

1. During the OS installation, click **Load Driver** to allow you to select the installation media containing the RAID driver.
2. Insert the USB flash drive with RAID driver into the USB port or the support DVD into the optical drive, and then click **Browse**.
3. Click the name of the device you've inserted, go to **Drivers > RAID**, and then select the RAID driver for the corresponding OS version. Click **OK**.
4. Follow the succeeding screen instructions to complete the installation.



---

Before loading the RAID driver from a USB flash drive, you have to use another computer to copy the RAID driver from the support DVD to the USB flash drive.

---



---

To set up a Windows® UEFI operating system under RAID mode, ensure to load the UEFI driver for your optical drive.

---

# Multiple GPU Support

## 6.1 AMD® CrossFireX™ technology

The motherboard supports the AMD® CrossFireX™ technology that allows you to install multi-graphics processing units (GPU) graphics cards. Follow the installation procedures in this section.

### 6.1.1 Requirements

- In Dual CrossFireX mode, you should have two identical CrossFireX-ready graphics cards or one CrossFireX-ready dual-GPU graphics card that are AMD® certified.
- Ensure that your graphics card driver supports the AMD CrossFireX technology. Download the latest driver from the AMD website at [www.amd.com](http://www.amd.com).
- Ensure that your power supply unit (PSU) can provide at least the minimum power required by your system. See Chapter 1 for details.



- 
- We recommend that you install additional chassis fans for better thermal environment.
  - Visit the AMD Game website at <http://game.amd.com> for the latest certified graphics card and the supported 3D application list.
- 

### 6.1.2 Before you begin

For AMD CrossFireX to work properly, you have to uninstall all existing graphics card drivers before installing AMD CrossFireX graphics cards to your system.

To uninstall existing graphics card drivers:

1. Close all current applications.
2. Go to **Control Panel > Programs and Features**.
3. Select your current graphics card driver/s.
4. Select **Uninstall**.
5. Turn off your computer.

## 6.1.3 Installing two CrossFire™ graphics cards



The following pictures are for reference only. The graphics cards and the motherboard layout may vary with models, but the installation steps remain the same.

To install two CrossFire™ graphics cards:

1. Prepare two CrossFireX-ready graphics cards.
2. Insert the two graphics card into the PCIEX16 slots. If your motherboard has more than two PCIEX16 slots, refer to Chapter 1 in this user manual for the locations of the PCIEX16 slots recommended for multi-graphics card installation.
3. Ensure that the cards are properly seated on the slots.
4. Align and firmly insert the CrossFireX bridge connector to the goldfingers on each graphics card. Ensure that the connector is firmly in place.

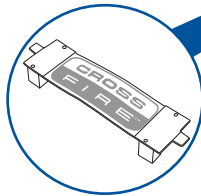
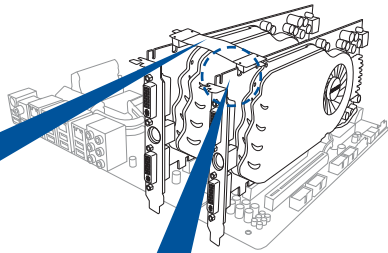
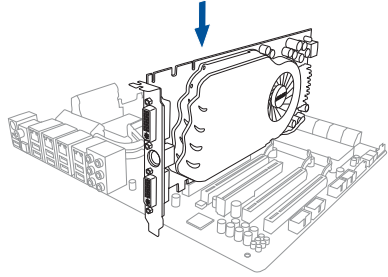

CrossFireX bridge  
(bundled with  
graphics cards)

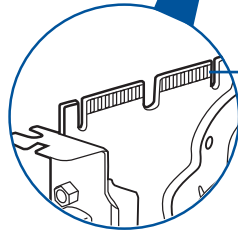

Goldfingers



5. Connect two independent auxiliary power sources from the power supply to the two graphics cards separately.
6. Connect a VGA or a DVI cable to the graphics card.

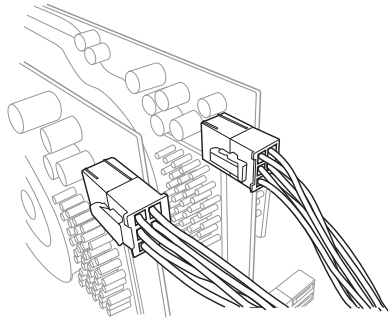

## 6.1.4 Installing three CrossFireX™ graphics cards

To install three CrossFireX™ graphics cards:

1. Prepare three CrossFireX-ready graphics cards.
2. Insert the three graphics card into the PCIEX16 slots. If your motherboard has more than three PCIEX16 slots, refer to Chapter 1 in this user manual for the locations of the PCIEX16 slots recommended for multi-graphics card installation.
3. Ensure that the cards are properly seated on the slots.
4. Align and firmly insert the two CrossFireX™ bridge connectors to the goldfingers on each graphics card. Ensure that the connectors are firmly in place.

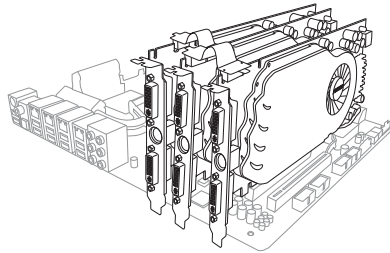

5. Connect three independent auxiliary power sources from the power supply to the three graphics cards separately.
6. Connect a VGA or a DVI cable to the graphics card.

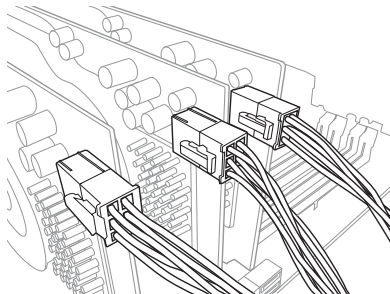

## 6.1.5 Installing four CrossFire™ graphics cards

To install four CrossFire™ graphics cards:

1. Prepare four CrossFireX-ready graphics cards.
2. Insert the four graphics cards into the PCIEX16 slots. Refer to Chapter 1 in this user manual for the locations of the PCIEX16 slots recommended for multi-graphics card installation.
3. Ensure that the cards are properly seated on the slots.
4. Align and firmly insert the three CrossFireX bridge connectors to the goldfingers on each graphics card. Ensure that the connectors are firmly in place.

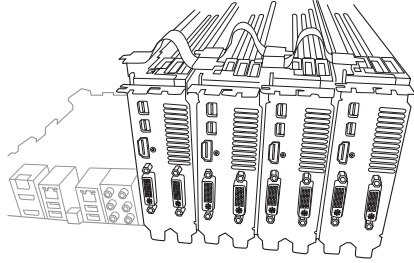

5. Connect four independent auxiliary power sources from the power supply to the four graphics cards separately.
6. Connect a VGA or a DVI cable to the graphics card.

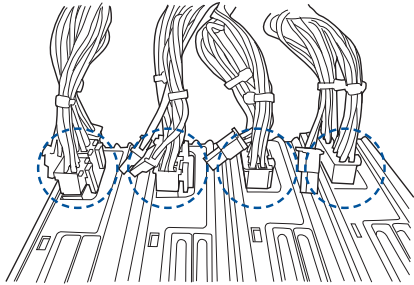

## 6.1.6 Installing the device drivers

Refer to the documentation that came with your graphics card package to install the device drivers.



Ensure that your PCI Express graphics card driver supports the AMD® CrossFireX™ technology. Download the latest driver from the AMD website at [www.amd.com](http://www.amd.com).

## 6.1.7 Enabling the AMD® CrossFireX™ technology

After installing your graphics cards and the device drivers, enable the CrossFireX™ feature through the AMD Vision Engine Control Center in Windows environment.

### Launching the AMD VISION Engine Control Center

To launch the AMD VISION Engine Control Center:

1. Right-click on the Windows® desktop and select **AMD VISION Engine Control Center**.

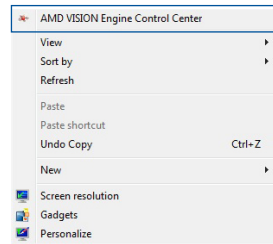

## Enabling Dual CrossFire™ technology

To enable Dual CrossFire™ technology:

1. In the AMD Vision Engine Control Center window, click **Performance > AMD CrossFire™**.
2. Select **Enable CrossFire™**.
3. Select a GPU combination from the drop-down list.
4. Click **Apply** to save and activate the GPU settings made.

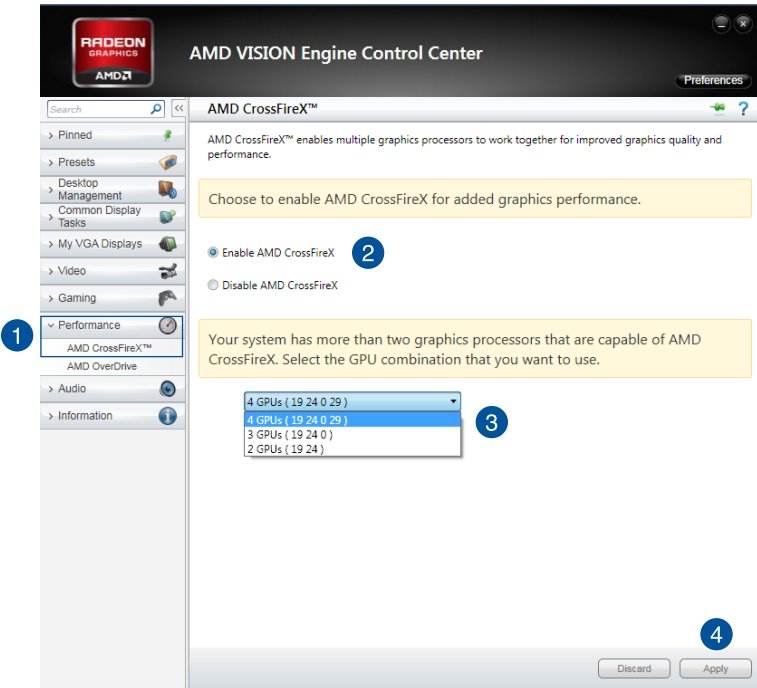

## 6.2 NVIDIA® SLI™ technology

The motherboard supports the NVIDIA® SLI™ (Scalable Link Interface) technology that allows you to install multi-graphics processing units (GPU) graphics cards. Follow the installation procedures in this section.

### 6.2.1 Requirements

- In SLI mode, you should have two identical SLI-ready graphics cards that are NVIDIA® certified.
- Ensure that your graphics card driver supports the NVIDIA SLI technology. Download the latest driver from the NVIDIA website at [www.nvidia.com](http://www.nvidia.com).
- Ensure that your power supply unit (PSU) can provide at least the minimum power required by your system.



- We recommend that you install additional chassis fans for better thermal environment.
- Visit the NVIDIA zone website at <http://www.nzone.com> for the latest certified graphics card and supported 3D application list.

### 6.2.2 Installing two SLI-ready graphics cards



The following pictures are for reference only. The graphics cards and the motherboard layout may vary with models, but the installation steps remain the same.

To install two SLI-ready graphics cards:

1. Prepare two SLI-ready graphics cards.
2. Insert the two graphics card into the PCIEX16 slots. If your motherboard has more than two PCIEX16 slots, refer to Chapter 1 in this user manual for the locations of the PCIEX16 slots recommended for multi-graphics card installation.
3. Ensure that the cards are properly seated on the slots.

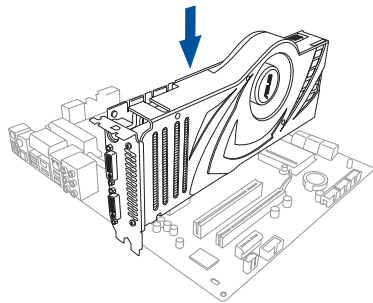

4. Align and firmly insert the SLI bridge connector to the goldfingers on each graphics card. Ensure that the connector is firmly in place.
5. Connect two independent auxiliary power sources from the power supply to the two graphics cards separately.
6. Connect a VGA or a DVI cable to the graphics card.

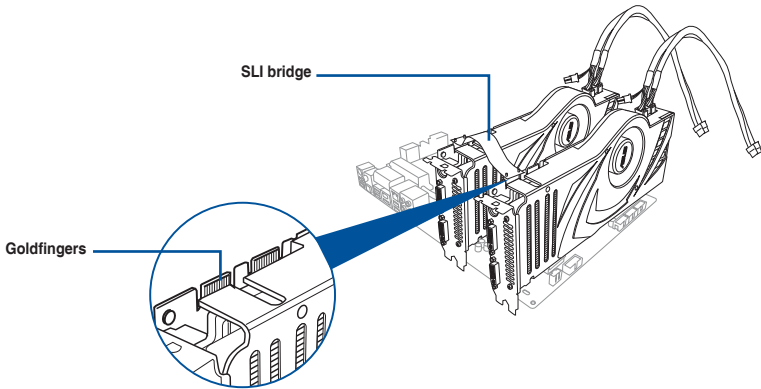

### 6.2.3 Installing three SLI-ready graphics cards

Refer to the documentation that came with your graphics card package to install the device drivers.

To install three SLI-ready graphics cards:

1. Prepare three SLI-ready graphics cards.
2. Insert the three graphics cards into the PCIEX16 slots. If your motherboard has more than two PCIEX16 slots, refer to Chapter 1 in this user manual for locations of the PCIEX16 slots recommended for multi-graphics card installation.
3. Ensure that the cards are properly seated on the slots.

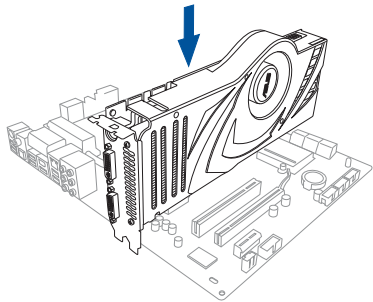

4. Align and firmly insert the 3-way SLI bridge connector to the goldfingers on each graphics card. Ensure that the connector is firmly in place.
5. Connect three independent auxiliary power sources from the power supply to the three graphics cards separately.
6. Connect a VGA or a DVI cable to the graphics card.

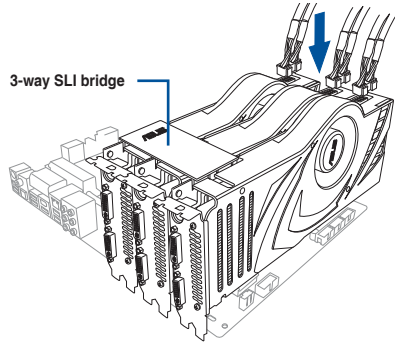

## 6.2.4 Installing four SLI-ready graphics cards

To install four SLI-ready graphics cards:

1. Prepare four SLI-ready graphics cards.
2. Insert the four graphics cards into the PCIEX16 slots. If your motherboard has more than two PCIEX16 slots, refer to Chapter 1 in this user manual for the locations of the PCIEX16 slots recommended for multi-graphics card installation.
3. Ensure that the cards are properly seated on the slots.
4. Align and firmly insert the 4-way SLI bridge connector to the goldfingers on each graphics card. Ensure that the connector is firmly in place.
5. Connect four independent auxiliary power sources from the power supply to the four graphics cards separately.
6. Connect a VGA or a DVI cable to the graphics card.

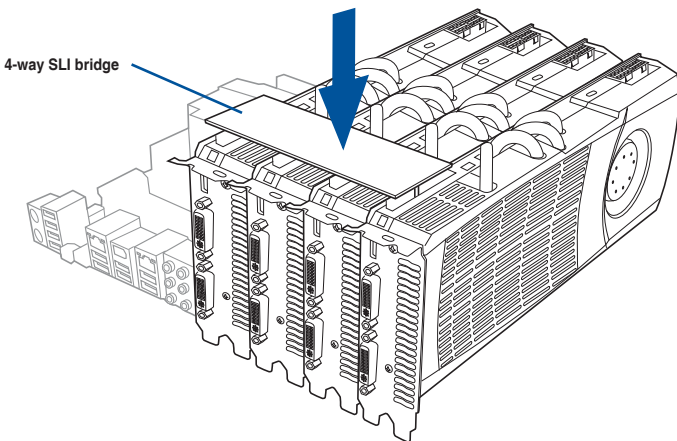

## 6.2.5 Installing the device drivers

Refer to the documentation that came with your graphics card package to install the device drivers.



---

Ensure that your PCI Express graphics card driver supports the NVIDIA® SLI™ technology. Download the latest driver from the NVIDIA website at [www.nvidia.com](http://www.nvidia.com).

---

## 6.2.6 Enabling the NVIDIA® SLI™ technology

After installing your graphics cards and the device drivers, enable the SLI feature in NVIDIA® Control Panel under the Windows® 7 operating system.

### Launching the NVIDIA Control Panel

You can launch the NVIDIA Control Panel by the following two methods:

- A. Right click on the empty space of the Windows® desktop and select **NVIDIA Control Panel**.

The NVIDIA Control Panel window appears (See Step B3).

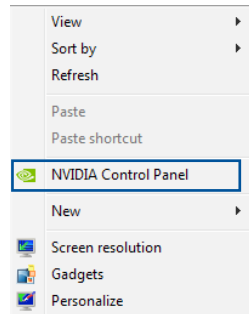

- B1. If you cannot see the NVIDIA Control Panel item in step (A), select **Screen Resolution**.

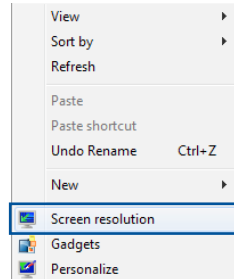



- B2. From the Screen Resolution window, click **Advanced settings**.

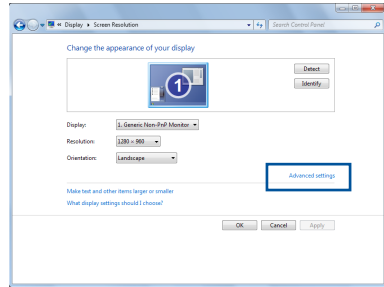

- B3. The NVIDIA Control Panel window appears.

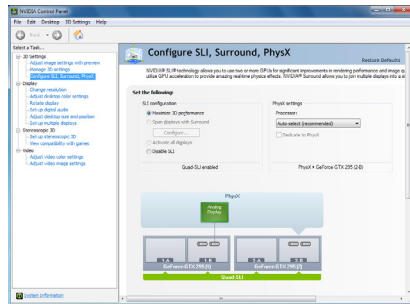

## Enabling SLI settings

From the NVIDIA Control Panel window, select **Configure SLI, Surround, PhysX**. In the **Quad-SLI enabled**, click **Maximize 3D Performance SLI** to set the display for viewing SLI rendered content. When done, click **Apply**.

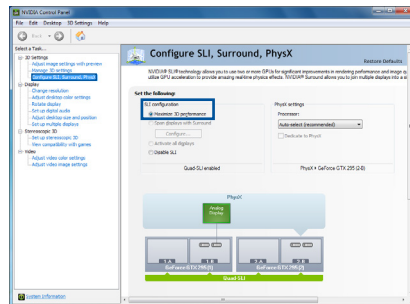





# X99-E WS/USB 3.1 block diagram (28-Lane)

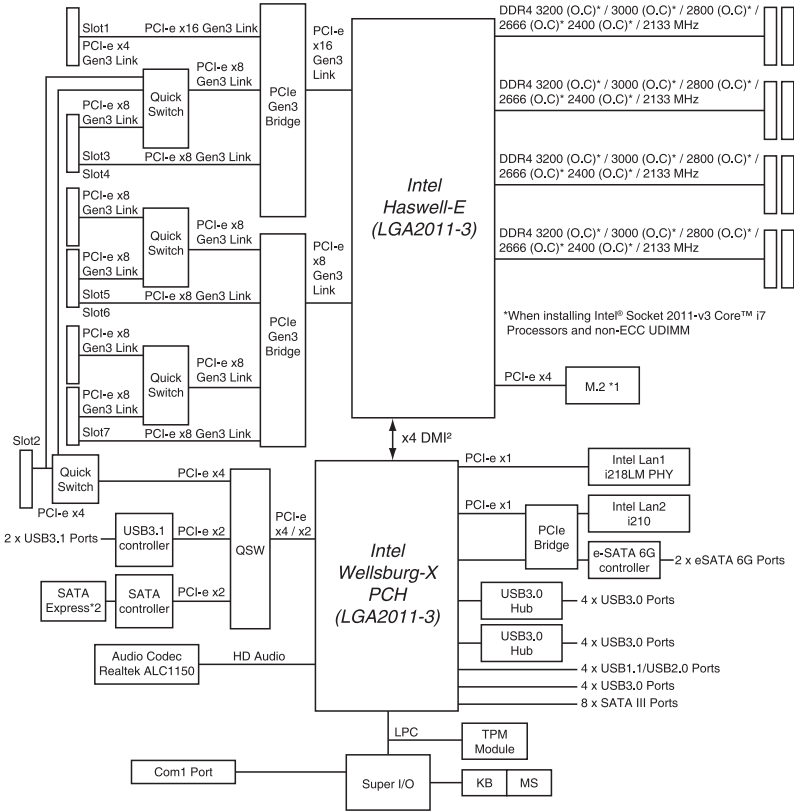

## Notices

### Federal Communications Commission Statement

This device complies with Part 15 of the FCC Rules. Operation is subject to the following two conditions:

- This device may not cause harmful interference.
- This device must accept any interference received including interference that may cause undesired operation.

This equipment has been tested and found to comply with the limits for a Class B digital device, pursuant to Part 15 of the FCC Rules. These limits are designed to provide reasonable protection against harmful interference in a residential installation. This equipment generates, uses and can radiate radio frequency energy and, if not installed and used in accordance with manufacturer's instructions, may cause harmful interference to radio communications. However, there is no guarantee that interference will not occur in a particular installation. If this equipment does cause harmful interference to radio or television reception, which can be determined by turning the equipment off and on, the user is encouraged to try to correct the interference by one or more of the following measures:

- Reorient or relocate the receiving antenna.
- Increase the separation between the equipment and receiver.
- Connect the equipment to an outlet on a circuit different from that to which the receiver is connected.
- Consult the dealer or an experienced radio/TV technician for help.



---

The use of shielded cables for connection of the monitor to the graphics card is required to assure compliance with FCC regulations. Changes or modifications to this unit not expressly approved by the party responsible for compliance could void the user's authority to operate this equipment.

---

## Compliance Statement of Innovation, Science and Economic Development Canada (ISED)

This device complies with Innovation, Science and Economic Development Canada licence exempt RSS standard(s). Operation is subject to the following two conditions: (1) this device may not cause interference, and (2) this device must accept any interference, including interference that may cause undesired operation of the device.

CAN ICES-3(B)/NMB-3(B)

## Déclaration de conformité de Innovation, Sciences et Développement économique Canada (ISED)

Le présent appareil est conforme aux CNR d'Innovation, Sciences et Développement économique Canada applicables aux appareils radio exempts de licence. L'exploitation est autorisée aux deux conditions suivantes : (1) l'appareil ne doit pas produire de brouillage, et (2) l'utilisateur de l'appareil doit accepter tout brouillage radioélectrique subi, même si le brouillage est susceptible d'en compromettre le fonctionnement.

CAN ICES-3(B)/NMB-3(B)

## VCCI: Japan Compliance Statement Class B ITE

この装置は、クラスB情報技術装置です。この装置は、家庭環境で使用することを目的としていますが、この装置がラジオやテレビジョン受信機に近接して使用されると、受信障害を引き起こすことがあります。

取扱説明書に従って正しい取り扱いをして下さい。

VCCI-B

## KC: Korea Warning Statement

B급 기기 (가정용 방송통신기자재)

이 기기는 가정용(B급) 전자파적합기기로서 주로 가정에서 사용하는 것을 목적으로 하며, 모든 지역에서 사용할 수 있습니다.

## REACH

Complying with the REACH (Registration, Evaluation, Authorisation, and Restriction of Chemicals) regulatory framework, we published the chemical substances in our products at ASUS REACH website at <http://csr.asus.com/english/REACH.htm>.



DO NOT throw the motherboard in municipal waste. This product has been designed to enable proper reuse of parts and recycling. This symbol of the crossed out wheeled bin indicates that the product (electrical and electronic equipment) should not be placed in municipal waste. Check local regulations for disposal of electronic products.



DO NOT throw the mercury-containing button cell battery in municipal waste. This symbol of the crossed out wheeled bin indicates that the battery should not be placed in municipal waste.

## ASUS Recycling/Takeback Services

ASUS recycling and takeback programs come from our commitment to the highest standards for protecting our environment. We believe in providing solutions for you to be able to responsibly recycle our products, batteries, other components as well as the packaging materials. Please go to <http://csr.asus.com/english/Takeback.htm> for detailed recycling information in different regions.

## Regional notice for California



### WARNING

Cancer and Reproductive Harm -  
[www.P65Warnings.ca.gov](http://www.P65Warnings.ca.gov)

## Google™ License Terms

Copyright© 2019 Google Inc. All Rights Reserved.

Licensed under the Apache License, Version 2.0 (the “License”); you may not use this file except in compliance with the License. You may obtain a copy of the License at:

<http://www.apache.org/licenses/LICENSE-2.0>

Unless required by applicable law or agreed to in writing, software distributed under the License is distributed on an “AS IS” BASIS, WITHOUT WARRANTIES OR CONDITIONS OF ANY KIND, either express or implied.

See the License for the specific language governing permissions and limitations under the License.

**English** ASUSTeK Computer Inc. hereby declares that this device is in compliance with the essential requirements and other relevant provisions of related Directives. Full text of EU declaration of conformity is available at: [www.asus.com/support](http://www.asus.com/support)

**Français** ASUSTeK Computer Inc. déclare par la présente que cet appareil est conforme aux critères essentiels et autres clauses pertinentes des directives concernées. La déclaration de conformité de l'UE peut être téléchargée à partir du site Internet suivant: [www.asus.com/support](http://www.asus.com/support)

**Deutsch** ASUSTeK Computer Inc. erklärt hiermit, dass dieses Gerät mit den wesentlichen Anforderungen und anderen relevanten Bestimmungen der zugehörigen Richtlinien übereinstimmt. Der gesamte Text der EU-Konformitätserklärung ist verfügbar unter: [www.asus.com/support](http://www.asus.com/support)

**Italiano** ASUSTeK Computer Inc. con la presente dichiara che questo dispositivo è conforme ai requisiti essenziali e alle altre disposizioni pertinenti con le direttive correlate. Il testo completo della dichiarazione di conformità UE è disponibile all'indirizzo: [www.asus.com/support](http://www.asus.com/support)

**Русский** Компания ASUS заявляет, что это устройство соответствует основным требованиям и другим соответствующим условиям соответствующих директив. Подробную информацию, пожалуйста, смотрите на [www.asus.com/support](http://www.asus.com/support)

**Български** С настоящото ASUSTeK Computer Inc. декларира, че това устройство е в съответствие със съществените изисквания и другите приложими постановления на свързаните директиви. Пълният текст на декларацията за съответствие на ЕС е достъпен на адрес: [www.asus.com/support](http://www.asus.com/support)

**Hrvatski** ASUSTeK Computer Inc. ovim izjavljuje da je ovaj uređaj sukladan s bitnim zahtjevima i ostalim odgovarajućim odredbama vezanih direktiva. Cijeli tekst EU izjave o sukladnosti dostupan je na: [www.asus.com/support](http://www.asus.com/support)

**Čeština** Společnost ASUSTeK Computer Inc. tímto prohlašuje, že toto zařízení splňuje základní požadavky a další příslušná ustanovení souvisejících směrnic. Plné znění prohlášení o shodě EU je k dispozici na adrese: [www.asus.com/support](http://www.asus.com/support)

**Dansk** ASUSTeK Computer Inc. erklærer hermed, at denne enhed er i overensstemmelse med hovedkravene og andre relevante bestemmelser i de relaterede direktiver. Hele EU-overensstemmelseserklæringen kan findes på: [www.asus.com/support](http://www.asus.com/support)

**Nederlands** ASUSTeK Computer Inc. verklaart hierbij dat dit apparaat voldoet aan de essentiële vereisten en andere relevante bepalingen van de verwante richtlijnen. De volledige tekst van de EU-verklaring van conformiteit is beschikbaar op: [www.asus.com/support](http://www.asus.com/support)

**Eesti** Käesolevaga kinnitab ASUSTeK Computer Inc, et see seade vastab asjakohaste direktiivide olulistele nõuetele ja teistele asjassepuutuvatele sätetele. El vastavusdeklaratsiooni täielik tekst on saadaval järgmisel aadressil: [www.asus.com/support](http://www.asus.com/support)

**Suomi** ASUSTeK Computer Inc. ilmoittaa täten, että tämä laite on asiaankuuluvien direktiivien olennaisien vaatimusten ja muiden tätä koskevien säädösten mukainen. EU-yhdenmukaisuusilmoituksen koko teksti on luettavissa osoitteessa: [www.asus.com/support](http://www.asus.com/support)

**Ελληνικά** Με το παρόν, η ASUSTeK Computer Inc. δηλώνει ότι αυτή η συσκευή συμμορφώνεται με τις θεμελιώδεις απαιτήσεις και άλλες σχετικές διατάξεις των Οδηγιών της ΕΕ. Το πλήρες κείμενο της δήλωσης συμμόρφωσης είναι διαθέσιμο στη διεύθυνση: [www.asus.com/support](http://www.asus.com/support)

**Magyar** Az ASUSTeK Computer Inc. ezennel kijelenti, hogy ez az eszköz megfelel a kapcsolódó irányelvek lényeges követelményeinek és egyéb vonatkozó rendelkezéseinek. Az EU megfélelőégi nyilatkozat teljes szövege innen letölthető: [www.asus.com/support](http://www.asus.com/support)

**Latviski** ASUSTeK Computer Inc. ar šo paziņo, ka šī ierīce atbilst saistošo Direktīvu būtiskajām prasībām un citiem citiem saistošajiem nosacījumiem. Pilns ES atbilstības paziņojuma teksts pieejams šeit: [www.asus.com/support](http://www.asus.com/support)

**Lietuvių** „ASUSTeK Computer Inc.“ šiuo tvirtina, kad šis įrenginys atitinka pagrindinius reikalavimus ir kitas svarbias susijusių direktyvų nuostatas. Visą ES atitikties deklaracijos tekstą galima rasti: [www.asus.com/support](http://www.asus.com/support)

**Norsk** ASUSTeK Computer Inc. erklærer herved at denne enheten er i samsvar med hovedsaklige krav og andre relevante forskrifter i relaterte direktiver. Fullstendig tekst for EU-samsvarserklæringen finnes på: [www.asus.com/support](http://www.asus.com/support)

**Polski** Firma ASUSTeK Computer Inc. niniejszym oświadcza, że urządzenie to jest zgodne z zasadniczymi wymogami i innymi właściwymi postanowieniami powiązanych dyrektyw. Pełny tekst deklaracji zgodności UE jest dostępny pod adresem: [www.asus.com/support](http://www.asus.com/support)

**Português** A ASUSTeK Computer Inc. declara que este dispositivo está em conformidade com os requisitos essenciais e outras disposições relevantes das Diretivas relacionadas. Texto integral da declaração da UE disponível em: [www.asus.com/support](http://www.asus.com/support)

**Română** ASUSTeK Computer Inc. declară că acest dispozitiv se conformează cerințelor esențiale și altor prevederi relevante ale directivelor conexe. Textul complet al declarației de conformitate a Uniunii Europene se găsește la: [www.asus.com/support](http://www.asus.com/support)

**Srpski** ASUSTeK Computer Inc. ovim izjavljuje da je ovaj uređaj u saglasnosti sa osnovnim zahtevima i drugim relevantnim odredbama povezanih Direktiva. Pun tekst EU deklaracije o usklađenosti je dostupan da adresi: [www.asus.com/support](http://www.asus.com/support)

**Slovensky** Spoločnosť ASUSTeK Computer Inc. týmto vyhlasuje, že toto zariadenie vyhovuje základným požiadavkám a ostatným príslušným ustanoveniam príslušných smerníc. Celý text vyhlásenia o zhode pre štáty EU je dostupný na adrese: [www.asus.com/support](http://www.asus.com/support)

**Slovenščina** ASUSTeK Computer Inc. izjavlja, da je ta naprava skladna z bistvenimi zahtevami in drugimi ustreznimi določbami povezanih direktiv. Celotno besedilo EU-izjave o skladnosti je na voljo na spletnem mestu: [www.asus.com/support](http://www.asus.com/support)

**Español** Por la presente, ASUSTeK Computer Inc. declara que este dispositivo cumple los requisitos básicos y otras disposiciones pertinentes de las directivas relacionadas. El texto completo de la declaración de la UE de conformidad está disponible en: [www.asus.com/support](http://www.asus.com/support)

**Svenska** ASUSTeK Computer Inc. förklarar härmed att denna enhet överensstämmer med de grundläggande kraven och andra relevanta föreskrifter i relaterad direktiv. Fulltext av EU-försäkran om överensstämmelse finns på: [www.asus.com/support](http://www.asus.com/support)

**Українська** ASUSTeK Computer Inc. заявляє, що цей пристрій відповідає основним вимогам та іншим відповідним положенням відповідних Директив. Повний текст декларації відповідності стандартам ЄС доступний на: [www.asus.com/support](http://www.asus.com/support)

**Türkçe** ASUSTeK Computer Inc., bu aygıtın temel gereksinimlerle ve ilişkili Yönergelerin diğer ilgili koşullarına uyumlu olduğunu beyan eder. AB uygunluk bildiriminin tam metni şu adreste bulunabilir: [www.asus.com/support](http://www.asus.com/support)

**Bosanski** ASUSTeK Computer Inc. ovim izjavljuje da je ovaj uređaj uskladen sa bitnim zahtjevima i ostalim odgovarajućim odredbama vezanih direktiva. Cijeli tekst EU izjave o usklađenosti dostupan je na: [www.asus.com/support](http://www.asus.com/support)



## ASUS contact information

### ASUSTeK COMPUTER INC.

Address 4F, No. 150, Li-Te Road, Peitou, Taipei 112, Taiwan  
Telephone +886-2-2894-3447  
Fax +886-2-2890-7798  
Web site <https://www.asus.com>

#### *Technical Support*

Telephone +86-21-38429911  
Fax +86-21-5866-8722, ext. 9101#  
Online support <https://www.asus.com/support/Product/ContactUs/Services/questionform/?lang=en>

### ASUS COMPUTER INTERNATIONAL (America)

Address 800 Corporate Way, Fremont, CA 94539, USA  
Telephone +1-510-739-3777  
Fax +1-510-608-4555  
Web site <https://www.asus.com/us/>

#### *Technical Support*

Support fax +1-812-284-0883  
Telephone +1-812-282-2787  
Online support <https://www.asus.com/support/Product/ContactUs/Services/questionform/?lang=en-us>

### ASUS COMPUTER GmbH (Germany and Austria)

Address Harkort Str. 21-23, 40880 Ratingen, Germany  
Fax +49-2102-959931  
Web site <https://www.asus.com/de>

#### *Technical Support*

Telephone +49-2102-5789555  
Support Fax +49-2102-959911  
Online support <https://www.asus.com/support/Product/ContactUs/Services/questionform/?lang=de-de>

# DECLARATION OF CONFORMITY

Per FCC Part 2 Section 2. 1077(a)



**Responsible Party Name:** Asus Computer International

**Address:** 800 Corporate Way, Fremont, CA 94539.

**Phone/Fax No:** (510)739-3777/(510)608-4555

hereby declares that the product

**Product Name :** Motherboard

**Model Number :** X99-E WS/USB3.1

Conforms to the following specifications:

FCC Part 15, Subpart B, Unintentional Radiators

### Supplementary Information:

This device complies with part 15 of the FCC Rules. Operation is subject to the following two conditions: (1) This device may not cause harmful interference, and (2) this device must accept any interference received, including interference that may cause undesired operation.

Representative Person's Name : Steve Chang / President

A handwritten signature in blue ink that reads "Steve Chang".

Signature :

Date : Apr. 24, 2015

Ver. 140331