



M5A78L-M Series

- *M5A78L-M LE*
- *M5A78L-M PLUS*

Motherboard

E8059

Second Edition

January 2013

Copyright © 2013 ASUSTeK Computer Inc. All Rights Reserved.

No part of this manual, including the products and software described in it, may be reproduced, transmitted, transcribed, stored in a retrieval system, or translated into any language in any form or by any means, except documentation kept by the purchaser for backup purposes, without the express written permission of ASUSTeK Computer Inc. ("ASUS").

Product warranty or service will not be extended if: (1) the product is repaired, modified or altered, unless such repair, modification or alteration is authorized in writing by ASUS; or (2) the serial number of the product is defaced or missing.

ASUS PROVIDES THIS MANUAL "AS IS" WITHOUT WARRANTY OF ANY KIND, EITHER EXPRESS OR IMPLIED, INCLUDING BUT NOT LIMITED TO THE IMPLIED WARRANTIES OR CONDITIONS OF MERCHANTABILITY OR FITNESS FOR A PARTICULAR PURPOSE. IN NO EVENT SHALL ASUS, ITS DIRECTORS, OFFICERS, EMPLOYEES OR AGENTS BE LIABLE FOR ANY INDIRECT, SPECIAL, INCIDENTAL, OR CONSEQUENTIAL DAMAGES (INCLUDING DAMAGES FOR LOSS OF PROFITS, LOSS OF BUSINESS, LOSS OF USE OR DATA, INTERRUPTION OF BUSINESS AND THE LIKE), EVEN IF ASUS HAS BEEN ADVISED OF THE POSSIBILITY OF SUCH DAMAGES ARISING FROM ANY DEFECT OR ERROR IN THIS MANUAL OR PRODUCT.

SPECIFICATIONS AND INFORMATION CONTAINED IN THIS MANUAL ARE FURNISHED FOR INFORMATIONAL USE ONLY, AND ARE SUBJECT TO CHANGE AT ANY TIME WITHOUT NOTICE, AND SHOULD NOT BE CONSTRUED AS A COMMITMENT BY ASUS. ASUS ASSUMES NO RESPONSIBILITY OR LIABILITY FOR ANY ERRORS OR INACCURACIES THAT MAY APPEAR IN THIS MANUAL, INCLUDING THE PRODUCTS AND SOFTWARE DESCRIBED IN IT.

Products and corporate names appearing in this manual may or may not be registered trademarks or copyrights of their respective companies, and are used only for identification or explanation and to the owners' benefit, without intent to infringe.

Offer to Provide Source Code of Certain Software

This product may contain copyrighted software that is licensed under the General Public License ("GPL") and under the Lesser General Public License Version ("LGPL"). The GPL and LGPL licensed code in this product is distributed without any warranty. Copies of these licenses are included in this product.

You may obtain the complete corresponding source code (as defined in the GPL) for the GPL Software, and/or the complete corresponding source code of the LGPL Software (with the complete machine-readable "work that uses the Library") for a period of three years after our last shipment of the product including the GPL Software and/or LGPL Software, which will be no earlier than December 1, 2011, either

(1) for free by downloading it from <http://support.asus.com/download>;

or

(2) for the cost of reproduction and shipment, which is dependent on the preferred carrier and the location where you want to have it shipped to, by sending a request to:

ASUSTeK Computer Inc.
Legal Compliance Dept.
15 Li Te Rd.,
Beitou, Taipei 112
Taiwan

In your request please provide the name, model number and version, as stated in the About Box of the product for which you wish to obtain the corresponding source code and your contact details so that we can coordinate the terms and cost of shipment with you.

The source code will be distributed WITHOUT ANY WARRANTY and licensed under the same license as the corresponding binary/object code.

This offer is valid to anyone in receipt of this information.

ASUSTeK is eager to duly provide complete source code as required under various Free Open Source Software licenses. If however you encounter any problems in obtaining the full corresponding source code we would be much obliged if you give us a notification to the email address gpl@asus.com, stating the product and describing the problem (please do NOT send large attachments such as source code archives etc to this email address).

Contents

Notices.....	vi
Safety information	vii
About this guide	viii
M5A78L-M Series specifications summary	ix

Chapter 1: Product introduction

1.1	Welcome!	1-1
1.2	Package contents	1-1
1.3	Special features	1-1
1.3.1	Product highlights	1-1
1.3.2	Innovative ASUS features.....	1-3
1.4	Before you proceed	1-5
1.5	Motherboard overview	1-6
1.5.1	Placement direction	1-6
1.5.2	Screw holes	1-6
1.5.3	Motherboard layout.....	1-7
1.5.4	Layout contents.....	1-7
1.6	Central Processing Unit (CPU)	1-8
1.6.1	Installing the CPU	1-8
1.6.2	Installing the heatsink and fan	1-10
1.7	System memory	1-11
1.7.1	Overview	1-11
1.7.2	Memory configurations.....	1-12
1.7.3	Installing a DIMM	1-16
1.7.4	Removing a DIMM	1-16
1.8	Expansion slots	1-17
1.8.1	Installing an expansion card	1-17
1.8.2	Configuring an expansion card	1-17
1.8.3	PCI slots.....	1-17
1.8.4	PCI Express x1 slot.....	1-17
1.8.5	PCI Express x16 slot.....	1-17
1.9	Jumpers	1-18
1.10	Connectors	1-20
1.10.1	Rear panel ports	1-20
1.10.2	Internal connectors	1-21

Contents

1.11	Software support	1-28
1.11.1	Installing an operating system	1-28
1.11.2	Support DVD information	1-28

Chapter 2: BIOS information

2.1	Managing and updating your BIOS	2-1
2.1.1	ASUS Update.....	2-1
2.1.2	ASUS EZ Flash 2.....	2-2
2.1.3	ASUS CrashFree BIOS 3.....	2-3
2.2	BIOS setup program	2-4
2.2.1	BIOS menu screen.....	2-5
2.2.2	Menu bar.....	2-5
2.2.3	Navigation keys.....	2-5
2.2.4	Menu items	2-6
2.2.5	Submenu items	2-6
2.2.6	Configuration fields	2-6
2.2.7	Pop-up window	2-6
2.2.8	Scroll bar.....	2-6
2.2.9	General help	2-6
2.3	Main menu	2-7
2.3.1	System Time [xx:xx:xx]	2-7
2.3.2	System Date [Day xx/xx/xxxx].....	2-7
2.3.3	SATA3G_1/2/3/4/5/6	2-7
2.3.4	SATA Configuration	2-8
2.3.5	System Information	2-9
2.4	Advanced menu	2-10
2.4.1	JumperFree Configuration	2-10
2.4.2	CPU Configuration	2-13
2.4.3	Chipset.....	2-14
2.4.4	Onboard Devices Configuration.....	2-15
2.4.5	PCIePnP	2-16
2.4.6	USB Configuration	2-16
2.5	Power menu	2-17
2.5.1	Suspend Mode [Auto]	2-17
2.5.2	ACPI 2.0 Support [Enabled].....	2-17
2.5.3	ACPI APIC Support [Enabled].....	2-17

2.5.4	APM Configuration	2-17
2.5.5	HW Monitor Configuration.....	2-18
2.5.6	Anti Surge Support [Enabled]	2-18
2.6	Boot menu	2-19
2.6.1	Boot Device Priority	2-19
2.6.2	Boot Settings Configuration	2-19
2.6.3	Security	2-20
2.7	Tools menu	2-22
2.7.1	ASUS EZ Flash 2.....	2-22
2.7.2	ASUS O.C. Profile.....	2-22
2.8	Exit menu	2-23

Notices

Federal Communications Commission Statement

This device complies with Part 15 of the FCC Rules. Operation is subject to the following two conditions:

- This device may not cause harmful interference, and
- This device must accept any interference received including interference that may cause undesired operation.

This equipment has been tested and found to comply with the limits for a Class B digital device, pursuant to Part 15 of the FCC Rules. These limits are designed to provide reasonable protection against harmful interference in a residential installation. This equipment generates, uses and can radiate radio frequency energy and, if not installed and used in accordance with manufacturer's instructions, may cause harmful interference to radio communications. However, there is no guarantee that interference will not occur in a particular installation. If this equipment does cause harmful interference to radio or television reception, which can be determined by turning the equipment off and on, the user is encouraged to try to correct the interference by one or more of the following measures:

- Reorient or relocate the receiving antenna.
- Increase the separation between the equipment and receiver.
- Connect the equipment to an outlet on a circuit different from that to which the receiver is connected.
- Consult the dealer or an experienced radio/TV technician for help.



The use of shielded cables for connection of the monitor to the graphics card is required to assure compliance with FCC regulations. Changes or modifications to this unit not expressly approved by the party responsible for compliance could void the user's authority to operate this equipment.

Canadian Department of Communications Statement

This digital apparatus does not exceed the Class B limits for radio noise emissions from digital apparatus set out in the Radio Interference Regulations of the Canadian Department of Communications.

This class B digital apparatus complies with Canadian ICES-003.

ASUS Recycling/Takeback Services

ASUS recycling and takeback programs come from our commitment to the highest standards for protecting our environment. We believe in providing solutions for you to be able to responsibly recycle our products, batteries, other components as well as the packaging materials. Please go to <http://csr.asus.com/english/Takeback.htm> for the detailed recycling information in different regions.

REACH

Complying with the REACH (Registration, Evaluation, Authorisation, and Restriction of Chemicals) regulatory framework, we published the chemical substances in our products at ASUS REACH website at <http://csr.asus.com/english/REACH.htm>.



DO NOT throw the motherboard in municipal waste. This product has been designed to enable proper reuse of parts and recycling. This symbol of the crossed out wheeled bin indicates that the product (electrical and electronic equipment) should not be placed in municipal waste. Check local regulations for disposal of electronic products.



DO NOT throw the mercury-containing button cell battery in municipal waste. This symbol of the crossed out wheeled bin indicates that the battery should not be placed in municipal waste.

Safety information

Electrical safety

- To prevent electric shock hazard, disconnect the power cable from the electric outlet before relocating the system.
- When adding or removing devices to or from the system, ensure that the power cables for the devices are unplugged before the signal cables are connected. If possible, disconnect all power cables from the existing system before you add a device.
- Before connecting or removing signal cables from the motherboard, ensure that all power cables are unplugged.
- Seek professional assistance before using an adapter or extension cord. These devices could interrupt the grounding circuit.
- Ensure that your power supply is set to the correct voltage in your area. If you are not sure about the voltage of the electrical outlet you are using, contact your local power company.
- If the power supply is broken, do not try to fix it by yourself. Contact a qualified service technician or your retailer.

Operation safety

- Before installing the motherboard and adding devices on it, carefully read all the manuals that came with the package.
- Before using the product, ensure that all cables are correctly connected and the power cables are not damaged. If you detect any damage, contact your dealer immediately.
- To avoid short circuits, keep paper clips, screws, and staples away from connectors, slots, sockets and circuitry.
- Avoid dust, humidity, and temperature extremes. Do not place the product in any area where it may become wet.
- Place the product on a stable surface.
- If you encounter technical problems with the product, contact a qualified service technician or your retailer.

About this guide

This user guide contains the information you need when installing and configuring the motherboard.

How this guide is organized

This guide contains the following parts:

- **Chapter 1: Product introduction**

This chapter describes the features of the motherboard and the new technology it supports.

- **Chapter 2: BIOS information**

This chapter tells how to change system settings through the BIOS Setup menus. Detailed descriptions of the BIOS parameters are also provided.

Conventions used in this guide

To ensure that you perform certain tasks properly, take note of the following symbols used throughout this manual.



DANGER/WARNING: Information to prevent injury to yourself when trying to complete a task.



CAUTION: Information to prevent damage to the components when trying to complete a task.



IMPORTANT: Instructions that you **MUST** follow to complete a task.



NOTE: Tips and additional information to help you complete a task.

Where to find more information

Refer to the following sources for additional information and for product and software updates.

1. **ASUS websites**

The ASUS website provides updated information on ASUS hardware and software products. Refer to the ASUS contact information.

2. **Optional documentation**

Your product package may include optional documentation, such as warranty flyers, that may have been added by your dealer. These documents are not part of the standard package.

Typography

Bold text

Indicates a menu or an item to select.

Italics

Used to emphasize a word or a phrase.

<Key>

Keys enclosed in the less-than and greater-than sign means that you must press the enclosed key.

Example: <Enter> means that you must press the Enter or Return key.

<Key1>+<Key2>+<Key3>

If you must press two or more keys simultaneously, the key names are linked with a plus sign (+).

Example: <Ctrl>+<Alt>+<D>

M5A78L-M Series specifications summary

CPU	<p>AMD® Socket AM3+ for AMD® FX™ / Phenom™ II / Athlon™ II / Sempron™ 100 series processors</p> <p>Supports 32nm AM3+ CPU</p> <p>AMD® Cool 'n' Quiet™ Technology</p> <p>Supports CPU up to 95W</p> <p>* Refer to www.asus.com for the AMD® CPU support list</p>
Chipset	AMD® 760G (780L) / SB710
System bus	Up to 5200 MT/s HyperTransport™ 3.0 interface
Memory	<p>2 x DIMM, max. 16GB, DDR3 1866(O.C.) / 1600(O.C.) / 1333 / 1066 MHz, ECC and non-ECC, un-buffered memory</p> <p>Dual-channel memory architecture</p> <p>* AMD® FX™ Series CPU on this motherboard supports up to DDR3 1866MHz as its standard memory frequency.</p> <p>** Due to CPU spec., AMD® 100 and 200 series CPUs support up to DDR3 1066MHz. With ASUS design, this motherboard can support up to DDR3 1333MHz.</p> <p>*** When overclocking, some AMD CPU models may not support DDR3 1600 MHz or higher frequency DIMMs.</p> <p>**** Refer to www.asus.com for the latest Memory QVL (Qualified Vendors List).</p> <p>***** When you install a total memory of 4GB or more, Windows® 32-bit operating system may only recognize less than 3GB. We recommend a maximum of 3GB system memory if you are using a Windows® 32-bit operating system.</p>
Graphics	<p>Integrated ATI Radeon™ HD 3000 GPU</p> <p>Supports max. shared memory of 1GB</p> <p>Supports DVI-D compliant with HDCP with max. resolution of 2560 x 1600 (@60Hz)</p> <p>Supports RGB with max. resolution of 2048 x 1536 (@75Hz)</p> <p>Supports Hybrid CrossFireX™</p> <p>* Refer to www.amd.com for the discrete GPUs that support Hybrid CrossFireX™.</p>
Expansion slots	<p>1 x PCIe 2.0 x16 slot</p> <p>1 x PCIe 2.0 x1 slot</p> <p>2 x PCI slots</p>
Storage	6 x Serial ATA 3Gb/s connectors support RAID 0, RAID 1, RAID 10, and JBOD configurations
LAN	Realtek® 8111E PCIe Gigabit LAN controller
Audio	<p>ALC887 8-channel* High Definition Audio CODEC</p> <p>* Use a chassis with HD audio module in the front panel to support an 8-channel audio output.</p>
USB	<p>AMD® SB710 chipset:</p> <ul style="list-style-type: none"> - 12 x USB 2.0/1.1 ports (8 ports at the mid-board, 4 ports at the back panel)

(continued on the next page)

M5A78L-M Series specifications summary

ASUS unique features	<ul style="list-style-type: none"> Core Unlocker ASUS EPU ASUS CrashFree BIOS 3 ASUS EZ Flash 2 ASUS Q-Fan ASUS MyLogo 2 ASUS C.P.R. (CPU Parameter Recall) ASUS Anti Surge ASUS AI Charger ASUS Turbo Key 100% All high quality conductive polymer capacitors (M5A78L-M PLUS only)
Back panel I/O ports	<ul style="list-style-type: none"> 1 x PS/2 Keyboard port 1 x PS/2 Mouse port 1 x LAN (RJ-45) port 1 x D-Sub port 1 x DVI port 3 x Audio jacks 4 x USB 2.0/1.1 ports
Internal I/O connectors	<ul style="list-style-type: none"> 4 x USB 2.0/1.1 connectors support additional 8 USB 2.0/1.1 ports 6 x SATA 3Gb/s connectors 1 x Front panel audio connector 1 x CPU fan connector 1 x Chassis fan connector 1 x COM connector 1 x LPT connector 1 x Speaker connector 1 x System panel connector 1 x S/PDIF Out connector 1 x 24-pin EATX power connector 1 x 4-pin ATX 12V power connector
BIOS	16 Mb Flash ROM, AMI BIOS, PnP, DMI v2.0, WfM 2.0, ACPI v2.0a, SM BIOS v2.5
Accessories	<ul style="list-style-type: none"> 2 x Serial ATA 3Gb/s cables 1 x I/O shield 1 x User Manual 1 x Support DVD
Support DVD	<ul style="list-style-type: none"> Drivers ASUS utilities ASUS Update Anti-virus software (OEM version)
Form factor	MicroATX form factor: 9.6 in x 8.2 in (24.4 cm x 20.8 cm)

* Specifications are subject to change without notice.

Chapter 1

Product introduction

1.1 Welcome!

Thank you for buying an ASUS® M5A78L-M Series motherboard!

The motherboard delivers a host of new features and latest technologies, making it another standout in the long line of ASUS quality motherboards!

Before you start installing the motherboard, and hardware devices on it, check the items in your package with the list below.

1.2 Package contents

Check your motherboard package for the following items.

Motherboard	ASUS M5A78L-M Series motherboard
Cables	2 x Serial ATA 3Gb/s cables
Accessories	1 x I/O shield
Application DVD	ASUS motherboard Support DVD
Documentation	User Manual



- M5A78L-M Series motherboards include M5A78L-M PLUS and M5A78L-M LE two models. The package contents vary from models. The layout illustrations in this user guide are for M5A78L-M LE only.
- If any of the items is damaged or missing, contact your retailer.

1.3 Special features

1.3.1 Product highlights



AMD® FX™ / Phenom™ II / Athlon™ II / Sempron™ 100 series CPU support

This motherboard supports AMD® Socket AM3+ multi-core processors with unique L3 cache and delivers better overclocking capabilities with less power consumption. It features dual-channel DDR3 memory support and accelerates data transfer rate up to 5200MT/s via HyperTransport™ 3.0-based system bus. This motherboard also supports AMD® CPUs in the new 32nm manufacturing process.



AMD® Cool ‘n’ Quiet Technology

This motherboard supports the AMD® Cool ‘n’ Quiet technology which monitors system operation and automatically adjusts CPU voltage and frequency for a cool and quiet operating environment.

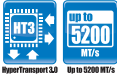

HyperTransport™ 3.0 support

HyperTransport™ 3.0 technology provides 2.6 times more bandwidth than HT1.0 that radically improves system efficiency for a smoother and faster computing environment.



Dual-Channel DDR3 1866(O.C.) support

This motherboard supports DDR3 memory that features data transfer rates of 1866 (O.C.) / 1600 (O.C.) / 1333 / 1066 MHz to meet the higher bandwidth requirements of the latest operating system, 3D graphics, multimedia, and Internet applications.



Gigabit LAN solution

The onboard LAN controller is a highly integrated Gb LAN controller. It is enhanced with an ACPI management function to provide efficient power management for advanced operating systems.



Serial ATA 3Gb/s technology and RAID support

This motherboard supports hard drives based on the Serial ATA (SATA) 3Gb/s storage specification, delivering enhanced scalability and doubling the bus bandwidth for high-speed data retrieval and save. It also supports RAID 0, RAID 1, and RAID 10 configurations for Serial ATA hard drives.



8-channel high definition audio

Enjoy high-end sound quality on your PC! The onboard 8-channel High Definition Audio CODEC enables high-quality 192KHz/24-bit audio output, jack-sensing feature, and multi-streaming technology that simultaneously sends different audio streams to different destinations. You can now talk to your partners on the headphone while playing multi-channel network games.



100% All High-quality Conductive Polymer Capacitors (M5A78L-M PLUS only)

This motherboard uses all high-quality conductive polymer capacitors for durability, improved lifespan, and enhanced thermal capacity.

1.3.2 Innovative ASUS features



Core Unlocker

ASUS Core Unlocker simplifies the activation of a latent AMD® CPU- with just pressing a key. Enjoy an instant performance boost by simply unlocking the extra cores, without performing complicated BIOS changes.



ASUS EPU

ASUS EPU is a unique power saving technology that detects the current system loadings and adjusts the power consumption in real time.



ASUS Turbo Key

ASUS Turbo Key allows you to turn the PC power button into an overclocking button. After the easy setup, Turbo Key boosts performances without interrupting ongoing work or games, simply through pressing the button.



ASUS MyLogo2™

Turn your favorite photos into 256-color boot logos to personalize your system.



ASUS CrashFree BIOS 3

ASUS CrashFree BIOS 3 is an auto-recovery tool that allows you to restore a corrupted BIOS file using the bundled support DVD or a USB flash disk that contains the BIOS file.



ASUS EZ Flash 2

ASUS EZ Flash 2 allows you to update the BIOS from a USB flash disk before entering the OS.



ASUS Q-Fan

ASUS Q-Fan technology intelligently adjusts the CPU fan speed according to system loading to ensure a quiet, cool, and efficient operation.



ASUS Anti-Surge Protection

This special design protects expensive devices and the motherboard from damage caused by power surges from switching power supply unit (PSU).



C.P.R. (CPU Parameter Recall)

The BIOS C.P.R. feature automatically restores the CPU default settings when the system hangs due to overclocking failure. C.P.R. eliminates the need to open the system chassis and clear the RTC data. Simply shut down and reboot the system, and the BIOS automatically restores the CPU parameters to their default settings.



ErP ready

The motherboard is European Union's Energy-related Products (ErP) ready, and ErP requires products to meet certain energy efficiency requirements in regards to energy consumptions. This is in line with ASUS vision of creating environment-friendly and energy-efficient products through product design and innovation to reduce carbon footprint of the product and thus mitigate environmental impacts.

1.4 Before you proceed

Take note of the following precautions before you install motherboard components or change any motherboard settings.



- Unplug the power cord from the wall socket before touching any component.
- Before handling components, use a grounded wrist strap or touch a safely grounded object or a metal object, such as the power supply case, to avoid damaging them due to static electricity.
- Hold components by the edges to avoid touching the ICs on them.
- Whenever you uninstall any component, place it on a grounded antistatic pad or in the bag that came with the component.
- Before you install or remove any component, switch off the ATX power supply and detach its power cord. Failure to do so may cause severe damage to the motherboard, peripherals, or components.

Onboard LED

The motherboard comes with a standby power LED that lights up to indicate that the system is ON, in sleep mode, or in soft-off mode. This is a reminder that you should shut down the system and unplug the power cable before removing or plugging in any motherboard component. The illustration below shows the location of the onboard LED.

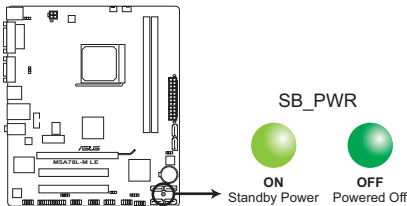

M5A78L-M LE Onboard LED

1.5 Motherboard overview

1.5.1 Placement direction

When installing the motherboard, ensure that you place it into the chassis in the correct orientation. The edge with external ports goes to the rear part of the chassis as indicated in the image below.

1.5.2 Screw holes

Place six screws into the holes indicated by circles to secure the motherboard to the chassis.



DO NOT overtighten the screws! Doing so can damage the motherboard.

Place this side towards
the rear of the chassis.

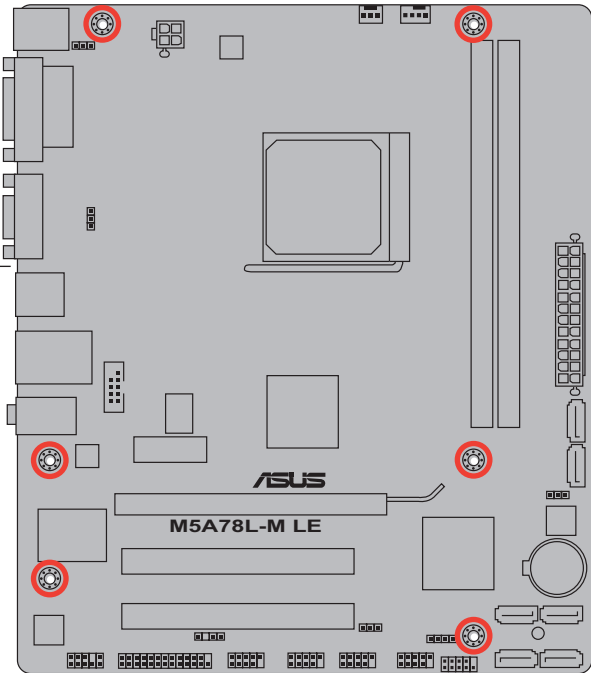

1.5.3 Motherboard layout

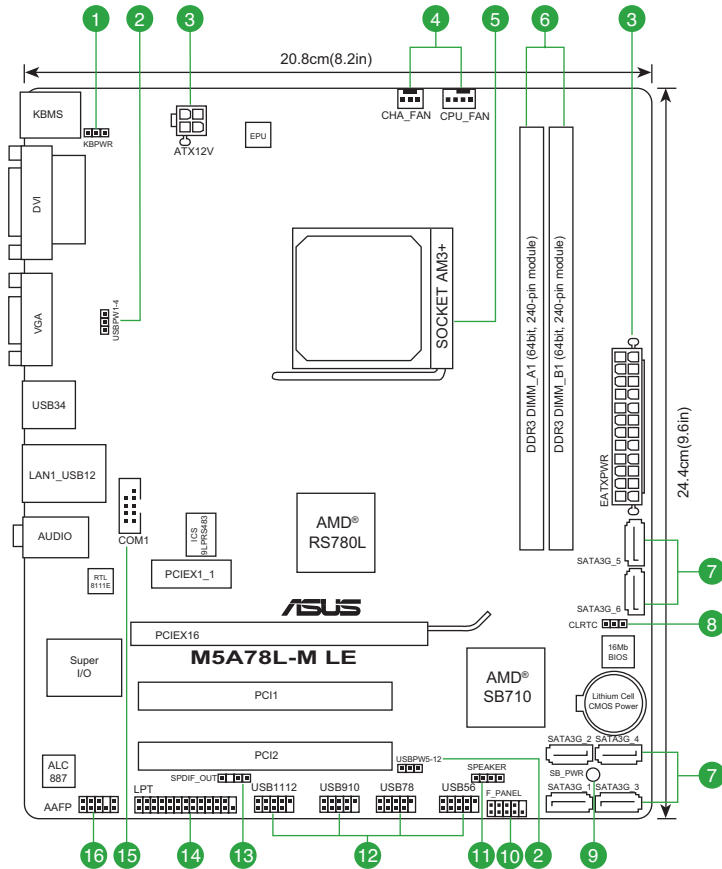

1.5.4 Layout contents

Connectors/Jumpers/Slots	Page	Connectors/Jumpers/Slots	Page
1. Keyboard power (3-pin KBPWR)	1-19	9. Onboard LED (SB_PWR)	1-5
2. USB device wake-up (3-pin USBPW1-4, USBPW5-12)	1-19	10. System panel connector (10-1 pin PANEL)	1-25
3. ATX power connectors (24-pin EATXPWR, 4-pin ATX12V)	1-22	11. Speaker connector (4-pin SPEAKER)	1-25
4. CPU and chassis fan connectors (4-pin CPU_FAN, 3-pin CHA_FAN)	1-27	12. USB connectors (10-1 pin USB56, USB78, USB910, USB1112)	1-26
5. AMD CPU socket	1-8	13. Digital audio connector (4-1 pin SPDIF_OUT)	1-26
6. DDR3 DIMM sockets	1-11	14. LPT connector (26-1 pin LPT)	1-23
7. Serial ATA connectors (7-pin SATA3G_1~6)	1-24	15. Serial port connector (10-1 pin COM1)	1-23
8. Clear RTC RAM (CLRTC)	1-18	16. Front panel audio connector (10-1 pin AAFP)	1-21

1.6 Central Processing Unit (CPU)

This motherboard comes with an AM3+ socket designed for FX™ / Phenom™ II / Athlon™ II / Sempron™ 100 series processors.



Ensure that you use a CPU designed for the AM3+ socket. The CPU fits in only one correct orientation. DO NOT force the CPU into the socket to prevent bending the pins and damaging the CPU!

1.6.1 Installing the CPU

To install a CPU:

1. Locate the CPU socket on the motherboard.

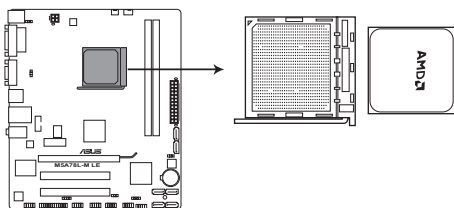

M5A78L-M LE CPU socket AM3+

2. Press the lever sideways to unlock the socket, then lift it up to a 90°-100° angle.



Ensure that the socket lever is lifted up to a 90°-100° angle; otherwise, the CPU will not fit in completely.

Socket lever

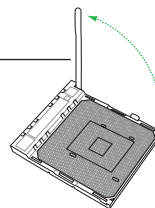

3. Position the CPU above the socket such that the CPU corner with the gold triangle matches the socket corner with a small triangle.
4. Carefully insert the CPU into the socket until it fits in place.



The CPU fits only in one correct orientation. DO NOT force the CPU into the socket to prevent bending the pins and damaging the CPU!

Small triangle

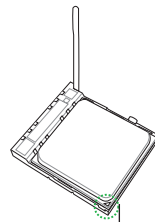

Gold triangle

- When the CPU is in place, push down the socket lever to secure the CPU. The lever clicks on the side tab to indicate that it is locked.
- Install a CPU heatsink and fan following the instructions that comes with the heatsink package. You can also refer to section **1.6.2 Installing heatsink and fan** for instructions.

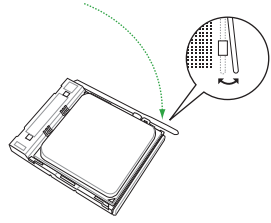

- Connect the CPU fan cable to the CPU_FAN connector on the motherboard.

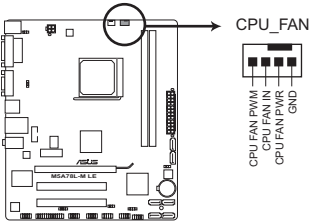

M5A78L-M LE CPU fan connector



DO NOT forget to connect the CPU fan connector! Hardware monitoring errors can occur if you fail to plug this connector.

1.6.2 Installing the heatsink and fan



Ensure that you use only AMD-certified heatsink and fan assembly.

To install the CPU heatsink and fan:

1. Place the heatsink on top of the installed CPU, ensuring that the heatsink fits properly on the retention module base.



- The retention module base is already installed on the motherboard upon purchase.
- You do not have to remove the retention module base when installing the CPU or installing other motherboard components.
- If you purchased a separate CPU heatsink and fan assembly, ensure that a Thermal Interface Material is properly applied to the CPU heatsink or CPU before you install the heatsink and fan assembly.

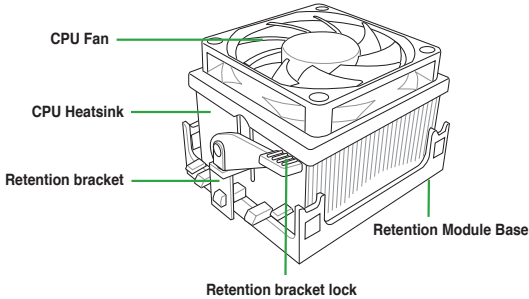

Your boxed CPU heatsink and fan assembly should come with installation instructions for the CPU, heatsink, and the retention mechanism. If the instructions in this section do not match the CPU documentation, follow the latter.

2. Attach one end of the retention bracket to the retention module base.

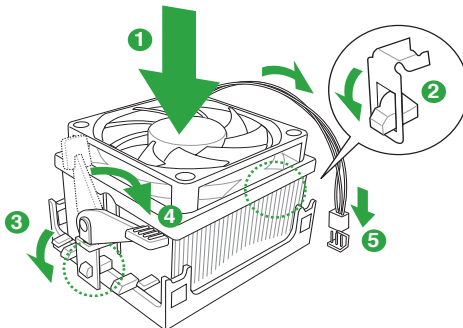

- Align the other end of the retention bracket to the retention module base. A clicking sound denotes that the retention bracket is in place.



Ensure that the fan and heatsink assembly perfectly fits the retention mechanism module base, otherwise you cannot snap the retention bracket in place.

- Push down the retention bracket lock on the retention mechanism to secure the heatsink and fan to the module base.
- When the fan and heatsink assembly is in place, connect the CPU fan cable to the connector on the motherboard labeled CPU_FAN.



DO NOT forget to connect the CPU fan connector! Hardware monitoring errors can occur if you fail to plug this connector.

1.7 System memory

1.7.1 Overview

This motherboard comes with two Double Data Rate 3 (DDR3) Dual Inline Memory Modules (DIMM) sockets. A DDR3 module has the same physical dimensions as a DDR2 DIMM but is notched differently to prevent installation on a DDR2 DIMM socket. DDR3 modules are developed for better performance with less power consumption. The figure illustrates the location of the DDR3 DIMM sockets:

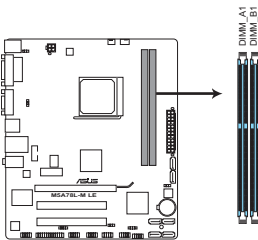

M5A78L-M LE 240-pin DDR3 DIMM sockets

Channel	Sockets
Channel A	DIMM_A1
Channel B	DIMM_B1

1.7.2 Memory configurations

You may install 1GB, 2GB, 4GB, and 8GB unbuffered ECC and non-ECC DDR3 DIMMs into the DIMM sockets.



- You may install varying memory sizes in Channel A and Channel B. The system maps the total size of the lower-sized channel for the dual-channel configuration. Any excess memory from the higher-sized channel is then mapped for single-channel operation.
- Always install DIMMs with the same CAS latency. For optimum compatibility, we recommend that you obtain memory modules from the same vendor.
- We recommend that you install the memory modules from the blue slots for better overclocking capability.
- AMD® FX™ Series CPU on this motherboard supports up to DDR3 1866MHz as its standard memory frequency.
- Due to the CPU specification, AMD® 100 and 200 series CPUs support up to DDR3 1066MHz. With ASUS design, this motherboard can support up to DDR3 1333MHz.
- When overclocking, some AMD CPUs may not support DDR3 1600MHz or higher frequency DIMMs.
- Due to the memory address limitation on 32-bit Windows® OS, when you install 4GB or more memory on the motherboard, the actual usable memory for the OS can be about 3GB or less. For effective use of memory, we recommend that you do any of the followings:
 - Install a maximum of 3GB system memory if you are using a 32-bit Windows® OS.
 - Use a 64-bit Windows® OS if you want to install 4GB or more memory on the motherboard.
- This motherboard does not support DIMMs made up of 512 megabits (Mb) chips or less.

M5A78L-M Series Motherboards Qualified Vendors Lists (QVL)

DDR3-1866(O.C.) MHz capability

Vendor	Part No.	Size	SS/DS	Brand	Chip NO.	Timing DIMM (BIOS)	Voltage	DIMM Support	
								A*	B*
Apacer	78.0AGCD.CDZ(XMP)	2048MB(Kit of 2)	SS	N/A	Heat-Sink Package			•	
Corsair	CM3X2G1800C8D	2048MB	DS	N/A	Heat-Sink Package			•	•
Transcend	TX1800KLU-2GK	1024MB	SS	N/A	Heat-Sink Package			•	•

DDR3-1600(O.C.) MHz capability

Vendor	Part No.	Size	SS/DS	Brand	Chip NO.	Timing DIMM (BIOS)	Voltage	DIMM Support	
								A*	B*
A-Data	AD31600X002GMU	4096MB(Kit of 2)	DS	N/A	Heat-Sink Package	7-7-7-20	1.75-1.85V	•	•
Corsair	CM3X1G1600C9DHX	2048MB(Kit of 2)	SS	N/A	Heat-Sink Package	9-9-9-24	1.8V	•	•
Corsair	CM3X2G1600C9DHX	2048MB	DS	N/A	Heat-Sink Package			•	•
Corsair	TR3X6G1600C8 G(XMP)	6144MB(Kit of 3)	DS	N/A	Heat-Sink Package			•	•
Corsair	TR3X6G1600C8D G(XMP)	6144MB(Kit of 3)	DS	N/A	Heat-Sink Package	8-8-8-24	1.65V	•	•
Corsair	TR3X6G1600C9 G(XMP)	6144MB(Kit of 3)	DS	N/A	Heat-Sink Package	9-9-9-24	1.65V	•	•

continued on the next page

DDR3-1600(O.C.) MHz capability

Vendor	Part No.	Size	SS/ DS	Brand	Chip NO.	Timing DIMM (BIOS)	Voltage	DIMM Support	
								A*	B*
Corsair	TR3X6G1600C8D G(XMP)	6144MB(Kit of 3)	DS	N/A	Heat-Sink Package	8-8-8-24	1.65V	*	*
Crucial	BL12864BA1608.8SFB(XMP)	3072MB(Kit of 3)	SS	N/A	Heat-Sink Package	8-8-8-24	1.8V	*	*
Crucial	BL12864BE2009.8SFB3(EPP)	3072MB(Kit of 3)	SS	N/A	Heat-Sink Package	9-9-9-28	2.0V	*	*
Crucial	BL25664BN1608.16FF(XMP)	6144MB(Kit of 3)	DS	N/A	Heat-Sink Package			*	*
Crucial	BL25664TB1608.K16SF(XMP)	6144MB(Kit of 3)	DS	N/A	Heat-Sink Package	8-8-8-24		*	*
Crucial	BL25664TG1608.K16SF(XMP)	6144MB(Kit of 3)	DS	N/A	Heat-Sink Package	8-8-8-24		*	*
Crucial	BL25664TR1608.K16SF(XMP)	6144MB(Kit of 3)	DS	N/A	Heat-Sink Package	8-8-8-24		*	*
G.SKILL	F3-12800CL9D-2GBNQ	2048MB(Kit of 2)	SS	N/A	Heat-Sink Package	9-9-9-24	1.5V~1.6V	*	*
G.SKILL	F3-12800CL8T-6GBHK	2048MB	DS	N/A	Heat-Sink Package	8-8-8-21	1.6~1.65	*	*
G.SKILL	F3-12800CL9T-6GBNQ	6144MB(Kit of 3)	DS	N/A	Heat-Sink Package	9-9-9-24	1.5V~1.6V	*	*
Kingmax	FLGD45F-B8KG9	1024MB	SS	Kingmax	KFB8FNGXF-ANX-12A			*	*
Kingmax	FLGD45F-B8MF7 MAEH(XMP)	1024MB	SS	N/A	Heat-Sink Package	7		*	*
Kingmax	FLGE85F-B8KG9	2048MB	DS	Kingmax	KFB8FNGXF-ANX-12A			*	*
Kingmax	FLGE85F-B8MF7 MEEH(XMP)	2048MB	DS	N/A	Heat-Sink Package	7		*	*
Kingston	KHX1600C9D3K2/4G	4096MB(Kit of 2)	DS	N/A	Heat-Sink Package		1.7-1.9V	*	*
Kingston	KHX1600C9D3K3/6GX(XMP)	6144MB(Kit of 3)	DS	N/A	Heat-Sink Package		1.65V	*	*
OCZ	OCZ3G1600LV3GK	3072MB(Kit of 3)	SS	N/A	Heat-Sink Package	8-8-8-24	1.65V	*	*
OCZ	OCZ3G1600LV6GK	6144MB(Kit of 3)	DS	N/A	Heat-Sink Package	8-8-8-24	1.65V	*	*
Super Talent	WA160UX6G9	6144MB(Kit of 3)	DS	N/A	Heat-Sink Package	9		*	*
CORSAIR	CM28GX3M1A1600C10(XMP)	8GB	DS	-	-	10-10-10-27	1.50V	*	*
Transcend	8G DDR3 1600 DIMM CL11	8GB	DS	SEC 222 HYKO	6MD9639W	-	-	*	*
Elixir	M2X8G64CB8H5N-DG(XMP)	8GB	DS	Elixir 1213	N2CB4G8BOBN-DG	-	-	*	*

DDR3-1333 MHz capability

Vendor	Part No.	Size	SS/ DS	Brand	Chip NO.	Timing DIMM (BIOS)	Voltage	DIMM Support	
								A*	B*
A-Data	AD31333001GOU	1024MB	SS	A-Data	AD30908C8D-151C E0906			*	*
A-Data	AD31333G001GOU	3072MB(Kit of 3)	SS	N/A	Heat-Sink Package	8-8-8-24	1.65-1.85V	*	*
A-Data	AD31333002GOU	2048MB	DS	A-Data	AD30908C8D-151C E0903			*	*
A-Data	AD31333G002GMU	2048MB	DS	N/A	Heat-Sink Package	8-8-8-24	1.65-1.85V	*	*
Apacer	78.01GC6.9L0	1024MB	SS	Apacer	AMS5D5808AEWSBG0914E	9		*	*
Apacer	78.A1GC6.9L1	2048MB	DS	Apacer	AMS5D5808AEWSBG0908D	9		*	*
Corsair	CM3X1024-1333C9DHX	1024MB	SS	N/A	Heat-Sink Package	9-9-9-24	1.60V	*	*
Corsair	CM3X1024-1333C9	1024MB	SS	N/A	Heat-Sink Package			*	*
Corsair	TR3X3G1333C9 G	3072MB(Kit of 3)	SS	N/A	Heat-Sink Package	9-9-9-24	1.50V	*	*
Corsair	TR3X3G1333C9 G	3072MB(Kit of 3)	SS	N/A	Heat-Sink Package	9-9-9-24	1.50V	*	*
Corsair	TR3X3G1333C9	3072MB(Kit of 3)	SS	N/A	Heat-Sink Package	9	1.5V	*	*
Corsair	CM3X1024-1333C9DHX	1024MB	DS	Corsair	Heat-Sink Package			*	*
Corsair	CM3X2048-1333C9DHX	2048MB	DS	N/A	Heat-Sink Package			*	*
Corsair	TW3X4G1333C9 G	4096MB(Kit of 2)	DS	N/A	Heat-Sink Package	9-9-9-24	1.50V	*	*
Crucial	CT12864BA1339.8FF	1024MB	SS	Micron	9FF22D9KPT	9		*	*
Crucial	CT12872BA1339.9FF	1024MB	SS	Micron	91F22D9KPT(ECC)	9		*	*
Crucial	BL12864TA1336.8SFB1	2048MB(Kit of 2)	SS	N/A	Heat-Sink Package	6-6-6-20	1.8V	*	*
Crucial	CT12864BA1339.8SFD	3072MB(Kit of 3)	SS	Micron	8XD22D9JNM	9		*	*
Crucial	CT25664BA1339.16FF	2048MB	DS	Micron	9KF27D9KPT	9		*	*
Crucial	CT25672BA1339.18FF	2048MB	DS	Micron	91F22D9KPT(ECC)	9		*	*

(continued on the next page)

DDR3-1333 MHz capability

Vendor	Part No.	Size	SS/ DS	Brand	Chip NO.	Timing DIMM (BIOS)	Voltage	DIMM Support	
								A*	B*
Crucial	BL25664BA1336.16SFB1	4096MB(Kit of 2)	DS	N/A	Heat-Sink Package	6-6-6-20	1.8V	*	*
Crucial	BL25664BA1336.16SFB1	4096MB(Kit of 2)	DS	N/A	Heat-Sink Package	6-6-6-20	1.8V	*	*
Crucial	BL25664BN1337.16FF (XMP)	6144MB(Kit of 3)	DS	N/A	Heat-Sink Package	7-7-7-24	1.65V	*	*
Crucial	CT25664BA1339.16SFD	6144MB(Kit of 3)	DS	Micron	8UD22D9JNM	9		*	
G.SKILL	F3-10600CL8D-2GBHK	1024MB	SS	G.SKILL	Heat-Sink Package			*	
G.SKILL	F3-10600CL9D-2GBPK	1024MB	SS	G.SKILL	Heat-Sink Package			*	
G.SKILL	F3-10666CL7T-3GBPK	3072MB(Kit of 3)	SS	N/A	Heat-Sink Package	7-7-7-18	1.5~1.6V	*	*
G.SKILL	F3-10666CL9T-6GBNQ	3072MB(Kit of 3)	SS	N/A	Heat-Sink Package	9-9-9-24	1.5~1.6V	*	*
G.SKILL	F3-10600CL7D-2GBPI	1024MB	DS	G.SKILL	Heat-Sink Package			*	*
G.SKILL	F3-10600CL9D-2GBNQ	1024MB	DS	G.SKILL	Heat-Sink Package			*	
G.SkILL	F3-10666CL8D-4GBHK	4096MB(Kit of 2)	DS	N/A	Heat-Sink Package	8-8-8-21	1.5-1.6V	*	*
G.SKILL	F3-10666CL7T-6GBPK	6144MB(Kit of 3)	DS	N/A	Heat-Sink Package	7-7-7-18	1.5~1.6V	*	*
G.SKILL	F3-10666CL9T-6GBNQ	6144MB(Kit of 3)	DS	N/A	Heat-Sink Package	9-9-9-24	1.5V~1.6V	*	*
GEIL	DDR3-1333 CL9-9-9-24	1024MB	SS	N/A	Heat-Sink Package	9		*	*
GEIL	GV34GB1333C7DC	2048MB	DS	N/A	Heat-Sink Package	7-7-7-24	1.5V	*	*
GEIL	GG34GB1333C9DC	4096MB(Kit of 2)	DS	GEIL	GL1L128M88BA12N	9-9-9-24	1.3V(low voltage)	*	*
GEIL	DDR3-1333 CL9-9-9-24	6144MB(Kit of 3)	DS	N/A	Heat-Sink Package	9	1.5V	*	*
Kingmax	FLFD45F-B8MH9 MAES	1024MB	SS	Micron	9CF22D9KPT			*	*
Kingmax	FLFE85F-B8MF9	2048MB	DS	Micron	8HD22D9JNM			*	*
Kingmax	FLFE85F-B8MH9 MEES	2048MB	DS	Micron	9GF27D9KPT			*	*
Kingston	KVR1333D3N9/1G	1024MB	SS	Hynix	H5TQ1G83BFR	9	1.5V	*	*
Kingston	KVR1333D3N9/2G	2048MB	DS	Qimonda	IDSH1G-03A1F1C-13H		1.5V	*	*
Micron	MT8JTF12864AY-1G4D1	1024MB	SS	Micron	8LD22D9JNM			*	*
Micron	MT8JTF12864AZ-1G4F1	1024MB	SS	Micron	9FF22D9KPT	9		*	*
Micron	MT9JSF 12872AZ-1G4F1	1024MB	SS	Micron	91F22D9KPT(ECC)	9		*	*
Micron	MT8JTF12864AY-1G4D1	3072MB(Kit of 3)	SS	Micron	8XD22D9JNM	9		*	*
Micron	MT12JSF25672AZ-1G4F1	2048MB	DS	Micron	91F22D9KPT(ECC)	9		*	*
Micron	MT16JTF25664AY-1G1D1	2048MB	DS	Micron	8LD22 D9JNM			*	*
Micron	MT16JTF25664AZ-1G4F1	2048MB	DS	Micron	9KF27D9KPT	9		*	*
Micron	MT16JTF25664AY-1G4D1	6144MB(Kit of 3)	DS	Micron	8UD22D9JNM	9		*	*
OCZ	OCZ3X1333LV3GK(XMP)	3072MB(Kit of 3)	SS	N/A	Heat-Sink Package		1.6V	*	*
OCZ	OCZ3G133334GK	4096MB(Kit of 2)	DS	N/A	Heat-Sink Package		1.7V	*	*
OCZ	OCZ3P13334GK	4096MB(Kit of 2)	DS	N/A	Heat-Sink Package	7-7-7-20	1.8V	*	*
OCZ	OCZ3G1333LV6GK	6144MB(Kit of 3)	DS	N/A	Heat-Sink Package	9-9-9-20	1.65V	*	*
OCZ	OCZ3P1333LV6GK	6144MB(Kit of 3)	DS	N/A	Heat-Sink Package	7-7-7-20	1.65V	*	*
OCZ	OCZ3X1333LV6GK(XMP)	6144MB(Kit of 3)	DS	N/A	Heat-Sink Package	8-8-8-20	1.60V	*	*
SAMSUNG	M378B2873DZ1-CH9	1024MB	SS	Samsung	K4B1G0846D-HCH9			*	*
SAMSUNG	M378B2873DZ1-CH9	1024MB	SS	Samsung	SEC 846 HCH9 K4B1G0846D			*	*
SAMSUNG	M378B2873EH1-CH9	1024MB	SS	Samsung	SEC 913 HCH9 K4B1G0846E			*	*
SAMSUNG	M391B2873DZ1-CH9	1024MB	SS	Samsung	K4B1G0846D-HCH9(ECC)			*	*
SAMSUNG	M378B5673DZ1-CH9	2048MB	DS	Samsung	K4B1G0846D-HCH9			*	*
SAMSUNG	M378B5673EH1-CH9	2048MB	DS	Samsung	SEC 913 HCH9 K4B1G0846E			*	*
SAMSUNG	M391B5673DZ1-CH9	2048MB	DS	Samsung	K4B1G0846D-HCH9(ECC)			*	*
Super Talent	W1333X2GB8	1024MB	SS	N/A	Heat-Sink Package			*	*
Transcend	TS128MLK64V3U	1024MB	SS	N/A	SEC 813HCH9 K4B1G0846D			*	*
Transcend	TS128MLK72V3U	1024MB	SS	N/A	K4B1G0846D(ECC)			*	*
Transcend	TS256MLK64V3U	2048MB	DS	Micron	9GF27D9KPT			*	*

continued on the next page

DDR3-1333 MHz capability

Vendor	Part No.	Size	SS/ DS	Brand	Chip NO.	Timing DIMM (BIOS)	Voltage	DIMM Support	
								A*	B*
Transcend	TS256MLK64V3U	2048MB	DS	N/A	SEC816HCH9K4B1G0846D			•	•
Samsung	M378B1G73AH0-CH9	8GB	DS	Samsung	K4B4G0846A-HCH9	-	-	•	•
Transcend	8G DDR3 1333 DIMM CL9	8GB	DS	Transcend	E207X8BO643Y	-	-	•	•
Transcend	8G DDR3 1333 DIMM CL9	8GB	DS	-	N/A	-	-	•	•
ASint	SLB304G08-EDJ1B	8GB	DS	Asint	SLB304G08-DJ1B	-	-	•	•
HMD	HMDD308GU648D1B9C-MEX	8GB	DS	FFCT	512X8DDR3 WT	-	-	•	•
PATRIOT	PG38G1333EL(XMP)	8GB	DS	-	-	9-9-9-24	1.5V	•	•

DDR3-1066 MHz capability

Vendor	Part No.	Size	SS/ DS	Brand	Chip NO.	Timing DIMM (BIOS)	Voltage	DIMM Support	
								A*	B*
Crucial	CT12864BA1067.8FF	1024MB	SS	Micron	9GF22D9KPT	7		•	•
Crucial	CT12872BA1067.9FF	1024MB	SS	Micron	9HF22D9KPT(ECC)	7		•	•
Crucial	CT25664BA1067.16FF	2048MB	DS	Micron	9HF22D9KPT	7		•	•
Crucial	CT25672BA1067.18FF	2048MB	DS	Micron	9GF22D9KPT(ECC)	7		•	•
Elpida	EBJ51UD8BAFA-AC-E	512MB	SS	Elpida	J5308BASE-AC-E			•	•
Elpida	EBJ51UD8BAFA-AE-E	512MB	SS	Elpida	J5308BASE-AC-E			•	•
Kingston	KVR1066D3N7/1G	1024MB	SS	Kingston	D128BJEKAPGA7U	7	1.5V	•	•
Kingston	KVR1066D3N7/2G	2048MB	DS	Kingston	D128BJEKAPGA7U	7	1.5V	•	•
Micron	MT8JTF12864AY-1G1D1	1024MB	SS	Micron	8ED22D9JNL			•	•
Micron	MT8JTF12864AZ-1G1F1	1024MB	SS	Micron	9GF22D9KPT	7		•	•
Micron	MT9JSF12872AZ-1G1F1	1024MB	SS	Micron	9HF22D9KPT(ECC)	7		•	•
Micron	MT16JTF25664AY-1G1D1	2048MB	DS	Micron	8LD22D9JNL			•	•
Micron	MT16JTF25664AZ-1G1F1	2048MB	DS	Micron	9HF22D9KPT	7		•	•
Micron	MT18JSF25672AZ-1G1F1	2048MB	DS	Micron	9GF22D9KPT(ECC)	7		•	•
OCZ	OCZ3SOE10662GK	2048MB(Kit of 2)	DS	N/A	Heat-Sink Package	7-7-7-16	1.75V	•	•
SAMSUNG	M378B2873EH1-CF8	1024MB	SS	Samsung	SEC 901 HCF8 K4B1G0846E			•	•
SAMSUNG	M378B5273BH1-CF8	4096MB	DS	Samsung	846 K4B2G0846B-HCF8			•	•



- AMD® FX™ Series CPU on this motherboard supports up to DDR3 1866MHz as its standard memory frequency.
- Due to CPU spec., AMD® 100 and 200 series CPUs support up to DDR3 1066MHz. With ASUS design, this motherboard can support up to DDR3 1333MHz.
- When overclocking, some AMD CPU models may not support DDR3 1600 MHz or higher frequency DIMMs.



SS: Single-sided / DS: Double-sided

DIMM support:

- **A*:** Supports one module inserted into either slot as single-channel memory configuration.
- **B*:** Supports one pair of modules inserted into both the blue slots as one pair of dual-channel memory configuration.



Visit the ASUS website at www.asus.com for the latest QVL.

1.7.3 Installing a DIMM



Unplug the power supply before adding or removing DIMMs or other system components. Failure to do so can cause severe damage to both the motherboard and the components.

1. Press the retaining clips outward to unlock a DIMM socket.
2. Align a DIMM on the socket such that the notch on the DIMM matches the DIMM slot key on the socket.

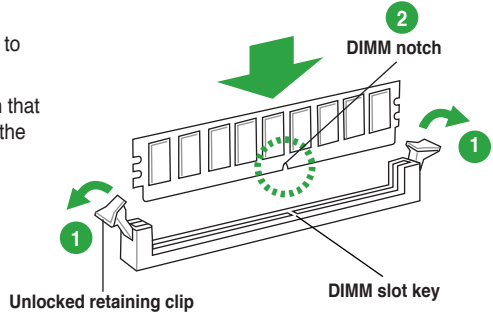

A DIMM is keyed with a notch so that it fits in only one direction. DO NOT force a DIMM into a socket in the wrong direction to avoid damaging the DIMM.

3. Firmly insert the DIMM into the socket until the retaining clips snap back in place and the DIMM is properly seated.

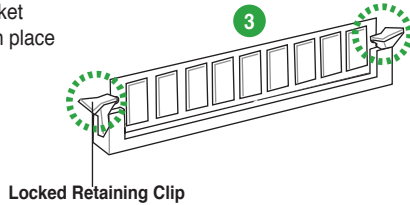

1.7.4 Removing a DIMM

To remove a DIMM:

1. Simultaneously press the retaining clips outward to unlock the DIMM.



Support the DIMM lightly with your fingers when pressing the retaining clips. The DIMM might get damaged when it flips out with extra force.

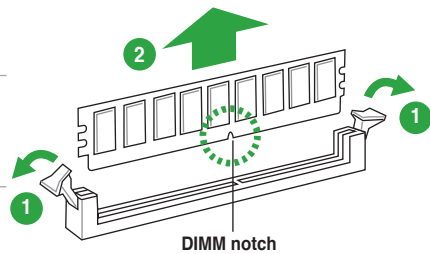

2. Remove the DIMM from the socket.

1.8 Expansion slots

In the future, you may need to install expansion cards. The following sub-sections describe the slots and the expansion cards that they support.



Unplug the power cord before adding or removing expansion cards. Failure to do so may cause you physical injury and damage motherboard components.

1.8.1 Installing an expansion card

To install an expansion card:

1. Before installing the expansion card, read the documentation that came with it and make the necessary hardware settings for the card.
2. Remove the system unit cover (if your motherboard is already installed in a chassis).
3. Remove the bracket opposite the slot that you intend to use. Keep the screw for later use.
4. Align the card connector with the slot and press firmly until the card is completely seated on the slot.
5. Secure the card to the chassis with the screw you removed earlier.
6. Replace the system cover.

1.8.2 Configuring an expansion card

After installing the expansion card, configure it by adjusting the software settings.

1. Turn on the system and change the necessary BIOS settings, if any. See Chapter 2 for information on BIOS setup.
2. Assign an IRQ to the card.
3. Install the software drivers for the expansion card.



When using PCI cards on shared slots, ensure that the drivers support “Share IRQ” or that the cards do not need IRQ assignments. Otherwise, conflicts will arise between the two PCI groups, making the system unstable and the card inoperable.

1.8.3 PCI slots

The PCI slots support cards such as a LAN card, SCSI card, USB card, and other cards that comply with PCI specifications.

1.8.4 PCI Express x1 slot

This motherboard supports PCI Express x1 network cards, SCSI cards, and other cards that comply with the PCI Express specifications.

1.8.5 PCI Express x16 slot

This motherboard supports a PCI Express x16 graphics card that comply with the PCI Express specifications.

1.9 Jumpers

1. Clear RTC RAM (CLRRTC)

This jumper allows you to clear the Real Time Clock (RTC) RAM in CMOS. You can clear the CMOS memory of date, time, and system setup parameters by erasing the CMOS RTC RAM data. The onboard button cell battery powers the RAM data in CMOS, which include system setup information such as system passwords.

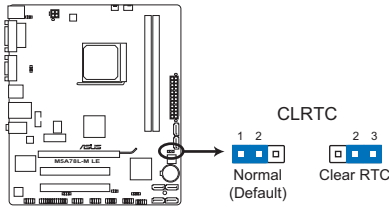

M5A78L-M LE Clear RTC RAM

To erase the RTC RAM:

1. Turn OFF the computer and unplug the power cord.
2. Move the jumper cap from pins 1-2 (default) to pins 2-3. Keep the cap on pins 2-3 for about 5~10 seconds, then move the cap back to pins 1-2.
3. Plug the power cord and turn ON the computer.
4. Hold down the key during the boot process and enter BIOS setup to reenter data.



Except when clearing the RTC RAM, never remove the cap on CLRRTC jumper default position. Removing the cap will cause system boot failure!



- If the steps above do not help, remove the onboard battery and move the jumper again to clear the CMOS RTC RAM data. After clearing the CMOS, reinstall the battery.
 - You do not need to clear the RTC when the system hangs due to overclocking. For system failure due to overclocking, use the CPU Parameter Recall (C.P.R) feature. Shut down and reboot the system so the BIOS can automatically reset parameter settings to default values.
-

2. USB device wake-up (3-pin USBPW1-4, USBPW5-12)

Set these jumpers to +5V to wake up the computer from S1 sleep mode (CPU stopped, DRAM refreshed, system running in low power mode) using the connected USB devices. Set these jumpers to +5VSB to wake up the computer from S3 and S4 sleep modes (no power to CPU, DRAM in slow refresh, power supply in reduced power mode).

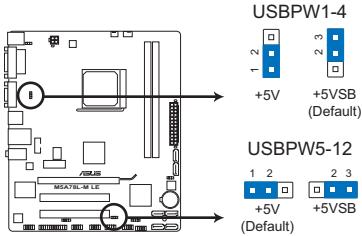

M5A78L-M LE USB device wake-up

3. Keyboard power (3-pin KBPWR)

This jumper allows you to enable or disable the keyboard wake-up feature. When you set this jumper to pins 2-3 (+5VSB), you can wake up the computer by pressing a key on the keyboard. This feature requires an ATX power supply that can supply at least 1A on the +5VSB lead, and a corresponding setting in the BIOS.

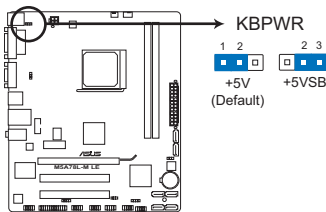

M5A78L-M LE Keyboard power setting

1.10 Connectors

1.10.1 Rear panel ports

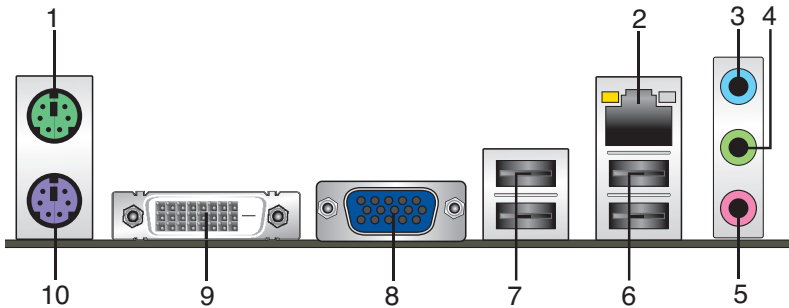

1. **PS/2 Mouse port (green).** This port is for a PS/2 mouse.
2. **LAN (RJ-45) port.** This port allows Gigabit connection to a Local Area Network (LAN) through a network hub.

LAN port LED indications

Activity/Link LED		Speed LED	
Status	Description	Status	Description
OFF	No link	OFF	10Mbps connection
ORANGE	Linked	ORANGE	100Mbps connection
BLINKING	Data activity	GREEN	1Gbps connection

ACT/LINK SPEED
LED LED



LAN port

3. **Line In port (light blue).** This port connects to the tape, CD, DVD player, or other audio sources.
4. **Line Out port (lime).** This port connects to a headphone or a speaker. In the 4, 6, and 8-channel configurations, the function of this port becomes Front Speaker Out.
5. **Microphone port (pink).** This port connects to a microphone.



Refer to the audio configuration table below for the function of the audio ports in 2, 4, 6, or 8-channel configuration.

Audio 2, 4, 6, or 8-channel configuration

Port	Headset 2-channel	4-channel	6-channel	8-channel
Light Blue (Rear panel)	Line In	Rear Speaker Out	Rear Speaker Out	Rear Speaker Out
Lime (Rear panel)	Line Out	Front Speaker Out	Front Speaker Out	Front Speaker Out
Pink (Rear panel)	Mic In	Mic In	Bass/Center	Bass/Center
Lime (Front panel)	–	–	–	Side Speaker Out



To configure an 8-channel audio output:

Use a chassis with HD audio module in the front panel to support 8-channel audio output.

6. **USB 2.0 ports 1 and 2.** These two 4-pin Universal Serial Bus (USB) ports connect to USB 2.0 devices.
7. **USB 2.0 ports 3 and 4.** These two 4-pin Universal Serial Bus (USB) ports connect to USB 2.0 devices.
8. **Video Graphics Adapter (VGA) port.** This 15-pin port is for a VGA monitor or other VGA-compatible devices.
9. **DVI port.** This port is for any DVI-D compatible device. DVI-D can't be converted to output RGB Signal to CRT and isn't compatible with DVI-I.
10. **PS/2 Keyboard port (purple).** This port is for a PS/2 keyboard.

1.10.2 Internal connectors

1. Front panel audio connector (10-1 pin AAFP)

This connector is for a chassis-mounted front panel audio I/O module that supports either High Definition Audio or AC'97 audio standard. Connect one end of the front panel audio I/O module cable to this connector.

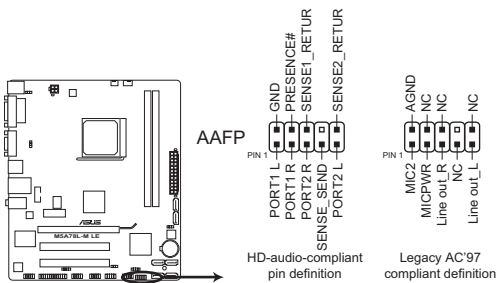

M5A78L-M LE Front panel audio connector



- We recommend that you connect a high-definition front panel audio module to this connector to avail of the motherboard high-definition audio capability.
- If you want to connect a high definition front panel audio module to this connector, set the **Front Panel Select** item in the BIOS to **[HD Audio]**. See section 2.4.4 **Onboard Devices Configuration** for details.
- The front panel audio I/O module is purchased separately.

2. ATX power connectors (24-pin EATXPWR, 4-pin ATX12V)

These connectors are for an ATX power supply. The plugs from the power supply are designed to fit these connectors in only one orientation. Find the proper orientation and push down firmly until the connectors completely fit.

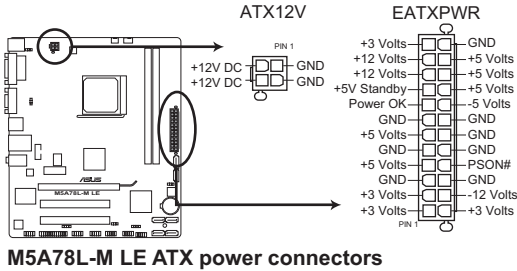

M5A78L-M LE ATX power connectors



- We recommend that you use an ATX 12V Specification 2.0-compliant power supply unit (PSU) with a minimum of 300W power rating. This PSU type has 24-pin and 4-pin power plugs.
- If you intend to use a PSU with 20-pin and 4-pin power plugs, ensure that the 20-pin power plug can provide at least 15 A on +12 V and that the PSU has a minimum power rating of 300W. The system may become unstable or may not boot up if the power is inadequate.
- DO NOT forget to connect the 4-pin ATX12V power plug. Otherwise, the system will not boot up.
- We recommend that you use a PSU with higher power output when configuring a system with more power-consuming devices or when you intend to install additional devices. The system may become unstable or may not boot up if the power is inadequate.
- If you are uncertain about the minimum power supply requirement for your system, refer to the Recommended Power Supply Wattage Calculator at <http://support.asus.com/PowerSupplyCalculator/PSCalculator.aspx?SLanguage=en-us> for details.

3. Serial port connector (10-1 pin COM1)

The connector is for a serial (COM) port. Connect the serial port module cable to the connector, then install the module to a slot opening at the back of the system chassis.



The serial port bracket is purchased separately.

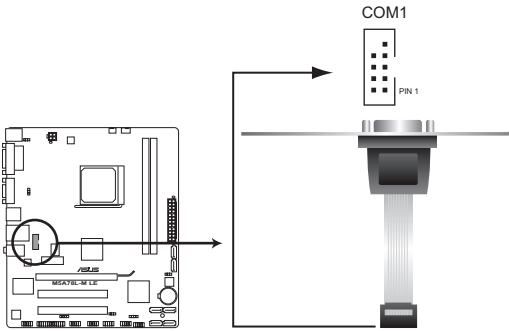

M5A78L-M LE Serial port (COM1) connector

4. LPT connector (26-1 pin LPT)

The LPT (Line Printing Terminal) connector supports devices such as a printer. LPT standardizes as IEEE 1284, which is the parallel port interface on IBM PC-compatible computers.

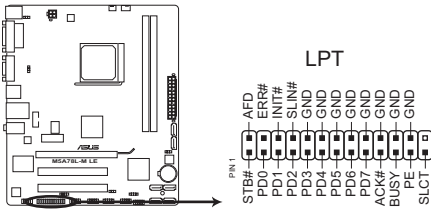

M5A78L-M LE LPT connector

6. System panel connector (10-1 pin PANEL)

This connector supports several chassis-mounted functions.

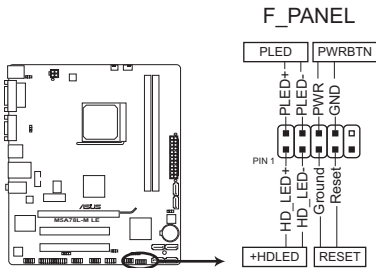

M5A78L-M LE System panel connector

- **System power LED (2-pin PLED)**

This 2-pin connector is for the system power LED. Connect the chassis power LED cable to this connector. The system power LED lights up when you turn on the system power, and blinks when the system is in sleep mode.

- **Hard disk drive activity LED (2-pin +HDLED)**

This 2-pin connector is for the HDD Activity LED. Connect the HDD Activity LED cable to this connector. The IDE LED lights up or flashes when data is read from or written to the HDD.

- **ATX power button/soft-off button (2-pin PWRBTN)**

This connector is for the system power button.

- **Reset button (2-pin RESET)**

This 2-pin connector is for the chassis-mounted reset button for system reboot without turning off the system power.

7. Speaker connector (4-pin SPEAKER)

The 4-pin connector is for the chassis-mounted system warning speaker. The speaker allows you to hear system beeps and warnings.

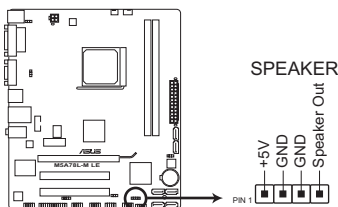

M5A78L-M LE Speaker connector

8. USB connectors (10-1 pin USB56, USB78, USB910, USB1112)

These connectors are for USB 2.0 ports. Connect the USB module cable to any of these connectors, then install the module to a slot opening at the back of the system chassis. These USB connectors comply with USB 2.0 specification that supports up to 480Mbps connection speed.

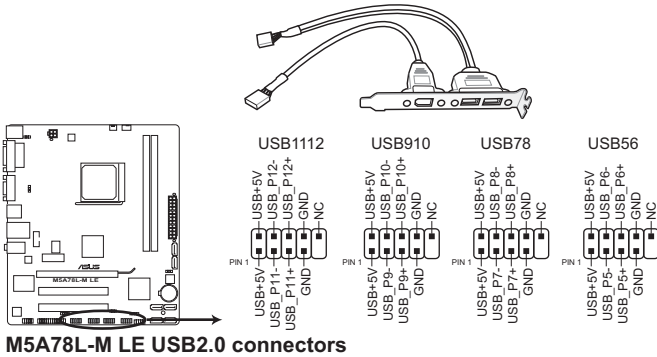

Never connect a 1394 cable to the USB connectors. Doing so will damage the motherboard!



The USB 2.0 module is purchased separately.

9. Digital audio connector (4-1 pin SPDIF_OUT)

This connector is for an additional Sony/Philips Digital Interface (S/PDIF) port.

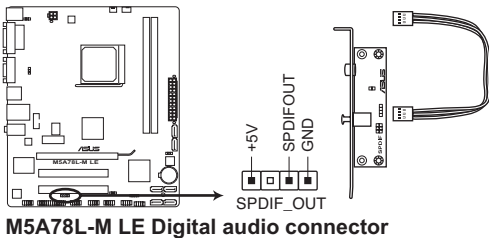

Ensure that the audio device of Sound playback is **Realtek High Definition Audio** (the name may be different based on the OS). Go to **Start > Control Panel > Sounds and Audio Devices > Sound Playback** to configure the setting.



The S/PDIF module is purchased separately.

10. CPU and chassis fan connectors (4-pin CPU_FAN and 3-pin CHA_FAN)

Connect the fan cables to the fan connectors on the motherboard, ensuring that the black wire of each cable matches the ground pin of the connector.

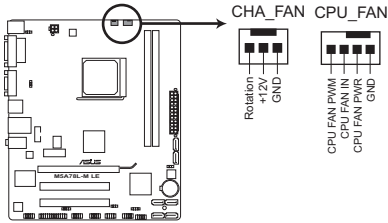

M5A78L-M LE Fan connectors



DO NOT forget to connect the fan cables to the fan connectors. Insufficient air flow inside the system may damage the motherboard components. These are not jumpers! DO NOT place jumper caps on the fan connectors.



Only the 4-pin CPU fan supports the ASUS Q-Fan feature.

1.11 Software support

1.11.1 Installing an operating system

This motherboard supports Windows® XP / Vista / 7 Operating Systems (OS). Always install the latest OS version and corresponding updates to maximize the features of your hardware.



- Motherboard settings and hardware options vary. Refer to your OS documentation for detailed information.
- Ensure that you install Windows® XP Service Pack 3 or later versions / Windows® Vista Service Pack 1 or later versions before installing the drivers for better compatibility and system stability.

1.11.2 Support DVD information

The Support DVD that comes with the motherboard package contains the drivers, software applications, and utilities that you can install to avail all motherboard features.



The contents of the Support DVD are subject to change at any time without notice. Visit the ASUS website at www.asus.com for updates.

To run the Support DVD

Place the Support DVD into the optical drive. If Autorun is enabled in your computer, the DVD automatically displays the Specials screen. Click Drivers, Utilities, Make Disk, Manual, and Contact tabs to display their respective menus.



The following screen is for reference only.



Click an icon to display Support DVD/ motherboard information

Click an item to install



If Autorun is NOT enabled on your computer, browse the contents of the Support DVD to locate the file ASSETUP.EXE from the BIN folder. Double-click the ASSETUP.EXE to run the DVD.

Chapter 2

BIOS information

2.1 Managing and updating your BIOS



Save a copy of the original motherboard BIOS file to a USB flash disk in case you need to restore the BIOS in the future. Copy the original motherboard BIOS using the ASUS Update utility.

2.1.1 ASUS Update

The ASUS Update is a utility that allows you to manage, save, and update the motherboard BIOS in Windows® environment.



-
- ASUS Update requires an Internet connection either through a network or an Internet Service Provider (ISP).
 - This utility is available in the support DVD that comes with the motherboard package.
-

Installing ASUS Update

To install ASUS Update:

1. Place the support DVD into the optical drive. The **Drivers** menu appears.
2. Click the **Utilities** tab, then click **ASUS Update**.
3. Follow the onscreen instructions to complete the installation.



Quit all Windows® applications before you update the BIOS using this utility.

Updating the BIOS

To update the BIOS:

1. From the Windows® desktop, click **Start > Programs > ASUS > ASUS Update > ASUS Update** to launch the ASUS Update utility.
2. From the dropdown list, select either of the following methods:

Updating from the Internet

- a. Select **Update BIOS from the Internet**, then click **Next**.
- b. Select the ASUS FTP site nearest you to avoid network traffic, or click **Auto Select** then click **Next**.
- c. From the FTP site, select the BIOS version that you want to download then click **Next**.



The ASUS Update utility is capable of updating itself through the Internet. Always update the utility to avail all its features.

Updating from a BIOS file

- a. Select **Update BIOS from a file**, then click **Next**.
 - b. Locate the BIOS file from the **Open** window, then click **Open**.
3. Follow the onscreen instructions to complete the updating process.

2.1.2 ASUS EZ Flash 2

The ASUS EZ Flash 2 feature allows you to update the BIOS without using an OS-based utility.



Before you start using this utility, download the latest BIOS file from the ASUS website at www.asus.com.

To update the BIOS using EZ Flash 2:

1. Insert the USB flash disk that contains the latest BIOS file to the USB port, then launch EZ Flash 2 in either of these two ways:
 - Press **<Alt> + <F2>** during POST.
 - Enter the BIOS setup program. Go to the **Tools** menu to select **EZ Flash 2** and press **<Enter>** to enable it.Press **<Tab>** to switch between drives until the correct BIOS file is found.

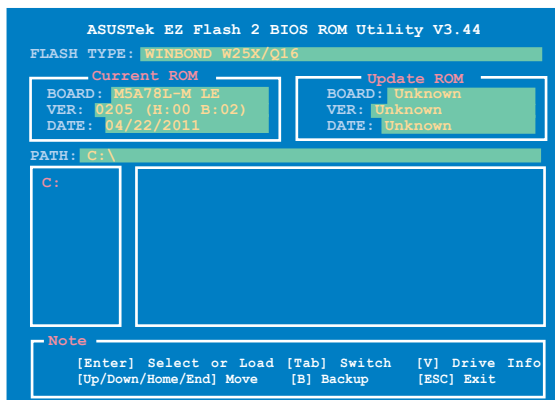

2. When the correct BIOS file is found, EZ Flash 2 performs the BIOS update process and automatically reboots the system when done.



-
- This function supports USB flash disks with **FAT 32/16** format and single partition only.
 - DO NOT shut down or reset the system while updating the BIOS to prevent system boot failure!
-

2.1.3 ASUS CrashFree BIOS 3

ASUS CrashFree BIOS 3 is an auto recovery tool that allows you to restore the BIOS file when it fails or gets corrupted during the updating process. You can restore a corrupted BIOS file using the motherboard support DVD or a USB flash drive that contains the BIOS file.



-
- Before using this utility, rename the BIOS file in the USB flash drive into **MA78LMPL.ROM** (for **M5A78L-M PLUS**) or **MA78LMLE.ROM** (for **M5A78L-M LE**).
 - Download the latest BIOS file from the ASUS website at www.asus.com.
-

Recovering the BIOS

To recover the BIOS:

1. Turn on the system.
2. Insert the support DVD to the optical drive or the removable device that contains the BIOS file to the USB port or to the floppy disk drive, if supported.
3. The utility automatically checks the devices for the BIOS file. When found, the utility reads the BIOS file and starts flashing the corrupted BIOS file.
4. Turn off the system after the utility completes the updating process and turn on again.



DO NOT shut down or reset the system while updating the BIOS! Doing so can cause system boot failure!



Ensure to load the BIOS default settings to ensure system compatibility and stability. Select the **Load Setup Defaults** item under the Exit menu. Refer to section **2.8 Exit menu** for details.

2.2 BIOS setup program

Use the BIOS Setup program to update the BIOS or configure its parameters. The BIOS screens include navigation keys and brief online help to guide you in using the BIOS Setup program.

Entering BIOS Setup at startup

To enter BIOS Setup at startup:

- Press **<Delete>** during the Power-On Self-Test (POST). If you do not press **<Delete>**, POST continues with its routines.

Entering BIOS Setup after POST

To enter BIOS Setup after POST:

- Press **<Ctrl>+<Alt>+<Delete>** simultaneously.
- Press the reset button on the system chassis.
- Press the power button to turn the system off then back on. Do this option only if you failed to enter BIOS Setup using the first two options.



Using the **power button**, **reset button**, or the **<Ctrl>+<Alt>+** keys to force reset from a running operating system can cause damage to your data or system. We recommend that you always shut down the system properly from the operating system.



- The default BIOS settings for this motherboard apply to most conditions to ensure optimum performance. If the system becomes unstable after changing any BIOS settings, load the default settings to ensure system compatibility and stability. Select the **Load Setup Defaults** item under the **Exit** menu. See section **2.8 Exit Menu**.
 - The BIOS setup screens in this chapter are for reference only. They may not exactly match what you see on your screen.
 - Visit the ASUS website at www.asus.com to download the latest BIOS file for this motherboard.
-

2.2.1 BIOS menu screen

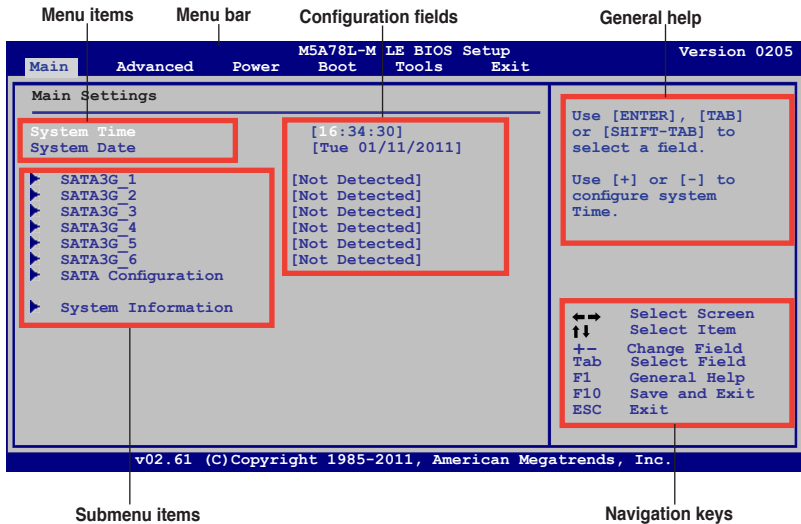

2.2.2 Menu bar

The menu bar on top of the screen has the following main items:

- Main** For changing the basic system configuration
- Advanced** For changing the advanced system settings
- Power** For changing the advanced power management (APM) configuration
- Boot** For changing the system boot configuration
- Tools** For configuring options for special functions
- Exit** For selecting the exit options and loading default settings.

To select an item on the menu bar, press the right or left arrow key on the keyboard until the desired item is highlighted.

2.2.3 Navigation keys

At the bottom right corner of a menu screen are the navigation keys for that particular menu. Use the navigation keys to select items in the menu and change the settings.



Some of the navigation keys differ from one screen to another.

2.2.4 Menu items

The highlighted item on the menu bar displays the specific items for that menu. For example, selecting Main shows the Main menu items.

The other items (Advanced, Power, Boot, Tools, and Exit) on the menu bar have their respective menu items.

2.2.5 Submenu items

A solid triangle before each item on a menu screen means that the item has a submenu. To display the submenu, select the item and press **<Enter>**.

2.2.6 Configuration fields

These fields show the values for the menu items. If an item is user-configurable, you can change the value of the field opposite the item. You cannot select an item that is not user-configurable.

A configurable field is enclosed in brackets, and is highlighted when selected. To change the value of a field, select it then press **<Enter>** to display a list of options. Refer to **2.2.7 Pop-up window**.

2.2.7 Pop-up window

Select a menu item then press **<Enter>** to display a pop-up window with the configuration options for that item.

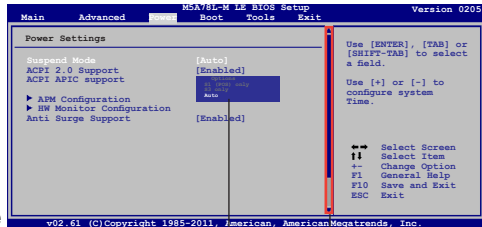

Pop-up window

Scroll bar

2.2.8 Scroll bar

A scroll bar appears on the right side of a menu screen when there are items that do not fit on the screen. Press the **<Up>** / **<Down>** arrow keys or **<Page Up>** / **<Page Down>** keys to display the other items on the screen.

2.2.9 General help

At the top right corner of the menu screen is a brief description of the selected item.

2.3 Main menu

When you enter the BIOS Setup program, the Main menu screen appears, giving you an overview of the basic system information.



Refer to section 2.2.1 **BIOS menu screen** for information on the menu screen items and how to navigate through them.

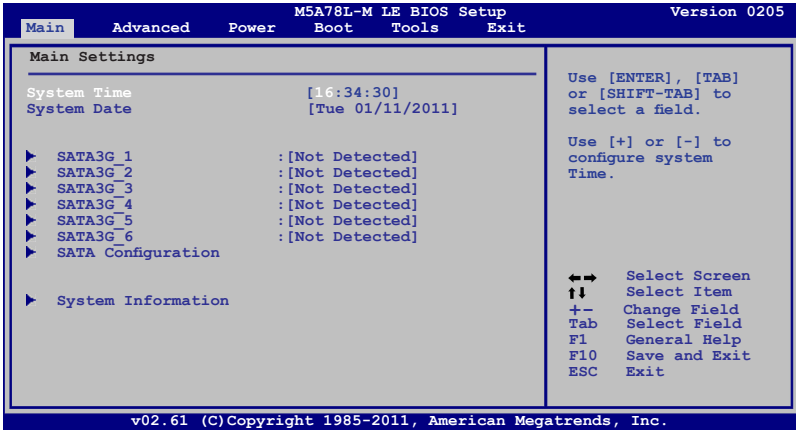

2.3.1 System Time [xx:xx:xx]

Allows you to set the system time.

2.3.2 System Date [Day xx/xx/xxxx]

Allows you to set the system date.

2.3.3 SATA3G_1/2/3/4/5/6

While entering Setup, the BIOS automatically detects the presence of SATA devices. There is a separate submenu for each SATA device. Select a device item then press **<Enter>** to display the SATA device information.

The BIOS automatically detects the values opposite the dimmed items (Device, Vendor, Size, LBA Mode, Block Mode, PIO Mode, Async DMA, Ultra DMA, and SMART monitoring). These values are not user-configurable. These items show Not Detected if no SATA device is installed in the system.

Type [Auto]

Selects the type of SATA drive. Setting this item to **[Auto]** allows automatic selection of the appropriate SATA device type. Select **[CDROM]** if you are specifically configuring a CD-ROM drive. Select **[ARMD]** (ATAPI Removable Media Device) if your device is either a ZIP, LS-120, or MO drive. Configuration options: [Not Installed] [Auto] [CDROM] [ARMD]



This item only appears in the **SATA3G_5/6** menus.

LBA/Large Mode [Auto]

Enables or disables the LBA mode. Setting this item to **[Auto]** enables the LBA mode if the device supports this mode, and if the device was not previously formatted with LBA mode disabled. Configuration options: [Disabled] [Auto]

Block (Multi-Sector Transfer) Mode [Auto]

Enables or disables data multi-sectors transfers. When this item is set to **[Auto]**, the data transfer from and to the device occurs multiple sectors at a time if the device supports multi-sector transfer feature. When this item is set to **[Disabled]**, the data transfer from and to the device occurs one sector at a time. Configuration options: [Disabled] [Auto]

PIO Mode [Auto]

Selects the PIO mode. Configuration options: [Auto] [0] [1] [2] [3] [4]

DMA Mode [Auto]

Selects the DMA mode. Configuration options: [Auto]

SMART Monitoring [Auto]

Sets the Smart Monitoring, Analysis, and Reporting Technology.

Configuration options: [Auto] [Disabled] [Enabled]

32Bit Data Transfer [Enabled]

Enables or disables 32-bit data transfer. Configuration options: [Disabled] [Enabled]

2.3.4 SATA Configuration

The **SATA Configuration** menu allows you to configure your storage devices. Select an item then press **<Enter>** to display the submenu.

OnChip SATA Channel [Enabled]

Enables or disables onboard channel SATA port. Configuration options: [Disabled] [Enabled]



The following two items only appear when you set **OnChip SATA Channel** to **[Enabled]**.

SATA Port1 - Port4 [IDE]

Allows you to set the SATA configuration.

- | | |
|--------|--|
| [IDE] | Set to [IDE] when you want to use the Serial ATA hard disk drives as Parallel ATA physical storage devices. |
| [RAID] | Set to [RAID] when you want to create a RAID configuration from the SATA hard disk drives. |
| [AHCI] | Set to [AHCI] when you want the SATA hard disk drives to use the AHCI (Advanced Host Controller Interface). The AHCI allows the onboard storage driver to enable advanced Serial ATA features that increases storage performance on random workloads by allowing the drive to internally optimize the order of commands. |



-
- When this item is set to [AHCI], the information of the SATA connectors 1–6 can be seen only under the OS environment or during POST.
 - For Windows® XP OS, you have to install the AHCI driver, so that you could use the SATA connectors 1–6 in AHCI mode under the OS environment.
-

SATA Port5 - Port6 [IDE]

Setting this item to [IDE] instead of [RAID] or [AHCI] allows the system to recognize the optical drives connected to the SATA connectors 5 or 6 when installing OS.



If you use a SATA optical drive to run the OS installation disk, we strongly recommend that you install the optical drive to the SATA connectors 5/6 and set them to [IDE] mode.

2.3.5 System Information

This menu gives you an overview of the general system specifications. The BIOS automatically detects the items in this menu.

BIOS information

Displays the auto-detected BIOS information.

Processor

Displays the auto-detected CPU specification.

System Memory

Displays the auto-detected system memory.

2.4 Advanced menu

The **Advanced** menu items allow you to change the settings for the CPU and other system devices.



Take caution when changing the settings of the Advanced menu items. Incorrect field values can cause the system to malfunction.

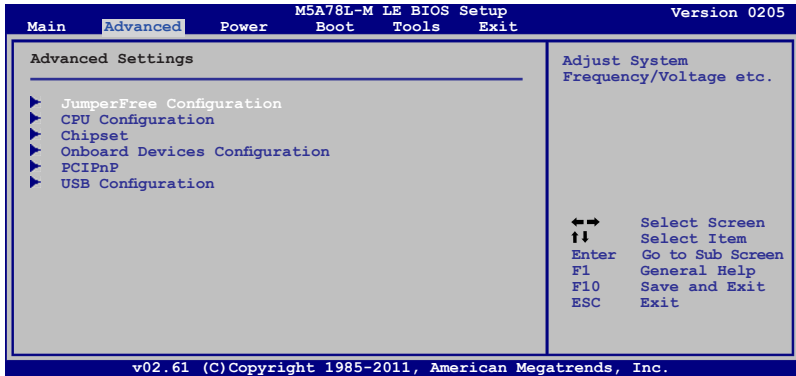

2.4.1 JumperFree Configuration



The items and configuration options in this menu may vary depending on the AMD CPU type.

CPU Overclocking [Auto]

Selects the CPU overclocking options to achieve desired CPU internal frequency. Configuration options: [Manual] [Auto] [Overclock Profile] [Test Mode]



The following item only appears when you set **CPU Overclocking** to [Manual].

CPU/HT Reference Clock (MHz) [200]

Sets the CPU/HT Reference Clock. Configuration options: [Min.=200] [Max.=550]



The following item only appears when you set **CPU Overclocking** to [Overclock Profile].

Overclock Options [Auto]

Selects the overclocking profile. Configuration options: [Auto] [Overclock 2%] [Overclock 5%] [Overclock 8%] [Overclock 10%]

GPU Overclocking [Auto]

Configures the GPU overclocking. Configuration options: [Auto] [Manual]



The following item only appears when you set **GPU Overclocking** to **[Manual]**.

GPU Engine Clock [350]

Sets the GPU Engine Clock. Configuration options: [Min.=200] [Max.=350]

PCIe Overclocking [Auto]

Configures the PCIe overclocking. Configuration options: [Auto] [Manual]



The following item only appears when you set **PCIe Overclocking** to **[Manual]**.

PCIe Clock [100]

Sets the PCIe Clock. Configuration options: [Min.=100] [Max.=150]

CPU Ratio [Auto]

Sets the CPU ratio. Configuration options: [Auto] [x4.0 800MHz] [x4.5 900MHz] [x5.0 1000MHz] [x5.5 1100MHz] ~ [x13.0 2600MHz] [x13.5 2700MHz] [x14.0 2800MHz] [x14.5 2900MHz] [x15.0 3000MHz]

CPU/NB Frequency [Auto]

Sets the CPU/Northbridge frequency. Configuration options: [Auto] [800MHz] [1000MHz] [1200MHz] [1400MHz] [1600MHz] [1800MHz] [2000MHz]

CPU Over Voltage [Auto]

Sets the CPU over voltage. The valid value ranges vary depending on your CPU model. Use <+> / <-> keys to adjust the ratio. Configuration options: [Auto]

VDDNB Over Voltage [Auto]

Sets the VDDNB over voltage. The valid value ranges vary depending on your CPU model. Use <+> / <-> keys to adjust the ratio. Configuration options: [Auto]

LoadLine Calibration [Auto]

Sets the LoadLine. Configuration options: [Auto] [Max.=100%] [Min.=0%]



If the system becomes unstable after changing the setting, set it back to **[Auto]** for safe mode.

HT Link Speed [Auto]

Sets the HyperTransport link speed. Configuration options: [Auto] [200MHz] [400MHz] [600MHz] [800MHz] [1000MHz] [1600MHz] [1800MHz] [2000MHz]

HT Over Voltage [Auto]

Sets the HT over voltage. The values range from 1.20000V to 1.38000V with a 0.01000V increment. Use the <+> / <-> keys to adjust the value. Configuration options: [Auto] [Max. = 1.38000V] [Min. = 1.20000V]

Memory Clock Mode [Auto]

Configuration options: [Auto] [Manual]



The following items only appear when you set **Memory Clock Mode** to **[Manual]**.

Memory Clock Speed [400MHz]

Selects the memory clock frequency programming method.

Configuration options: [400MHz] [533MHz] [667MHz] [800MHz]

DRAM Timing Configuration



The configuration options for some of the following items vary depending on the DIMMs you install on the motherboard.

DRAM CAS# Latency [Auto]

Configuration options: [Auto] [4 CLK] ~ [12 CLK]

DRAM RAS# to CAS# Delay [Auto]

Configuration options: [Auto] [5 CLK] ~ [12 CLK]

DRAM RAS# PRE Time [Auto]

Configuration options: [Auto] [5 CLK] ~ [12 CLK]

DRAM RAS# ACT Time [Auto]

Configuration options: [Auto] [15 CLK] ~ [30 CLK]

DRAM READ to PRE Time [Auto]

Configuration options: [Auto] [4 CLK] [5 CLK] [6 CLK] [7 CLK]

DRAM Row Cycle Time [Auto]

Configuration options: [Auto] [12 CLK] ~ [42 CLK]

DRAM WRITE Recovery Time [Auto]

Configuration options: [Auto] [5 CLK] [6 CLK] [7 CLK] [8 CLK] [10 CLK] [12 CLK]

DRAM RAS# to RAS# Delay [Auto]

Configuration options: [Auto] [4 CLK] [5 CLK] [6 CLK] [7 CLK]

DRAM READ to WRITE Delay [Auto]

Configuration options: [Auto] [3 CLK] ~ [17 CLK]

DRAM WRITE to READ Delay(DD) [Auto]

Configuration options: [Auto] [2 CLK] ~ [10 CLK]

DRAM WRITE to READ Delay(SD) [Auto]

Configuration options: [Auto] [4 CLK] [5 CLK] [6 CLK] [7 CLK]

DRAM WRITE to WRITE Timing [Auto]

Configuration options: [Auto] [2 CLK] ~ [10 CLK]

DRAM READ to READ Timing [Auto]

Configuration options: [Auto] [3 CLK] ~ [10 CLK]

DRAM REF Cycle Time [Auto]

Configuration options: [Auto] [90ns] [110ns] [160ns] [300ns] [350ns]

DRAM Refresh Rate [Auto]

Configuration options: [Auto] [Every 7.8ms] [Every 3.9ms]

DRAM Command Rate [Auto]

Configuration options: [Auto] [1T] [2T]

Memory Over Voltage [Auto]

Sets the memory over voltage. The values range from 1.3500V to 2.3000V with a 0.0100V increment. Use the <+> / <-> keys to adjust the value.

Chipset Over Voltage [Auto]

Sets the chipset over voltage. The values range from 1.10000V to 1.60000V with a 0.01000V increment. Use the <+> / <-> keys to adjust the value.

PCI/PCIe CLK Status [Enabled]

Enables or disables the clock for PCI/PCIe slots. Configuration options: [Disabled] [Enabled]

2.4.2 CPU Configuration

The items in this menu show the CPU-related information that the BIOS automatically detects.

GART Error Reporting [Disabled]

This option should remain disabled for the normal operation. The driver developer may enable it for testing purpose. Configuration options: [Disabled] [Enabled]

Microcode Update [Enabled]

Enables or disables Microcode Update. Configuration options: [Disabled] [Enabled]

Secure Virtual Machine Mode [Disabled]

Enables or disables Secure Virtual Machine Mode (SVM). Configuration options: [Disabled] [Enabled]

Cool 'n' Quiet [Enabled]

Enables or disables the AMD® Cool 'n' Quiet technology. Configuration options: [Enabled] [Disabled]

C1E Support [Disabled]

Enables or disables the CPU Enhanced Halt (C1E) function, a CPU power-saving function in system halt state. When this item is enabled, the CPU core frequency and voltage will be reduced during the system halt state to decrease power consumption.

Configuration options: [Disabled] [Enabled]

Advanced Clock Calibration [Disabled]

Adjusts the processor's overclocking capability. When this item is set to **[Auto]**, the BIOS automatically adjusts this function. When this item is set to **[All Cores]**, the processor has the best overclocking performance. When this item is set to **[Per Core]**, the processor's overclocking capability is enhanced. Configuration options: [Disabled] [Auto] [All Cores] [Per Core]



The following items only appear when you set **Advanced Clock Calibration** to **[Auto]**, **[All Cores]**, or **[Per Core]**.

Unleashing Mode [Disabled]

Enable the Unleashing Mode to get full computing power of the processor. However, this might make your system unstable depending on your processor's overclocking capability. Configuration options: [Enabled] [Disabled]

Active CPU Cores [Auto]

Allows you to manually turn ON/OFF a process core. Configuration options: [Auto] [Manual]

2nd / 3rd / 4th / 6th / 8th Core [On]

These items only appear when you set **Active CPU Cores** to **[Manual]**.

Configuration options: [On] [Off]

Value (All Cores) [-2%]

This item only appears when you set **Advanced Clock Calibration** to **[All Cores]**. It allows you to set the overclocking percentage for all the processor cores as a whole.

Configuration options: [0%] [+2%] [+4%] [+6%] [+8%] [+10%] [+12%] [-2%] [-4%] [-6%] [-8%] [-10%] [-12%]

Value (Core 0) / (Core 1) / (Core 2) / (Core 3) [-2%]

These items only appear when you set **Advanced Clock Calibration** to **[Per Core]** and allow you to set the overclocking percentage for each process core separately.

Configuration options: [0%] [+2%] [+4%] [+6%] [+8%] [+10%] [+12%] [-2%] [-4%] [-6%] [-8%] [-10%] [-12%]

2.4.3 Chipset

NorthBridge Configuration

DRAM Controller Configuration

Bank Interleaving [Auto]

Allows you to enable the bank memory interleaving. Configuration options: [Disabled] [Auto]

Node Interleaving [Disabled]

Allows you to enable the node memory interleaving. Configuration options: [Disabled] [Auto]

Channel Interleaving [Auto]

Allows you to enable the channel memory interleaving. Configuration options: [Disabled] [Auto]

Memory Hole Remapping [Enabled]

Allows you to enable or disable memory remapping around memory hole.

Configuration options: [Disabled] [Enabled]

Power Down Enable [Auto]

Allows you to enable or disable DDR power down mode.

Configuration options: [Auto] [Disabled] [Enabled]

ECC Configuration

ECC Mode [Disabled]

Enables or disables the DRAM ECC that allows the hardware to report and correct memory errors automatically. Configuration options: [Disabled] [Basic] [Good] [Super] [Max] [User]

Internal Graphics

Primary Video Controller [GFX0-GPP-IGFX-PCI]

Selects the primary display adapter. Configuration options: [GFX0-GPP-IGFX-PCI] [GPP-GFX0-IGFX-PCI] [PCI-GFX0-GPP-IGFX] [IGFX-GFX0-GPP-PCI]



GFX0: primary video controller on a PCIe x16 slot

GPP: primary video controller on a PCIe x1 slot

IGFX: onboard display output port

PCI: primary video controller on a PCI slot

UMA Frame Buffer Size [Auto]

This item appears only when the previous item is set to [Enabled]. Selects the UMA frame buffer size. Configuration options: [Auto] [32MB] [64MB] [128MB] [256MB] [512MB] [1GB]



- The **[512MB]** option only appears when you install 1GB system memory or more.
- The **[1GB]** option only appears when you install 2GB system memory or more.

Surround View [Auto]

Disables or enables the Surround View function. Configuration options: [Auto] [Disabled] [Enabled]



This item becomes user-configurable when you install an ATI graphics card into the PCIe x16 slot.

Frame Buffer Location [Above 4G]

Configuration options: [Below 4G] [Above 4G]

2.4.4 Onboard Devices Configuration

Serial Port1 Address [3F8/IRQ4]

Allows you to select the Serial Port1 base address. Configuration options: [Disabled] [3F8/IRQ4][2F8/IRQ3] [3E8/IRQ4] [2E8/IRQ3]

Parallel Port Address [378]

Allows you to select the Parallel Port base addresses. Configuration options: [Disabled] [378] [278] [3BC]

Parallel Port Mode [Normal]

Allows you to select the Parallel Port mode. Configuration options: [Normal] [EPP] [ECP] [EPP+ECP]

Parallel Port IRQ [IRQ7]

Allows BIOS to select the Parallel Port IRQ. Configuration options: [IRQ5] [IRQ7]

HDAudio Controller [Enabled]

Enables or disables the high definition audio controller. Configuration options: [Disabled] [Enabled]

Front Panel Select [HD Audio]

Allows you to set the front panel audio connector (AAFP) mode to legacy AC'97 or high-definition audio depending on the audio standard that the front panel audio module supports. Configuration options: [AC97] [HD Audio]

OnBoard LAN Controller [Enabled]

Enables or disables the onboard LAN controller. Configuration options: [Disabled] [Enabled]

OnBoard LAN Boot ROM [Disabled]

Enables or disables the onboard Gigabit LAN Boot ROM. Configuration options: [Disabled] [Enabled]

2.4.5 PCIPnP

The PCI PnP menu items allow you to change the advanced settings for PCI/PnP devices. The menu includes setting IRQ and DMA channel resources for either PCI/PnP or legacy ISA devices, and setting the memory size block for legacy ISA devices.



Take caution when changing the settings of the PCI PnP menu items. Incorrect field values can cause the system to malfunction.

Plug and Play O/S [No]

When this item is set to [No], BIOS configures all the devices in the system. When this item is set to [Yes] and if you install a Plug and Play operating system, the operating system configures the Plug and Play devices not required for boot. Configuration options: [No] [Yes]

2.4.6 USB Configuration

The items in this menu allows you to change the USB-related features. Select an item then press <Enter> to display the configuration options.



The Module Version and USB Devices Enabled items show the auto-detected values. If no USB device is detected, the item shows **None**.

USB Functions [Enabled]

Allows you to enable or disable the USB functions. Configuration options: [Disabled] [Enabled]

USB 2.0 Controller [Enabled]

Enables or disables USB 2.0 Controllers. Configuration options: [Disabled] [Enabled]

Legacy USB Support [Auto]

Allows you to enable or disable support for Legacy USB storage devices, including USB flash drives and USB hard drives. Setting to Auto allows the system to detect the presence of USB devices at startup. If detected, the USB controller legacy mode is enabled. If no USB device is detected, the legacy USB support is disabled. Configuration options: [Disabled] [Enabled] [Auto]

USB 2.0 Controller Mode [HiSpeed]

Allows you to configure the USB 2.0 controller in HiSpeed (480Mbps) or Full Speed (12Mbps). Configuration options: [FullSpeed] [HiSpeed]



The following items only appear when a USB storage device is plugged in.

USB Mass Storage Device Configuration

USB Mass Storage Reset Delay [20 Sec]

Sets the maximum time that the BIOS waits for the USB storage device to initialize. Configuration options: [10 Sec] [20 Sec] [30 Sec] [40 Sec]

Emulation Type [Auto]

Allows you to set the emulation type. Configuration options: [Auto] [Floppy] [Forced FDD] [Hard Disk] [CDROM]

2.5 Power menu

The Power menu items allow you to change the settings for the Advanced Configuration and Power Interface (ACPI) and the Advanced Power Management (APM). Select an item then press <Enter> to display the configuration options.

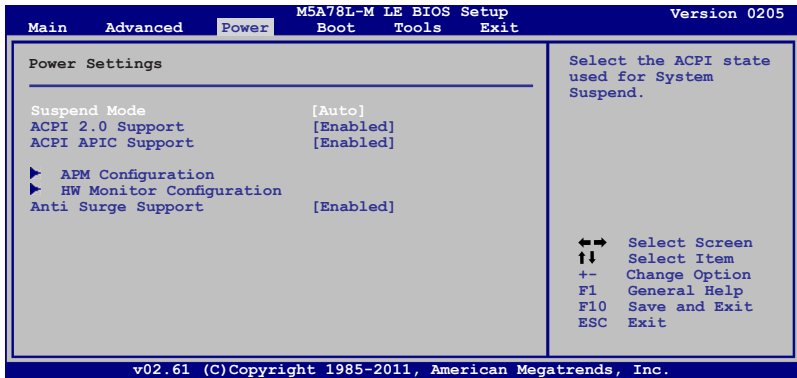

2.5.1 Suspend Mode [Auto]

Allows you to select the Advanced Configuration and Power Interface (ACPI) state to be used for system suspend. Configuration options: [S1 (POS) Only] [S3 Only] [Auto]

2.5.2 ACPI 2.0 Support [Enabled]

Allows you to enable or disable the Advanced Configuration and Power Interface (ACPI) 2.0 support. Configuration options: [Disabled] [Enabled]

2.5.3 ACPI APIC Support [Enabled]

Allows you to enable or disable the Advanced Configuration and Power Interface (ACPI) support in the Advanced Programmable Interrupt Controller (APIC). When set to Enabled, the ACPI APIC table pointer is included in the RSDT pointer list. Configuration options: [Disabled] [Enabled]

2.5.4 APM Configuration

Restore on AC Power Loss [Power Off]

When this item is set to **[Power Off]**, the system goes into off state after an AC power loss. When this item is set to **[Power On]**, the system goes on after an AC power loss. When this item set to **[Last State]**, the system goes into either off or on state, whatever the system state was before the AC power loss. Configuration options: [Power Off] [Power On] [Last State]

Power on From S5 By PME# [Disabled]

Enables or disables PME wake from sleep states. Configuration options: [Disabled] [Enabled]

Power on From S5 By Ring [Disabled]

Enables or disables ring to generate a wake event. Configuration options: [Disabled] [Enabled]

Power on By PS/2 Keyboard [Disabled]

Enables or disables PS/2 Keyboard to generate a wake event.
Configuration options: [Disabled] [Space Bar] [Power Key] [Ctrl-Esc]

Power On By PS/2 Mouse [Disabled]

When set to [Enabled], this parameter allows you to use the PS/2 mouse to turn on the system. This feature requires an ATX power supply that provides at least 1A on the +5VSB lead. Configuration options: [Disabled] [Enabled]

Power on From S5 By RTC Alarm [Disabled]

Enables or disables RTC to generate a wake event. Configuration options: [Disabled] [Enabled]

2.5.5 HW Monitor Configuration

CPU Temperature [xxx°C/xxx°F] or [Ignored]

MB Temperature [xxx°C/xxx°F] or [Ignored]

The onboard hardware monitor automatically detects and displays the motherboard and CPU temperatures. Select Ignored if you do not wish to display the detected temperatures.

CPU / Chassis Fan Speed [N/A], [xxxxRPM], or [Ignored]

The onboard hardware monitor automatically detects and displays the CPU / Chassis fan speeds in rotations per minute (RPM). If the fan is not connected to the motherboard, the field shows N/A. Select [Ignored] if you do not want the detected speed to be displayed.

VCORE Voltage, 3.3V Voltage, 5V Voltage, 12V Voltage [xx.xxxV] or [Ignored]

The onboard hardware monitor automatically detects the voltage output through the onboard voltage regulators.

CPU Q-Fan Function [Enabled]

Enables or disables the ASUS Q-Fan feature that smartly adjusts the CPU fan speeds for more efficient system operation. Configuration options: [Disabled] [Enabled]



The following item appears only when you set **CPU Q-Fan Function** to [Enabled].

CPU Fan Speed Low Limit [200 RPM]

Allows you to manually set a lower limit for the CPU fan speed. If the CPU fan speed is below the specified limit, the system sends out warning beeps. Configuration options: [600 RPM] [500 RPM] [400 RPM] [300 RPM] [200 RPM] [Ignored]

CPU Q-Fan Mode [Standard]

Allows you to set the appropriate performance level of the CPU fan.

[Standard] Sets to [Standard] to make the CPU fan automatically adjust depending on the CPU temperature.

[Silent] Sets to [Silent] to minimize the fan speed for quiet CPU fan operation.

[Turbo] Set to [Turbo] to achieve maximum CPU fan speed.

[Manual] Allows you to individually set the CPU fan parameters.

2.5.6 Anti Surge Support [Enabled]

Allows you to enable or disable the Anti-Surge protection feature.
Configuration options: [Disabled] [Enabled]

2.6 Boot menu

The **Boot** menu items allow you to change the system boot options. Select an item then press **<Enter>** to display the submenu.

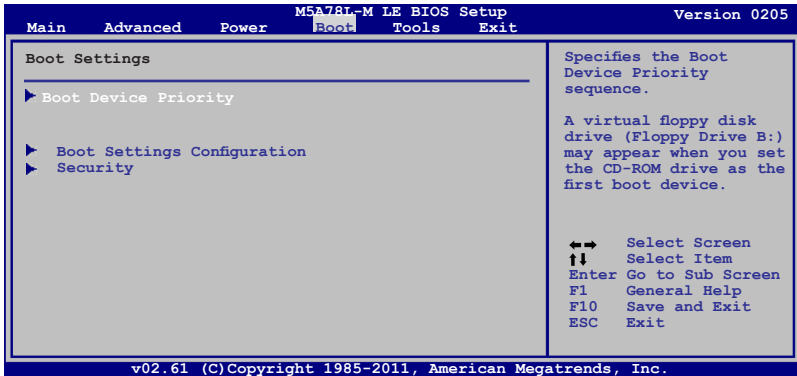

2.6.1 Boot Device Priority

1st ~ xxth Boot Device

These items specify the boot device priority sequence from the available devices. The number of device items that appears on the screen depends on the number of devices installed in the system. Configuration options: [Removable Dev.] [Hard Drive] [ATAPI CD-ROM] [Disabled]



- To select the boot device during system startup, press **<F8>** when ASUS logo appears.
- To access Windows OS in Safe Mode, do any of the following:
 - Press **<F5>** when ASUS logo appears.
 - Press **<F8>** after POST.

2.6.2 Boot Settings Configuration

Quick Boot [Enabled]

Enabling this item allows the BIOS to skip some power on self tests (POST) while booting to decrease the time needed to boot the system. When this item is set to **[Disabled]**, BIOS performs all the POST items. Configuration options: [Disabled] [Enabled]

Full Screen Logo [Enabled]

Enables or disables the full screen logo display feature. Configuration options: [Disabled] [Enabled]



Set this item to **[Enabled]** to use the ASUS MyLogo2™ feature.

AddOn ROM Display Mode [Force BIOS]

Sets the display mode for option ROM. Configuration options: [Force BIOS] [Keep Current]

Bootup Num-Lock [On]

Selects the power-on state for the NumLock. Configuration options: [Off] [On]

Wait for 'F1' If Error [Enabled]

When this item is set to [Enabled], the system waits for the F1 key to be pressed when error occurs. Configuration options: [Disabled] [Enabled]

Hit 'DEL' Message Display [Enabled]

When this item is set to [Enabled], the system displays the message **Press DEL to run Setup** during POST. Configuration options: [Disabled] [Enabled]

2.6.3 Security

The Security menu items allow you to change the system security settings. Select an item then press **<Enter>** to display the configuration options.

Change Supervisor Password

Select this item to set or change the supervisor password. The **Supervisor Password** item on top of the screen shows the default **Not Installed**. After you set a password, this item shows **Installed**.

To set a Supervisor Password:

1. Select the **Change Supervisor Password** item and press **<Enter>**.
2. On the password box, key in a password containing up to six letters, or numbers, or both, then press **<Enter>**.
3. Confirm the password when prompted.

The message **Password Installed** appears after you successfully set your password.

To change the supervisor password, follow the same steps as in setting a supervisor password.

To clear the supervisor password, select the **Change Supervisor Password** then press **<Enter>** twice. The message **Password uninstalled** appears.



If you forget your BIOS password, you can clear it by erasing the CMOS Real Time Clock (RTC) RAM. See section 1.9 **Jumpers** for information on how to erase the RTC RAM.

After you have set a supervisor password, the other items appear to allow you to change other security settings.

User Access Level [Full Access]

This item allows you to select the access restriction to the Setup items. Configuration options: [No Access] [View Only] [Limited] [Full Access]

No Access prevents user access to the Setup utility.

View Only allows access but does not allow change to any field.

Limited allows changes only to selected fields, such as Date and Time.

Full Access allows viewing and changing all the fields in the Setup utility.

Change User Password

Select this item to set or change the user password. The **User Password** item on top of the screen shows the default **Not Installed**. After you set a password, this item shows **Installed**.

To set a User Password:

1. Select the **Change User Password** item and press **<Enter>**.
2. On the password box, key in a password containing up to six letters, or numbers, or both, then press **<Enter>**.
3. Confirm the password when prompted.

The message "**Password Installed**" appears after you set your password successfully.

To change the user password, follow the same steps as in setting a user password.

Clear User Password

Select this item to clear the user password.

Password Check [Setup]

When set to **[Setup]**, BIOS checks for user password when accessing the Setup utility. When set to **[Always]**, BIOS checks for user password both when accessing Setup and booting the system. Configuration options: **[Setup]** **[Always]**

2.7 Tools menu

The **Tools** menu items allow you to configure options for special functions. Select an item then press **<Enter>** to display the sub-menu.

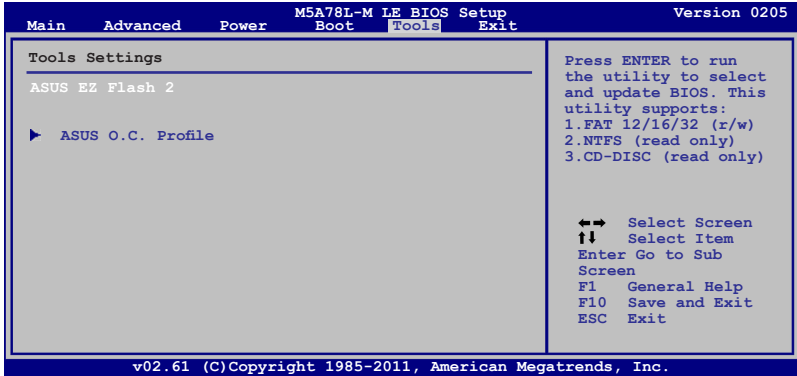

2.7.1 ASUS EZ Flash 2

Allows you to run ASUS EZ Flash 2. When you press **<Enter>**, a confirmation message appears. Use the left/right arrow key to select between **[Yes]** or **[No]**, then press **<Enter>** to confirm your choice. See section 2.1.2 for details.

2.7.2 ASUS O.C. Profile

This item allows you to store or load multiple BIOS settings.

Add Your CMOS Profile

Allows you to save the current BIOS file to the BIOS Flash. In the Name sub-item, key in your profile name and press **<Enter>**, and then choose a profile number to save your CMOS settings in the **Save to** sub-item.

Load CMOS Profiles.

Allows you to load the previous BIOS settings saved in the BIOS Flash. Press **<Enter>** to load the file.

Start O.C. Profile

Allows you to run the utility to save and load CMOS. Press **<Enter>** to run the utility.



- This function can support devices such as a USB flash disk with FAT 32/16 format and single partition only.
- DO NOT shut down or reset the system while updating the BIOS to prevent the system boot failure!
- We recommend that you update the BIOS file only coming from the same memory/CPU configuration and BIOS version.
- Only the CMO file can be loaded.

2.8 Exit menu

The **Exit** menu items allow you to load the optimal or failsafe default values for the BIOS items, and save or discard your changes to the BIOS items.

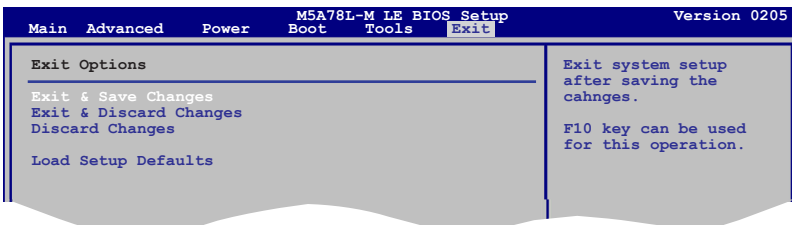

Pressing **<Esc>** does not immediately exit this menu. Select one of the options from this menu or **<F10>** from the legend bar to exit.

Exit & Save Changes

Once you are finished making your selections, choose this option from the Exit menu to ensure the values you selected are saved to the CMOS RAM. An onboard backup battery sustains the CMOS RAM so it stays on even when the PC is turned off. When you select this option, a confirmation window appears. Select **OK** to save changes and exit.

Exit & Discard Changes

Select this option only if you do not want to save the changes that you made to the Setup program. If you made changes to fields other than System Date, System Time, and Password, the BIOS asks for a confirmation before exiting.

Discard Changes

This option allows you to discard the selections you made and restore the previously saved values. After selecting this option, a confirmation appears. Select **OK** to discard any changes and load the previously saved values.

Load Setup Defaults

This option allows you to load the default values for each of the parameters on the Setup menus. When you select this option or if you press **<F5>**, a confirmation window appears. Select **OK** to load default values. Select **Exit & Save Changes** or make other changes before saving the values to the non-volatile RAM.

ASUS contact information

ASUSTeK COMPUTER INC.

Address	15 Li-Te Road, Peitou, Taipei, Taiwan 11259
Telephone	+886-2-2894-3447
Fax	+886-2-2890-7798
E-mail	info@asus.com.tw
Web site	www.asus.com.tw

Technical Support

Telephone	+86-21-38429911
Online support	support.asus.com

ASUS COMPUTER INTERNATIONAL (America)

Address	800 Corporate Way, Fremont, CA 94539, USA
Telephone	+1-510-739-3777
Fax	+1-510-608-4555
Web site	usa.asus.com

Technical Support

Telephone	+1-812-282-2787
Support fax	+1-812-284-0883
Online support	support.asus.com

ASUS COMPUTER GmbH (Germany and Austria)

Address	Harkort Str. 21-23, D-40880 Ratingen, Germany
Fax	+49-2102-959911
Web site	www.asus.de
Online contact	www.asus.de/sales

Technical Support

Telephone (Component)	+49-1805-010923*
Telephone (System/Notebook/Eee/LCD)	+49-1805-010920*
Support Fax	+49-2102-9599-11
Online support	support.asus.com

* EUR 0.14/minute from a German fixed landline; EUR 0.42/minute from a mobile phone.

DECLARATION OF CONFORMITY

Per FCC Part 2 Section 2.1077(a)



Responsible Party Name: **Asus Computer International**

Address: **800 Corporate Way, Fremont, CA 94539.**

Phone/Fax No.: **(510)739-3777/(510)608-4555**

hereby declares that the product

Product Name : MotherBoard

Model Number : M5A78L-M LE, M5A78L-M PLUS

Conforms to the following specifications:

- FCC Part 15, Subpart B, Unintentional Radiators
- FCC Part 15, Subpart C, Intentional Radiators
- FCC Part 15, Subpart E, Intentional Radiators

Supplementary Information:

This device complies with part 15 of the FCC Rules. Operation is subject to the following two conditions: (1) This device may not cause harmful interference, and (2) this device must accept any interference received, including interference that may cause undesired operation.

Representative Person's Name : Steve Chang / President

Steve Chang

Signature :

Date : **May 13, 2011**

EC Declaration of Conformity



We, the undersigned,

Manufacturer: **ASUSTeK COMPUTER INC.**
Address, City: **4F, 150, LITE RD., PEITOU, TAINPEI 12, TAIWAN**
Country: **TAIWAN**
Authorized representative in Europe: **ASUS COMPUTER GmbH**
Address, City: **HARKORT STR. 21-23, 40860 RATINGEN**
Country: **GERMANY**

declare the following apparatus:

Product name : **Motherboard**
Model name : **M5A78L-M LE**

conform with the essential requirements of the following directives:

2004/108/EC-EMC Directive
 EN 55022:2010
 EN 61000-3-2:2006-A2:2009
 EN 55013:2011+A1:2009-A2:2006
 EN 55020:2007-A11:2011

1999/5/EC-R & TTE Directive

EN 300 328 V1.7.1 (2006-10)
 EN 300 442 V1.4.1 (2010-08)
 EN 300 442 V1.4.1 (2010-08)
 EN 301 511 V9.0.2 (2003-03)
 EN 301 511 V9.0.2 (2003-03)
 EN 301 883 V1.6.1 (2011-11)
 EN 301 883 V1.6.1 (2011-11)
 EN 302 463 V1.1 (2009-01)
 EN 302 463 V1.1 (2009-01)
 EN 300 330-1 V1.7.1 (2010-02)
 EN 300 330-2 V1.5.1 (2010-02)
 EN 62479:2010

2006/95/EC-LVD Directive

EN 60950-1 A11:2009
 EN 60950-1 A12:2011
 EN 60950-1 A12:2011

2009/125/EC-EP Directive

Regulation (EC) No. 1275/2008
 Regulation (EC) No. 642/2009

2011/65/EU-RoHS Directive

CE marking



(EC conformity marking)

Position : **CEO**
Name : **Jerry Shen**

Jerry Shen

Signature : _____

Declaration Date: **Dec. 10, 2012**
Year to begin affixing CE marking: **2012**

Ver. 12/01