

**ROG CROSSHAIR
VIII FORMULA**

ASUS[®]

Motherboard

E15393
First Edition
May 2019

Copyright © 2019 ASUSTeK COMPUTER INC. All Rights Reserved.

No part of this manual, including the products and software described in it, may be reproduced, transmitted, transcribed, stored in a retrieval system, or translated into any language in any form or by any means, except documentation kept by the purchaser for backup purposes, without the express written permission of ASUSTeK COMPUTER INC. ("ASUS").

Product warranty or service will not be extended if: (1) the product is repaired, modified or altered, unless such repair, modification of alteration is authorized in writing by ASUS; or (2) the serial number of the product is defaced or missing.

ASUS PROVIDES THIS MANUAL "AS IS" WITHOUT WARRANTY OF ANY KIND, EITHER EXPRESS OR IMPLIED, INCLUDING BUT NOT LIMITED TO THE IMPLIED WARRANTIES OR CONDITIONS OF MERCHANTABILITY OR FITNESS FOR A PARTICULAR PURPOSE. IN NO EVENT SHALL ASUS, ITS DIRECTORS, OFFICERS, EMPLOYEES OR AGENTS BE LIABLE FOR ANY INDIRECT, SPECIAL, INCIDENTAL, OR CONSEQUENTIAL DAMAGES (INCLUDING DAMAGES FOR LOSS OF PROFITS, LOSS OF BUSINESS, LOSS OF USE OR DATA, INTERRUPTION OF BUSINESS AND THE LIKE), EVEN IF ASUS HAS BEEN ADVISED OF THE POSSIBILITY OF SUCH DAMAGES ARISING FROM ANY DEFECT OR ERROR IN THIS MANUAL OR PRODUCT.

SPECIFICATIONS AND INFORMATION CONTAINED IN THIS MANUAL ARE FURNISHED FOR INFORMATIONAL USE ONLY, AND ARE SUBJECT TO CHANGE AT ANY TIME WITHOUT NOTICE, AND SHOULD NOT BE CONSTRUED AS A COMMITMENT BY ASUS. ASUS ASSUMES NO RESPONSIBILITY OR LIABILITY FOR ANY ERRORS OR INACCURACIES THAT MAY APPEAR IN THIS MANUAL, INCLUDING THE PRODUCTS AND SOFTWARE DESCRIBED IN IT.

Products and corporate names appearing in this manual may or may not be registered trademarks or copyrights of their respective companies, and are used only for identification or explanation and to the owners' benefit, without intent to infringe.

Offer to Provide Source Code of Certain Software

This product contains copyrighted software that is licensed under the General Public License ("GPL"), under the Lesser General Public License Version ("LGPL") and/or other Free Open Source Software Licenses. Such software in this product is distributed without any warranty to the extent permitted by the applicable law. Copies of these licenses are included in this product.

Where the applicable license entitles you to the source code of such software and/or other additional data, you may obtain it for a period of three years after our last shipment of the product, either

(1) for free by downloading it from <https://www.asus.com/support/>

or

(2) for the cost of reproduction and shipment, which is dependent on the preferred carrier and the location where you want to have it shipped to, by sending a request to:

ASUSTeK Computer Inc.
Legal Compliance Dept.
15 Li Te Rd.,
Beitou, Taipei 112
Taiwan

In your request please provide the name, model number and version, as stated in the About Box of the product for which you wish to obtain the corresponding source code and your contact details so that we can coordinate the terms and cost of shipment with you.

The source code will be distributed WITHOUT ANY WARRANTY and licensed under the same license as the corresponding binary/object code.

This offer is valid to anyone in receipt of this information.

ASUSTeK is eager to duly provide complete source code as required under various Free Open Source Software licenses. If however you encounter any problems in obtaining the full corresponding source code we would be much obliged if you give us a notification to the email address gpl@asus.com, stating the product and describing the problem (please DO NOT send large attachments such as source code archives, etc. to this email address).

Contents

Safety information.....	vi
About this guide.....	vii
ROG CROSSHAIR VIII FORMULA specifications summary	ix
Package contents.....	xv
Installation tools and components	xvi

Chapter 1: Product Introduction

1.1	Motherboard overview.....	1-1
1.1.1	Before you proceed.....	1-1
1.1.2	Motherboard layout.....	1-2
1.1.3	Central Processing Unit (CPU)	1-4
1.1.4	System memory	1-5
1.1.5	Expansion slots.....	1-7
1.1.6	Onboard buttons	1-9
1.1.7	Onboard switches	1-11
1.1.8	Onboard jumpers	1-12
1.1.9	Onboard LEDs	1-13
1.1.10	Internal connectors.....	1-16

Chapter 2: Basic Installation

2.1	Building your PC system.....	2-1
2.1.1	CPU installation.....	2-1
2.1.2	Cooling system installation.....	2-2
2.1.3	Motherboard installation.....	2-5
2.1.4	DIMM installation.....	2-6
2.1.5	ATX power connection	2-7
2.1.6	SATA device connection	2-8
2.1.7	Front I/O connector.....	2-9
2.1.8	Expansion card installation	2-10
2.1.9	M.2 installation	2-11
2.1.10	Wi-Fi antenna installation.....	2-12
2.2	BIOS update utility	2-13
2.3	Motherboard rear and audio connections	2-14
2.3.1	Rear I/O connection	2-14
2.3.2	Audio I/O connections.....	2-16
2.4	Starting up for the first time.....	2-18
2.5	Turning off the computer	2-18

Chapter 3: BIOS Setup

3.1	Knowing BIOS	3-1
3.2	BIOS setup program	3-2
3.2.1	Advanced Mode	3-3
3.2.2	EZ Mode	3-6
3.2.3	Q-Fan Control	3-7
3.2.4	EZ Tuning Wizard	3-9
3.3	My Favorites	3-11
3.4	Main menu	3-13
3.5	Extreme Tweaker menu	3-13
3.6	Advanced menu	3-14
3.6.1	AMD fTPM configuration	3-14
3.6.2	CPU Configuration	3-15
3.6.3	SATA Configuration	3-15
3.6.4	Onboard Devices Configuration	3-16
3.6.5	APM Configuration	3-18
3.6.6	PCI Subsystem Settings	3-18
3.6.7	USB Configuration	3-19
3.6.8	HDD/SSD SMART Information	3-19
3.6.9	Network Stack Configuration	3-19
3.6.10	AMD CBS	3-20
3.6.11	AMD PBS	3-20
3.7	Monitor menu	3-20
3.8	Boot menu	3-21
3.9	Tool menu	3-22
3.9.1	ASUS EZ Flash 3 Utility	3-22
3.9.2	ASUS Secure Erase	3-23
3.9.3	ASUS User Profile	3-24
3.9.4	ASUS SPD Information	3-24
3.9.5	Graphics Card Information	3-24
3.9.6	ASUS Armoury Crate	3-25
3.10	Exit menu	3-25
3.11	Updating BIOS	3-26
3.11.1	EZ Update	3-26
3.11.2	ASUS EZ Flash 3	3-27
3.11.3	ASUS CrashFree BIOS 3	3-29

Chapter 4: RAID Support

4.1	AMD RAID Array configurations.....	4-1
4.1.1	RAID definitions	4-1

Appendix

Q-Code table.....	A-1
Notices	A-5
ASUS contact information.....	A-11

Safety information

Electrical safety

- To prevent electrical shock hazard, disconnect the power cable from the electrical outlet before relocating the system.
- When adding or removing devices to or from the system, ensure that the power cables for the devices are unplugged before the signal cables are connected. If possible, disconnect all power cables from the existing system before you add a device.
- Before connecting or removing signal cables from the motherboard, ensure that all power cables are unplugged.
- Seek professional assistance before using an adapter or extension cord. These devices could interrupt the grounding circuit.
- Ensure that your power supply is set to the correct voltage in your area. If you are not sure about the voltage of the electrical outlet you are using, contact your local power company.
- If the power supply is broken, do not try to fix it by yourself. Contact a qualified service technician or your retailer.

Operation safety

- Before installing the motherboard and adding devices on it, carefully read all the manuals that came with the package.
- Before using the product, ensure all cables are correctly connected and the power cables are not damaged. If you detect any damage, contact your dealer immediately.
- To avoid short circuits, keep paper clips, screws, and staples away from connectors, slots, sockets and circuitry.
- Avoid dust, humidity, and temperature extremes. Do not place the product in any area where it may become wet.
- Place the product on a stable surface.
- If you encounter technical problems with the product, contact a qualified service technician or your retailer.

About this guide

This user guide contains the information you need when installing and configuring the motherboard.

How this guide is organized

This guide contains the following parts:

- **Chapter 1: Product Introduction**
This chapter describes the features of the motherboard and the new technology it supports. It includes description of the switches, jumpers, and connectors on the motherboard.
- **Chapter 2: Basic Installation**
This chapter lists the hardware setup procedures that you have to perform when installing system components.
- **Chapter 3: BIOS Setup**
This chapter tells how to change system settings through the BIOS Setup menus. Detailed descriptions of the BIOS parameters are also provided.
- **Chapter 4: RAID Support**
This chapter describes the RAID configurations.

Where to find more information

Refer to the following sources for additional information and for product and software updates.

1. **ASUS website**
The ASUS website (www.asus.com) provides updated information on ASUS hardware and software products.
2. **Optional documentation**
Your product package may include optional documentation, such as warranty flyers, that may have been added by your dealer. These documents are not part of the standard package.

Conventions used in this guide

To ensure that you perform certain tasks properly, take note of the following symbols used throughout this manual.



DANGER/WARNING: Information to prevent injury to yourself when trying to complete a task.



CAUTION: Information to prevent damage to the components when trying to complete a task.



IMPORTANT: Instructions that you **MUST** follow to complete a task.



NOTE: Tips and additional information to help you complete a task.

Typography

Bold text

Indicates a menu or an item to select.

Italics

Used to emphasize a word or a phrase.

<Key>

Keys enclosed in the less-than and greater-than sign means that you must press the enclosed key.

Example: <Enter> means that you must press the Enter or Return key.

<Key1> + <Key2> + <Key3>

If you must press two or more keys simultaneously, the key names are linked with a plus sign (+).

ROG CROSSHAIR VIII FORMULA

specifications summary

CPU	<p>AMD AM4 Socket for 3rd and 2nd Gen AMD Ryzen™ / 2nd and 1st Gen AMD Ryzen™ with Radeon™ Vega Graphics Processors*</p> <p>* Refer to www.asus.com for the AMD CPU support list.</p>
Chipset	AMD X570 Chipset
Memory	<p>3rd Gen AMD Ryzen™ Processors 4 x DIMM, max. 128GB, DDR4 4600(O.C.) / 4533(O.C.) / 4400(O.C.) / 4266(O.C.) / 4133(O.C.) / 4000(O.C.) / 3866(O.C.) / 3733(O.C.) / 3600(O.C.) / 3466(O.C.) / 3200(O.C.) / 3000(O.C.) / 2933(O.C.) / 2800(O.C.) / 2666 / 2400 / 2133 MHz non-ECC, un-buffered memory</p> <p>2nd Gen AMD Ryzen™ Processors 4 x DIMM, max. 64GB, DDR4 3600(O.C.) / 3466(O.C.) / 3200(O.C.) / 3000(O.C.) / 2933(O.C.) / 2800(O.C.) / 2666 / 2400 / 2133 MHz non-ECC, un-buffered memory</p> <p>2nd and 1st Gen AMD Ryzen™ with Radeon™ Vega Graphics Processors 4 x DIMM, max. 64GB, DDR4 3200(O.C.) / 3000(O.C.) / 2933(O.C.) / 2800(O.C.) / 2666 / 2400 / 2133 MHz non-ECC, un-buffered memory</p> <p>Dual channel memory architecture</p> <p>* Refer to www.asus.com for the Memory QVL (Qualified Vendors List).</p>
Expansion slots	<p>3rd Gen AMD Ryzen™ Processors - 2 x PCIe 4.0 x16 SafeSlots (supports x16, x8/x8)</p> <p>2nd Gen AMD Ryzen™ Processors - 2 x PCIe 3.0 x16 SafeSlots (supports x16, x8/x8)</p> <p>2nd and 1st Gen AMD Ryzen™ with Radeon™ Vega Graphics Processors - 1 x PCIe 3.0 x16 SafeSlot (supports x8)</p> <p>AMD X570 chipset - 1 x PCIe 4.0 x16 (supports x4) - 1 x PCIe 4.0 x1</p>
Multi-GPU	<p>3rd and 2nd Gen AMD Ryzen™ Processors Supports NVIDIA® 2-Way SLI® Technology Supports AMD 3-Way CrossFireX™ Technology</p> <p>2nd and 1st Gen AMD Ryzen™ with Radeon™ Vega Graphics Processors Supports AMD 2-Way CrossFireX™ Technology</p>

(continued on the next page)

ROG CROSSHAIR VIII FORMULA

specifications summary

Storage	<p>3rd Gen AMD Ryzen™ Processors</p> <ul style="list-style-type: none"> - 1 x M.2 Socket 3 with M Key, type 2242 / 2260 / 2280 (PCIe 4.0 x4 and SATA modes) storage devices support <p>2nd Gen AMD Ryzen™ / 2nd and 1st Gen AMD Ryzen™ with Radeon™ Vega Graphics Processors</p> <ul style="list-style-type: none"> - 1 x M.2 Socket 3 with M Key, type 2242 / 2260 / 2280 (PCIe 3.0 x4 and SATA modes) storage devices support <p>AMD X570 chipset</p> <ul style="list-style-type: none"> - 8 x SATA 6Gb / s ports - Support Raid 0, 1, 10 - 1 x M.2 Socket 3 with M Key, type 2242 / 2260 / 2280 / 22110 (PCIe 4.0 x4 and SATA modes) storage devices support
LAN	<p>Aquantia AQC-111C 5G LAN Intel® Ethernet Controller I211-AT Anti-surge LANGuard ROG GameFirst Technology</p>
Wireless Data Network	<p>Intel® Wi-Fi 6 AX200 2 x 2 Wi-Fi 6 (802.11 a/b/g/n/ac/ax) with MU-MIMO supports dual frequency band 2.4/5GHz Supports channel bandwidth: HT20/HT40/HT80/HT160 Up to 2.4Gbps transfer speed</p>
Bluetooth	<p>Bluetooth v5.0</p>
Audio	<p>ROG SupremeFX 8-Channel High Definition Audio CODEC S1220</p> <ul style="list-style-type: none"> - Supports up to 32-Bit/192kHz playback* - High quality 120 dB SNR stereo playback output and 113 dB SNR recording input - Impedance sense for front and rear headphone outputs - ESS® ES9023P High Definition DAC - SupremeFX Shielding Technology - Jack-detection, Multi-streaming, and Front Panel Jack-retasking - Optical S/PDIF out port at back Panel <p>Audio Features:</p> <ul style="list-style-type: none"> - Sonic Radar III - Sonic Studio III + Sonic Studio Virtual Mixer - DTS® Sound Unbound <p>* Due to limitations in HDA bandwidth, 32-Bit/192kHz is not supported for 8-Channel audio.</p>

(continued on the next page)

ROG CROSSHAIR VIII FORMULA

specifications summary

<p>USB</p>	<p>3rd Gen AMD Ryzen™ Processors</p> <ul style="list-style-type: none"> - 4 x USB 3.2 Gen 2 ports (4 ports at back panel, Type-A, [red]) <p>2nd Gen AMD Ryzen™ / 2nd and 1st Gen AMD Ryzen™ with Radeon™ Vega Graphics Processors</p> <ul style="list-style-type: none"> - 4 x USB 3.2 Gen 1 ports (4 ports at back panel, Type-A [red]) <p>AMD X570 chipset:</p> <ul style="list-style-type: none"> - 1 x USB 3.2 Gen 2 front panel connector - 4 x USB 3.2 Gen 2 ports (4 ports at back panel, 3 x Type-A [red], 1 x Type-C) - 8 x USB 3.2 Gen 1 ports (4 ports at back panel [blue], 4 ports at front panel) - 4 x USB 2.0 ports at front panel
<p>ROG Exclusive Features</p>	<p>Extreme Engine Digi+</p> <ul style="list-style-type: none"> - MicroFine Alloy Choke - 10K Black Metallic Capacitors - IR3555 PoweIRstage® <p>ROG Extreme OC kit:</p> <ul style="list-style-type: none"> - Safe Boot button - Slow Mode - LN2 Mode - OptiMem III <p>Extreme Tweaker</p> <p>ROG Exclusive Software</p> <ul style="list-style-type: none"> - RAMCache III - ROG RAMDisk - CPU-Z - GameFirst V - Sonic Studio III + Sonic Studio Virtual Mixer - Sonic Radar III - DTS® Sound Unbound <p>CrossChill EK III</p> <p>ROG Armor</p>

(continued on the next page)

ROG CROSSHAIR VIII FORMULA

specifications summary

<p>Special Features</p>	<p>Asus Exclusive Software Features</p> <ul style="list-style-type: none"> - Armoury Crate - Aura - AI Suite 3 - Asus Dual Intelligent Processor 5 <ul style="list-style-type: none"> - 5-way Optimization tuning key perfectly consolidates TPU Insights, EPU Guidance, DIGI+ VRM, Fan Expert 4, and Turbo app - ASUS EZ DIY <ul style="list-style-type: none"> - ASUS CrashFree BIOS 3 - ASUS EZ Flash 3 - ASUS C.P.R (CPU Parameter Recall) - Ai Charger <p>Asus Exclusive Hardware Features</p> <ul style="list-style-type: none"> - LiveDash OLED 1.3" - ROG patented pre-mounted I/O shield - ASUS NODE: Hardware control interface - USB BIOS Flashback™ Button - Clear CMOS Button - Start Button - Reset Button - Retry Button <p>ASUS Q-Design</p> <ul style="list-style-type: none"> - Q-Slot - Q-Connector - Q-LED - Q-DIMM
<p>Back I/O Ports</p>	<ul style="list-style-type: none"> 1 x Clear CMOS Button 1 x BIOS Flashback™ Button 1 x 2x2 Wi-Fi Module 8 x USB 3.2 Gen 2 ports (7 x Type-A [red] and 1 x Type-C) 4 x USB 3.2 Gen 1 ports (4 x Type-A [blue]) 1 x Anti-surge 5G LAN (RJ45) port 1 x Anti-surge LAN (RJ45) port 1 x Optical S/PDIF out port 5 x Gold-plated audio jacks

(continued on the next page)

ROG CROSSHAIR VIII FORMULA

specifications summary

Internal connectors

- 1 x USB 3.2 Gen 2 front panel connector
- 2 x USB 3.2 Gen 1 headers support additional 4 USB 3.2 Gen 1 ports
- 2 x USB 2.0 headers support additional 4 USB 2.0 ports
- 8 x SATA 6Gb/s connectors
- 1 x M.2 Socket 3 with M Key, Type 2242/2260/2280 storage devices support
- 1 x M.2 Socket 3 with M Key, Type 2242/2260/2280/22110 storage devices support
- 1 x 4-Pin CPU_Fan connector
- 1 x 4-Pin CPU_OPT fan connector
- 3 x 4-Pin CHA_Fan connectors
- 1 x 4-Pin AIO_PUMP connector
- 1 x 4-Pin W_PUMP+ connector
- 1 x 4-Pin H_AMP fan connector
- 1 x PCH_FAN
- 1 x 3-Pin W_FLOW connector
- 1 x 2-Pin W_IN connector
- 1 x 2-Pin W_OUT connector
- 1 x T_SENSOR connector
- 1 x 24-Pin EATX power connector
- 1 x 8-Pin EATX 12V power connector
- 1 x 4-Pin EATX 12V power connector
- 1 x Start button
- 1 x Reset button
- 1 x Safe Boot button
- 1 x Retry button
- 1 x LN2 mode Jumper
- 1 x Slow mode switch
- 1 x NODE connector
- 1 x System panel connector
- 1 x Speaker connector
- 1 x Front panel audio connector (AAFP)
- 2 x AURA Addressable Gen2 headers
- 2 x AURA RGB headers

(continued on the next page)

ROG CROSSHAIR VIII FORMULA

specifications summary

BIOS	256 Mb Flash ROM, UEFI AMI BIOS, PnP, WfM2.0, SM BIOS 3.2, ACPI 6.2
Manageability	WOL, PXE
Software	Overwolf WinRAR Anti-virus software (1-year full subscription)
Operating System Support	Windows® 10 64-bit
Form Factor	ATX Form Factor, 12" x 9.6" (30.5cm x 24.4cm)



Specifications are subject to change without notice.

Package contents



Check your motherboard package for the following items.

Motherboard	1 x ROG CROSSHAIR VIII FORMULA motherboard
Cables	1 x 4-in-1 SATA 6Gb/s cable
	1 x 2-in-1 ROG weave SATA 6G cable
	1 x Extension Cable for RGB strip
	1 x Extension Cable for RGB addressable strip
Accessories	1 x ASUS 2x2 dual band Wi-Fi antennas
	1 x Q-Connector
	1 x 2-in-1 M.2 screws package
Application DVD	1 x ROG motherboard support DVD
Documentation	1 x User guide
Others	1 x ROG logo plate sticker
	1 x ROG coaster
	1 x ROG sticker
	1 x ROG thank you card
	1 x Cablemod coupon

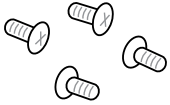

If any of the above items is damaged or missing, contact your retailer.

Installation tools and components

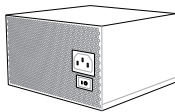
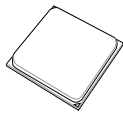
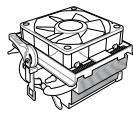
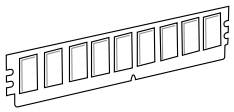
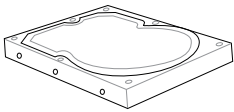
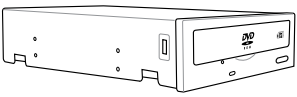
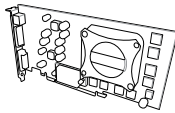
	
<p>1 Bag of screws</p>	<p>Phillips (cross) screwdriver</p>
	
<p>PC chassis</p>	<p>Power supply unit</p>
	
<p>AMD AM4 CPU</p>	<p>AMD AM4/AM3 compatible CPU Fan</p>
	
<p>DDR4 DIMM</p>	<p>SATA hard disk drive</p>
	
<p>SATA optical disc drive (optional)</p>	<p>Graphics card</p>



The tools and components in the table above are not included in the motherboard package.

Product Introduction

1

1.1 Motherboard overview

1.1.1 Before you proceed

Take note of the following precautions before you install motherboard components or change any motherboard settings.



Components shown in this section may require additional purchase. Refer to **Package contents** section for more information about the contents of your motherboard package.



- Unplug the power cord from the wall socket before touching any component.
 - Before handling components, use a grounded wrist strap or touch a safely grounded object or a metal object, such as the power supply case, to avoid damaging them due to static electricity.
 - Hold components by the edges to avoid touching the ICs on them.
 - Whenever you uninstall any component, place it on a grounded antistatic pad or in the bag that came with the component.
 - Before you install or remove any component, ensure that the ATX power supply is switched off or the power cord is detached from the power supply. Failure to do so may cause severe damage to the motherboard, peripherals, or components.
-

1.1.2 Motherboard layout

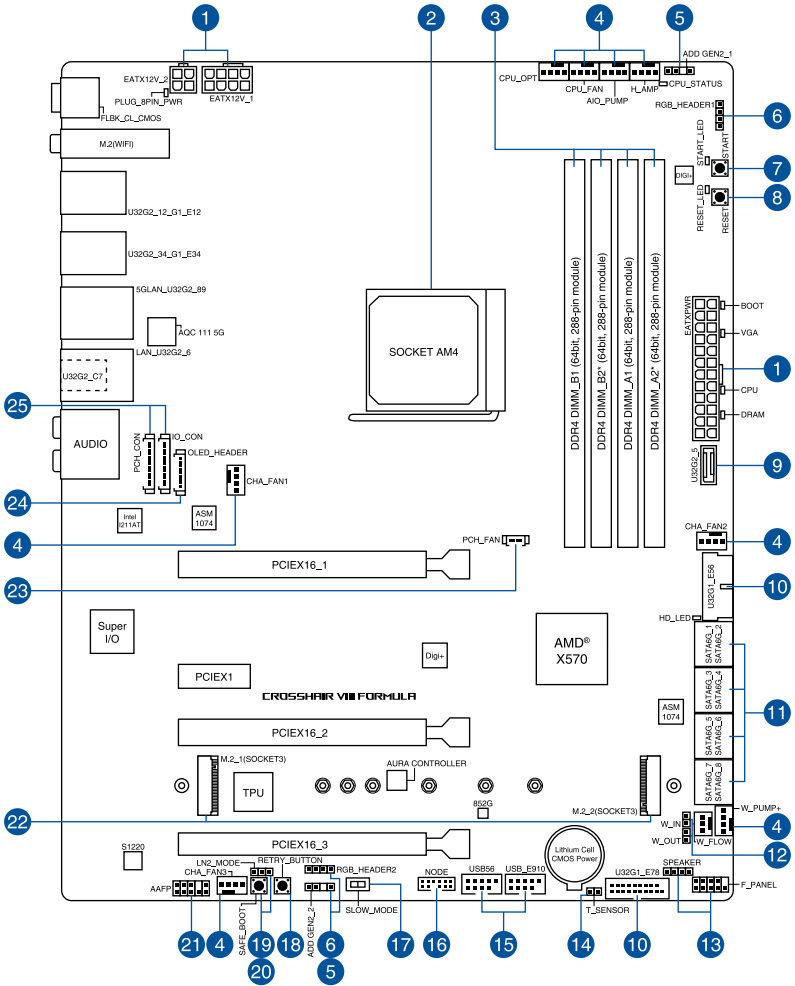

Refer to **Internal connectors** and **Rear panel features** section for more information.

Layout contents	Page
1. Power connectors	1-23
2. CPU socket	1-4
3. DIMM slots	1-5
4. Fan and Pump connectors	1-21
5. Addressable Gen2 LED connector	1-26
6. RGB LED connector	1-25
7. Power button	1-9
8. Reset button	1-9
9. USB 3.2 Gen 2 connector	1-18
10. USB 3.2 Gen 1 connector	1-19
11. SATA 6Gb/s connector	1-16
12. Water Cooling System connectors	1-22
13. System Panel connector	1-24
14. Thermal Sensor connector	1-22
15. USB 2.0 connector	1-20
16. Node connector	1-28
17. Slow Mode switch	1-11
18. ReTry button	1-10
19. LN2 Mode jumper	1-12
20. Safe Boot button	1-10
21. Front Panel Audio connector	1-18
22. M.2 slot	1-17
23. PCH Fan connector	1-27
24. OLED connector	1-28
25. Rear I/O Cover LED connector	1-27

1.1.3 Central Processing Unit (CPU)

The motherboard comes with an AM4 socket designed for AMD AM4 Socket for 3rd and 2nd Gen AMD Ryzen™ / 2nd and 1st Gen AMD Ryzen™ with Radeon™ Vega Graphics Processors.

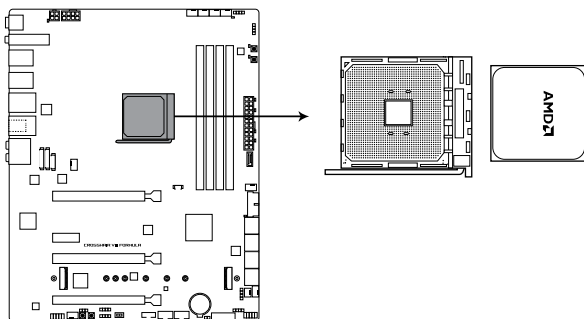

ROG CROSSHAIR VIII FORMULA CPU AM4



- The AM4 socket has a different pinout design. Ensure that you use a CPU designed for the AM4 socket.
- The CPU fits in only one correct orientation. DO NOT force the CPU into the socket to prevent bending the connectors on the CPU and damaging the CPU.
- Ensure that all power cables are unplugged before installing the CPU.

1.1.4 System memory

The motherboard comes with Dual Inline Memory Modules (DIMM) slots designed for DDR4 (Double Data Rate 4) memory modules.



A DDR4 memory module is notched differently from a DDR, DDR2, or DDR3 module. DO NOT install a DDR, DDR2, or DDR3 memory module to the DDR4 slot.

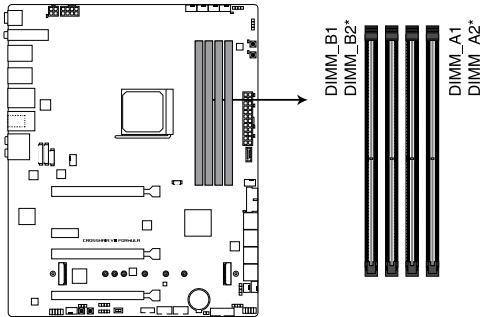

ROG CROSSHAIR VIII FORMULA 288-pin DDR4 DIMM socket

Recommended memory configurations

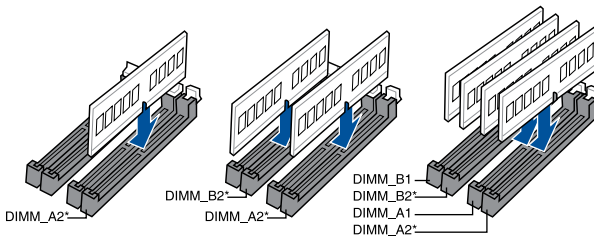

Memory configurations

You may install 2 GB, 4 GB, 8 GB, 16 GB, and 32 GB unbuffered and non-ECC DDR4 DIMMs into the DIMM sockets.



You may install varying memory sizes in Channel A and Channel B. The system maps the total size of the lower-sized channel for the dual-channel configuration. Any excess memory from the higher-sized channel is then mapped for single-channel operation.



- The default memory operation frequency is dependent on its Serial Presence Detect (SPD), which is the standard way of accessing information from a memory module. Under the default state, some memory modules for overclocking may operate at a lower frequency than the vendor-marked value.
 - For system stability, use a more efficient memory cooling system to support a full memory load or overclocking condition.
 - Always install the DIMMS with the same CAS Latency. For an optimum compatibility, we recommend that you install memory modules of the same version or data code (D/C) from the same vendor. Check with the vendor to get the correct memory modules.
 - Visit the ASUS website for the latest QVL.
-

1.1.5 Expansion slots



Unplug the power cord before adding or removing expansion cards. Failure to do so may cause you physical injury and damage motherboard components.

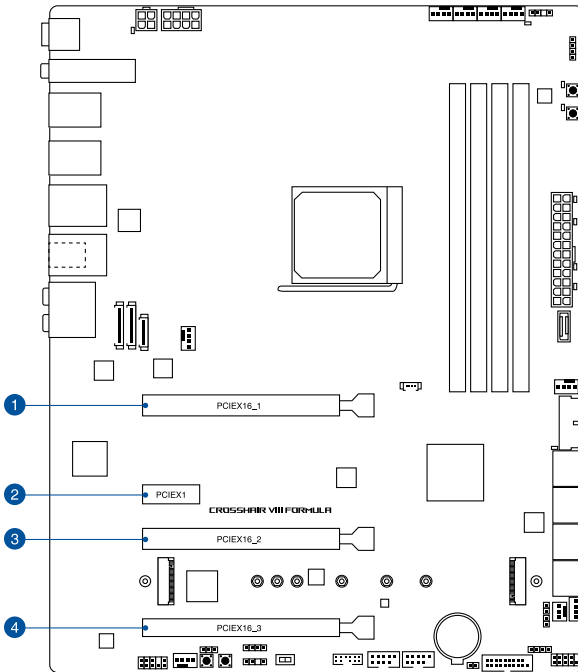

Slot No.	Slot Description
1	PCIe x16_1
2	PCIe x1
3	PCIe x16_2
4	PCIe x16_3

PCIe operating mode

3rd Gen AMD Ryzen™ Processors

Slot Description	PCIe operating mode		
	Single VGA / PCIe card	Dual VGA / PCIe card	Triple VGA / PCIe card
PCIe x16_1	x16 (PCIe 4.0)	x8 (PCIe 4.0)	x8 (PCIe 4.0)
PCIe x16_2	N/A	x8 (PCIe 4.0)	x8 (PCIe 4.0)
PCIe x16_3	N/A	N/A	x4 (PCIe 4.0)
M.2_1 (PCIe Mode)	x4 (PCIe 4.0)	x4 (PCIe 4.0)	x4 (PCIe 4.0)
M.2_1 (SATA Mode)	Support	Support	Support
M.2_2 (PCIe Mode)	x4 (PCIe 4.0)	x4 (PCIe 4.0)	x4 (PCIe 4.0)
M.2_2 (SATA Mode)	Support	Support	Support

2nd Gen AMD Ryzen™ Processors

Slot Description	PCIe operating mode		
	Single VGA / PCIe card	Dual VGA / PCIe card	Triple VGA / PCIe card
PCIe x16_1	x16 (PCIe 3.0)	x8 (PCIe 3.0)	x8 (PCIe 3.0)
PCIe x16_2	N/A	x8 (PCIe 3.0)	x8 (PCIe 3.0)
PCIe x16_3	N/A	N/A	x4 (PCIe 4.0)
M.2_1 (PCIe Mode)	x4 (PCIe 3.0)	x4 (PCIe 3.0)	x4 (PCIe 3.0)
M.2_1 (SATA Mode)	Support	Support	Support
M.2_2 (PCIe Mode)	x4 (PCIe 4.0)	x4 (PCIe 4.0)	x4 (PCIe 4.0)
M.2_2 (SATA Mode)	Support	Support	Support

2nd and 1st Gen AMD Ryzen™ with Radeon™ Vega Graphics

Slot Description	PCIe operating mode		
	Single VGA / PCIe card	Dual VGA / PCIe card	Triple VGA / PCIe card
PCIe x16_1	x8 (PCIe 3.0)	x8 (PCIe 3.0)	N/A
PCIe x16_2	N/A	N/A	N/A
PCIe x16_3	N/A	x4 (PCIe 4.0)	N/A
M.2_1 (PCIe Mode)	x4 (PCIe 3.0)	x4 (PCIe 3.0)	x4 (PCIe 3.0)
M.2_1 (SATA Mode)	Support	Support	Support
M.2_2 (PCIe Mode)	x4 (PCIe 4.0)	x4 (PCIe 4.0)	x4 (PCIe 4.0)
M.2_2 (SATA Mode)	Support	Support	Support



- We recommend that you provide sufficient power when running CrossFireX™ or SLI® mode.
- Ensure to connect the 8-pin and 4-pin power plugs when running CrossFireX™ or SLI® mode.
- Connect a chassis fan to the chassis fan connectors when using multiple graphics cards for better thermal environment.

1.1.6 Onboard buttons

1. Power button

Press the Power button to power up the system, or put the system into sleep or soft-off mode (depending on the operating system settings).

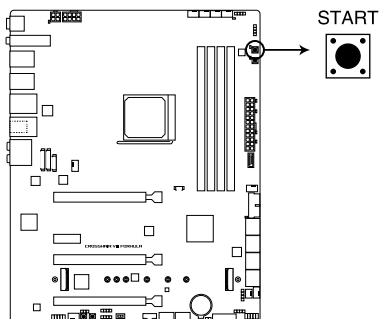

ROG CROSSHAIR VIII FORMULA Power on button

2. Reset button

Press the Reset button to reboot the system.

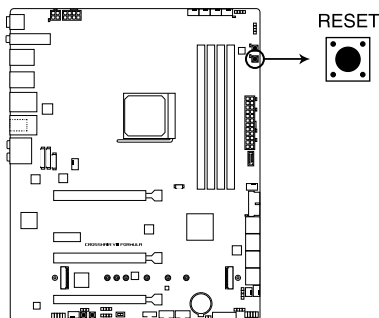

ROG CROSSHAIR VIII FORMULA Reset button

3. Safe Boot button

The Safe Boot button temporarily applies safe settings to the BIOS while retaining the overlocked settings, allowing you to modify the settings causing a boot failure. Press this button at anytime to force the system to reboot into the BIOS safe mode.

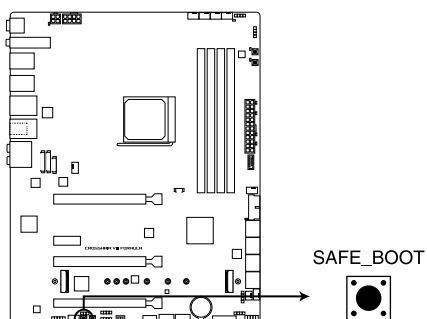

ROG CROSSHAIR VIII FORMULA Safe Boot button

4. ReTry button

The ReTry button is specially designed for overclockers and is most useful during the booting process where the Reset button is rendered useless. Press this button to force the system to reboot while retaining the same settings to be retried in quick succession to achieve a successful POST.

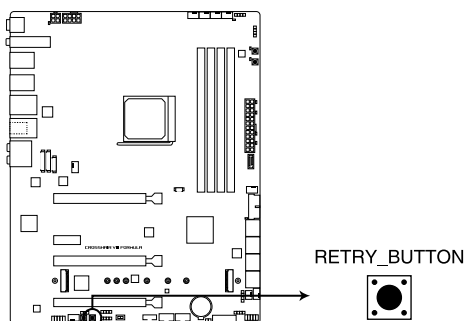

ROG CROSSHAIR VIII FORMULA ReTry button

1.1.7 Onboard switches

1. Slow Mode switch

The system may crash due to the CPU being unstable when using extreme overclocking settings. Enable the Slow Mode switch during LN2 benching to decrease the processor frequency and stabilize the system, allowing you to keep track of the overclocking data.

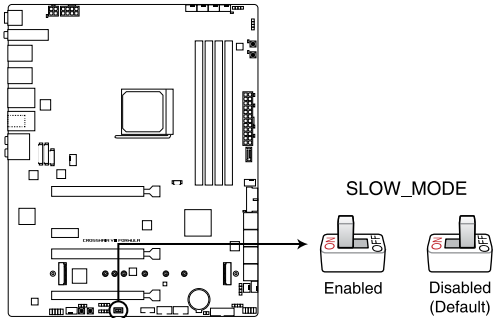

ROG CROSSHAIR VIII FORMULA Slow Mode switch

1.1.8 Onboard jumpers

1. LN2 Mode jumper

Set to pins 2-3 to optimize the motherboard to remedy the cold-boot bug during POST and help the system boot successfully.

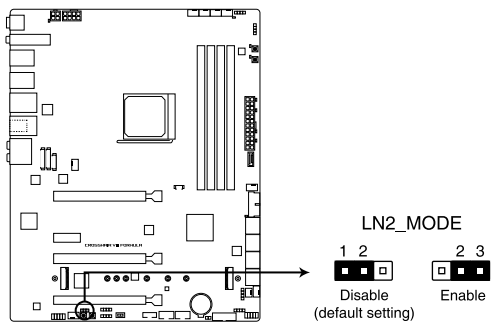

ROG CROSSHAIR VIII FORMULA LN2 Mode jumper

1.1.9 Onboard LEDs

1. Q LEDs

The Q LEDs check key components (CPU, DRAM, VGA, and booting devices) during the motherboard booting process. If an error is found, the critical component's LED stays lit up until the problem is solved.

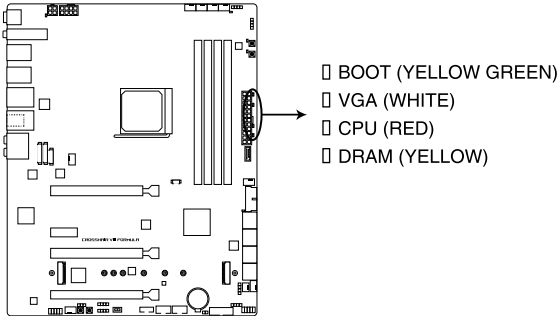

ROG CROSSHAIR VIII FORMULA Q LEDs



The Q LEDs provide the most probable cause of an error code as a starting point for troubleshooting. The actual cause may vary from case to case.

2. Storage Device Activity LED

The Storage Device Activity LED lights up or blinks when data is read from or written to the storage device or storage device add-on card.

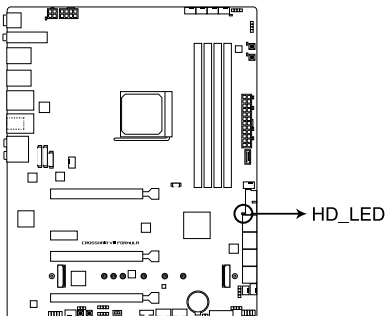

ROG CROSSHAIR VIII FORMULA Storage Device Activity LED

3. Start LED

The Start LED is designed to indicate the location of the START button.

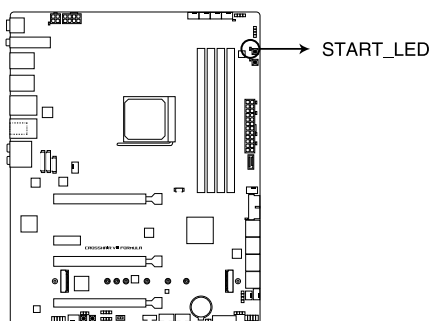

ROG CROSSHAIR VIII FORMULA START LED

4. Reset LED

The Reset LED is designed to indicate the location of the RESET button.

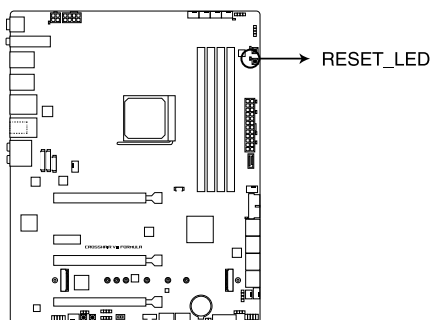

ROG CROSSHAIR VIII FORMULA RESET LED

5. 8-pin Power Plug LED

The 8-pin Power Plug LED lights up to indicate that the 8-pin power plug is not connected.

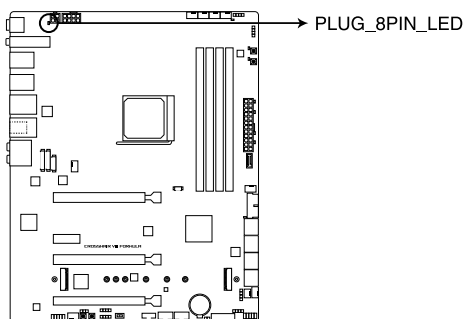

ROG CROSSHAIR VIII FORMULA 8-pin Power Plug LED



- DO NOT connect the 4-pin power plug only, the motherboard may overheat under heavy usage.
- Ensure to connect the 8-pin power plug, or connect both the 8-pin and 4-pin power plugs.

6. CPU Status LED

The CPU Status LED will indicate the current status of your CPU. A red light indicates that the CPU is not ready to boot, and the LED will turn off once the problem is solved.

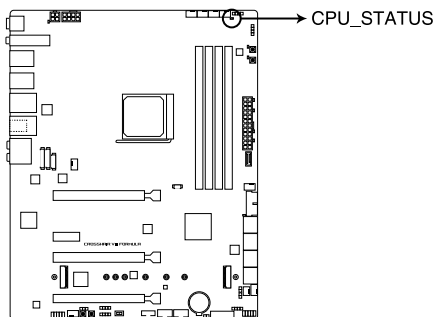

ROG CROSSHAIR VIII FORMULA CPU Status LED



Ensure the CPU Status LED is off before powering on your system.

1.1.10 Internal connectors

1. SATA 6Gb/s connector

The SATA 6Gb/s connector allows you to connect SATA devices such as optical disc drives and hard disk drives via a SATA cable.

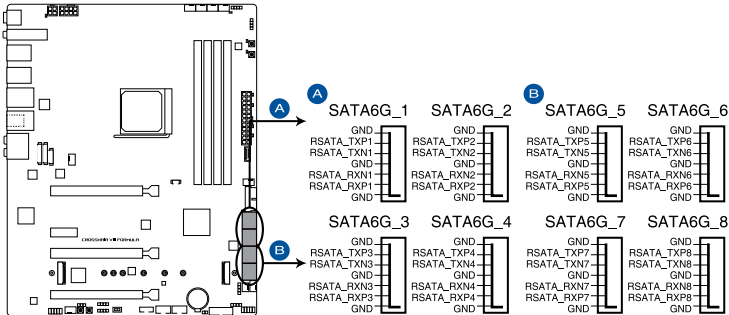

ROG CROSSHAIR VIII FORMULA SATA 6 Gb/s connector



If you installed SATA storage devices, you can create a RAID 0, 1, and 10 configuration through the onboard AMD X570 chipset.



- These connectors are set to **[AHCI]** by default. If you intend to create a Serial ATA RAID set using these connectors, set the SATA Mode Selection item in the BIOS to **[RAID]**.
- Before creating a RAID set, refer to the **RAID Configuration Guide**. You can download the **RAID Configuration Guide** from the ASUS website.

2. M.2 slot

The M.2 slot allows you to install M.2 devices such as M.2 SSD modules.

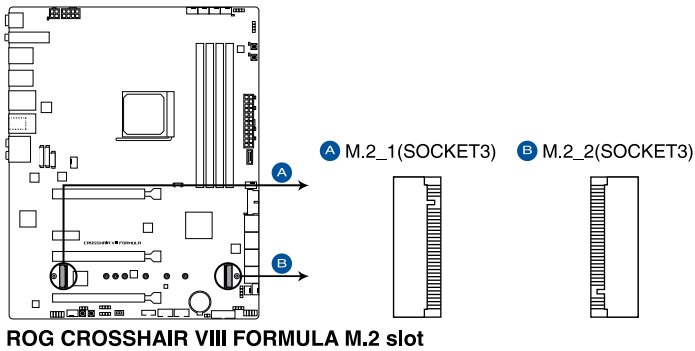

- For 3rd Gen AMD Ryzen™ Processors:
 - M.2_1 supports PCIe 4.0 x4 and SATA mode M Key design and type 2242 / 2260 / 2280 storage devices.
 - M.2_2 supports PCIe 4.0 x4 and SATA mode M Key design and type 2242 / 2260 / 2280 / 22110 storage devices.
- For 2nd Gen AMD Ryzen™ / 2nd and 1st Gen AMD Ryzen™ with Radeon™ Vega Graphics Processors:
 - M.2_1 supports PCIe 3.0 x4 and SATA mode M Key design and type 2242 / 2260 / 2280 storage devices.
 - M.2_2 supports PCIe 4.0 x4 and SATA mode M Key design and type 2242 / 2260 / 2280 / 22110 storage devices.



The M.2 SSD module is purchased separately.

3. Front Panel Audio connector

The front panel audio connector is for a chassis-mounted front panel audio I/O module that supports HD Audio. Connect one end of the front panel audio I/O module cable to this connector.

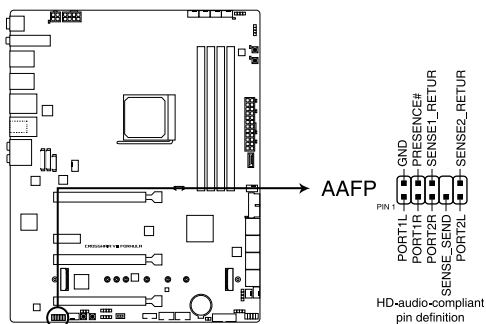

ROG CROSSHAIR VIII FORMULA Front Panel Audio connector



We recommend that you connect a high-definition front panel audio module to this connector to avail of the motherboard's high-definition audio capability.

4. USB 3.2 Gen 2 connector

The USB 3.2 Gen 2 connector allows you to connect a USB 3.2 Gen 2 module for additional USB 3.2 Gen 2 ports. The USB 3.2 Gen 2 connector provides data transfer speeds of up to 10 Gb/s.

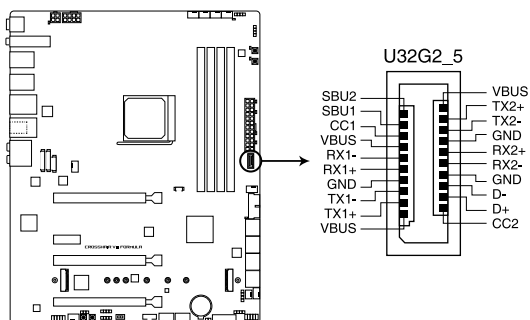

ROG CROSSHAIR VIII FORMULA USB 3.2 Gen 2 connector



The USB 3.2 Gen 2 module is purchased separately.

6. USB 2.0 connector

The USB 2.0 connector allows you to connect a USB module for additional USB 2.0 ports. The USB 2.0 connector provides data transfer speeds of up to 480 MB/s connection speed.

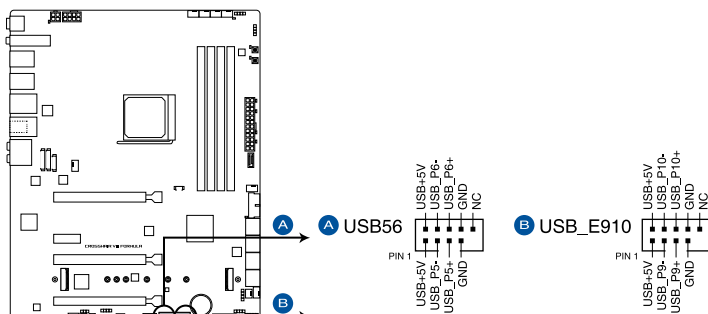

ROG CROSSHAIR VIII FORMULA USB 2.0 connector



DO NOT connect a 1394 cable to the USB connectors. Doing so will damage the motherboard!



The USB 2.0 module is purchased separately.

7. Fan and Pump connectors

The Fan and Pump connectors allow you to connect fans or pumps to cool the system.

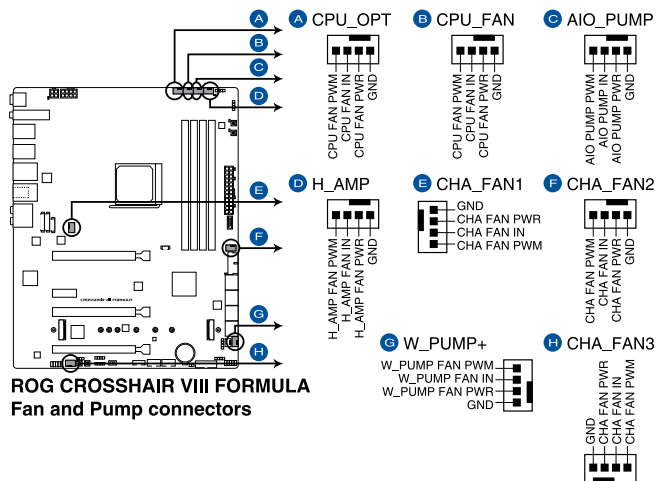

- DO NOT forget to connect the fan cables to the fan connectors. Insufficient air flow inside the system may damage the motherboard components. These are not jumpers! Do not place jumper caps on the fan connectors!
- Ensure the cable is fully inserted into the connector.



- For water cooling kits, connect the pump to the W_PUMP+ connector, and connect the fans to the CPU_FAN and CPU_OPT connectors.
- For All-In-One coolers, connect the pump to the AIO_PUMP connector, and connect the fans to the CPU_FAN and CPU_OPT connectors.
- For better Q-Fan functions, we recommend using 4-pin PWM fans when you connect powerful fans (1A or above) onto the H_AMP_FAN connector.
- Ensure to disable Q-Fan functions if you want to connect powerful 3-pin DC fans (1A or above) onto the H_AMP_FAN connector.

Header	Max. Current	Max. Power	Default Speed	Shared Control
CPU_FAN	1A	12W	Q-Fan Controlled	A
CPU_OPT	1A	12W	Q-Fan Controlled	A
CHA_FAN1	1A	12W	Q-Fan Controlled	-
CHA_FAN2	1A	12W	Q-Fan Controlled	-
CHA_FAN3	1A	12W	Q-Fan Controlled	-
H_AMP	3A	36W	Q-Fan Controlled	-
AIO_PUMP	1A	12W	Full-Speed	-
W_PUMP+	3A	36W	Full-Speed	-

8. Water Cooling System connectors

The Water Cooling System connectors allow you to connect sensors to monitor the temperature and flow rate of your water cooling system. You can manually adjust the fans and water pump to optimize the thermal efficiency of your water cooling system.

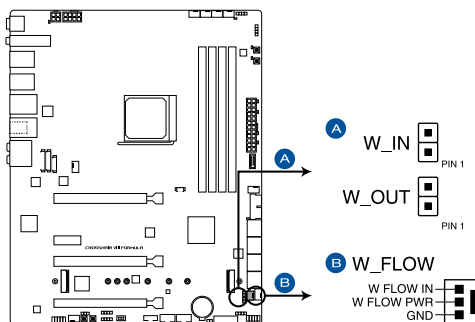

ROG CROSSHAIR VIII FORMULA Water Cooling System connectors

9. Thermal Sensor connector

The Thermal Sensor connector allows you to connect a sensor to monitor the temperature of the devices and the critical components inside the motherboard. Connect the thermal sensor and place it on the device or the motherboard's component to detect its temperature.

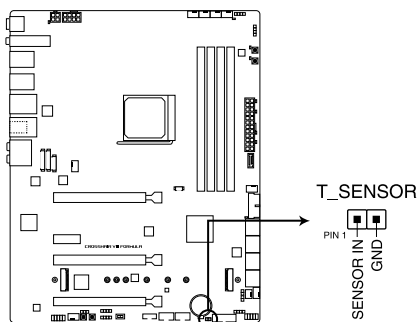

ROG CROSSHAIR VIII FORMULA Thermal Sensor connector



The thermal sensor is purchased separately.

10. Power connectors

These Power connectors allow you to connect your motherboard to a power supply. The power supply plugs are designed to fit in only one orientation, find the proper orientation and push down firmly until the power supply plugs are fully inserted.

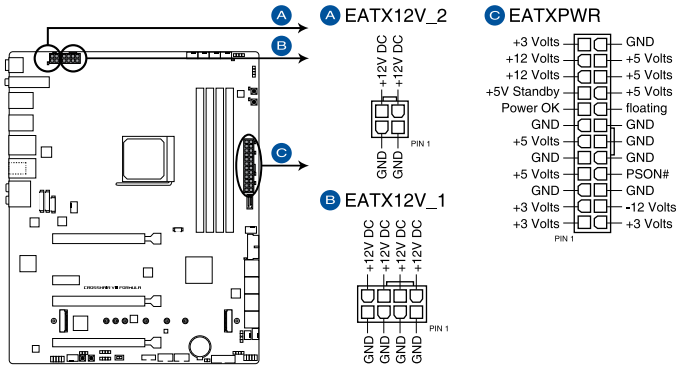

ROG CROSSHAIR VIII FORMULA Power connectors



- DO NOT connect the 4-pin power plug only, the motherboard may overheat under heavy usage.
- Ensure to connect the 8-pin power plug, or connect both the 8-pin and 4-pin power plugs.



- For a fully configured system, we recommend that you use a power supply unit (PSU) that complies with ATX 12V Specification 2.0 (or later version) and provides a minimum power of 350 W.
- We recommend that you use a PSU with a higher power output when configuring a system with more power-consuming devices. The system may become unstable or may not boot up if the power is inadequate.
- If you want to use two or more high-end PCI Express x16 cards, use a PSU with 1000W power or above to ensure the system stability.

11. System Panel connector

The System Panel connector supports several chassis-mounted functions.

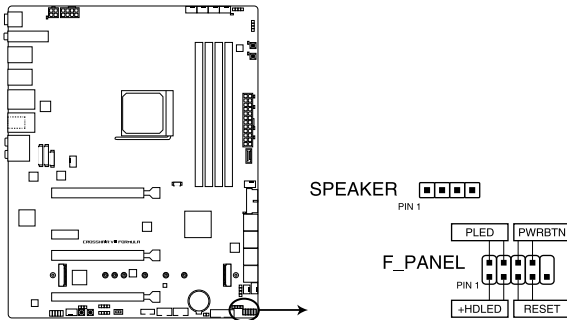

ROG CROSSHAIR VIII FORMULA System panel connector

- **System Power LED connector (PLED)**

The 2-pin connector allows you to connect the System Power LED. The System Power LED lights up when the system is connected to a power source, or when you turn on the system power, and blinks when the system is in sleep mode.

- **Storage Device Activity LED connector (HDLED)**

The 2-pin connector allows you to connect the Storage Device Activity LED. The Storage Device Activity LED lights up or blinks when data is read from or written to the storage device or storage device add-on card.

- **System Warning Speaker connector (SPEAKER)**

The 4-pin connector allows you to connect the chassis-mounted system warning speaker. The speaker allows you to hear system beeps and warnings.

- **Power Button/Soft-off Button connector (PWRBTN)**

The 3-1 pin connector allows you to connect the system power button. Press the power button to power up the system, or put the system into sleep or soft-off mode (depending on the operating system settings).

- **Reset button connector (RESET)**

The 2-pin connector allows you to connect the chassis-mounted reset button. Press the reset button to reboot the system.

12. RGB LED connector

The RGB LED connector allows you to connect RGB LED strips.

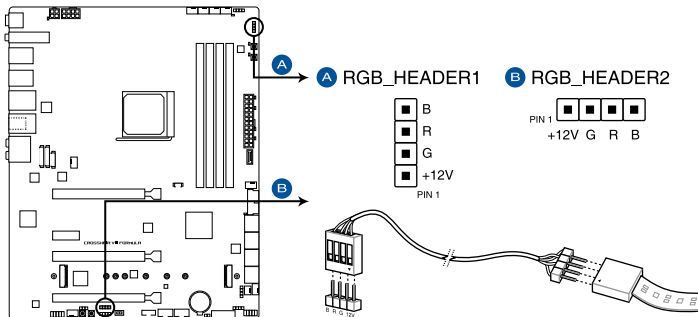

ROG CROSSHAIR VIII FORMULA AURA RGB LED connector



The RGB LED connector supports 5050 RGB multi-color LED strips (12V/G/R/B), with a maximum power rating of 3A (12V), and no longer than 3m.



Before you install or remove any component, ensure that the power supply is switched off or the power cord is detached from the power supply. Failure to do so may cause severe damage to the motherboard, peripherals, or components.



- Actual lighting and color will vary with LED strip.
- If your LED strip does not light up, check if the RGB LED extension cable and the RGB LED strip is connected in the correct orientation, and the 12V connector is aligned with the 12V header on the motherboard.
- The LED strip will only light up when the system is powered on.
- The LED strip is purchased separately.

13. Addressable Gen2 LED connector

The Addressable Gen2 LED connector allows you to connect individually addressable RGB WS2812B LED strips or WS2812B based LED strips.

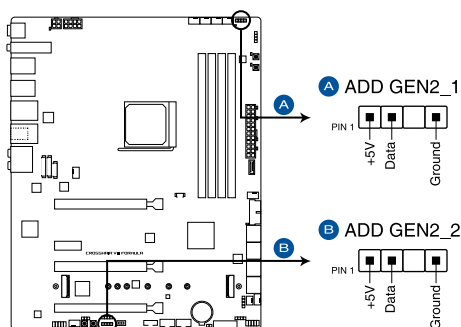

ROG CROSSHAIR VIII FORMULA Addressable RGB LED connector



The Addressable RGB LED connector supports WS2812B addressable RGB LED strips (5V/Data/Ground), with a maximum power rating of 3A (5V) and a maximum of 120 LEDs.



Before you install or remove any component, ensure that the power supply is switched off or the power cord is detached from the power supply. Failure to do so may cause severe damage to the motherboard, peripherals, or components.



- Actual lighting and color will vary with LED strip.
- If your LED strip does not light up, check if the addressable RGB LED strip is connected in the correct orientation, and the 5V connector is aligned with the 5V header on the motherboard.
- The addressable RGB LED strip will only light up when the system is powered on.
- The addressable RGB LED strip is purchased separately.

14. Rear I/O Cover LED connector

The Rear I/O Cover LED connector is for connecting the LEDs on your rear I/O cover.

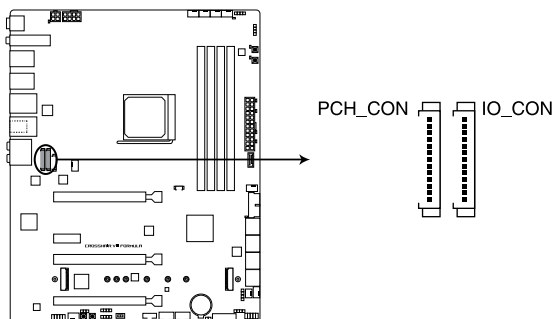

ROG CROSSHAIR VIII FORMULA Rear I/O Cover LED connector

15. PCH Fan connector

The PCH Fan connector is for connecting the PCH fan on your PCH cover.

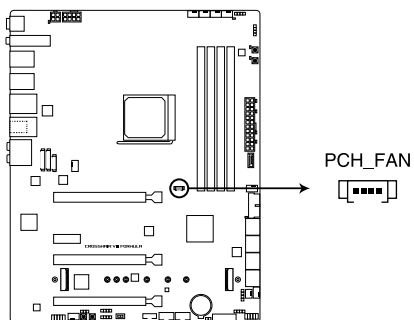

ROG CROSSHAIR VIII FORMULA PCH_FAN

16. OLED connector

The OLED connector allows you to connect the LiveDash OLED panel. The OLED panel provides you a quick overview of the system temperature, power status, and fan speeds when your system boots up.

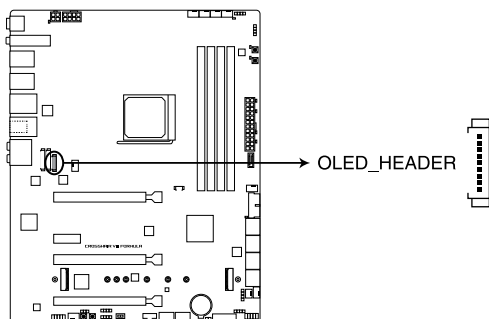

ROG CROSSHAIR VIII FORMULA OLED connector



- Use the **ROG LiveDash Utility** to configure and customize the LiveDash OLED panel.
- The LiveDash OLED displays a Q-Code that provides the most probable cause of an error code as a starting point for troubleshooting. The actual cause may vary from case to case.
- Please refer to the Q-Code table in the **Appendix** section for more details.

17. Node connector

The Node connector allows you to connect Node compatible devices.

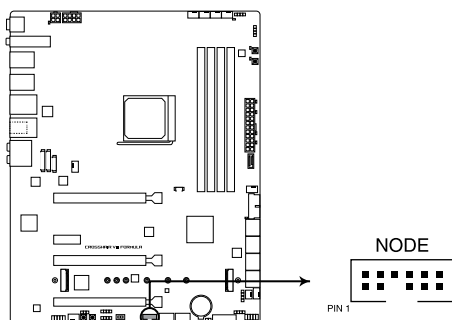

ROG CROSSHAIR VIII FORMULA Node connector



Visit www.asus.com for more information about the devices and the latest compatibility list.

Basic Installation

2

2.1 Building your PC system



The diagrams in this section are for reference only. The motherboard layout may vary with models, but the installation steps are the same for all models.

2.1.1 CPU installation



The AMD AM4 socket is compatible with AMD AM4 processors. Ensure you use a CPU designed for the AM4 socket. The CPU fits in only one correct orientation. **DO NOT** force the CPU into the socket to prevent bending the connectors on the socket and damaging the CPU!

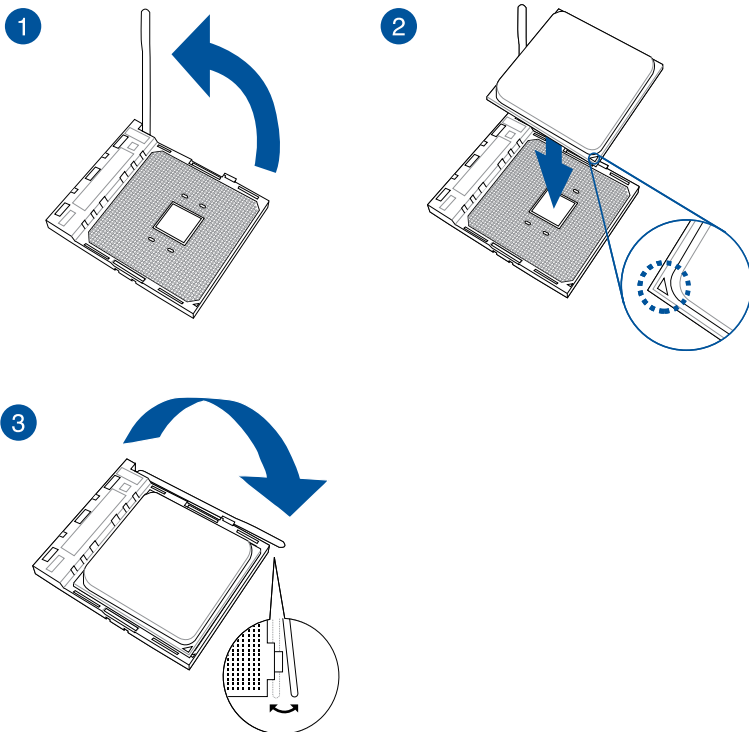

2.1.2 Cooling system installation



Apply the Thermal Interface Material to the CPU cooling system and CPU before you install the cooling system, if necessary.

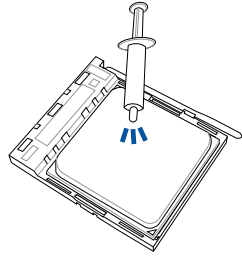

CPU heatsink and fan assembly Type 1

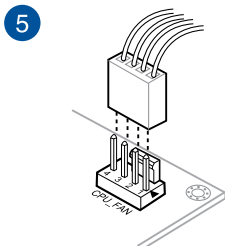
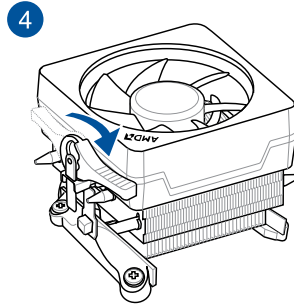
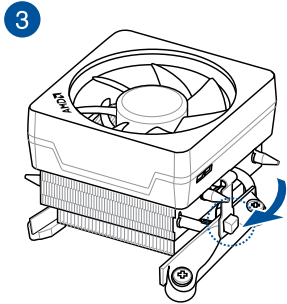
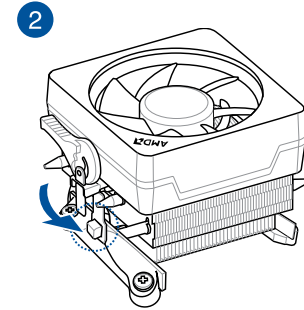
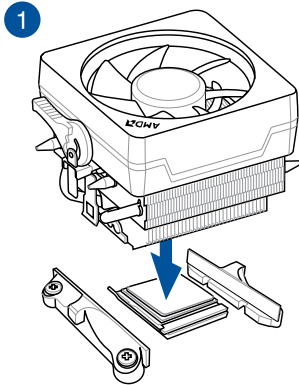

CPU heatsink and fan assembly Type 2

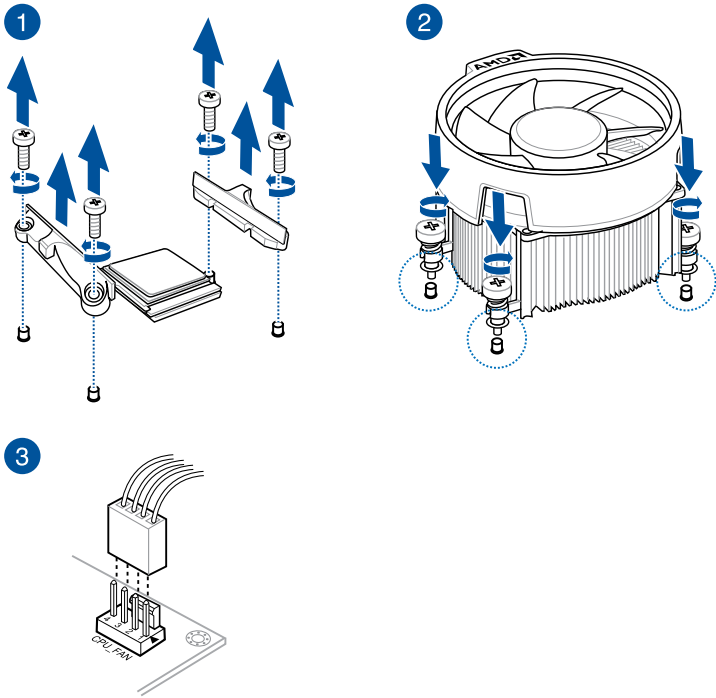

When using this type of CPU fan, remove the screws and the retention module only. Do not remove the plate on the bottom.

To install an AIO cooler

1

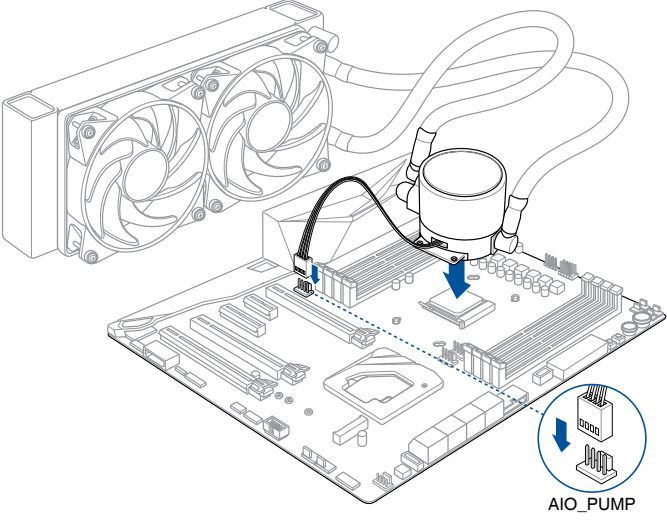

2

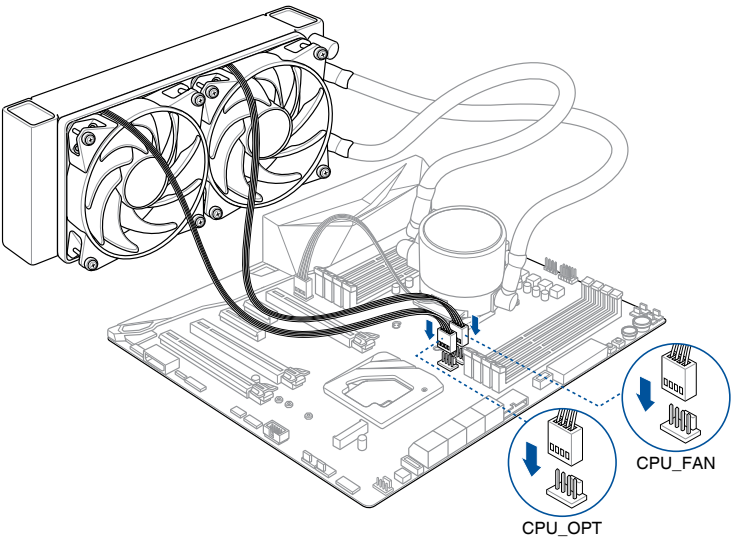

2.1.3 Motherboard installation

1. Place the motherboard into the chassis, ensuring that its rear I/O ports are aligned to the chassis' rear I/O panel.

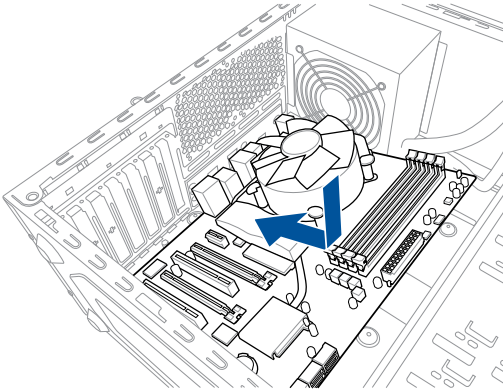

2. Place eight (8) screws into the holes indicated by circles to secure the motherboard to the chassis.

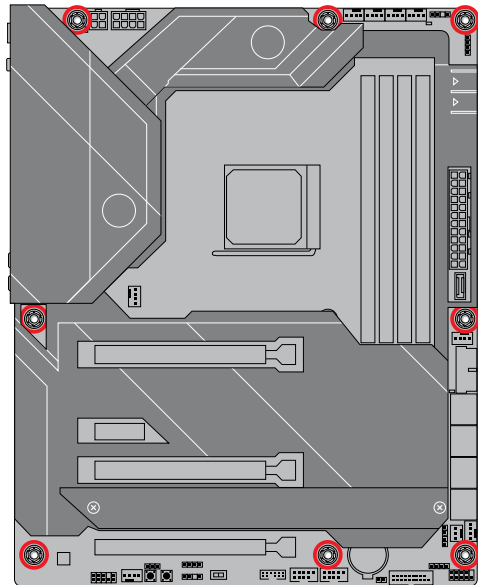
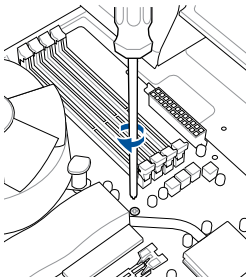

DO NOT over tighten the screws! Doing so can damage the motherboard.

2.1.4 DIMM installation

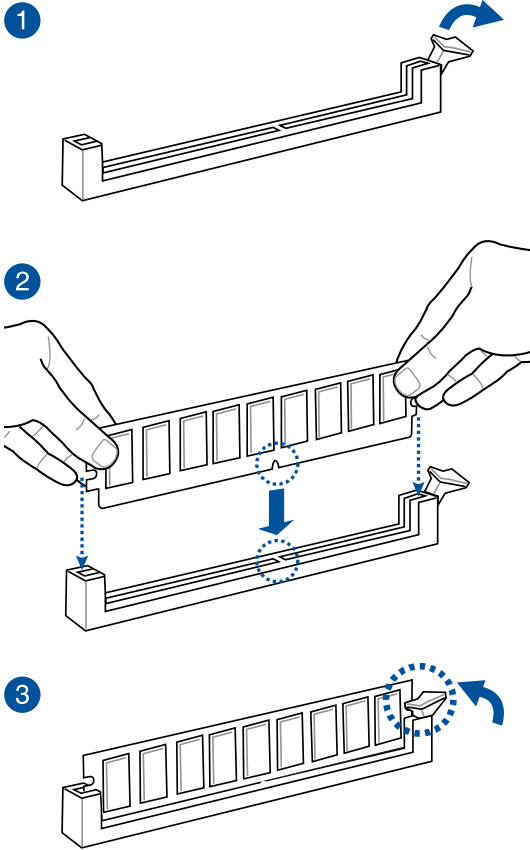

To remove a DIMM

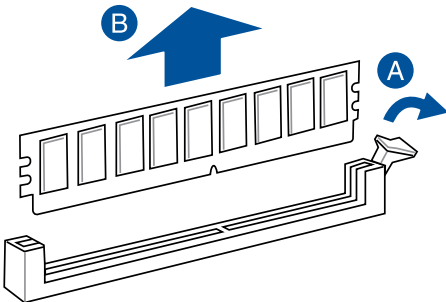

2.1.5 ATX power connection

1

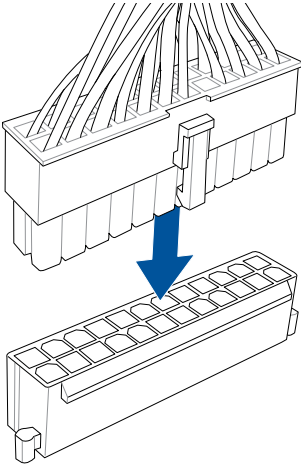

2

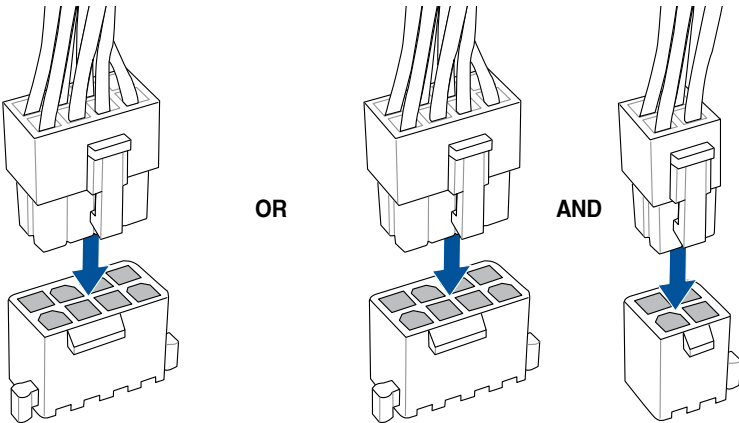

- DO NOT connect the 4-pin power plug only, the motherboard may overheat under heavy usage.
- Ensure to connect the 8-pin power plug, or connect both the 8-pin and 4-pin power plugs.

2.1.6 SATA device connection

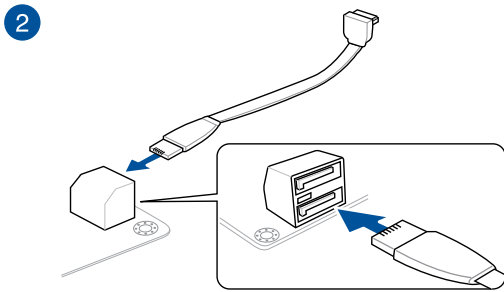
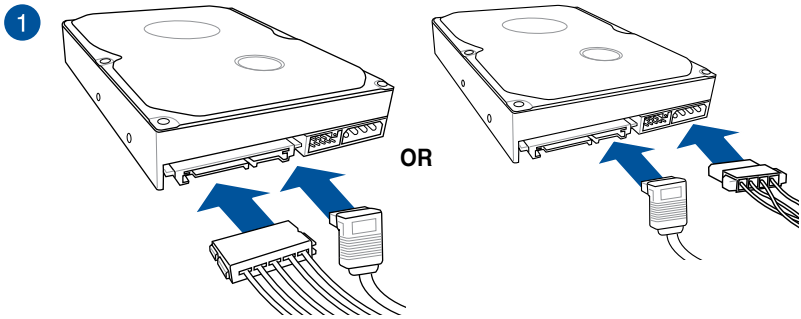

2.1.7 Front I/O connector

To install ASUS Q-Connector

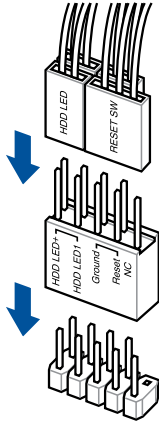

To install USB 3.2 Gen 2 connector

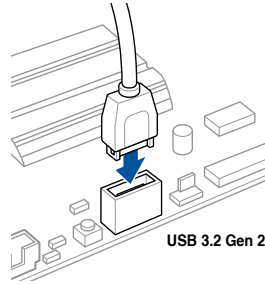

This connector will only fit in one orientation. Push the connector until it clicks into place.

To install USB 3.2 Gen 1 connector

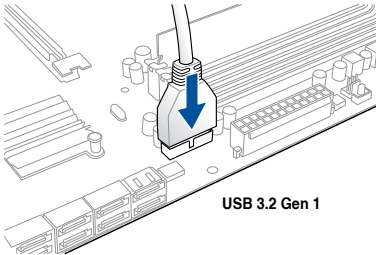

To install USB 2.0 connector

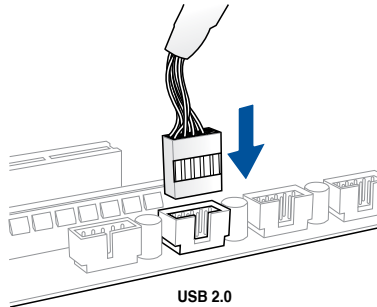

To install front panel audio connector

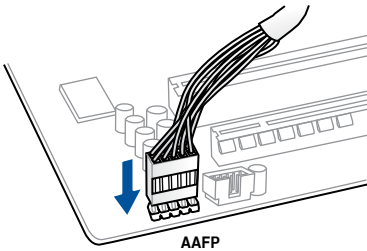

To install system speaker connector

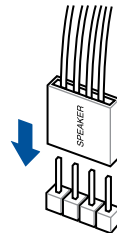

2.1.8 Expansion card installation

To install PCIe x16 cards

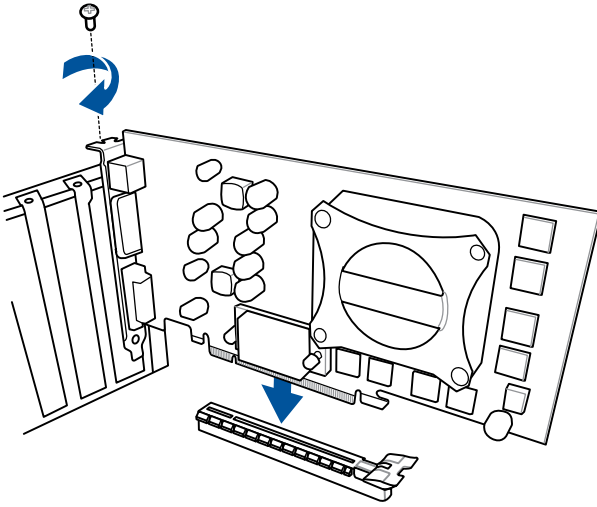

To install PCIe x1 cards

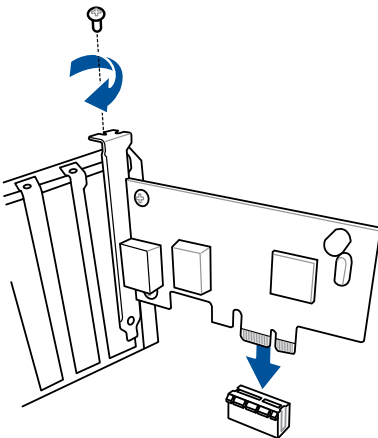

2.1.9 M.2 installation



Supported M.2 type varies per motherboard.

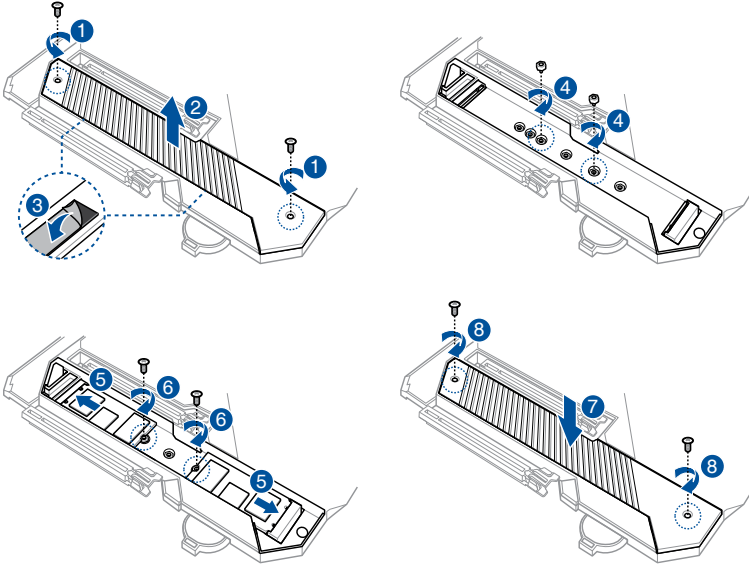

When a 22110 M.2 SSD is installed in M.2_2 Socket 3, M.2_1 Socket 3 will be limited to a 2242 M.2 SSD.

2.1.10 Wi-Fi antenna installation

Installing the ASUS 2x2 dual band W-Fi antenna

Connect the bundled ASUS 2x2 dual band Wi-Fi antenna connector to the Wi-Fi ports at the back of the chassis.

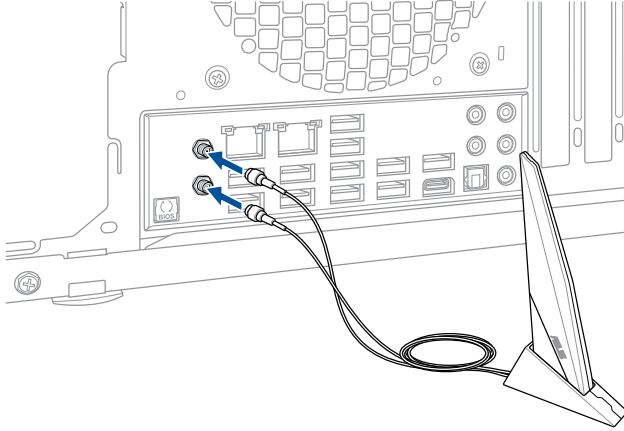

- Ensure that the ASUS 2x2 dual band Wi-Fi antenna is securely installed to the Wi-Fi ports.
- Ensure that the antenna is at least 20 cm away from all persons.



The illustration above is for reference only. The I/O port layout may vary with models, but the Wi-Fi antenna installation procedure is the same for all models.

2.2 BIOS update utility

USB BIOS Flashback

USB BIOS Flashback allows you to easily update the BIOS without entering the existing BIOS or operating system. Simply insert a USB storage device to the USB port, press the USB BIOS Flashback button for three seconds, and the BIOS is updated automatically.

To use USB BIOS Flashback:

1. Insert a USB storage device to the USB Flashback port.



We recommend you to use a USB 2.0 storage device to save the latest BIOS version for better compatibility and stability.

2. Visit <https://www.asus.com/support/> and download the latest BIOS version for this motherboard.
3. Rename the file as **C8F.CAP**, then copy it to your USB storage device.
4. Shut down your computer.
5. Press the BIOS Flashback button for three seconds until the Flashback LED blinks three times, indicating that the BIOS Flashback function is enabled.

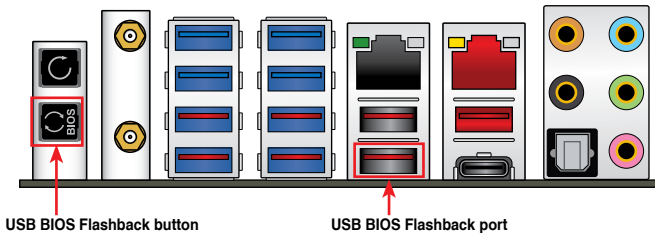

6. Wait until the light goes out, indicating that the BIOS updating process is completed.



For more BIOS update utilities in BIOS setup, refer to the section 3.11 **Updating BIOS** in Chapter 3.



- Do not unplug portable disk, power system, or press the CLR_CMOS button while BIOS update is ongoing, otherwise update will be interrupted. In case of interruption, please follow the steps again.
- If the light flashes for five seconds and turns into a solid light, this means that the BIOS Flashback is not operating properly. This may be caused by improper installation of the USB storage device and filename/file format error. If this scenario happens, please restart the system to turn off the light.
- Updating BIOS may have risks. If the BIOS program is damaged during the process and results to the system's failure to boot up, please contact your local ASUS Service Center.

2.3 Motherboard rear and audio connections

2.3.1 Rear I/O connection

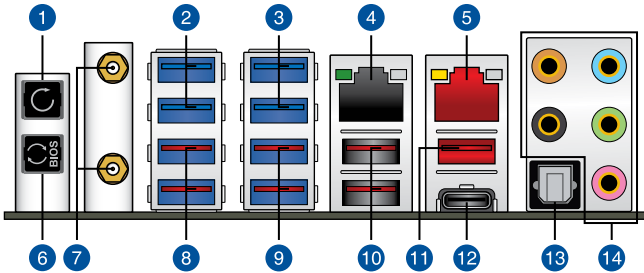

Rear panel connectors

- | | |
|-----|--|
| 1. | Clear CMOS button. Press this button to clear the BIOS setup information only when the system hangs due to overclocking. |
| 2. | USB 3.2 Gen 1 ports E1 and E2 |
| 3. | USB 3.2 Gen 1 ports E3 and E4 |
| 4. | 5G LAN (RJ-45) port* |
| 5. | LAN (RJ-45) port* |
| 6. | USB BIOS Flashback™ button |
| 7. | Wi-Fi 802.11 a/b/g/n/ac/ax, Bluetooth V5.0 |
| 8. | USB 3.2 Gen 2 Type-A ports 1 and 2 |
| 9. | USB 3.2 Gen 2 Type-A ports 3 and 4 |
| 10. | USB 3.2 Gen 2 Type-A ports 8 and 9 |
| 11. | USB 3.2 Gen 2 Type-A port 6 |
| 12. | USB 3.2 Gen 2 Type-C™ port C7 |
| 13. | Optical S/PDIF OUT port |
| 14. | Audio I/O ports** |

* and **: Refer to the tables on the next page for LAN port LEDs, and audio port definitions.



- USB 3.2 Gen 1/Gen 2 devices can only be used as data storage only.
- We strongly recommend that you connect your devices to ports with matching data transfer rate. Please connect your USB 3.2 Gen 1 devices to USB 3.2 Gen 1 ports and your USB 3.2 Gen 2 devices to USB 3.2 Gen 2 ports for faster and better performance for your devices.

*** LAN ports LED indications**

Activity Link LED		Speed LED	
Status	Description	Status	Description
OFF	No link	OFF	10 Mbps connection
ORANGE	Linked	ORANGE	100 Mbps connection
BLINKING	Data activity	GREEN	1 Gbps connection

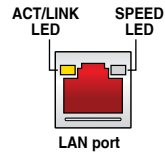

Aquantia AQC-111C 5G LAN port LED indications

Activity Link LED		Speed LED	
Status	Description	Status	Description
OFF	No link	OFF	100 Mbps connection
GREEN	Linked	GREEN	5 Gbps
BLINKING	Data activity	ORANGE	2.5 Gbps / 1 Gbps / 100 Mbps connection

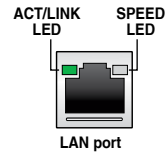

**** Audio 2, 4, 5.1 or 7.1-channel configuration**

Port	Headset 2-channel	4-channel	5.1-channel	7.1-channel
Light Blue	Line In	Line In	Line In	Side Speaker Out
Lime	Line Out	Front Speaker Out	Front Speaker Out	Front Speaker Out
Pink	Mic In	Mic In	Mic In	Mic In
Orange	–	–	Center/Sub woofer	Center/Sub woofer
Black	–	Rear Speaker Out	Rear Speaker Out	Rear Speaker Out

2.3.2 Audio I/O connections

Audio I/O ports

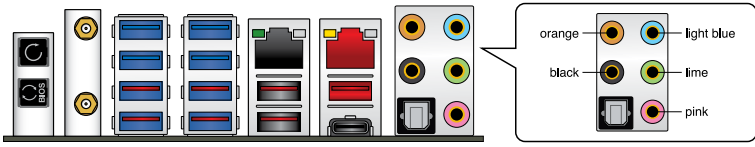

Connect to Headphone and Mic



Connect to Stereo Speakers

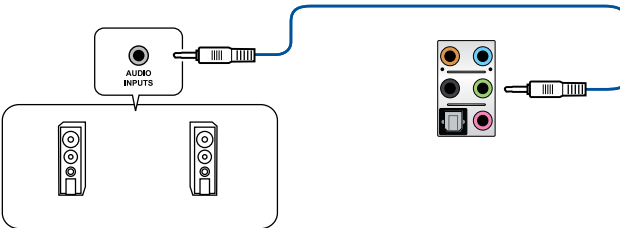

Connect to 2-channel Speakers

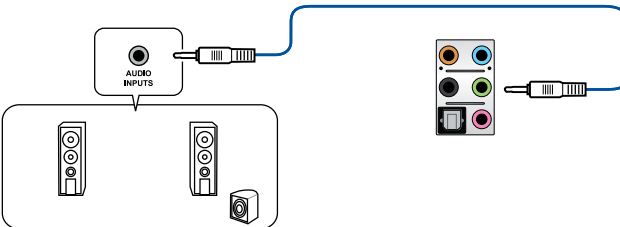

Connect to 4-channel Speakers

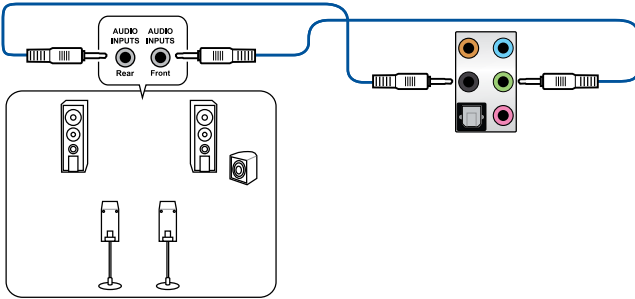

Connect to 5.1-channel Speakers

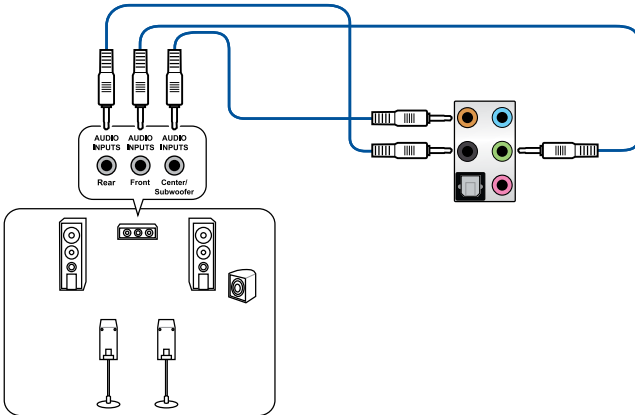

Connect to 7.1-channel Speakers

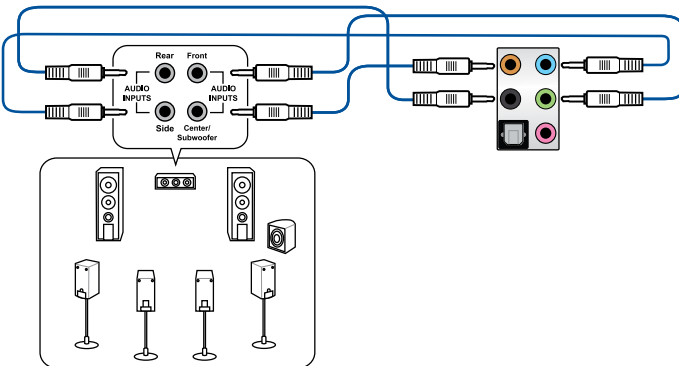

2.4 Starting up for the first time

1. After making all the connections, replace the system case cover.
2. Ensure that all switches are off.
3. Connect the power cord to the power connector at the back of the system chassis.
4. Connect the power cord to a power outlet that is equipped with a surge protector.
5. Turn on the devices in the following order:
 - a. Monitor
 - b. External SCSI devices (starting with the last device on the chain)
 - c. System power
6. After applying power, the system power LED on the system front panel case lights up. For systems with ATX power supplies, the system LED lights up when you press the ATX power button. If your monitor complies with the “green” standards or if it has a “power standby” feature, the monitor LED may light up or change from orange to green after the system LED turns on.

The system then runs the power-on self tests (POST). While the tests are running, the BIOS beeps (refer to the BIOS beep codes table) or additional messages appear on the screen. If you do not see anything within 30 seconds from the time you turned on the power, the system may have failed a power-on test. Check the jumper settings and connections or call your retailer for assistance.

BIOS Beep	Description
One short beep	VGA detected Quick boot set to disabled No keyboard detected
One continuous beep followed by two short beeps then a pause (repeated)	No memory detected
One continuous beep followed by three short beeps	No VGA detected
One continuous beep followed by four short beeps	Hardware component failure

7. At power on, hold down the <Delete> key to enter the BIOS Setup. Follow the instructions in Chapter 3.

2.5 Turning off the computer

While the system is ON, press the power button for less than four seconds to put the system on sleep mode or soft-off mode, depending on the BIOS setting. Press the power button for more than four seconds to let the system enter the soft-off mode regardless of the BIOS setting.

BIOS Setup

3

3.1 Knowing BIOS



The new ASUS UEFI BIOS is a Unified Extensible Interface that complies with UEFI architecture, offering a user-friendly interface that goes beyond the traditional keyboard-only BIOS controls to enable a more flexible and convenient mouse input. You can easily navigate the new UEFI BIOS with the same smoothness as your operating system. The term “BIOS” in this user manual refers to “UEFI BIOS” unless otherwise specified.

BIOS (Basic Input and Output System) stores system hardware settings such as storage device configuration, overclocking settings, advanced power management, and boot device configuration that are needed for system startup in the motherboard CMOS. In normal circumstances, the default BIOS settings apply to most conditions to ensure optimal performance. **DO NOT change the default BIOS settings** except in the following circumstances:

- An error message appears on the screen during the system bootup and requests you to run the BIOS Setup.
- You have installed a new system component that requires further BIOS settings or update.



Inappropriate BIOS settings may result to instability or boot failure. **We strongly recommend that you change the BIOS settings only with the help of a trained service personnel.**



When downloading or updating the BIOS file, rename it as **C8F.CAP** for this motherboard.

3.2 BIOS setup program

Use the BIOS Setup to update the BIOS or configure its parameters. The BIOS screen include navigation keys and brief onscreen help to guide you in using the BIOS Setup program.

Entering BIOS at startup

To enter BIOS Setup at startup, press <Delete> or <F2> during the Power-On Self Test (POST). If you do not press <Delete> or <F2>, POST continues with its routines.

Entering BIOS Setup after POST

To enter BIOS Setup after POST:

- Press <Ctrl>+<Alt>+<Delete> simultaneously.
- Press the reset button on the system chassis.
- Press the power button to turn the system off then back on. Do this option only if you failed to enter BIOS Setup using the first two options.

After doing either of the three options, press <Delete> key to enter BIOS.



-
- The BIOS setup screens shown in this section are for reference purposes only, and may not exactly match what you see on your screen.
 - Ensure that a USB mouse is connected to your motherboard if you want to use the mouse to control the BIOS setup program.
 - If the system becomes unstable after changing any BIOS setting, load the default settings to ensure system compatibility and stability. Select the **Load Optimized Defaults** item under the **Exit** menu or press hotkey <F5>. See section 3.10 **Exit Menu** for details.
 - If the system fails to boot after changing any BIOS setting, try to clear the CMOS and reset the motherboard to the default value. See section 2.3.1 **Rear I/O connection** for information on how to erase the RTC RAM via the Clear CMOS button.
 - The BIOS setup program does not support the Bluetooth devices.
-



Please visit ASUS website for the detailed BIOS content manual.

BIOS menu screen

The BIOS Setup program can be used under two modes: **EZ Mode** and **Advanced Mode**. You can change modes from **Setup Mode** in **Boot menu** or by pressing the <F7> hotkey.

3.2.1 Advanced Mode

The Advanced Mode provides advanced options for experienced end-users to configure the BIOS settings. The figure below shows an example of the Advanced Mode. Refer to the following sections for the detailed configurations.



The default screen for entering the BIOS setup program can be changed. Refer to the **Setup Mode** item in section **Boot menu** for details.

The screenshot shows the UEFI BIOS Advanced Mode interface. The top bar includes the date and time (05/07/2019, 13:18), language (English), and navigation icons for MyFavorite(F3), Qfan Control(F6), EZ Tuning Wizard(F11), Search(F9), and AURA ON/OFF(F4). The main menu bar contains My Favorites, Main, Extreme Tweaker, Advanced, Monitor, Boot, Tool, and Exit. The current page is 'Advanced', showing settings for LN2 Mode (Disabled), Target CPU Speed (3300MHz), Target DRAM Frequency (2133MHz), and Target FCLK Frequency (1066MHz). The 'AI Overclock Tuner' is set to 'Default', with a dropdown menu showing 'Auto', 'Default', and 'Manual'. Other settings include Memory Frequency, FCLK Frequency, Core Performance Boost (Auto), CPU Core Ratio, EPU Power Saving Mode (Disabled), TPU (Keep Current Settings), and Performance Bias (Auto). A 'Precision Boost Overdrive' section is partially visible. On the right, the 'Hardware Monitor' displays CPU (3300 MHz, 46°C), Memory (2133 MHz, 1.200 V), and Voltage (+12V, +5V, +3.3V, 3.248 V). The bottom status bar shows 'Version 2.20.1271. Copyright (C) 2019 American Megatrends, Inc.', 'Last Modified', 'EZMode(F7)', 'Hot Keys', and 'Search on FAQ'. Red lines and labels identify various UI elements: Configuration fields, Pop-up Menu, Menu bar, Language, MyFavorite(F3), Qfan Control(F6), EZ Tuning Wizard(F11), Search(F9), Scroll bar, AURA ON/OFF(F4), Menu items, General help, Last modified settings, Go back to EZ Mode, Hot Keys, Search on the FAQ, and a note that the Hardware Monitor displays a quick overview of the system status.

Menu bar

The menu bar on top of the screen has the following main items:

My Favorites	For saving the frequently-used system settings and configuration.
Main	For changing the basic system configuration
Extreme Tweaker	For changing the overclocking settings
Advanced	For changing the advanced system settings
Monitor	For displaying the system temperature, power status, and changing the fan settings.
Boot	For changing the system boot configuration
Tool	For configuring options for special functions
Exit	For selecting the exit options and loading default settings

Menu items

The highlighted item on the menu bar displays the specific items for that menu. For example, selecting **Main** shows the Main menu items.

The other items (**My Favorites**, **Ai Tweaker**, **Advanced**, **Monitor**, **Boot**, **Tool**, and **Exit**) on the menu bar have their respective menu items.

Submenu items

A greater than sign (>) before each item on any menu screen means that the item has a submenu. To display the submenu, select the item and press <Enter>.

Language

This button above the menu bar contains the languages that you can select for your BIOS. Click this button to select the language that you want to display in your BIOS screen.

My Favorites(F3)

This button above the menu bar shows all BIOS items in a Tree Map setup. Select frequently-used BIOS settings and save it to MyFavorites menu.



Refer to section **3.3 My Favorites** for more information.

Q-Fan Control(F6)

This button above the menu bar displays the current settings of your fans. Use this button to manually tweak the fans to your desired settings.



Refer to section **3.2.3 QFan Control** for more information.

EZ Tuning Wizard(F11)

This button above the menu bar allows you to view and tweak the overclocking settings of your system. It also allows you to change the motherboard's SATA mode from AHCI to RAID mode.



Refer to section **3.2.4 EZ Tuning Wizard** for more information.

Search (F9)

This button allows you to search for BIOS items by entering its name, enter the item name to find the related item listing.

AURA (F4)

This button allows you to turn the RGB LED lighting or functional LED on or off.

- [All On] All RGB LEDs and Functional LEDs will be enabled.
- [Stealth Mode] All RGB LEDs and Functional LEDs will be disabled.
- [Aura Only] RGB LEDs will be enabled, Functional LEDs will be disabled.
- [Aura Off] Functional LEDs will be enabled, RGB LEDs will be disabled.

Search on FAQ

Move your mouse over this button to show a QR code, scan this QR code on your mobile device to connect to the BIOS FAQ web page of the ASUS support website. You can also scan the following QR code:



Scroll bar

A scroll bar appears on the right side of a menu screen when there are items that do not fit on the screen. Press the Up/Down arrow keys or <Page Up> / <Page Down> keys to display the other items on the screen.

General help

At the bottom of the menu screen is a brief description of the selected item. Use <F12> key to capture the BIOS screen and save it to the removable storage device.

Configuration fields

These fields show the values for the menu items. If an item is user-configurable, you can change the value of the field opposite the item. You cannot select an item that is not user-configurable.

A configurable field is highlighted when selected. To change the value of a field, select it and press <Enter> to display a list of options.

Hot keys

This button contains the navigation keys for the BIOS setup program. Use the navigation keys to select items in the menu and change the settings.

Last Modified button

This button shows the items that you last modified and saved in BIOS Setup.

3.2.2 EZ Mode

The EZ Mode provides you an overview of the basic system information, and allows you to select the display language, system performance, mode and boot device priority. To access the Advanced Mode, select **Advanced Mode** or press the <F7> hotkey for the advanced BIOS settings.



To switch from Advanced Mode to EZ Mode, click **EZ Mode(F7)** or press the <F7> hotkey.

The screenshot shows the UEFI BIOS Utility in EZ Mode. The interface is dark-themed with red accents. At the top, it displays the date and time (05/07/2019, 13:12), language (English), and navigation options like EZ Tuning Wizard (F11), Search (F9), and AURA ON/OFF (F4). The main area is divided into several sections: Information (BIOS Ver: 0119, AMD 100-000000031-02, Speed: 3300 MHz, Memory: 4096 MB), DRAM Status (DIMM_A1, A2, B1, B2), D.O.C.P. (Disabled), FAN Profile (CPU FAN at 3349 RPM, CHA1, CHA2, CHA3, PCH, HAMP, EXT), CPU Temperature (46°C), CPU Core Voltage (1.353 V), Motherboard Temperature (33°C), Storage Information, EZ System Tuning (Normal), and Boot Priority (Switch all). A CPU FAN speed graph is also visible. At the bottom, there are buttons for Default (F5), Save & Exit (F10), Advanced Mode (F7), and Search on FAQ.

Annotations on the screenshot include:

- Displays a quick overview of the system status**: Points to the Information section.
- Creates storage RAID and configures system overlocking**: Points to the Storage Information section.
- Selects the display language of the BIOS setup program**: Points to the English language selection.
- Search (F9)**: Points to the Search (F9) button.
- AURA ON/OFF (F4)**: Points to the AURA ON/OFF (F4) button.
- Displays the system properties of the selected mode. Click < > to switch EZ System Tuning modes**: Points to the EZ System Tuning section.
- Displays the CPU Fan's speed. Click the button to manually tune the fans**: Points to the CPU FAN speed and the QFan Control button.
- Saves the changes and resets the system**: Points to the Save & Exit (F10) button.
- Click to go to Advanced mode**: Points to the Advanced Mode (F7) button.
- Search on the FAQ**: Points to the Search on FAQ button.
- Click to display boot devices**: Points to the Boot Menu (F8) button.
- Selects the boot device priority**: Points to the Boot Priority section.
- Loads optimized default settings**: Points to the Default (F5) button.



The boot device options vary depending on the devices you installed to the system.

3.2.3 Q-Fan Control

The QFan Control allows you to set a fan profile or manually configure the operating speed of your CPU and chassis fans.

The screenshot shows the Q-Fan Control interface. At the top, it says "Q-Fan Control" and "Select your target fan and then move the slider to select any of these profiles: Standard, Silent, Turbo and Full Speed). You can also move the slider to Manual and manually configure the fan's operating speed." Below this is a list of fans: CPU FAN, CHA1 FAN, CHA2 FAN, CHA3 FAN, HAMP FAN, PCH FAN, EXT FAN1, EXT FAN2, EXT FAN3, EXT FAN4, EXT FAN5. A graph shows fan speed (%) vs temperature (°C) with a yellow line representing the profile. Below the graph are radio buttons for Standard, Silent, Turbo, Full Speed, and Manual. At the bottom are buttons for Undo, Apply, and Exit (ESC). Annotations with red lines point to various elements:

- Click to select a fan to be configured (points to the fan list)
- Click to activate PWM Mode (points to the PWM button)
- Click to activate DC Mode (points to the DC button)
- Select a profile to apply to your fans (points to the radio buttons)
- Click to apply the fan setting (points to the Apply button)
- Click to undo the changes (points to the Undo button)
- Click to go back to main menu (points to the Exit (ESC) button)
- Select manually configure your fans (points to the Manual radio button)

Configuring fans manually

Select **Manual** from the list of profiles to manually configure your fans' operating speed.

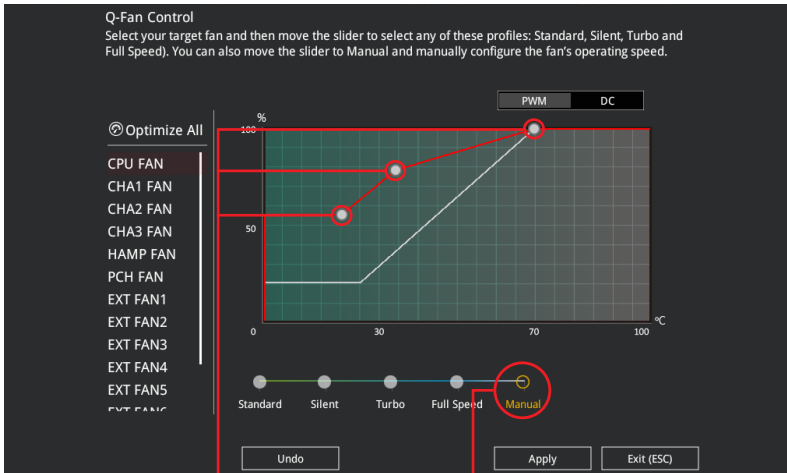

Speed points

Select to manually
configure your fans

To configure your fans:

1. Select the fan that you want to configure and to view its current status.
2. Click and drag the speed points to adjust the fans' operating speed.
3. Click **Apply** to save the changes then click **Exit (ESC)**.

3.2.4 EZ Tuning Wizard

EZ Tuning Wizard allows you to easily overclock your CPU and DRAM, computer usage, and CPU fan to their best settings.

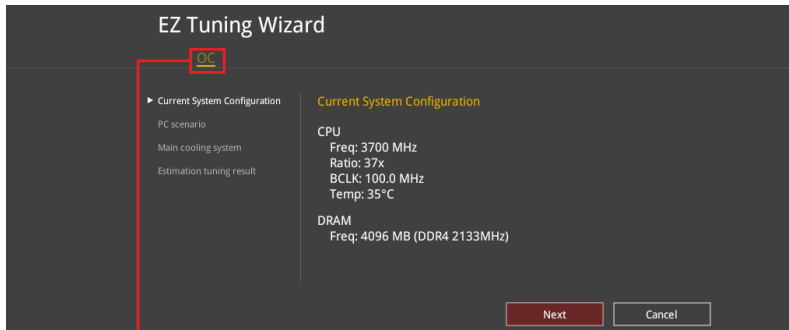

OC Setup

OC Tuning

To start OC Tuning:

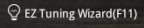
1. Press <F11> on your keyboard or click  from the BIOS screen to open EZ Tuning Wizard screen.
2. Click **OC** then click **Next**.
3. Select a PC scenario **Daily Computing** or **Gaming/Media Editing**, then click **Next**.

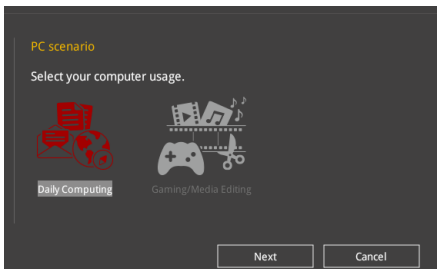

4. Select a Main Cooling System **BOX cooler**, **Tower cooler**, **Water cooler**, or **I'm not sure**, then click **Next**.

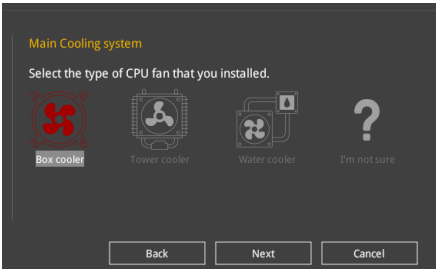

5. After selecting the Main Cooling System, click **Next** then click **Yes** to start the OC Tuning.

3.3 My Favorites

My Favorites is your personal space where you can easily save and access your favorite BIOS items.





My Favorites comes with several performance, power saving, and fast boot related items by default. You can personalize this screen by adding or removing items.

Adding items to My Favorites

To add BIOS items:

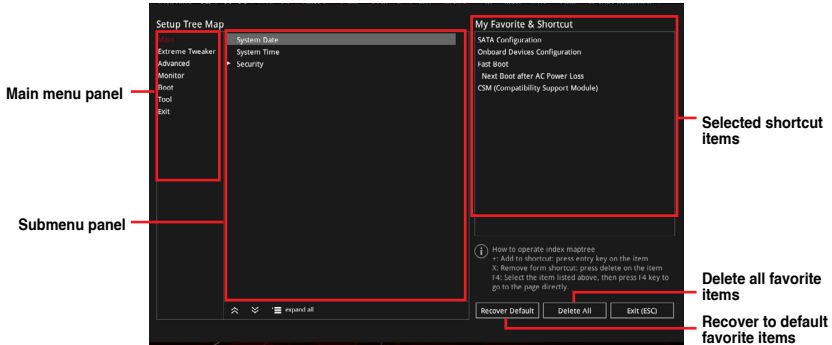
1. Press <F3> on your keyboard or click  (F3)MyFavorite from the BIOS screen to open Setup Tree Map screen.
2. On the Setup Tree Map screen, select the BIOS items that you want to save in My Favorites screen.



3. Select an item from main menu panel, then click the submenu that you want to save as favorite from the submenu panel and click  or press <Enter> on your keyboard.



You cannot add the following items to My Favorite items:

- Items with submenu options
- User-managed items such as language and boot order
- Configuration items such as Memory SPD Information, system time and date.

4. Click **Exit (ESC)** or press <Esc> key to close Setup Tree Map screen.
5. Go to My Favorites menu to view the saved BIOS items.

3.4 Main menu

The Main menu screen appears when you enter the Advanced Mode of the BIOS Setup program. The Main menu provides you an overview of the basic system information, and allows you to set the system date, time, language, and security settings.

Security

The Security menu items allow you to change the system security settings.



- If you have forgotten your BIOS password, erase the CMOS Real Time Clock (RTC) RAM to clear the BIOS password. See section 1.1.6 **Onboard buttons and switches** for information on how to erase the RTC RAM via the Clear CMOS button.
- The Administrator or User Password items on top of the screen show the default **[Not Installed]**. After you set a password, these items show **[Installed]**.

3.5 Extreme Tweaker menu

The Extreme Tweaker menu items allow you to configure overclocking-related items.



Be cautious when changing the settings of the Extreme Tweaker menu items. Incorrect field values can cause the system to malfunction



The configuration options for this section vary depending on the CPU and DIMM model you installed on the motherboard.

Ai Overclock Tuner

Allows you to select the CPU overclocking options to achieve the desired CPU internal frequency. Configuration options:

- | | |
|-----------|---|
| [Auto] | Loads the optimal settings for the system. |
| [Default] | Loads the default settings for the system. |
| [Manual] | Allows you to individually set overclocking parameters. |



The following item appears only when you set the Ai Overclocking Tuner to **[Manual]**.

BCLK Frequency

This item allows you to set the BCLK frequency to enhance the system performance. Use the <+> or <-> to adjust the value.



We recommend you to set the value based on the CPU specification, as high BCLK frequencies may damage the CPU permanently.

Memory Frequency

This item allows you to set the memory operating frequency. The configurable options vary with the BCLK (base clock) frequency setting. Select the auto mode to apply the optimized setting.

Configuration options: [Auto] [DDR4-1333MHz] - [DDR4-5000MHz]

TPU

This item allows you to automatically overclock the CPU and DRAM frequencies and voltage for an enhanced system performance.

[Keep Current Settings] Keep the current settings without changing anything.

[TPU I] Applies air cooling overclocking conditions.

[TPU II] Applies water cooling overclocking conditions.



Ensure to use water cooling device before selecting [TPU II].

3.6 Advanced menu

The Advanced menu items allow you to change the settings for the CPU and other system devices.



Be cautious when changing the settings of the Advanced menu items. Incorrect field values can cause the system to malfunction.

3.6.1 AMD fTPM configuration

The items in this menu show the AMD fTPM configuration options.

TPM Device Selection

This item allows you to enable or disable AMD CPU fTPM.

Configuration options: [Firmware TPM] [Discrete TPM]



When Firmware TPM is set to disabled all saved data on it will be lost.

3.6.2 CPU Configuration

The items in this menu show the CPU-related information that the BIOS automatically detects.



The items in this menu may vary based on the CPU installed.

PSS Support

This item allows you enable or disable the generation of ACPI_PPC, _PSS, and _PCT objects.

Configuration options: [Disabled] [Enabled] [Auto]

NX Mode

This item allows you enable or disable no-execute page protection function.

Configuration options: [Disabled] [Enabled]

SVM Mode

This item allows you enable or disable CPU virtualization.

Configuration options: [Disabled] [Enabled]

3.6.3 SATA Configuration

While entering Setup, the BIOS automatically detects the presence of SATA devices. The SATA Port items show **Not Present** if no SATA device is installed to the corresponding SATA port.

SATA0 Enable

This item allows you to enable or disable the SATA Device.

Configuration options: [Disabled] [Enabled]

SATA1 Enable

This item allows you to enable or disable the SATA Device.

Configuration options: [Disabled] [Enabled]

SATA Mode

This item allows you to set the SATA configuration.

- [AHCI] Set to [AHCI] when you want the SATA hard disk drives to use the AHCI (Advanced Host Controller Interface). The AHCI allows the onboard storage driver to enable advanced Serial ATA features that increases storage performance on random workloads by allowing the drive to internally optimize the order of commands.
- [RAID] Set to [RAID] when you want to create a RAID configuration from the SATA hard disk drives.

SMART Self Test

S.M.A.R.T. (Self-Monitoring, Analysis and Reporting Technology) is a monitoring system that shows a warning message during POST (Power-on Self Test) when an error occurs in the hard disks.

Configuration options: [On] [Off]

SATA6G_1(Gray) - SATA6G_8(Gray)

SATA6G_1 - SATA6G_8

This item allows you to enable or disable the selected SATA port.

Configuration options: [Disabled] [Enabled]

Hot Plug

These items appears only when the **SATA Mode** is set to [AHCI] and allows you to enable or disable SATA Hot Plug Support.

Configuration options: [Disabled] [Enabled]

3.6.4 Onboard Devices Configuration

The items in this menu allow you to switch between PCIe Lanes and configure onboard devices.

HD Audio Controller

This item allows you to use the Azalia High Definition Audio Controller

Configuration options: [Disabled] [Enabled]

PCIEX16_2 Bandwidth

[X8 Mode] Run at x8 mode.

[PCIe RAID Mode] Run at x4+x4 mode to create a RAID array for up to 2 PCIe devices.



Use [PCIe RAID Mode] only when installing the Hyper M.2 x16 card or other M.2 adapter cards. Installing other devices when using this mode may cause your PC to fail to boot.

RGB LED lighting

When system is in working state

[All On] All RGB LEDs and Functional LEDs will be enabled.

[Stealth Mode] All RGB LEDs and Functional LEDs will be disabled.

[Aura Only] RGB LEDs will be enabled, Functional LEDs will be disabled.

[Aura Off] Functional LEDs will be enabled, RGB LEDs will be disabled.

When system is in sleep, hibernate or soft off states

[All On] All RGB LEDs and Functional LEDs will be enabled.

[Stealth Mode] All RGB LEDs and Functional LEDs will be disabled.

[Aura Only] RGB LEDs will be enabled, Functional LEDs will be disabled.

[Aura Off] Functional LEDs will be enabled, RGB LEDs will be disabled.

5G LAN Card

This item allows you to enable or disable the Realtek 5G LAN Card.
Configuration options: [On] [Off]

Intel LAN Controller

This item allows you to enable or disable the Intel LAN controller.
Configuration options: [On] [Off]

Wi-Fi 6 (802.11ax) Controller

This item allows you to enable or disable the Wi-Fi 6 (802.11ax) Controller.
Configuration options: [Disabled] [Enabled]

Bluetooth Controller

This item allows you to enable or disable the Intel Bluetooth controller.
Configuration options: [Disabled] [Enabled]

PCIEX16/X8_1 Mode

This item allows you to set the link speed for PCIEX16/X8_1 slot.
Configuration options: [Auto] [GEN 1] [GEN 2] [GEN 3] [GEN 4]

PCIEX8/X4_2 Mode

This item allows you to set the link speed for PCIEX8/X4_2 slot.
Configuration options: [Auto] [GEN 1] [GEN 2] [GEN 3] [GEN 4]

PCIEX4_3 Mode

This item allows you to set the link speed for PCIEX4_3 slot.
Configuration options: [Auto] [GEN 1] [GEN 2] [GEN 4]

M.2_1 Link Mode

This item allows you to set the link speed for M.2_1 Device.
Configuration options: [Auto] [GEN 1] [GEN 2] [GEN 3] [GEN 4]

M.2_2 Link Mode

This item allows you to set the link speed for M.2_2 Device.
Configuration options: [Auto] [GEN 1] [GEN 2] [GEN 3] [GEN 4]

SB Link Mode

This item allows you to set the link speed for Southbridge.
Configuration options: [Auto] [GEN 1] [GEN 2] [GEN 3] [GEN 4]

3.6.5 APM Configuration

The items in this menu allow you to set system wake and sleep settings.

ErP Ready

This item allows you to switch off some power at S4+S5 or S5 to get the system ready for ErP requirement. When set to **[Enabled]**, all other PME options are switched off.

Configuration options: [Disabled] [Enable(S4+S5)] [Enable(S5)]

Restore On AC Power Loss

This item allows your system to go to ON state, OFF state, or both states after an AC power loss. When setting your system to [Last State], it goes to the previous state before the AC power loss.

Configuration options: [Power Off] [Power On] [Last State]

Power On By PCI-E/PCI

This item allows you to enable or disable the Wake-on-LAN function of the onboard LAN controller or other installed PCI-E LAN cards.

Configuration options: [Disabled] [Enabled]

Power On By RTC

This item allows you to enable or disable the RTC (Real-Time Clock) to generate a wake event and configure the RTC alarm date. When enabled, you can set the days, hours, minutes, or seconds to schedule an RTC alarm date.

Configuration options: [Disabled] [Enabled]

3.6.6 PCI Subsystem Settings

Allows you to configure PCI, PCI-X, and PCI Express Settings.

SR-IOV Support

This option enables or disables Single Root IO Virtualization Support if the system has SR-IOV capable PCIe devices.

Configuration options: [Disabled] [Enabled]

3.6.7 USB Configuration

The items in this menu allow you to change the USB-related features.



The **Mass Storage Devices** item shows the auto-detected values. If no USB device is detected, the item shows **None**.

Legacy USB Support

- [Enabled] Your system supports the USB devices in legacy operating systems.
- [Disabled] Your USB devices can be used for BIOS setup only and cannot be recognized in the boot devices list.
- [Auto] Your system automatically detects the presence of USB devices at startup. If any USB devices are detected, the legacy USB support is enabled.

XHCI Hand-off

- [Enabled] Enables the support for operating systems without an XHCI hand-off feature.
- [Disabled] Disables the XHCI Hand-off support.

USB Device Enable

This item allows you to enable or disable USB device support.

Configuration options: [Disabled] [Enabled]

USB Single Port Control

This item allows you to enable or disable the individual USB ports.



Refer to section 1.1.2 **Motherboard layout** for the location of the USB ports.

3.6.8 HDD/SSD SMART Information

This menu displays the SMART information of the connected devices.

3.6.9 Network Stack Configuration

The items in this menu allow you to enable or disable the UEFI network stack

3.6.10 AMD CBS

The items in this menu display the CPU-related information that the BIOS automatically detects.

3.6.11 AMD PBS

The items in this menu display the CPU-related information that the BIOS automatically detects.

3.7 Monitor menu

The Monitor menu displays the system temperature/power status, and allows you to change the fan settings.

Scroll down to display the other BIOS items.

Q-fan Configuration

Qfan Tuning

Click this item to automatically detect the lowest speed and configure the minimum duty cycle for each fan.

W_PUMP+/AIO PUMP Control

- | | |
|------------|--|
| [Disabled] | Disable the Water Pump control feature. |
| [Auto] | Detects the type of water pump installed and automatically switches the control modes. |
| [DC mode] | Enable the Water Pump control in DC mode for 3-pin chassis fan. |
| [PWM mode] | Enable the Water Pump control in PWM mode for 4-pin chassis fan. |

3.8 Boot menu

The Boot menu items allow you to change the system boot options.

Boot Configuration

Fast Boot

[Disabled]

Allows your system to go back to its normal boot speed.

[Enabled]

Allows your system to accelerate the boot speed.



The following item appears only when you set the Fast Boot to **[Enabled]**.

Next Boot after AC Power Loss

[Normal Boot]

Returns to normal boot on the next boot after an AC power loss.

[Fast Boot]

Accelerates the boot speed on the next boot after an AC power loss.

Setup Mode

[Advanced Mode]

This item allows you to go to Advanced Mode of the BIOS after POST.

[EZ Mode]

This item allows you to go to EZ Mode of the BIOS after POST.

CSM (Compatibility Support Module)

This item allows you to configure the CSM (Compatibility Support Module) items to fully support the various VGA, bootable devices and add-on devices for better compatibility.

Launch CSM

[Auto]

The system automatically detects the bootable devices and the add-on devices.

[Enabled]

For better compatibility, enable the CSM to fully support the non-UEFI driver add-on devices or the Windows® UEFI mode.

[Disabled]

Disable the CSM to fully support the non-UEFI driver add-on devices or the Windows® UEFI mode.



The following items appear only when you set the **Launch CSM** to **[Enabled]**.

Boot Devices Control

This item allows you to select the type of devices that you want to boot.

Configuration options: [UEFI and Legacy OPROM] [Legacy OPROM only] [UEFI only]

Boot from Network Devices

This item allows you to select the type of network devices that you want to launch.

Configuration options: [Ignore] [Legacy only] [UEFI driver first]

Boot from Storage Devices

This item allows you to select the type of storage devices that you want to launch.

Configuration options: [Ignore] [Legacy only] [UEFI driver first]

Boot from PCI-E/PCI Expansion Devices

This item allows you to select the type of PCI-E/PCI expansion devices that you want to launch.

Configuration options: [Legacy only] [UEFI driver first]

Secure Boot

This item allows you to configure the Windows® Secure Boot settings and manage its keys to protect the system from unauthorized access and malwares during POST.

Boot Option Priorities

These items specify the boot device priority sequence from the available devices. The number of device items that appears on the screen depends on the number of devices installed in the system.



- To access Windows® OS in Safe Mode, press <F8> after POST (Windows® 8 not supported).
- To select the boot device during system startup, press <F8> when the ASUS Logo appears.

Boot Override

These items displays the available devices. The number of device items that appears on the screen depends on the number of devices installed in the system. Click an item to start booting from the selected device.

3.9 Tool menu

The Tool menu items allow you to configure options for special functions. Select an item then press <Enter> to display the submenu.

Setup Animator

This item allows you to enable or disable the Setup animator.

Configuration options: [Enabled] [Disabled]

3.9.1 ASUS EZ Flash 3 Utility

This item allows you to run ASUS EZ Flash 3. When you press <Enter>, a confirmation message appears. Use the left/right arrow key to select between [Yes] or [No], then press <Enter> to confirm your choice.



For more details, refer to section 3.11.2 **ASUS EZ Flash 3**.

3.9.2 ASUS Secure Erase

SSD speeds may lower over time as with any storage medium due to data processing. ASUS Secure Erase completely and safely cleans your SSD, restoring it to factory performance levels.

To launch ASUS Secure Erase, click **Tool > ASUS Secure Erase** on the Advanced mode menu.



Check the ASUS support site for a full list of SSDs tested with ASUS Secure Erase. The drive may become unstable if you run ASUS Secure Erase on an incompatible SSD.



The time to erase the contents of your SSD may take a while depending on its size. Do not turn off the system during the process.

Displays the available SSDs



Port #	SSD Name	Status	Total Capacity
P2	ADATA S596 Turbo	Frozen	64.0GB



Status definition:

- **Frozen.** The frozen state is the result of a BIOS protective measure. The BIOS guards drives that do not have password protection by freezing them prior to booting. If the drive is frozen, a power off or hard reset of your PC must be performed to proceed with the ASUS Secure Erase.
- **Locked.** SSDs might be locked if the ASUS Secure Erase process is either incomplete or was stopped. This may be due to a third party software that uses a different password defined by ASUS. You have to unlock the SSD in the software before proceeding with ASUS Secure Erase.

3.9.3 ASUS User Profile

This item allows you to store or load multiple BIOS setting profiles.

Load Profile

This item allows you to load the previous BIOS settings saved in the BIOS Flash. Key in the profile number that saved your BIOS settings, press <Enter>, and then select **Yes**.



- DO NOT shut down or reset the system while updating the BIOS to prevent the system boot failure!
- We recommend that you update the BIOS file only coming from the same memory/ CPU configuration and BIOS version.

Profile Name

This item allows you to key in a profile name.

Save to Profile

This item allows you to save the current BIOS settings to the BIOS Flash, and create a profile. Key in a profile number from one to eight, press <Enter>, and then select **Yes**.

Load/Save Profile from/to USB Drive

This item allows you to load or save profile from your USB drive, load and save profile to your USB drive.

3.9.4 ASUS SPD Information

This item allows you to view the DRAM SPD information.

3.9.5 Graphics Card Information

This item displays the information about the graphics card installed in your system.

GPU Post

This item displays the information and recommended configuration for the PCIe slots that the graphics card is installed in your system.



This feature is only supported on selected ASUS graphics cards.

Bus Interface

This item allows you to select the bus interface.

Configuration options: [PCIEX16/X8_1]

3.9.6 ASUS Armoury Crate

This item allows you to enable or disable the system to download ASUS Armoury Crate.

Download & Install ARMOURY CRATE app

This item allows you to enable Armoury Crate download Process.

Configuration options: [Disabled] [Enabled]

3.10 Exit menu

The Exit menu items allow you to load the optimal default values for the BIOS items, and save or discard your changes to the BIOS items. You can access the EZ Mode from the Exit menu.

Load Optimized Defaults

This option allows you to load the default values for each of the parameters on the Setup menus. When you select this option or if you press <F5>, a confirmation window appears. Select **OK** to load the default values.

Save Changes & Reset

Once you are finished making your selections, choose this option from the Exit menu to ensure the values you selected are saved. When you select this option or if you press <F10>, a confirmation window appears. Select **OK** to save changes and exit.

Discard Changes & Exit

This option allows you to exit the Setup program without saving your changes. When you select this option or if you press <Esc>, a confirmation window appears. Select **Yes** to discard changes and exit.

Launch EFI Shell from USB drives

This item allows you to attempt to launch the EFI Shell application (shellx64.efi) from one of the available filesystem devices.

3.11 Updating BIOS

The ASUS website publishes the latest BIOS versions to provide enhancements on system stability, compatibility, and performance. However, BIOS updating is potentially risky. If there is no problem using the current version of BIOS, DO NOT manually update the BIOS. Inappropriate BIOS updating may result to system's failure to boot. Carefully follow the instructions in this chapter to update your BIOS when necessary.



Visit <http://www.asus.com> to download the latest BIOS file for this motherboard.

The following utilities allow you to manage and update the motherboard BIOS setup program.

1. EZ Update: Updates the BIOS in Windows® environment.
2. ASUS EZ Flash 3: Updates the BIOS using a USB flash drive.
3. ASUS CrashFree BIOS 3: Restores the BIOS using the motherboard support DVD or a USB flash drive when the BIOS file fails or gets corrupted.

3.11.1 EZ Update

The EZ Update is a utility that allows you to update the motherboard BIOS in Windows® environment.



- EZ Update requires an Internet connection either through a network or an ISP (Internet Service Provider).
 - This utility is available in the support DVD that comes with the motherboard package.
-

3.11.2 ASUS EZ Flash 3

ASUS EZ Flash 3 allows you to download and update to the latest BIOS through the Internet without having to use a bootable floppy disk or an OS-based utility.



Updating through the Internet varies per region and Internet conditions. Check your local Internet connection before updating through the Internet.

To update the BIOS by USB:

1. Enter the Advanced Mode of the BIOS setup program. Go to the Tool menu to select **ASUS EZ Flash Utility** and press <Enter>.
2. Insert the USB flash disk that contains the latest BIOS file to the USB port.
3. Select **via Storage Device(s)**.

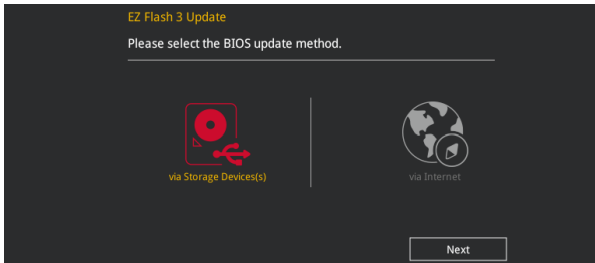

4. Press <Tab> to switch to the Drive field.
5. Press the Up/Down arrow keys to find the USB flash disk that contains the latest BIOS, and then press <Enter>.
6. Press <Tab> to switch to the Folder Info field.
7. Press the Up/Down arrow keys to find the BIOS file, and then press <Enter> to perform the BIOS update process. Reboot the system when the update process is done.

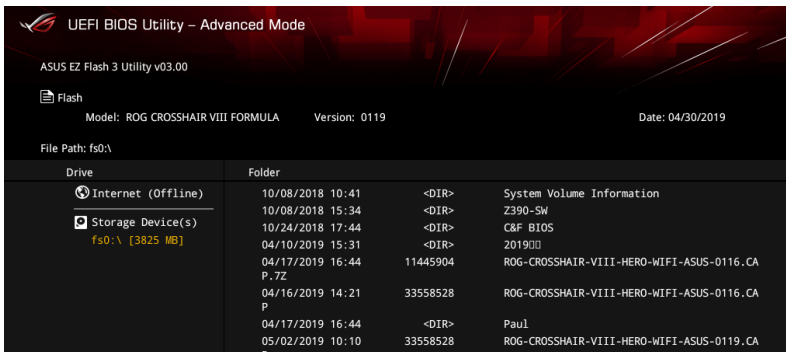



- This function can support devices such as a USB flash disk with FAT 32/16 format and single partition only.
- DO NOT shut down or reset the system while updating the BIOS to prevent system boot failure!



Ensure to load the BIOS default settings to ensure system compatibility and stability. Select the Load Optimized Defaults item under the Exit menu. See section 3.10 **Exit Menu** for details.

To update the BIOS by Internet:

1. Enter the Advanced Mode of the BIOS setup program. Go to the Tool menu to select **ASUS EZ Flash Utility** and press <Enter>.
2. Select **via Internet**.

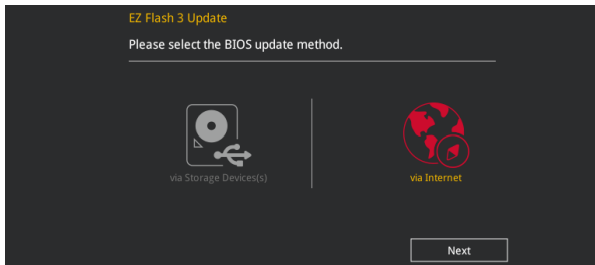

3. Press the Left/Right arrow keys to select an Internet connection method, and then press <Enter>.

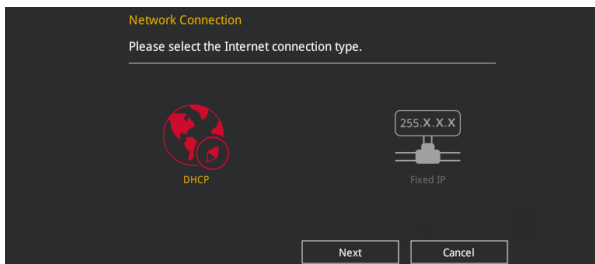

4. Follow the onscreen instructions to complete the update.
5. Reboot the system when the update process is done.



Ensure to load the BIOS default settings to ensure system compatibility and stability. Select the Load Optimized Defaults item under the Exit menu. See section 3.10 **Exit Menu** for details.

3.11.3 ASUS CrashFree BIOS 3

The ASUS CrashFree BIOS 3 utility is an auto recovery tool that allows you to restore the BIOS file when it fails or gets corrupted during the updating process. You can restore a corrupted BIOS file using the motherboard support DVD or a USB flash drive that contains the BIOS file.



The BIOS file in the motherboard support DVD may be older than the BIOS file published on the ASUS official website. If you want to use the newer BIOS file, download the file at <https://www.asus.com/support/> and save it to a USB flash drive.

Recovering the BIOS

To recover the BIOS:

1. Turn on the system.
2. Insert the motherboard support DVD to the optical drive, or the USB flash drive containing the BIOS file to the USB port.
3. The utility automatically checks the devices for the BIOS file. When found, the utility reads the BIOS file and enters ASUS EZ Flash 3 automatically.
4. The system requires you to enter BIOS Setup to recover the BIOS setting. To ensure system compatibility and stability, we recommend that you press <F5> to load default BIOS values.



DO NOT shut down or reset the system while updating the BIOS! Doing so can cause system boot failure!

RAID Support

4

4.1 AMD RAID Array configurations

The motherboard comes with the RaidXpert2 Configuration Utility that supports Volume, RAIDABLE, RAID 0, RAID 1, and RAID 10 (depends on system licensing) configurations.



For more information on configuring your RAID sets, please refer to the **RAID Configuration Guide** which you can find at <https://www.asus.com/support>.

4.1.1 RAID definitions

Volume provides the ability to link-together storage from one or several disks, regardless of the size of the space on those disks. This configuration is useful in scavenging space on disks unused by other disks in the array. This configuration does not provide performance benefits or data redundancy, disk failure will result in data loss.

RAIDABLE arrays (also known as RAID Ready) are a special type of Volume (JBOD) that allows the user to add more storage space or create a redundant array after a system is installed. RAIDABLE arrays are created using Option ROM, UEFI, or roadm.



The ability to create RAIDABLE arrays may vary per system.

RAID 0 (Data striping) optimizes two identical hard disk drives to read and write data in parallel, interleaved stacks. Two hard disks perform the same work as a single drive but at a sustained data transfer rate, double that of a single disk alone, thus improving data access and storage. Use of two new identical hard disk drives is required for this setup.

RAID 1 (Data mirroring) copies and maintains an identical image of data from one drive to a second drive. If one drive fails, the disk array management software directs all applications to the surviving drive as it contains a complete copy of the data in the other drive. This RAID configuration provides data protection and increases fault tolerance to the entire system. Use two new drives or use an existing drive and a new drive for this setup. The new drive must be of the same size or larger than the existing drive.

RAID 10 is data striping and data mirroring combined without parity (redundancy data) having to be calculated and written. With the RAID 10 configuration you get all the benefits of both RAID 0 and RAID 1 configurations. Use four new hard disk drives or use an existing drive and three new drives for this setup.

Appendix

Q-Code table

Code	Description
00	Not used
01	Power on. Reset type detection (soft/hard).
02	AP initialization before microcode loading
03	System Agent initialization before microcode loading
04	PCH initialization before microcode loading
06	Microcode loading
07	AP initialization after microcode loading
08	System Agent initialization after microcode loading
09	PCH initialization after microcode loading
0B	Cache initialization
0C – 0D	Reserved for future AMI SEC error codes
0E	Microcode not found
0F	Microcode not loaded
10	PEI Core is started
11 – 14	Pre-memory CPU initialization is started
15 – 18	Pre-memory System Agent initialization is started
19 – 1C	Pre-memory PCH initialization is started
2B – 2F	Memory initialization
30	Reserved for ASL (see ASL Status Codes section below)
31	Memory Installed
32 – 36	CPU post-memory initialization
37 – 3A	Post-Memory System Agent initialization is started
3B – 3E	Post-Memory PCH initialization is started
4F	DXE IPL is started
50 – 53	Memory initialization error. Invalid memory type or incompatible memory speed
54	Unspecified memory initialization error
55	Memory not installed
56	Invalid CPU type or Speed
57	CPU mismatch
58	CPU self test failed or possible CPU cache error
59	CPU micro-code is not found or micro-code update is failed
5A	Internal CPU error
5B	Reset PPI is not available
5C – 5F	Reserved for future AMI error codes

(continued on the next page)

Q-Code table

Code	Description
E0	S3 Resume is started (S3 Resume PPI is called by the DXE IPL)
E1	S3 Boot Script execution
E2	Video repost
E3	OS S3 wake vector call
E4 – E7	Reserved for future AMI progress codes
E8	S3 Resume Failed
E9	S3 Resume PPI not Found
EA	S3 Resume Boot Script Error
EB	S3 OS Wake Error
EC – EF	Reserved for future AMI error codes
F0	Recovery condition triggered by firmware (Auto recovery)
F1	Recovery condition triggered by user (Forced recovery)
F2	Recovery process started
F3	Recovery firmware image is found
F4	Recovery firmware image is loaded
F5 – F7	Reserved for future AMI progress codes
F8	Recovery PPI is not available
F9	Recovery capsule is not found
FA	Invalid recovery capsule
FB – FF	Reserved for future AMI error codes
60	DXE Core is started
61	NVRAM initialization
62	Installation of the PCH Runtime Services
63 – 67	CPU DXE initialization is started
68	PCI host bridge initialization
69	System Agent DXE initialization is started
6A	System Agent DXE SMM initialization is started
6B – 6F	System Agent DXE initialization (System Agent module specific)
70	PCH DXE initialization is started
71	PCH DXE SMM initialization is started
72	PCH devices initialization
73 – 77	PCH DXE Initialization (PCH module specific)
78	ACPI module initialization
79	CSM initialization
7A – 7F	Reserved for future AMI DXE codes

(continued on the next page)

Q-Code table

Code	Description
90	Boot Device Selection (BDS) phase is started
91	Driver connecting is started
92	PCI Bus initialization is started
93	PCI Bus Hot Plug Controller Initialization
94	PCI Bus Enumeration
95	PCI Bus Request Resources
96	PCI Bus Assign Resources
97	Console Output devices connect
98	Console input devices connect
99	Super IO Initialization
9A	USB initialization is started
9B	USB Reset
9C	USB Detect
9D	USB Enable
9E – 9F	Reserved for future AMI codes
A0	IDE initialization is started
A1	IDE Reset
A2	IDE Detect
A3	IDE Enable
A4	SCSI initialization is started
A5	SCSI Reset
A6	SCSI Detect
A7	SCSI Enable
A8	Setup Verifying Password
A9	Start of Setup
AA	Reserved for ASL (see ASL Status Codes section below)
AB	Setup Input Wait
AC	Reserved for ASL (see ASL Status Codes section below)
AD	Ready To Boot event
AE	Legacy Boot event
AF	Exit Boot Services event
B0	Runtime Set Virtual Address MAP Begin
B1	Runtime Set Virtual Address MAP End
B2	Legacy Option ROM Initialization
B3	System Reset

(continued on the next page)

Q-Code table

Code	Description
B4	USB hot plug
B5	PCI bus hot plug
B6	Clean-up of NVRAM
B7	Configuration Reset (reset of NVRAM settings)
B8– BF	Reserved for future AMI codes
D0	CPU initialization error
D1	System Agent initialization error
D2	PCH initialization error
D3	Some of the Architectural Protocols are not available
D4	PCI resource allocation error. Out of Resources
D5	No Space for Legacy Option ROM
D6	No Console Output Devices are found
D7	No Console Input Devices are found
D8	Invalid password
D9	Error loading Boot Option (LoadImage returned error)
DA	Boot Option is failed (StartImage returned error)
DB	Flash update is failed
DC	Reset protocol is not available

ACPI/ASL Checkpoints

Code	Description
0x01	System is entering S1 sleep state
0x02	System is entering S2 sleep state
0x03	System is entering S3 sleep state
0x04	System is entering S4 sleep state
0x05	System is entering S5 sleep state
0x10	System is waking up from the S1 sleep state
0x20	System is waking up from the S2 sleep state
0x30	System is waking up from the S3 sleep state
0x40	System is waking up from the S4 sleep state
0xAC	System has transitioned into ACPI mode. Interrupt controller is in PIC mode.
0xAA	System has transitioned into ACPI mode. Interrupt controller is in APIC mode.

Notices

FCC Compliance Information

Responsible Party: Asus Computer International
Address: 48720 Kato Rd., Fremont, CA 94538, USA
Phone / Fax No: (510)739-3777 / (510)608-4555

Identification of the assembled product: INTEL® WI-FI 6 AX200

Identification of the modular components used in the assembly:

Model Name: INTEL® WI-FI 6 AX200 FCC ID: PD9AX200NG

This device complies with part 15 of the FCC Rules. Operation is subject to the following two conditions: (1) This device may not cause harmful interference, and (2) this device must accept any interference received, including interference that may cause undesired operation.

This equipment has been tested and found to comply with the limits for a Class B digital device, pursuant to part 15 of the FCC Rules. These limits are designed to provide reasonable protection against harmful interference in a residential installation. This equipment generates, uses and can radiate radio frequency energy and, if not installed and used in accordance with the instructions, may cause harmful interference to radio communications. However, there is no guarantee that interference will not occur in a particular installation. If this equipment does cause harmful interference to radio or television reception, which can be determined by turning the equipment off and on, the user is encouraged to try to correct the interference by one or more of the following measures:

- Reorient or relocate the receiving antenna.
- Increase the separation between the equipment and receiver.
- Connect the equipment into an outlet on a circuit different from that to which the receiver is connected.
- Consult the dealer or an experienced radio/TV technician for help.

RF exposure warning

This equipment must be installed and operated in accordance with provided instructions and the antenna(s) used for this transmitter must be installed to provide a separation distance of at least 20 cm from all persons and must not be co-located or operating in conjunction with any other antenna or transmitter. End-users and installers must be provided with antenna installation instructions and transmitter operating conditions for satisfying RF exposure compliance.

Compliance Statement of Innovation, Science and Economic Development Canada (ISED)

This device complies with Innovation, Science and Economic Development Canada licence exempt RSS standard(s). Operation is subject to the following two conditions: (1) this device may not cause interference, and (2) this device must accept any interference, including interference that may cause undesired operation of the device.

Operation in the band 5150–5250 MHz is only for indoor use to reduce the potential for harmful interference to co-channel mobile satellite systems.

CAN ICES-3(B)/NMB-3(B)

Déclaration de conformité de Innovation, Sciences et Développement économique Canada (ISED)

Le présent appareil est conforme aux CNR d'Innovation, Sciences et Développement économique Canada applicables aux appareils radio exempts de licence. L'exploitation est autorisée aux deux conditions suivantes : (1) l'appareil ne doit pas produire de brouillage, et (2) l'utilisateur de l'appareil doit accepter tout brouillage radioélectrique subi, même si le brouillage est susceptible d'en compromettre le fonctionnement.

La bande 5150–5250 MHz est réservée uniquement pour une utilisation à l'intérieur afin de réduire les risques de brouillage préjudiciable aux systèmes de satellites mobiles utilisant les mêmes canaux.

CAN ICES-3(B)/NMB-3(B)

VCCI: Japan Compliance Statement

Class B ITE

この装置は、クラスB情報技術装置です。この装置は、家庭環境で使用することを目的としていますが、この装置がラジオやテレビジョン受信機に近接して使用されると、受信障害を引き起こすことがあります。

取扱説明書に従って正しい取り扱いをして下さい。

VCCI-B

KC: Korea Warning Statement

B급 기기 (가정용 방송통신기자재)

이 기기는 가정용(B급) 전자파적합기기로서 주로 가정에서 사용하는 것을 목적으로 하며, 모든 지역에서 사용할 수 있습니다.

*당해 무선설비는 전파혼신 가능성이 있으므로 인명안전과 관련된 서비스는 할 수 없습니다.

REACH

Complying with the REACH (Registration, Evaluation, Authorisation, and Restriction of Chemicals) regulatory framework, we published the chemical substances in our products at ASUS REACH website at <http://csr.asus.com/english/REACH.htm>.



DO NOT throw the motherboard in municipal waste. This product has been designed to enable proper reuse of parts and recycling. This symbol of the crossed out wheeled bin indicates that the product (electrical and electronic equipment) should not be placed in municipal waste. Check local regulations for disposal of electronic products.



DO NOT throw the mercury-containing button cell battery in municipal waste. This symbol of the crossed out wheeled bin indicates that the battery should not be placed in municipal waste.

ASUS Recycling/Takeback Services

ASUS recycling and takeback programs come from our commitment to the highest standards for protecting our environment. We believe in providing solutions for you to be able to responsibly recycle our products, batteries, other components as well as the packaging materials. Please go to <http://csr.asus.com/english/Takeback.htm> for detailed recycling information in different regions.

Regional notice for California



WARNING

Cancer and Reproductive Harm -
www.P65Warnings.ca.gov

Google™ License Terms

Copyright© 2018 Google Inc. All Rights Reserved.

License under the Apache License, Version 2.0 (the "License"); you may not use this file except in compliance with the License. You may obtain a copy of the License at:

<http://www.apache.org/licenses/LICENSE-2.0>

Unless required by applicable law or agreed to in writing, software distributed under the License is distributed on an "AS IS" BASIS, WITHOUT WARRANTIES OR CONDITIONS OF ANY KIND, either express or implied.

See the License for the specific language governing permissions and limitations under the License.

NCC: Taiwan Wireless Statement

經型式認證合格之低功率射頻電機，非經許可，公司、商號或使用者均不得擅自變更頻率、加大功率或變更原設計之特性及功能。低功率射頻電機之使用不得影響飛航安全及干擾合法通信；經發現有干擾現象時，應立即停用，並改善至無干擾時方得繼續使用。前項合法通信，指依電信法規定作業之無線電通信。低功率射頻電機須忍受合法通信或工業、科學及醫療用電波輻射性電機設備之干擾。

應避免影響附近雷達系統之操作。

Japan RF Equipment Statement

屋外での使用について

本製品は、5GHz帯域での通信に対応しています。電波法の定めにより5.2GHz、5.3GHz帯域の電波は屋外で使用が禁じられています。

法律および規制遵守

本製品は電波法及びこれに基づく命令の定めるところに従い使用してください。日本国外では、その国の法律または規制により、本製品の使用ができないことがあります。このような国では、本製品を運用した結果、罰せられることがあります。当社は一切責任を負いかねますのでご了承ください。

Précautions d'emploi de l'appareil :

- a. Soyez particulièrement vigilant quant à votre sécurité lors de l'utilisation de cet appareil dans certains lieux (les avions, les aéroports, les hôpitaux, les stations-service et les garages professionnels).
- b. Évitez d'utiliser cet appareil à proximité de dispositifs médicaux implantés. Si vous portez un implant électronique (stimulateurs cardiaques, pompes à insuline, neurostimulateurs...), veuillez impérativement respecter une distance minimale de 15 centimètres entre cet appareil et l'implant pour réduire les risques d'interférence.
- c. Utilisez cet appareil dans de bonnes conditions de réception pour minimiser le niveau de rayonnement. Ce n'est pas toujours le cas dans certaines zones ou situations, notamment dans les parkings souterrains, dans les ascenseurs, en train ou en voiture ou tout simplement dans un secteur mal couvert par le réseau.
- d. Tenez cet appareil à distance du ventre des femmes enceintes et du bas-ventre des adolescents.

Simplified EU Declaration of Conformity

ASUSTek Computer Inc. hereby declares that this device is in compliance with the essential requirements and other relevant provisions of Directive 2014/53/EU. Full text of EU declaration of conformity is available at <https://www.asus.com/support/>

The WiFi operating in the band 5150-5350MHz shall be restricted to indoor use for countries listed in the table below:

Déclaration simplifiée de conformité de l'UE

ASUSTek Computer Inc. déclare par la présente que cet appareil est conforme aux critères essentiels et autres clauses pertinentes de la directive 2014/53/EU. La déclaration de conformité de l'UE peut être téléchargée à partir du site internet suivant : <https://www.asus.com/support/>

Dans la plage de fréquence 5150-5350 MHz, le Wi-Fi est restreint à une utilisation en intérieur dans les pays listés dans le tableau ci-dessous:

Vereinfachte EU-Konformitätserklärung

ASUSTEK COMPUTER INC erklärt hiermit, dass dieses Gerät mit den grundlegenden Anforderungen und anderen relevanten Bestimmungen der Richtlinie 2014/53/EU übereinstimmt. Der gesamte Text der EU-Konformitätserklärung ist verfügbar unter: <https://www.asus.com/support/>
Der WLAN-Betrieb im Band von 5150-5350 MHz ist für die in der untenen Tabelle aufgeführten Länder auf den Innenbereich beschränkt:

Dichiarazione di conformità UE semplificata

ASUSTEK Computer Inc. con la presente dichiara che questo dispositivo è conforme ai requisiti essenziali e alle altre disposizioni pertinenti con la direttiva 2014/53/EU. Il testo completo della dichiarazione di conformità UE è disponibile all'indirizzo: <https://www.asus.com/support/>

L'utilizzo della rete Wi-Fi con frequenza compresa nell'intervallo 5150-5350MHz deve essere limitato all'interno degli edifici per i paesi presenti nella seguente tabella:

Упрощенное заявление о соответствии европейской директиве

ASUSTEK Computer Inc. заявляет, что устройство соответствует основным требованиям и другим соответствующим условиям директивы 2014/53/EU. Полный текст декларации соответствия ЕС доступен на <https://www.asus.com/support/>

Работа WiFi в диапазоне частот 5150-5350 должна быть ограничена использованием в помещениях для стран, перечисленных в таблице ниже:
إعلان التوافق المبسط الصادر عن الاتحاد الأوروبي

تقر شركة ASUSTek Computer Inc أن هذا الجهاز يتوافق مع المتطلبات الأساسية والأحكام الأخرى ذات الصلة الخاصة بتوجيه 2014/53/EE. يتوفر النص الكامل لإعلان التوافق الصادر عن الاتحاد الأوروبي على: <https://www.asus.com/support/>

يجب حصر استخدام WiFi المعاملة بـ 5150-5350 ميجا هرتز على الاستخدام المنزلي للبلدان المدرجة بالجدول.

Опрощенная декларация за съответствие на ЕС

С настоящото ASUSTEK Computer Inc. декларира, че това устройство е в съответствие със съществените изисквания и другите приложими постановления на свързаната Директива 2014/53/EE. Пълният текст на ЕС декларация за съвместимост е достъпен на адрес <https://www.asus.com/support/>

WiFi, работеща в диапазон 5150-5350MHz, трябва да се ограничи до употреба на закрито за страните, посочени в таблицата по-долу:

Declaração de Conformidade UE Simplificada

ASUSTEK Computer Inc. declara que este dispositivo está em conformidade com os requisitos essenciais e outras disposições relevantes relacionadas às diretivas 2014/53/EU. O texto completo da declaração de conformidade CE está disponível em <https://www.asus.com/support/>

O WiFi operando na banda 5150-5350MHz deve ser restrito para uso interno para os países listados na tabela abaixo:

Поједностављена ЕУ изјава о суладности

ASUSTEK Computer Inc. овим изјављује да је овај уређај суладан с битним захтевима и осталим одговарајућим одредбама директиве 2014/53/EU. Цјели текст ЕУ изјаве о суладности доступан је на <https://www.asus.com/support/>
WiFi који ради на опсегу фреквенција 5150-5350 MHz бит ће ограничен на употребу у затвореном простору у земљама на доњем попису:

Zjednodušené prohlášení o shodě EU

Společnost ASUSTEK Computer Inc. tímto prohlašuje, že toto zařízení splňuje základní požadavky a další příslušná ustanovení směrnice 2014/53/EU. Plné znění prohlášení o shodě EU je k dispozici na adrese <https://www.asus.com/support/>

V zemích uvedených v tabulce je provoz síti Wi-Fi ve frekvenčním rozsahu 5 150 - 5 350 MHz povolen pouze ve vnitřních prostorech:

Forenklet EU-oversensstemmelseerklæring

ASUSTEK Computer Inc. erklærer hermed at denne enhed er i overensstemmelse med hovedkravene og øvrige relevante bestemmelser i direktivet 2014/53/EU. Hele EU-oversensstemmelseerklæringen kan findes på <https://www.asus.com/support/>

Wi-Fi, der bruger 5150-5350 MHz skal begrænses til indendørs brug i lande, der er anført i tabellen:

Vereenvoudigd EU-conformiteitsverklaring

ASUSTEK Computer Inc. verklaart hierbij dat dit apparaat voldoet aan de essentiële vereisten en andere relevante bepalingen van Richtlijn 2014/53/EU. De volledige tekst van de EU-conformiteitsverklaring is beschikbaar op <https://www.asus.com/support/>

De WiFi op 5150-5350MHz zal beperkt zijn tot binnengebruik voor in de tabel vermelde landen:

Lihtsustatud EÜ vastavusdeklaratsioon

Käesolevaga kinnitab ASUSTEK Computer Inc. et seade vastab direktiivi 2014/53/EU olulistele nõuetele ja teiste asjakohastele sätetele. EL vastavusdeklaratsiooni täistekst on saadaval veebisaidil <https://www.asus.com/support/>

Sagedusvahemikus 5150-5350 MHz töötava WiFi kasutamine on järgmistes riikides lubatud ainult siseruumides:

Eurooppa - EYn vaatimustenmukaisuusvaakuuus

ASUSTEK Computer Inc. ilmoittaa täten, että tämä laite on direktiivin 2014/53/EU olennaisien vaatimusten ja muiden asiaankuuluvien luvustusten mukainen. Koko EYn vaatimustenmukaisuusvaakuuksen teksti on luettävissa osoitteessa <https://www.asus.com/support/>

5 150 - 5 350 MHz:in taajuudella toimiva WiFi on rajoitettu sisäkäyttöön taulukossa luettelussa maissa:

تبعیت از نسخه ساده شده بیانیه تطبیقی اروپا

ASUSTEK Computer Inc در اینجا اعلام می کند که این دستگاه با نیازهای اساسی و سایر مقررات مربوط به بیانیه 2014/53/EE مطابقت دارد. متن کامل پیروی از این بیانیه تطبیقی اروپا در این آدرس موجود است: <https://www.asus.com/support/>

عنوان 5150-5350 مگاهرتز برای WiFi باید برای استفاده در فضای داخلی ساختمان برای کشورها فهرست شده در جدول، محدود شود.

Απλοποιημένη Δήλωση Συμμόρφωσης ΕΕ

Διά του παρόντος η ASUSTEK Computer Inc. δηλώνει ότι αυτή η συσκευή είναι συμμόρφη με τις βασικές προϋποθέσεις και άλλες σχετικές διατάξεις της Οδηγίας 2014/53/ΕΕ. Το πλήρες κείμενο της δήλωσης συμμόρφωσης της ΕΕ είναι διαθέσιμο στη διεύθυνση <https://www.asus.com/support/>

To WiFi που λειτουργεί στη ζώνη 5150-5350MHz περιορίζεται για χρήση σε εσωτερικούς χώρους για τις χώρες που αναφέρονται στον παρακάτω πίνακα:

הגדרת האימות הרגולטורית מקוצרת עבור האיחוד האירופי

ASUSTEK Computer Inc. מגהירה בזאת כי מכשיר זה תומך לרישורט הניווט ולשיא הספייפיק המאופיינים את תקנה 2014/53/EE. ניתן לקרוא את הסוג המלא של הגדרת האימות הרגולטורית עבור האיחוד האירופי בכתובת: <https://www.asus.com/support/>
יש להגביל רשתות Wi-Fi הפועלות ברצועות התדרים 5150-5350MHz לשימוש בתוך מבנים מסוים המפורטים ברשימה הבאה:

Egyszerűsített EU megfelelési nyilatkozat

Az ASUSTEK Computer Inc. ezennel kijelenti, hogy ez az eszköz megfelel az 2014/53/EU sz. irányelv alapvető követelményeinek és egyéb vonatkozó rendelkezésének. Az EU megfelelési nyilatkozat teljes szövegét a következő weboldalon tekintheti meg: <https://www.asus.com/support/>

Az 5150-5350 MHz-es sávban működő Wi-Fi-t belterületi használatra kell korlátozni az alábbi táblázatban felsorolt országokban:

Pernyataan Kesesuaian UE yang Disederhanakan

ASUSTEK Computer Inc. dengan ini menyatakan bahwa perangkat ini memenuhi persyaratan utama dan ketentuan relevan lainnya yang terdapat pada Petunjuk 2014/53/EU. Teks lengkap pernyataan kesesuaian UE tersedia di: <https://www.asus.com/support/>

WiFi yang Beroperasi pada 5150-5350 MHz akan terbatas untuk penggunaan dalam ruangan di negara yang tercantum dalam tabel

Vienkāršota ES atbilstības paziņojums

ASUSTEK Computer Inc. ar šo paziņo, ka šī ierīce atbilst Direktīvas 2014/53/ES būtiskajām prasībām un citiem citiem saistītajiem nosacījumiem. Pilns ES atbilstības paziņojuma teksts pieejams šeit: <https://www.asus.com/support/>

Wi-Fi darbība 5150–5350 MHz ir jāierobežo lietošanai telpās valstīs, kuras norādītas tālāk.

Supraprastinta ES atitikties deklaracija

Šiame dokumente bendrovė „ASUSTek Computer Inc.“ pareiškia, kad šis prietaisas atitinka pagrindinius reikalavimus ir kitas susijusias Direktyvos 2014/53/ES nuostatas. Visas ES atitikties deklaracijos tekstas pateikiamas čia: <https://www.asus.com/support/>

Toliau nurodytose šalyse „WiFi“ ryšiu, veikiančiu 5 150-5 350 MHz dažniu juostoje, galima naudotis tik patalpose:

Ovaj uredaj može da se koristi u državama navedenim ispod:

Förenklad EU-samsvarserklæring

ASUSTek Computer Inc. erklærer herved at denne enheten er i samsvar med hovedsaklige krav og andre relevante forskrifter i direktivet 2014/53/EU. Fullstendig tekst for EU-samsvarserklæring finnes på: <https://www.asus.com/support/>

Wi-Fi-området 5150–5350 MHz skal begrenses til innendørs bruk for landene som er oppført i tabellen:

Uproszczone deklaracja zgodności UE

Firma ASUSTek Computer Inc. niniejszym oświadcza, że urządzenie to jest zgodne z zasadniczymi wymogami i innymi właściwymi postanowieniami dyrektywy 2014/53/EU. Pełny tekst deklaracji zgodności UE jest dostępny pod adresem <https://www.asus.com/support/>

W krajach wymienionych w tabeli działanie sieci Wi-Fi w paśmie 5150–5350 MHz powinno być ograniczone wyłącznie do pomieszczeń:

Declaração de Conformidade Simplificada da UE

A ASUSTek Computer Inc. declara que este dispositivo está em conformidade com os requisitos essenciais e outras disposições relevantes da Diretiva 2014/53/UE. O texto integral da declaração de conformidade da UE está disponível em <https://www.asus.com/support/>

A utilização das frequências WiFi de 5150 a 5350MHz está restrita a ambientes interiores nos países apresentados na tabela:

Declaratie de conformitate UE, versiune simplificată

Prin prezenta, ASUSTek Computer Inc. declară că acest dispozitiv este în conformitate cu regulamentele esențiale și cu celelalte prevederi relevante ale Directivei 2014/53/UE. Textul complet al declarației de conformitate UE este disponibil la adresa <https://www.asus.com/support/>

Pentru țările listate în tabelul de mai jos, rețelele WiFi care funcționează în banda de frecvență de 5.150-5.350 MHz trebuie utilizate doar în interior:

Pojednostavljena Deklaracija o usaglašenosti EU

ASUSTek Computer Inc. ovim izjavljuje da je ovaj uređaj usaglašen sa osnovnim zahtevima i drugim relevantnim odredbama Direktive 2014/53/EU. Ceo tekst Deklaracije o usaglašenosti EU dostupan je na lokaciji <https://www.asus.com/support/>

WiFi koji radi u frekventnom opsegu od 5150 MHz do 5350 MHz ograničen je isključivo na upotrebu u zatvorenom prostoru za zemlje navedene u tabeli ispod:

Zjednodušené vyhlásenie o zhode platné pre EÚ

Spoločnosť ASUSTek Computer Inc. týmto vyhlasuje, že toto zariadenie je v súlade so základnými požiadavkami a ďalšími príslušnými ustanoveniami smernice č. 2014/53/EÚ. Plné znenie vyhlásenia o zhode pre EÚ je k dispozícii na lokalite <https://www.asus.com/support/>

Činnosť WiFi v pásme 5150 - 5350 MHz bude obmedzená na použitie vo vnútornom prostredí pre krajiny uvedené v tabuľke nižšie:

Poenostavljena izjava EU o skladnosti

ASUSTek Computer Inc. tukaj izjavlja, da je ta naprava skladna s temeljnimi zahtevami in drugimi relevantnimi določili Direktive 2014/53/EU. Polno besedilo izjave EU o skladnosti je na voljo na <https://www.asus.com/support/>

WiFi, ki deluje v pasovnem območju 5150–5350 MHz, mora biti v državah, navedenih v spodnjem seznamu, omejen na notranjo uporabo:

Declaración de conformidad simplificada para la UE

Por la presente, ASUSTek Computer Inc. declara que este dispositivo cumple los requisitos básicos y otras disposiciones pertinentes de la directiva 2014/53/UE. En <https://www.asus.com/support/> está disponible el texto completo de la declaración de conformidad para la UE.

La conexión WiFi con una frecuencia de funcionamiento de 5150-5350 MHz se restringirá al uso en interiores para los países enumerados en la tabla:

Förenklad EU-försäkran om överensstämmelse

ASUSTek Computer Inc. deklarerar härmed att denna enhet överensstämmer med de grundläggande kraven och andra relevanta bestämmelser i direktiv 2014/53/EU. Fullständig text av EU-försäkran om överensstämmelse finns på <https://www.asus.com/support/>

WiFi som används 5150-5350 MHz kommer att begränsas för användning inomhus i de länder som anges i tabellen:

ประกาศเกี่ยวกับความสอดคล้องของสหภาพยุโรปแบบย่อ

ASUSTek Computer Inc.

ขอประกาศในที่นี้ว่าอุปกรณ์นี้มีความสอดคล้องกับความต้องการที่จำเป็นและเงื่อนไขที่เกี่ยวข้องอื่น ๆ ของบทบัญญัติข้อกำหนด 2014/53/UE (เนื้อหาที่สมบูรณ์ของประกาศความสอดคล้องกับ EU มีอยู่ที่ <https://www.asus.com/support/>)

การทำงานของ WiFi ที่ 5150-5350MHz ถูกจำกัดให้ใช้ในอาคารสำหรับประเทศที่แสดงในตาราง

Basitleştirilmiş AB Ulusuluk Bildirimi

ASUSTek Computer Inc. bu aygıtın 2014/53/UE Yönergesinin temel gereksinimlerine ve diğer ilgili hükümlerine uygun olduğunu bildirir. AB uygunluk bildiriminin tam metni şu adreste bulunabilir: <https://www.asus.com/support/>

5150-5350 MHz aralındaki WiFi çalışması, tabloda listelenen ülkeler için iç mekân kullanımıyla kısıtlanacaktır.

Спрощена декларация про відповідність нормам ЄС

ASUSTek Computer Inc. заявляє, що цей пристрій відповідає основним вимогам та іншим відповідним вимогам Директиви 2014 / 53 / EU. Повний текст декларації відповідності нормам ЄС доступний на <https://www.asus.com/support/>

Робота Wi-Fi на частоті 5150-5350 МГц обмежується використанням у приміщенні для країн, поданих у таблиці нижче:



AT	BE	BG	CZ	DK	EE	FR
DE	IS	IE	IT	EL	ES	CY
LV	LI	LT	LU	HU	MT	NL
NO	PL	PT	RO	SI	SK	TR
FI	SE	CH	UK	HR		

INTEL® Wi-Fi 6 AX200 output power table:

Function	Frequency	Maximum Output Power (EIRP)
WiFi	2400 - 2483.5 MHz	18.57 dBm
	5150 - 5350 MHz	19.13 dBm
	5470 - 5725 MHz	18.41 dBm
	5725 - 5850 MHz	9.11 dBm
Bluetooth	2402 - 2483.5 MHz	11.68 dBm

For the standard EN 300 440 V2.1.1, if this device operates in 5725-5875 MHz, it will be considered as a receiver category 2.



ASUS contact information

ASUSTeK COMPUTER INC.

Address 4F, No. 150, Li-Te Road, Peitou, Taipei 112, Taiwan
Telephone +886-2-2894-3447
Fax +886-2-2890-7798
Web site www.asus.com

Technical Support

Telephone +86-21-38429911
Fax +86-21-5866-8722, ext. 9101#
Online support <http://qr.asus.com/techserv>

ASUS COMPUTER INTERNATIONAL (America)

Address 48720 Kato Rd., Fremont, CA 94538, USA
Telephone +1-510-739-3777
Fax +1-510-608-4555
Web site <http://www.asus.com/us/>

Technical Support

Support fax +1-812-284-0883
Telephone +1-812-282-2787
Online support <http://qr.asus.com/techserv>

ASUS COMPUTER GmbH (Germany and Austria)

Address Harkort Str. 21-23, 40880 Ratingen, Germany
Fax +49-2102-959931
Web site <http://www.asus.com/de>
Online contact <http://eu-rma.asus.com/sales>

Technical Support

Telephone +49-2102-5789555
Support Fax +49-2102-959911
Online support <http://qr.asus.com/techserv>

