

**ROG STRIX  
B450-F  
GAMING**

**ASUS®**

**Motherboard**

E14401  
First Edition  
June 2018

**Copyright© 2018 ASUSTeK COMPUTER INC. All Rights Reserved.**

No part of this manual, including the products and software described in it, may be reproduced, transmitted, transcribed, stored in a retrieval system, or translated into any language in any form or by any means, except documentation kept by the purchaser for backup purposes, without the express written permission of ASUSTeK COMPUTER INC. ("ASUS").

Product warranty or service will not be extended if: (1) the product is repaired, modified or altered, unless such repair, modification of alteration is authorized in writing by ASUS; or (2) the serial number of the product is defaced or missing.

ASUS PROVIDES THIS MANUAL "AS IS" WITHOUT WARRANTY OF ANY KIND, EITHER EXPRESS OR IMPLIED, INCLUDING BUT NOT LIMITED TO THE IMPLIED WARRANTIES OR CONDITIONS OF MERCHANTABILITY OR FITNESS FOR A PARTICULAR PURPOSE. IN NO EVENT SHALL ASUS, ITS DIRECTORS, OFFICERS, EMPLOYEES OR AGENTS BE LIABLE FOR ANY INDIRECT, SPECIAL, INCIDENTAL, OR CONSEQUENTIAL DAMAGES (INCLUDING DAMAGES FOR LOSS OF PROFITS, LOSS OF BUSINESS, LOSS OF USE OR DATA, INTERRUPTION OF BUSINESS AND THE LIKE), EVEN IF ASUS HAS BEEN ADVISED OF THE POSSIBILITY OF SUCH DAMAGES ARISING FROM ANY DEFECT OR ERROR IN THIS MANUAL OR PRODUCT.

SPECIFICATIONS AND INFORMATION CONTAINED IN THIS MANUAL ARE FURNISHED FOR INFORMATIONAL USE ONLY, AND ARE SUBJECT TO CHANGE AT ANY TIME WITHOUT NOTICE, AND SHOULD NOT BE CONSTRUED AS A COMMITMENT BY ASUS. ASUS ASSUMES NO RESPONSIBILITY OR LIABILITY FOR ANY ERRORS OR INACCURACIES THAT MAY APPEAR IN THIS MANUAL, INCLUDING THE PRODUCTS AND SOFTWARE DESCRIBED IN IT.

Products and corporate names appearing in this manual may or may not be registered trademarks or copyrights of their respective companies, and are used only for identification or explanation and to the owners' benefit, without intent to infringe.

**Offer to Provide Source Code of Certain Software**

This product contains copyrighted software that is licensed under the General Public License ("GPL"), under the Lesser General Public License Version ("LGPL") and/or other Free Open Source Software Licenses. Such software in this product is distributed without any warranty to the extent permitted by the applicable law. Copies of these licenses are included in this product.

Where the applicable license entitles you to the source code of such software and/or other additional data, you may obtain it for a period of three years after our last shipment of the product, either

(1) for free by downloading it from <https://www.asus.com/support/>

or

(2) for the cost of reproduction and shipment, which is dependent on the preferred carrier and the location where you want to have it shipped to, by sending a request to:

ASUSTeK Computer Inc.  
Legal Compliance Dept.  
15 Li Te Rd.,  
Beitou, Taipei 112  
Taiwan

In your request please provide the name, model number and version, as stated in the About Box of the product for which you wish to obtain the corresponding source code and your contact details so that we can coordinate the terms and cost of shipment with you.

The source code will be distributed WITHOUT ANY WARRANTY and licensed under the same license as the corresponding binary/object code.

This offer is valid to anyone in receipt of this information.

ASUSTeK is eager to duly provide complete source code as required under various Free Open Source Software licenses. If however you encounter any problems in obtaining the full corresponding source code we would be much obliged if you give us a notification to the email address [gpl@asus.com](mailto:gpl@asus.com), stating the product and describing the problem (please DO NOT send large attachments such as source code archives, etc. to this email address).

# Contents

Safety information.....	vi
About this guide.....	vii
ROG STRIX B450-F GAMING specifications summary.....	ix
Package contents.....	xiii
Installation tools and components.....	xiv

## Chapter 1: Product Introduction

<b>1.1</b>	<b>Motherboard overview.....</b>	<b>1-1</b>
1.1.1	Before you proceed.....	1-1
1.1.2	Motherboard layout.....	1-2
1.1.3	Central Processing Unit (CPU).....	1-4
1.1.4	System memory.....	1-5
1.1.5	Expansion slots.....	1-7
1.1.6	Jumper.....	1-9
1.1.7	Onboard LEDs.....	1-10
1.1.8	Internal connectors.....	1-11

## Chapter 2: Basic Installation

<b>2.1</b>	<b>Building your PC system.....</b>	<b>2-1</b>
2.1.1	CPU installation.....	2-1
2.1.2	Cooling system installation.....	2-2
2.1.3	Motherboard installation.....	2-5
2.1.4	DIMM installation.....	2-6
2.1.5	ATX power connection.....	2-7
2.1.6	SATA device connection.....	2-8
2.1.7	Front I/O connector.....	2-9
2.1.8	Expansion card installation.....	2-10
2.1.9	M.2 installation.....	2-11
<b>2.2</b>	<b>Motherboard rear and audio connections.....</b>	<b>2-12</b>
2.2.1	Rear I/O connection.....	2-12
2.2.2	Audio I/O connections.....	2-14
<b>2.3</b>	<b>Starting up for the first time.....</b>	<b>2-16</b>
<b>2.4</b>	<b>Turning off the computer.....</b>	<b>2-16</b>

## **Chapter 3: BIOS Setup**

<b>3.1</b>	<b>Knowing BIOS</b> .....	<b>3-1</b>
<b>3.2</b>	<b>BIOS setup program</b> .....	<b>3-2</b>
	3.2.1 Advanced Mode .....	3-3
	3.2.2 EZ Mode.....	3-6
	3.2.3 QFan Control.....	3-7
	3.2.4 EZ Tuning Wizard .....	3-9
<b>3.3</b>	<b>My Favorites</b> .....	<b>3-11</b>
<b>3.4</b>	<b>Main menu</b> .....	<b>3-13</b>
<b>3.5</b>	<b>Ai Tweaker menu</b> .....	<b>3-13</b>
<b>3.6</b>	<b>Advanced menu</b> .....	<b>3-14</b>
	3.6.1 AMD fTPM configuration.....	3-14
	3.6.2 CPU Configuration .....	3-14
	3.6.3 ROG Effects .....	3-15
	3.6.4 SATA Configuration .....	3-15
	3.6.5 Onboard Devices Configuration.....	3-16
	3.6.6 APM Configuration.....	3-17
	3.6.7 Network Stack Configuration.....	3-17
	3.6.8 HDD/SSD SMART Information .....	3-17
	3.6.9 USB Configuration .....	3-18
<b>3.7</b>	<b>Monitor menu</b> .....	<b>3-18</b>
<b>3.8</b>	<b>Boot menu</b> .....	<b>3-19</b>
<b>3.9</b>	<b>Tool menu</b> .....	<b>3-20</b>
	3.9.1 ASUS EZ Flash 3 Utility .....	3-20
	3.9.2 ASUS Secure Erase.....	3-21
	3.9.3 ASUS User Profile.....	3-22
	3.9.4 ASUS SPD Information .....	3-22
	3.9.5 Graphics Card Information.....	3-22
<b>3.10</b>	<b>Exit menu</b> .....	<b>3-23</b>
<b>3.11</b>	<b>Updating BIOS</b> .....	<b>3-23</b>
	3.11.1 EZ Update .....	3-23
	3.11.2 ASUS EZ Flash 3.....	3-24
	3.11.3 ASUS CrashFree BIOS 3.....	3-26

<b>Chapter 4:</b>	<b>RAID Support</b>	
<b>4.1</b>	<b>AMD® RAID Array configurations .....</b>	<b>4-1</b>
4.1.1	RAID definitions .....	4-1
<b>Chapter 5:</b>	<b>Multi GPU Support</b>	
<b>5.1</b>	<b>AMD® CrossFireX™ technology .....</b>	<b>5-1</b>
5.1.1	Requirements.....	5-1
5.1.2	Before you begin .....	5-1
5.1.3	Installing three CrossFireX™ graphics cards.....	5-2
5.1.4	Installing the device drivers.....	5-3
5.1.5	Enabling the AMD® CrossFireX™ technology.....	5-3
<b>Appendix</b>		
<b>Notices</b> .....		<b>A-1</b>
<b>ASUS contact information</b> .....		<b>A-5</b>

# Safety information

## Electrical safety

- To prevent electrical shock hazard, disconnect the power cable from the electrical outlet before relocating the system.
- When adding or removing devices to or from the system, ensure that the power cables for the devices are unplugged before the signal cables are connected. If possible, disconnect all power cables from the existing system before you add a device.
- Before connecting or removing signal cables from the motherboard, ensure that all power cables are unplugged.
- Seek professional assistance before using an adapter or extension cord. These devices could interrupt the grounding circuit.
- Ensure that your power supply is set to the correct voltage in your area. If you are not sure about the voltage of the electrical outlet you are using, contact your local power company.
- If the power supply is broken, do not try to fix it by yourself. Contact a qualified service technician or your retailer.

## Operation safety

- Before installing the motherboard and adding devices on it, carefully read all the manuals that came with the package.
- Before using the product, ensure all cables are correctly connected and the power cables are not damaged. If you detect any damage, contact your dealer immediately.
- To avoid short circuits, keep paper clips, screws, and staples away from connectors, slots, sockets and circuitry.
- Avoid dust, humidity, and temperature extremes. Do not place the product in any area where it may become wet.
- Place the product on a stable surface.
- If you encounter technical problems with the product, contact a qualified service technician or your retailer.

## About this guide

This user guide contains the information you need when installing and configuring the motherboard.

## How this guide is organized

This guide contains the following parts:

- **Chapter 1: Product Introduction**  
This chapter describes the features of the motherboard and the new technology it supports. It includes description of the switches, jumpers, and connectors on the motherboard.
- **Chapter 2: Basic Installation**  
This chapter lists the hardware setup procedures that you have to perform when installing system components.
- **Chapter 3: BIOS Setup**  
This chapter tells how to change system settings through the BIOS Setup menus. Detailed descriptions of the BIOS parameters are also provided.
- **Chapter 4: RAID Support**  
This chapter describes the RAID configurations.
- **Chapter 5: Multi GPU Support**  
This chapter describes how to install and configure multiple AMD® CrossFire™ graphics cards.

## Where to find more information

Refer to the following sources for additional information and for product and software updates.

1. **ASUS website**  
The ASUS website ([www.asus.com](http://www.asus.com)) provides updated information on ASUS hardware and software products.
2. **Optional documentation**  
Your product package may include optional documentation, such as warranty flyers, that may have been added by your dealer. These documents are not part of the standard package.

## Conventions used in this guide

To ensure that you perform certain tasks properly, take note of the following symbols used throughout this manual.



**DANGER/WARNING:** Information to prevent injury to yourself when trying to complete a task.



**CAUTION:** Information to prevent damage to the components when trying to complete a task.



**IMPORTANT:** Instructions that you **MUST** follow to complete a task.



**NOTE:** Tips and additional information to help you complete a task.

## Typography

**Bold text**

Indicates a menu or an item to select.

*Italics*

Used to emphasize a word or a phrase.

<Key>

Keys enclosed in the less-than and greater-than sign means that you must press the enclosed key.

Example: <Enter> means that you must press the Enter or Return key.

<Key1> + <Key2> + <Key3>

If you must press two or more keys simultaneously, the key names are linked with a plus sign (+).



## ROG STRIX B450-F GAMING specifications summary

<b>CPU</b>	<p>AM4 socket for AMD Ryzen™ 2nd Generation / Ryzen™ with Radeon™ Vega Graphics / Ryzen™ 1st Generation</p> <p>* Refer to <a href="http://www.asus.com">www.asus.com</a> for the AMD® CPU support list.</p>
<b>Chipset</b>	AMD® B450 Chipset
<b>Memory</b>	<p>4 x DIMM, max. 64GB, DDR4 3200(O.C.) / 3000(O.C.) / 2933(O.C.) / 2800(O.C.) / 2666 / 2400 / 2133 MHz, un-buffered memory</p> <p><b>Dual channel memory architecture</b></p> <p>* Refer to <a href="http://www.asus.com">www.asus.com</a> for the Memory QVL (Qualified Vendors List).</p>
<b>Graphics</b>	<p><b>Integrated Graphics in the AMD Ryzen™ with Radeon™ Vega Graphics</b></p> <p>Multi-VGA output support: HDMI and DisplayPort ports</p> <ul style="list-style-type: none"> <li>- Supports HDMI 2.0a with maximum resolution of 4096 x 2160@60Hz</li> <li>- Supports DisplayPort 1.2 with maximum resolution of 4096 x 2160@60Hz</li> </ul>
<b>Multi-GPU Support</b>	<p><b>AMD Ryzen™ 2nd Generation / Ryzen™ 1st Generation Processors</b></p> <p>Supports AMD® 3-way CrossFireX™ Technology</p>
<b>Expansion slots</b>	<p><b>AMD Ryzen™ 2nd Generation/Ryzen™ 1st Generation Processors</b></p> <p>2 x PCIe 3.0 x 16 SafeSlots (support x16, x8/x4 modes)</p> <p><b>AMD Ryzen™ with Radeon™ Vega Graphics</b></p> <p>1 x PCIe 3.0 x 16 SafeSlot (supports x8 mode)</p> <p><b>AMD® B450 chipset</b></p> <p>1 x PCIe 2.0 x 16 slot (max. at x4 mode)*</p> <p>3 x PCIe 2.0 x 1 slots</p> <p>* PCIe x16_3 slot shares bandwidth with PCIe x1_2 and PCIe x1_3.</p>
<b>Storage</b>	<p><b>AMD Ryzen™ 2nd Generation / Ryzen™ 1st Generation Processors*</b></p> <ul style="list-style-type: none"> <li>- M.2_1 socket 3 with M Key, Type 2242/2260/2280 (PCIe 3.0 x 4 and SATA modes) storage devices support**</li> <li>- M.2_2 socket 3 with M Key, Type 2242/2260/2280/22110 (PCIe 3.0 x 4 mode) storage devices support***</li> <li>- 2 x SATA 6Gb/s ports</li> </ul> <p><b>AMD Ryzen™ with Radeon™ Vega Graphics</b></p> <ul style="list-style-type: none"> <li>- M.2_1 socket 3 with M Key, Type 2242/2260/2280(PCIe 3.0 x 4 and SATA modes) storage devices support</li> <li>- 2 x SATA 6Gb/s ports</li> </ul> <p><b>AMD® B450 Chipset:</b></p> <ul style="list-style-type: none"> <li>- 4 x SATA 6Gb/s ports</li> </ul> <p>* Support <b>SoreMI</b> and <b>NVMe RAID</b></p> <p>** When the M.2_1 Socket 3 is operating in SATA or PCIe mode, SATA6G_5/6 ports will be disabled.</p> <p>*** When the M.2_2 is occupied by M.2 device, PCIe x16_1 will run at x8 mode.</p>

(continued on the next page)

## ROG STRIX B450-F GAMING specifications summary

LAN	<p>Intel® Ethernet Controller I211-AT          Anti-surge LANGuard          ROG GameFirst technology</p>
Audio	<p><b>SupremeFX S1220A 8-Channel High Definition Audio CODEC</b></p> <ul style="list-style-type: none"> <li>- Supports up to 32-Bit/192kHz playback*</li> <li>- High quality 120 dB SNR stereo playback output and 113 dB SNR recording input</li> <li>- Impedance sense for front and rear headphone outputs</li> <li>- SupremeFX Shielding Technology</li> <li>- Dual OP Amplifiers</li> <li>- Jack-detection, Multi-streaming, and Front Panel Jack-retasking</li> </ul> <p><b>Audio Feature:</b></p> <ul style="list-style-type: none"> <li>- Sonic Studio III + Sonic Studio Link</li> <li>- Sonic Radar III</li> <li>- Optical S/PDIF out port at back panel</li> </ul> <p>* Due to limitations in HDA bandwidth, 32-Bit/192kHz is not supported for 8-Channel audio.</p>
USB	<p><b>AMD® B450 chipset</b></p> <ul style="list-style-type: none"> <li>- 2 x USB 3.1 Gen 2 ports (2 ports at back panel [red])</li> <li>- 6 x USB 3.1 Gen 1 ports (4 ports at back panel [3 x Type-A and 1 x Type-C™], 2 ports at mid-board)</li> <li>- 6 x USB 2.0 ports ( 2 ports at back panel, 4 ports at mid-board)</li> </ul>
ROG Exclusive Features	<p>ROG RAMCache II          ROG GameFirst IV*          ROG Overwolf          ROG CPU-Z</p>

*(continued on the next page)*

# ROG STRIX B450-F GAMING specifications summary

<b>Special Features</b>	<p><b>Digi+VRM</b> <b>EPU</b> <b>TPU APP</b> <b>Fan Xpert 4</b> <b>ASUS EZ DIY</b></p> <ul style="list-style-type: none"><li>- ASUS CrashFree BIOS 3</li><li>- ASUS EZ Flash 3</li></ul> <p><b>ASUS Q-Design</b></p> <ul style="list-style-type: none"><li>- Q-LED (CPU, DRAM, VGA, Boot Device LED)</li><li>- Q-Slot</li><li>- Q-DIMM</li></ul> <p><b>Gamer's Guardian</b></p> <ul style="list-style-type: none"><li>- Pre-Mounted I/O Shield</li><li>- SafeSlot</li><li>- DRAM Overcurrent Protection</li><li>- ESD Guards on LAN, Audio, KBMS and USB ports</li><li>- Highly Durable Components</li></ul> <p><b>ASUS Exclusive Features</b></p> <ul style="list-style-type: none"><li>- AURA Lighting Control</li><li>- AI Suite 3</li><li>- AI Charger</li><li>- ASUS Grid</li></ul>
<b>Back I/O Ports</b>	<ul style="list-style-type: none"><li>1 x PS/2 Keyboard/Mouse Combo port</li><li>1 x HDMI 2.0a port</li><li>1 x DisplayPort</li><li>2 x USB 3.1 Gen 2 ports (2 x Type-A [red] )</li><li>4 x USB 3.1 Gen 1 ports (3 x Type-A [blue] and 1 x Type-C™)</li><li>2 x USB 2.0 ports</li><li>1 x Anti-surge LAN (RJ45) port</li><li>1 x Optical S/PDIF out</li><li>5 x Audio jacks</li></ul>

*(continued on the next page)*

## ROG STRIX B450-F GAMING specifications summary

<b>Internal I/O Ports</b>	<ul style="list-style-type: none"> <li>1 x USB 3.1 Gen 1 connector supports additional 2 USB 3.1 Gen 1 ports</li> <li>2 x USB 2.0 connectors support additional 4 USB 2.0 ports</li> <li>1 x TPM header</li> <li>6 x SATA 6Gb/s connectors</li> <li>1 x M.2_1 Socket 3 for M Key, type 2242/2260/2280 devices support, (supports PCIE and SATA modes)</li> <li>1 x M.2_2 Socket 3 for M Key, type 2242/2260/2280/22110 devices support, (supports PCIE mode)</li> <li>1 x 4-Pin CPU fan connector</li> <li>1 x 4-Pin CPU_OPT fan connector</li> <li>1 x 4-Pin AIO_PUMP connector</li> <li>3 x 4-Pin Chassis fan connectors</li> <li>1 x Thermal sensor connector</li> <li>2 x AURA RGB headers</li> <li>1 x 24-pin EATX power connector</li> <li>1 x 8-pin EATX 12V power connector</li> <li>1 x System panel connector</li> <li>1 x Front panel audio connector (AAFP)</li> <li>1 x COM header</li> <li>1 x 2-Pin Clear CMOS jumper</li> </ul>
<b>BIOS</b>	128 Mb Flash ROM, UEFI AMI BIOS, PnP, SM BIOS 2.8, ACPI 6.0, Multi-language BIOS, ASUS EZ Flash 3, CrashFree BIOS 3, F11 EZ Tuning Wizard, F6 Qfan Control, F3 My Favorites, Last Modified log, F12 PrintScreen, Secure Erase, ASUS User Profile, F4 AURA ON/OFF, F9 Search, and ASUS DRAM SPD (Serial Presence Detect) memory information
<b>Manageability</b>	WOL, PXE, WOR
<b>Software</b>	<ul style="list-style-type: none"> <li>Drivers</li> <li>ASUS Utilities</li> <li>Anti-virus software (OEM version)</li> </ul>
<b>Operating system support</b>	Windows® 10 64-bit
<b>Form factor</b>	ATX Form Factor, 12 inch x 9.6 inch (30.5cm x 24.4cm)



Specifications are subject to change without notice. Please refer to the ASUS website for the latest specifications.

# Package contents

Check your motherboard package for the following items.

Motherboard	1 x ROG STRIX B450-F GAMING motherboard
Cables	4 x SATA 6Gb/s Cables 1 x Extension cable for RGB strips (80cm)
Accessories	2 x M.2 Screw Packages 1 x Strix door hanger 1 x ROG Strix stickers 1 x cable tie package 1 x Replaceable PCH nameplate*
Application drive	1 x ROG motherboard support DVD
Documentation	1 x User guide

\* You may replace the default PCH nameplate with the replaceable PCH nameplate.



Please note that removing the default PCH nameplate may cause damage to the default nameplate.



If any of the above items is damaged or missing, contact your retailer.

# Installation tools and components

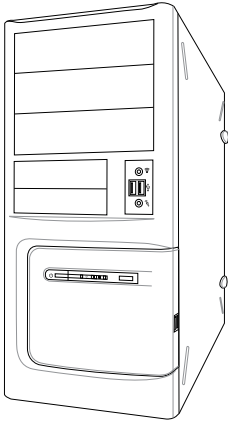

PC chassis

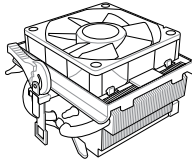

AMD® AM4/AM3 compatible CPU Fan

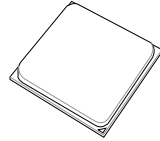

AMD® AM4 CPU

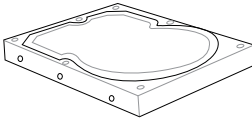

SATA hard disk drive



Phillips (cross) screwdriver

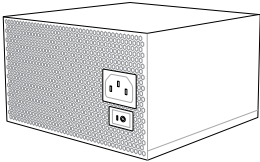

Power supply unit

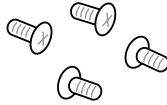

1 bag of screws

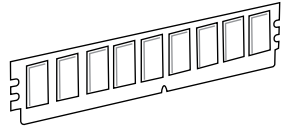

DIMM

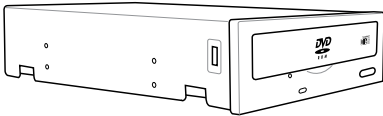

SATA optical disc drive (optional)

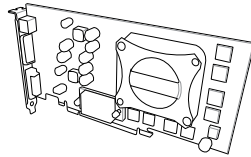

Graphics card



---

The tools and components listed above are not included in the motherboard package.

---

# Product Introduction

# 1

## 1.1 Motherboard overview

### 1.1.1 Before you proceed

Take note of the following precautions before you install motherboard components or change any motherboard settings.



- 
- Unplug the power cord from the wall socket before touching any component.
  - Before handling components, use a grounded wrist strap or touch a safely grounded object or a metal object, such as the power supply case, to avoid damaging them due to static electricity.
  - Hold components by the edges to avoid touching the ICs on them.
  - Whenever you uninstall any component, place it on a grounded antistatic pad or in the bag that came with the component.
  - Before you install or remove any component, ensure that the ATX power supply is switched off or the power cord is detached from the power supply. Failure to do so may cause severe damage to the motherboard, peripherals, or components.
-

## 1.1.2 Motherboard layout

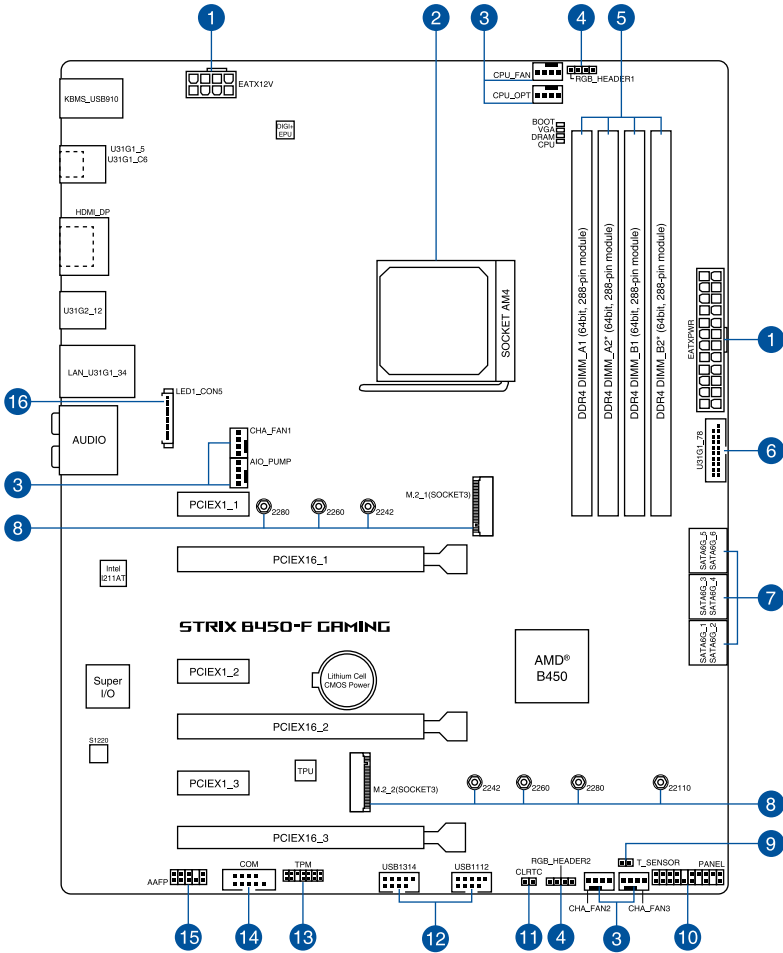

Refer to **1.1.8 Internal connectors** and **2.2.1 Rear I/O connection** for more information about rear panel connectors and internal connectors.



## Layout contents

Connectors/Jumpers/Slots	Page
1. ATX power connectors (24-pin EATXPWR; 8-pin EATX12V)	1-19
2. AM4 CPU socket	1-4
3. Fan and pump connectors (4-pin CPU_FAN; 4-pin CPU_OPT; 4-pin CHA_FAN1-3; 4-pin AIO_PUMP)	1-18
4. AURA RGB header (4-pin RGB_HEADER1-2)	1-17
5. DDR4 DIMM slots	1-5
6. USB 3.1 Gen 1 connector (20-1 pin U31G1_78)	1-16
7. AMD® Serial ATA 6.0 Gb/s connectors (7-pin SATA6G_1-6)	1-11
8. M.2 sockets (M.2_1; M.2_2)	1-14
9. Thermal sensor connector (2-pin T_SENSOR)	1-13
10. System panel connector (20-3 pin PANEL)	1-20
11. Clear RTC RAM jumper (2-pin CLRRTC)	1-9
12. USB 2.0 connectors (10-1 pin USB1112, USB1314)	1-15
13. TPM connector (14-1 pin TPM)	1-13
14. Serial port connector (10-1 pin COM)	1-12
15. Front panel audio connector (10-1 pin AAFP)	1-12
16. LED connector (13-pin LED1_CON5)	1-16

### 1.1.3 Central Processing Unit (CPU)

The motherboard comes with an AM4 socket designed for AMD Ryzen™ 2nd Generation / Ryzen™ 1st Generation / Ryzen™ with Radeon™ Vega Graphics.

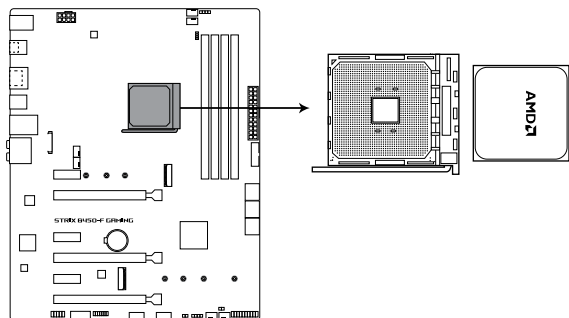

**ROG STRIX B450-F GAMING CPU AM4**



---

The AM4 socket has a different pinout design. Ensure that you use a CPU designed for the AM4 socket. The CPU fits in only one correct orientation. **DO NOT** force the CPU into the socket to prevent bending the connectors on the socket and damaging the CPU!

---



---

Ensure that all power cables are unplugged before installing the CPU.

---

## 1.1.4 System memory

The motherboard comes with four (4) DDR4 (Double Data Rate 4) Quad Inline Memory Modules (DIMM) slots.



A DDR4 module is notched differently from a DDR, DDR2, or DDR3 module. DO NOT install a DDR, DDR2, or DDR3 memory module to the DDR4 slot.

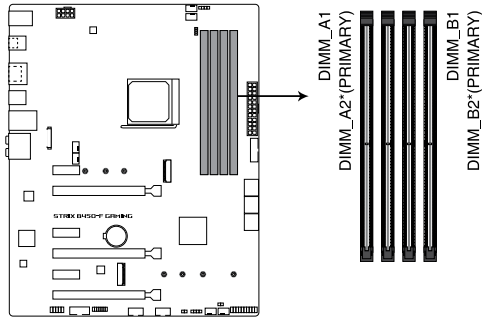

ROG STRIX B450-F GAMING 288-pin DDR4 DIMM socket

### Recommended memory configurations

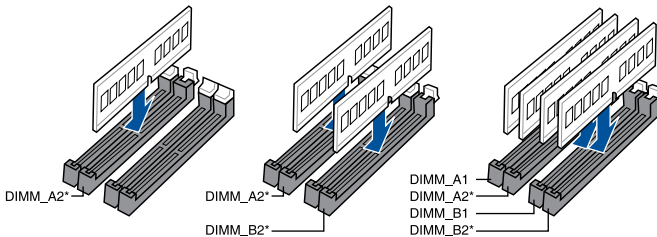

The recommended memory DIMM slots are marked with an asterisk (\*).

## Memory configurations

You may install 2 GB, 4 GB, 8 GB, and 16 GB unbuffered and non-ECC DDR4 DIMMs into the DIMM sockets.



---

You may install varying memory sizes in Channel A and Channel B. The system maps the total size of the lower-sized channel for the dual-channel configuration. Any excess memory from the higher-sized channel is then mapped for single-channel operation.

---



- The default memory operation frequency is dependent on its Serial Presence Detect (SPD), which is the standard way of accessing information from a memory module. Under the default state, some memory modules for overclocking may operate at a lower frequency than the vendor-marked value.
  - For system stability, use a more efficient memory cooling system to support a full memory load (4 DIMMs) or overclocking condition.
  - Always install the DIMMS with the same CAS Latency. For an optimum compatibility, we recommend that you install memory modules of the same version or data code (D/C) from the same vendor. Check with the vendor to get the correct memory modules.
-

## 1.1.5 Expansion slots



Unplug the power cord before adding or removing expansion cards. Failure to do so may cause you physical injury and damage motherboard components.

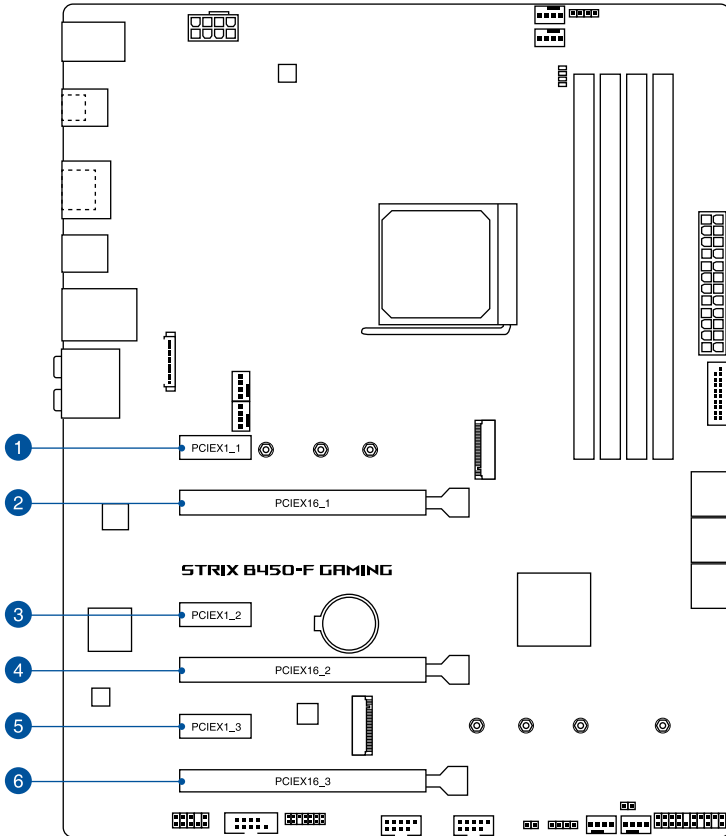

Slot No.	Slot Description
1	PCIEX1_1 slot
2	PCIEX16_1 slot
3	PCIEX1_2 slot
4	PCIEX16_2 slot
5	PCIEX1_3 slot
6	PCIEX16_3 slot

CPU Family	PCIe operating mode				
	PCIE_X16_1	PCIE_X16_2	M.2_2	M.2_1 (PCIe mode)	M.2_1 (SATA mode)
AMD Ryzen™ 1st / 2nd Generation Processors	X16	N/A	N/A	X4	Support
	X8	X4	X4	X4	Support
AMD Ryzen™ with Radeon™ Vega Graphics Processors	X8	N/A	N/A	X4	Support

### AMD Ryzen™ 1st/ 2nd Generation Processors

VGA Configuration	PCIe operating mode	
	PCIE_X16_1	PCIE_X16_2
Single VGA/PCIe card	x16	N/A
Dual VGA/PCIe card	x8	x4

### AMD Ryzen™ with Radeon™ Vega Graphics Processors

VGA Configuration	PCIe operating mode		
	PCIE_X16_1	PCIE_X16_2	PCIE_X16_3
Single VGA/PCIe card	x8	N/A	N/A
Dual VGA/PCIe card	x8	N/A	x4 (PCI Express 2.0 from chipset)



- We recommend that you provide sufficient power when running CrossFireX™ mode.
- Connect chassis fans to the motherboard chassis fan connectors when using multiple graphics cards for better thermal environment.

## 1.1.6 Jumper

### 1. Clear RTC RAM jumper (2-pin CLRRTC)

This jumper allows you to clear the Real Time Clock (RTC) RAM in CMOS. You can clear the CMOS memory of date, time, and system setup parameters by erasing the CMOS RTC RAM data. The onboard button cell battery powers the RAM data in CMOS, which include system setup information such as system passwords.

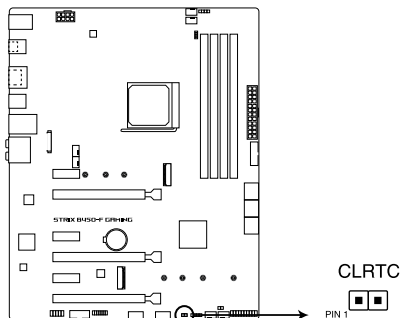

**ROG STRIX B450-F GAMING Clear RTC RAM jumper**

To erase the RTC RAM:

1. Turn OFF the computer and unplug the power cord.
2. Short-circuit pin 1-2 with a metal object or jumper cap for about 5-10 seconds.
3. Plug the power cord and turn ON the computer.
4. Hold down the <Delete> key during the boot process and enter BIOS setup to re-enter data.



Except when clearing the RTC RAM, never remove the cap on CLRRTC jumper default position. Removing the cap will cause system boot failure!



- If the steps above do not help, remove the onboard battery and move the jumper again to clear the CMOS RTC RAM data. After the CMOS clearance, reinstall the battery.
- You do not need to clear the RTC when the system hangs due to overclocking. For system failure due to overclocking, use the C.P.R. (CPU Parameter Recall) feature. Shut down and reboot the system so the BIOS can automatically reset parameter settings to default values.
- Due to the chipset behavior, AC power off is required to enable C.P.R. function. You must turn off and on the power supply or unplug and plug the power cord before rebooting the system.

## 1.1.7 Onboard LEDs

### 1. Q LEDs (CPU, DRAM, VGA, BOOT)

Q LEDs check key components (CPU, DRAM, VGA card, and booting devices) in sequence during motherboard booting process. If an error is found, the corresponding LED remains lit until the problem is solved. This user-friendly design provides an intuitive way to locate the root problem within seconds.

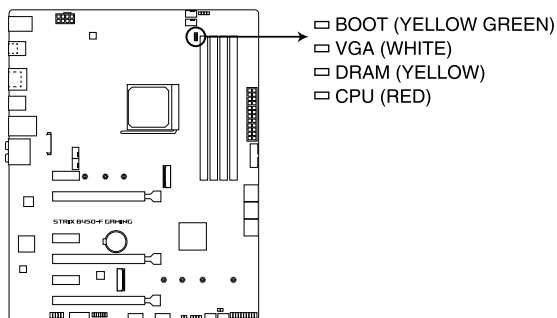

**ROG STRIX B450-F GAMING**  
**CPU/ DRAM/ BOOT\_DEVICE/ VGA LED**



---

The Q LEDs provide the most probable cause of an error code as a starting point for troubleshooting. The actual cause may vary from case to case.

---



## 1.1.8 Internal connectors

### 1. AMD® Serial ATA 6.0 Gb/s connectors (7-pin SATA6G\_1-6)

These connectors connect to Serial ATA 6.0 Gb/s hard disk drives via Serial ATA 6.0 Gb/s signal cables.

If you installed Serial ATA hard disk drives, you can create a RAID 0, 1, and 10 configuration through the onboard AMD® B450 chipset.

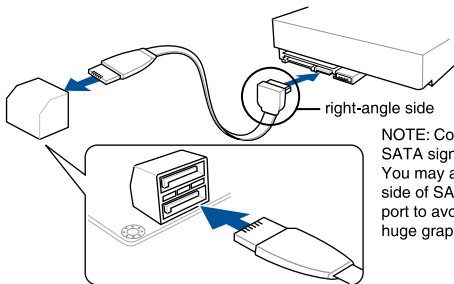
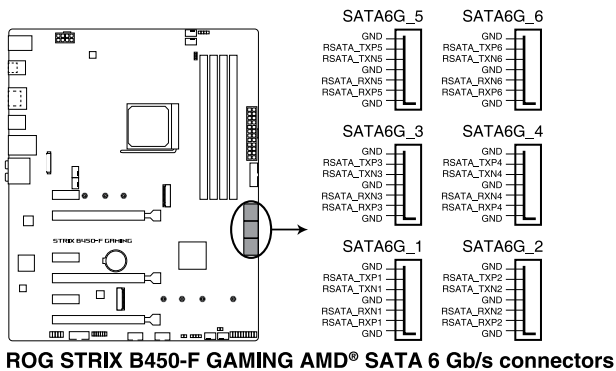

- These connectors are set to **[AHCI]** by default. If you intend to create a Serial ATA RAID set using these connectors, set the SATA Mode Selection item in the BIOS to **[RAID]**.
- Before creating a RAID set, refer to the **RAID Configuration Guide**. You can download the **RAID Configuration Guide** from the ASUS website.

## 2. Front panel audio connector (10-1 pin AAFP)

This connector is for a chassis-mounted front panel audio I/O module that supports HD Audio standard. Connect one end of the front panel audio I/O module cable to this connector.

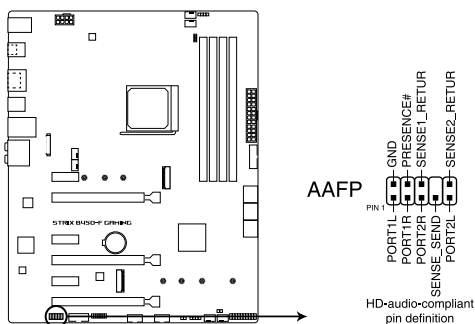

**ROG STRIX B450-F GAMING Analog front panel connector**



We recommend that you connect a high-definition front panel audio module to this connector to avail of the motherboard's high-definition audio capability.

## 3. Serial port connector (10-1 pin COM)

This connector is for a serial (COM) port. Connect the serial port module cable to this connector, then install the module to a slot opening at the back of the system chassis.

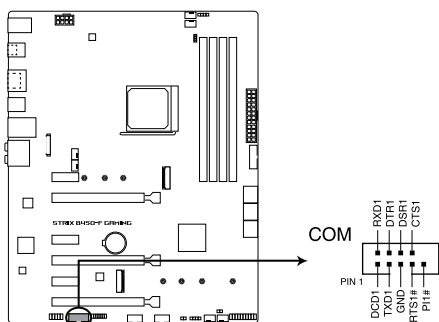

**ROG STRIX B450-F GAMING Serial port connector**



The COM module is purchased separately.

#### 4. TPM connector (14-1 pin TPM)

This connector supports a Trusted Platform Module (TPM) system, which securely stores keys, digital certificates, passwords and data. A TPM system also helps enhance network security, protect digital identities, and ensures platform integrity.

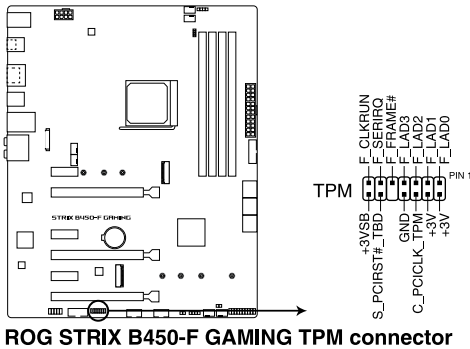

The TPM module is purchased separately.

#### 5. Thermal sensor connector (2-pin T\_SENSOR)

This connector is for the thermistor cable that allows you to monitor the temperature of your motherboard's critical components and connected devices.

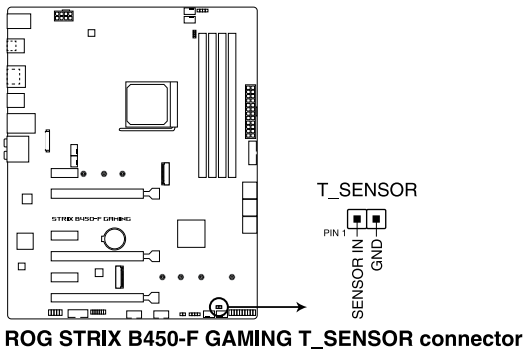

## 6. M.2 socket (M.2\_1; M.2\_2)

These sockets allow you to install M.2 SSD modules.

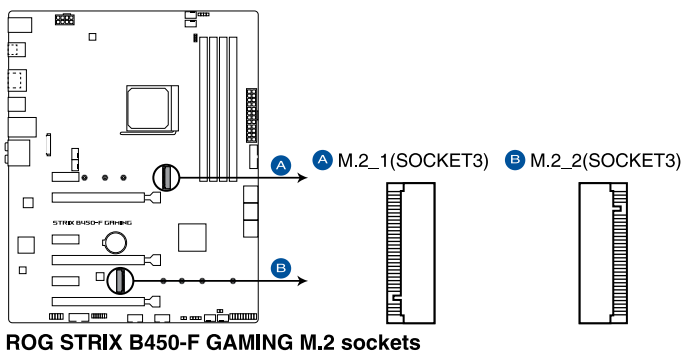

- For AMD Ryzen™ 2nd Generation / Ryzen™ 1st Generation Processors:
  - M.2\_1 supports PCIe 3.0 x4 and SATA mode M Key design and type 2242 / 2260 / 2280 storage devices.
  - M.2\_2 supports PCIe 3.0 x4 M Key design and type 2242 / 2260 / 2280 / 22110 storage devices\*.
- For AMD Ryzen™ with Radeon™ Vega Graphics Processors\*\*
  - M.2\_1 supports PCIe 3.0 x4 and SATA mode M Key design and type 2242 / 2260 / 2280 storage devices.
  - \* M.2\_2 socket shares bandwidth with PCIe x16. When M.2\_2 slot runs in PCIe mode, the PCIe x16\_1 slot will run at x8 mode.
  - \*\* The M.2\_2 socket is not supported for these CPU



The M.2 SSD module is purchased separately.

## 7. USB 2.0 connectors (10-1 pin USB1112, USB1314)

These connector are for USB 2.0 ports. Connect the USB module cable to these connectors, then install the module to a slot opening at the back of the system chassis. This USB connector complies with USB 2.0 specification that supports up to 480 Mb/s connection speed.

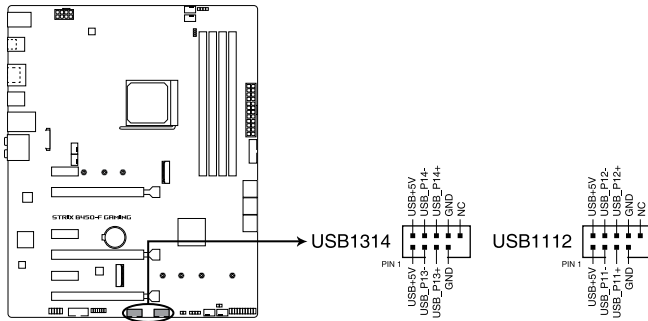

**ROG STRIX B450-F GAMING USB 2.0 connectors**



DO NOT connect a 1394 cable to the USB connectors. Doing so will damage the motherboard!



The USB 2.0 module is purchased separately.

## 8. USB 3.1 Gen 1 connectors (20-pin U31G1\_78)

This connector allows you to connect a USB 3.1 Gen 1 module for additional USB 3.1 Gen 1 front or rear panel ports. With an installed USB 3.1 Gen 1 module, you can enjoy all the benefits of USB 3.1 Gen 1 including faster data transfer speeds of up to 5 Gbps, faster charging time for USB-chargeable devices, optimized power efficiency, and backward compatibility with USB 2.0.

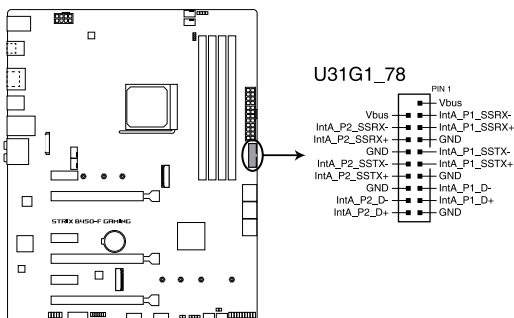

**ROG STRIX B450-F GAMING USB 3.1 Gen 1 connector**



The USB 3.1 Gen 1 module is purchased separately.

## 9. LED connector (13-pin LED1\_CON5)

This connector is for connecting LED strips on your cover.

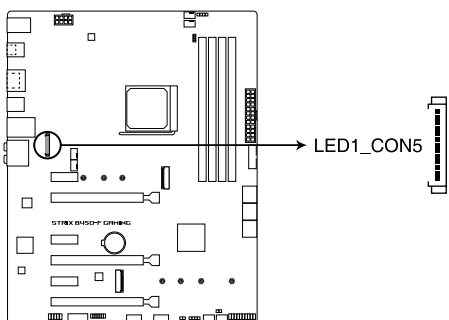

**ROG STRIX B450-F GAMING LED card connector**

## 10. AURA RGB headers (4-pin RGB\_HEADER1-2)

These connectors are for RGB LED strips.

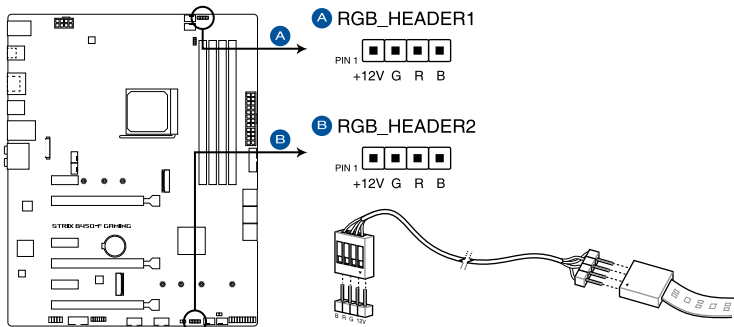

**ROG STRIX B450-F GAMING RGB\_HEADER connectors**



The RGB header supports 5050 RGB multi-color LED strips (12V/G/R/B), with a maximum power rating of 3A (12V), and no longer than 3 m.



Before you install or remove any component, ensure that the ATX power supply is switched off or the power cord is detached from the power supply. Failure to do so may cause severe damage to the motherboard, peripherals, or components.



- Actual lighting and color will vary with LED strip.
- If your LED strip does not light up, check if the RGB LED extension cable and the RGB LED strip is connected in the correct orientation, and the 12V connector is aligned with the 12V header on the motherboard.
- The LED strip will only light up when the system is operating.
- The LED strip is purchased separately.

## 11. Fan and pump connectors (4-pin CPU\_FAN; 4-pin CPU\_OPT; 4-pin CHA\_FAN1-3; 4-pin AIO\_PUMP)

Connect the fan cables to the fan connectors on the motherboard, ensuring that the black wire of each cable matches the ground pin of the connector.

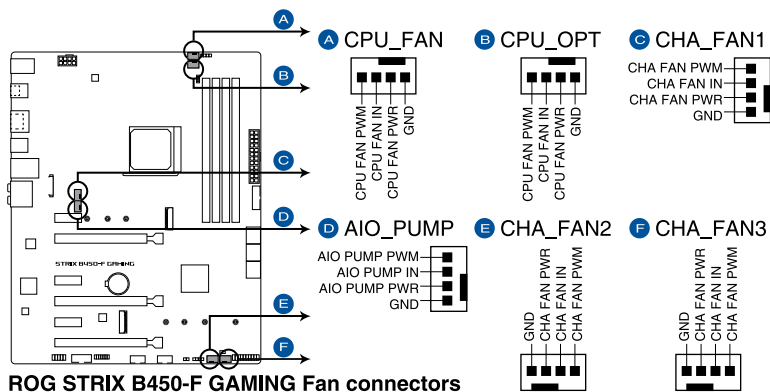

- DO NOT forget to connect the fan cables to the fan connectors. Insufficient air flow inside the system may damage the motherboard components. These are not jumpers! Do not place jumper caps on the fan connectors!
- Ensure that the CPU fan cable is securely installed to the CPU fan connector.



Connect the pump cable from the all-in-one cooler (AIO cooler) to the AIO\_PUMP header, and connect the fan cables to the CPU\_FAN and CHA\_fan1 headers.



## 12. ATX power connectors (24-pin EATXPWR; 8-pin EATX12V)

These connectors are for ATX power supply plugs. The power supply plugs are designed to fit these connectors in only one orientation. Find the proper orientation and push down firmly until the connectors completely fit.

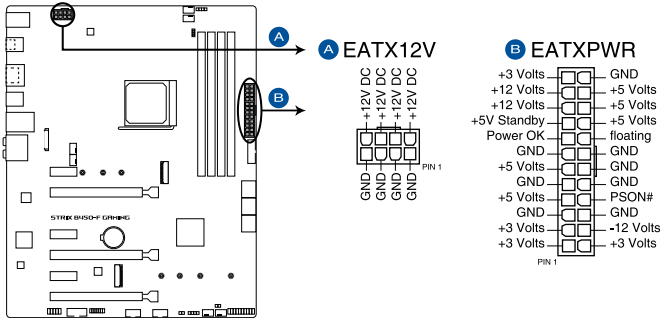

**ROG STRIX B450-F GAMING ATX power connectors**



- For a fully configured system, we recommend that you use a power supply unit (PSU) that complies with ATX 12 V Specification 2.0 (or later version) and provides a minimum power of 350 W.
- DO NOT forget to connect the 8-pin EATX12V power plug. Otherwise, the system will not boot.
- We recommend that you use a PSU with a higher power output when configuring a system with more power-consuming devices. The system may become unstable or may not boot up if the power is inadequate.
- If you want to use two or more high-end PCI Express x16 cards, use a PSU with 1000W power or above to ensure the system stability.

### 13. System panel connector (20-3 pin PANEL)

This connector supports several chassis-mounted functions.

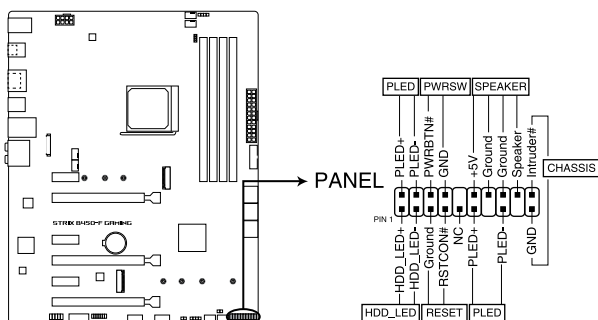

**ROG STRIX B450-F GAMING System panel connector**

- **System power LED (2-pin or 3-1 pin PLED)**

The 2-pin or 3-1 pin connector is for the system power LED. Connect the chassis power LED cable to this connector. The system power LED lights up when you turn on the system power, and blinks when the system is in sleep mode.

- **Hard disk drive activity LED (2-pin HDD\_LED)**

This 2-pin connector is for the HDD Activity LED. Connect the HDD Activity LED cable to this connector. The HDD LED lights up or flashes when data is read from or written to the HDD.

- **System warning speaker (4-pin SPEAKER)**

This 4-pin connector is for the chassis-mounted system warning speaker. The speaker allows you to hear system beeps and warnings.

- **ATX power button/soft-off button (2-pin PWRSW)**

This connector is for the system power button. Pressing the power button turns the system on or puts the system in sleep or soft-off mode depending on the operating system settings. Pressing the power switch for more than four seconds while the system is ON turns the system OFF.

- **Reset button (2-pin RESET)**

This 2-pin connector is for the chassis-mounted reset button for system reboot without turning off the system power.

- **Chassis intrusion connector (2-pin CHASSIS)**

This connector is for a chassis-mounted intrusion detection sensor or switch. Connect one end of the chassis intrusion sensor or switch cable to this connector. The chassis intrusion sensor or switch sends a high-level signal to this connector when a chassis component is removed or replaced. The signal is then generated as a chassis intrusion event.

# Basic Installation

# 2

## 2.1 Building your PC system



The diagrams in this section are for reference only. The motherboard layout may vary with models, but the installation steps are the same for all models.

### 2.1.1 CPU installation



The AMD AM4 socket is compatible with AMD AM4 processors. Ensure you use a CPU designed for the AM4 socket. The CPU fits in only one correct orientation. **DO NOT** force the CPU into the socket to prevent bending the connectors on the socket and damaging the CPU!

1

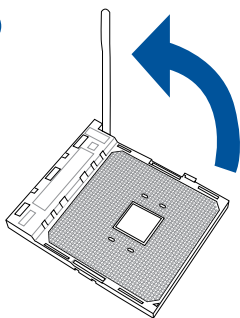

2

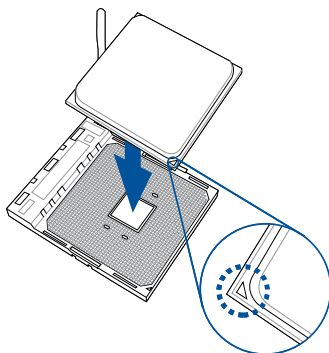

3

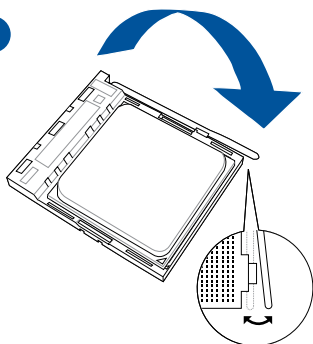

## 2.1.2 Cooling system installation



Apply the Thermal Interface Material to the CPU cooling system and CPU before you install the cooling system, if necessary.

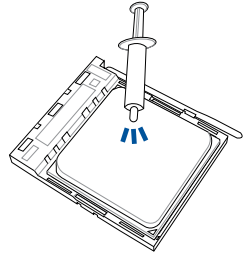

### CPU heatsink and fan assembly Type 1

1

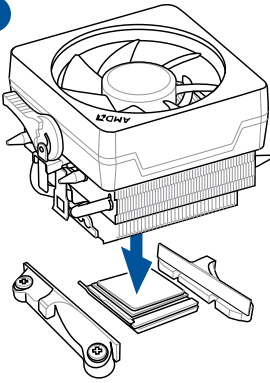

2

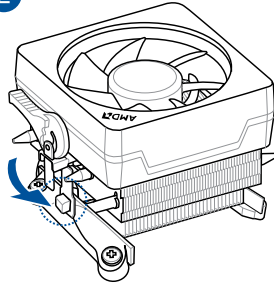

3

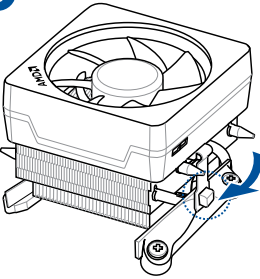

4

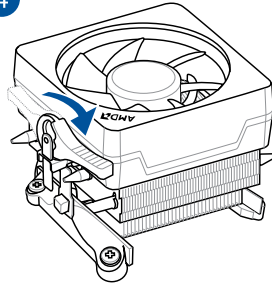

5

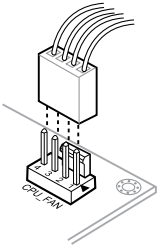

## CPU heatsink and fan assembly Type 2

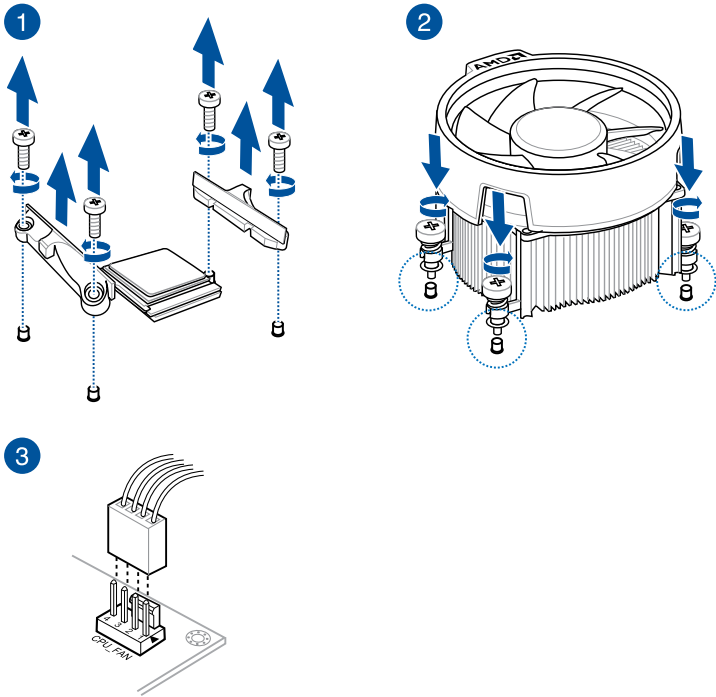

When using this type of CPU fan, remove the screws and the retention module only. Do not remove the plate on the bottom.

## To install an AIO cooler

1

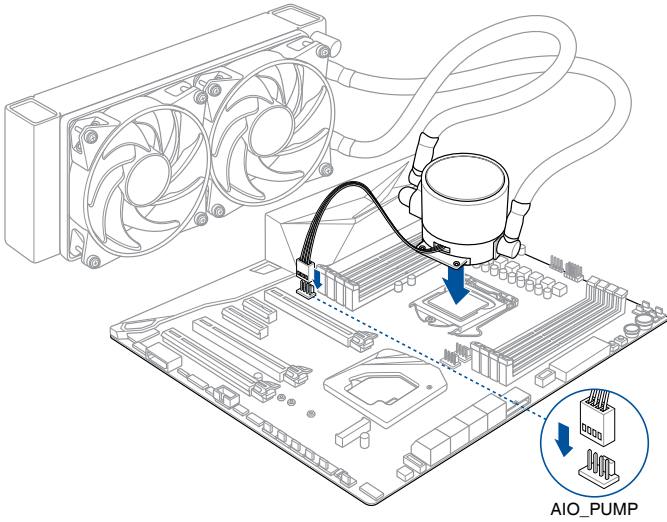

2

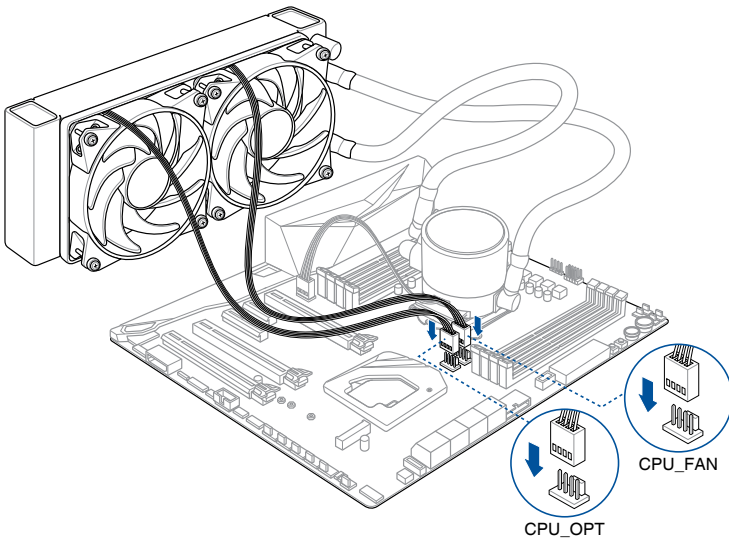

## 2.1.3 Motherboard installation

1. Place the motherboard into the chassis, ensuring that its rear I/O ports are aligned to the chassis' rear I/O panel.

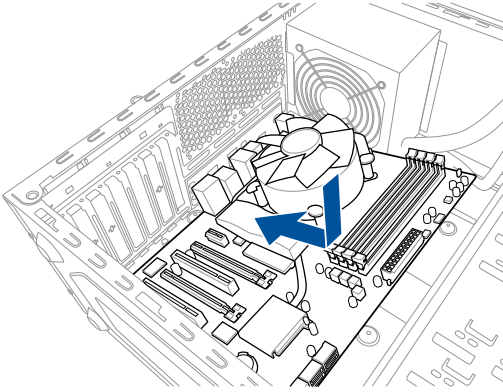

2. Place nine (9) screws into the holes indicated by circles to secure the motherboard to the chassis.

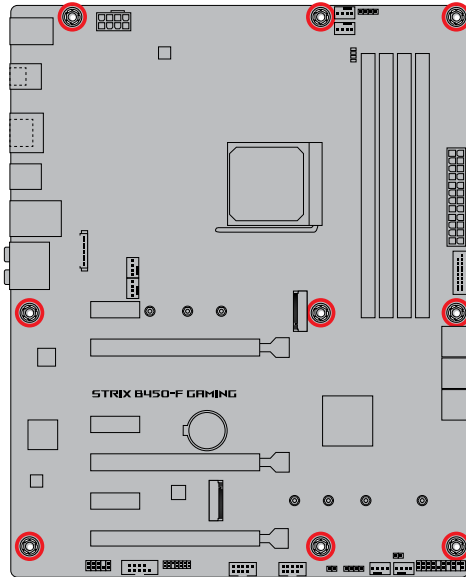
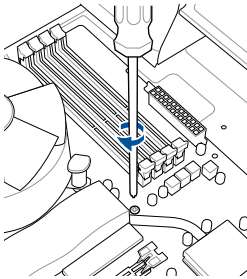

DO NOT over tighten the screws! Doing so can damage the motherboard.

## 2.1.4 DIMM installation

1

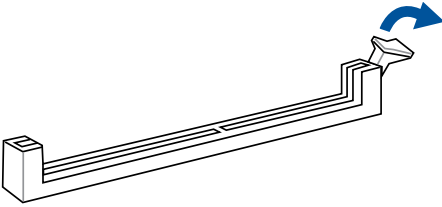

2

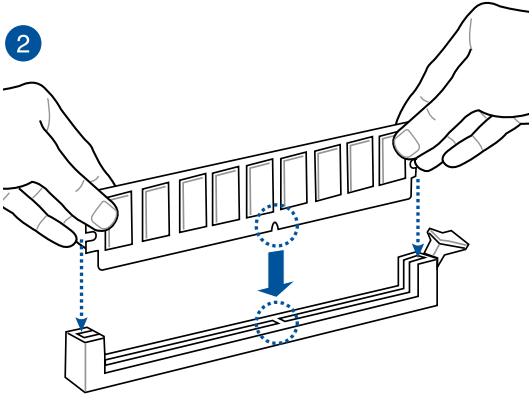

3

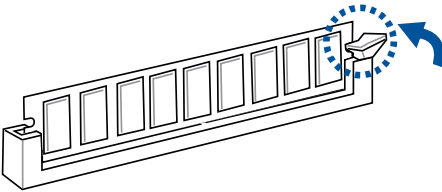

To remove a DIMM

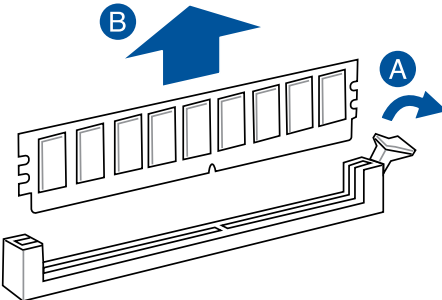



## 2.1.5 ATX power connection

1

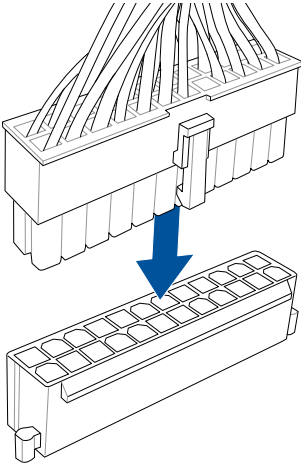

2

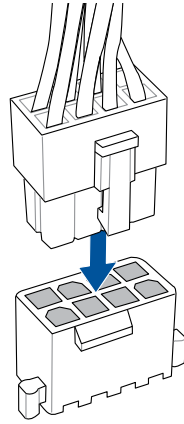

Ensure to connect the 8-pin power plug.

## 2.1.6 SATA device connection

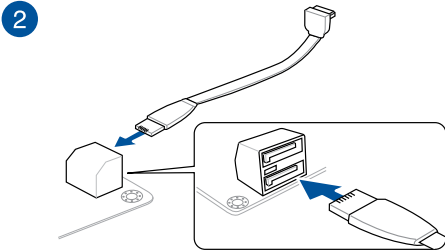
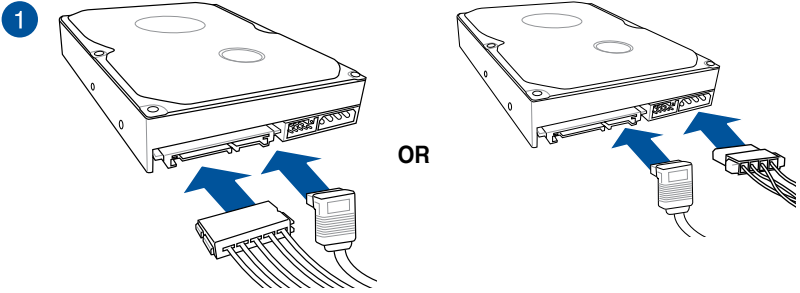

## 2.1.7 Front I/O connector

To install front panel connector

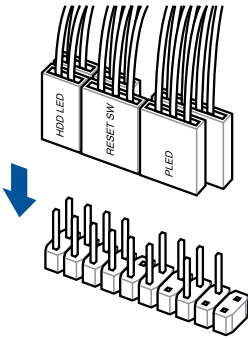

To install front panel audio connector

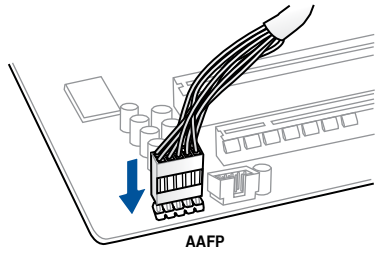

To install USB 3.1 Gen 1 connector

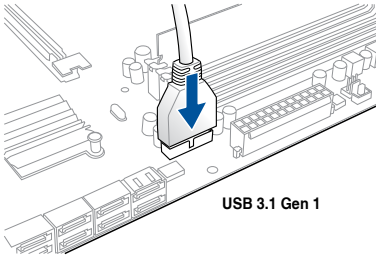

To install USB 2.0 connector

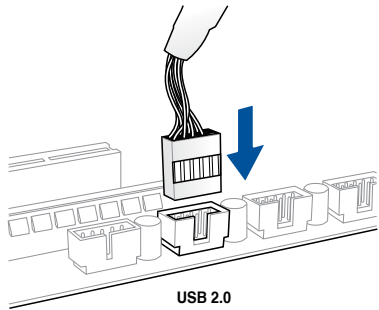

## 2.1.8 Expansion card installation

To install PCIe x16 cards

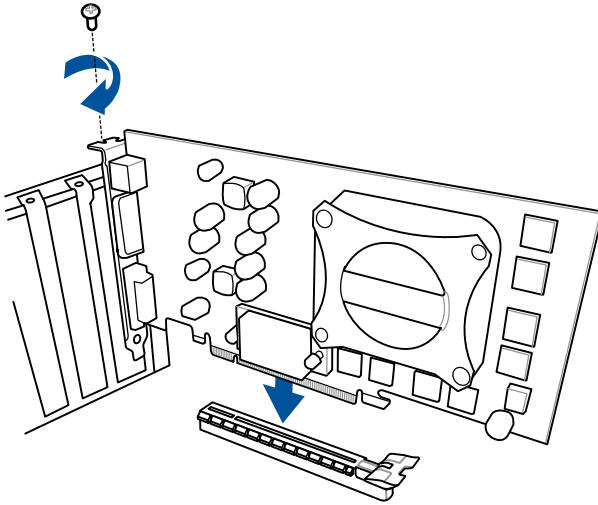

To install PCIe x1 cards

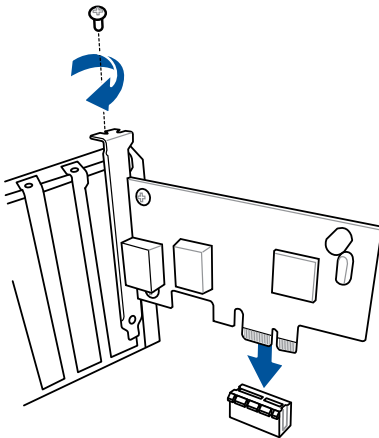

## 2.1.9 M.2 installation

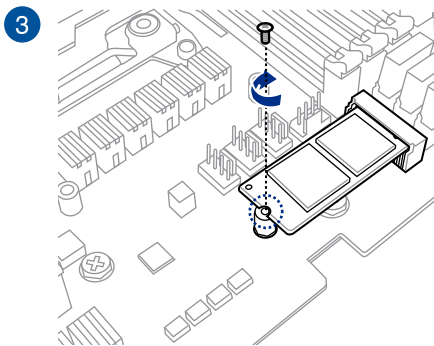
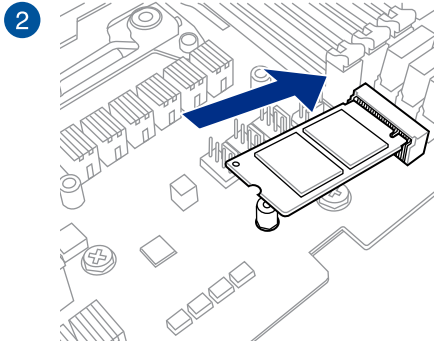
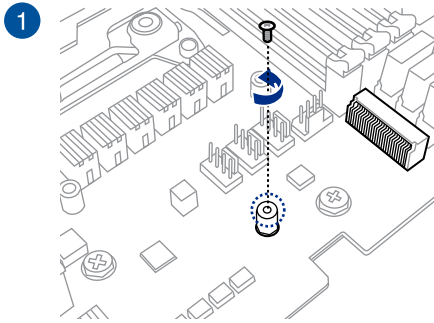

## 2.2 Motherboard rear and audio connections

### 2.2.1 Rear I/O connection

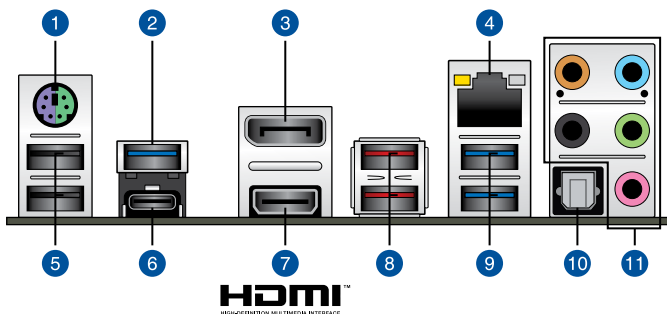

#### Rear panel connectors

1. PS/2 keyboard/mouse combo port	7. HDMI 2.0a port
2. USB 3.1 Gen 1 Type-A port 5	8. USB 3.1 Gen 2 ports 1 and 2
3. DisplayPort	9. USB 3.1 Gen 1 ports 3 and 4
4. LAN (RJ-45) port*	10. Optical S/PDIF OUT port
5. USB 2.0 ports 9 and 10	11. Audio I/O ports**
6. USB 3.1 Gen 1 Type-C™ port C6	

\* and \*\*: Refer to the tables on the next page for LAN port LEDs and audio port definitions.



- USB 3.1 Gen 1/Gen 2 devices can only be used as data storage only.
- We strongly recommend that you connect your devices to ports with matching data transfer rate. Please connect your USB 3.1 Gen 2 devices to USB 3.1 Gen 2 ports for faster and better performance for your devices.

**\* LAN ports LED indications**

Activity Link LED		Speed LED	
Status	Description	Status	Description
Off	No link	Off	10 Mbps connection
Orange	Linked	Orange	100 Mbps connection
Orange (Blinking)	Data activity	Green	1 Gbps connection
Orange (Blinking then steady)	Ready to wake up from S5 mode		

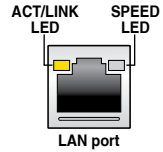

**\*\* Audio 2, 4, 5.1, or 7.1-channel configuration**

Port	Headset 2-channel	4-channel	5.1-channel	7.1-channel
Light Blue	Line In	Line In	Line In	Side speaker
Lime	Line Out	Front Speaker Out	Front Speaker Out	Front Speaker Out
Pink	Mic In	Mic In	Mic In	Mic In
Orange	–	–	Center/Subwoofer	Center/Subwoofer
Black	–	Rear Speaker Out	Rear Speaker Out	Rear Speaker Out

## 2.2.2 Audio I/O connections

### Audio I/O ports

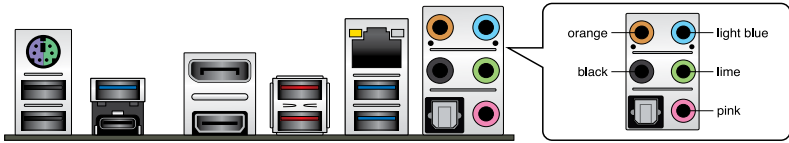

### Connect to Headphone and Mic



### Connect to Stereo Speakers

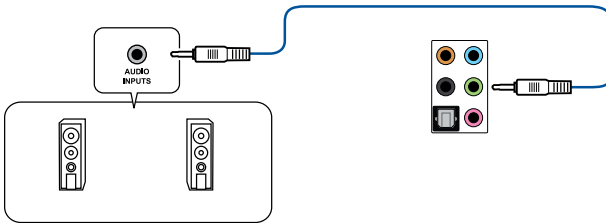

### Connect to 2-channel Speakers

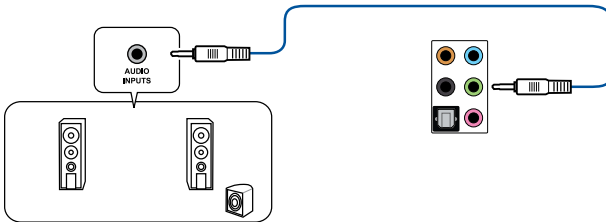



## Connect to 4-channel Speakers

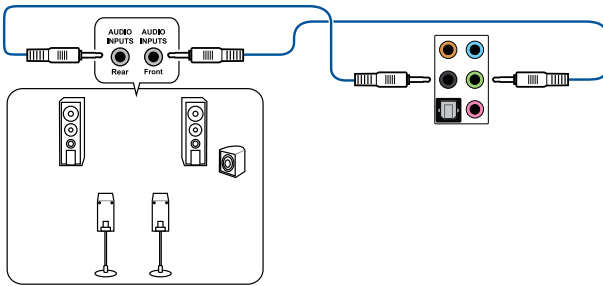

## Connect to 5.1-channel Speakers

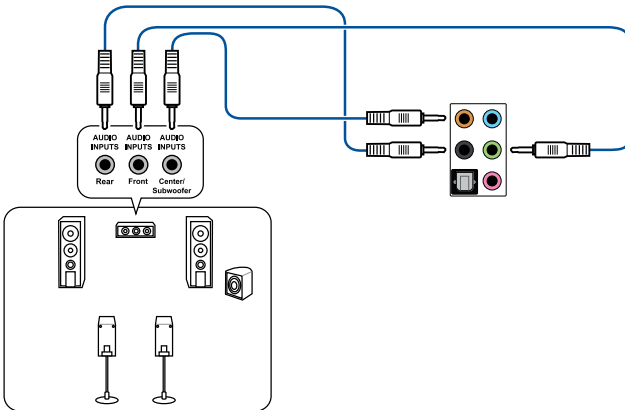

## Connect to 7.1-channel Speakers

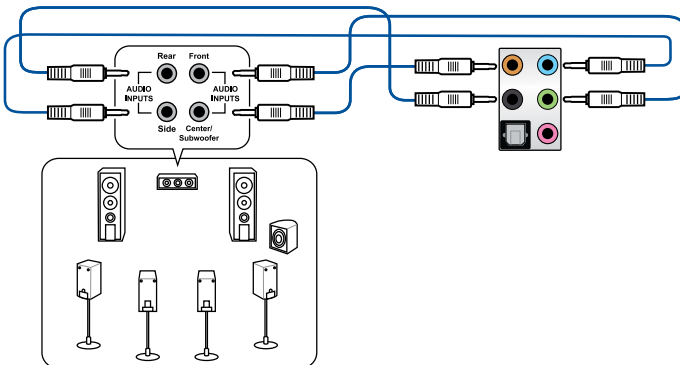

## 2.3 Starting up for the first time

1. After making all the connections, replace the system case cover.
2. Ensure that all switches are off.
3. Connect the power cord to the power connector at the back of the system chassis.
4. Connect the power cord to a power outlet that is equipped with a surge protector.
5. Turn on the devices in the following order:
  - a. Monitor
  - b. External storage devices (starting with the last device on the chain)
  - c. System power
6. After applying power, the system power LED on the system front panel case lights up. For systems with ATX power supplies, the system LED lights up when you press the ATX power button. If your monitor complies with the “green” standards or if it has a “power standby” feature, the monitor LED may light up or change from orange to green after the system LED turns on.

The system then runs the power-on self tests (POST). While the tests are running, the BIOS beeps (refer to the BIOS beep codes table) or additional messages appear on the screen. If you do not see anything within 30 seconds from the time you turned on the power, the system may have failed a power-on test. Check the jumper settings and connections or call your retailer for assistance.

BIOS Beep	Description
One short beep	VGA detected Quick boot set to disabled No keyboard detected
One continuous beep followed by two short beeps then a pause (repeated)	No memory detected
One continuous beep followed by three short beeps	No VGA detected
One continuous beep followed by four short beeps	Hardware component failure

7. At power on, hold down the <Delete> key to enter the BIOS Setup. Follow the instructions in Chapter 3.

## 2.4 Turning off the computer

While the system is ON, press the power button for less than four seconds to put the system on sleep mode or soft-off mode, depending on the BIOS setting. Press the power switch for more than four seconds to let the system enter the soft-off mode regardless of the BIOS setting.

# BIOS Setup

# 3

## 3.1 Knowing BIOS

---



The new ASUS UEFI BIOS is a Unified Extensible Interface that complies with UEFI architecture, offering a user-friendly interface that goes beyond the traditional keyboard-only BIOS controls to enable a more flexible and convenient mouse input. You can easily navigate the new UEFI BIOS with the same smoothness as your operating system. The term “BIOS” in this user manual refers to “UEFI BIOS” unless otherwise specified.

---

BIOS (Basic Input and Output System) stores system hardware settings such as storage device configuration, overclocking settings, advanced power management, and boot device configuration that are needed for system startup in the motherboard CMOS. In normal circumstances, the default BIOS settings apply to most conditions to ensure optimal performance. **DO NOT change the default BIOS settings** except in the following circumstances:

- An error message appears on the screen during the system bootup and requests you to run the BIOS Setup.
- You have installed a new system component that requires further BIOS settings or update.



Inappropriate BIOS settings may result to instability or boot failure. **We strongly recommend that you change the BIOS settings only with the help of a trained service personnel.**

---



When downloading or updating the BIOS file, rename it as **RX450FGM.CAP** for this motherboard.

---

## 3.2 BIOS setup program

Use the BIOS Setup to update the BIOS or configure its parameters. The BIOS screen include navigation keys and brief onscreen help to guide you in using the BIOS Setup program.

### Entering BIOS at startup

To enter BIOS Setup at startup, press <Delete> or <F2> during the Power-On Self Test (POST). If you do not press <Delete> or <F2>, POST continues with its routines.

### Entering BIOS Setup after POST

To enter BIOS Setup after POST:

- Press <Ctrl>+<Alt>+<Delete> simultaneously.
- Press the reset button on the system chassis.
- Press the power button to turn the system off then back on. Do this option only if you failed to enter BIOS Setup using the first two options.

After doing either of the three options, press <Delete> key to enter BIOS.



- 
- The BIOS setup screens shown in this section are for reference purposes only, and may not exactly match what you see on your screen.
  - Ensure that a USB mouse is connected to your motherboard if you want to use the mouse to control the BIOS setup program.
  - If the system becomes unstable after changing any BIOS setting, load the default settings to ensure system compatibility and stability. Select the **Load Optimized Defaults** item under the **Exit** menu or press hotkey <F5>. See section 3.10 **Exit Menu** for details.
  - If the system fails to boot after changing any BIOS setting, try to clear the CMOS and reset the motherboard to the default value. See section 1.1.6 **Jumpers** for information on how to erase the RTC RAM via the Clear CMOS jumper.
  - The BIOS setup program does not support the Bluetooth devices.
- 



---

Please visit ASUS website for the detailed BIOS content manual.

---

### BIOS menu screen

The BIOS Setup program can be used under two modes: **EZ Mode** and **Advanced Mode**. You can change modes from **Setup Mode** in **Boot menu** or by pressing the <F7> hotkey.

### 3.2.1 Advanced Mode

The Advanced Mode provides advanced options for experienced end-users to configure the BIOS settings. The figure below shows an example of the Advanced Mode. Refer to the following sections for the detailed configurations.



The default screen for entering the BIOS setup program can be changed. Refer to the **Setup Mode** item in section **Boot menu** for details.

The screenshot shows the UEFI BIOS Advanced Mode interface. The top bar includes the date and time (06/13/2018 15:43), language (English), and various utility shortcuts like MyFavorite(F3), Qfan Control(F6), EZ Tuning Wizard(F11), Search(F9), and AURA ON/OFF(F4). The main menu includes My Favorites, Main, Ai Tweaker (selected), Advanced, Monitor, Boot, Tool, and Exit. The Ai Tweaker section contains several configuration fields: Ai Overclock Tuner (set to Auto), Performance Enhancer, CPU Core Ratio, Performance Bias, Memory Frequency, Core Performance Boost, SMT Mode, and TPU. A detailed help box for the Ai Overclock Tuner is expanded, explaining the Auto, Manual, and D.O.C.P. Standard options. On the right, the Hardware Monitor displays system status including CPU frequency (3200 MHz), temperature (49°C), BCLK (100 MHz), core voltage (1.406 V), ratio (32.0 x), memory frequency (2133 MHz), voltage (1.200 V), and capacity (4096 MB). The bottom status bar shows 'Last Modified', 'EzMode(F7)', 'Hot Keys', and 'Search on FAQ'. A copyright notice for American Megatrends is also visible.

**Configuration fields**  
**Pop-up Menu**  
**Menu bar** Language MyFavorite(F3) Qfan Control(F6) EZ Tuning Wizard(F11) Search(F9) Scroll bar AURA ON/OFF(F4)

**Menu items** General help Last modified settings Go back to EZ Mode Hot Keys Search on the FAQ

**Displays a quick overview of the system status**

## Menu bar

The menu bar on top of the screen has the following main items:

<b>My Favorites</b>	For saving the frequently-used system settings and configuration.
<b>Main</b>	For changing the basic system configuration
<b>Ai Tweaker</b>	For changing the overclocking settings
<b>Advanced</b>	For changing the advanced system settings
<b>Monitor</b>	For displaying the system temperature, power status, and changing the fan settings.
<b>Boot</b>	For changing the system boot configuration
<b>Tool</b>	For configuring options for special functions
<b>Exit</b>	For selecting the exit options and loading default settings

## Menu items

The highlighted item on the menu bar displays the specific items for that menu. For example, selecting **Main** shows the Main menu items.

The other items (My Favorites, Ai Tweaker, Advanced, Monitor, Boot, Tool, and Exit) on the menu bar have their respective menu items.

## Submenu items

A greater than sign (>) before each item on any menu screen means that the item has a submenu. To display the submenu, select the item and press <Enter>.

## Language

This button above the menu bar contains the languages that you can select for your BIOS. Click this button to select the language that you want to display in your BIOS screen.

## My Favorites(F3)

This button above the menu bar shows all BIOS items in a Tree Map setup. Select frequently-used BIOS settings and save it to MyFavorites menu.



---

Refer to section **3.3 My Favorites** for more information.

---

## Q-Fan Control(F6)

This button above the menu bar displays the current settings of your fans. Use this button to manually tweak the fans to your desired settings.



---

Refer to section **3.2.3 QFan Control** for more information.

---

## Search (F9)

This button allows you to search for BIOS items by entering its name, enter the item name to find the related item listing.

## AURA (F4)

This button allows you to turn the RGB LED lighting or functional LED on or off.

[ON] All AURA effects will be enabled. (Default mode)

[OFF] All AURA effects will be disabled.

[Stealth Mode] Functional LEDs (Q-Code and HDD\_LED) and all AURA effects will be disabled.

## Search on FAQ

Move your mouse over this button to show a QR code, scan this QR code on your mobile device to connect to the BIOS FAQ web page of the ASUS support website. You can also scan the following QR code:



## Scroll bar

A scroll bar appears on the right side of a menu screen when there are items that do not fit on the screen. Press the Up/Down arrow keys or <Page Up> / <Page Down> keys to display the other items on the screen.

## General help

At the bottom of the menu screen is a brief description of the selected item. Use <F12> key to capture the BIOS screen and save it to the removable storage device.

## Configuration fields

These fields show the values for the menu items. If an item is user-configurable, you can change the value of the field opposite the item. You cannot select an item that is not user-configurable.

A configurable field is highlighted when selected. To change the value of a field, select it and press <Enter> to display a list of options.

## Hot keys

This button contains the navigation keys for the BIOS setup program. Use the navigation keys to select items in the menu and change the settings.

## Last Modified button

This button shows the items that you last modified and saved in BIOS Setup.

### 3.2.2 EZ Mode

The EZ Mode provides you an overview of the basic system information, and allows you to select the display language, system performance, mode and boot device priority. To access the Advanced Mode, select **Advanced Mode** or press the <F7> hotkey for the advanced BIOS settings.



To switch from Advanced Mode to EZ Mode, click **EZ Mode(F7)** or press the <F7> hotkey.

**Displays a quick overview of the system status**

**Creates storage RAID and configures system overlocking**

**Selects the display language of the BIOS setup program**

**Search(F9)**

**AURA ON/OFF(F4)**

**Displays the system properties of the selected mode. Click < or > to switch EZ System Tuning modes**

**Information**  
 ROG STRIX B450-F GAMING BIOS Ver. 0204  
 AMD Ryzen 7 2700 Eight-Core Processor  
 Speed: 3200 MHz  
 Memory: 4096 MB (DDR4 2133MHz)

**CPU Temperature**  
 CPU Core Voltage: 1.417 V  
 Motherboard Temperature: 30°C

**DRAM Status**  
 DIMM\_A1: N/A  
 DIMM\_A2: Apacer 4096MB 2133MHz  
 DIMM\_B1: N/A  
 DIMM\_B2: N/A

**SATA Information**  
 SATA6G\_1: N/A  
 SATA6G\_2: N/A  
 SATA6G\_3: N/A  
 SATA6G\_4: N/A  
 SATA6G\_5: N/A  
 SATA6G\_6: N/A  
 M.2: N/A

**EZ System Tuning**  
 Click the icon to specify your preferred system settings for a power-saving system environment  
 Quiet  
 Performance  
 Energy Saving  
 Normal

**Boot Priority**  
 Choose one and drag the items. [Switch all]  
 UEFI: JetFlashTranscend 4GB 8.07, Partition 1 (3830MB)  
 JetFlashTranscend 4GB 8.07 (3830MB)

**FAN Profile**  
 CPU FAN: 4821 RPM  
 CHA\_FAN1: N/A  
 CHA\_FAN2: N/A  
 CHA\_FAN3: N/A  
 AIO PUMP: N/A  
 CPU\_OPT: N/A

**CPU FAN**  
 Graph showing fan speed (%) vs temperature (°C). Includes QFan Control button.

**Default(F5) | Save & Exit(F10) | Advanced Mode(F7) | Search on FAQ**

**Saves the changes and resets the system**

**Click to go to Advanced mode**

**Search on the FAQ**

**Click to display boot devices**

**Selects the boot device priority**

**Displays the CPU Fan's speed. Click the button to manually tune the fans**

**Loads optimized default settings**



The boot device options vary depending on the devices you installed to the system.



### 3.2.3 QFan Control

The QFan Control allows you to set a fan profile or manually configure the operating speed of your CPU and chassis fans.

The screenshot shows the Q-Fan Control interface with the following annotations:

- Click to select a fan to be configured**: Points to the fan selection list on the left.
- Click to activate PWM Mode**: Points to the 'PWM' button at the top right.
- Click to activate DC Mode**: Points to the 'DC' button at the top right.
- Select a profile to apply to your fans**: Points to the 'Standard' profile in the slider.
- Click to apply the fan setting**: Points to the 'Apply' button.
- Click to undo the changes**: Points to the 'Undo' button.
- Click to go back to main menu**: Points to the 'Exit (ESC)' button.
- Select to manually configure your fans**: Points to the 'Manual' profile in the slider.

The interface includes a fan selection list, a graph showing fan speed (%) vs temperature (°C), a mode selector (PWM/DC), a fan profile slider (Standard, Silent, Turbo, Full Speed, Manual), and control buttons (Undo, Apply, Exit (ESC)).

## Configuring fans manually

Select **Manual** from the list of profiles to manually configure your fans' operating speed.

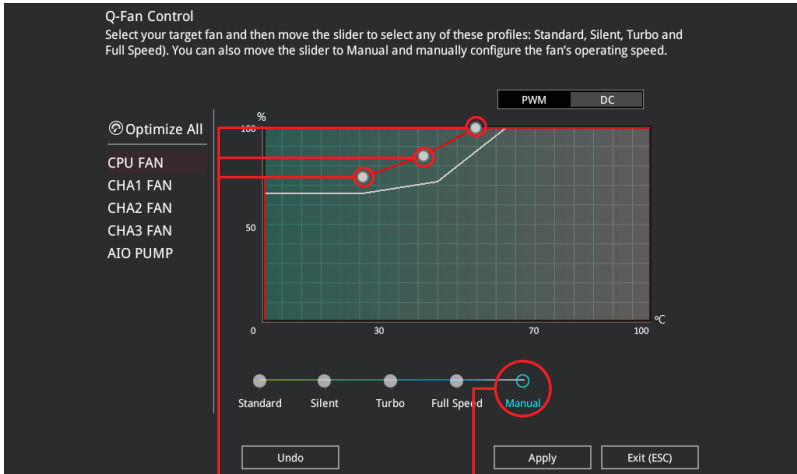

Speed points

Select to manually  
configure your fans

To configure your fans:

1. Select the fan that you want to configure and to view its current status.
2. Click and drag the speed points to adjust the fans' operating speed.
3. Click **Apply** to save the changes then click **Exit (ESC)**.

### 3.2.4 EZ Tuning Wizard

EZ Tuning Wizard allows you to easily overclock your CPU and DRAM, computer usage, and CPU fan to their best settings.

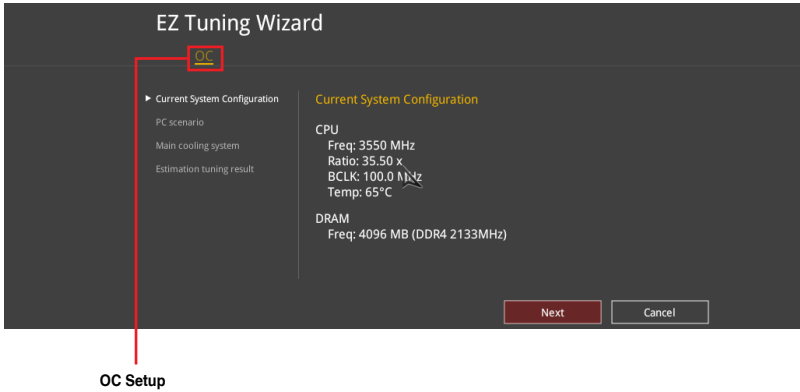

### OC Tuning

To start OC Tuning:

1. Press <F11> on your keyboard or click **EZ Tuning Wizard(F11)** from the BIOS screen to open EZ Tuning Wizard screen.
2. Click **OC** then click **Next**.
3. Select a PC scenario **Daily Computing** or **Gaming/Media Editing**, then click **Next**.

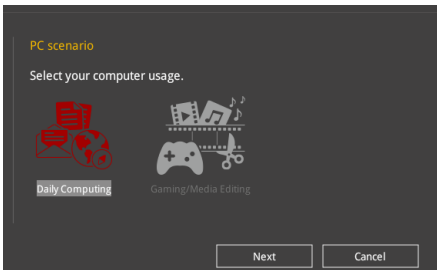

4. Select a Main Cooling System **BOX cooler**, **Tower cooler**, **Water cooler**, or **I'm not sure**, then click **Next**.

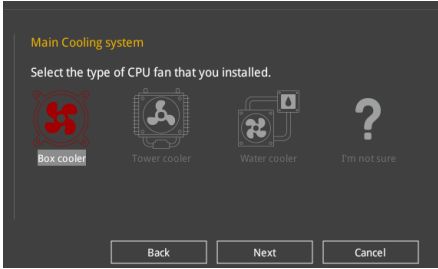

5. After selecting the Main Cooling System, click **Next** then click **Yes** to start the OC Tuning.

## 3.3 My Favorites

My Favorites is your personal space where you can easily save and access your favorite BIOS items.

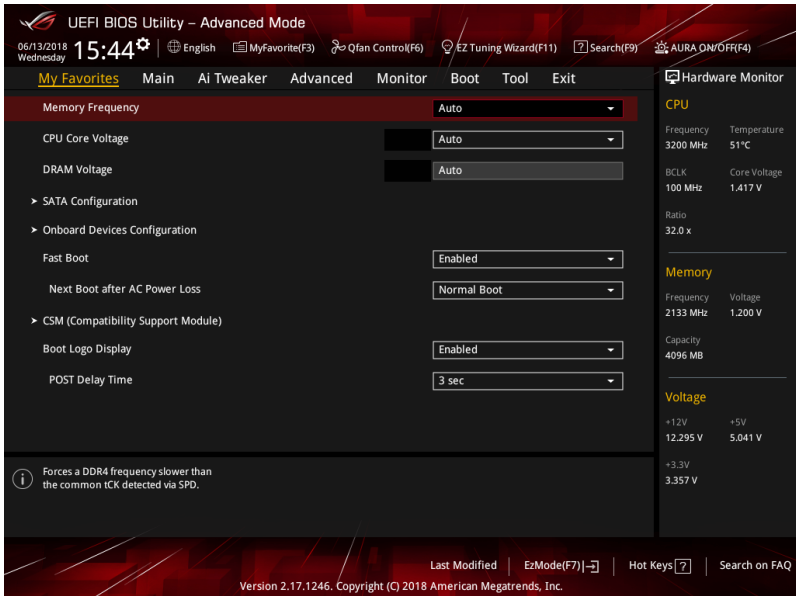



My Favorites comes with several performance, power saving, and fast boot related items by default. You can personalize this screen by adding or removing items.

## Adding items to My Favorites

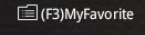
To add BIOS items:

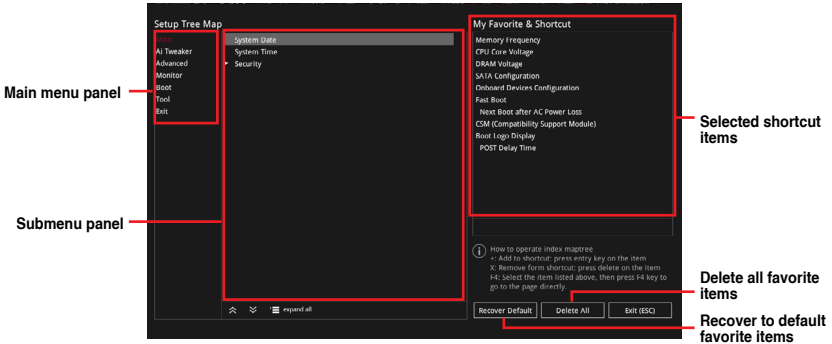
1. Press <F3> on your keyboard or click  from the BIOS screen to open Setup Tree Map screen.
2. On the Setup Tree Map screen, select the BIOS items that you want to save in My Favorites screen.



3. Select an item from main menu panel, then click the submenu that you want to save as favorite from the submenu panel and click  or press <Enter> on your keyboard.



You cannot add the following items to My Favorite items:

- Items with submenu options
- User-managed items such as language and boot order
- Configuration items such as Memory SPD Information, system time and date.

4. Click **Exit (ESC)** or press <Esc> key to close Setup Tree Map screen.
5. Go to My Favorites menu to view the saved BIOS items.

## 3.4 Main menu

The Main menu screen appears when you enter the Advanced Mode of the BIOS Setup program. The Main menu provides you an overview of the basic system information, and allows you to set the system date, time, language, and security settings.

### Security

The Security menu items allow you to change the system security settings.



- If you have forgotten your BIOS password, erase the CMOS Real Time Clock (RTC) RAM to clear the BIOS password. See section 1.1.6 **Jumper** for information on how to erase the RTC RAM via the Clear RTC RAM jumper.
- The Administrator or User Password items on top of the screen show the default **[Not Installed]**. After you set a password, these items show **[Installed]**.

## 3.5 Ai Tweaker menu

The Ai Tweaker menu items allow you to configure overclocking-related items.



Be cautious when changing the settings of the Ai Tweaker menu items. Incorrect field values can cause the system to malfunction



The configuration options for this section vary depending on the CPU and DIMM model you installed on the motherboard.

### Ai Overclock Tuner

Allows you to select the CPU overclocking options to achieve the desired CPU internal frequency. Configuration options:

- |            |  |
|------------|--|
| [Auto]     | Loads the optimal settings for the system.   |
| [Manual]   | Allows you to individually set overclocking parameters.  |
| [D.O.C.P.] | Allows you to select a DRAM O.C. profile, and the related parameters will be adjusted automatically. |



The following item appears only when you set the Ai Overclocking Tuner to **[Manual]**.

#### BCLK Frequency

This item allows you to set the BCLK frequency to enhance the system performance. Use the <+> or <-> to adjust the value.



We recommend you to set the value based on the CPU specification, as high BCLK frequencies may damage the CPU permanently.

## Memory Frequency

This item allows you to set the memory operating frequency. The configurable options vary with the BCLK (base clock) frequency setting. Select the auto mode to apply the optimized setting.

Configuration options: [Auto] [DDR4-1333MHz] - [DDR4-4000MHz]

## TPU

This item allows you to automatically overclock the CPU and DRAM frequencies and voltage for an enhanced system performance.

[Keep Current Settings] Keep the current settings without changing anything.

[TPU I] Applies air cooling overclocking conditions.

[TPU II] Applies water cooling overclocking conditions.



---

Ensure to use water cooling device before selecting [TPU II].

---

## 3.6 Advanced menu

The Advanced menu items allow you to change the settings for the CPU and other system devices.



---

Be cautious when changing the settings of the Advanced menu items. Incorrect field values can cause the system to malfunction.

---

### 3.6.1 AMD fTPM configuration

The items in this menu show the AMD fTPM configuration options.

#### Firmware TPM

This item allows you to enable or disable AMD CPU fTPM.

Configuration options: [Enable] [Disable]



---

When Firmware TPM is set to disabled all saved data on it will be lost.

---

### 3.6.2 CPU Configuration

The items in this menu show the CPU-related information that the BIOS automatically detects.



---

The items in this menu may vary based on the CPU installed.

---

#### PSS Support

This item allows you enable or disable the generation of ACPI\_PPC, \_PSS, and \_PCT objects.

Configuration options: [Disabled] [Enabled] [Auto]



## SVM Mode

This item allows you enable or disable CPU Virtualization.

Configuration options: [Disabled] [Enabled]

### 3.6.3 ROG Effects

The items in this menu allow you to configure the LEDs on your motherboard.

#### Onboard LED

This item allows you to enable all the onboard LEDs.

Configuration options: [Enabled] [Disabled]

### 3.6.4 SATA Configuration

While entering Setup, the BIOS automatically detects the presence of SATA devices. The SATA Port items show **Not Present** if no SATA device is installed to the corresponding SATA port.

#### SATA Port Enable

This item allows you to enable or disable the SATA Device.

Configuration options: [Disabled] [Enabled]

#### SATA Mode

This item allows you to set the SATA configuration.

[AHCI] Set to [AHCI] when you want the SATA hard disk drives to use the AHCI (Advanced Host Controller Interface). The AHCI allows the onboard storage driver to enable advanced Serial ATA features that increases storage performance on random workloads by allowing the drive to internally optimize the order of commands.

[RAID] Set to [RAID] when you want to create a RAID configuration from the SATA hard disk drives.

#### NVMe RAID mode

This item allows you to enable or disable NVMe RAID mode.

Configuration options: [Disabled] [Enabled]

#### SMART Self Test

S.M.A.R.T. (Self-Monitoring, Analysis and Reporting Technology) is a monitoring system that shows a warning message during POST (Power-on Self Test) when an error occurs in the hard disks.

Configuration options: [On] [Off]

#### SATA6G\_1(Gray) - SATA6G\_6(Gray)

##### SATA6G\_1(Gray) - SATA6G\_6(Gray)

This item allows you to enable or disable the selected SATA port.

Configuration options: [Disabled] [Enabled]

### Hot Plug

These items appears only when the **SATA Mode** is set to **[AHCI]** and allows you to enable or disable SATA Hot Plug Support.

Configuration options: [Disabled] [Enabled]

## 3.6.5 Onboard Devices Configuration

The items in this menu allow you to switch between PCIe Lanes and configure onboard devices.

### HD Audio Controller

This item allows you to use the Azalia High Definition Audio Controller

Configuration options: [Disabled] [Enabled]

### PCIEX16\_3 Control

[Auto] If PCIEX16\_3 is detected, run x4 mode and disable PCIEX1\_2 + PCIEX1\_3, otherwise enable PCIEX1\_2 + PCIEX1\_3

[X2 mode] PCIEX16\_3 run x2 mode & enable PCIEX1\_2 + PCIEX1\_3

[X4 mode] PCIEX16\_3 run x4 mode & disable PCIEX1\_2 + PCIEX1\_3

### M.2\_1 Control

[Auto] If M.2\_1 detected, run X4 mode or SATA mode and disable SATA56, otherwise enable SATA56

[SATA56] M.2\_1 X2 mode & SATA56 enable

### PCIEX16\_1 Mode

This item allows you to set the link speed for first VGA slot.

Configuration options: [Auto] [GEN 1] [GEN 2] [GEN 3]

### PCIEX16\_2 Mode

This item allows you to set the link speed for second VGA slot.

Configuration options: [Auto] [GEN 1] [GEN 2] [GEN 3]

### M.2\_1 Link Mode

This item allows you to set the link speed for M.2\_1 device.

Configuration options: [Auto] [GEN 1] [GEN 2] [GEN 3]

### M.2\_2 Link Mode

This item allows you to set the link speed for M.2\_1 device.

Configuration options: [Auto] [GEN 1] [GEN 2] [GEN 3]

### SB Link Mode

This item allows you to set the link speed for Southbridge.

Configuration options: [Auto] [GEN 1] [GEN 2] [GEN 3]

## RGB LED lighting

### When system is in working state

This item allows you to turn the RGB LED lighting on or off when the system is in the working state.

Configuration options: [On] [Off]

### When system is in sleep, hibernate or soft off states

This item allows you to turn the RGB LED lighting on or off when the system is in the sleep, hibernate or soft off states.

Configuration options: [On] [Off]

## Intel LAN Controller

This item allows you to enable or disable the Intel LAN controllers.

Configuration options: [Disabled] [Enabled]

## 3.6.6 APM Configuration

The items in this menu allow you to set system wake and sleep settings.

### ErP Ready

This item allows you to switch off some power at S4+S5 or S5 to get the system ready for ErP requirement. When set to **[Enabled]**, all other PME options are switched off.

Configuration options: [Disabled] [Enable(S4+S5)] [Enable(S5)]

## 3.6.7 Network Stack Configuration

The items in this menu allow you to configure Ipv4 / Ipv6 PXE support.

## 3.6.8 HDD/SSD SMART Information

This menu displays the SMART information of the connected devices.



---

NVM Express devices do not support SMART information.

---

## 3.6.9 USB Configuration

The items in this menu allow you to change the USB-related features.



---

The **Mass Storage Devices** item shows the auto-detected values. If no USB device is detected, the item shows **None**.

---

### Legacy USB Support

- [Enabled] Your system supports the USB devices in legacy operating systems.
- [Disabled] Your USB devices can be used for BIOS setup only and cannot be recognized in the boot devices list.
- [Auto] Your system automatically detects the presence of USB devices at startup. If any USB devices are detected, the legacy USB support is enabled.

### XHCI Hand-off

- [Enabled] Enables the support for operating systems without an XHCI hand-off feature.
- [Disabled] Disables the XHCI Hand-off support.

### USB Mass Storage Driver Support

This item allows you to enable or disable USB Mass Storage Driver Support.

Configuration options: [Disabled] [Enabled]

### USB Single Port Control

This item allows you to enable or disable the individual USB ports.



---

Refer to section 1.1.2 **Motherboard layout** for the location of the USB ports.

---

## 3.7 Monitor menu

The Monitor menu displays the system temperature/power status, and allows you to change the fan settings.

Scroll down to display the other BIOS items.

### Q-fan Configuration

#### Qfan Tuning

Click this item to automatically detect the lowest speed and configure the minimum duty cycle for each fan.

#### AIO\_PUMP Control

- [Disabled] Disable the Water Pump control feature.
- [Auto] Detects the type of water pump installed and automatically switches the control modes.
- [DC mode] Enable the Water Pump control in DC mode for 3-pin chassis fan.
- [PWM mode] Enable the Water Pump control in PWM mode for 4-pin chassis fan.

## 3.8 Boot menu

The Boot menu items allow you to change the system boot options.

### Fast Boot

[Disabled] Allows your system to go back to its normal boot speed.

[Enabled] Allows your system to accelerate the boot speed.



---

The following item appears only when you set the Fast Boot to **[Enabled]**.

---

### Next Boot after AC Power Loss

[Normal Boot] Returns to normal boot on the next boot after an AC power loss.

[Fast Boot] Accelerates the boot speed on the next boot after an AC power loss.

### Boot Configuration

#### Setup Mode

[Advanced Mode] This item allows you to go to Advanced Mode of the BIOS after POST.

[EZ Mode] This item allows you to go to EZ Mode of the BIOS after POST.

### CSM (Compatibility Support Module)

This item allows you to configure the CSM (Compatibility Support Module) items to fully support the various VGA, bootable devices and add-on devices for better compatibility.

#### Launch CSM

[Auto] The system automatically detects the bootable devices and the add-on devices.

[Enabled] For better compatibility, enable the CSM to fully support the non-UEFI driver add-on devices or the Windows® UEFI mode.

[Disabled] Disable the CSM to fully support the non-UEFI driver add-on devices or the Windows® UEFI mode.



---

The following items appear only when you set the **Launch CSM** to **[Enabled]**.

---

#### **Boot Devices Control**

This item allows you to select the type of devices that you want to boot.

Configuration options: [UEFI and Legacy OPROM] [Legacy OPROM only] [UEFI only]

#### **Boot from Network Devices**

This item allows you to select the type of network devices that you want to launch.

Configuration options: [Ignore] [Legacy only] [UEFI driver first]

#### **Boot from Storage Devices**

This item allows you to select the type of storage devices that you want to launch.

Configuration options: [Ignore] [Legacy only] [UEFI driver first]

**Boot from PCI-E Expansion Devices**

This item allows you to select the type of PCI-E/PCI expansion devices that you want to launch.

Configuration options: [Legacy only] [UEFI driver first]

**Secure Boot**

This item allows you to configure the Windows® Secure Boot settings and manage its keys to protect the system from unauthorized access and malwares during POST.

**Boot Option Priorities**

These items specify the boot device priority sequence from the available devices. The number of device items that appears on the screen depends on the number of devices installed in the system.



- To access Windows® OS in Safe Mode, press <F8> after POST (Windows® 8 not supported).
- To select the boot device during system startup, press <F8> when the ASUS Logo appears.

**Boot Override**

These items displays the available devices. The number of device items that appears on the screen depends on the number of devices installed in the system. Click an item to start booting from the selected device.

## 3.9 Tool menu

The Tool menu items allow you to configure options for special functions. Select an item then press <Enter> to display the submenu.

**Setup Animator**

This item allows you to enable or disable the Setup animator.

Configuration options: [Enabled] [Disabled]

**ASUS Grid Install Service**

This item allows you to enable or disable support for Auto-launch ASUS Grid.

Configuration options: [Enabled] [Disabled]

### 3.9.1 ASUS EZ Flash 3 Utility

This item allows you to run ASUS EZ Flash 3. When you press <Enter>, a confirmation message appears. Use the left/right arrow key to select between [Yes] or [No], then press <Enter> to confirm your choice.



For more details, refer to section **3.11.2 ASUS EZ Flash 3**.

## 3.9.2 ASUS Secure Erase

SSD speeds may lower over time as with any storage medium due to data processing. ASUS Secure Erase completely and safely cleans your SSD, restoring it to factory performance levels.



ASUS Secure Erase is only available in AHCI mode. Ensure to set the SATA mode to AHCI. Click **Advanced > SATA Configuration > SATA Mode > AHCI**.

To launch ASUS Secure Erase, click **Tool > ASUS Secure Erase** on the Advanced mode menu.



Check the ASUS support site for a full list of SSDs tested with ASUS Secure Erase. The drive may become unstable if you run ASUS Secure Erase on an incompatible SSD.



The time to erase the contents of your SSD may take a while depending on its size. Do not turn off the system during the process.

Displays the available SSDs

Port #	SSD Name	Status	Total Capacity
P2	ADATA SX96 Turbo	Frozen	64.0GB



### Status definition:

- **Frozen.** The frozen state is the result of a BIOS protective measure. The BIOS guards drives that do not have password protection by freezing them prior to booting. If the drive is frozen, a power off or hard reset of your PC must be performed to proceed with the ASUS Secure Erase.
- **Locked.** SSDs might be locked if the ASUS Secure Erase process is either incomplete or was stopped. This may be due to a third party software that uses a different password defined by ASUS. You have to unlock the SSD in the software before proceeding with ASUS Secure Erase.

### 3.9.3 ASUS User Profile

This item allows you to store or load multiple BIOS setting profiles.

#### Load Profile

This item allows you to load the previous BIOS settings saved in the BIOS Flash. Key in the profile number that saved your BIOS settings, press <Enter>, and then select **Yes**.



- DO NOT shut down or reset the system while updating the BIOS to prevent the system boot failure!
- We recommend that you update the BIOS file only coming from the same memory/ CPU configuration and BIOS version.

#### Profile Name

This item allows you to key in a profile name.

#### Save to Profile

This item allows you to save the current BIOS settings to the BIOS Flash, and create a profile. Key in a profile number from one to eight, press <Enter>, and then select **Yes**.

#### Load/Save Profile from/to USB Drive

This item allows you to load or save profile from your USB drive, load and save profile to your USB drive.

### 3.9.4 ASUS SPD Information

This item allows you to view the DRAM SPD information.

### 3.9.5 Graphics Card Information

This item displays the information about the graphics card installed in your system.

#### GPU Post

This item displays the information and recommended configuration for the PCIE slots that the graphics card is installed in your system.



This feature is only supported on selected ASUS graphics cards.

#### Bus Interface

This item allows you to select the bus interface.

Configuration options: [PCIEX16\_1]



## 3.10 Exit menu

The Exit menu items allow you to load the optimal default values for the BIOS items, and save or discard your changes to the BIOS items. You can access the EZ Mode from the Exit menu.

### Load Optimized Defaults

This option allows you to load the default values for each of the parameters on the Setup menus. When you select this option or if you press <F5>, a confirmation window appears. Select **OK** to load the default values.

### Save Changes & Reset

Once you are finished making your selections, choose this option from the Exit menu to ensure the values you selected are saved. When you select this option or if you press <F10>, a confirmation window appears. Select **OK** to save changes and exit.

### Discard Changes & Exit

This option allows you to exit the Setup program without saving your changes. When you select this option or if you press <Esc>, a confirmation window appears. Select **Yes** to discard changes and exit.

### Launch EFI Shell from USB drives

This item allows you to attempt to launch the EFI Shell application (shellx64.efi) from one of the available filesystem devices.

## 3.11 Updating BIOS

The ASUS website publishes the latest BIOS versions to provide enhancements on system stability, compatibility, and performance. However, BIOS updating is potentially risky. If there is no problem using the current version of BIOS, DO NOT manually update the BIOS. Inappropriate BIOS updating may result to system's failure to boot. Carefully follow the instructions in this chapter to update your BIOS when necessary.



---

Visit <http://www.asus.com> to download the latest BIOS file for this motherboard.

---

The following utilities allow you to manage and update the motherboard BIOS setup program.

1. EZ Update: Updates the BIOS in Windows® environment.
2. ASUS EZ Flash 3: Updates the BIOS using a USB flash drive.
3. ASUS CrashFree BIOS 3: Restores the BIOS using the motherboard support DVD or a USB flash drive when the BIOS file fails or gets corrupted.

### 3.11.1 EZ Update

The EZ Update is a utility that allows you to update the motherboard BIOS in Windows® environment.



- 
- EZ Update requires an Internet connection either through a network or an ISP (Internet Service Provider).
  - This utility is available in the support DVD that comes with the motherboard package.
-

### 3.11.2 ASUS EZ Flash 3

ASUS EZ Flash 3 allows you to download and update to the latest BIOS through the Internet without having to use a bootable floppy disk or an OS-based utility.



Updating through the Internet varies per region and Internet conditions. Check your local Internet connection before updating through the Internet.

#### To update the BIOS by USB:

1. Enter the Advanced Mode of the BIOS setup program. Go to the Tool menu to select **ASUS EZ Flash Utility** and press <Enter>.
2. Insert the USB flash disk that contains the latest BIOS file to the USB port.
3. Select **via Storage Device(s)**.

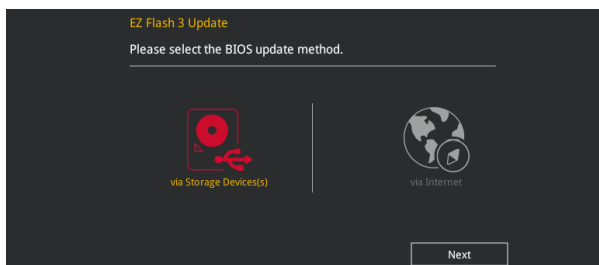

4. Press <Tab> to switch to the Drive field.
5. Press the Up/Down arrow keys to find the USB flash disk that contains the latest BIOS, and then press <Enter>.
6. Press <Tab> to switch to the Folder Info field.
7. Press the Up/Down arrow keys to find the BIOS file, and then press <Enter> to perform the BIOS update process. Reboot the system when the update process is done.

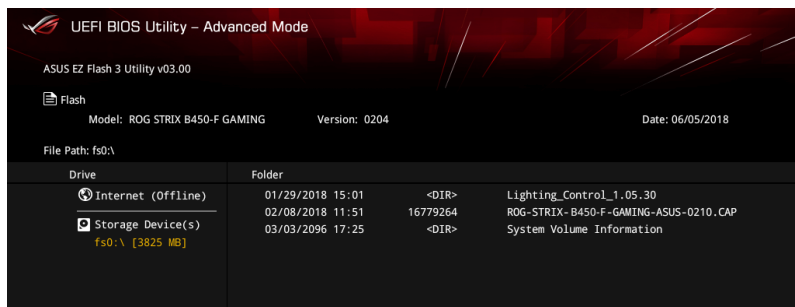



- This function can support devices such as a USB flash disk with FAT 32/16 format and single partition only.
- DO NOT shut down or reset the system while updating the BIOS to prevent system boot failure!



Ensure to load the BIOS default settings to ensure system compatibility and stability. Select the Load Optimized Defaults item under the Exit menu. See section **3.10 Exit Menu** for details.

### To update the BIOS by Internet:

1. Enter the Advanced Mode of the BIOS setup program. Go to the Tool menu to select **ASUS EZ Flash Utility** and press <Enter>.
2. Select **via Internet**.

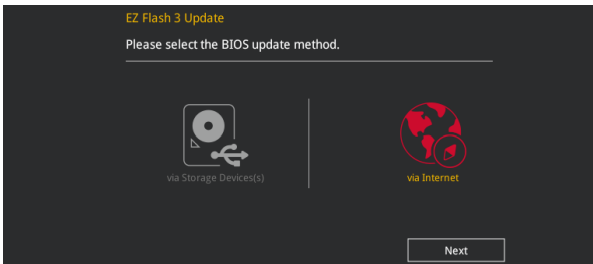

3. Press the Left/Right arrow keys to select an Internet connection method, and then press <Enter>.

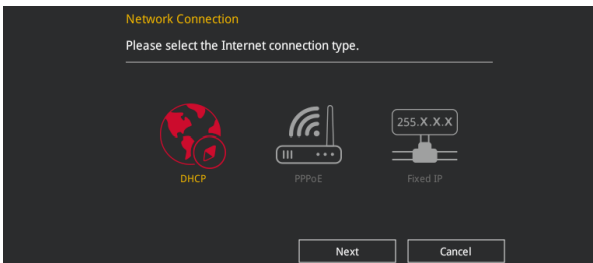

4. Follow the onscreen instructions to complete the update.
5. Reboot the system when the update process is done.



Ensure to load the BIOS default settings to ensure system compatibility and stability. Select the Load Optimized Defaults item under the Exit menu. See section **3.10 Exit Menu** for details.

### 3.11.3 ASUS CrashFree BIOS 3

The ASUS CrashFree BIOS 3 utility is an auto recovery tool that allows you to restore the BIOS file when it fails or gets corrupted during the updating process. You can restore a corrupted BIOS file using the motherboard support DVD or a USB flash drive that contains the BIOS file.



---

The BIOS file in the motherboard support DVD may be older than the BIOS file published on the ASUS official website. If you want to use the newer BIOS file, download the file at <https://www.asus.com/support/> and save it to a USB flash drive.

---

#### Recovering the BIOS

##### To recover the BIOS:

1. Turn on the system.
2. Insert the motherboard support DVD to the optical drive, or the USB flash drive containing the BIOS file to the USB port.
3. The utility automatically checks the devices for the BIOS file. When found, the utility reads the BIOS file and enters ASUS EZ Flash 3 automatically.
4. The system requires you to enter BIOS Setup to recover the BIOS setting. To ensure system compatibility and stability, we recommend that you press <F5> to load default BIOS values.



---

**DO NOT** shut down or reset the system while updating the BIOS! Doing so can cause system boot failure!

---

# RAID Support

# 4

## 4.1 AMD® RAID Array configurations

The motherboard comes with the RaidXpert2 Configuration Utility that supports Volume, RAIDABLE, RAID 0, RAID 1, and RAID 10 (depends on system licensing) configurations.



---

For more information on configuring your RAID sets, please refer to the **RAID Configuration Guide** which you can find at <https://www.asus.com/support>.

---

### 4.1.1 RAID definitions

**Volume** provides the ability to link-together storage from one or several disks, regardless of the size of the space on those disks. This configuration is useful in scavenging space on disks unused by other disks in the array. This configuration does not provide performance benefits or data redundancy, disk failure will result in data loss.

**RAIDABLE** arrays (also known as RAID Ready) are a special type of Volume (JBOD) that allows the user to add more storage space or create a redundant array after a system is installed. RAIDABLE arrays are created using Option ROM, UEFI, or rcadm.



---

The ability to create RAIDABLE arrays may vary per system.

---

**RAID 0 (Data striping)** optimizes two identical hard disk drives to read and write data in parallel, interleaved stacks. Two hard disks perform the same work as a single drive but at a sustained data transfer rate, double that of a single disk alone, thus improving data access and storage. Use of two new identical hard disk drives is required for this setup.

**RAID 1 (Data mirroring)** copies and maintains an identical image of data from one drive to a second drive. If one drive fails, the disk array management software directs all applications to the surviving drive as it contains a complete copy of the data in the other drive. This RAID configuration provides data protection and increases fault tolerance to the entire system. Use two new drives or use an existing drive and a new drive for this setup. The new drive must be of the same size or larger than the existing drive.

**RAID 10** is data striping and data mirroring combined without parity (redundancy data) having to be calculated and written. With the RAID 10 configuration you get all the benefits of both RAID 0 and RAID 1 configurations. Use four new hard disk drives or use an existing drive and three new drives for this setup.



# Multiple GPU Support

# 5

## 5.1 AMD® CrossFireX™ technology

The motherboard supports the AMD® CrossFireX™ technology that allows you to install multi-graphics processing units (GPU) graphics cards. Follow the installation procedures in this section.

### 5.1.1 Requirements

- In Dual CrossFireX mode, you should have two identical CrossFireX-ready graphics cards or one CrossFireX-ready dual-GPU graphics card that are AMD® certified.
- Ensure that your graphics card driver supports the AMD CrossFireX technology. Download the latest driver from the AMD website ([www.amd.com](http://www.amd.com)).
- Ensure that your power supply unit (PSU) can provide at least the minimum power required by your system. See Chapter 1 for details.



- 
- We recommend that you install additional chassis fans for better thermal environment.
  - Visit the AMD Game website (<http://game.amd.com>) for the latest certified graphics card and the supported 3D application list.
- 

### 5.1.2 Before you begin

For AMD® CrossFireX™ to work properly, you have to uninstall all existing graphics card drivers before installing AMD® CrossFireX™ graphics cards to your system.

#### To uninstall existing graphics card drivers:

1. Close all current applications.
2. Press the Windows key on your keyboard to bring up the Start menu.
3. Type Control Panel in the search box, then select **Control Panel**.
4. Select **Programs and Features**.
5. Select your current graphics card driver/s, then select **Uninstall/Change**.
6. Turn off your computer.

### 5.1.3 Installing three CrossFireX™ graphics cards

To install three CrossFireX™ graphics cards:

1. Prepare three CrossFireX-ready graphics cards.
2. Insert the three graphics card into the PCIEX16 slots. If your motherboard has more than three PCIEX16 slots, refer to Chapter 1 in this user manual for the locations of the PCIEX16 slots recommended for multi-graphics card installation.
3. Ensure that the cards are properly seated on the slots.
4. Align and firmly insert the two CrossFireX™ bridge connectors to the goldfingers on each graphics card. Ensure that the connectors are firmly in place.

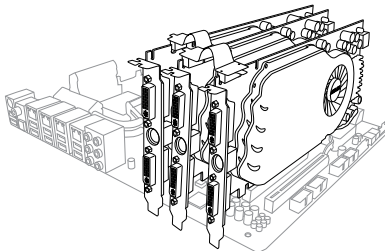

5. Connect three independent auxiliary power sources from the power supply to the three graphics cards separately.
6. Connect a VGA or a DVI cable to the graphics card.

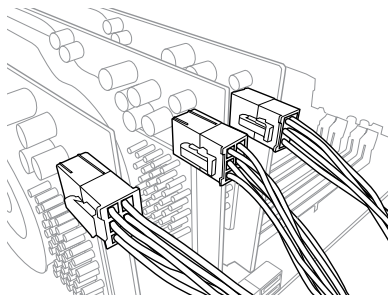



## 5.1.4 Installing the device drivers

Refer to the documentation that came with your graphics card package to install the device drivers.



Ensure that your PCI Express graphics card driver supports the AMD® CrossFireX™ technology. Download the latest driver from the AMD website at [www.amd.com](http://www.amd.com).

## 5.1.5 Enabling the AMD® CrossFireX™ technology

After installing your graphics cards and the device drivers, enable the CrossFireX™ feature through the AMD Vision Engine Control Center in Windows environment.

### Launching the AMD VISION Engine Control Center

To launch the AMD VISION Engine Control Center:

Right-click on the Windows® desktop and select **AMD VISION Engine Control Center**.

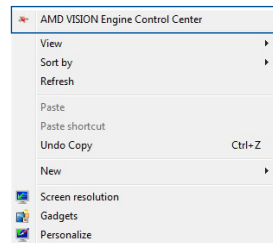

## Enabling Dual CrossFire™ technology

To enable Dual CrossFire™ technology:

1. In the AMD Vision Engine Control Center window, click **Performance > AMD CrossFire™**.
2. Select **Enable CrossFire™**.
3. Select a GPU combination from the drop-down list.
4. Click **Apply** to save and activate the GPU settings made.

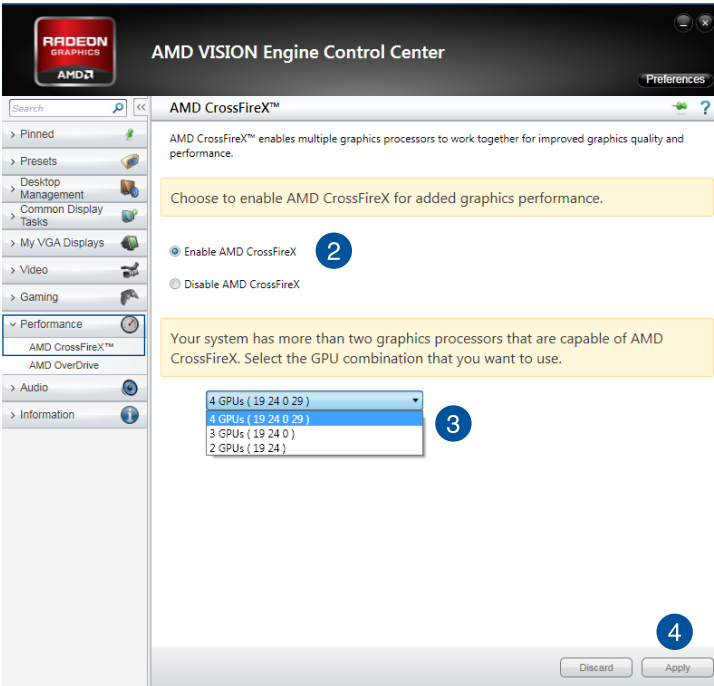

# Appendix

## Notices

### Federal Communications Commission Statement

This device complies with Part 15 of the FCC Rules. Operation is subject to the following two conditions:

- This device may not cause harmful interference.
- This device must accept any interference received including interference that may cause undesired operation.

This equipment has been tested and found to comply with the limits for a Class B digital device, pursuant to Part 15 of the FCC Rules. These limits are designed to provide reasonable protection against harmful interference in a residential installation. This equipment generates, uses and can radiate radio frequency energy and, if not installed and used in accordance with manufacturer's instructions, may cause harmful interference to radio communications. However, there is no guarantee that interference will not occur in a particular installation. If this equipment does cause harmful interference to radio or television reception, which can be determined by turning the equipment off and on, the user is encouraged to try to correct the interference by one or more of the following measures:

- Reorient or relocate the receiving antenna.
- Increase the separation between the equipment and receiver.
- Connect the equipment to an outlet on a circuit different from that to which the receiver is connected.
- Consult the dealer or an experienced radio/TV technician for help.



---

The use of shielded cables for connection of the monitor to the graphics card is required to assure compliance with FCC regulations. Changes or modifications to this unit not expressly approved by the party responsible for compliance could void the user's authority to operate this equipment.

---

## Compliance Statement of Innovation, Science and Economic Development Canada (ISED)

This device complies with Innovation, Science and Economic Development Canada licence exempt RSS standard(s). Operation is subject to the following two conditions: (1) this device may not cause interference, and (2) this device must accept any interference, including interference that may cause undesired operation of the device.

CAN ICES-3(B)/NMB-3(B)

## Déclaration de conformité de Innovation, Sciences et Développement économique Canada (ISED)

Le présent appareil est conforme aux CNR d'Innovation, Sciences et Développement économique Canada applicables aux appareils radio exempts de licence. L'exploitation est autorisée aux deux conditions suivantes : (1) l'appareil ne doit pas produire de brouillage, et (2) l'utilisateur de l'appareil doit accepter tout brouillage radioélectrique subi, même si le brouillage est susceptible d'en compromettre le fonctionnement.

CAN ICES-3(B)/NMB-3(B)

## VCCI: Japan Compliance Statement

### Class B ITE

この装置は、クラスB情報技術装置です。この装置は、家庭環境で使用することを目的としていますが、この装置がラジオやテレビジョン受信機に近接して使用されると、受信障害を引き起こすことがあります。

取扱説明書に従って正しい取り扱いをして下さい。

VCCI-B

## KC: Korea Warning Statement

B급 기기 (가정용 방송통신기자재)

이 기기는 가정용(B급) 전자파적합기기로서 주로 가정에서 사용하는 것을 목적으로 하며, 모든 지역에서 사용할 수 있습니다.

## REACH

Complying with the REACH (Registration, Evaluation, Authorisation, and Restriction of Chemicals) regulatory framework, we published the chemical substances in our products at ASUS REACH website at <http://csr.asus.com/english/REACH.htm>.



DO NOT throw the motherboard in municipal waste. This product has been designed to enable proper reuse of parts and recycling. This symbol of the crossed out wheeled bin indicates that the product (electrical and electronic equipment) should not be placed in municipal waste. Check local regulations for disposal of electronic products.



DO NOT throw the mercury-containing button cell battery in municipal waste. This symbol of the crossed out wheeled bin indicates that the battery should not be placed in municipal waste.

## ASUS Recycling/Takeback Services

ASUS recycling and takeback programs come from our commitment to the highest standards for protecting our environment. We believe in providing solutions for you to be able to responsibly recycle our products, batteries, other components as well as the packaging materials. Please go to <http://csr.asus.com/english/Takeback.htm> for detailed recycling information in different regions.

## Regional notice for California



### WARNING

Cancer and Reproductive Harm -  
[www.P65Warnings.ca.gov](http://www.P65Warnings.ca.gov)

## Google™ License Terms

Copyright© 2018 Google Inc. All Rights Reserved.

Licensed under the Apache License, Version 2.0 (the "License"); you may not use this file except in compliance with the License. You may obtain a copy of the License at:

<http://www.apache.org/licenses/LICENSE-2.0>

Unless required by applicable law or agreed to in writing, software distributed under the License is distributed on an "AS IS" BASIS, WITHOUT WARRANTIES OR CONDITIONS OF ANY KIND, either express or implied.

See the License for the specific language governing permissions and limitations under the License.

**English** ASUSTeK Computer Inc. hereby declares that this device is in compliance with the essential requirements and other relevant provisions of related Directives. Full text of EU declaration of conformity is available at: [www.asus.com/support](http://www.asus.com/support)

**Français** AsusTek Computer Inc. déclare par la présente que cet appareil est conforme aux critères essentiels et autres clauses pertinentes des directives concernées. La déclaration de conformité de l'UE peut être téléchargée à partir du site Internet suivant: [www.asus.com/support](http://www.asus.com/support)

**Deutsch** ASUSTeK Computer Inc. erklärt hiermit, dass dieses Gerät mit den wesentlichen Anforderungen und anderen relevanten Bestimmungen der zugehörigen Richtlinien übereinstimmt. Der gesamte Text der EU-Konformitätserklärung ist verfügbar unter: [www.asus.com/support](http://www.asus.com/support)

**Italiano** ASUSTeK Computer Inc. con la presente dichiara che questo dispositivo è conforme ai requisiti essenziali e alle altre disposizioni pertinenti con le direttive correlate. Il testo completo della dichiarazione di conformità UE è disponibile all'indirizzo: [www.asus.com/support](http://www.asus.com/support)

**Русский** Компания ASUS заявляет, что это устройство соответствует основным требованиям и другим соответствующим условиям соответствующих директив. Подробную информацию, пожалуйста, смотрите на [www.asus.com/support](http://www.asus.com/support)

**Български** С настоящото ASUSTEK Computer Inc. декларира, че това устройство е в съответствие със съществените изисквания и другите приложими постановления на свързаните директиви. Пълният текст на декларацията за съответствие на ЕС е достъпен на адрес: [www.asus.com/support](http://www.asus.com/support)

**Hrvatski** ASUSTeK Computer Inc. ovim izjavljuje da je ovaj uređaj sukladan s bitnim zahtjevima i ostalim odgovarajućim odredbama vezanih direktiva. Cijeli tekst EU izjave o sukladnosti dostupan je na: [www.asus.com/support](http://www.asus.com/support)

**Čeština** Společnost ASUSTEK Computer Inc. tímto prohlašuje, že toto zařízení splňuje základní požadavky a další příslušná ustanovení souvisejících směrnic. Plné znění prohlášení o shodě EU je k dispozici na adrese: [www.asus.com/support](http://www.asus.com/support)

**Dansk** ASUSTeK Computer Inc. erklærer hermed, at denne enhed er i overensstemmelse med hovedkravene og andre relevante bestemmelser i de relaterede direktiver. Hele EU-overensstemmelseserklæringen kan findes på: [www.asus.com/support](http://www.asus.com/support)

**Nederlands** ASUSTEK Computer Inc. verklaart hierbij dat dit apparaat voldoet aan de essentiële vereisten en andere relevante bepalingen van de verwante richtlijnen. De volledige tekst van de EU-verklaring van conformiteit is beschikbaar op: [www.asus.com/support](http://www.asus.com/support)

**Eesti** Käesolevaga kinnitab ASUSTEK Computer Inc, et see seade vastab asjakohaste direktiivide olulistele nõuetele ja teistele asjassepuutuvatele sätetele. El vastavusdeklaratsiooni täielik tekst on saadaval järgmisel aadressil: [www.asus.com/support](http://www.asus.com/support)

**Suomi** ASUSTEK Computer Inc. ilmoittaa täten, että tämä laite on asiaankuuluvien direktiivien olennaisten vaatimusten ja muiden tätä koskevien säädösten mukainen. EU-yhdenmukaisuusilmoituksen koko teksti on luettavissa osoitteessa: [www.asus.com/support](http://www.asus.com/support)

**Ελληνικά** Με το παρόν, η AsusTek Computer Inc. δηλώνει ότι αυτή η συσκευή συμμορφώνεται με τις θεμελιώδεις απαιτήσεις και άλλες σχετικές διατάξεις των Οδηγιών της ΕΕ. Το πλήρες κείμενο της δήλωσης συμμόρφωσης είναι διαθέσιμο στη διεύθυνση: [www.asus.com/support](http://www.asus.com/support)

**Magyar** Az ASUSTEK Computer Inc. ezennel kijelenti, hogy ez az eszköz megfelel a kapcsolódó irányelvek lényeges követelményeinek és egyéb vonatkozó rendelkezéseinek. Az EU megfélelősegi nyilatkozat teljes szövege innen letölthető: [www.asus.com/support](http://www.asus.com/support)

**Latviski** ASUSTEK Computer Inc. ar šo paziņo, ka šī ierīce atbilst saistošo Direktīvu būtiskajām prasībām un citiem citiem saistošajiem nosacījumiem. Pilns ES atbilstības paziņojuma teksts pieejams šeit: [www.asus.com/support](http://www.asus.com/support)

**Lietuvių** „ASUSTEK Computer Inc.“ šiuo tvirtina, kad šis įrenginys atitinka pagrindinius reikalavimus ir kitas svarbias susijusių direktyvų nuostatas. Visą ES atitikties deklaracijos tekstą galima rasti: [www.asus.com/support](http://www.asus.com/support)

**Norsk** ASUSTEK Computer Inc. erklærer herved at denne enheten er i samsvar med hovedsaklige krav og andre relevante forskrifter i relaterede direktiver. Fullstendig tekst for EU-samsvarserklæringen finnes på: [www.asus.com/support](http://www.asus.com/support)

**Polski** Firma ASUSTEK Computer Inc. niniejszym oświadcza, że urządzenie to jest zgodne z zasadniczymi wymogami i innymi właściwymi postanowieniami powiązanych dyrektyw. Pełny tekst deklaracji zgodności UE jest dostępny pod adresem: [www.asus.com/support](http://www.asus.com/support)

**Português** A ASUSTEK Computer Inc. declara que este dispositivo está em conformidade com os requisitos essenciais e outras disposições relevantes das Diretivas relacionadas. Texto integral da declaração da UE disponível em: [www.asus.com/support](http://www.asus.com/support)

**Română** ASUSTEK Computer Inc. declară că acest dispozitiv se conformează cerințelor esențiale și altor prevederi relevante ale directivelor conexe. Textul complet al declarației de conformitate a Uniunii Europene se găsește la: [www.asus.com/support](http://www.asus.com/support)

**Srpski** ASUSTEK Computer Inc. ovim izjavljuje da je ovaj uređaj u saglasnosti sa osnovnim zahtevima i drugim relevantnijim odredbama povezanih Direktiva. Pun tekst EU deklaracije o usaglašenosti je dostupan da adres: [www.asus.com/support](http://www.asus.com/support)

**Slovensky** Spoločnosť ASUSTEK Computer Inc. týmto vyhlasuje, že toto zariadenie vyhovuje základným požiadavkám a ostatým príslušným ustanoveniam príslušných smerníc. Celý text vyhlásenia zohodre pre štáty EU je dostupný na adrese: [www.asus.com/support](http://www.asus.com/support)

**Slovenščina** ASUSTEK Computer Inc. izjavlja, da je ta naprava skladna z bistvenimi zahtevami in drugimi ustreznimi določbami povezanih direktiv. Celotno besedilo EU-izjave o skladnosti je na voljo na spletnem mestu: [www.asus.com/support](http://www.asus.com/support)

**Español** Por la presente, ASUSTEK Computer Inc. declara que este dispositivo cumple los requisitos básicos y otras disposiciones pertinentes de las directivas relacionadas. El texto completo de la declaración de la UE de conformidad está disponible en: [www.asus.com/support](http://www.asus.com/support)

**Svenska** ASUSTEK Computer Inc. förklarar härmed att denna enhet överensstämmer med de grundläggande kraven och andra relevanta föreskrifter i relaterade direktiv. Fulltext av EU-försäkran om överensstämmelse finns på: [www.asus.com/support](http://www.asus.com/support)

**Українська** ASUSTEK Computer Inc. заявляє, що цей пристрій відповідає основним вимогам та іншим відповідним положенням відповідних Директив. Повний текст декларації відповідності стандартам ЄС доступний на: [www.asus.com/support](http://www.asus.com/support)

**Türkçe** ASUSTEK Computer Inc., bu aygıtın temel gereksinimlerle ve ilişkili Yönergelerin diğer ilgili kullarıyla uyumlu olduğunu beyan eder. AB uygunsuz bildiriminin tam metni şu adreste bulunabilir: [www.asus.com/support](http://www.asus.com/support)

**Bosanski** ASUSTEK Computer Inc. ovim izjavljuje da je ovaj uređaj uskladen sa bitnim zahtjevima i ostalim odgovarajućim odredbama vezanih direktiva. Cijeli tekst EU izjave o uskladenosti dostupan je na: [www.asus.com/support](http://www.asus.com/support)

## ASUS contact information

### ASUSTeK COMPUTER INC.

Address 4F, No. 150, Li-Te Road, Peitou, Taipei 112, Taiwan  
Telephone +886-2-2894-3447  
Fax +886-2-2890-7798  
Web site [www.asus.com](http://www.asus.com)

#### **Technical Support**

Telephone +86-21-38429911  
Fax +86-21-5866-8722, ext. 9101#  
Online support <https://www.asus.com/support/Product/ContactUs/Services/questionform/?lang=en>

### ASUS COMPUTER INTERNATIONAL (America)

Address 48720 Kato Rd., Fremont, CA 94538, USA  
Telephone +1-510-739-3777  
Fax +1-510-608-4555  
Web site <http://www.asus.com/us/>

#### **Technical Support**

Support fax +1-812-284-0883  
Telephone +1-812-282-2787  
Online support <https://www.asus.com/support/Product/ContactUs/Services/questionform/?lang=en-us>

### ASUS COMPUTER GmbH (Germany and Austria)

Address Harkort Str. 21-23, 40880 Ratingen, Germany  
Fax +49-2102-959931  
Web site <http://www.asus.com/de>  
Online contact <http://eu-rma.asus.com/sales>

#### **Technical Support**

Telephone +49-2102-5789555  
Support Fax +49-2102-959911  
Online support <https://www.asus.com/support/Product/ContactUs/Services/questionform/?lang=de-de>

# FCC COMPLIANCE INFORMATION

Per FCC Part 2 Section 2.1077(a)



**Responsible Party:** Asus Computer International  
**Address:** 48720 Kato Rd., Fremont, CA 94538  
**Phone/Fax No:** (510)739-3777/(510)608-4555

**hereby declares that the product**

**Product Name :** Motherboard  
**Model Number :** ROG STRIX B450-F GAMING

**compliance statement:**

This device complies with part 15 of the FCC Rules. Operation is subject to the following two conditions: (1) This device may not cause harmful interference, and (2) this device must accept any interference received, including interference that may cause undesired operation.

Ver. 180125