

TUF B450-PLUS GAMING



Motherboard

E14220
First Edition
May 2018

Copyright © 2018 ASUSTeK COMPUTER INC. All Rights Reserved.

No part of this manual, including the products and software described in it, may be reproduced, transmitted, transcribed, stored in a retrieval system, or translated into any language in any form or by any means, except documentation kept by the purchaser for backup purposes, without the express written permission of ASUSTeK COMPUTER INC. ("ASUS").

Product warranty or service will not be extended if: (1) the product is repaired, modified or altered, unless such repair, modification or alteration is authorized in writing by ASUS; or (2) the serial number of the product is defaced or missing.

ASUS PROVIDES THIS MANUAL "AS IS" WITHOUT WARRANTY OF ANY KIND, EITHER EXPRESS OR IMPLIED, INCLUDING BUT NOT LIMITED TO THE IMPLIED WARRANTIES OR CONDITIONS OF MERCHANTABILITY OR FITNESS FOR A PARTICULAR PURPOSE. IN NO EVENT SHALL ASUS, ITS DIRECTORS, OFFICERS, EMPLOYEES OR AGENTS BE LIABLE FOR ANY INDIRECT, SPECIAL, INCIDENTAL, OR CONSEQUENTIAL DAMAGES (INCLUDING DAMAGES FOR LOSS OF PROFITS, LOSS OF BUSINESS, LOSS OF USE OR DATA, INTERRUPTION OF BUSINESS AND THE LIKE), EVEN IF ASUS HAS BEEN ADVISED OF THE POSSIBILITY OF SUCH DAMAGES ARISING FROM ANY DEFECT OR ERROR IN THIS MANUAL OR PRODUCT.

SPECIFICATIONS AND INFORMATION CONTAINED IN THIS MANUAL ARE FURNISHED FOR INFORMATIONAL USE ONLY, AND ARE SUBJECT TO CHANGE AT ANY TIME WITHOUT NOTICE, AND SHOULD NOT BE CONSTRUED AS A COMMITMENT BY ASUS. ASUS ASSUMES NO RESPONSIBILITY OR LIABILITY FOR ANY ERRORS OR INACCURACIES THAT MAY APPEAR IN THIS MANUAL, INCLUDING THE PRODUCTS AND SOFTWARE DESCRIBED IN IT.

Products and corporate names appearing in this manual may or may not be registered trademarks or copyrights of their respective companies, and are used only for identification or explanation and to the owners' benefit, without intent to infringe.

Offer to Provide Source Code of Certain Software

This product contains copyrighted software that is licensed under the General Public License ("GPL"), under the Lesser General Public License Version ("LGPL") and/or other Free Open Source Software Licenses. Such software in this product is distributed without any warranty to the extent permitted by the applicable law. Copies of these licenses are included in this product.

Where the applicable license entitles you to the source code of such software and/or other additional data, you may obtain it for a period of three years after our last shipment of the product, either

(1) for free by downloading it from <http://support.asus.com/download>
or

(2) for the cost of reproduction and shipment, which is dependent on the preferred carrier and the location where you want to have it shipped to, by sending a request to:

ASUSTeK Computer Inc.
Legal Compliance Dept.
15 Li Te Rd.,
Beitou, Taipei 112
Taiwan

In your request please provide the name, model number and version, as stated in the About Box of the product for which you wish to obtain the corresponding source code and your contact details so that we can coordinate the terms and cost of shipment with you.

The source code will be distributed WITHOUT ANY WARRANTY and licensed under the same license as the corresponding binary/object code.

This offer is valid to anyone in receipt of this information.

ASUSTeK is eager to duly provide complete source code as required under various Free Open Source Software licenses. If however you encounter any problems in obtaining the full corresponding source code we would be much obliged if you give us a notification to the email address gpl@asus.com, stating the product and describing the problem (please DO NOT send large attachments such as source code archives, etc. to this email address).

Contents

Safety information	iv
About this guide	iv
Package contents	vi
TUF B450-PLUS GAMING specifications summary.....	vi

Chapter 1: Product introduction

Motherboard overview	1-1
Central Processing Unit (CPU).....	1-8
System memory	1-10

Chapter 2: BIOS information

BIOS setup program.....	2-1
EZ Mode.....	2-2
Advanced Mode	2-3
Exit menu.....	2-4

Appendix

Notices.....	A-1
ASUS contact information	A-5

Safety information

Electrical safety

- To prevent electrical shock hazard, disconnect the power cable from the electrical outlet before relocating the system.
- When adding or removing devices to or from the system, ensure that the power cables for the devices are unplugged before the signal cables are connected. If possible, disconnect all power cables from the existing system before you add a device.
- Before connecting or removing signal cables from the motherboard, ensure that all power cables are unplugged.
- Seek professional assistance before using an adapter or extension cord. These devices could interrupt the grounding circuit.
- Ensure that your power supply is set to the correct voltage in your area. If you are not sure about the voltage of the electrical outlet you are using, contact your local power company.
- If the power supply is broken, do not try to fix it by yourself. Contact a qualified service technician or your retailer.

Operation safety

- Before installing the motherboard and adding components, carefully read all the manuals that came with the package.
- Before using the product, ensure all cables are correctly connected and the power cables are not damaged. If you detect any damage, contact your dealer immediately.
- To avoid short circuits, keep paper clips, screws, and staples away from connectors, slots, sockets and circuitry.
- Avoid dust, humidity, and temperature extremes. Do not place the product in any area where it may be exposed to moisture.
- Place the product on a stable surface.
- If you encounter technical problems with the product, contact a qualified service technician or your retailer.

About this guide

This user guide contains the information you need when installing and configuring the motherboard.

How this guide is organized

This guide contains the following parts:

- **Chapter 1: Product introduction**
This chapter describes the features of the motherboard and the new technology it supports. It includes descriptions of the switches, jumpers, and connectors on the motherboard.
- **Chapter 2: BIOS information**
This chapter discusses changing system settings through the BIOS Setup menus.

Where to find more information

Refer to the following sources for additional information and for product and software updates.

1. ASUS websites

The ASUS website provides updated information on ASUS hardware and software products. Refer to the ASUS contact information.

2. Optional documentation

Your product package may include optional documentation, such as warranty flyers, that may have been added by your dealer. These documents are not part of the standard package.

Conventions used in this guide

To ensure that you perform certain tasks properly, take note of the following symbols used throughout this manual.



DANGER/WARNING: Information to prevent injury to yourself when completing a task.



CAUTION: Information to prevent damage to the components when completing a task.



IMPORTANT: Instructions that you **MUST** follow to complete a task.



NOTE: Tips and additional information to help you complete a task.

Typography

Bold text

Indicates a menu or an item to select.

Italics

Used to emphasize a word or a phrase.

<Key>

Keys enclosed in the less-than and greater-than sign means that you must press the enclosed key.

Example: <Enter> means that you must press the Enter or Return key.

<Key1> + <Key2> + <Key3>

If you must press two or more keys simultaneously, the key names are linked with a plus sign (+).

Package contents

Check your motherboard package for the following items.

Motherboard	ASUS TUF B450-PLUS GAMING motherboard
Cables	2 x Serial ATA 6.0 Gb/s cables 1 x I/O shield
Accessories	1 x M.2 screw package 1 x TUF Certification Card 1 x TUF GAMING Sticker
Application DVD	1 x Support DVD
Documentation	1 x User Manual



If any of the above items is damaged or missing, contact your retailer.

TUF B450-PLUS GAMING specifications summary

CPU	AM4 socket for AMD Ryzen™ 2 nd Generation / Ryzen™ with Radeon™ Vega Graphics / Ryzen™ 1 st Generation processors Supports CPU up to 8 cores* * Due to CPU limitation, CPU cores supported vary by processor. ** Refer to www.asus.com for AMD CPU support list.
Chipset	AMD B450 chipset
Memory	AMD Ryzen™ 2nd Generation/AMD Ryzen™ with Radeon™ Vega Graphics/ Ryzen™ 1st Generation processors: 4 x DIMM, max. 64GB, DDR4 3200(O.C.)/3000(O.C.)/2800(O.C)/2666/2400/2133 MHz, un-buffered memory Dual-channel memory architecture * Refer to www.asus.com for the latest Memory QVL (Qualified Vendors List). ** ECC memory(ECC mode) support varies by CPU.
Graphics	Integrated Graphics in the AMD Ryzen™ with Radeon™ Vega Graphics processors Multi-VGA output support: HDMI and DVI-D ports - Supports HDMI 2.0b output with a maximum resolution of 4096x2160 @60Hz - Supports DVI-D output with a maximum resolution of 1920 x 1200 @60Hz
Expansion slots	AMD Ryzen™ 2nd Generation / Ryzen™ 1st Generation processors: 1 x PCI Express 3.0 x16 slot (max. @x16 mode) AMD Ryzen™ with Radeon™ Vega Graphics processors: 1 x PCI Express 3.0 x16 slot (max. @x8 mode) AMD B450 Chipset: 1 x PCI Express 2.0 x16 slot (max. @x4 mode) 3 x PCI Express 2.0 x1 slots
USB	AMD Ryzen™ 2nd Generation/ Ryzen™ with Radeon™ Vega Graphics/ Ryzen™ 1st Generation processors: - 3 x USB 3.1 Gen 1 (up to 5Gbps) ports (2 Type A ports and 1 Type C port at back panel) AMD B450 Chipset: - 2 x USB 3.1 Gen 2 (up to 10 Gbps) ports (2 ports at back panel) - 2 x USB 3.1 Gen 1 (up to 5Gbps) ports (2 ports at mid-board) - 6 x USB 2.0/1.1 ports (2 ports at back panel, 4 ports at mid-board)

(continued on the next page)

TUF B450-PLUS GAMING specifications summary

Multi-GPU support	Supports AMD CrossFireX™ Technology
Storage	<p>AMD B450 Chipset</p> <ul style="list-style-type: none"> - 4 x Serial ATA 6.0 Gb/s connectors with RAID 0, RAID 1 and RAID 10 support <p>AMD Ryzen™ 2nd Generation/ Ryzen™ with Radeon™ Vega Graphics/ Ryzen™ 1st Generation processors:</p> <ul style="list-style-type: none"> - 2 x Serial ATA 6.0 Gb/s connectors with RAID 0, RAID 1 and RAID 10 support <p>AMD Ryzen™ 2nd Generation/ Ryzen™ with Radeon™ Vega Graphics/ Ryzen™ 1st Generation processors:</p> <ul style="list-style-type: none"> - 1 x M.2 socket 3 with M Key, Type 2242/2260/2280/22110 (PCIe 3.0 x4 and SATA modes) storage devices support* <p>* The M.2 Socket shares bandwidth with the SATA_5/6 ports, and therefore the SATA_5/6 ports cannot be used when an M.2 device is installed.</p>
LAN	Realtek® 8111H Gigabit LAN controller
Audio	<p>Realtek® ALC 887-VD2 8-Channel High Definition Audio CODEC</p> <ul style="list-style-type: none"> - Exclusive DTS Custom for GAMING Headsets - Audio Shielding: Ensures precision analog/digital separation and greatly reduces multi-lateral interference - Dedicated audio PCB layers: Separate layers for left and right channels to guard the quality of the sensitive audio signals - Premium Japanese audio capacitors: Provide warm, natural and immersive sound with exceptional clarity and fidelity - Supports jack-detection and front panel jack-retasking - Audio Cover: Effective shielding preserves the integrity of audio signals to ensure best quality <p>* Use a chassis with HD audio module in the front panel to support an 8-channel audio output.</p>
ASUS unique features	<p>Dependable Stability</p> <p>ASUS TUF PROTECTION</p> <ul style="list-style-type: none"> - ASUS SafeSlot: Protect your graphics card Investment - ASUS LANGuard: Protects against LAN surges, lightning strikes and static-electricity discharges! - ASUS Overvoltage Protection: World-class circuit-protecting power design - ASUS Stainless-Steel Back I/O: 3X corrosion-resistance for greater durability! - ASUS DIGI+ VRM: 6 Phase digital power design <p>Superb performance</p> <p>UEFI BIOS</p> <ul style="list-style-type: none"> - The most advanced options with a fast response time <p>ASUS Fan Xpert 4 Core</p> <ul style="list-style-type: none"> - Advanced fan and liquid controls for ultimate cooling and quietness <p>GAMING</p> <p>Aura</p> <ul style="list-style-type: none"> - Brings up your Build

(continued on the next page)

TUF B450-PLUS GAMNG specifications summary

<p>ASUS unique features</p>	<p>ASUS Exclusive Features</p> <ul style="list-style-type: none"> - ASUS AI Charger - ASUS File Transfer - ASUS AI Suite 3 - ASUS PC Cleaner <p>Easy PC DIY</p> <p>Safe motherboard mounting</p> <ul style="list-style-type: none"> - Component-free areas to minimize damage risk <p>Q-Design</p> <ul style="list-style-type: none"> - ASUS Q-DIMM - ASUS Q-Slot <p>UEFI BIOS EZ Mode</p> <ul style="list-style-type: none"> - Featuring friendly graphics user interface - ASUS CrashFree BIOS 3 - ASUS EZ Flash 3
<p>ASUS Quiet Thermal Solution</p>	<p>Quiet Thermal Design:</p> <ul style="list-style-type: none"> - Stylish Fanless Design: MOS Heat-sink & Chipset Heat-sink solution - ASUS Fan Xpert 4 core
<p>Rear panel I/O ports</p>	<p>1 x PS/2 Keyboard/Mouse combo port</p> <p>1 x HDMI port</p> <p>1 x DVI-D port</p> <p>1 x LAN (RJ-45) port</p> <p>2 x USB 3.1 Gen 2 (up to 10 Gbps) ports (Type A, teal blue)</p> <p>1 x USB 3.1 Gen 1 (up to 5 Gbps) port (Type C)</p> <p>2 x USB 3.1 Gen 1 (up to 5 Gbps) ports (Type A, blue)</p> <p>2 x USB 2.0/1.1 ports</p> <p>3 x Audio jacks support 8-channel audio output</p>
<p>Internal connectors</p>	<p>1 x USB 3.1 Gen 1 (up to 5Gbps) connector supports additional 2 USB 3.1 Gen 1 ports</p> <p>2 x USB 2.0/1.1 connectors support additional 4 USB 2.0/1.1 ports</p> <p>6 x SATA 6.0 Gb/s connectors</p> <p>1 x M.2 socket 3 for M Key and type 2242/2260/2280/22110 devices support (both SATA & PCIe mode)</p> <p>1 x COM connector</p> <p>1 x CPU Fan connector</p> <p>3 x 4-pin Chassis Fan connectors for both 3-pin (DC mode) and 4-pin (PWM mode) coolers control</p> <p>1 x Front panel audio connector</p> <p>1 x 24-pin EATX power connector</p> <p>1 x 8-pin EATX 12V power connector</p> <p>1 x 2-pin Clear CMOS header</p> <p>1 x System panel connector</p> <p>1 x S/PDIF out connector</p> <p>1 x AIO pump header</p> <p>1 x Aura RGB Strip header</p>

(continued on the next page)

BIOS features	128 Mb Flash ROM, UEFI AMI BIOS, PnP, SM BIOS 3.1, ACPI 6.1, Multi-language BIOS, ASUS EZ Flash 3, ASUS CrashFree BIOS 3, F3 My Favorite, Last Modified log, F12 PrintScreen, F4 AURA ON/OFF, F9 Search and ASUS DRAM SPD (Serial Presence Detect) memory information
Manageability	WOL by PME, PXE
Support DVD	Drivers ASUS Utilities ASUS Update Anti-virus software (OEM version)
OS support	Windows® 10 (64-bit)
Form factor	ATX form factor: 12" x 9.6" (30.5 cm x 24.4 cm)



Specifications are subject to change without notice.

Product introduction

1

Motherboard overview



- Unplug the power cord from the wall socket before touching any component.
- Before handling components, use a grounded wrist strap or touch a safely grounded object or a metal object, such as the power supply case, to avoid damaging them due to static electricity.
- Before you install or remove any component, ensure that the ATX power supply is switched off or the power cord is detached from the power supply. Failure to do so may cause severe damage to the motherboard, peripherals, or components.
- Unplug the power cord before installing or removing the motherboard. Failure to do so can cause you physical injury and damage to motherboard components.

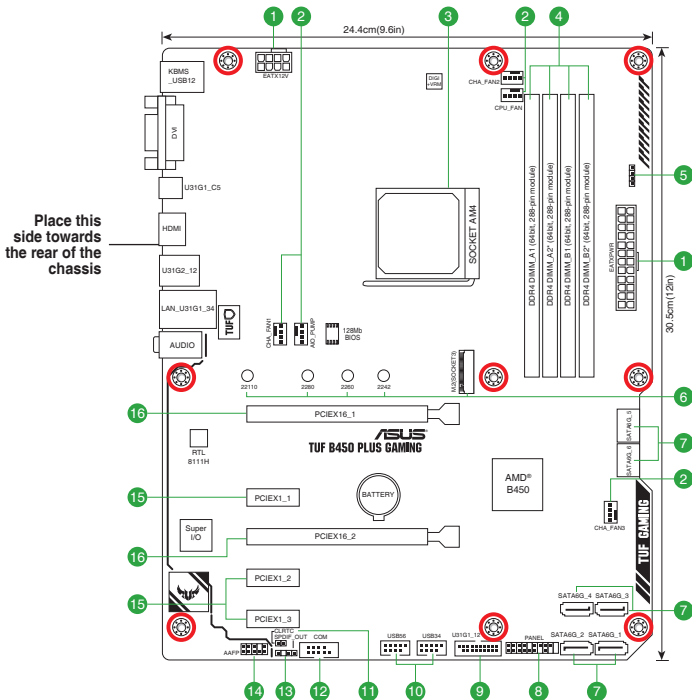

Scan the QR code to get the detailed pin definitions.



1 ATX power connectors (24-pin EATXPWR, 8-pin EATX12V)

These connectors are for ATX power supply plugs. The power supply plugs are designed to fit these connectors in only one orientation. Find the proper orientation and push down firmly until the connectors completely fit.



- For a fully configured system, we recommend that you use a power supply unit (PSU) that complies with ATX12V Specification 2.0 (or later version) and provides a minimum power of 350 W. This PSU type has 24-pin and 8-pin power plugs.
- DO NOT forget to connect the 8-pin EATX +12V power plug. Otherwise, the system will not boot up.
- We recommend that you use a PSU with higher power output when configuring a system with more power-consuming devices or when you intend to install additional devices. The system may become unstable or may not boot up if the power is inadequate.
- If you are uncertain about the minimum power supply requirement for your system, refer to the Recommended Power Supply Wattage Calculator at <http://support.asus.com/PowerSupplyCalculator/PSCalculator.aspx?SLanguage=en-us> for details.

2 CPU and chassis fan connectors; AIO pump connector (4-pin CPU_FAN, 4-pin CHA_FAN1/2/3; 4-pin AIO_PUMP)

Connect the fan cables to the fan connectors on the motherboard, ensuring that the black wire of each cable matches the ground pin of the connector.



Do not forget to connect the fan cables to the fan connectors. Insufficient air flow inside the system may damage the motherboard components. These are not jumpers! Do not place jumper caps on the fan connectors! The CPU_FAN connector supports a CPU fan of maximum 1A (12 W) fan power.

3 AMD AM4 CPU socket

This motherboard comes with an AMD AM4 socket designed for AMD Ryzen™ 2nd Generation / Ryzen™ with Radeon™ Vega Graphics / Ryzen™ 1st Generation processors.



For more details, refer to **Central Processing Unit (CPU)**.

4 DDR4 DIMM slots

Install 2 GB, 4 GB, 8 GB, and 16 GB unbuffered DDR4 DIMMs into these DIMM sockets.



For more details, refer to **System memory**.

5**Aura RGB Strip header (4-pin RGB_HEADER)**

This header is for RGB LED strip.



The RGB header supports 5050 RGB multi-color LED strips (12V/G/R/B), with a maximum power rating of 3A (12V), and no longer than 3 m.

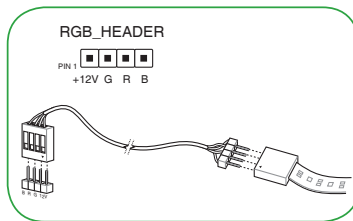

Before you install or remove any component, ensure that the ATX power supply is switched off or the power cord is detached from the power supply. Failure to do so may cause severe damage to the motherboard, peripherals, or components.



- Actual lighting and color will vary with LED strip.
- If your LED strip does not light up, check if the RGB LED extension cable and the RGB LED strip is connected in the correct orientation, and the 12V connector is aligned with the 12V header on the motherboard.
- The LED strip will only light up when the system is operating.
- The LED strips are purchased separately.

6**M.2 socket 3**

This socket allows you to install M.2 (NGFF) SSD modules.

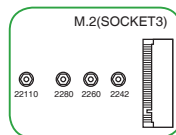

- The M.2 socket supports PCIe 3.0 x4 mode and SATA mode M Key design and type 2242 / 2260 / 2280 / 22110 storage devices.
- The M.2 Socket shares bandwidth with the SATA_5/6 ports, and therefore the SATA_5/6 ports cannot be used when an M.2 device is installed.

**7****AMD Serial ATA 6.0 Gb/s connectors (7-pin SATA6G_1~6)**

These connectors connect to Serial ATA 6.0 Gb/s hard disk drives via Serial ATA 6.0 Gb/s signal cables.

8**System panel connector (20-5 pin F_PANEL)**

This connector supports several chassis-mounted functions.

9**USB 3.1 Gen 1 (up to 5Gbps) connector (20-1 pin U31G1_12)**

Connect a USB 3.1 Gen 1 module to this connector for additional USB 3.1 Gen 1 front or rear panel ports. This connector complies with USB 3.1 Gen 1 specifications and provides faster data transfer speeds of up to 5 Gbps, faster charging time for USB-chargeable devices, optimized power efficiency, and backward compatibility with USB 2.0.

10**USB 2.0 connectors (10-1 pin USB34,USB56)**

Connect a USB module cable to any of these connectors, then install the module to a slot opening at the back of the system chassis. These USB connectors comply with USB 2.0 specifications and support up to 480Mbps connection speed.

11**Clear RTC RAM (2-pin CLRTC)**

This header allows you to clear the CMOS RTC RAM data of the system setup information such as date, time, and system passwords.

To erase the RTC RAM:

1. Turn OFF the computer and unplug the power cord.
2. Use a metal object such as a screwdriver to short the two pins.
3. Plug the power cord and turn ON the computer.
4. Hold down the key during the boot process and enter BIOS setup to re-enter data.

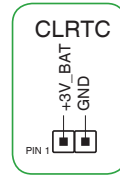

If the steps above do not help, remove the onboard battery and short the two pins again to clear the CMOS RTC RAM data. After clearing the CMOS, reinstall the battery.

12**Serial port connector (10-1 pin COM)**

This connector is for a serial (COM) port. Connect the serial port module cable to this connector, then install the module to a slot opening at the back of the system chassis.

13**Digital audio connector (4-1 pin SPDIF_OUT)**

This connector is for an additional Sony/Philips Digital Interface (S/PDIF) port. Connect the S/PDIF Out module cable to this connector, then install the module to a slot opening at the back of the system chassis.

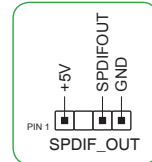
**14****Front panel audio connector (10-1 pin AAFP)**

This connector is for a chassis-mounted front panel audio I/O module that supports HD Audio standard. Connect one end of the front panel audio I/O module cable to this connector.



We recommend that you connect a high-definition front panel audio module to this connector to avail of the motherboard's high-definition audio capability.

15**PCI Express 2.0 x1 slots**

This motherboard has three PCI Express 2.0 x1 slots that support PCI Express x1 network cards, SCSI cards, and other cards that comply with the PCI Express specifications.

16**PCI Express 3.0 / 2.0 x16 slots**

This motherboard supports two PCI Express 3.0 / 2.0 x16 graphic cards that comply with the PCI Express specifications.

AMD Ryzen™ 2nd Generation/ Ryzen™ 1st Generation Processors

VGA Configuration	PCIe operating mode	
	PCIe 3.0 x16_1	PCIe 2.0 x16_2
Single VGA/PCIe card	x16	N/A
Dual VGA/PCIe card	x16	x4

AMD Ryzen™ with Radeon™ Vega Graphics Processors

VGA Configuration	PCIe operating mode	
	PCIe 3.0 x16_1	PCIe 2.0 x16_2
Single VGA/PCIe card	x8	N/A
Dual VGA/PCIe card	x8	x4



-
- In single VGA card mode, use the PCIe 3.0/2.0 x16_1 slot (gray) for a PCI Express x16 graphics card to get better performance.
 - We recommend that you provide sufficient power when running CrossFireX™ mode.
 - Connect chassis fans to the motherboard chassis fan connectors when using multiple graphics cards for better thermal environment.
-

Rear panel connectors

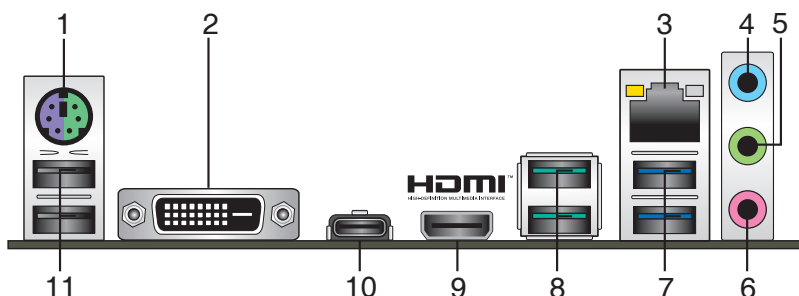

1. **PS/2 Keyboard/Mouse combo port.** This port is for a PS/2 keyboard or mouse.
2. **DVI-D port.** This port is for any DVI-D compatible device.



DVI-D can not be converted to output from RGB Signal to CRT and is not compatible with DVI-I.

3. **LAN (RJ-45) port.** This port allows Gigabit connection to a Local Area Network (LAN) through a network hub.

LAN port LED indications

Activity/Link LED		Speed LED	
Status	Description	Status	Description
Off	No link	OFF	10Mbps connection
Orange	Linked	ORANGE	100Mbps connection
Orange (Blinking)	Data activity	GREEN	1Gbps connection
Orange (Blinking then steady)	Ready to wake up from S5 mode		

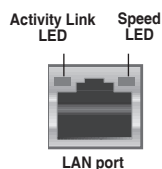

4. **Line In port (light blue).** This port connects to the tape, CD, DVD player, or other audio sources.
5. **Line Out port (lime).** This port connects to a headphone or a speaker. In the 4.1, 5.1 and 7.1-channel configurations, the function of this port becomes Front Speaker Out.
6. **Microphone port (pink).** This port connects to a microphone.



Refer to the audio configuration table for the function of the audio ports in 2.1, 4.1, 5.1, or 7.1-channel configuration.

Audio 2.1, 4.1, 5.1 or 7.1-channel configuration

Port	Headset 2.1-channel	4.1-channel	5.1-channel	7.1-channel
Light Blue (Rear panel)	Line In	Rear Speaker Out	Rear Speaker Out	Rear Speaker Out
Lime (Rear panel)	Line Out	Front Speaker Out	Front Speaker Out	Front Speaker Out
Pink (Rear panel)	Mic In	Mic In	Bass/Center	Bass/Center
Lime (Front panel)	-	-	-	Side Speaker Out

- 7. USB 3.1 Gen 1 (up to 5Gbps) ports.** These two 9-pin Universal Serial Bus (USB) ports connect to USB 3.1 Gen 1 devices.
- 8. USB 3.1 Gen 2 (up to 10Gbps) ports.** These 9-pin Universal Serial Bus (USB) ports are for USB 3.1 Gen 2 devices.



-
- USB 3.1 Gen 1/Gen 2 devices can only be used for data storage.
 - Due to the design of AMD AM4 series chipset, all USB devices connected to the USB 2.0 and USB 3.1 Gen 1/Gen 2 ports are controlled by the xHCI controller.
 - We strongly recommend that you connect USB 3.1 Gen 2 devices to USB 3.1 Gen 2 ports for faster and better performance from your USB 3.1 Gen 2 devices.
-

- 9. HDMI port.** This port is for a High-Definition Multimedia Interface (HDMI) connector, and is HDCP compliant allowing playback of HD DVD, Blu-ray, and other protected content.
- 10. USB 3.1 Gen 1 (up to 5Gbps) port (Type-C).** This Universal Serial Bus (USB) Type C port is for USB 3.1 Gen 1 mobile or peripheral devices.
- 11. USB 2.0 ports.** These 4-pin Universal Serial Bus (USB) ports are for USB 2.0/1.1 devices.

Central Processing Unit (CPU)

The motherboard comes with an AMD AM4 socket designed for AMD Ryzen™ 2nd Generation / Ryzen™ with Radeon™ Vega Graphics / Ryzen™ 1st Generation processors.

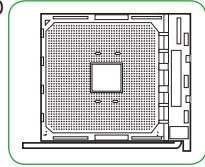

Unplug all power cables before installing the CPU.



The AM4 socket has a different pinout from the FM2+/FM2 socket. Ensure that you use a CPU designed for the AM4 socket. The CPU fits in only one correct orientation. **DO NOT** force the CPU into the socket to prevent bending the pins and damaging the CPU!

Installing the CPU

1

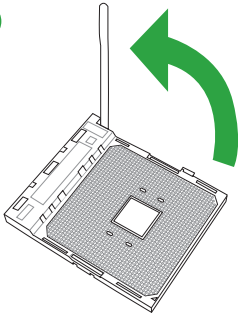

2

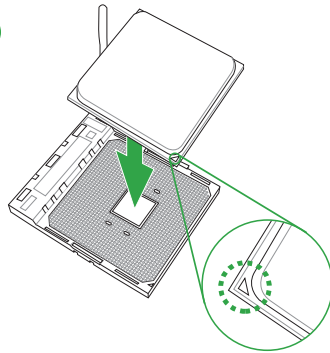

3

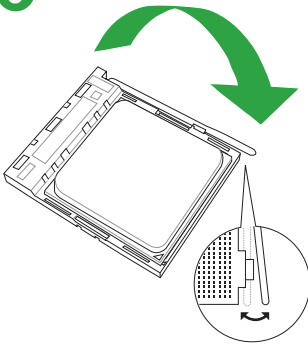

4

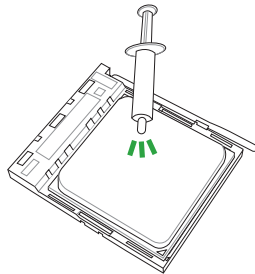

Apply the Thermal Interface Material to the CPU heatsink and CPU before you install the heatsink and fan if necessary.

Installing the CPU heatsink and fan assembly

Type 1

1

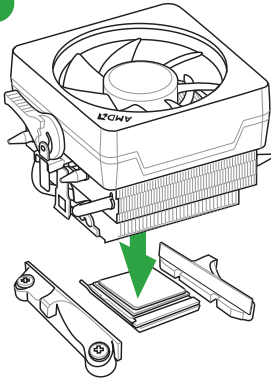

2

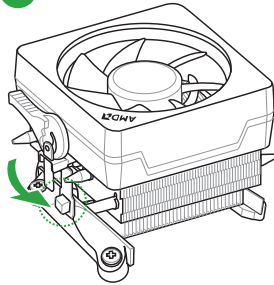

3

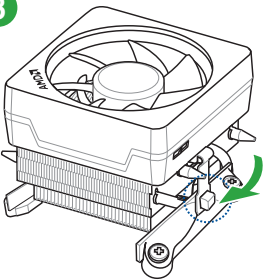

4

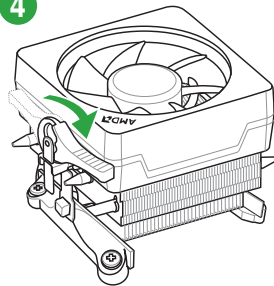

Type 2

1

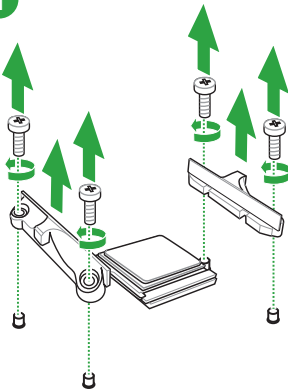

2

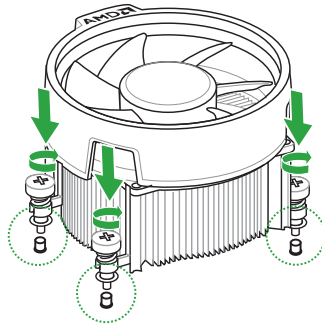

Remove the screws and the retention module only. Do not remove the plate on the bottom.

System memory

Overview

This motherboard comes with four Double Data Rate 4 (DDR4) Dual Inline Memory Module (DIMM) sockets. The figure illustrates the location of the DDR4 DIMM sockets:



Channel	Sockets
Channel A	DIMM_A1 & DIMM_A2*
Channel B	DIMM_B1 & DIMM_B2*



- You may install varying memory sizes in Channel A and Channel B. The system maps the total size of the lower-sized channel for the dual-channel configuration. Any excess memory from the higher-sized channel is then mapped for single-channel operation.
- Always install DIMMs with the same CAS latency. For optimal compatibility, we recommend that you install memory modules of the same version or date code (D/C) from the same vendor. Check with the retailer to get the correct memory modules.



- For system stability, use a more efficient memory cooling system to support a full memory load (4 DIMMs).
- Refer to www.asus.com for the latest Memory QVL (Qualified Vendors List)

Recommended memory configuration

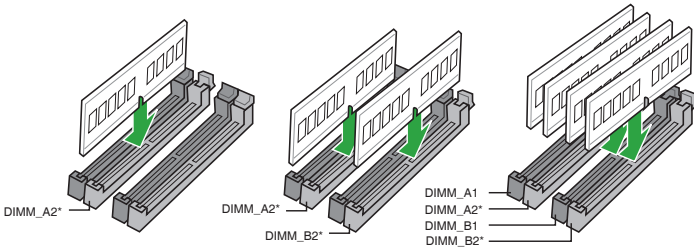

Installing a DIMM

1

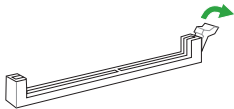

2

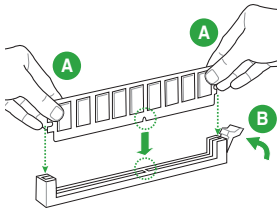

To remove a DIMM

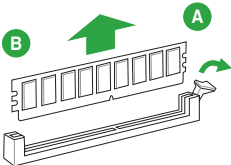

BIOS information

2



- Scan the QR code to view the BIOS update guide.
- Before using the ASUS CrashFree BIOS 3 utility, rename the BIOS file in the removable device into **TB450PSG.CAP**.



BIOS setup program

Use the BIOS Setup program to update the BIOS or configure its parameters. The BIOS screens include navigation keys and brief online help to guide you in using the BIOS Setup program.

Entering BIOS Setup at startup

To enter BIOS Setup at startup:

Press <Delete> or <F2> during the Power-On Self Test (POST). If you do not press <Delete> or <F2>, POST continues with its routines.

Entering BIOS Setup after POST

To enter BIOS Setup after POST:

Press <Ctrl>+<Alt>+ simultaneously.

Press the reset button on the system chassis.

Press the power button to turn the system off then back on. Do this option only if you failed to enter BIOS Setup using the first two options.



Using the power button, reset button, or the <Ctrl>+<Alt>+ keys to force reset from a running operating system can cause damage to your data or system. We recommend you always shut down the system properly from the operating system.



- The BIOS setup screens shown in this section are for reference purposes only, and may not exactly match what you see on your screen.
- Visit the ASUS website at www.asus.com to download the latest BIOS file for this motherboard.
- If the system becomes unstable after changing any BIOS setting, load the default settings to ensure system compatibility and stability. Select the **Load Optimized Defaults** item under the Exit menu or press hotkey F5.
- If the system fails to boot after changing any BIOS setting, try to clear the CMOS and reset the motherboard to the default value. See section **Motherboard overview** for information on how to erase the RTC RAM.

BIOS menu screen

The BIOS setup program can be used under two modes: **EZ Mode** and **Advanced Mode**. Press <F7> to change between the two modes.

EZ Mode

By default, the EZ Mode screen appears when you enter the BIOS setup program. The EZ Mode provides you an overview of the basic system information, and allows you to select the display language, system performance mode, fan profile and boot device priority. To access the Advanced Mode, click **Advanced Mode(F7)** or press <F7>.



The default screen for entering the BIOS setup program can be changed.

Displays the CPU/motherboard temperature, CPU voltage output, CPU/chassis fan speed, and SATA information

Displays the system properties of the selected mode. Click <Enter> to switch EZ System Tuning modes

Selects the display language of the BIOS setup program

Searches by BIOS item name, enter the item name to find the related item listing

Turns the RGB LED lighting or functional LED on or off

Displays the CPU Fan's speed
Click the button to manually tune the fans
Loads optimized default settings

Saves the changes and resets the system

Shows the bootable devices

Displays the Advanced mode menus

Search on FAQ
Selects the boot device priority



The boot device options vary depending on the devices you installed to the system.

Advanced Mode

The Advanced Mode provides advanced options for experienced end-users to configure the BIOS settings. The figure below shows an example of the **Advanced Mode**. Refer to the following sections for the detailed configurations.



To access the EZ Mode, click **EzMode(F7)** or press <F7>.

The screenshot shows the ASUS UEFI BIOS Utility in Advanced Mode. The interface is dark-themed with blue accents. At the top, it displays the date and time (04/27/2018, 22:11), language (English), and navigation icons for MyFavorite (F3), Q-Fan Control (F6), Search (F9), and AURA ON/OFF (F4). The main menu bar includes My Favorites, Main, Ai Tweaker, Advanced, Monitor, Boot, Tool, and Exit. The current view is the Ai Tweaker section, which includes options for AI Overclock Tuner, Memory Frequency, APU Multiplier, EPU Power Saving Mode, and OC Tuner. The OC Tuner is currently set to 'Keep Current Settings'. A detailed information box at the bottom explains the OC tuner's function and provides instructions. On the right side, there is a Hardware Monitor section showing CPU and Memory status, including frequency, temperature, and voltage. The bottom of the screen displays 'Last Modified', 'EzMode(F7)', 'Hot Keys', and 'Search on FAQ'. The version number 'Version 2.17.1246. Copyright (C) 2018 American Megatrends, Inc.' is visible at the bottom center.

Labels in the image:

- MyFavorite
- Q-Fan control
- Search
- AURA ON/OFF
- Language
- Menu bar
- My Favorites
- Main
- Ai Tweaker
- Advanced
- Monitor
- Boot
- Tool
- Exit
- Hardware Monitor
- AI Overclock Tuner
- Memory Frequency
- APU Multiplier
- EPU Power Saving Mode
- OC Tuner
- DRAM Timing Control
- TDP Configuration
- DIGI+ VRM
- VDDCR CPU Voltage
- VDDCR SOC Voltage
- General help
- Configuration fields
- Last modified
- EzMode(F7)
- Hot Keys
- Search on FAQ
- Sub-menu items
- Menu items
- Popup window
- Last settings
- Goes back to EZ Mode
- Scroll bar
- Hot Keys
- Search on FAQ
- Displays hardware monitoring data

Search on FAQ

Move your mouse over this button to show a QR code. Scan this QR code with your mobile device to connect to the ASUS BIOS FAQ web page. You can also scan the QR code below.



Exit menu

The Exit menu items allow you to load the optimal default values for the BIOS items, and save or discard your changes to the BIOS items.

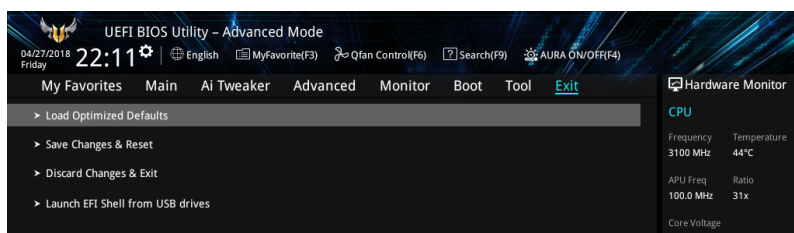

Load Optimized Defaults

This option allows you to load the default values for each of the parameters on the Setup menus. When you select this option or if you press <F5>, a confirmation window appears. Select OK to load the default values.

Save Changes & Reset

Once you are finished making your selections, choose this option from the Exit menu to ensure the values you selected are saved. When you select this option or if you press <F10>, a confirmation window appears. Select OK to save changes and exit.

Discard Changes & Exit

This option allows you to exit the Setup program without saving your changes. When you select this option or if you press <Esc>, a confirmation window appears. Select OK to discard changes and exit.

Launch EFI Shell from USB drives

This option allows you to attempt to launch the EFI Shell application (shellx64.efi) from one of the available USB devices.

Appendix

Notices

Federal Communications Commission Statement

This device complies with Part 15 of the FCC Rules. Operation is subject to the following two conditions:

- This device may not cause harmful interference.
- This device must accept any interference received including interference that may cause undesired operation.

This equipment has been tested and found to comply with the limits for a Class B digital device, pursuant to Part 15 of the FCC Rules. These limits are designed to provide reasonable protection against harmful interference in a residential installation. This equipment generates, uses and can radiate radio frequency energy and, if not installed and used in accordance with manufacturer's instructions, may cause harmful interference to radio communications. However, there is no guarantee that interference will not occur in a particular installation. If this equipment does cause harmful interference to radio or television reception, which can be determined by turning the equipment off and on, the user is encouraged to try to correct the interference by one or more of the following measures:

- Reorient or relocate the receiving antenna.
- Increase the separation between the equipment and receiver.
- Connect the equipment to an outlet on a circuit different from that to which the receiver is connected.
- Consult the dealer or an experienced radio/TV technician for help.



The use of shielded cables for connection of the monitor to the graphics card is required to assure compliance with FCC regulations. Changes or modifications to this unit not expressly approved by the party responsible for compliance could void the user's authority to operate this equipment.

Compliance Statement of Innovation, Science and Economic Development Canada (ISED)

This device complies with Innovation, Science and Economic Development Canada licence exempt RSS standard(s). Operation is subject to the following two conditions: (1) this device may not cause interference, and (2) this device must accept any interference, including interference that may cause undesired operation of the device.

CAN ICES-3(B)/NMB-3(B)

Déclaration de conformité de Innovation, Sciences et Développement économique Canada (ISED)

Le présent appareil est conforme aux CNR d'Innovation, Sciences et Développement économique Canada applicables aux appareils radio exempts de licence. L'exploitation est autorisée aux deux conditions suivantes : (1) l'appareil ne doit pas produire de brouillage, et (2) l'utilisateur de l'appareil doit accepter tout brouillage radioélectrique subi, même si le brouillage est susceptible d'en compromettre le fonctionnement.

CAN ICES-3(B)/NMB-3(B)

VCCI: Japan Compliance Statement

Class B ITE

この装置は、クラスB情報技術装置です。この装置は、家庭環境で使用することを目的としています。この装置がラジオやテレビジョン受信機に近接して使用されると、受信障害を引き起こすことがあります。

取扱説明書に従って正しい取り扱いをして下さい。

VCCI-B

KC: Korea Warning Statement

B급 기기 (가정용 방송통신기자재)

이 기기는 가정용(B급) 전자파적합기기로서 주로 가정에서 사용하는 것을 목적으로 하며, 모든 지역에서 사용할 수 있습니다.

REACH

Complying with the REACH (Registration, Evaluation, Authorisation, and Restriction of Chemicals) regulatory framework, we published the chemical substances in our products at ASUS REACH website at <http://csr.asus.com/english/REACH.htm>.



DO NOT throw the motherboard in municipal waste. This product has been designed to enable proper reuse of parts and recycling. This symbol of the crossed out wheeled bin indicates that the product (electrical and electronic equipment) should not be placed in municipal waste. Check local regulations for disposal of electronic products.



DO NOT throw the mercury-containing button cell battery in municipal waste. This symbol of the crossed out wheeled bin indicates that the battery should not be placed in municipal waste.

ASUS Recycling/Takeback Services

ASUS recycling and takeback programs come from our commitment to the highest standards for protecting our environment. We believe in providing solutions for you to be able to responsibly recycle our products, batteries, other components as well as the packaging materials. Please go to <http://csr.asus.com/english/Takeback.htm> for detailed recycling information in different regions.

Regional notice for California



WARNING

Cancer and Reproductive Harm -
www.P65Warnings.ca.gov

Google™ License Terms

Copyright© 2018 Google Inc. All Rights Reserved.

Licensed under the Apache License, Version 2.0 (the "License"); you may not use this file except in compliance with the License. You may obtain a copy of the License at:

<http://www.apache.org/licenses/LICENSE-2.0>

Unless required by applicable law or agreed to in writing, software distributed under the License is distributed on an "AS IS" BASIS, WITHOUT WARRANTIES OR CONDITIONS OF ANY KIND, either express or implied.

See the License for the specific language governing permissions and limitations under the License.

English ASUSTeK Computer Inc. hereby declares that this device is in compliance with the essential requirements and other relevant provisions of related Directives. Full text of EU declaration of conformity is available at: www.asus.com/support

Français AsusTek Computer Inc. déclare par la présente que cet appareil est conforme aux critères essentiels et autres clauses pertinentes des directives concernées. La déclaration de conformité de l'UE peut être téléchargée à partir du site Internet suivant: www.asus.com/support

Deutsch ASUSTeK Computer Inc. erklärt hiermit, dass dieses Gerät mit den wesentlichen Anforderungen und anderen relevanten Bestimmungen der zugehörigen Richtlinien übereinstimmt. Der gesamte Text der EU-Konformitätserklärung ist verfügbar unter: www.asus.com/support

Italiano ASUSTeK Computer Inc. con la presente dichiara che questo dispositivo è conforme ai requisiti essenziali e alle altre disposizioni pertinenti con le direttive correlate. Il testo completo della dichiarazione di conformità UE è disponibile all'indirizzo: www.asus.com/support

Русский Компания ASUS заявляет, что это устройство соответствует основным требованиям и другим соответствующим условиям соответствующих директив. Подробную информацию, пожалуйста, смотрите на www.asus.com/support

Български С настоящото ASUSTeK Computer Inc. декларира, че това устройство е в съответствие със съществените изисквания и другите приложими постановления на свързаните директиви. Пълният текст на декларацията за съответствие на ЕС е достъпен на адрес: www.asus.com/support

Hrvatski ASUSTeK Computer Inc. ovim izjavljuje da je ovaj uređaj sukladan s bitnim zahtjevima i ostalim odgovarajućim odredbama vezanih direktiva. Cijeli tekst EU izjave o sukladnosti dostupan je na: www.asus.com/support

Čeština Společnost ASUSTeK Computer Inc. tímto prohlašuje, že toto zařízení splňuje základní požadavky a další příslušná ustanovení souvisejících směrnic. Plné znění prohlášení o shodě EU je k dispozici na adrese: www.asus.com/support

Dansk ASUSTeK Computer Inc. erklærer hermed, at denne enhed er i overensstemmelse med hovedkravene og andre relevante bestemmelser i de relaterede direktiver. Hele EU-overensstemmelseserklæringen kan findes på: www.asus.com/support

Nederlands ASUSTeK Computer Inc. verklaart hierbij dat dit apparaat voldoet aan de essentiële vereisten en andere relevante bepalingen van de verwante richtlijnen. De volledige tekst van de EU-verklaring van conformiteit is beschikbaar op: www.asus.com/support

Eesti Käesolevaga kinnitab ASUSTeK Computer Inc, et see seade vastab asjakohaste direktiivide oluliste nõuetele ja teistele asjassepuutuvatele sätetele. El vastavusdeklaratsiooni täielik tekst on saadaval järgmisel aadressil: www.asus.com/support

Suomi ASUSTeK Computer Inc. ilmoittaa täten, että tämä laite on asiaankuuluvien direktiivien olennaisten vaatimusten ja muiden tätä koskevien säädösten mukainen. EU-yhdenmukaisuusilmoituksen koko teksti on luettavissa osoitteessa: www.asus.com/support

Ελληνικά Με το παρόν, η AsusTek Computer Inc. δηλώνει ότι αυτή η συσκευή συμμορφώνεται με τις θεμελιώδεις απαιτήσεις και άλλες σχετικές διατάξεις των Οδηγιών της ΕΕ. Το πλήρες κείμενο της δήλωσης συμμόρφωσης είναι διαθέσιμο στη διεύθυνση: www.asus.com/support

Magyar Az ASUSTeK Computer Inc. ezennel kijelenti, hogy ez az eszköz megfelel a kapcsolódó irányelvek lényeges követelményeinek és egyéb vonatkozó rendelkezéseinek. Az EU megfelelőségi nyilatkozat teljes szövege innen letölthető: www.asus.com/support

Latviski ASUSTeK Computer Inc. ar šo paziņo, ka šī ierīce atbilst saisto Direktīvu būtiskajām prasībām un citiem citiem saistošajiem nosacījumiem. Pilns ES atbilstības paziņojuma teksts pieejams šeit: www.asus.com/support

Lietuvių „ASUSTeK Computer Inc.“ šiuo tvirtina, kad šis įrenginys atitinka pagrindinius reikalavimus ir kitas svarbias susijusių direktyvų nuostatas. Visą ES atitikties deklaracijos tekstą galima rasti: www.asus.com/support

Norsk ASUSTeK Computer Inc. erklærer herved at denne enheten er i samsvar med hovedsaklige krav og andre relevante forskrifter i relaterte direktiver. Fullstendig tekst for EU-samsvarserklæringen finnes på: www.asus.com/support

Polski Firma ASUSTeK Computer Inc. niniejszym oświadcza, że urządzenie to jest zgodne z zasadniczymi wymogami i innymi właściwymi postanowieniami powiązanych dyrektyw. Pełny tekst deklaracji zgodności UE jest dostępny pod adresem: www.asus.com/support

Portugués A ASUSTeK Computer Inc. declara que este dispositivo está em conformidade com os requisitos essenciais e outras disposições relevantes das Diretivas relacionadas. Texto integral da declaração da UE disponível em: www.asus.com/support

Română ASUSTeK Computer Inc. declară că acest dispozitiv se conformează cerințelor esențiale și altor prevederi relevante ale directivelor conexe. Textul complet al declarației de conformitate a Uniunii Europene se găsește la: www.asus.com/support

Srpski ASUSTeK Computer Inc. ovim izjavljuje da je ovaj uređaj u saglasnosti sa osnovnim zahtevima i drugim relevantnim odredbama povezanih Direktiva. Pun tekst EU deklaracije o usaglasnosti je dostupan da adres: www.asus.com/support

Slovensky Spoločnosť ASUSTeK Computer Inc. týmto vyhlasuje, že toto zariadenie vyhovuje základným požiadavkám a ostatým príslušným ustanoveniam príslušných smerníc. Celý text vyhlásenia o zhode pre štáty EÚ je dostupný na adrese: www.asus.com/support

Slovenščina ASUSTeK Computer Inc. izjavlja, da je ta naprava skladna z bistvenimi zahtevami in drugimi ustreznimi določbami povezanih direktiv. Celotno besedilo EU-izjave o skladnosti je na voljo na spletnem mestu: www.asus.com/support

Español Por la presente, ASUSTeK Computer Inc. declara que este dispositivo cumple los requisitos básicos y otras disposiciones pertinentes de las directivas relacionadas. El texto completo de la declaración de la UE de conformidad está disponible en: www.asus.com/support

Svenska ASUSTeK Computer Inc. förklarar härmed att denna enhet överensstämmer med de grundläggande kraven och andra relevanta föreskrifter i relaterade direktiv. Fulltext av EU-försäkran om överensstämmelse finns på: www.asus.com/support

Українська ASUSTeK Computer Inc. заявляє, що цей пристрій відповідає основним вимогам та іншим відповідним положенням відповідних Директив. Повний текст декларації відповідності стандартам ЄС доступний на: www.asus.com/support

Türkçe ASUSTeK Computer Inc., bu aygıtın temel gereksinimlerle ve ilişkili Yönergelere diğer ilgili kullarıyla uyumlu olduğunu beyan eder. AB uygunluk bildirimini tam metni şu adreste bulunabilir: www.asus.com/support

Bosanski ASUSTeK Computer Inc. ovim izjavljuje da je ovaj uređaj uskladan sa bitnim zahtjevima i ostalim odgovarajućim odredbama vezanih direktiva. Cijeli tekst EU izjave o uskladenosti dostupan je na: www.asus.com/support

ASUS contact information

ASUSTeK COMPUTER INC.

Address 4F, No. 150, Li-Te Road, Peitou, Taipei 112, Taiwan
Telephone +886-2-2894-3447
Fax +886-2-2890-7798
Web site www.asus.com

Technical Support

Telephone +86-21-38429911
Fax +86-21-5866-8722, ext. 9101#
Online support <http://qr.asus.com/techserv>

ASUS COMPUTER INTERNATIONAL (America)

Address 48720 Kato Rd., Fremont, CA 94538, USA
Telephone +1-510-739-3777
Fax +1-510-608-4555
Web site <http://www.asus.com/us/>

Technical Support

Support fax +1-812-284-0883
Telephone +1-812-282-2787
Online support <http://qr.asus.com/techserv>

ASUS COMPUTER GmbH (Germany and Austria)

Address Harkort Str. 21-23, 40880 Ratingen, Germany
Fax +49-2102-959931
Web site <http://www.asus.com/de>
Online contact <http://eu-rma.asus.com/sales>

Technical Support

Telephone +49-2102-5789555
Support Fax +49-2102-959911
Online support <http://qr.asus.com/techserv>

FCC COMPLIANCE INFORMATION

Per FCC Part 2 Section 2.1077



Responsible Party: **Asus Computer International**

Address: **800 Corporate Way, Fremont, CA 94539.**

Phone/Fax No: **(510)739-3777/(510)608-4555**

hereby declares that the product

Product Name : **Motherboard**

Model Number : **TUF B450-PLUS GAMING**

compliance statement:

This device complies with part 15 of the FCC Rules. Operation is subject to the following two conditions: (1) This device may not cause harmful interference, and (2) this device must accept any interference received, including interference that may cause undesired operation.

Ver. 180125