

**A88X-PRO**



# Motherboard

E9072

Revised Edition v3

February 2014

**Copyright © 2014 ASUSTeK COMPUTER INC. All Rights Reserved.**

No part of this manual, including the products and software described in it, may be reproduced, transmitted, transcribed, stored in a retrieval system, or translated into any language in any form or by any means, except documentation kept by the purchaser for backup purposes, without the express written permission of ASUSTeK COMPUTER INC. ("ASUS").

Product warranty or service will not be extended if: (1) the product is repaired, modified or altered, unless such repair, modification of alteration is authorized in writing by ASUS; or (2) the serial number of the product is defaced or missing.

ASUS PROVIDES THIS MANUAL "AS IS" WITHOUT WARRANTY OF ANY KIND, EITHER EXPRESS OR IMPLIED, INCLUDING BUT NOT LIMITED TO THE IMPLIED WARRANTIES OR CONDITIONS OF MERCHANTABILITY OR FITNESS FOR A PARTICULAR PURPOSE. IN NO EVENT SHALL ASUS, ITS DIRECTORS, OFFICERS, EMPLOYEES OR AGENTS BE LIABLE FOR ANY INDIRECT, SPECIAL, INCIDENTAL, OR CONSEQUENTIAL DAMAGES (INCLUDING DAMAGES FOR LOSS OF PROFITS, LOSS OF BUSINESS, LOSS OF USE OR DATA, INTERRUPTION OF BUSINESS AND THE LIKE), EVEN IF ASUS HAS BEEN ADVISED OF THE POSSIBILITY OF SUCH DAMAGES ARISING FROM ANY DEFECT OR ERROR IN THIS MANUAL OR PRODUCT.

SPECIFICATIONS AND INFORMATION CONTAINED IN THIS MANUAL ARE FURNISHED FOR INFORMATIONAL USE ONLY, AND ARE SUBJECT TO CHANGE AT ANY TIME WITHOUT NOTICE, AND SHOULD NOT BE CONSTRUED AS A COMMITMENT BY ASUS. ASUS ASSUMES NO RESPONSIBILITY OR LIABILITY FOR ANY ERRORS OR INACCURACIES THAT MAY APPEAR IN THIS MANUAL, INCLUDING THE PRODUCTS AND SOFTWARE DESCRIBED IN IT.

Products and corporate names appearing in this manual may or may not be registered trademarks or copyrights of their respective companies, and are used only for identification or explanation and to the owners' benefit, without intent to infringe.

**Offer to Provide Source Code of Certain Software**

This product contains copyrighted software that is licensed under the General Public License ("GPL"), under the Lesser General Public License Version ("LGPL") and/or other Free Open Source Software Licenses. Such software in this product is distributed without any warranty to the extent permitted by the applicable law. Copies of these licenses are included in this product.

Where the applicable license entitles you to the source code of such software and/or other additional data, you may obtain it for a period of three years after our last shipment of the product, either

(1) for free by downloading it from <http://support.asus.com/download>

or

(2) for the cost of reproduction and shipment, which is dependent on the preferred carrier and the location where you want to have it shipped to, by sending a request to:

ASUSTeK Computer Inc.  
Legal Compliance Dept.  
15 Li Te Rd.,  
Beitou, Taipei 112  
Taiwan

In your request please provide the name, model number and version, as stated in the About Box of the product for which you wish to obtain the corresponding source code and your contact details so that we can coordinate the terms and cost of shipment with you.

The source code will be distributed WITHOUT ANY WARRANTY and licensed under the same license as the corresponding binary/object code.

This offer is valid to anyone in receipt of this information.

ASUSTeK is eager to duly provide complete source code as required under various Free Open Source Software licenses. If however you encounter any problems in obtaining the full corresponding source code we would be much obliged if you give us a notification to the email address [gpl@asus.com](mailto:gpl@asus.com), stating the product and describing the problem (please DO NOT send large attachments such as source code archives, etc. to this email address).

# Contents

Safety information .....	vi
About this guide .....	vii
A88X-PRO specifications summary .....	ix

## Chapter 1: Product introduction

1.1	Welcome! .....	1-1
1.2	Package contents .....	1-1
1.3	Special features .....	1-2
1.3.1	Product highlights .....	1-2
1.3.2	5X Protection .....	1-3
1.3.3	ASUS Exclusive Features .....	1-4
1.3.4	ASUS Quiet Thermal Solutions .....	1-5
1.3.5	ASUS EZ DIY .....	1-5

## Chapter 2: Hardware information

2.1	Before you proceed .....	2-1
2.2	Motherboard overview .....	2-2
2.2.1	Motherboard layout .....	2-2
2.2.2	Accelerated Processing Unit (APU) .....	2-4
2.2.3	System memory .....	2-5
2.2.4	Expansion slots .....	2-17
2.2.5	Jumper .....	2-19
2.2.6	Onboard switches/buttons .....	2-20
2.2.7	Onboard LEDs .....	2-24
2.2.8	Internal connectors .....	2-31
2.3	Building your computer system .....	2-37
2.3.1	Additional tools and components to build a PC system .....	2-37
2.3.2	APU installation .....	2-38
2.3.3	APU heatsink and fan assembly installation .....	2-39
2.3.4	DIMM installation .....	2-41
2.3.5	Motherboard installation .....	2-42
2.3.6	ATX Power connection .....	2-44
2.3.7	SATA device connection .....	2-45
2.3.8	Front I/O Connector .....	2-46
2.3.9	Expansion Card installation .....	2-47
2.3.10	Rear panel connection .....	2-48
2.3.11	Audio I/O connections .....	2-50

# Contents

2.4 Starting up for the first time..... 2-52  
2.5 Turning off the computer..... 2-52

## Chapter 3: BIOS setup

3.1 Knowing BIOS ..... 3-1  
3.2 BIOS setup program ..... 3-1  
    3.2.1 EZ Mode ..... 3-2  
    3.2.2 Advanced Mode ..... 3-3  
3.3 Main menu ..... 3-5  
3.4 Ai Tweaker menu ..... 3-7  
3.5 Advanced menu ..... 3-13  
    3.5.1 CPU Configuration ..... 3-14  
    3.5.2 SATA Configuration ..... 3-15  
    3.5.3 USB Configuration ..... 3-16  
    3.5.4 NB Configuration ..... 3-16  
    3.5.5 Onboard Devices Configuration ..... 3-17  
    3.5.6 APM ..... 3-19  
    3.5.7 Network Stack ..... 3-20  
3.6 Monitor menu ..... 3-21  
3.7 Boot menu ..... 3-25  
3.8 Tools menu ..... 3-31  
3.9 Exit menu ..... 3-33  
3.10 Managing and updating your BIOS ..... 3-34

## Chapter 4: Software support

4.1 Installing an operating system ..... 4-1  
4.2 Support DVD information ..... 4-1  
    4.2.1 Running the support DVD ..... 4-1  
    4.2.2 Obtaining the software manuals ..... 4-2  
4.3 Software information ..... 4-3  
    4.3.1 Ai Suite 3 ..... 4-3  
    4.3.2 Dual Intelligent Processors 4 ..... 4-5  
    4.3.3 Ai Charger+ ..... 4-6

# Contents

4.3.4	EZ Update .....	4-7
4.3.5	USB 3.0 Boost .....	4-8
4.3.6	Network iControl .....	4-9
4.3.7	USB Charger+.....	4-10
4.3.8	USB BIOS Flashback Wizard .....	4-11
4.3.9	System Information .....	4-13
4.3.10	Audio configurations .....	4-15
<b>4.4</b>	<b>RAID configurations .....</b>	<b>4-16</b>
4.4.1	RAID definitions .....	4-16
4.4.2	Installing Serial ATA hard disks .....	4-17
4.4.3	Setting the RAID item in BIOS .....	4-17
4.4.4	AMD® Option ROM Utility .....	4-18
<b>4.5</b>	<b>Creating a RAID driver disk.....</b>	<b>4-21</b>
4.5.1	Creating a RAID driver disk without entering the OS....	4-21
4.5.2	Creating a RAID driver disk in Windows®.....	4-21
4.5.3	Installing the RAID driver during Windows® installation	4-22
<b>Chapter 5: Multiple GPU technology support</b>		
<b>5.1</b>	<b>AMD® CrossFireX™ technology .....</b>	<b>5-1</b>
5.1.1	Requirements.....	5-1
5.1.2	Before you begin.....	5-1
5.1.3	Installing two CrossFireX™ graphics cards .....	5-2
5.1.4	Installing the device drivers.....	5-3
5.1.5	Enabling the AMD® CrossFireX™ technology.....	5-3
<b>5.2</b>	<b>AMD® Dual Graphics technology .....</b>	<b>5-5</b>
5.2.1	System requirements .....	5-5
5.2.2	Before you proceed.....	5-5
5.2.3	Installing AMD Graphics Driver .....	5-5
5.2.4	Using the AMD® VISION Engine Control Center.....	5-6
<b>Appendices</b>		
<b>Notices.....</b>		<b>A-1</b>

# Safety information

## Electrical safety

- To prevent electrical shock hazard, disconnect the power cable from the electrical outlet before relocating the system.
- When adding or removing devices to or from the system, ensure that the power cables for the devices are unplugged before the signal cables are connected. If possible, disconnect all power cables from the existing system before you add a device.
- Before connecting or removing signal cables from the motherboard, ensure that all power cables are unplugged.
- Seek professional assistance before using an adapter or extension cord. These devices could interrupt the grounding circuit.
- Ensure that your power supply is set to the correct voltage in your area. If you are not sure about the voltage of the electrical outlet you are using, contact your local power company.
- If the power supply is broken, do not try to fix it by yourself. Contact a qualified service technician or your retailer.

## Operation safety

- Before installing the motherboard and adding devices on it, carefully read all the manuals that came with the package.
- Before using the product, ensure all cables are correctly connected and the power cables are not damaged. If you detect any damage, contact your dealer immediately.
- To avoid short circuits, keep paper clips, screws, and staples away from connectors, slots, sockets and circuitry.
- Avoid dust, humidity, and temperature extremes. Do not place the product in any area where it may become wet.
- Place the product on a stable surface.
- If you encounter technical problems with the product, contact a qualified service technician or your retailer.

# About this guide

This user guide contains the information you need when installing and configuring the motherboard.

## How this guide is organized

This guide contains the following parts:

- **Chapter 1: Product introduction**  
This chapter describes the features of the motherboard and the new technology it supports.
- **Chapter 2: Hardware information**  
This chapter lists the hardware setup procedures that you have to perform when installing system components. It includes description of the switches, jumpers, and connectors on the motherboard.
- **Chapter 3: BIOS setup**  
This chapter tells how to change system settings through the BIOS Setup menus. Detailed descriptions of the BIOS parameters are also provided.
- **Chapter 4: Software support**  
This chapter describes the contents of the support DVD that comes with the motherboard package and the software.
- **Chapter 5: AMD® CrossFireX™ technology support**  
This chapter describes how to install and configure multiple AMD® CrossFireX™ and AMD® Dual Graphics cards.

## Where to find more information

Refer to the following sources for additional information and for product and software updates.

1. **ASUS websites**  
The ASUS website provides updated information on ASUS hardware and software products. Refer to the ASUS contact information.
2. **Optional documentation**  
Your product package may include optional documentation, such as warranty flyers, that may have been added by your dealer. These documents are not part of the standard package.

## Conventions used in this guide

To ensure that you perform certain tasks properly, take note of the following symbols used throughout this manual.



**DANGER/WARNING:** Information to prevent injury to yourself when trying to complete a task.



**CAUTION:** Information to prevent damage to the components when trying to complete a task.



**IMPORTANT:** Instructions that you **MUST** follow to complete a task.



**NOTE:** Tips and additional information to help you complete a task.

## Typography

### **Bold text**

Indicates a menu or an item to select.

### *Italics*

Used to emphasize a word or a phrase.

### <Key>

Keys enclosed in the less-than and greater-than sign means that you must press the enclosed key.

Example: <Enter> means that you must press the Enter or Return key.

### <Key1> + <Key2> + <Key3>

If you must press two or more keys simultaneously, the key names are linked with a plus sign (+).

Example: <Ctrl> + <Alt> + <Del>



## A88X-PRO specifications summary

<b>APU</b>	<p>AMD® FM2+ socket for AMD® A-series/ Athlon™ Series processors          Supports CPU up to 4 CPU cores          AMD® Turbo Core Technology 3.0 support</p> <ul style="list-style-type: none"> <li>* The AMD® Turbo Core Technology 3.0 support depends on the APU types.</li> <li>** Refer to <a href="http://www.asus.com">www.asus.com</a> for the AMD® CPU support list.</li> </ul>
<b>Chipset</b>	AMD® A88X FCH (Bolton-D4)
<b>Memory</b>	<p>Dual-channel memory architecture          4 x 240-pin DIMM slots support maximum 64GB unbuffered non-ECC DDR3 2400(O.C.) / 2250(O.C.) / 2200(O.C.) / 2133 / 1866 / 1600 / 1333MHz memory modules          Supports AMD® Memory Profile (AMP) Memory</p> <ul style="list-style-type: none"> <li>* When you install a total memory of 4GB or more, Windows® 32-bit operating system may only recognize less than 3GB. We recommend a maximum of 3GB system memory if you are using a Windows® 32-bit operating system.</li> <li>** The 64GB maximum memory capacity can be supported with 16GB DIMMs or above. ASUS will update the Memory QVL (Qualified Vendors List) once the DIMMs are available on the market.</li> <li>***Hyper DIMM support is subject to the physical characteristics of individual CPUs.</li> <li>****Refer to <a href="http://www.asus.com">www.asus.com</a> for the latest Memory QVL (Qualified Vendors List).</li> </ul>
<b>Graphics</b>	<p>Integrated AMD Radeon™ R/HD8000/HD7000 Series Graphics in A-series APU          Multi-VGA output support: DisplayPort, HDMI, DVI, RGB ports</p> <ul style="list-style-type: none"> <li>- Supports DisplayPort with max. resolution 4096x2160@60Hz</li> <li>- Supports HDMI with max. resolution 4096x2160@24Hz/1920x1200@60Hz**</li> <li>- Supports Dual-link DVI with max. resolution 2560x1600@60Hz</li> <li>- Supports D-Sub with max. resolution 1920x1600@60GHz</li> <li>- Maximum shared memory of 2GB</li> <li>- Supports AMD® Dual Graphics technology</li> </ul> <ul style="list-style-type: none"> <li>* Refer to <a href="http://www.amd.com">www.amd.com</a> for discrete GPUs supporting Dual Graphics technology</li> <li>** Only FM2+ APU can support up to 4096x2160 resolution display via HDMI port.</li> </ul>
<b>Expansion slots</b>	<p>2 x PCIe 3.0†/2.0 x16 slots (single@x16 or dual@x8/x8 mode)          1 x PCIe 2.0 x16 slot (dark brown, max @x4 mode)          2 x PCIe 2.0 x1 slots          2 x PCI slots</p> <ul style="list-style-type: none"> <li>* Only FM2+ processors can support PCIe 3.0</li> </ul>
<b>Multi-GPU support</b>	Supports AMD® 3-Way CrossFireX™ Technology

(continued on the next page)

## A88X-PRO specifications summary

<b>Storage / RAID</b>	<b>AMD® A88X FCH:</b> <ul style="list-style-type: none"> <li>- 6 x Serial ATA 6.0Gb/s connectors support RAID 0, RAID 1, RAID 5, RAID 10 and JBOD configurations</li> <li>- 2 x eSerial ATA 6.0Gb/s at the rear I/O</li> </ul>
<b>LAN</b>	Realtek® 8111GR Gigabit LAN controller
<b>Audio</b>	ALC1150 supports 8-channel High Definition Audio <ul style="list-style-type: none"> <li>- Optical S/PDIF Out port at the rear I/O</li> <li>- Supports Jack-detection, Multi-streaming and Front Panel Jack-Retasking</li> </ul>
<b>USB</b>	<b>ASMedia® USB3.0 controller</b> <ul style="list-style-type: none"> <li>- 2 x USB 3.0/2.0 ports (blue, at the back panel)</li> </ul> <b>AMD® A88X FCH</b> <ul style="list-style-type: none"> <li>- 4 x USB 3.0/2.0 ports (2 ports at the back panel [blue], 2 ports at mid-board)</li> <li>- 10 x USB 2.0/1.1 ports (2 ports at the back panel, 8 ports at mid-board)</li> </ul>
<b>ASUS unique features</b>	<b>ASUS Dual Intelligent Processors 4 with 4-Way Optimization</b> <ul style="list-style-type: none"> <li>- The tuning key perfectly consolidates ASUS-exclusive DIGI+ Power Control, TPU, EPU, and Fan Xpert2 to optimize digital power settings, system performance, power savings and whole system cooling.</li> </ul> <b>ASUS Digital Power Design</b> <ul style="list-style-type: none"> <li>- Industry leading digital 6+2 phase power design</li> <li>- ASUS CPU power utility</li> <li>- ASUS DRAM power utility</li> </ul> <b>ASUS EPU</b> <ul style="list-style-type: none"> <li>- EPU, EPU switch</li> </ul> <b>ASUS TPU</b> <ul style="list-style-type: none"> <li>- GPU Boost, TPU switch</li> </ul> <b>ASUS Fan Xpert2</b> <ul style="list-style-type: none"> <li>- Featuring Fan Auto Tuning for optimized speed control and a customized fan speed setting for each fan</li> </ul> <b>ASUS 5X Protection</b> <ul style="list-style-type: none"> <li>- ASUS motherboards safeguard your PC with 5X Protection: DIGI+VRM, DRAM Fuse, ESD Guards, High-Quality Solid Capacitors and Stainless Steel Back I/O to ensure the best quality, reliability and durability.</li> </ul> <b>ASUS DRAM Fuse</b> <ul style="list-style-type: none"> <li>- Enhanced DRAM Overcurrent Protection and short circuit damage prevention.</li> </ul> <b>ASUS ESD Guards</b> <ul style="list-style-type: none"> <li>- Strong ESD Protection for extended component lifespan.</li> </ul> <b>ASUS High-Quality 5K Solid Capacitors</b> <ul style="list-style-type: none"> <li>- 2.5x long lifespan with excellent durability.</li> </ul> <b>ASUS Stainless Steel Back I/O</b> <ul style="list-style-type: none"> <li>- 3x more durable corrosion-resistant coating.</li> </ul>

(continued on the next page)

## A88X-PRO specifications summary

<b>ASUS unique features</b>	<b>ASUS Exclusive Features</b> <ul style="list-style-type: none"><li>- ASUS USB 3.0 Boost</li><li>- ASUS Remote GO!</li><li>- ASUS Network iControl*</li><li>- ASUS USB Charger+*</li><li>- ASUS AI Charger+</li><li>- ASUS Disk Unlocker</li><li>- ASUS MemOK!</li><li>- ASUS AI Suite 3</li><li>- ASUS Anti Surge</li></ul> <b>ASUS Quiet Thermal Solution</b> <ul style="list-style-type: none"><li>- ASUS Fanless Design: Stylish Heatpipe &amp; MOS Heatsink Solution</li><li>- ASUS Fan Xpert2</li></ul> <b>ASUS EZ DIY</b> <ul style="list-style-type: none"><li>- ASUS DirectKey</li><li>- ASUS Precision Tweaker 2</li><li>- ASUS USB BIOS Flashback with USB BIOS Flashback Wizard for EZ BIOS download scheduling</li><li>- ASUS UEFI BIOS EZ Mode featuring a friendly graphical user interface</li><li>- ASUS CrashFree BIOS 3</li><li>- ASUS EZ Flash 2</li><li>- ASUS MyLogo 2</li></ul> <b>ASUS Q-Design</b> <ul style="list-style-type: none"><li>- ASUS Q-Slot, Q-Shield, Q-Connector, Q-Code</li></ul> * Network iControl and USB Charger+ are only supported in Windows® 7 and later versions.
<b>ASUS exclusive overclocking features</b>	<b>Precision Tweaker 2</b> <ul style="list-style-type: none"><li>- vCore: Adjustable CPU voltage at 0.00625V increment</li><li>- vDDNB: Adjustable CPU/NB voltage at 0.00625V increment</li><li>- vDRAM Bus: Adjustable DRAM voltage at 0.005V increment</li><li>- vFCH: Adjustable FCH voltage at 0.01V increment</li></ul> <b>SFS (Stepless Frequency Selection):</b> <ul style="list-style-type: none"><li>- APU frequency tuning from 90MHz to 300MHz at 1MHz increment</li></ul> <b>Overclocking Protection:</b> <ul style="list-style-type: none"><li>- ASUS C.P.R (CPU Parameter Recall)</li></ul>
<b>Back panel I/O ports</b>	1 x PS/2 keyboard / mouse combo port 1 x DisplayPort 1 x HDMI port 1 x DVI port 1 x D-Sub port 1 x Optical S/PDIF output port 1 x LAN (RJ-45) port 2 x eSATA 6Gb/s ports 2 x USB 2.0/1.1 ports 4 x USB 3.0/2.0 ports (blue, 1 supports USB BIOS Flashback) 5 Audio jacks (Line In, Front Speaker Out, Mic in, Center/Subwoofer, Rear Speaker Out)

*(continued on the next page)*

## A88X-PRO specifications summary

<b>Internal connectors / switches / buttons</b>	<p>1 x 19-pin USB 3.0/2.0 connector supports additional 2 USB 3.0/2.0 ports</p> <p>4 x USB 2.0/1.1 connectors support additional 8 USB 2.0/1.1 ports</p> <p>6 x SATA 6.0Gb/s connectors</p> <p>1 x S/PDIF out header</p> <p>1 x Front panel audio connector</p> <p>1 x COM connector</p> <p>1 x EPU switch</p> <p>1 x TPU switch (embedded with GPU switch)</p> <p>1 x USB BIOS Flashback button</p> <p>1 x MemOK! button</p> <p>1 x DirectKey button</p> <p>1 x DRCT header</p> <p>1 x System panel connector (20-pin)</p> <p>1 x CPU fan connector (4-pin)</p> <p>4 x Chassis fan connectors (4-pin)</p> <p>1 x 24-pin EATX power connector</p> <p>1 x 8-pin ATX 12V power connector</p>
<b>BIOS features</b>	<p>64Mb Flash ROM, UEFI AMI BIOS, PnP, DMI v2.7, WfM 2.0, ACPI 5.0, SM BIOS 2.7, Multi-language BIOS, ASUS EZ Flash 2, ASUS CrashFree BIOS 3, My Favorites, Quick Note, Last Modified log, F12 PrintScreen Function, F3 Shortcut Function and ASUS DRAM SPD (Serial Presence Detect) Memory information</p>
<b>Support DVD contents</b>	<p>Drivers</p> <p>ASUS Update</p> <p>ASUS utilities</p> <p>Anti-Virus software (OEM version)</p>
<b>Accessories</b>	<p>4 x Serial ATA 6.0Gb/s cables</p> <p>1 x Q-connector (retail version only)</p> <p>1 x Q-Shield</p> <p>1 x User Manual</p> <p>1 x Support DVD</p>
<b>Operating System</b>	<p>Windows® 8.1 / 8.1 64-bit</p> <p>Windows® 8 / 8 64-bit</p> <p>Windows® 7 / 7 64-bit</p> <p>Windows® XP 32-bit</p>
<b>Form factor</b>	<p>ATX form factor: 12.0 in x 9.6 in (30.5 cm x 24.4 cm)</p>

\*Specifications are subject to change without notice.

# Chapter 1

## 1.1 Welcome!



Thank you for buying an ASUS® A88X-PRO motherboard!

The motherboard delivers a host of new features and latest technologies, making it another standout in the long line of ASUS quality motherboards!

Before you start installing the motherboard, and hardware devices on it, check the items in your package with the list below.

## 1.2 Package contents

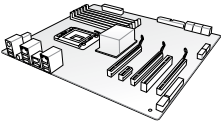
Check your motherboard package for the following items.

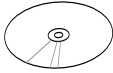
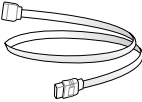
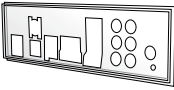
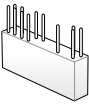
		
<b>ASUS A88X-PRO motherboard</b>	<b>User guide</b>	<b>Support DVD</b>
		
<b>4 x Serial ATA 6.0 Gb/s cables</b>	<b>1 x ASUS Q-Shield</b>	
		
<b>1 x 2-in-1 ASUS Q-Connector kit</b>		



- If any of the above items is damaged or missing, contact your retailer.
- The illustrated items above are for reference only. Actual product specifications may vary with different models.

## 1.3 Special features

### 1.3.1 Product highlights

#### **AMD® A-series accelerated processors with AMD® Radeon™ R/HD8000/HD7000 Series graphics**

This motherboard supports AMD® A-series accelerated processor with AMD® Radeon™ R/HD8000/HD7000 Series graphics. This revolutionary APU (Accelerated Processing Unit) combines processing power, energy-efficient design to enable accelerated performance and an industry-leading visual experience. It features Dual-channel DDR3 memory support and accelerates data transfer rate up to 5GT/s.

#### **AMD® A88X FCH (Bolton-D4) chipset**

AMD® A88X FCH (Bolton-D4) is designed to support up to 5GT/s interface speed and AMD® CrossFireX™ multi-GPU technology. It also supports 8 x SATA 6Gb/s ports and 4 x USB 3.0 ports.

#### **USB 3.0 support**

Experience ultra-fast data transfer at 4.8Gbps with USB 3.0 – the latest connectivity standard. Built to connect easily with next-generation components and peripherals, USB 3.0 transfers data 10x faster and is also backward compatible with USB 2.0 components.

#### **PCI Express® 3.0**

PCI Express® 3.0 (PCIe 3.0) is the latest PCI Express bus standard with improved encoding schemes that provide twice the performance of the current PCIe 2.0. The total bandwidth for a x16 link reaches a maximum of 32Gb/s, double the 16 Gb/s of PCIe 2.0 (in x16 mode). As such, PCIe 3.0 provides users unprecedented data speeds, combined with the convenience and seamless transition offered by complete backward compatibility with PCIe 1.0 and PCIe 2.0 devices. PCIe 3.0 will become a must-have feature for users who wish to improve and optimize graphic performance, as well as have the latest technology available to them.

\* Only FM2+ processors can support PCIe3.0.

#### **Native SATA 6.0 Gb/s support**

The AMD® A88X FCH natively supports the new Serial ATA (SATA) storage interface, this motherboard delivers up to 6.0 Gb/s data transfer rates. Additionally, get enhanced scalability, faster data retrieval, double the bandwidth of current bus systems.

#### **100% All Japan-made High-quality Conductive Polymer Capacitors**

This motherboard uses all high-quality conductive polymer capacitors for durability, improved lifespan, and enhanced thermal capacity.

## 1.3.2 5X Protection

### 5X PROTECTION

ASUS motherboards guard your PC with 5X PROTECTION. We use quality components like ESD units tested to strict standards that eliminate electrostatic interference, polyswitches (resettable fuses) around DRAM slots to prevent overcurrent and short-circuit damage, and a corrosion-resistant back I/O shield. All examples of ASUS providing the best possible reliability and durability.

#### DIGI+ VRM

##### Precise power control and long-lasting stability

Voltage regulator modules (VRMs) are among the most essential motherboard components. A good VRM intelligently delivers CPU power based on actual needs at any given time. Quickly-changing digital signal (SVID) requests from the CPU may prove too much for generic VRMs, and ASUS was first with digital controllers featuring faster sensing and response to deliver precise CPU power on demand. This great accuracy reduces energy waste and of course improves system stability thanks to more consistent delivery.

#### ASUS DRAM Fuse

##### Enhanced DRAM overcurrent protection and short circuit damage prevention

Onboard polyswitch (resettable fuse) prevents overcurrent and short-circuit damage. This extends beyond I/O ports to DRAM to safeguard system and device lifespan.

#### ASUS ESD Guards

##### Strong ESD protection for extended component lifespan

Electrostatic discharges (ESD) can happen suddenly, and their damaging effects are often underestimated. ASUS ESD Guards offer an active protective circuit design that ensures electrostatic discharges are properly grounded, providing prolonged component longevity.

#### ASUS High-Quality 5K Solid Capacitors

##### 2.5X longer lifespan with excellent durability

ASUS high-quality solid state capacitors assure a 5,000-hour lifespan – equivalent to 2.5 times longer than traditional capacitors. All capacitors pass testing under temperatures as high as 105 degrees and meet Japanese industrial standards to provide excellent durability and enhanced thermal capacity.

#### ASUS Stainless Steel Back I/O

##### 3X more durable corrosion-resistant coating

ASUS motherboard back I/O panels are made from strong and corrosion-resistant stainless steel, which is bonded with a thin layer of chromium oxide to enhance anti-corrosive properties. Passing 72-hour spray salt endurance tests, ASUS stainless steel back I/O panels have a usage life three times longer compared to ordinary panels.

### 1.3.3 ASUS Exclusive Features

#### USB 3.0 Boost

##### Faster USB 3.0 Transmission with UASP

New ASUS USB 3.0 Boost technology supports UASP (USB Attached SCSI Protocol), the latest USB 3.0 standard. With USB 3.0 Boost technology, a USB device's transmission speed is significantly increased up to 170%, adding to an already impressive fast USB 3.0 transfer speed. ASUS software automatically accelerates data speeds for compatible USB 3.0 peripherals without the need for any user interaction.

#### Network iControl\*

##### Real-time Network Bandwidth Control

With a single-click on/off button, the application currently in use has its data and network bandwidth prioritized over other programs. Moreover, you can prioritize your favorite software easily by configuring profiles through the intuitive user interface. Within the profile, the programs can be pre-scheduled to run in a specific time period to avoid network congestion and long-waits on downloads. Auto PPPoE network connection provides a one-step setup. Overall, it's an intuitive network bandwidth control center.

\*Network iControl is only supported in Windows® 7 and later versions.

#### MemOK!

##### Any Memory is A-OK!

MemOK! quickly ensures memory boot compatibility. This remarkable memory rescue tool requires a mere push of a button to patch memory issues. MemOK! determines fail-safe settings and dramatically improves your system boot success. Get your system up and running in no time!

#### USB Charger+\*

##### 3X Faster Charging for All Smart Devices

With a dedicated onboard controller, quick-charge all your smart devices such as iProducts, smartphones, tablets, and more, all up to 3x faster, even when the PC is powered off, in sleep, or hibernation mode.

\*USB Charger+ is only supported in Windows® 7 and later versions.

#### AI Suite 3

##### One-stop Access to Innovative ASUS Features

With its user-friendly interface, ASUS AI Suite 3 consolidates all the exclusive ASUS features into one simple to use software package. It allows you to supervise overclocking, energy management, fan speed control, voltage and sensor readings. This all-in-one software offers diverse and ease to use functions, with no need to switch back and forth between different utilities.

#### ASUS Anti-Surge Protection

This special design protects expensive devices and the motherboard from damage caused by power surges from switching power supply unit (PSU).



## ESD

Protect your computer with ESD Guards. Electrostatic discharge (ESD) conditions can happen while plugging or unplugging any USB peripherals-causing damage to the computer. ASUS ESD Guards clamp the ESD voltage and shunt the majority of the ESD current away for a more reliable computing environment.

### 1.3.4 ASUS Quiet Thermal Solutions

ASUS Quiet Thermal solution makes system more stable and enhances the overclocking capability.

#### Fan Xpert 2

ASUS Fan Xpert 2 provides customizable settings for a cooler and quieter computing environment. With its Fan Auto Tuning feature, ASUS Fan Xpert 2 automatically detects and tweaks all fan speeds, and provides you with optimized fan settings based on the fans' specifications and positions.

#### Fanless Design: stylish heatpipe solution

The stylish heatpipe features a 0-dB thermal solution that offers users a noiseless PC environment. Not only the beautiful shape upgrades the visual enjoyment for motherboard users, but also the heatpipe design lowers the temperature of the chipset and power phase area through high efficient heat-exchange. Combined with usability and aesthetics, the ASUS stylish heatpipe will give users an extremely silent and cooling experience with the elegant appearance!

### 1.3.5 ASUS EZ DIY

#### ASUS UEFI BIOS (EZ Mode)

ASUS UEFI BIOS, a UEFI compliant architecture, offers the first mouse-controlled intuitive graphical BIOS interface that goes beyond the traditional keyboard-only BIOS controls, providing you with more flexibility, convenience, and easy to navigate UEFI BIOS than the traditional BIOS versions. It offers you with dual selectable modes and native support for hard drives larger than 2.2 TB.

ASUS UEFI BIOS includes the following new features:

- New My Favorite function allows you to quickly access the frequently used items
- New Quick Note function allows you to take notes in the BIOS environment
- New log reminder allows you to view all your modified settings
- F12 BIOS snapshot hotkey
- F3 Shortcut for most accessed information
- ASUS DRAM SPD (Serial Presence Detect) information detecting faulty DIMMs, and helping with difficult POST situations.

## **USB BIOS Flashback**

### **Easy, Worry-free USB BIOS Flashback**

A truly revolutionary hardware-based BIOS update solution. USB BIOS Flashback offers the most convenient way to update the BIOS! It allows users to update new UEFI BIOS versions even without hardware such as a CPU or a DRAM installed into the motherboard. Just plug in a USB flash drive containing the BIOS file, and press the BIOS Flashback button for 3 seconds with the power supply connected. The UEFI BIOS then automatically updates without requiring further interaction. With its new complementary Windows® application, users can regularly check for UEFI BIOS updates, and downloads the latest BIOS automatically. Hassle-free updating for the ultimate convenience!

### **ASUS DirectKey**

This feature allows your system to go to the BIOS Setup program with the press of a button. With DirectKey, you can enter the BIOS anytime without having to press the <Del> key during POST. It also allows you to turn on and turn off your system and conveniently enter the BIOS during bootup.

### **ASUS EZ-Flash 2**

ASUS EZ Flash 2 is a user-friendly utility that allows you to update the BIOS without using a bootable floppy disk or an OS-based utility.

### **ASUS MyLogo2™**

This feature allows you to convert your favorite photo into a 256-color boot logo for a more colorful and vivid image on your screen.

### **CrashFree BIOS 3**

#### **Simply restore corrupted BIOS data from USB flash disk**

The ASUS CrashFree BIOS 3 allows users to restore corrupted BIOS data from a USB flash disk containing the BIOS file. This utility saves users the cost and hassle of buying a replacement BIOS chip.

### **ASUS Q-Design**

ASUS Q-Design enhances your DIY experience. All of Q-Slot, Q-Shield and Q-Connector design speed up and simplify the DIY process!

#### **ASUS Q-Slot**

ASUS Q-Slot is designed to speed and simplify the DIY process to enhance your DIY experience.

#### **ASUS Q-Shield**

ASUS Q-Shield's special design makes it convenient and easy to install on your motherboard. With better electric conductivity, it ideally protects your motherboard against static electricity and shields it against Electronic Magnetic Interference (EMI).

## **ASUS Q-Code**

### **Detailed PC status display and diagnostics**

The Q-Code is designed to display POST status for precise troubleshooting. Users can refer to the table in the user guide to interpret provided Q-Code.

## **ASUS Q-Connector**

### **Make Connection Quick and Accurate!**

The ASUS Q-Connector allows you to connect or disconnect chassis front panel cables in one easy step with one complete module. This unique adapter eliminates the trouble of plugging in one cable at a time, making connection quick and accurate.

## **ErP ready**

The motherboard is European Union's Energy-related Products (ErP) ready, and ErP requires products to meet certain energy efficiency requirements in regards to energy consumptions. This is in line with ASUS vision of creating environment-friendly and energy-efficient products through product design and innovation to reduce carbon footprint of the product and thus mitigate environmental impacts.



# Chapter 2

## 2.1 Before you proceed

Take note of the following precautions before you install motherboard components or change any motherboard settings.



- 
- Unplug the power cord from the wall socket before touching any component.
  - Before handling components, use a grounded wrist strap or touch a safely grounded object or a metal object, such as the power supply case, to avoid damaging them due to static electricity.
  - Hold components by the edges to avoid touching the ICs on them.
  - Whenever you uninstall any component, place it on a grounded antistatic pad or in the bag that came with the component.
  - Before you install or remove any component, ensure that the ATX power supply is switched off or the power cord is detached from the power supply. Failure to do so may cause severe damage to the motherboard, peripherals, or components.
-

## 2.2 Motherboard overview

### 2.2.1 Motherboard layout

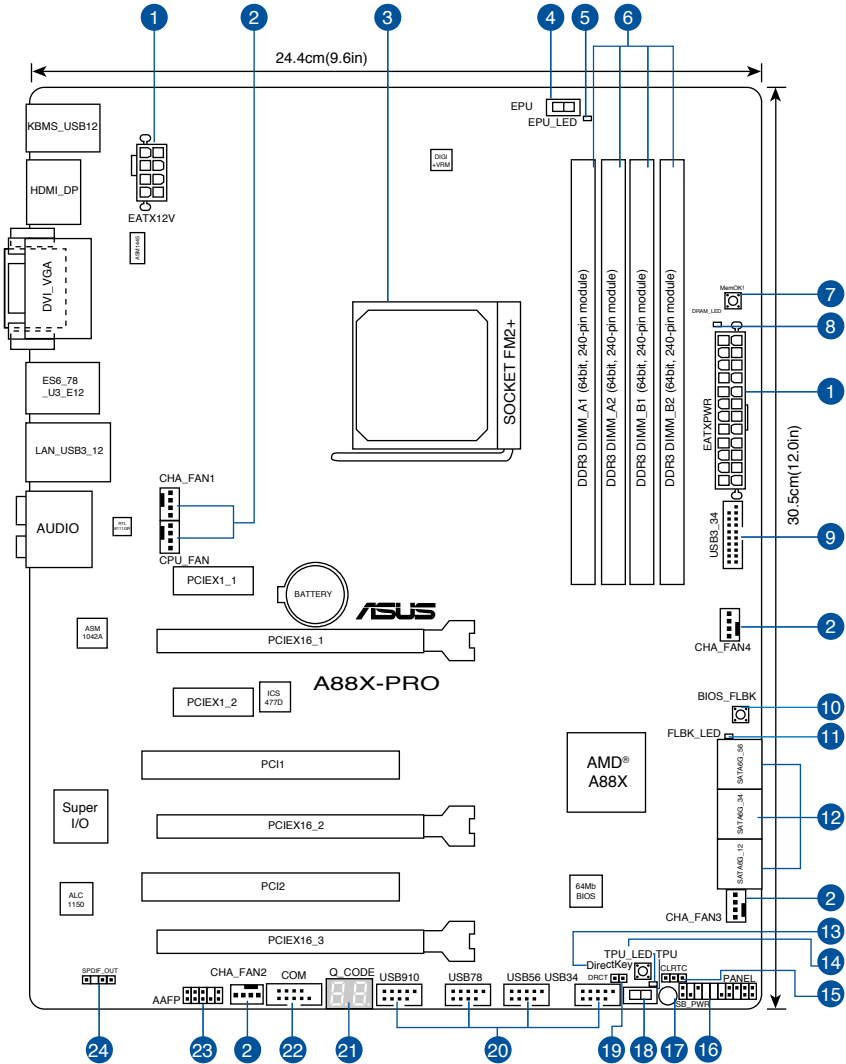

Refer to 2.2.8 Connectors and 2.3.10 Rear panel connection for more information about rear panel connectors and internal connectors.

## Layout contents

Connectors/Jumpers/Slots	Page
1. ATX power connectors (24-pin EATXPWR, 8-pin EATX12V)	2-31
2. CPU and chassis fan connectors (4-pin CPU_FAN, 4-pin CHA_FAN1/2/3/4)	2-29
3. AMD FM2+ Socket	2-4
4. EPU switch (EPU)	2-17
5. EPU LED (EPU_LED)	2-26
6. DDR3 DIMM slots	2-5
7. MemOK! switch	2-16
8. DRAM LED (DRAM_LED)	2-20
9. USB 3.0 connector (20-1 pin USB3_34)	2-30
10. BIOS Flashback button (BIOS_FLBK)	2-19
11. BIOS Flashback LED (FLBK_LED)	2-26
12. SATA 6.0 Gb/s connectors (SATA6G_1~6)	2-27
13. DirectKey button	2-18
14. TPU LED	2-26
15. Clear RTC RAM (3-pin CLRTC)	2-15
16. System panel connector (20-8 pin PANEL)	2-32
17. Standby power LED (SB_PWR)	2-20
18. TPU switch	2-17
19. Direct connector (2-pin DRCT)	2-31
20. USB 2.0 connectors (10-1 pin USB34, USB56, USB78, USB910)	2-28
21. Q_CODE	2-20
22. Serial port connector (10-1 pin COM)	2-30
23. Front panel audio connector (10-1 pin AAFP)	2-28
24. Digital audio connector (4-1 pin SPDIF_OUT)	2-29

## 2.2.2 Accelerated Processing Unit (APU)

This motherboard comes with an FM2+ socket designed for AMD™ A-Series and Athlon Series Accelerated processors.



Ensure that you use an APU designed for the FM2+ socket. The APU fits in only one correct orientation. DO NOT force the APU into the socket to prevent bending the pins and damaging the APU!

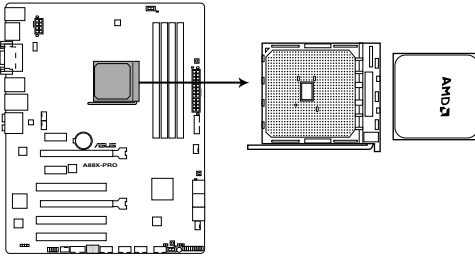

**A88X-PRO CPU socket FM2+**



## 2.2.3 System memory

The motherboard comes with four Double Data Rate 3 (DDR3) Dual Inline Memory Modules (DIMM) sockets.



A DDR3 module is notched differently from a DDR or DDR2 module. DO NOT install a DDR or DDR2 memory module to the DDR3 slot.

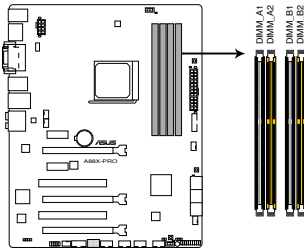

A88X-PRO 240-pin DDR3 DIMM sockets

### Recommended memory configurations

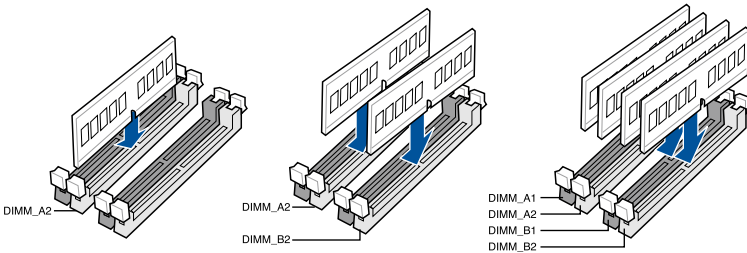

We recommend that you install the memory modules from the yellow slots for better overclocking capability.

## Memory configurations

You may install 1GB, 2GB, 4GB and 8GB unbuffered non-ECC DDR3 DIMMs into the DIMM sockets.



- 
- You may install varying memory sizes in Channel A and Channel B. The system maps the total size of the lower-sized channel for the dual-channel configuration. Any excess memory from the higher-sized channel is then mapped for single-channel operation.
  - We recommend that you install the memory modules from the yellow slots for better overclocking capability.
  - Always install DIMMs with the same CAS latency. For optimal compatibility, we recommend that you install memory modules of the same version or date code (D/C) from the same vendor. Check with the retailer to get the correct memory modules.
  - Due to the memory address limitation on 32-bit Windows OS, when you install 4GB or more memory on the motherboard, the actual usable memory for the OS can be about 3GB or less. For effective use of memory, we recommend that you do any of the following:
    - Use a maximum of 3GB system memory if you are using a 32-bit Windows OS.
    - Install a 64-bit Windows OS when you want to install 4GB or more on the motherboard. For more details, refer to the Microsoft® support site at <http://support.microsoft.com/kb/929605/en-us>.
  - This motherboard does not support DIMMs made up of 512Mb (64MB) chips or less (Memory chip capacity counts in Megabit, 8 Megabit/Mb = 1 Megabyte/MB).
- 



- 
- The default memory operation frequency is dependent on its Serial Presence Detect (SPD), which is the standard way of accessing information from a memory module. Under the default state, some memory modules for overclocking may operate at a lower frequency than the vendor-marked value. To operate at the vendor-marked or at a higher frequency, refer to section **3.4 Ai Tweaker menu** for manual memory frequency adjustment.
  - For system stability, use a more efficient memory cooling system to support a full memory load (4 DIMMs) or overclocking condition.
-

## A88X-PRO Motherboard Qualified Vendors Lists (QVL) DDR3 2400 (O.C.) MHz capability

Vendors	Part No.	Size	SS/ DS	Chip Brand	Chip NO.	Timing	Voltage	DIMM socket support (optional)		
								1DIMM	2DIMMs	4DIMMs
KINGMAX	FLLE88F-C8KAA HAIS (XMP)	2GB	SS	-	-	10-11-10-30	1.8V	.	.	.
G.SKILL	F3-2400C10D-8GTX(XMP)	8GB (2x4GB)	SS	-	-	10-12-12-31	1.65V	.	.	.
G.SKILL	F3-19200CL 10Q-32GBZHD (XMP)	8GB	DS	-	-	10-12-12-31	1.65V	.	.	.
CORSAIR	CMGTX8(XMP)	8GB (2GBx 4)	SS	-	-	10-12-10-27	1.65V	.	.	.
CORSAIR	CMD16GX3M2A2400C9 (Ver4.21)	8GB	DS	-	-	10-12-12-31	1.65V	.	.	.
CORSAIR	CMD32GX3M4A2400C10 (Ver5.29)	8GB	DS	-	-	10-12-12-31	1.65V	.	.	.
CORSAIR	CMY16GX3M2A2400C10R (Ver4.21)	8GB	DS	-	-	10-12-12-31	1.65V	.	.	.
GEIL	GET34GB2400C9DC (XMP)	2GB	DS	-	-	9-11-9-27	1.65V	.	.	.
KINGSTON	KHX24C11T2K2/8X (XMP)	4GB	DS	-	-	-	1.65V	.	.	.
ADATA	AX3U2400GW8G11	16GB (2x 8GB)	DS	-	-	11-13-13-35	1.65V	.	.	.

## DDR3 2250 (O.C.) MHz capability

Vendors	Part No.	Size	SS/ DS	Chip Brand	Chip NO.	Timing	Voltage	DIMM socket support (optional)		
								1DIMM	2DIMMs	4DIMMs
KINGSTON	KHX2250C9D3T1K2/4GX (XMP)	16GB (2x 8GB)	DS	-	-	11-13-13-35	1.65V	.	.	.

## DDR3 2200 (O.C.) MHz capability

Vendors	Part No.	Size	SS/ DS	Chip Brand	Chip NO.	Timing	Voltage	DIMM socket support (optional)		
								1DIMM	2DIMMs	4DIMMs
GEIL	GET34GB2200C9DC (XMP)	2GB	DS	-	-	9-10-9-28	1.65V	.	.	.
GEIL	GET38GB2200C9ADC (XMP)	4GB	DS	-	-	9-11-9-28	1.65V	.	.	.
KINGMAX	FLKE85F-B8KJAA-FEIS (XMP)	2GB	DS	-	-	-	-	.	.	.
KINGMAX	FLKE85F-B8KHA EEIH (XMP)	4GB (2x2GB)	DS	-	-	-	1.5V-1.7V	.	.	.
KINGMAX	FLKE85F-B8KJA FEIH (XMP)	4GB (2x2GB)	DS	-	-	-	1.5V-1.7V	.	.	.

(continued on the next page)

## DDR3 2133 MHz capability

Vendors	Part No.	Size	SS/DS	Chip Brand	Chip NO.	Timing	Voltage	DIMM socket support (optional)		
								1DIMM	2DIMMs	4DIMMs
A-DATA	AX3U2133GC2G9B-DG2 (XMP)	2GB	SS	-	-	9-11-9-27	1.55~1.75V	.	.	.
CORSAIR	CMT16GX3M4X2133C9 (XMP1.3)	16GB (4GBx4)	DS	-	-	9-11-10-27	1.50V	.	.	.
CORSAIR	CMT4GX3M2A2133C9 (XMP)	4GB (2x2GB)	DS	-	-	9-10-9-24	1.65V	.	.	.
CORSAIR	CMT4GX3M2B2133C9 (XMP)	4GB (2x2GB)	DS	-	-	9-10-9-27	1.50V	.	.	.
CORSAIR	CMT8GX3M2B2133C9 (XMP)	8GB (4GBx2)	DS	-	-	9-11-9-27	1.50V	.	.	.
G.SKILL	F3-17000CL9Q-16GBZH (XMP1.3)	16GB (4GBx4)	DS	-	-	9-11-10-28	1.65V	.	.	.
KINGSTON	KHX2133C11D3T1K2/16GX (XMP)	16GB (8GBx2)	DS	-	-	-	1.6V	.	.	.
KINGSTON	KHX2133C9AD3T1K2/4GX (XMP)	4GB (2x2GB)	DS	-	-	-	1.65V	.	.	.
KINGSTON	KHX2133C9AD3X2K2/4GX (XMP)	4GB (2x2GB)	DS	-	-	9-11-9-27	1.65V	.	.	.
KINGSTON	KHX2133C9AD3T1K4/8GX (XMP)	8GB (4x2GB)	DS	-	-	9-11-9-27	1.65V	.	.	.
KINGSTON	KHX2133C9AD3T1FK4/8GX (XMP)	8GB (4x2GB)	DS	-	-	-	1.65V	.	.	.
PATRIOT	PGD38G2133C11K (XMP)	16GB (4GBx4)	DS	-	-	11-11-11-30	1.65V	.	.	.
Team	TXD34096M2133HC9N-L	4GB	DS	SEC 128 HCH9	K4B2G0846D	9-11-11-28	1.65V	.	.	.
KINGSTON	KHX21C11T1BK2/16X (XMP)	16GB (8GBx2)	DS	-	-	-	1.6V	.	.	.
KINGSTON	KHX21C11T1BK2/8X (XMP)	8GB (4GBx2)	DS	-	-	-	1.6V	.	.	.
Team	TXD34096M2133HC9N-L	4GB	DS	SEC 128 HCH9	K4B2G0846D	9-11-11-28	1.65V	.	.	.
KINGSTON	KHX2133C11D3K4/16GX (XMP)	16GB (4GBx4)	DS	-	-	-	1.65V	.	.	.
ADATA	AX3U2133XC4G10-2X (XMP)	4GB	DS	-	-	10-11-11-30	1.65V	.	.	.
ADATA	AX3U2133XW8G10-2X (XMP)	8GB	DS	-	-	10-11-11-30	1.65V	.	.	.
ADATA	AX3U2133XW8G10	16GB (2x8GB)	DS	-	-	10-11-11-30	1.65V	.	.	.
Team	TLD38G2133HC11ABK	8GB	DS	-	-	11-11-11-31	1.65V	.	.	.
G.SKILL	F3-2133C11Q-32GZL (XMP)	8GB	DS	-	-	11-11-11-31	1.5V	.	.	.
KINGSTON	KHX21C11T3K4/32X	8GB	DS	-	-	-	1.65V	.	.	.

(continued on the next page)

## DDR3 2000 MHz capability

Vendor	Part No.	Size	SS/DS	Chip Brand	Chip NO.	Timing	Voltage	DIMM socket support (optional)		
								1DIMM	2DIMMs	4DIMMs
Apacer	78.AAGD5.9KD(XMP)	6GB(3 x 2GB)	DS	-	-	9-9-9-27	1.65V	.	.	.
CORSAIR	CMZ4GX3M2A2000C10(XMP)	4GB(2 x 2GB)	SS	-	-	10-10-10-27	1.50V	.	.	.
CORSAIR	CMT6GX3M3A2000C8(XMP)	6GB(3 x 2GB)	DS	-	-	8-9-8-24	1.65V	.	.	.
G.SKILL	F3-16000CL9D-4GBFLS(XMP)	4GB(2 x 2GB)	DS	-	-	9-9-9-24	1.65V	.	.	.
G.SKILL	F3-16000CL9D-4GBTD(XMP)	4GB(2 x 2GB)	DS	-	-	9-9-9-27	1.65V	.	.	.
G.SKILL	F3-16000CL6T-6GBPIS(XMP)	6GB (3x 2GB )	DS	-	-	6-9-6-24	1.65V	.	.	.
GEIL	GUP34GB2000C9DC(XMP)	4GB(2 x 2GB)	DS	-	-	9-9-9-28	1.65V	.	.	.
KINGSTON	KHX2000C9AD3T1K2/4GX(XMP)	4GB ( 2x 2GB )	DS	-	-	-	1.65V	.	.	.
KINGSTON	KHX2000C9AD3W1K2/4GX(XMP)	4GB ( 2x 2GB )	DS	-	-	-	1.65V	.	.	.
KINGSTON	KHX2000C9AD3T1K2/4GX(XMP)	4GB(2 x 2GB)	DS	-	-	9	1.65V	.	.	.
KINGSTON	KHX2000C9AD3W1K3/6GX(XMP)	6GB ( 3x 2GB )	DS	-	-	-	1.65V	.	.	.
KINGSTON	KHX2000C9AD3T1K3/6GX(XMP)	6GB (3x 2GB )	DS	-	-	-	1.65V	.	.	.

## DDR3 1866 MHz capability

Vendor	Part No.	Size	SS/DS	Chip Brand	Chip NO.	Timing	Voltage	DIMM socket support (optional)		
								1DIMM	2DIMMs	4DIMMs
CORSAIR	CMT4GX3M2A1866C9 (XMP)	4GB (2x2GB)	DS	-	-	9-9-9-24	1.65V	.	.	.
CORSAIR	CMT6GX3M1A1866C9 (XMP)	6GB (3x2GB)	DS	-	-	9-9-9-24	1.65V	.	.	.
CORSAIR	CMZ8GX3M2A1866C9 (XMP)	8GB (2x4GB)	DS	-	-	9-10-9-27	1.50V	.	.	.
G.SKILL	F3-14900CL9Q-16GBZL (XMP1.3)	16GB (4GBx4 )	DS	-	-	9-10-9-28	1.5V	.	.	.
G.SKILL	F3-14900CL10Q2-64GBZLD (XMP1.3)	64GB (8GBx8 )	DS	-	-	10-11-10-30	1.5V	.	.	.
G.SKILL	F3-14900CL9D-8GBXL (XMP)	8GB (2x4GB)	DS	-	-	9-10-9-28	1.5V	.	.	.
G.SKILL	F3-14900CL9Q-8GBXL (XMP)	8GB (2GBx4)	DS	-	-	9-9-9-24	1.6V	.	.	.
KINGSTON	KHX1866C9D3K4/16GX (XMP)	16GB (4GBx4 )	DS	-	-	-	1.65V	.	.	.
KINGSTON	KHX1866C9D3T1K3/6GX (XMP)	6GB (3x2GB)	DS	-	-	-	1.65V	.	.	.
KINGSTON	KHX1866C11D3P1K2/8G	8GB (4GBx2)	DS	-	-	-	1.5V	.	.	.
KINGSTON	KHX1866C9D3K2/8GX (XMP)	8GB (4GBX2)	DS	-	-	-	1.65V	.	.	.
CRUCIAL	BLE4G3D1869DE1TX0.16FMD (XMP)	4GB	DS	-	-	9-9-9-27	1.5V	.	.	.
CRUCIAL	BLT4G3D1869DT2TXOB.16FMR (XMP)	4GB	DS	-	-	9-9-9-27	1.5V	.	.	.
AMD	AP38G1869U2K	8GB (4GBX2)	DS	-	-	9-10-9-27	1.5V	.	.	.
ADATA	AX3U1866XW8G10	16GB (2x8GB )	DS	-	-	10-11-10-30	1.5V	.	.	.
PATRIOT	PV138G186C9KPD000326	4GB	DS	-	-	-	1.5V	.	.	.
Team	TLD34G1866H9KKB	4GB	DS	-	-	9-11-9-27	1.5V	.	.	.
Team	TLD38G1866HC10SBK	8GB	DS	-	-	10-11-10-30	1.5V	.	.	.
CRUCIAL	BLT4G3D1869DT1TX0.13FKD (XMP)	4GB	DS	-	-	9-9-9-27	1.5V	.	.	.
KINGSTON	KHX18C10T3K4/32X	8GB	DS	-	-	-	1.5V	.	.	.

(continued on the next page)

## DDR3 1600 MHz capability

Vendor	Part No.	Size	SS/DS	Chip Brand	Chip NO.	Timing	Voltage	DIMM socket support (optional)		
								1DIMM	2DIMMs	4DIMMs
A-DATA	AM2U16BC2P1	2GB	SS	A-DATA	3CCD-1509A EL1126T	-	-	.	.	.
A-DATA	AX3U1600XB2G79-2X (XMP)	4GB (2x2GB)	DS	-	-	7-9-7-21	1.55V-1.75V	.	.	.
A-DATA	AM2U16BC4P2	4GB	DS	A-DATA	3CCD-1509A EL1126T	-	-	.	.	.
A-DATA	AX3U1600GC4G9-2G (XMP)	8GB(2x4GB)	DS	-	-	9-9-9-24	1.55V-1.75V	.	.	.
A-DATA	AX3U1600XC4G79-2X (XMP)	8GB(2x4GB)	DS	-	-	7-9-7-21	1.55V-1.75V	.	.	.
CORSAIR	TR3X3G1600C8D (XMP)	3GB (3x1GB)	SS	-	-	8-8-8-24	1.65V	.	.	.
CORSAIR	CMD12GX3M6A1600C8 (XMP)	12GB (6x2GB)	DS	-	-	8-8-8-24	1.65V	.	.	.
CORSAIR	CMZ32GX3M4X1600C10 (XMP)	32GB (8GBx4)	DS	-	-	10-10-10-27	1.50V	.	.	.
CORSAIR	CMP4GX3M2A1600C8 (XMP)	4GB (2x2GB)	DS	-	-	8-8-8-24	1.65V	.	.	.
CORSAIR	CMP4GX3M2A1600C9 (XMP)	4GB (2x2GB)	DS	-	-	9-9-9-24	1.65V	.	.	.
CORSAIR	CMP4GX3M2C1600C7 (XMP)	4GB (2x2GB)	DS	-	-	7-8-7-20	1.65V	.	.	.
CORSAIR	CMX4GX3M2A1600C9 (XMP)	4GB (2x2GB)	DS	-	-	9-9-9-24	1.65V	.	.	.
CORSAIR	CMX4GX3M2A1600C9 (XMP)	4GB (2x2GB)	DS	-	-	9-9-9-24	1.65V	.	.	.
CORSAIR	TR3X6G1600C8 G (XMP)	6GB (3x2GB)	DS	-	-	8-8-8-24	1.65V	.	.	.
CORSAIR	TR3X6G1600C8D G (XMP)	6GB (3x2GB)	DS	-	-	8-8-8-24	1.65V	.	.	.
CORSAIR	TR3X6G1600C9 G (XMP)	6GB (3x2GB)	DS	-	-	9-9-9-24	1.65V	.	.	.
CORSAIR	CMP8GX3M2A1600C9 (XMP)	8GB (2x4GB)	DS	-	-	9-9-9-24	1.65V	.	.	.
CORSAIR	CMZ8GX3M2A1600C7R (XMP)	8GB (2x4GB)	DS	-	-	7-8-7-20	1.50V	.	.	.
CORSAIR	CMX8GX3M4A1600C9 (XMP)	8GB (4x2GB)	DS	-	-	9-9-9-24	1.65V	.	.	.
Crucial	BL25664BN1608.16FF (XMP)	6GB (3x2GB)	DS	-	-	-	-	.	.	.
G.SKILL	F3-12800CL9D-2GBNQ (XMP)	2GB (2x1GB)	SS	-	-	9-9-9-24	1.5V	.	.	.
G.SKILL	F3-12800CL7D-4GBRH (XMP)	4GB (2x2GB)	SS	-	-	7-7-7-24	1.6V	.	.	.
G.SKILL	F3-12800CL7D-4GBECO (XMP)	4GB (2x2GB)	DS	-	-	7-7-8-24	XMP 1.35V	.	.	.
G.SKILL	F3-12800CL7D-4GBRM (XMP)	4GB (2x2GB)	DS	-	-	7-8-7-24	1.6V	.	.	.
G.SKILL	F3-12800CL8D-4GBRM (XMP)	4GB (2x2GB)	DS	-	-	8-8-8-24	1.60V	.	.	.
G.SKILL	F3-12800CL9D-4GBECO (XMP)	4GB (2x2GB)	DS	-	-	9-9-9-24	XMP 1.35V	.	.	.
G.SKILL	F3-12800CL9D-4GBRL (XMP)	4GB (2x2GB)	DS	-	-	9-9-9-24	1.5V	.	.	.
G.SKILL	F3-12800CL9T-6GBNQ (XMP)	6GB (3x2GB)	DS	-	-	9-9-9-24	1.5V ~1.6V	.	.	.
G.SKILL	F3-12800CL7D-8GBRH (XMP)	8GB (2x4GB)	DS	-	-	7-8-7-24	1.6V	.	.	.
G.SKILL	F3-12800CL8D-8GBECO (XMP)	8GB (2x4GB)	DS	-	-	8-8-8-24	XMP 1.35V	.	.	.
G.SKILL	F3-12800CL9D-8GBRL (XMP)	8GB (2x4GB)	DS	-	-	9-9-9-24	1.5V	.	.	.
GEIL	GET316GB1600C9QC (XMP)	16GB (4x4GB)	DS	-	-	9-9-9-28	1.6V	.	.	.
GEIL	GV34GB1600C8DC(XMP)	2GB	DS	-	-	8-8-8-28	1.6V	.	.	.
HYNIX	HMT351U6CFR8C-PB	4GB	DS	HYNIX	H5TQ2G83CFR PBC	-	-	.	.	.
KINGMAX	FLGD45F-B8MF7 MAEH(XMP)	1GB	SS	-	-	7	-	.	.	.
KINGMAX	FLGE85F-B8KJ9A FEIS(XMP)	2GB	DS	-	-	-	-	.	.	.
KINGMAX	FLGE85F-B8MF7 MEEH(XMP)	2GB	DS	-	-	7	-	.	.	.

(continued on the next page)

## DDR3 1600 MHz capability

Vendor	Part No.	Size	SS/ DS	Chip brand	Chip NO.	Timing	Voltage	DIMM socket support		
								1DIMM	2DIMMs	4DIMM
KINGSTON	KHX1600C9D3P1K2/4G	4GB (2x2GB)	SS	-	-	-	1.5V	.	.	.
KINGSTON	KHX1600C9D3K3/12GX (XMP)	12GB (3x4GB)	DS	-	-	9-9-9-27	1.65V	.	.	.
KINGSTON	KHX1600C9D3T1BK3/12GX (XMP)	12GB (3x4GB)	DS	-	-	9-9-9-27	1.65V	.	.	.
KINGSTON	KHX1600C9D3K4/16GX (XMP)	16GB (4GBx4)	DS	-	-	-	1.65V	.	.	.
KINGSTON	KHX1600C9AD3/2G	2GB	DS	-	-	-	1.65V	.	.	.
KINGSTON	KVR1600D3N11/2G-ES	2GB	DS	KTC	D1288JPNDFLD9U	11-11-11-28	1.35V ~1.5V	.	.	.
KINGSTON	KHX1600C7D3K2/4GX (XMP)	4GB (2x2GB)	DS	-	-	-	1.65V	.	.	.
KINGSTON	KHX1600C8D3K2/4GX (XMP)	4GB (2x2GB)	DS	-	-	8	1.65V	.	.	.
KINGSTON	KHX1600C8D3T1K2/4GX (XMP)	4GB (2x2GB)	DS	-	-	8	1.65V	.	.	.
KINGSTON	KHX1600C9D3K2/4GX (XMP)	4GB (2x2GB)	DS	-	-	9	1.65V	.	.	.
KINGSTON	KHX1600C9D3LK2/4GX (XMP)	4GB (2x2GB)	DS	-	-	9	XMP 1.35V	.	.	.
KINGSTON	KHX1600C9D3X2K2/4GX (XMP)	4GB (2x2GB)	DS	-	-	9-9-9-27	1.65V	.	.	.
KINGSTON	KHX1600C9D3T1K3/6GX (XMP)	6GB (3x2GB)	DS	-	-	-	1.65V	.	.	.
KINGSTON	KHX1600C9D3K3/6GX (XMP)	6GB (3x2GB)	DS	-	-	9	1.65V	.	.	.
KINGSTON	KHX1600C9D3T1BK3/6GX (XMP)	6GB (3x2GB)	DS	-	-	9-9-9-27	1.65V	.	.	.
KINGSTON	KHX1600C9D3K2/8GX (XMP)	8GB (2x4GB)	DS	-	-	9-9-9-27	1.65V	.	.	.
KINGSTON	KHX1600C9D3P1K2/8G	8GB (2x4GB)	DS	-	-	-	1.5V	.	.	.
Super Talent	WA160UX6G9	6GB (3x2GB)	DS	-	-	9	-	.	.	.
Transcend	JM1600KLN-8GK	8GB (4GBx2)	DS	Transcend	TK483PCW3	-	-	.	.	.
SanMax	SMD-4G68HP-16KZ	4GB	DS	HYNIX	H5TQ2G83BFR PBC	-	-	.	.	.
AMD	AE32G1609U1-U	2GB	SS	-	23EY4587MB6H11503M	9-9-9-24	1.5V	.	.	.
AMD	AE34G1609U2-U	4GB	DS	AMD	23EY4587MB6H11503M	9-9-9-24	1.5V	.	.	.
ASint	SLZ302G08-EGN1C	2GB	SS	Asint	SLZ302G08-GN1C	-	-	.	.	.
Asint	SLZ3128M8-EGJ1D (XMP)	2GB	DS	Asint	3128M8-GJ1D	9-9-9-24	1.6V	.	.	.
Asint	SLA302G08-EGG1C (XMP)	4GB	DS	Asint	302G08-GG1C	-	-	.	.	.
Asint	SLA302G08-EGJ1C (XMP)	4GB	DS	Asint	302G08-GJ1C	-	-	.	.	.
ASint	SLA302G08-EGN1C	4GB	DS	Asint	SLA302G08-GN1C	-	-	.	.	.
ASint	SLB304G08-EGN1B	8GB	DS	Asint	SLB304G08-GN1B	-	-	.	.	.
Elixir	M2P2G64CB8HC9N-DG (XMP)	2GB	DS	-	-	-	-	.	.	.
Elixir	M2X8G64CB8HB5N-DG (XMP)	8GB	DS	Elixir1213	N2CB4G8BOBN-DG	-	-	.	.	.
Mushkin	998659 (XMP)	6GB (3x2GB)	DS	-	-	9-9-9-24	-	.	.	.
Mushkin	998659 (XMP)	6GB (3x2GB)	DS	-	-	9-9-9-24	1.5 ~1.6V	.	.	.
PATRIOT	PGD316G1600ELK (XMP)	32GB (8GBx4)	DS	-	-	9-9-9-24	1.65V	.	.	.
PATRIOT	PGS34G1600LLKA	4GB (2x2GB)	DS	-	-	7-7-7-20	1.7V	.	.	.

(continued on the next page)

## DDR3 1600 MHz capability

Vendor	Part No.	Size	SS/ DS	Chip Brand	Chip No.	Timing	Voltage	DIMM socket support (optional)		
								1DIMM	2DIMMs	4DIMMs
Silicon Power	SP002GBLTU160V02 (XMP)	2GB	SS	S-POWER	20YT5NG-1201	-	-	.	.	.
Silicon Power	SP004GBLTU160V02 (XMP)	4GB	DS	S-POWER	20YT5NG-1201	-	-	.	.	.
Apacer	78.B1GE3.9L10C	4GB	DS	Apacer KZCC	AM5D5908DEQSCK	-	-	.	.	.
KINGSTON	KHX16C9K2/16	16GB (8GBx2)	DS	-	-	-	1.5V	.	.	.
Elixir	M2X8G64CB8HB5N-DG (XMP)	8GB	DS	Elixir 1213	N2CB4G8BOBN-DG	-	-	.	.	.
APACER	8GB UNB PC3-12800 CL11	8GB	DS	APACER	AM5D6008BQQSCK	-	-	.	.	.
CORSAIR	CM28GX3M1A1600C10 (XMP)	8GB	DS	-	-	10-10 -10-27	1.50V	.	.	.
Transcend	8G DDR31600 DIMM CL11	8GB	DS	SEC 222 HYKO	6MD9639W	-	-	.	.	.
Transcend	8G DDR31600 DIMM CL11	8GB	DS	Transcend	E223X8BO648S	-	-	.	.	.
ADATA	AD3U1600C2G11-B	2GB	SS	-	N/A	-	-	.	.	.
ADATA	AD3U1600W4G11-B	4GB	SS	ADATA	F209X8BR6413	-	-	.	.	.
ADATA	AD3U1600C4G11-B	4GB	DS	-	N/A	-	-	.	.	.
ADATA	AD3U1600W8G11-B	8GB	DS	ADATA	F211X8B0640A	-	-	.	.	.
TEAM	TED34G1600HC11BK	4GB	DS	-	-	11-11 -11-28	-	.	.	.
TEAM	TLD34G1600HC9BK (XMP)	4GB	DS	-	-	9-9-24	1.5V	.	.	.
MICRON	MT8JTF51264AZ-1G6E1	4GB	SS	MICRON	D9QBJ	-	-	.	.	.
MICRON	MT16JTF1G64AZ-1G6E1	8GB	DS	MICRON	D9QBJ	-	-	.	.	.
Transcend	TS512MLK64W6H	4GB	SS	SEC 234 HYKO	K4B4G08468	-	-	.	.	.
Transcend	TS1GLK64W6H	8GB	DS	SEC 234 HYKO	K4B4G08468	-	-	.	.	.
ADATA	AX3U1600GW8G9	16GB (2x8GB)	DS	-	-	9-9-9-24	1.5V	.	.	.
ADATA	AXDU1600GW8G9B	16GB (2x8GB)	DS	-	-	11-11 -11-28	1.5V	.	.	.
Asint	SLA304G08-ENG1B	4GB	SS	Asint	304G08-GN1B1301	-	-	.	.	.
Asint	SLB304G08-EGJ1B	8GB	DS	-	-	-	-	.	.	.
PATRIOT	PV332G160C9QK	8GB	DS	-	-	-	1.5V	.	.	.
APACER	4GB UNB PC3-12800 CL11	4GB	SS	APACER	AM5D6008BQQSCK	-	-	.	.	.
G.SKILL	F3-12800CL10S-8GBXL (XMP)	8GB	DS	-	-	10-10 -10-30	-	.	.	.
KINGSTON	KVR16N11/4(Low Profile)	4GB	DS	KINGSTON	D2568GEROPGGBU	-	1.5V	.	.	.
KINGSTON	KHX16C10B1K2/16X (XMP)	8GB	DS	-	-	-	1.5V	.	.	.
KINGSTON	KHX16C9P1K2/16 (XMP)	8GB	DS	-	-	-	1.5V	.	.	.
PSC	AL9F8L93B-GN2E	4GB	SS	PSC	XHP284C3G-M	-	-	.	.	.
PSC	ALAF8L93B-GN2E	8GB	DS	PSC	XHR425C3G-M	-	-	.	.	.
Elixir	M2P2G64CB8HC9N-DG	2GB	DS	-	-	-	-	.	.	.

## DDR3 1333 MHz capability

Vendor	Part No.	Size	SS/ DS	Chip Brand	Chip No.	Timing	Voltage	DIMM socket support (optional)		
								1DIMM	2DIMMs	4DIMMs
A-DATA	AD31333001GOU	1GB	SS	A-Data	AD30908C8D-151C E0906	-	-	.	.	.
A-DATA	AD3U1333C2G9	2GB	SS	A-DATA	3CCD-1509HNA1126L	-	-	.	.	.
A-DATA	AM2U139C2P1	2GB	SS	ADATA	3CCD-1509A EL1127T	-	-	.	.	.
A-DATA	AX3U1333C2G9-BP	2GB	SS	-	-	-	-	.	.	.
A-DATA	AD31333G001GOU	3GB (3x1GB)	SS	-	-	8-8-8-24	1.65-1.85V	.	.	.

(continued on the next page)



## DDR3 1333 MHz capability

Vendor	Part No.	Size	SS/ DS	Chip Brand	Chip No.	Timing	Voltage	DIMM socket support (optional)		
								1DIMM	2DIMMs	4DIMMs
A-DATA	AXDU1333GC2G9-2G (XMP)	4GB (2x2GB)	SS	-	-	9-9-9-24	1.25V-1.35V (low voltage)	.	.	.
A-DATA	AD31333G002GMU	2GB	DS	-	-	8-8-8-24	1.6S-1.85V	.	.	.
A-DATA	AD8311C1624EV	4GB	DS	A-DATA	3CCA-1509A	-	-	.	.	.
A-DATA	AM2U139C4P2	4GB	DS	ADATA	3CCD-1509A EL1127T	-	-	.	.	.
A-DATA	SU3U1333W8G9-B	8GB	DS	ELPIDA	J4208BASE-DJ-F	-	-	.	.	.
Apacer	78.A1GC6.9L1	2GB	DS	Apacer	AM5D5808DEWSBG	-	-	.	.	.
Apacer	78.A1GC6.9L1	2GB	DS	Apacer	AM5D5808FEQSBG	9	-	.	.	.
Apacer	AU02GFA33C9NDBG	2GB	DS	Apacer	AM5D5808APQSBG	-	-	.	.	.
Apacer	78.B1GDE.9L10C	4GB	DS	Apacer	AM5D5908CEHSBG	-	-	.	.	.
Corsair	TR3X3G1333C9 G	3GB (3x1GB)	SS	-	-	9-9-9-24	1.50V	.	.	.
Corsair	TR3X6G1333C9 G	6GB (3x2GB)	SS	-	-	9-9-9-24	1.50V	.	.	.
Corsair	CMD24GX3M6A1333C9 (XMP)	24GB (6x4GB)	DS	-	-	9-9-9-24	1.60V	.	.	.
Corsair	TW3X4G1333C9D G	4GB (2x2GB)	DS	-	-	9-9-9-24	1.50V	.	.	.
Corsair	CM3X4GA1333C9N2	4GB	DS	Corsair	256MBDCJGEL0401136	9-9-9-24	-	.	.	.
Corsair	CMX4GX3M1A1333C9	4GB	DS	-	-	9-9-9-24	1.50V	.	.	.
Corsair	CMD8GX3M4A1333C7	8GB (4x2GB)	DS	-	-	7-7-7-20	1.60V	.	.	.
Crucial	CT12864BA1339.8FF	1GB	SS	Micron	9FF22D9KPT	9	-	.	.	.
Crucial	CT25664BA1339.16FF	2GB	DS	Micron	9KF27D9KPT	9	-	.	.	.
Crucial	BL25664BN1337.16FF (XMP)	6GB (3x2GB)	DS	-	-	7-7-7-24	1.65V	.	.	.
Elpida	EBJ10UE8EDF0-DJ-F	1GB	SS	ELPIDA	J1108EDSE-DJ-F	-	1.35V (low voltage)	.	.	.
Elpida	EBJ21UE8EDF0-DJ-F	2GB	DS	ELPIDA	J1108EDSE-DJ-F	-	1.35V (low voltage)	.	.	.
G-Skill	F3-10600CL8D-2GBHK (XMP)	1GB	SS	G.SKILL	-	-	-	.	.	.
G-Skill	F3-10600CL9D-2GBNQ	2GB (2x1GB)	SS	-	-	9-9-9-24	1.5V	.	.	.
G-Skill	F3-10666CL8D-4GBECO (XMP)	4GB (2x2GB)	DS	-	-	8-8-8-8-24	XMP 1.35V	.	.	.
G-Skill	F3-10666CL7D-8GBRH (XMP)	8GB (2x4GB)	DS	-	-	7-7-7-21	1.5V	.	.	.
GEIL	GV32GB1333C9DC	2GB (2x1GB)	DS	-	-	9-9-9-24	1.5V	.	.	.
GEIL	GG34GB1333C9DC	4GB (2x2GB)	DS	GEIL	GL1L128M88BA12N	9-9-9-24	1.3V (low voltage)	.	.	.
GEIL	GV34GB1333C9DC	4GB (2x2GB)	DS	-	-	9-9-9-24	1.5V	.	.	.
GEIL	GVP34GB1333C7DC	4GB (2x2GB)	DS	-	-	7-7-7-24	1.5V	.	.	.
Hynix	HMT112U6TFR8A-H9	1GB	SS	Hynix	H5TC1G83TFRH9A	-	1.35V (low voltage)	.	.	.
Hynix	HMT325U6BFR8C-H9	2GB	SS	Hynix	H5TQ2G83BFRH9C	-	-	.	.	.
Hynix	HMT125U6TFR8A-H9	2GB	DS	Hynix	H5TC1G83TFRH9A	-	1.35V (low voltage)	.	.	.
Hynix	HMT351U6BFR8C-H9	4GB	DS	Hynix	H5TQ2G83BFRH9C	-	-	.	.	.
Kingmax	FLFD45F-B8KL9 NAES	1GB	SS	Kingmax	KKB8FNWBFGNX-27A	-	-	.	.	.
Kingmax	FLFE85F-C8KF9 CAES	2GB	SS	Kingmax	KFC8FMFXF-DXX-15A	-	-	.	.	.
Kingmax	FLFE85F-C8KL9 NAES	2GB	SS	Kingmax	KFC8FNLXF-DXX-15A	-	-	.	.	.
Kingmax	FLFE85F-C8KM9 NAES	2GB	SS	Kingmax	KFC8FNMXF-BXX-15A	-	-	.	.	.
Kingmax	FLFE85F-B8KL9 NEES	2GB	DS	Kingmax	KKB8FNWBFGNX-26A	-	-	.	.	.
Kingmax	FLFF65F-C8KL9 NEES	4GB	DS	Kingmax	KFC8FNLXF-DXX-15A	-	-	.	.	.
Kingmax	FLFF65F-C8KM9 NEES	4GB	DS	Kingmax	KFC8FNMXF-BXX-15A	-	-	.	.	.

(continued on the next page)

## DDR3 1333 MHz capability

Vendor	Part No.	Size	SS/DS	Chip Brand	Chip NO.	Timing	Voltage	DIMM socket support (optional)		
								1DIMM	2DIMMs	4DIMMs
KINGSTON	KVR1333D3N9/1G (Low Profile)	1GB	SS	ELPIDA	J1108BDBG-DJ-F	9	1.5V	.	.	.
KINGSTON	KVR1333D3N9/2G (Low Profile)	2GB	SS	Hynix	H5T02G83AFRH9C	9	-	.	.	.
KINGSTON	KVR1333D3S8N9/2G	2GB	SS	Micron	IID77 D9LGK	-	1.5V	.	.	.
KINGSTON	KVR1333D3S8N9/2G-SP (Low Profile)	2GB	SS	ELPIDA	J2108BCSE-DJ-F	-	1.5V	.	.	.
KINGSTON	KVR1333D3N9/2G (Low Profile)	2GB	DS	ELPIDA	J1108BFBG-DJ-F	9	1.5V	.	.	.
KINGSTON	KVR1333D3N9/2G	2GB	DS	KTC	D1288JPNPLD9U	9	1.5V	.	.	.
KINGSTON	KVR1333D3N9/2G	2GB	DS	ELPIDA	J1108BDSE-DJ-F	9	1.5V	.	.	.
KINGSTON	KVR1333D3N9/2G-SP (Low Profile)	2GB	DS	KTC	D1288JEMFNGD9U	-	1.5V	.	.	.
KINGSTON	KVR1333D3N9/2G-SP (Low Profile)	2GB	DS	KINGSTON	D1288JPSFPGD9U	-	1.5V	.	.	.
KINGSTON	KHX1333C7D3K2/4GX (XMP)	4GB (2x2GB)	DS	-	-	7	1.65V	.	.	.
KINGSTON	KHX1333C9D3UK2/4GX (XMP)	4GB (2x2GB)	DS	-	-	9	XMP 1.25V	.	.	.
KINGSTON	KVR1333D3N9/4G (Low Profile)	4GB	DS	ELPIDA	J2108BCSE-DJ-F	9	1.5V	.	.	.
KINGSTON	KVR1333D3N9/4G (Low Profile)	4GB	DS	ELPIDA	J2108BCSE-DJ-F	-	1.5V	.	.	.
KINGSTON	KVR1333D3N9/4G	4GB	DS	KTC	D2568JENCNGD9U	-	1.5V	.	.	.
KINGSTON	KVR1333D3N9/4G	4GB	DS	Hynix	H5T02G83AFR	-	-	.	.	.
KINGSTON	KVR1333D3N9/4G-SP (Low Profile)	4GB	DS	KINGSTON	D2568JENCPGD9U	-	1.5V	.	.	.
Micron	MT4JTF12864AZ-1G4D1	1GB	SS	Micron	OJD12D9LGQ	-	-	.	.	.
Micron	MT8JTF12864AZ-1G4F1	1GB	SS	Micron	9FF22D9KPT	9	-	.	.	.
Micron	MT8JTF25664AZ-1G4D1	2GB	SS	Micron	OJD12D9LGK	-	-	.	.	.
Micron	MT8JTF25664AZ-1G4M1	2GB	SS	MICRON	IJM22 D9PFJ	-	-	.	.	.
Micron	MT16JTF25664AZ-1G4F1	2GB	DS	Micron	9KF27D9KPT	9	-	.	.	.
Micron	MT16JTF51264AZ-1G4D1	4GB	DS	Micron	OLD22D9LGK	-	-	.	.	.
NANYA	NT4GC64B8HG0NF-CG	4GB	DS	NANYA	NT5CB256M8GN-CG	-	-	.	.	.
PSC	AL7F8G73F-DJ2	1GB	SS	PSC	A3P1GF3FGF	-	-	.	.	.
PSC	AL8F8G73F-DJ2	2GB	DS	PSC	A3P1GF3FGF	-	-	.	.	.
SAMSUNG	M378B2873FHS-CH9	1GB	SS	SAMSUNG	K4B1G0846F	-	-	.	.	.
SAMSUNG	M378B5773DHO-CH9	2GB	SS	SAMSUNG	K4B2G0846D	-	-	.	.	.
SAMSUNG	M378B5673FH0-CH9	2GB	DS	SAMSUNG	K4B1G0846F	-	-	.	.	.
SAMSUNG	M378B5273CHO-CH9	4GB	DS	SAMSUNG	K4B2G0846C	-	-	.	.	.
Super Talent	W1333UA1GH	1GB	SS	Hynix	H5T01G83TFR	9	-	.	.	.
Super Talent	W1333UX2G8(XMP)	2GB (2x1GB)	SS	-	-	8	-	.	.	.
Super Talent	W1333UB2GS	2GB	DS	SAMSUNG	K4B1G0846F	9	-	.	.	.
Super Talent	W1333UB4GS	4GB	DS	SAMSUNG	K4B2G0846C	-	-	.	.	.
Super Talent	W1333UX6GM	6GB (3x2GB)	DS	Micron	0BF27D9KPT	9-9-9-24	1.5V	.	.	.
Transcend	JM1333KLN-2G	2GB	SS	Hynix	H5T02G83BZRH9C	-	-	.	.	.
Transcend	TS256MLK64V3U	2GB	DS	Micron	9GF27D9KPT	-	-	.	.	.
Transcend	TS1GLK64V3H	8GB	DS	Micron	IVD22D9PBC	-	-	.	.	.
KINGSTEK	KSTD3PC-10600	2GB	SS	MICRON	PE911-125E	-	-	.	.	.
AMD	AE32G1339U1-U	2GB	SS	AMD	23EY4587MB3H11503M	9-9-9-24	1.5V	.	.	.
AMD	AE34G1339U2-U	4GB	DS	AMD	23EY4587MB3H11503M	9-9-9-24	1.5V	.	.	.
ASint	SLZ302G08-EDJ1C	2GB	SS	Asint	SLZ302G08-DJ1C	-	-	.	.	.
ASint	SLA302G08-EDJ1C	4GB	DS	Asint	SLA302G08-DJ1C	-	-	.	.	.
ASint	SLB304G08-EDJ1B	8GB	DS	Asint	SLB304G08-DJ1B	-	-	.	.	.

(continued on the next page)

## DDR3 1333 MHz capability

Vendor	Part No.	Size	SS/DS	Chip Brand	Chip NO.	Timing	Voltage	DIMM socket support (optional)		
								1DIMM	2DIMM	4DIMMs
Elixir	M2F2G64CB88B7N-CG	2GB	SS	Elixir	N2CB2G80BN-CG	-	-	.	.	.
Elixir	M2F2G64CB88D7N-CG	2GB	SS	Elixir	N2CB2G80DN-CG	-	-	.	.	.
Elixir	M2F2G64CB88G7N-CG	2GB	SS	Elixir	N2CB2G80GN-CG	-	-	.	.	.
Elixir	M2F4G64CB88B5N-CG	4GB	DS	Elixir	N2CB2G80BN-CG	-	-	.	.	.
Elixir	M2F4G64CB88D5N-CG	4GB	DS	Elixir	N2CB2G80DN-CG	-	-	.	.	.
Kingshare	KSRPCD313332G	2GB	DS	PATRIOT	PM128M8D385-15	-	-	.	.	.
Kingtiger	2GB DIMM PC3-10666	2GB	DS	SAMSUNG	S E C 9 0 4 H C H 9 K4B1G0846D	-	-	.	.	.
Kingtiger	KTG2G1333PG3	2GB	DS	-	-	-	-	.	.	.
Markvision	BMD32048M1333C9-1123	2GB	DS	Markvision	M3D1288P-13	-	-	.	.	.
Markvision	BMD34096M1333C9-1124	4GB	DS	Markvision	M3D2568E-13	-	-	.	.	.
PATRIOT	PSD32G13332H	2GB	DS	-	-	-	-	.	.	.
PATRIOT	PG38G1333EL(XMP)	8GB	DS	-	-	9-9-9-24	1.5V	.	.	.
RAMAXEL	RMR1870ED48E8F-1333	2GB	DS	ELPIDA	J1108BDBG-DJ-F	-	-	.	.	.
RAMAXEL	RMR1870EC58E9F-1333	4GB	DS	ELPIDA	J2108BCSE-DJ-F	-	-	.	.	.
RiDATA	C304627CB1AG22Fe	2GB	DS	RiDATA	N/A	9	-	.	.	.
RiDATA	E304459CB1AG32Cf	4GB	DS	RiDATA	N/A	9	-	.	.	.
Silicon Power	SP002GBLTU133V02	2GB	SS	S-POWER	20YT3NG-1202	-	-	.	.	.
Silicon Power	SP002GBLTU133S02	2GB	DS	Elixir	N2CB1680AN-C6	-	-	.	.	.
Silicon Power	SP004GBLTU133V02	4GB	DS	S-POWER	20YT3NG-1201	-	-	.	.	.
TAKEMS	TMS2GB364D081-107EY	2GB	DS	-	-	7-7-7-20	1.5V	.	.	.
TAKEMS	TMS2GB364D082-138EW	2GB	DS	-	-	8-8-8-24	1.5V	.	.	.
UMAX	E41302GP0-73BDB	2GB	DS	UMAX	U2S24D30TP-13	-	-	.	.	.
WINTEC	3WVS31333-2G-CNR	2GB	DS	AMPO	AM3420803-13H	-	-	.	.	.
Transcend	8G DDR3 1333 DIMM CL9	8GB	DS	Transcend	E207X8B0643Y	-	-	.	.	.
Transcend	8G DDR3 1333 DIMM CL9	8GB	DS	-	N/A	-	-	.	.	.
HMD	HMD D302GU648S1B9C-MEX	2GB	SS	ERTH	256X8DDR3 WT	-	1.5V	.	.	.
HMD	HMD D304GU648S1B9C-MEX	4GB	SS	UUJK	512X8DDR3 WT	-	1.5V	.	.	.
HMD	HMD D308GU648D1B9C-MEX	8GB	DS	FFCT	512X8DDR3 WT	-	1.5V	.	.	.
TEAM	TED34G1333HC9BK	4GB	DS	-	-	9-9-9-24	-	.	.	.
TEAM	TED38G1333HC9BK	8GB	DS	-	-	9-9-9-24	1.5V	.	.	.
Asint	SLA304G08-EDJ1B	4GB	SS	Asint	304G08-DJ1B1301	-	-	.	.	.

(continued on the next page)



---

**Side(s): SS - Single-sided DS - Double-sided**

**DIMM support:**

- **1 DIMM:** Supports one (1) module inserted into any slot as Single-channel memory configuration. **We suggest that you install the module into A2 slot.**
- **2 DIMMs:** Supports two (2) modules inserted into either the yellow slots or the dark brown slots as one pair of Dual-channel memory configuration. **We suggest that you install the modules into slots A2 and B2 for better compatibility.**
- **4 DIMMs:** Supports four (4) modules inserted into both the yellow and dark brown slots as two pairs of Dual-channel memory configuration.



---

Visit the ASUS website for the latest QVL.

---

## 2.2.4 Expansion slots



Ensure to unplug the power cord before adding or removing expansion cards. Failure to do so may cause you physical injury and damage motherboard components.

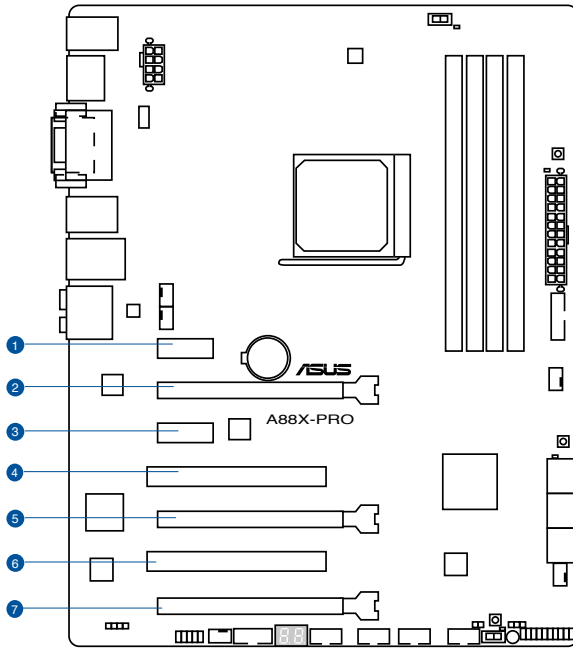

Slot No.	Slot Description
1	PCIe 2.0 x1_1 slot [yellow]
2	PCIe 3.0/2.0 x16_1 slot [yellow] (single at x16 or dual at x8/x8 mode)
3	PCIe 2.0 x1_2 slot [yellow]
4	PCI slot 1
5	PCIe 3.0/2.0 x16_2 slot [dark brown] (at x8 mode)
6	PCI slot 2
7	PCIe 2.0 x16_3 slot [dark brown] (at x4 mode, compatible with PCIe x1 and x4 devices)

VGA configuration	PCI Express operating mode	
	PCIe 2.0 x16_1	PCIe 2.0 x16_2
Single VGA/PCIe card	x16 (Recommend for single VGA)	N/A
Dual VGA/PCIe card	x8	x8



- In single VGA card mode, use the PCIe 2.0 x16\_1 slot (yellow) for a PCI Express x16 graphics card to get better performance.
- In CrossFireX™ mode, use the PCIe 2.0 x16\_1 and PCIe 2.0 x16\_2 slots for PCI Express x16 graphics cards to get better performance.
- We recommend that you provide sufficient power when running CrossFireX™ mode.
- Connect a chassis fan to the motherboard connector labeled CHA\_FAN1/2/3/4 when using multiple graphics cards for better thermal environment.

## IRQ assignments for this motherboard

	A	B	C	D	E	F	G	H
PCIe x16_1	-	-	shared	-	-	-	-	-
PCIe x16_2	-	-	-	shared	-	-	-	-
PCIe x16_3	shared	-	-	-	-	-	-	-
PCIe x1_1	shared	-	-	-	-	-	-	-
PCIe x1_2	-	-	-	shared	-	-	-	-
PCI_1	-	-	-	-	shared	-	-	-
PCI_2	-	-	-	-	-	shared	-	-
LAN	-	-	shared	-	-	-	-	-
ASMedia USB 3.0 controller	-	shared	-	-	-	-	-	-
AMD FCH USB3.0 Controller_1	-	-	shared	-	-	-	-	-
AMD FCH USB3.0 Controller_2	-	shared	-	-	-	-	-	-
AMD FCH SATA Controller	-	-	-	shared	-	-	-	-
HD Audio	shared	-	-	-	-	-	-	-
Onboard VGA Controller	-	shared	-	-	-	-	-	-

## 2.2.5 Jumper

### Clear RTC RAM (3-pin CLRTC)

This jumper allows you to clear the Real Time Clock (RTC) RAM in CMOS. You can clear the CMOS memory of date, time, and system setup parameters by erasing the CMOS RTC RAM data. The onboard button cell battery powers the RAM data in CMOS, which include system setup information such as system passwords.

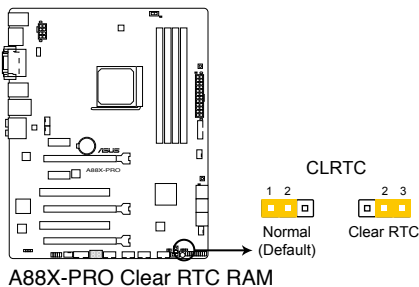

To erase the RTC RAM

1. Turn OFF the computer and unplug the power cord.
2. Move the jumper cap from pins 1-2 (default) to pins 2-3. Keep the cap on pins 2-3 for about 5–10 seconds, then move the cap back to pins 1-2.
3. Plug the power cord and turn ON the computer.
4. Hold down the <Del> key during the boot process and enter BIOS setup to re-enter data.



Except when clearing the RTC RAM, never remove the cap on CLRTC jumper default position. Removing the cap will cause system boot failure!



- If the steps above do not help, remove the onboard battery and move the jumper again to clear the CMOS RTC RAM data. After clearing the CMOS, reinstall the battery.
- You do not need to clear the RTC when the system hangs due to overclocking. For system failure due to overclocking, use the C.P.R. (CPU Parameter Recall) feature. Shut down and reboot the system so the BIOS can automatically reset parameter settings to default values.

## 2.2.6 Onboard switches/buttons

Onboard switches allow you to fine-tune performance when working on a bare or open-case system. This is ideal for overclockers and gamers who continually change settings to enhance system performance.

### 1. MemOK! button

Installing DIMMs that are incompatible with the motherboard may cause system boot failure, and the DRAM\_LED near the MemOK! switch lights continuously. Press and hold the MemOK! switch until the DRAM\_LED starts blinking to begin automatic memory compatibility tuning for successful boot.

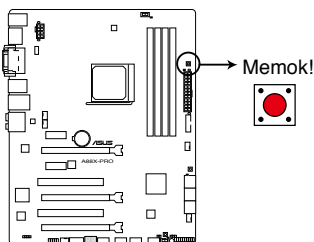

A88X-PRO MemOK! button



- Refer to section **2.2.7 Onboard LEDs** for the exact location of the DRAM\_LED.
- The DRAM\_LED also lights when the DIMM is not properly installed. Turn off the system and reinstall the DIMM before using the MemOK! function.
- The MemOK! switch does not function under a Windows® OS environment.
- During the tuning process, the system loads and tests failsafe memory settings. It takes about 30 seconds for the system to test one set of failsafe settings. If the test fails, the system reboots and tests the next set of failsafe settings. The blinking speed of the DRAM\_LED increases, indicating different test processes.
- Due to memory tuning requirement, the system automatically reboots when each timing set is tested. If the installed DIMMs still fail to boot after the whole tuning process, the DRAM\_LED lights continuously. Replace the DIMMs with ones recommended in the Memory QVL (Qualified Vendors Lists) in this user manual or on the ASUS website at [www.asus.com](http://www.asus.com).
- If you turn off the computer and replace DIMMs during the tuning process, the system continues memory tuning after turning on the computer. To stop memory tuning, turn off the computer and unplug the power cord for about 5–10 seconds.
- If your system fails to boot due to BIOS overclocking, press the MemOK! switch to boot and load BIOS default settings. A message will appear during POST reminding you that the BIOS has been restored to its default settings.
- We recommend that you download and update to the latest BIOS version from the ASUS website at [www.asus.com](http://www.asus.com) after using the MemOK! function.



## 2. TPU (GPU Boost) switch

Turning this switch to Enable will automatically optimize the system for fast, yet stable clock speeds.

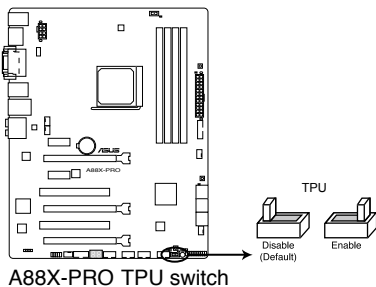

- To ensure system performance, turn the switch setting to **Enable** when the system is powered off.
- When the TPU switch is set to **Enable**, it can be used as a GPU Boost switch.



- The TPU LED near the TPU switch lights when the switch setting is turned to **Enable**. Refer to section 2.2.7 **Onboard LEDs** for the exact location of the TPU LED.
- If you change the switch setting to **Enable** under the OS environment, the TPU function will be activated after the next system bootstrap.
- You may use the TurboV and Auto Tuning feature in the TurboV EVO application, adjust the BIOS setup program, or enable the TPU switch at the same time. However, the system will use the last setting you have made.

## 3. EPU switch

This switch allows you to enable or disable the EPU function.

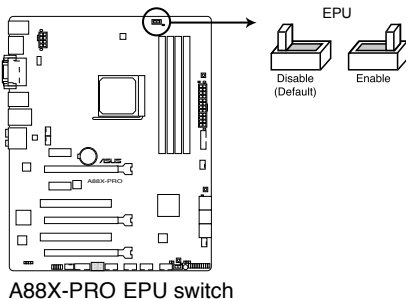

- To ensure system performance, turn the switch setting to **Enable** when the system is powered off.



- 
- The EPU LED near the TPU switch lights when the switch setting is turned to **Enable**.
  - If you change the switch setting to **Enable** under the OS environment, the EPU function will be activated after the next system bootup.
  - You may change the EPU settings in the EPU application, change the BIOS settings, and enable the EPU function at the same time. However, the system will use the last setting you have made.
- 

#### 4. DirectKey button

This feature allows your system to go to the BIOS Setup program with the press of a button. With DirectKey, you can enter the BIOS anytime without having to press the <Del> key during POST. It also allows you to turn on and turn off your system and conveniently enter the BIOS during bootup.

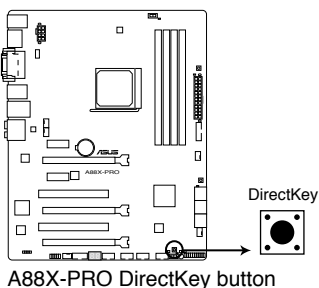

---

Ensure to save your data before using the DirectKey button.

---



- When the system is on and you press the DirectKey button, your system will shut down. Press the DirectKey button again or the Power-on button to reboot and enter the BIOS directly.
  - Turn off your system using the power-on button to allow your system to go through POST (without entering the BIOS) when you reboot your system.
  - Refer to Chapter 3.7 **Boot Menu** for details about setting the DirectKey default function.
-

## 5. BIOS-FLBK button

The BIOS Flashback button offers the most convenient way to update the BIOS. It allows overclockers to update new BIOS versions without having to enter their existing BIOS or operating system. Just plug in a USB storage and press the BIOS Flashback button for 3 seconds, and the BIOS is automatically flashed using standby power. Hassle-free updating for the ultimate convenience!

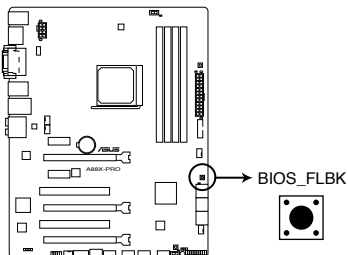

A88X-PRO BIOS FLBK button

1. Download the BIOS file from the ASUS service website ([www.asus.com](http://www.asus.com)), rename the BIOS file into **A88XPRO.CAP** and save it in the root directory of a removable device.
2. Plug the USB flash drive into the bottom port of the LAN\_USB3\_12 connector in the back I/O.
3. Press the USB BIOS Flashback button for 3 seconds, and the light will begin to flash (on the third second).
4. The Flashback function is enabled once the light starts to flash.
5. The flashing rate of the light signal accelerates along with the updating speed.
6. BIOS update is complete once the light signal goes out.

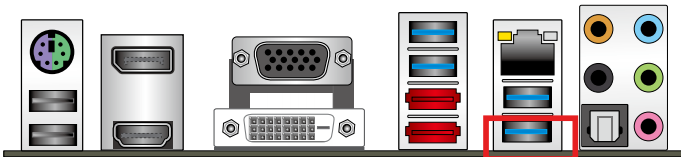

- Do not unplug the portable disk, power off the system or press the CLR\_CMOS button while BIOS update is ongoing, otherwise update will be interrupted. In case of interruption, please follow the recommended procedures again to complete BIOS update.
- If the light flashes for five seconds and turns into a stable light, this means that the USB BIOS Flashback is not operating properly. This may be caused by:
  1. Improper installation of the portable disk.
  2. Error in file name or incompatibility in file format. If this is the case, please restart the system to turn off the light.
- Updating BIOS may have risks. If the BIOS program is damaged during the process causing the system unable to reboot, please contact the local service station for help.

## 2.2.7 Onboard LEDs

### 1. Standby Power LED

The motherboard comes with a standby power LED. The green LED lights up to indicate that the system is ON, in sleep mode, or in soft-off mode. This is a reminder that you should shut down the system and unplug the power cable before removing or plugging in any motherboard component. The illustration below shows the location of the onboard LED.

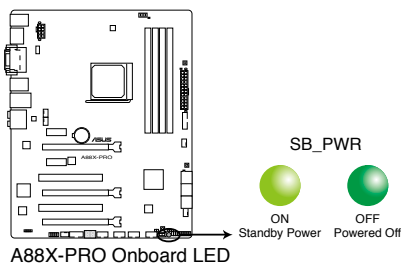

### 2. DRAM LED

DRAM LED checks the DRAM in sequence during motherboard booting process. If an error is found, the LED next to the error device will continue lighting until the problem is solved. This user-friendly design provides an intuitive way to locate the root problem within a second.

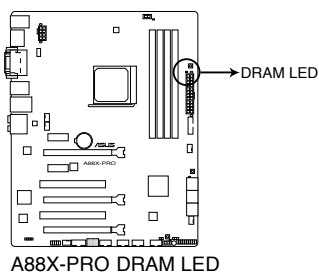

### 3. Q-Code LED

The Q-Code LED provides you with a 2-digit error code that displays the system status. Refer to the Q-Code table on the next page for details.

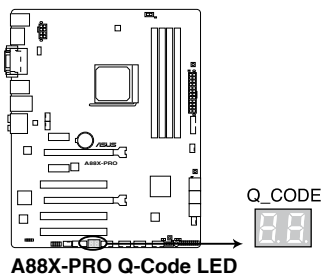

## Q-Code table

Code	Description
00	Not used
01	Power on. Reset type detection (soft/hard).
02	AP initialization before microcode loading
03	System Agent initialization before microcode loading
04	PCH initialization before microcode loading
06	Microcode loading
07	AP initialization after microcode loading
08	System Agent initialization after microcode loading
09	PCH initialization after microcode loading
0B	Cache initialization
0C – 0D	Reserved for future AMI SEC error codes
0E	Microcode not found
0F	Microcode not loaded
10	PEI Core is started
11 – 14	Pre-memory CPU initialization is started
15 – 18	Pre-memory System Agent initialization is started
19 – 1C	Pre-memory PCH initialization is started
2B – 2F	Memory initialization
30	Reserved for ASL (see ASL Status Codes section below)
31	Memory Installed
32 – 36	CPU post-memory initialization
37 – 3A	Post-Memory System Agent initialization is started
3B – 3E	Post-Memory PCH initialization is started
4F	DXE IPL is started
50 – 53	Memory initialization error. Invalid memory type or incompatible memory speed
54	Unspecified memory initialization error
55	Memory not installed
56	Invalid CPU type or Speed
57	CPU mismatch
58	CPU self test failed or possible CPU cache error
59	CPU micro-code is not found or micro-code update is failed

*(continued on the next page)*

Code	Description
5A	Internal CPU error
5B	Reset PPI is not available
5C – 5F	Reserved for future AMI error codes
E0	S3 Resume is started (S3 Resume PPI is called by the DXE IPL)
E1	S3 Boot Script execution
E2	Video repost
E3	OS S3 wake vector call
E4 – E7	Reserved for future AMI progress codes
E8	S3 Resume Failed
E9	S3 Resume PPI not Found
EA	S3 Resume Boot Script Error
EB	S3 OS Wake Error
EC – EF	Reserved for future AMI error codes
F0	Recovery condition triggered by firmware (Auto recovery)
F1	Recovery condition triggered by user (Forced recovery)
F2	Recovery process started
F3	Recovery firmware image is found
F4	Recovery firmware image is loaded
F5 – F7	Reserved for future AMI progress codes
F8	Recovery PPI is not available
F9	Recovery capsule is not found
FA	Invalid recovery capsule
FB – FF	Reserved for future AMI error codes
60	DXE Core is started
61	NVRAM initialization
62	Installation of the PCH Runtime Services
63 – 67	CPU DXE initialization is started
68	PCI host bridge initialization
69	System Agent DXE initialization is started
6A	System Agent DXE SMM initialization is started
6B – 6F	System Agent DXE initialization (System Agent module specific)

*(continued on the next page)*

Code	Description
70	PCH DXE initialization is started
71	PCH DXE SMM initialization is started
72	PCH devices initialization
73 – 77	PCH DXE Initialization (PCH module specific)
78	ACPI module initialization
79	CSM initialization
7A – 7F	Reserved for future AMI DXE codes
90	Boot Device Selection (BDS) phase is started
91	Driver connecting is started
92	PCI Bus initialization is started
93	PCI Bus Hot Plug Controller Initialization
94	PCI Bus Enumeration
95	PCI Bus Request Resources
96	PCI Bus Assign Resources
97	Console Output devices connect
98	Console input devices connect
99	Super IO Initialization
9A	USB initialization is started
9B	USB Reset
9C	USB Detect
9D	USB Enable
9E – 9F	Reserved for future AMI codes
A0	IDE initialization is started
A1	IDE Reset
A2	IDE Detect
A3	IDE Enable
A4	SCSI initialization is started
A5	SCSI Reset
A6	SCSI Detect
A7	SCSI Enable
A8	Setup Verifying Password

*(continued on the next page)*

Code	Description
A9	Start of Setup
AA	Reserved for ASL (see ASL Status Codes section below)
AB	Setup Input Wait
AC	Reserved for ASL (see ASL Status Codes section below)
AD	Ready To Boot event
AE	Legacy Boot event
AF	Exit Boot Services event
B0	Runtime Set Virtual Address MAP Begin
B1	Runtime Set Virtual Address MAP End
B2	Legacy Option ROM Initialization
B3	System Reset
B4	USB hot plug
B5	PCI bus hot plug
B6	Clean-up of NVRAM
B7	Configuration Reset (reset of NVRAM settings)
B8–BF	Reserved for future AMI codes
D0	CPU initialization error
D1	System Agent initialization error
D2	PCH initialization error
D3	Some of the Architectural Protocols are not available
D4	PCI resource allocation error. Out of Resources
D5	No Space for Legacy Option ROM
D6	No Console Output Devices are found
D7	No Console Input Devices are found
D8	Invalid password
D9	Error loading Boot Option (LoadImage returned error)
DA	Boot Option is failed (StartImage returned error)
DB	Flash update is failed
DC	Reset protocol is not available



## ACPI/ASL Checkpoints

Code	Description
01	System is entering S1 sleep state
02	System is entering S2 sleep state
03	System is entering S3 sleep state
04	System is entering S4 sleep state
05	System is entering S5 sleep state
10	System is waking up from the S1 sleep state
20	System is waking up from the S2 sleep state
30	System is waking up from the S3 sleep state
40	System is waking up from the S4 sleep state
AC	System has transitioned into ACPI mode. Interrupt controller is in PIC mode.
AA	System has transitioned into ACPI mode. Interrupt controller is in APIC mode.

#### 4. BIOS\_FLBK LED

The BIOS\_FLBK LED lights up when the BIOS-FLBK function is enabled.

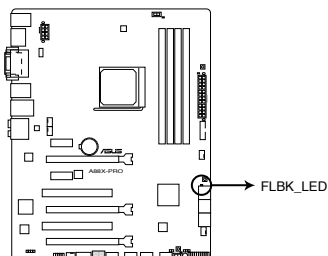

A88X-PRO FLBK LED

#### 5. EPU LED

The EPU LED lights up when the EPU switch is turned to **Enable**.

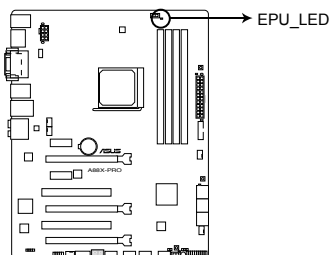

A88X-PRO EPU LED

#### 6. TPU LED

The TPU LED lights up when the TPU switch is turned to **Enable**.

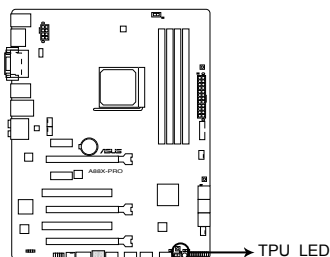

A88X-PRO TPU LED

## 2.2.8 Internal connectors

### 1. Serial ATA 6.0 Gb/s connectors (7-pin SATA6G\_1~6)

These connectors connect to Serial ATA 6.0 Gb/s hard disk drives via Serial ATA 6.0 Gb/s signal cables.

If you installed Serial ATA hard disk drives, you can create a RAID 0, 1, 5, and 10 configuration through the onboard AMD® A88X chipset.

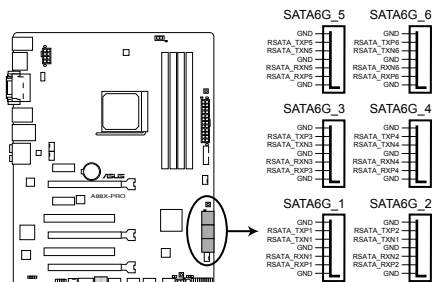

A88X-PRO SATA 6.0Gb/s connectors

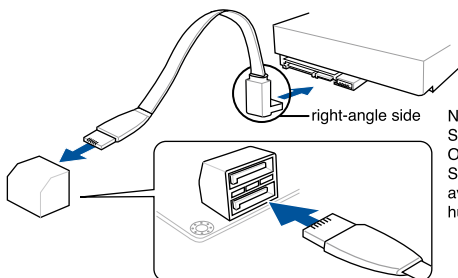

NOTE: Connect the right-angle side of SATA signal cable to SATA device. Or you may connect the right-angle side of SATA cable to the onboard SATA port to avoid mechanical conflict with huge graphics cards.



- These connectors are set to [AHCI] by default. If you intend to create a Serial ATA RAID set using these connectors, set the **OnChip SATA Type** item in the BIOS to [RAID]. Refer to section **3.5.2 SATA Configuration** for details.
- Before creating a RAID set, refer to section **4.4 RAID configurations** or the manual bundled in the motherboard support DVD.
- When using NCQ, set the **OnChip SATA Type** in the BIOS to [AHCI]. Refer to section **3.5.2 SATA Configuration** for details.
- You must install Windows® XP Service Pack 3 or later versions before using Serial ATA hard disk drives. The Serial ATA RAID feature is available only if you are using Windows® XP SP3 or later versions.

## 2. USB 2.0 connectors (10-1 pin USB910, USB78, USB56, USB34)

These connectors are for USB 2.0 ports. Connect the USB module cable to any of these connectors, then install the module to a slot opening at the back of the system chassis. These USB connectors comply with USB 2.0 specification that supports up to 480 Mbps connection speed.

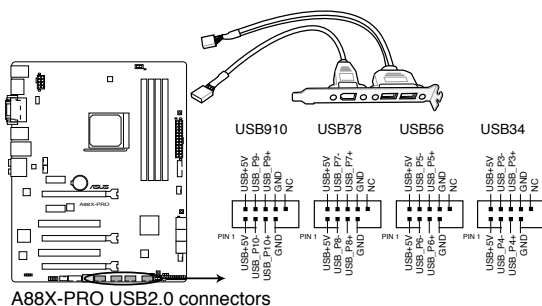

Never connect a 1394 cable to the USB connectors. Doing so will damage the motherboard!



The USB module cable is purchased separately.

## 3. Front panel audio connector (10-1 pin AAFF)

This connector is for a chassis-mounted front panel audio I/O module that supports either HD Audio or legacy AC'97 audio standard. Connect one end of the front panel audio I/O module cable to this connector.

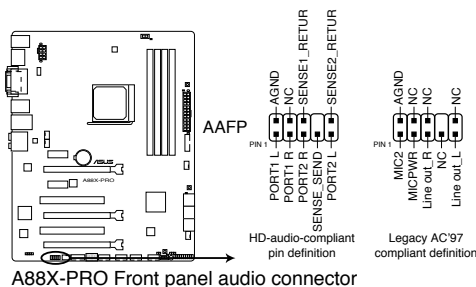

- We recommend that you connect a high-definition front panel audio module to this connector to avail of the motherboard's high-definition audio capability.
- If you want to connect a high-definition front panel audio module to this connector, set the **Front Panel Type** item in the BIOS setup to **[HD]**; if you want to connect an AC'97 front panel audio module to this connector, set the item to **[AC 97]**. By default, this connector is set to **[HD]**. Refer to **3.5.5 Onboard Devices Configuration** for details.

#### 4. Digital audio connector (4-1 pin SPDIF\_OUT)

This connector is for an additional Sony/Philips Digital Interface (S/PDIF) port. Connect the S/PDIF Out module cable to this connector, then install the module to a slot opening at the back of the system chassis.

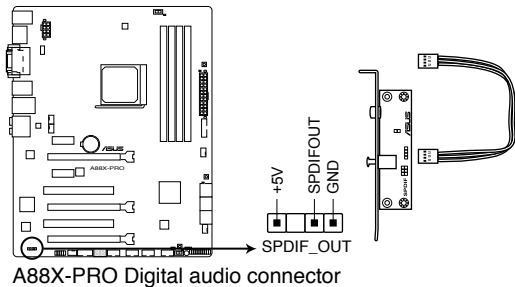

The S/PDIF module is purchased separately.

#### 5. CPU and chassis fan connectors (4-pin CPU\_FAN, 4-pin CHA\_FAN1/2/3/4)

Connect the fan cables to the fan connectors on the motherboard, ensuring that the black wire of each cable matches the ground pin of the connector.

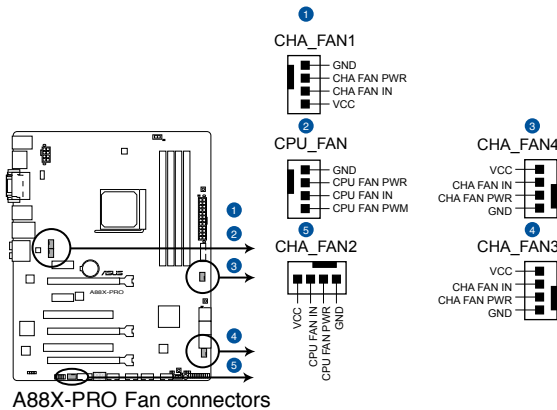

Do not forget to connect the fan cables to the fan connectors. Insufficient air flow inside the system may damage the motherboard components. These are not jumpers! Do not place jumper caps on the fan connectors!



The CPU\_FAN connector supports the CPU fan of maximum 1A (12 W) fan power.

## 6. USB 3.0 connector (20-1 pin USB3\_34)

These connectors are for the additional USB 3.0 ports, and complies with the USB 3.0 specification that supports up to 4.8Gbps connection speed. If the USB 3.0 front panel cable is available from your system chassis, with this USB 3.0 connector, you can have a front panel USB 3.0 solution.

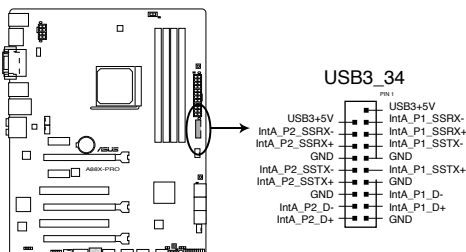

A88X-PRO USB3.0 Front panel connector



You can connect the ASUS front panel USB 3.0 bracket to this connector to obtain the front panel USB 3.0 solution.

## 7. Serial port connector (10-1 pin COM)

This connector is for a serial (COM) port. Connect the serial port module cable to this connector, then install the module to a slot opening at the back of the system chassis.

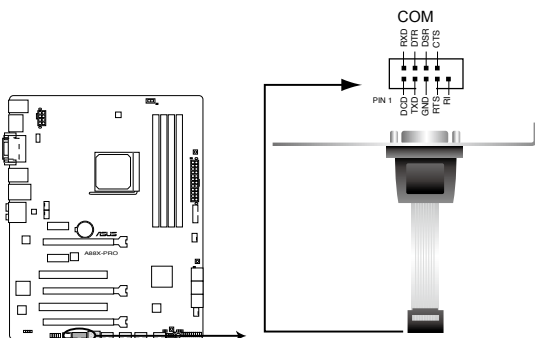

A88X-PRO Serial port (COM) connector



The serial port bracket (COM) module is purchased separately.

## 8. ATX power connectors (24-pin EATXPWR; 8-pin EATX12V)

These connectors are for ATX power supply plugs. The power supply plugs are designed to fit these connectors in only one orientation. Find the proper orientation and push down until the connectors completely fit.

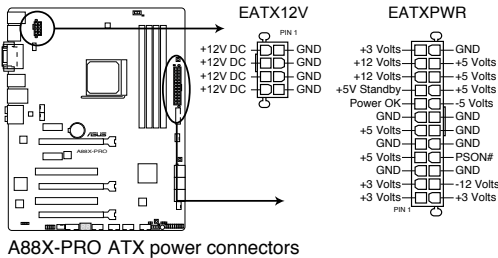

A88X-PRO ATX power connectors



- For a fully configured system, we recommend that you use a power supply unit (PSU) that complies with ATX 12 V Specification 2.0 (or later version) and provides a minimum power of 450 W.
- Do not forget to connect the 4-pin / 8-pin EATX12 V power plug; otherwise, the system will not boot.
- We recommend that you use a PSU with higher power output when configuring a system with more power-consuming devices. The system may become unstable or may not boot up if the power is inadequate.
- If you are uncertain about the minimum power supply requirement for your system, refer to the **Recommended Power Supply Wattage Calculator** at <http://support.asus.com/PowerSupplyCalculator/PSCalculator.aspx?SLanguage=en-us> for details.

## 9. Direct connector (2-pin DRCT)

This connector is for the chassis-mounted button that supports the DirectKey function. Connect the button cable that supports DirectKey, from the chassis to this connector on the motherboard.

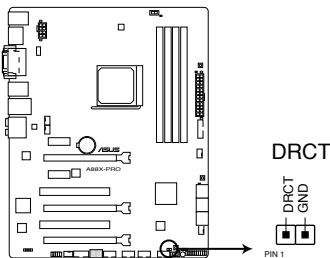

A88X-PRO DRCT connector



- Ensure that your chassis comes with the button cable that supports the DirectKey feature. Refer to the technical documentation that came with the chassis for details.

## 10. System panel connector (20-8 pin PANEL)

This connector supports several chassis-mounted functions.

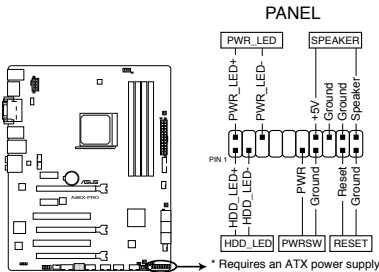

A88X-PRO System panel connector

- **System power LED (2-pin PLED)**

This 2-pin connector is for the system power LED. Connect the chassis power LED cable to this connector. The system power LED lights up when you turn on the system power, and blinks when the system is in sleep mode.

- **Hard disk drive activity LED (2-pin IDE\_LED)**

This 2-pin connector is for the HDD Activity LED. Connect the HDD Activity LED cable to this connector. The IDE LED lights up or flashes when data is read from or written to the HDD.

- **System warning speaker (4-pin SPEAKER)**

This 4-pin connector is for the chassis-mounted system warning speaker. The speaker allows you to hear system beeps and warnings.

- **ATX power button/soft-off button (2-pin PWRSW)**

This connector is for the system power button. Pressing the power button turns the system on. Pressing the power switch for more than four seconds while the system is ON turns the system OFF.



- **Reset button (2-pin RESET)**

This 2-pin connector is for the chassis-mounted reset button for system reboot without turning off the system power.

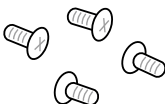

## 2.3 Building your computer system

### 2.3.1 Additional tools and components to build a PC system

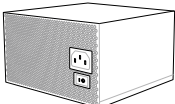
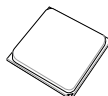
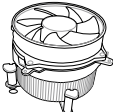
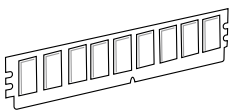
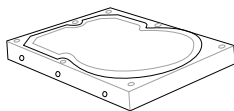
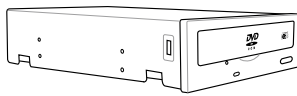
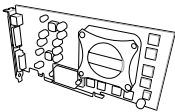
	
1 bag of screws	Phillips (cross) screwdriver
	
PC chassis	Power supply unit
	
AMD FM2+/FM2 APU	AMD FM2+/FM2 compatible CPU Fan
	
DIMM	SATA hard disk drive
	
SATA optical disc drive (optional)	Graphics card (optional)



The tools and components in the table above are not included in the motherboard package.

## 2.3.2 APU installation



Ensure that you use an APU designed for the FM2+ socket. The APU fits in only one correct orientation. DO NOT force the APU into the socket to prevent bending the pins and damaging the APU!

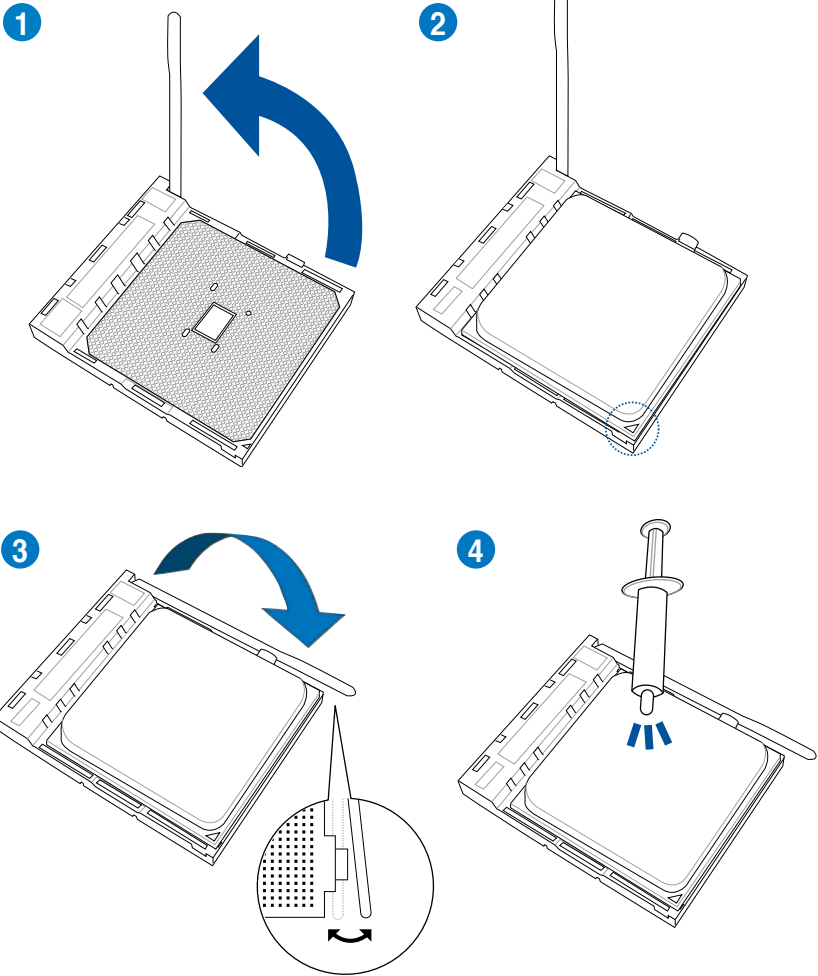

### 2.3.3 APU heatsink and fan assembly installation

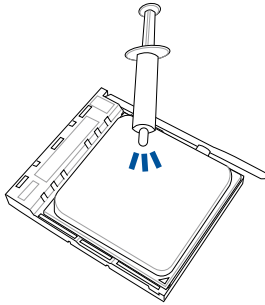

Apply the Thermal Interface Material to the APU heatsink and APU before you install the heatsink and fan if necessary.

#### To install the APU heatsink and fan assembly

1

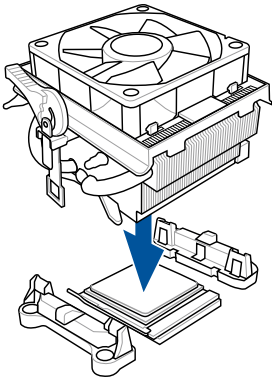

2

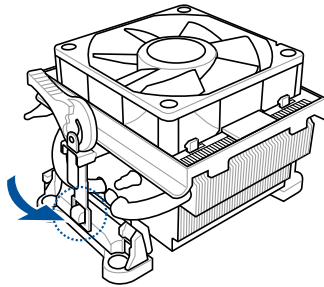

3

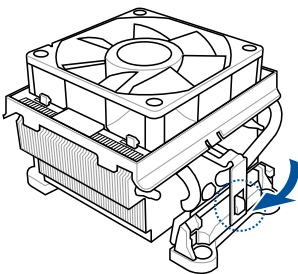

4

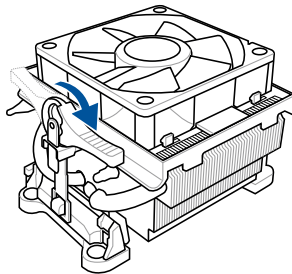

5

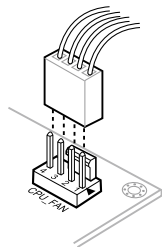

## To uninstall the APU heatsink and fan assembly

1

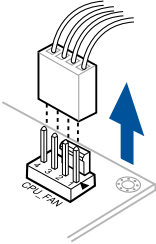

2

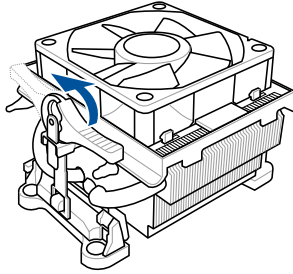

3

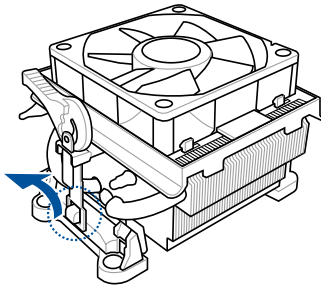

4

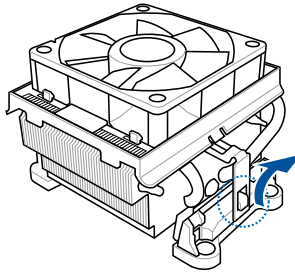

5

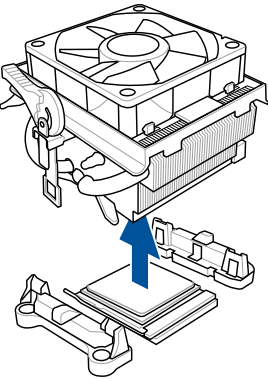

### 2.3.4 DIMM installation

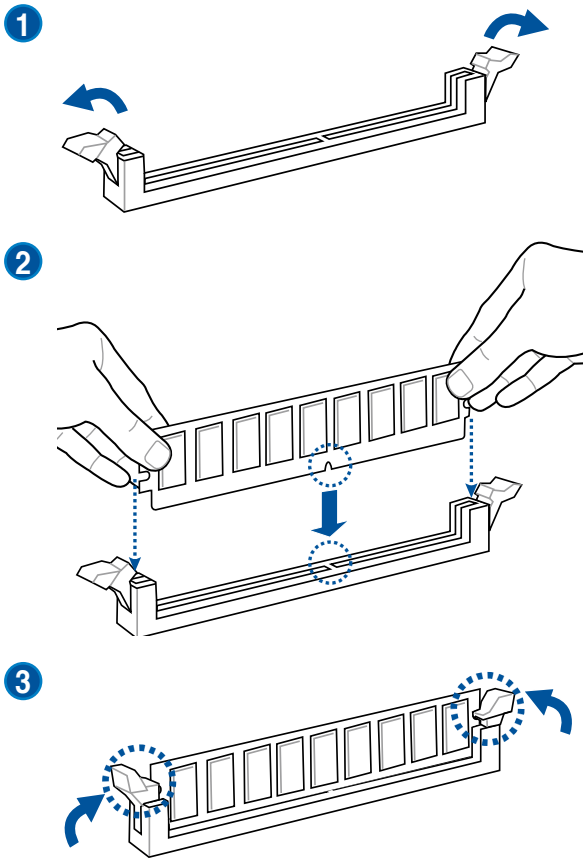

#### To remove a DIMM

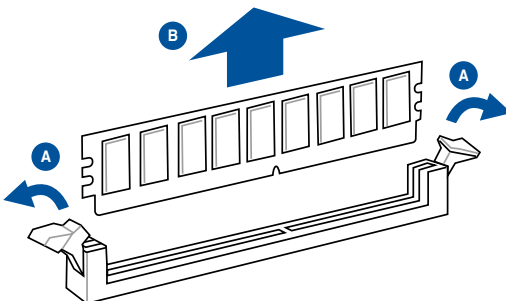

## 2.3.5 Motherboard installation



The diagrams in this section are for reference only. The motherboard layout may vary with models, but the installation steps remain the same.

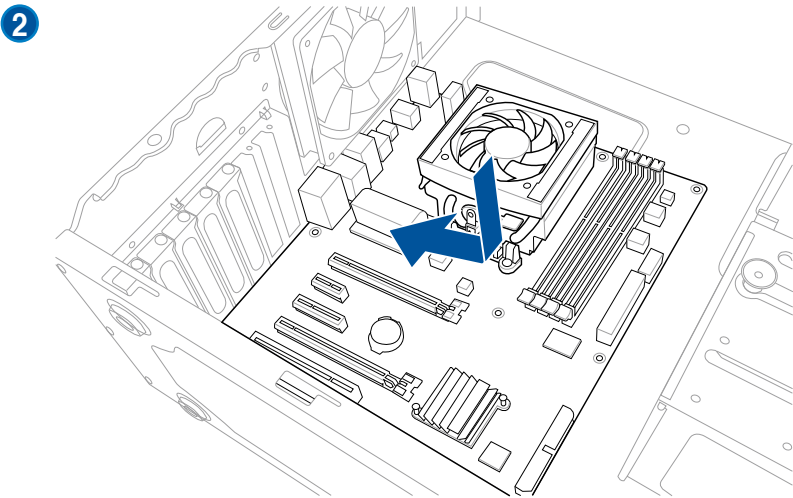
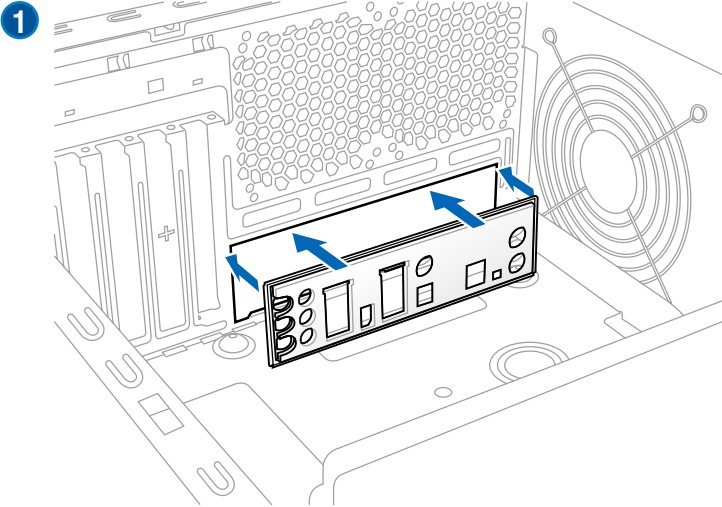

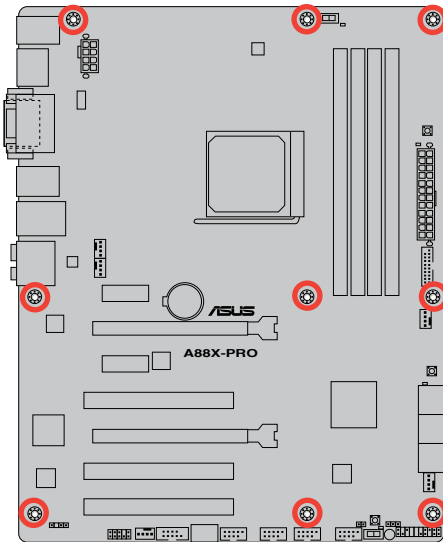
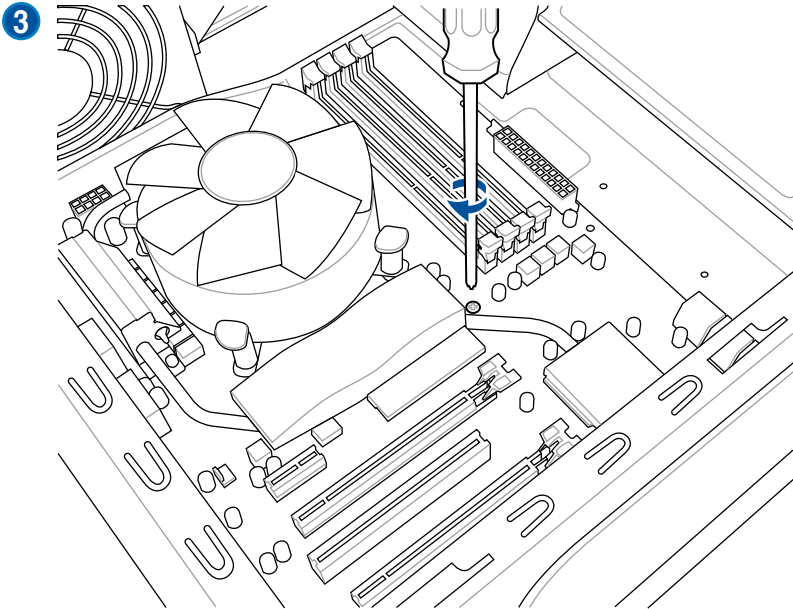

DO NOT overtighten the screws! Doing so can damage the motherboard.

### 2.3.6 ATX Power connection

1

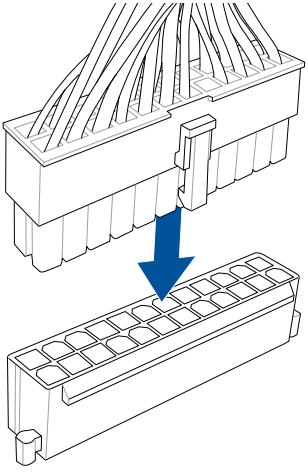

2

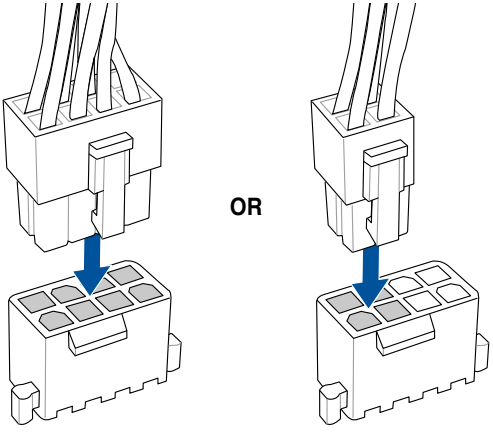



### 2.3.7 SATA device connection

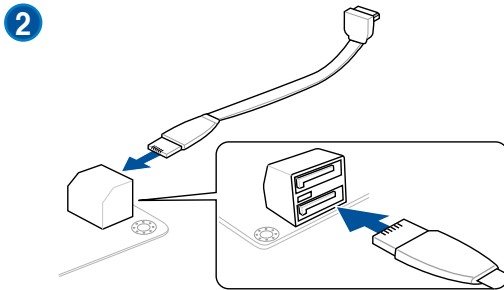
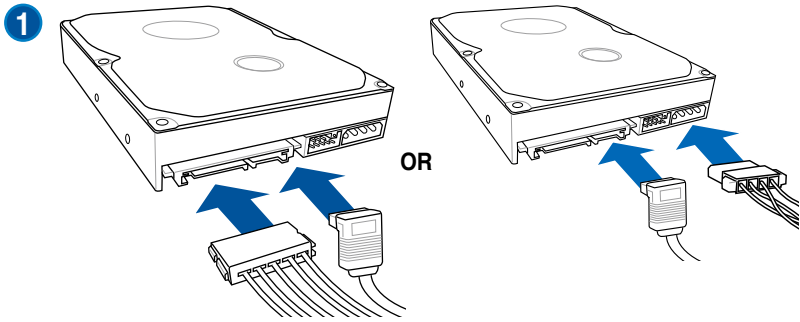

## 2.3.8 Front I/O Connector

To install ASUS Q-Connector

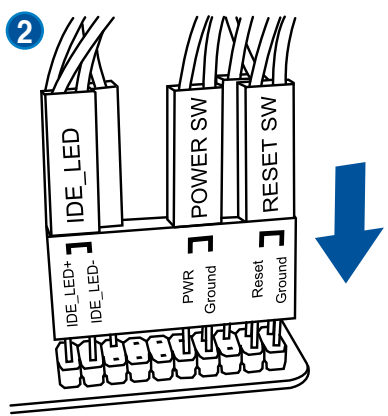
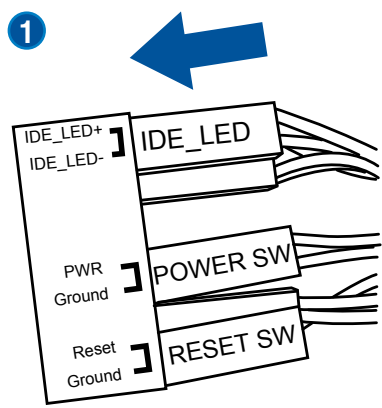

To install USB 2.0 Connector

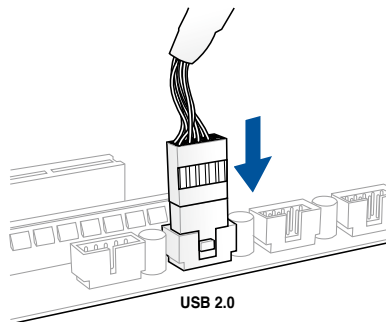

To install front panel audio connector

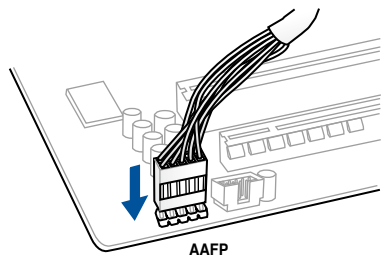

To install USB 3.0 Connector

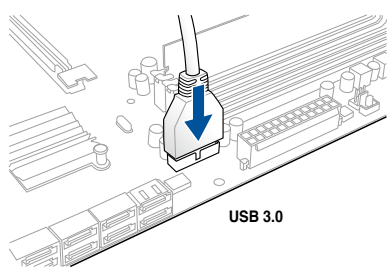

## 2.3.9 Expansion Card installation

To install PCIe x16 cards

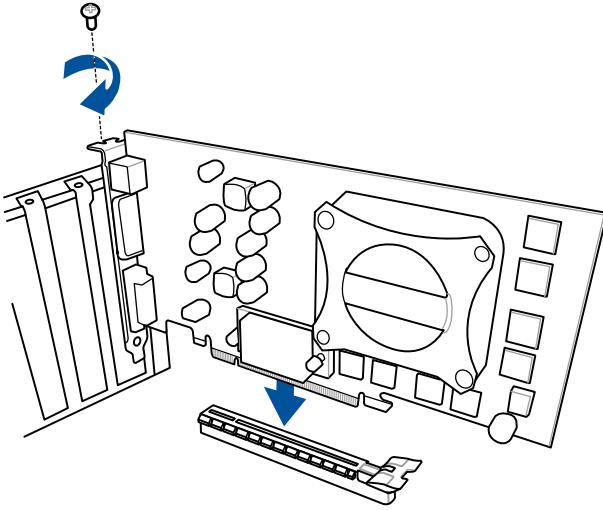

To install PCIe x1 cards

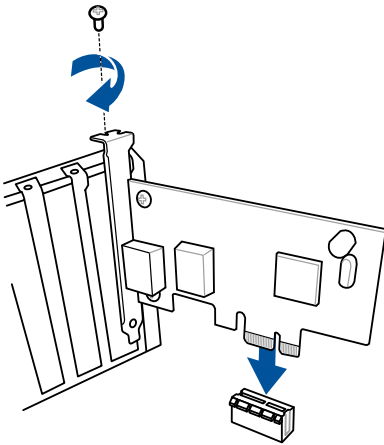

To install PCI cards

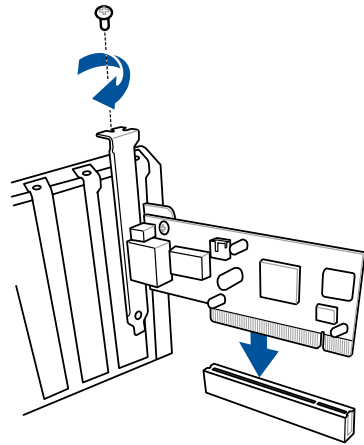

## 2.3.10 Rear panel connection

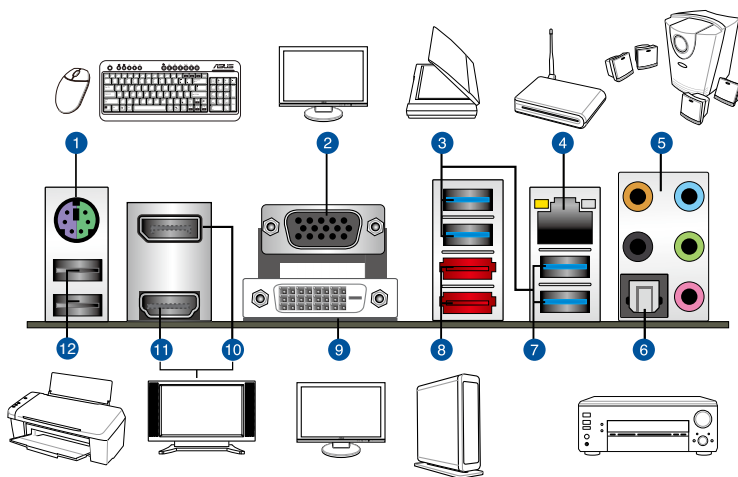

### Rear panel connectors

1.	PS/2 keyboard/mouse combo port	7.	AMD USB 3.0 ports 1 and 2, support ASUS USB 3.0 Boost UASP Mode. Bottom port supports USB BIOS Flashback and USB Charger+
2.	Video Graphics Adapter (VGA) port	8.	External SATA 6.0Gb/s ports
3.	ASMedia USB 3.0 ports 1 and 2, support ASUS USB 3.0 Boost UASP Mode	9.	DVI-D port
4.	Realtek® LAN (RJ-45) port*	10.	DisplayPort
5.	Audio I/O ports**	11.	HDMI port
6.	Optical S/PDIF Out port	12.	USB 2.0 ports 1 and 2

\* and \*\*: Refer to the tables on the next page for LAN port LED and audio port definitions.



- Due to USB 3.0 controller limitation, USB 3.0 devices can only be used under Windows® OS environment and after the USB 3.0 driver is installed.
- USB 3.0 devices can be used as data storage only.
- The USB3\_2 port supports USB Charger+ and USB BIOS Flashback.
- We strongly recommend that you connect USB 3.0 devices to USB 3.0 ports for faster and better performance for your USB 3.0 devices.



DO NOT insert a different connector to the external SATA port.

### \* LAN port LED indications

Activity Link LED		Speed LED	
Status	Description	Status	Description
OFF	No link	OFF	10 Mbps connection
ORANGE	Linked	ORANGE	100 Mbps connection
BLINKING	Data activity	GREEN	1 Gbps connection

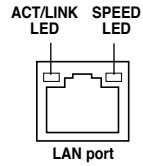

### \*\* Audio 2.1, 4.1, 5.1 or 7.1-channel configuration

Port	Headset 2-channel	4.1-channel	5.1-channel	7.1-channel
Light Blue	Line In	Line In	Line In	Side Speaker Out
Lime	Line Out	Front Speaker Out	Front Speaker Out	Front Speaker Out
Pink	Mic In	Mic In	Mic In	Mic In
Orange	–	–	Center/Subwoofer	Center/Subwoofer
Black	–	Rear Speaker Out	Rear Speaker Out	Rear Speaker Out



\*\*8-channel speaker setup may refer to above 7.1 channel configuration.



#### Multiple display table

This table indicates whether the multiple display you want to use is supported or not.

Multiple display output	Supported	Not supported
DVI + D-Sub	•	
HDMI + D-Sub	•	
DVI + HDMI		•
DVI + DisplayPort	•	
D-Sub + DisplayPort	•	
HDMI + DisplayPort	•	
DVI + D-Sub + DisplayPort	•	
HDMI + D-Sub + DisplayPort	•	
HDMI + DVI + DisplayPort		•

## 2.3.11 Audio I/O connections

### Audio I/O ports

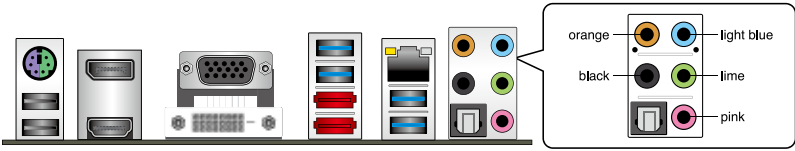

### Connect to Headphone and Mic



### Connect to Stereo Speakers

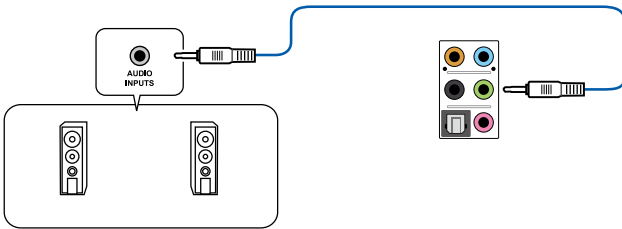

### Connect to 2.1 channel Speakers

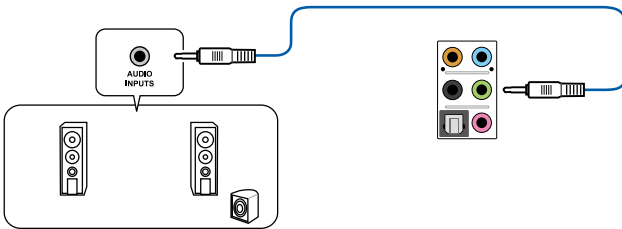

### Connect to 4.1 channel Speakers

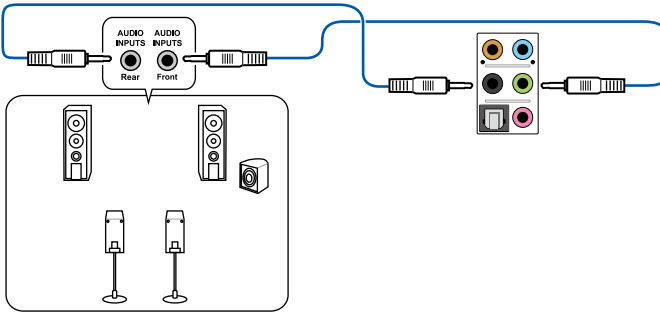

### Connect to 5.1 channel Speakers

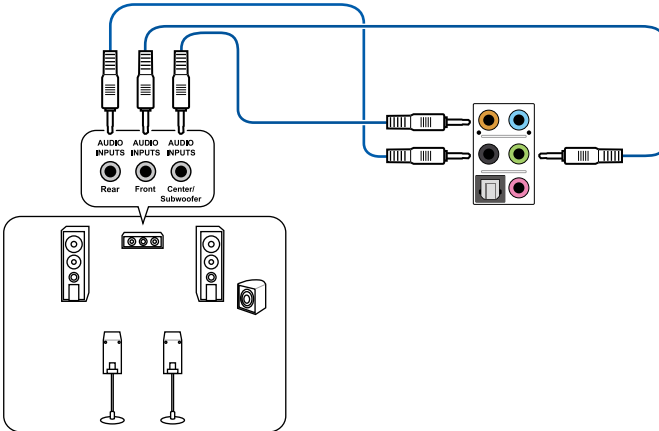

### Connect to 7.1 channel Speakers

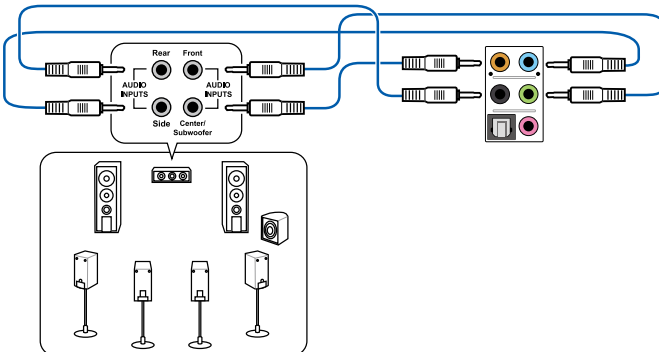

## 2.4 Starting up for the first time

1. After making all the connections, replace the system case cover.
2. Be sure that all switches are off.
3. Connect the power cord to the power connector at the back of the system chassis.
4. Connect the power cord to a power outlet that is equipped with a surge protector.
5. Turn on the devices in the following order:
  - a. Monitor
  - b. External SCSI devices (starting with the last device on the chain)
  - c. System power
6. After applying power, the system power LED on the system front panel case lights up. For systems with ATX power supplies, the system LED lights up when you press the ATX power button. If your monitor complies with the “green” standards or if it has a “power standby” feature, the monitor LED may light up or change from orange to green after the system LED turns on.

The system then runs the power-on self tests or POST. While the tests are running, the BIOS beeps (see the BIOS beep codes table below) or additional messages appear on the screen. If you do not see anything within 30 seconds from the time you turned on the power, the system may have failed a power-on test. Check the jumper settings and connections or call your retailer for assistance.

BIOS Beep	Description
One short beep	VGA detected Quick boot set to disabled No keyboard detected
One continuous beep followed by two short beeps then a pause (repeated)	No memory detected
One continuous beep followed by three short beeps	No VGA detected
One continuous beep followed by four short beeps	Hardware component failure

7. At power on, hold down the <Delete> key to enter the BIOS Setup. Follow the instructions in Chapter 3.

## 2.5 Turning off the computer

While the system is ON, pressing the power switch for less than four seconds puts the system on sleep mode or soft-off mode, depending on the BIOS setting. Pressing the power switch for more than four seconds lets the system enter the soft-off mode regardless of the BIOS setting.



# Chapter 3

## 3.1 Knowing BIOS



The ASUS UEFI BIOS offers a user-friendly interface that goes beyond traditional keyboard-only BIOS controls to enable more flexible and convenient mouse input. Users can easily navigate the UEFI BIOS with the same smoothness as their operating system. The term "BIOS" in this user manual refers to "UEFI BIOS" unless otherwise specified.

BIOS (Basic Input and Output System) stores system hardware settings such as storage device configuration, overclocking settings, advanced power management, and boot device configuration that are needed for system startup in the motherboard CMOS. In normal circumstances, the default BIOS settings apply to most conditions to ensure optimum performance. **We recommend that you not change the default BIOS settings** except in the following circumstances:

- An error message appears on the screen during the system bootup and requests you to run the BIOS Setup.
- You have installed a new system component that requires further BIOS settings or update.



Inappropriate settings of the BIOS may result to instability or failure to boot. We strongly recommend that you change the BIOS settings only with the help of a trained service personnel.

## 3.2 BIOS setup program

A BIOS setup program is provided for BIOS item modification. When you start up the computer, the system provides you with the opportunity to run this program. Press <Del> during the Power-On Self-Test (POST) to enter the Setup utility. Otherwise, POST continues with its test routines.

If you wish to enter Setup after POST, press <Ctrl> + <Alt> + <Delete>, or press the reset button on the system chassis to restart the system. You can also turn the system off and then turn it back on to restart the system. Do this last option only if the first two failed.



- The BIOS setup screens shown in this section are for reference purposes only, and may not exactly match what you see on your screen.
- Ensure that a USB mouse is connected to your motherboard if you want to use the mouse to control the BIOS setup program.
- If the system becomes unstable after changing any BIOS setting, load the default settings to ensure system compatibility and stability. Select the **Load Optimized Defaults** item under the **Exit** menu. See section 3.9 **Exit Menu** for details.
- If the system fails to boot after changing any BIOS setting, try to clear the CMOS and reset the motherboard to the default value. See section 2.2.5 **Jumper** for information on how to erase the RTC RAM.
- The BIOS setup program does not support the bluetooth devices.

The BIOS setup program is designed to make it as easy to use as possible. Being a menu-driven program, it lets you scroll through the various submenus and select from the available options using a keyboard or a USB mouse.

The BIOS setup program can be used under two modes: **EZ Mode** and **Advanced Mode**. You can change modes from the **Exit** menu or from the **Exit/Advanced Mode** button in the **EZ Mode/Advanced Mode** screen.

### 3.2.1 EZ Mode

By default, the EZ Mode screen appears when you enter the BIOS setup program. The EZ Mode provides you an overview of the basic system information, and allows you to select the display language, system performance mode and boot device priority. To access the Advanced Mode, click **Exit/Advanced Mode**, then select **Advanced Mode** or press F7 hot key for the advanced BIOS settings.



The default screen for entering the BIOS setup program can be changed. Refer to the **Setup Mode** item in section 3.7 **Boot menu** for details.

Selects the display language of the BIOS setup program

Displays CPU temperature, CPU voltage output, DRAM information and CPU/ Chassis fan speed

Exits the BIOS setup program without saving the changes, saves the changes and resets the system, or enters the Advanced Mode



Power Saving mode

Advanced mode functions

Advanced mode menus

Boot device priority

Normal mode

SATA Information

ASUS Optimal mode

Loads optimized default

Displays the system properties



- The boot device options vary depending on the devices you installed to the system.
- The **Boot Menu(F8)** button is available only when the boot device is installed to the system.

### 3.2.2 Advanced Mode

The Advanced Mode provides advanced options for experienced end-users to configure the BIOS settings. The figure below shows an example of the Advanced Mode. Refer to the following sections for the detailed configurations.



To access the Advanced Mode, click **Exit**, then select **Advanced Mode**.

The screenshot shows the ASUS UEFI BIOS Utility in Advanced Mode. The interface includes a menu bar at the top with items like 'Main', 'Ai Tweaker', 'Advanced', 'Monitor', 'Boot', 'Tool', and 'Exit'. A left sidebar contains menu items such as 'Advanced SATA Configuration', 'SATA Configuration', 'OnChip SATA Channel', 'OnChip SATA Type', and 'SATA Ports - Port0'. The main area displays 'S.M.A.R.T. Status Check' with a scroll bar and a pop-up window. A 'Navigation keys' box lists: 'Esc: Select Screen', 'F1: Select Item', 'Enter: Select', 'F2: Change option', 'F12: General help', 'F10: Previous screen', 'F5: Uninstall', 'F4: Add to Uninstall List By Favorites', 'F11: Optimized Defaults', 'F8: Save', 'F10: Exit', and 'F12: Print Screen'. A 'Quick note' box is also present.

#### Menu bar

The menu bar on top of the screen has the following main items:

<b>Main</b>	For changing the basic system configuration
<b>Ai Tweaker</b>	For changing the overclocking settings
<b>Advanced</b>	For changing the advanced system settings
<b>Monitor</b>	For displaying the system temperature, power status, and changing the fan settings.
<b>Boot</b>	For changing the system boot configuration
<b>Tool</b>	For configuring options for special functions
<b>Exit</b>	For selecting the exit options and loading default settings

## Menu items

The highlighted item on the menu bar displays the specific items for that menu. For example, selecting **Main** shows the Main menu items.

The other items (Ai Tweaker, Advanced, Monitor, Boot, Tool, and Exit) on the menu bar have their respective menu items.

## Back button

This button appears when entering a submenu. Press <Esc> or use the USB mouse to click this button to return to the previous menu screen.

## Submenu items

A greater than sign (>) before each item on any menu screen means that the item has a submenu. To display the submenu, select the item and press <Enter>.

## Pop-up window

Select a menu item and press <Enter> to display a pop-up window with the configuration options for that item.

## Scroll bar

A scroll bar appears on the right side of a menu screen when there are items that do not fit on the screen. Press the Up/Down arrow keys or <Page Up> / <Page Down> keys to display the other items on the screen.

## Navigation keys

At the bottom right corner of the menu screen are the navigation keys for the BIOS setup program. Use the navigation keys to select items in the menu and change the settings.

## General help

At the top right corner of the menu screen is a brief description of the selected item. Use <F12> key to capture the BIOS screen and save it to the removable storage device.

## Configuration fields

These fields show the values for the menu items. If an item is user-configurable, you can change the value of the field opposite the item. You cannot select an item that is not user-configurable.

A configurable field is highlighted when selected. To change the value of a field, select it and press <Enter> to display a list of options.

### 3.3 Main menu

The Main menu screen appears when you enter the Advanced Mode of the BIOS Setup program. The Main menu provides you an overview of the basic system information, and allows you to set the system date, time, language, and security settings.



### Security

The Security menu items allow you to change the system security settings.



- If you have forgotten your BIOS password, erase the CMOS Real Time Clock (RTC) RAM to clear the BIOS password. See section 2.2.5 Jumper for information on how to erase the RTC RAM.
- The **Administrator** or **User Password** items on top of the screen show the default **Not Installed**. After you set a password, these items show **Installed**.

## Administrator Password

If you have set an administrator password, we recommend that you enter the administrator password for accessing the system. Otherwise, you might be able to see or change only selected fields in the BIOS setup program.

To set an administrator password:

1. Select the **Administrator Password** item and press <Enter>.
2. From the **Create New Password** box, key in a password, then press <Enter>.
3. Confirm the password when prompted.

To change an administrator password:

1. Select the **Administrator Password** item and press <Enter>.
2. From the **Enter Current Password** box, key in the current password, then press <Enter>.
3. From the **Create New Password** box, key in a new password, then press <Enter>.
4. Confirm the password when prompted.

To clear the administrator password, follow the same steps as in changing an administrator password, but press <Enter> when prompted to create/confirm the password. After you clear the password, the **Administrator Password** item on top of the screen shows **Not Installed**.

## User Password

If you have set a user password, you must enter the user password for accessing the system. The **User Password** item on top of the screen shows the default **Not Installed**. After you set a password, this item shows **Installed**.

To set a user password:

1. Select the **User Password** item and press <Enter>.
2. From the **Create New Password** box, key in a password, then press <Enter>.
3. Confirm the password when prompted.

To change a user password:

1. Select the **User Password** item and press <Enter>.
2. From the **Enter Current Password** box, key in the current password, then press <Enter>.
3. From the **Create New Password** box, key in a new password, then press <Enter>.
4. Confirm the password when prompted.

To clear the user password, follow the same steps as in changing a user password, but press <Enter> when prompted to create/confirm the password. After you clear the password, the **User Password** item on top of the screen shows **Not Installed**.

## 3.4 Ai Tweaker menu

The Ai Tweaker menu items allow you to configure overclocking-related items.



Be cautious when changing the settings of the Ai Tweaker menu items. Incorrect field values can cause the system to malfunction.



The configuration options for this section vary depending on the CPU and DIMM model you installed on the motherboard.



Scroll down to display the following items:



## Ai Overclock Tuner [Auto]

Allows you to select the CPU overclocking options to achieve the desired CPU internal frequency. Select any of these preset overclocking configuration options:

- [Auto] Loads the optimal settings for the system.
- [Manual] Allows you to individually set overclocking parameters.



---

The following item appears only when you set the Ai Overclocking Tuner item to [Manual].

---

## APU Frequency [XXX]

Allows you to adjust the APU frequency to enhance the system performance. Use the <+> and <-> keys to adjust the value. You can also key in the desired value using the numeric keypad. The values range from 90.0MHz to 300.0MHz.

## Memory Frequency [Auto]

Allows you to set the memory operating frequency. The configuration options vary with the **APU Frequency** item settings. Configuration options: [Auto] [DDR3-800MHz] [DDR3-1066MHz] [DDR3-1333MHz] [DDR3-1600MHz] [DDR3-1866MHz] [DDR3-2133MHz] [DDR3-2400MHz]



---

Selecting a very high memory frequency may cause the system to become unstable! If this happens, revert to the default setting.

---

## CPU Ratio [Auto]

Allows you to adjust non-turbo ratio. Use the <+> and <-> keys to adjust the value. You can also key in the desired value using the numeric keypad.

## NB Frequency [Auto]

Allows you to adjust the NB frequency. Use the <+> and <-> keys to adjust the value. You can also key in the desired value using the numeric keypad.

## EPU Power Saving Mode [Disabled]

Allows you to enable or disable the EPU power saving function. Configuration options: [Disabled] [Enabled]

## EPU Setting [Auto]

This item appears only when you set the **EPU Power Saving Mode** item to [Enabled] and allows you to select the EPU power saving mode. Configuration options: [Auto] [Light Power Saving Mode] [Medium Power Saving Mode] [Max Power Saving Mode]



## GPU Boost [Auto]

- [Auto] Automatic configuration.
- [Turbo Mode] Set to [Turbo Mode] to achieve better 3D performance.
- [Extreme Mode] Set to [Extreme Mode] for the excellent visual experience.
- [Manual Mode] Set to [Manual Mode] if you want to manually select the desired GPU Engine frequency.

## OC Tuner

OC Tuner automatically overlocks the frequency and voltage of CPU and DRAM for enhancing the system performance. Configuration options: [OK] [Cancel]

## DRAM Timing Control

The sub-items in this menu allow you to set the DRAM timing control features. Use the <+> and <-> keys to adjust the value. To restore the default setting, type [auto] using the keyboard and press the <Enter> key.



---

Changing the values in this menu may cause the system to become unstable! If this happens, revert to the default settings.

---

## DIGI+ Power Control

### CPU Load-Line Calibration [Auto]

Load-line is defined by AMD VRM spec and affects CPU voltage. The CPU working voltage will decrease proportionally to CPU loading. Higher value gets a higher voltage and better overclocking performance, but increases the CPU and VRM thermal. Configuration options: [Auto] [Regular] [Medium] [High] [Extreme]



---

The actual performance boost may vary depending on your CPU specifications.

---

### CPU/NB Load Line Calibration [Auto]

Allows you to select the CPU/NB Load Line Calibration mode. Configuration options: [Auto] [Regular] [Medium] [High] [Extreme]

### CPU Current Capability [100%]

This item provides wider total power range for overclocking. A higher value brings a wider total power range and extends the overclocking frequency range simultaneously. Configuration options: [100%] [110%] [120%] [130%] [140%]

### CPU/NB Current Capability [100%]

This item provides wider total power range for overclocking. A higher value brings a wider total power range and extends the overclocking frequency range simultaneously. Configuration options: [100%] [110%] [120%] [130%]

## CPU Power Phase Control [Optimized]

Phase number is the number of working VRM phase. Increase the phase number under heavy system loading to get more transient and better thermal performance. Reduce the phase number under light system loading to increase VRM efficiency.

[Standard]	Proceeds to phase control depending on the CPU loading.
[Optimized]	Loads the ASUS optimized phase tuning profile.
[Extreme]	Proceeds to the full phase mode.
[Manual Adjustment]	Allows manual adjustment.

## CPU Voltage Frequency [Auto]

Switching frequency will affect the VRM transient response and thermal condition. Setting a higher frequency gets a faster transient response.

[Auto]	Allows you to enable or disable the Spread Spectrum item.
[Manual]	Allows you to manually set the frequency with a 10k Hz interval.

### VRM Spread Spectrum [Disabled]

This item appears only when you set the CPU Voltage Frequency item to [Auto] and allows you to enable the spread spectrum to enhance system stability.

### VRM Fixed Frequency Mode [xxx]

This item appears only when you set the CPU Voltage Frequency item to [Manual] and allows you to set a fixed VRM frequency. Use the <+> and <-> keys to adjust the value. The values range from 200k Hz to 400k Hz with a 10k Hz interval.

## CPU Power Duty Control [T-Probe]

[T-Probe]	Maintains the VRM thermal balance.
[Extreme]	Maintains the VRM current balance.

## CPU Power Thermal Control [125]

A higher temperature brings a wider CPU power thermal range and extends the overclocking tolerance to enlarge the O.C. potential. Use the <+> and <-> keys to adjust the value. The values range from 125 to 135.

## DRAM Current Capability [100%]

A higher value brings a wider total power range, and extends the overclocking range simultaneously. Configuration options: [100%] [110%] [120%] [130%]

## DRAM Voltage Frequency [Auto]

Allows you to adjust the DRAM switching frequency. Assign a fixed high DRAM frequency to increase the O.C. range, or a low DRAM frequency for a better system stability. Configuration options: [Auto] [Manual]

### DRAM Fixed Frequency Mode [300]

This item only appears when you set the DRAM Frequency Mode item to **[Manual]**, and allows you to set a fixed DRAM frequency. Use the <+> and <-> keys to adjust the value. The values range from 300k Hz to 500k Hz with a 50k Hz interval.

### DRAM Power Phase Control [Auto]

- [Auto] Allows you to set the Auto mode.
- [Optimized] Allows you to set the ASUS optimized phase tuning profile.
- [Extreme] Allows you to set the full phase mode.



Do not remove the thermal module while changing the DIGI+ Power Control related parameters. The thermal conditions should be monitored.

### CPU Voltage [Offset Mode]

- [Manual Mode] Allows you to set a fixed CPU voltage.
- [Offset Mode] Allows you to set the Offset voltage.

### CPU Offset Mode Sign [+]

This item appears only when you set the **CPU Voltage** item to [Offset Mode].

- [+] To offset the voltage by a positive value.
- [-] To offset the voltage by a negative value.

### CPU Offset Voltage [Auto]

This item appears only when you set the **CPU Voltage** item to [Offset Mode] and allows you to set the Offset voltage. The values range from -0.500V to 0.500V with a 0.00625V interval.

### CPU Manual Voltage [Auto]

This item appears only when you set the **CPU Voltage** item to [Manual Mode] and allows you to set a fixed CPU voltage. The values range from 0.800V to 1.900V with a 0.00625V interval.



Refer to the CPU documentation before setting the CPU voltage. Setting a high voltage may damage the CPU permanently, and setting a low voltage may make the system unstable.

### VDDNB Offset Mode Sign [+]

This item appears only when you set the **CPU Voltage** item to [Offset Mode].

- [+] To offset the voltage by a positive value.
- [-] To offset the voltage by a negative value.

**VDDNB Offset Voltage [Auto]**

This item appears only when you set the **CPU Voltage** item to [Offset Mode] and allows you to set the VDDNB Offset voltage. The values range from -0.500V to 0.500V with a 0.00625V interval.

**VDDNB Manual Voltage [Auto]**

This item appears only when you set the **CPU Voltage** item to [Manual Mode] and allows you to set a fixed VDDNB voltage. The values range from 0.800V to 1.750V with a 0.00625V interval.

**DRAM Voltage [Auto]**

Allows you to set the DRAM voltage. The values range from 1.35V to 2.135V with a 0.005V interval.

**SB 1.1V Voltage [Auto]**

Allows you to set the Southbridge 1.1V voltage. The values range from 1.1V to 1.4V with a 0.01V interval.

**1.1VSB Voltage [Auto]**

Allows you to set the 1.1Vsb voltage. The values range from 1.1000V to 1.4000V with a 0.1V interval.

**APU1.2V Voltage [Auto]**

Allows you to set the APU (Accelerated Processor Unit) 1.2V voltage. The values range from 1.2000V to 1.8000V with a 0.01V interval.

**VDDA Voltage [Auto]**

Allows you to set the VDDA voltage. The values range from 2.5000V to 2.8000V with a 0.1V interval.

**NB VREF Voltage [Auto]**

Allows you to set the NB VREF voltage with a 0.005V interval.

**DRAM VREFCA Voltage [Auto]**

Allows you to set the DRAM VREFCA voltage with a 0.005V interval.

**DRAM VREFDQ Voltage [Auto]**

Allows you to set the DRAM VREFDQ voltage with a 0.005V interval.



- The values of the **CPU Voltage**, **CPU Offset Voltage**, **VDDNB Offset Voltage**, **VDDNB Manual Voltage**, **DRAM Voltage**, **SB 1.1V Voltage**, **1.1VSB Voltage**, **APU1.2V Voltage**, **VDDA Voltage**, **NB VREF Voltage**, **DRAM VREFCA Voltage**, and **DRAM VREFDQ Voltage** items are labeled in a different color, indicating the risk levels of high voltage settings.
- The system may need better cooling system to work stably under high voltage settings.

## 3.5 Advanced menu

The Advanced menu items allow you to change the settings for the CPU and other system devices.



Be cautious when changing the settings of the Advanced menu items. Incorrect field values can cause the system to malfunction.



### 3.5.1 CPU Configuration

The items in this menu show the CPU-related information that the BIOS automatically detects.



The items shown in this screen may be different due to the CPU you installed.



#### AMD PowerNow function [Enabled]

Enables or disables the AMD PowerNow function. Configuration options: [Enabled] [Disabled]

#### NX Mode [Enabled]

Enables or disables the No-execute page protection function. Configuration options: [Enabled] [Disabled]

#### SVM Mode [Enabled]

Allows you to enable or disable CPU virtualization. Configuration options: [Disabled] [Enabled]

#### CPB Mode [Auto]

Disables the CPB (Core Performance Boost) mode or set it to [Auto] for automatic configuration. Configuration options: [Disabled] [Auto]

#### C6 Mode [Enabled]

Enables or disables C6 mode. Configuration options: [Enabled] [Disabled]

**IOMMU [Disabled]**

Set this item to [Enabled] to show IOMMU Mode. Configuration options: [Enabled] [Disabled]

**Bank Interleaving [Enabled]**

Enables or disables the bank memory interleaving. Configuration options: [Enabled] [Disabled]

**Channel Interleaving [Enabled]**

Enables or disables the channel memory interleaving. Configuration options: [Enabled] [Disabled]

**Core Leveling Mode [Automatic mode]**

Allows you to change the number of working Compute Unit on the system. Configuration options: [Automatic mode] [One core per processor] [One Compute Unit] [One core per Compute Unit]

**3.5.2 SATA Configuration**

While entering Setup, the BIOS automatically detects the presence of SATA devices. The SATA Port items show **Not Present** if no SATA device is installed to the corresponding SATA port.

**OnChip SATA Channel [Enabled]**

Enables or disables onboard channel SATA port. Configuration options: [Disabled] [Enabled]

**OnChip SATA Type [AHCI]**

Allows you to set the SATA configuration.

- |        |  |
|--------|--|
| [IDE]  | Set to [IDE] when you want to use the Serial ATA hard disk drives as Parallel ATA physical storage devices.  |
| [RAID] | Set to [RAID] when you want to create a RAID configuration from the SATA hard disk drives.   |
| [AHCI] | Set to [AHCI] when you want the SATA hard disk drives to use the AHCI (Advanced Host Controller Interface). The AHCI allows the onboard storage driver to enable advanced Serial ATA features that increases storage performance on random workloads by allowing the drive to internally optimize the order of commands. |

**SATA Port 5, 6, ESATA 7, 8 [AHCI]**

This item only appears when **OnChip SATA Type** is set to [AHCI]. If SATA ports 5 and 6 are configured as [AHCI], the ports can only be used under OS with driver installed. Set to [IDE] instead of [AHCI] to access devices on SATA ports 5 and 6 before entering OS. Configuration options: [AHCI] [IDE]

**S.M.A.R.T. Status Check [Enabled]**

S.M.A.R.T. (Self-Monitoring, Analysis and Reporting Technology) is a monitor system. When read/write of your hard disk errors occur, this feature allows the hard disk to report warning messages during the POST. Configuration options: [Enabled] [Disabled]

### 3.5.3 USB Configuration

The items in this menu allow you to change the USB-related features.



---

The **USB Devices** item shows the auto-detected values. If no USB device is detected, the item shows **None**.

---

#### USB Device Enable [Enabled]

Allows you to enable or disable all USB ports. Configuration options: [Disabled] [Enabled]

#### Legacy USB Support [Enabled]

[Enabled] Enables the support for USB devices on legacy operating systems (OS).  
[Disabled] The USB devices can be used only for the BIOS setup program.  
[Auto] Allows the system to detect the presence of USB devices at startup. If detected, the USB controller legacy mode is enabled. If no USB device is detected, the legacy USB support is disabled.

#### EHCI Hand-off [Disabled]

[Enabled] Enables the support for operating systems without an EHCI hand-off feature.  
[Disabled] Disables the function.

#### USB Single Port Control

Allows you to enable/disable individual USB ports.

### 3.5.4 NB Configuration

#### IGFX Multi-Monitor [Disabled]

Enables or disables the Internal Graphics Device Multi-Monitor support for add-on VGA devices. And the memory size of Internal Graphics Device will keep memory reserved. Configuration options: [Disabled] [Enabled]



---

The **IGFX Multi-Monitor** item must be enabled before using AMD® Dual Graphics technology.

---

#### Primary Video Device [PCI-E / PCI Video]

Selects the primary display device. Configuration options: [IGFX Video] [PCI-E / PCI Video]

#### Integrated Graphics [Auto]

Enables the integrated graphics controller. Configuration options: [Auto] [Force]



### UMA Frame Buffer Size [Auto]

Configuration options: [Auto] [32M] [64M] [128M] [256M] [512M] [1G] [2G]

### HDMI/DVI Port Output [Auto]

Sets the HDMI/DVI port output type. Configuration options: [Auto] [HDMI] [DVI]

### PClex16\_1 [Auto]

Sets the speed mode for the PClex16\_1 slot. When [Force X16] is selected, the PClex16\_2 slot will be disabled. Configuration options: [Auto] [Force X16] [Force X8]

## 3.5.5 Onboard Devices Configuration

### HD Audio Device [Enabled]

[Enabled] Enables the High Definition Audio Controller.

[Disabled] Disables the controller.



---

The following two items appear only when you set the **HD Audio Device** item to [Enabled].

---

### Front Panel Type [HD]

Allows you to set the front panel audio connector (AAFP) mode to legacy AC'97 or high-definition audio depending on the audio standard that the front panel audio module supports.

[HD] Sets the front panel audio connector (AAFP) mode to high definition audio.

[AC97] Sets the front panel audio connector (AAFP) mode to legacy AC'97

### SPDIF Out Type [SPDIF]

[SPDIF] Sets to [SPDIF] for SPDIF audio output.

[HDMI] Sets to [HDMI] for HDMI audio output.

### Realtek LAN Controller [Enabled]

[Enabled] Enables the Realtek LAN controller.

[Disabled] Disables the controller.

### Realtek PXE OPROM [Disabled]

This item appears only when you set the previous item to [Enabled] and allows you to enable or disable the PXE OptionRom of the Realtek LAN controller.

Configuration options: [Enabled] [Disabled]

## Asmedia USB 3.0 Controller [Enabled]

[Enabled] Enables the USB 3.0 controller.

[Disabled] Disables the controller.

## Asmedia USB 3.0 Battery Charging Support [Disabled]

This item appears only when you set the previous item to [Enabled] and allows you to enable or disable the ASmedia USB 3.0 Battery Charging Support.

[Enabled] Enables Asmedia USB 3.0 fast battery charging support for USB 3.0 devices complying with the BC 1.1 regulation.

[Disabled] Disables battery charging support.

## Serial Port Configuration

The sub-items in this menu allow you to set the serial port configuration.

### Serial Port [Enabled]

Allows you to enable or disable the serial port (COM). Configuration options: [Enabled] [Disabled]

### Change Settings [IO=3F8h; IRQ=4]

This item appears only when you set the **Serial Port** to [Enabled] and allows you to select the Serial Port base address. Configuration options: [IO=3F8h; IRQ=4] [IO=2F8h; IRQ=3] [IO=3E8h; IRQ=4] [IO=2E8h; IRQ=3]

### 3.5.6 APM

#### Deep S4 [Disabled]

When enabled, the system in S4 state will further reduce power usage and will power off the USB and PS/2 devices. The system in deep S4 state can be woken up via the power button, devices in LAN, or other ways except via the USB and PS/2 devices. Configuration options: [Disabled] [Enabled]

#### Deep S5 [Disabled]

When enabled, the system in S5 state will further reduce power usage. The system in deep S5 state can be only woken up via the power button. Configuration options: [Disabled] [Enabled]

#### Restore AC Power Loss [Power Off]

[Power On] The system goes into on state after an AC power loss.  
 [Power Off] The system goes into off state after an AC power loss.  
 [Last State] The system goes into either off or on state, whatever the system state was before the AC power loss.

#### Power On By PME [Disabled]

[Disabled] Disables the PME to wake up by PCI/PCIE devices.  
 [Enabled] Allows you to turn on the system through a PCI/PCIE LAN or modem card. This feature requires an ATX power supply that provides at least 1A on the +5VSB lead.

#### Power On By Ring [Disabled]

[Disabled] Disables Ring to generate a wake event.  
 [Enabled] Enables Ring to generate a wake event.

#### Power On By RTC [Disabled]

[Disabled] Disables RTC to generate a wake event.  
 [Enabled] When set to [Enabled], the items **RTC Alarm Date (Days)** and **Hour/Minute/Second** will become user-configurable with set values.

##### RTC Alarm Date (Days)

This item appears only when you set the previous item to [Enabled] and allows you to select RTC alarm time (days). When you set the time to zero, the RTC alarms everyday. Use <+> and <-> keys to adjust the time.

##### - Hour / - Minute / - Second

Allows you to set the RTC alarm time. Use <+> and <-> keys to adjust the time.

### 3.5.7 Network Stack

#### Network Stack [Disable Link]

Enables or disables the UEFI network stack. Configuration options: [Disable Link] [Enabled]

#### Ipv4 PXE Support [Enabled]

This item appears only when you set the Network Stack item to [Enabled]. When this item is disabled, the IPV4 PXE boot option will not be created. Configuration options: [Disable Link] [Enabled]

#### Ipv6 PXE Support [Enabled]

This item appears only when you set the Network Stack item to [Enabled]. When this item is disabled, the IPV6 PXE boot option will not be created. Configuration options: [Disable Link] [Enabled]

## 3.6 Monitor menu

The Monitor menu displays the system temperature/power status, and allows you to change the fan settings.



Scroll down to display the following items:

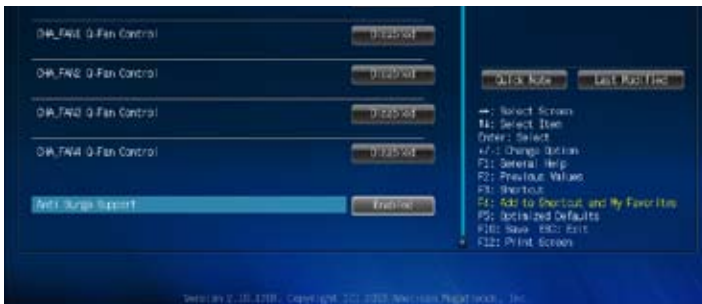

## CPU Temperature / MB Temperature [xxx°C/xxx°F]

The onboard hardware monitor automatically detects and displays the CPU and motherboard temperatures. Select **Ignore** if you do not wish to display the detected temperatures.

## CPU\_FAN Speed [xxxx RPM] or [Ignore] / [N/A]

## CHA\_FAN1/2/3/4 Speed [xxxx RPM] or [Ignore] / [N/A]

## CPU Voltage, 3.3V Voltage, 5V Voltage, 12V Voltage

The onboard hardware monitor automatically detects the voltage output through the onboard voltage regulators. Select **Ignore** if you do not want to detect this item.

## CPU Q-Fan Control [Disabled]

[Disabled] Disables the CPU Q-Fan control feature.

[Enabled] Enables the CPU Q-Fan control feature.

## CPU\_FAN Speed Low Limit [200 RPM]

This item appears only when you enable the **CPU Q-Fan Control** feature and allows you to disable or set the CPU fan warning speed. Configuration options: [Ignore] [200 RPM] [300 RPM] [400 RPM] [500 RPM] [600 RPM]

### Q-Fan Profile [Standard]

This item appears only when you enable the **Q-Fan Control** feature and allows you to set the appropriate performance level of the CPU fan.

[Standard] Sets to [Standard] to make the CPU fan automatically adjust depending on the CPU temperature.

[Silent] Sets to [Silent] to minimize the fan speed for quiet CPU fan operation.

[Turbo] Sets to [Turbo] to achieve maximum CPU fan speed.

[Manual] Sets to [Manual] to assign detailed fan speed control parameters.



---

The following four items appear only when you set **Q-Fan Profile** to [Manual].

---

### **Q-Fan Upper Temperature [70]**

Use the <+> and <-> keys to adjust the upper limit of the CPU temperature. The values range from 40°C to 75°C.

**Q-Fan Max. Duty Cycle(%) [100]**

Use the <+> and <-> keys to adjust the maximum CPU fan duty cycle. The values range from 20% to 100%. When the CPU temperature reaches the upper limit, the CPU fan will operate at the maximum duty cycle.

**Q-Fan Lower Temperature [20]**

Displays the lower limit of the CPU temperature.

**Q-Fan Min. Duty Cycle(%) [20]**

Use the <+> and <-> keys to adjust the minimum CPU fan duty cycle. The values range from 0% to 100%. When the CPU temperature is under 40°C, the CPU fan will operate at the minimum duty cycle.

**CHA\_FAN1/2/3/4 Q-Fan Control [Disabled]**

[Disabled] Disables the Chassis Q-Fan control feature.

[Enabled] Enables the Chassis Q-Fan control feature.

**CHA\_FAN1/2/3/4 Fan Speed Low Limit [600 RPM]**

This item appears only when you enable the **CHA\_FAN1/2/3/4 Q-Fan Control** feature and allows you to disable or set the CHA\_FAN1/2/3/4 fan warning speed. Configuration options: [Ignore] [200 RPM] [300 RPM] [400 RPM] [500 RPM] [600 RPM]

**CHA\_FAN1/2/3/4 Fan Profile [Standard]**

This item appears only when you enable the **CHA\_FAN1/2/3/4 Q-Fan Control** feature and allows you to set the appropriate performance level of the CHA\_FAN1/2/3/4 fan.

[Standard] Sets to [Standard] to make the chassis fan automatically adjust depending on the chassis temperature.

[Silent] Sets to [Silent] to minimize the fan speed for quiet chassis fan operation.

[Turbo] Sets to [Turbo] to achieve maximum chassis fan speed.

[Manual] Sets to [Manual] to assign detailed fan speed control parameters.



---

The following four items appear only when you set **CHA\_FAN1/2/3/4 Fan Profile** to [Manual].

---

**CHA\_FAN1/2/3/4 Upper Temperature [70]**

Use the <+> and <-> keys to adjust the upper limit of the chassis temperature. The values range from 40°C to 90°C.

***CHA\_FAN1/2/3/4 Fan Max. Duty Cycle(%) [100]***

Use the <+> and <-> keys to adjust the maximum chassis fan duty cycle. The values range from 60% to 100%. When the chassis temperature reaches the upper limit, the chassis fan will operate at the maximum duty cycle.

***CHA\_FAN1/2/3/4 Lower Temperature [40]***

Displays the lower limit of the chassis temperature.

***CHA\_FAN1/2/3/4 Fan Min. Duty Cycle(%) [60]***

Use the <+> and <-> keys to adjust the minimum chassis fan duty cycle. The values range from 60% to 100%. When the chassis temperature is under 40°C, the chassis fan will operate at the minimum duty cycle.

**Anti Surge Support [Enabled]**

This item allows you to enable or disable the Anti Surge function. Configuration options:  
[Disabled] [Enabled]



## 3.7 Boot menu

The Boot menu items allow you to change the system boot options.



Scroll down to display the following items:



## Fast Boot [Enabled]

Enable or disable boot with initialization of a minimal set of devices to launch active boot option. Configuration options: [Disabled] [Enabled]



---

The following three items appear only when you set **Fast Boot** to [Enabled].

---

## SATA Support [All Devices]

- [All Devices] All devices connected to SATA ports will be available during POST. This process will extend the POST time.
- [Hard Drive Only] Only hard drives connected to SATA ports will be detected during POST. Any hardware change will disable fast boot.
- [Boot Drive Only] Only boot drive connected to SATA ports will be detected during POST. Any hardware change will disable fast boot.

## USB Support [Partial Initial]

- [Disabled] All USB devices will not be available until OS bootup for a fastest POST time.
- [Full Initial] All USB devices will be available during POST. This process will extend the POST time.
- [Partial Initial] For a faster POST time, only the USB ports with keyboard and mouse connections will be detected.

## PS2 Keyboard and Mouse Support [Enabled]

- [Auto] For a faster BIOS POST time, PS/2 devices will only be available when the system boots up. PS/2 devices will not be available and BIOS Setup program will not be accessible via PS/2 devices when the system is restarted.
- [Full Initial] For full system control, PS/2 devices will be available during POST at any circumstances. This process will extend the POST time.
- [Disabled] All PS/2 devices will not be available until OS bootup for a fastest POST time.

## Network Stack Driver Support [Disabled]

- [Disabled] The BIOS skips over the Network Stack Driver and tries to boot from the next device.
- [Enabled] Allows the BIOS to boot from the Network Stack Driver.

## Next Boot after AC Power Loss [Normal Boot]

- [Normal Boot] Returns to normal boot on the next boot after AC power loss.
- [Fast Boot] Accelerates the boot speed on the next boot after AC power loss.

### Boot Logo Display [Auto]

- [Auto] Adjust automatically for Windows® requirement.
- [Full Screen] Maximize the boot logo size.
- [Disabled] Hide the logo during POST.

### POST Delay Time [3 sec]

This item appears only when you set **Boot Logo Display** to [Auto] or [Full Screen]. This item allows you to select the desired additional POST waiting time to easily enter the BIOS setup. You can only execute the POST delay time during Normal Boot. The values range from 0 to 10 seconds.



---

This feature will only work under normal boot.

---

### Bootup NumLock State [On]

- [On] Set the power-on state of the NumLock to **[On]**.
- [Off] Set the power-on state of the NumLock to **[Off]**.

### Wait For 'F1' If Error [Enabled]

- [Disabled] Disables the function.
- [Enabled] The system waits for the <F1> key to be pressed when error occurs.

### DirectKey Enable [Go to BIOS...]

- [Disabled] Disables the DirectKey function. The system will only power on or off when you press the DirectKey button.
- [Go to BIOS Setup] Allows the system to power on and go to BIOS Setup directly when you press the DirectKey button.

### Option ROM Messages [Force BIOS]

- [Force BIOS] The third-party ROM messages will be forced to display during the boot sequence.
- [Keep Current] The third-party ROM messages will be displayed only if the third-party manufacturer had set the add-on device to do so.

### Interrupt 19 Capture [Disabled]

- [Enabled] Allows the option ROMs to trap Interrupt 19.
- [Disabled] Disables this function.

### Setup Mode [EZ Mode]

- [Advanced Mode] Allows you to go to Advanced Mode of the BIOS after POST.
- [EZ Mode] Allows you to go to EZ Mode of the BIOS after POST.

## CSM (Compatibility Support Module)

This option controls whether or not CSM will be launched.

### Launch CSM [Auto]

Configuration option: [Auto] [Enabled] [Disabled]



---

The following four items appear only when you set **Launch CSM** to [Enabled].

---

### Boot Device Control [UEFI and Legacy OpROM]

Configuration option: [UEFI and Legacy OpROM] [Legacy OpROM only] [UEFI only]

### Boot from Network Devices [Legacy OpROM first]

Configuration option: [Legacy OpROM first] [UEFI driver first] [Ignore]

### Boot from Storage Devices [Legacy OpROM first]

Configuration option: [Both, Legacy OpRom first] [Both, UEFI driver first] [Legacy OpROM first] [UEFI driver first] [Ignore]

### Boot from PCIe/PCI Expansion Devices [Legacy OpROM first]

Configuration option: [Legacy OpROM first] [UEFI driver first]

## Secure Boot

This option allows you to configure the Secure Boot related parameters.

Allows you to configure the Windows® Secure Boot settings and manage its keys to protect the system from unauthorized access and malwares during POST.

## OS Type [Windows UEFI mode]

Allows you to select your installed operating system.

[Windows UEFI mode]Executes the Microsoft® Secure Boot check. Only select this option when booting on Windows® UEFI mode or other Microsoft® Secure Boot compliant OS.

[Other OS] Get the optimized function when booting on Windows® non-UEFI mode, Windows® Vista/XP, or other Microsoft® Secure Boot non-compliant OS. Only on Windows® UEFI mode that Microsoft® Secure Boot can function properly.



---

The following item appears when **OS Type** is set to [Windows UEFI mode].

---

## Key Management

### Clear Secure Boot keys

This item appears only when you load the default Secure Boot keys. This item allows you to clear all default Secure Boot keys.

## Save Secure Boot keys

This item appears only when you load the default Secure Boot keys. This item allows you to save all default Secure Boot keys.

## PK Management

The Platform Key (PK) locks and secures the firmware from any non-permissible changes. The system verifies the PK before your system enters the OS.

### **Delete PK**

Allows you to delete the PK from your system. Once the PK is deleted, all the system's Secure Boot keys will not be active. Configuration options: [Yes] [No]

### **Load PK from File**

Allows you to load the downloaded PK from a USB storage device.



---

The PK file must be formatted as a UEFI variable structure with time-based authenticated variable.

---

## KEK Management

The KEK (Key-exchange Key or Key Enrollment Key) manages the Signature database (db) and Revoked Signature database (dbx).



---

Key-exchange Key (KEK) refers to Microsoft® Secure Boot Key-Enrollment Key (KEK).

---

### **Delete the KEK**

Allows you to delete the KEK from your system. Configuration options: [Yes] [No]

### **Load KEK from File**

Allows you to load the downloaded KEK from a USB storage device.

### **Append KEK from file**

Allows you to load the additional KEK from a storage device for an additional db and dbx loaded management.



---

The KEK file must be formatted as a UEFI variable structure with time-based authenticated variable.

---

## DB Management

The db (Authorized Signature database) lists the signers or images of UEFI applications, operating system loaders, and UEFI drivers that you can load on the single computer.

### **Delete the db**

Allows you to delete the db file from your system. Configuration options: [Yes] [No]

**Load db from File**

Allows you to load the downloaded db from a USB storage device.

**Append db from file**

Allows you to load the additional db from a storage device so that more images can be loaded securely.



---

The DB file must be formatted as a UEFI variable structure with time-based authenticated variable.

---

**DBX Management**

The dbx (Revoked Signature database) lists the forbidden images of db items that are no longer trusted and cannot be loaded.

**Delete the DBX**

Allows you to delete the DBX file from your system. Configuration options: [Yes] [No]

**Load DBX from File**

Allows you to load the downloaded DBX from a USB storage device.

**Append DBX from file**

Allows you to load the additional DBX from a storage device so that more db's images cannot be loaded.



---

The DBX file must be formatted as a UEFI variable structure with time-based authenticated variable.

---

**2.8.10 Boot Option Priorities**

These items specify the boot device priority sequence from the available devices. The number of device items that appears on the screen depends on the number of devices installed in the system.



- 
- To select the boot device during system startup, press <F8> when ASUS Logo appears.
  - To access Windows OS in Safe Mode, do any of the following:
    - Press <F5> when ASUS Logo appears.
    - Press <F8> after POST.
-

## 2.8.11 Boot Override

These items displays the available devices. The number of device items that appears on the screen depends on the number of devices installed in the system. Click an item to start booting from the selected device.

## 3.8 Tools menu

The Tools menu items allow you to configure options for special functions. Select an item then press <Enter> to display the submenu.



### ASUS EZ Flash 2 Utility

Allows you to run ASUS EZ Flash 2. Press [Enter] to launch the ASUS EZ Flash 2 screen.



For more details, refer to section 3.10.2 **ASUS EZ Flash 2 utility**.

### ASUS SPD Information

#### DIMM Slot # [DIMM\_A1]

Displays the Serial Presence Detect (SPD) information of the DIMM module installed on the selected slot. Configuration options: [DIMM\_A1] [DIMM\_A2] [DIMM\_B1] [DIMM\_B2]

## ASUS O.C. Profile

This item allows you to store or load multiple BIOS settings.



---

The **Setup Profile Status** items show **Not Installed** if no profile is created.

---

### Label

Allows you to input the label of the setup profile.

### Save to Profile

Allows you to save the current BIOS settings to the BIOS Flash, and create a profile. Key in a profile number from one to eight, press <Enter>, and then select **Yes**.

### Load from Profile

Allows you to load the previous BIOS settings saved in the BIOS Flash. Key in the profile number that saved your BIOS settings, press <Enter>, and then select **Yes**.



- DO NOT shut down or reset the system while updating the BIOS to prevent the system boot failure!
  - We recommend that you update the BIOS file only coming from the same memory/CPU configuration and BIOS version.
- 

### Load/Save Profile from/to USB Drive

Allows you to load/save CMOS profile from/to USB drive.



## 3.9 Exit menu

The Exit menu items allow you to load the optimal default values for the BIOS items, and save or discard your changes to the BIOS items. You can access the **EZ Mode** from the Exit menu.



### Load Optimized Defaults

This option allows you to load the default values for each of the parameters on the Setup menus. When you select this option or if you press <F5>, a confirmation window appears. Select **Yes** to load the default values.

### Save Changes & Reset

Once you are finished making your selections, choose this option from the Exit menu to ensure the values you selected are saved. When you select this option or if you press <F10>, a confirmation window appears. Select **Yes** to save changes and exit.

### Discard Changes & Exit

This option allows you to exit the Setup program without saving your changes. When you select this option or if you press <Esc>, a confirmation window appears. Select **Yes** to discard changes and exit.

### ASUS EZ Mode

This option allows you to enter the EZ Mode screen.

### Launch EFI Shell from filesystem device

This option allows you to attempt to launch the EFI Shell application (shellx64.efi) from one of the available filesystem devices.

## 3.10 Managing and updating your BIOS



Save a copy of the original motherboard BIOS file to a USB flash disk in case you need to restore the BIOS in the future. Copy the original motherboard BIOS using the ASUS Update utility.

### 3.10.1 EZ Update

EZ Update is a utility that allows you to automatically update your motherboard's softwares, drivers and the BIOS version easily. With this utility, you can also manually update the saved BIOS and select a boot logo when the system goes into POST.

To launch EZ Update, click **EZ Update** on the AI Suite 3 main menu bar.

Click to automatically update your motherboard's driver, software and firmware



Click to find and select the BIOS from file

Click to select a boot logo



EZ Update requires an Internet connection either through a network or an ISP (Internet Service Provider).

### 3.10.2 ASUS EZ Flash 2

The ASUS EZ Flash 2 feature allows you to update the BIOS without using an OS-based utility.



Before you start using this utility, download the latest BIOS file from the ASUS website at [www.asus.com](http://www.asus.com).

#### To update the BIOS using EZ Flash 2:

1. Insert the USB flash disk that contains the latest BIOS file to the USB port.
2. Enter the **Advanced Mode** of the BIOS setup program. Go to the **Tool** menu to select **ASUS EZ Flash Utility** and press <Enter> to enable it.
3. Press <Tab> to switch to the **Drive** field.
4. Press the Up/Down arrow keys to find the USB flash disk that contains the latest BIOS, and then press <Enter>.
5. Press <Tab> to switch to the **Folder Info** field.
6. Press the Up/Down arrow keys to find the BIOS file, and then press <Enter> to perform the BIOS update process. Reboot the system when the update process is done.



- This function supports USB flash disks formatted using FAT32/16 on a single partition only.
- Ensure to load the BIOS default settings to ensure system compatibility and stability. Select the Load Optimized Defaults item under the Exit menu. .
- DO NOT shut down or reset the system while updating the BIOS to prevent system boot failure!



### 3.10.3 ASUS CrashFree BIOS 3 utility

The ASUS CrashFree BIOS 3 is an auto recovery tool that allows you to restore the BIOS file when it fails or gets corrupted during the updating process. You can restore a corrupted BIOS file using the motherboard support DVD or a USB flash drive that contains the updated BIOS file.



- 
- Before using this utility, rename the BIOS file in the removable device into **A88XPRO.CAP**.
  - The BIOS file in the support DVD may not be the latest version. Download the latest BIOS file from the ASUS website at [www.asus.com](http://www.asus.com).
- 

## Recovering the BIOS

### To recover the BIOS:

1. Turn on the system.
2. Insert the support DVD to the optical drive or the USB flash drive that contains the BIOS file to the USB port.
3. The utility automatically checks the devices for the BIOS file. When found, the utility reads the BIOS file and enters ASUS EZ Flash 2 utility automatically.
4. The system requires you to enter BIOS Setup to recover BIOS settings. To ensure system compatibility and stability, we recommend that you press <F5> to load default BIOS values.



---

DO NOT shut down or reset the system while updating the BIOS! Doing so can cause system boot failure!

---

### 3.10.4 ASUS BIOS Updater

The ASUS BIOS Updater allows you to update BIOS in a DOS environment. This utility also allows you to copy the current BIOS file that you can use as a backup when the BIOS fails or gets corrupted during the updating process.



---

The succeeding utility screens are for reference only. The actual utility screen displays may not be same as shown.

---

## Before updating BIOS

1. Prepare the motherboard support DVD and a USB flash drive formatted using FAT32/16 on a single partition.
2. Download the latest BIOS file and BIOS Updater from the ASUS website at <http://support.asus.com> and save them on the USB flash drive.



---

NTFS is not supported under a DOS environment. Do not save the BIOS file and BIOS Updater to a hard disk drive or USB flash drive in NTFS format.

---

3. Turn off the computer and disconnect all SATA hard disk drives (optional).

## Booting the system to a DOS environment

1. Insert the DOS-bootable USB flash drive with the latest BIOS file and BIOS Updater to your computer's USB port.
2. Boot your computer. When the ASUS Logo appears, press <F8> to show the **BIOS Boot Device Select Menu**.

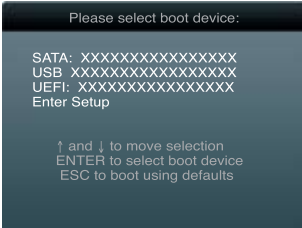

3. Select the USB flash drive as the boot device. The DOS screen appears.



## Updating the BIOS file

To update the BIOS file using BIOS Updater:

1. At the FreeDOS prompt, type `bupdater /pc /g` and press <Enter>.

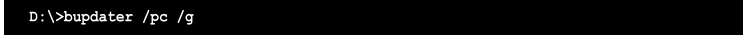

2. The BIOS Updater screen appears as below.

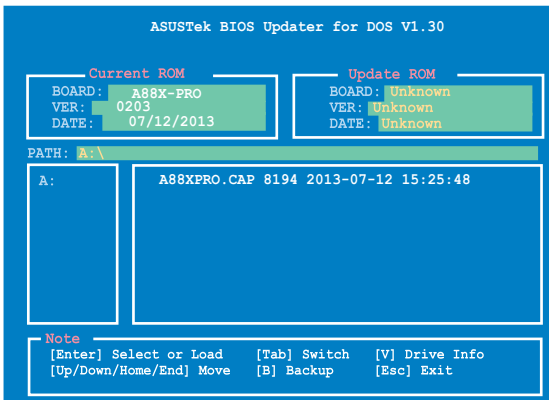

3. Press <Tab> to switch between screen fields and use the <Up/Down/Home/End> keys to select the BIOS file and press <Enter>. BIOS Updater checks the selected BIOS file and prompts you to confirm BIOS update.



4. Select Yes and press <Enter>. When BIOS update is done, press <ESC> to exit BIOS Updater. Restart your computer.



---

DO NOT shut down or reset the system while updating the BIOS to prevent system boot failure!

---



- 
- For BIOS Updater version 1.30 or later, the utility automatically exits to the DOS prompt after updating BIOS.
  - Ensure to load the BIOS default settings to ensure system compatibility and stability. Select the Load Optimized Defaults item under the Exit menu. Refer to section **3.9 Exit menu** for details.
  - Ensure to connect all SATA hard disk drives after updating the BIOS file if you have disconnected them.
-

# Chapter 4

## 4.1 Installing an operating system

This motherboard supports Windows® XP / Windows® 7 / 64-bit Windows® 7 / Windows® 8 / 64-bit Windows® 8 / Windows® 8.1 / 64-bit Windows® 8.1 operating systems (OS). Always install the latest OS version and corresponding updates to maximize the features of your hardware.



- Motherboard settings and hardware options vary. Use the setup procedures presented in this chapter for reference only. Refer to your OS documentation for detailed information.
- Ensure that you install the Windows® XP Service Pack 3 or Windows® 7 / 64-bit Windows® 7 / Windows® 8 / 64-bit Windows® 8 / Windows® 8.1 / 64-bit Windows® 8.1 operating systems (OS) before installing the drivers for better compatibility and system stability.

## 4.2 Support DVD information

The support DVD that comes with the motherboard package contains the drivers, software applications, and utilities that you can install to avail of all motherboard features.



The contents of the support DVD are subject to change at any time without notice. Visit the ASUS website at [www.asus.com](http://www.asus.com) for updates.

### 4.2.1 Running the support DVD

Place the support DVD into the optical drive. The DVD automatically displays the Drivers menu if Autorun is enabled in your computer. Click each menu tab and select the items you want to install.

The Drivers menu shows the available device drivers if the system detects installed devices. Install the necessary drivers to use the devices.

The Make Disk menu contains items to create the RAID/AHCI driver disk.

The Manual menu contains the list of supplementary user manuals. Click an item to open the folder of the user manual.

The Utilities menu shows the applications and other software that the motherboard supports.

Click an item to install

Click the Contact tab to display the ASUS contact information.

The Specials tab contains the unique features of ASUS motherboard

Click an icon to display DVD/motherboard information



If Autorun is NOT enabled in your computer, browse the contents of the support DVD to locate the file ASSETUP.EXE from the BIN folder. Double-click the ASSETUP.EXE to run the DVD.

## 4.2.2 Obtaining the software manuals

The software manuals are included in the support DVD. Follow the instructions below to get the necessary software manuals.



The software manual files are in Portable Document Format (PDF). Install the Adobe® Acrobat® Reader from the Utilities menu before opening the files.

1. Click the **Manual** tab. Click **ASUS Motherboard Utility Guide** from the manual list on the left.



2. The **Manual** folder of the support DVD appears. Double-click the folder of your selected software.

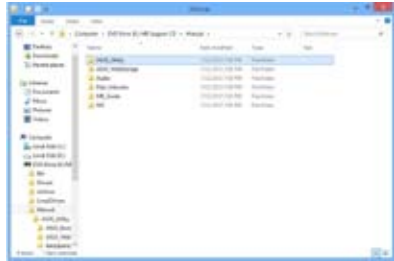

3. Some software manuals are provided in different languages. Double-click the language to show the software manual.

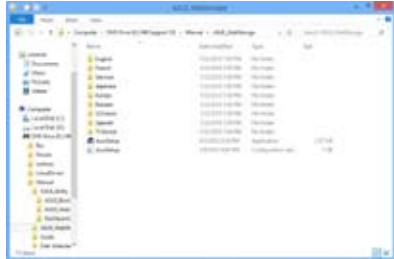

The screenshots in this section are for reference only. The actual software manuals in the support DVD vary between models.



## 4.3 Software information

Most of the applications in the support DVD have wizards that will conveniently guide you through the installation. View the online help or readme file that came with the software application for more information.

### 4.3.1 AI Suite 3

AI Suite 3 is an all-in-one interface that integrates several ASUS utilities and allows you to launch and operate these utilities simultaneously.

#### Installing AI Suite 3

**To install AI Suite 3 on your computer:**

1. Place the support DVD in the optical drive. The **Special** tab appears if your computer has enabled the Autorun feature.
2. Click **Utilities tab > AI Suite 3**.
3. Follow the onscreen instructions to complete the installation.
4. After AI Suite 3 is installed, restart your computer.

#### Using AI Suite 3

You can launch AI Suite 3 for the following Windows® operating systems:

- For Windows® 7, click  on the notification area.
- For Windows® 8, click the AI Suite 3 app from the Start Screen.

When launched, the main screen of the AI Suite 3 appears. To go to the AI Suite 3 main menu bar, click or tap  to launch the AI Suite 3 menu bar on the upper right corner of the menu.



---

The main screen of the AI Suite 3 is for reference only and varies with models.

---

## Main screen

Click to launch AI Suite 3 menu bar

Click to auto-detect the best settings based on actual usage

Select an advanced power saving mode

## AI Suite 3 main menu bar

Ai Charger+    EZ Update    System Information    USB Charger+

USB 3.0 Boost    Network iControl    USB BIOS Flashback    Remote GO!



- The screenshots of AI Suite 3 in this user manual are for reference only. The actual screenshots vary with models.
- Refer to the software manual in the support DVD or visit the ASUS website at [www.asus.com](http://www.asus.com) for detailed software configuration.

### 4.3.2 Dual Intelligent Processors 4

Dual Intelligent Processors 4 comes with these five utilities in one interface: 4-Way Optimization, TurboV Processing Unit (TPU), Energy Processing Unit (EPU), DIGI+ Power Control, and Fan Xpert 2.

#### 4-Way Optimization

The 4-Way Optimization utility allows you to automatically tweak the TPU, EPU, DIGI+ Power Control and Fan Xpert 2 to their optimal settings.



Click to auto-detect the best settings based on actual usage

Select an advanced power saving mode



DO NOT remove your fan during the tuning process.

### 4.3.3 Ai Charger+

Ai Charger+ allows you to fast-charge your portable BC 1.1\* mobile devices on your computer's USB port three times faster than the standard USB devices\*\*.

#### Launching Ai Charger+

To launch Ai Charger+, click or tap  on the top-right corner of the menu, then click **Ai Charger+** on the AI Suite 3 main menu bar.

#### Ai Charger+ screen



Tick to enable or  
disable Ai Charger+

Tick to apply the  
selection



- \* Check manufacturer specifications if your USB device complies with Battery Charging Specification 1.1 (BC 1.1).
- \*\* Actual charging speeds may vary depending on the charging rate and specifications of your USB device.
- To ensure normal charging function, disconnect and reconnect your USB device every time you enable or disable Ai Charger+.
- Ai Charger+ does not support USB hubs, USB extension cables, and generic USB cables.

### 4.3.4 EZ Update

EZ Update is a utility that automatically updates your motherboard's softwares, drivers and BIOS easily

With this utility, you can also manually update the BIOS and select the boot logo that will display during POST.

#### Launching EZ Update

To launch EZ Update, click or tap  on the top-right corner of the menu, then click **EZ Update** on the AI Suite 3 main menu bar.

#### EZ Update screen

Click to automatically update your motherboard's driver, software and firmware



Click to search and select the BIOS file

Click to select a boot logo

Click to update the BIOS

### 4.3.5 USB 3.0 Boost

USB 3.0 Boost technology supports UASP (USB Attached SCSI Protocol) and automatically speeds up the transfer rates of your USB storage devices.

#### Launching USB 3.0 Boost

To launch USB 3.0 Boost, click or tap  on the top-right corner of the menu, then click **USB 3.0 Boost** on the AI Suite 3 main menu bar.

#### Using the USB 3.0 Boost

1. Connect your USB 3.0 device to the USB 3.0 port.
2. From the USB 3.0 Boost screen, select a USB device.
3. To enable UASP on your USB device, click **UASP**. To revert to its normal transfer rate, click **Normal**.

#### USB 3.0 Boost screen



- Refer to the software manual in the support DVD or visit the ASUS website at [www.asus.com](http://www.asus.com) for detailed software configuration.
- Use USB 3.0 devices for better performance. Data transfer speed varies with USB devices.

### 4.3.6 Network iControl

Network iControl is a one-stop setup network control center that allows you to manage your network bandwidth and set the bandwidth priority for your running programs.

#### Launching Network iControl

To launch Network iControl, click or tap  on the top-right corner of the menu, then click **Network iControl** on the AI Suite 3 main menu bar.



- Ensure to install the LAN drivers before using this utility.
- Network iControl can only support the onboard LAN.
- Network iControl is only supported in Windows® 7 and later versions.

#### EZ Start screen

Click or tap to enable Network iControl

Click or tap to select a profile

Tick to set the current network program as the highest priority

Click or tap to apply the changes

#### EZ Profile screen

Click to select a network profile

Click to set the program as High, Normal, or Low priority

Select a program from this list and click to add to your network profile

Click to save the profile settings or rename the profile

Tick to assign a schedule of your network programs to avoid network congestions

### 4.3.7 USB Charger+

USB Charger+ allows you to quick-charge your portable USB devices even if your computer is off, in sleep mode or hibernate mode.

#### Launching USB Charger+

To launch USB Charger+, click or tap  on the top-right corner of the menu, then click **USB Charger+** on the AI Suite 3 main menu bar.

#### USB Charger+ screen

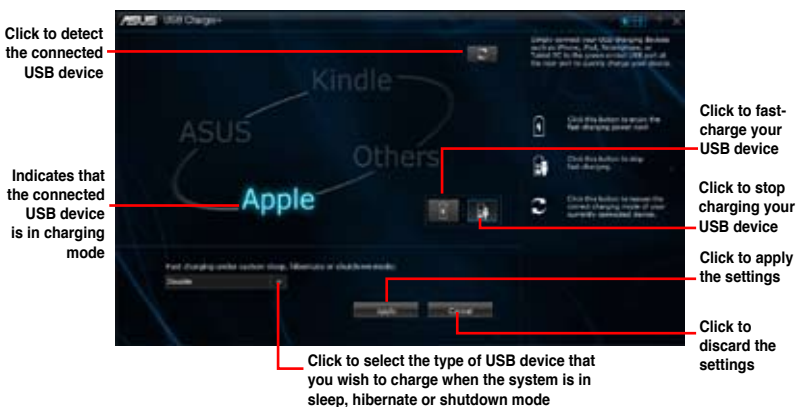

Ensure to connect your USB device into the USB port that supports this utility. Refer to section 2.3.10 **Rear panel connection** of your user manual for more details.



- USB Charger+ does not support USB hubs and USB extension cables, and generic USB cables.
- USB Charger+ may not recognize some ASUS devices due to a special design.
- USB Charger+ is only supported in Windows® 7 and later versions.



### 4.3.8 USB BIOS Flashback Wizard

USB BIOS Flashback Wizard allows you to check and save the latest BIOS version to a USB storage device. Use this utility to quickly check for the latest available BIOS and set the BIOS download schedule.

#### USB BIOS Flashback Wizard screen

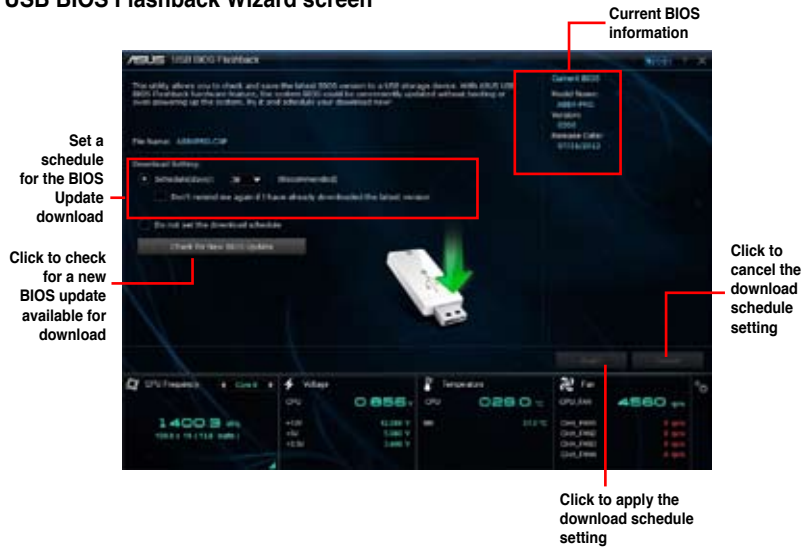

#### Scheduling the BIOS download

1. In the Download Setting field, tick **Schedule (days)** then select the number of days for the BIOS download schedule.
2. Click **Apply** to save the BIOS download schedule. Click **Cancel** to cancel the download schedule.

#### Downloading the updated BIOS



Before you start downloading, ensure that you have installed the USB storage device to your computer's USB port that supports USB BIOS Flashback. Refer to section **2.3.10 Rear panel connection** of your user manual for more details.

To download the updated BIOS:

1. From the USB BIOS Flashback screen, click **Check for New BIOS Update**.  
Wait for the system to check the latest BIOS version.

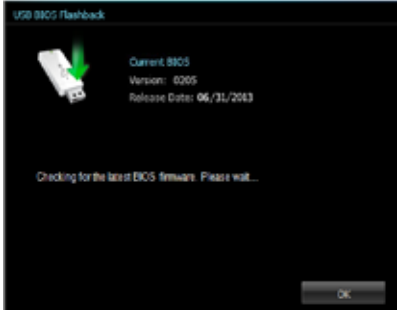

2. After the utility detects a new BIOS, click **Download** from the Save to: field, select the USB flash drive, then click **Download**.

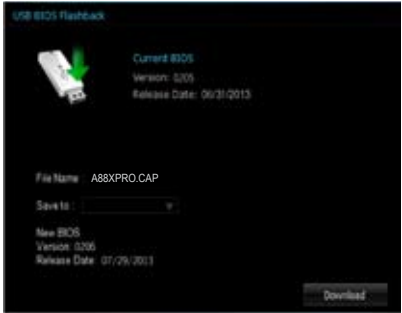

3. After the download is complete, click **OK**.



### 4.3.9 System Information

This utility allows you to get detailed information of the motherboard, CPU, and memory settings.

#### Launching System Information

To launch System Information, click or tap  on the top-right corner of the menu, then click **System Information** on the AI Suite 3 main menu bar.

#### Viewing the motherboard information

From the System Information screen, click the **MB** tab to view the motherboard's information.



#### Viewing the CPU information

From the System Information screen, click the **CPU** tab to view the processor's information.



## Viewing the SPD information

From the System Information screen, click the **SPD** tab to view the memory's information.



### 4.3.10 Audio configurations

The Realtek® audio CODEC provides 8-channel audio capability to deliver the ultimate audio experience on your computer. The software provides Jack-Sensing function, S/PDIF Out support and interrupt capability. The CODEC also includes the Realtek® proprietary UAJ® (Universal Audio Jack) technology for all audio ports, eliminating cable connection errors and giving users plug and play convenience.

Follow the installation wizard to install the Realtek® Audio Driver from the support DVD that came with the motherboard package.

If the Realtek® audio software is correctly installed, you will find the Realtek® HD Audio Manager icon on the taskbar. Double-click on the icon to display the Realtek® HD Audio Manager.

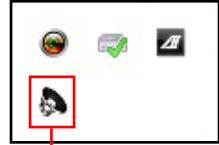

Realtek® HD Audio Manager

### Realtek® HD Audio Manager for Windows® 7/ Windows® 8



## 4.4 RAID configurations

The motherboard comes with the AMD® A88X chipset that allows you to configure Serial ATA hard disk drives as RAID sets. The motherboard supports the following RAID configurations: RAID 0, RAID 1, RAID 5, and RAID 10.



- You must install Windows® XP Service Pack 3 or Windows® Vista / 64-bit Vista / 7 / 64-bit 7 / 8 / 64-bit 8 / 8.1 / 64-bit 8.1 operating systems (OS) before using Serial ATA hard disk drives. The Serial ATA RAID feature is available only if you are using Windows® XP SP3 or Windows® Vista / 64-bit Vista / 7 / 64-bit 7 / 8 / 64-bit 8 / 8.1 / 64-bit 8.1 operating systems (OS) .
- Due to Windows® XP limitations, a RAID array with the total capacity over 2TB cannot be set as a boot disk. A RAID array over 2TB can only be set as a data disk.
- If you want to install a Windows® operating system to a hard disk drive included in a RAID set, you have to create a RAID driver disk and load the RAID driver during OS installation. Refer to section 4.5 **Creating a RAID driver disk** for details.

### 4.4.1 RAID definitions

**RAID 0 (Data striping)** optimizes two identical hard disk drives to read and write data in parallel, interleaved stacks. Two hard disks perform the same work as a single drive but at a sustained data transfer rate, double that of a single disk alone, thus improving data access and storage. Use of two new identical hard disk drives is required for this setup.

**RAID 1 (Data mirroring)** copies and maintains an identical image of data from one drive to a second drive. If one drive fails, the disk array management software directs all applications to the surviving drive as it contains a complete copy of the data in the other drive. This RAID configuration provides data protection and increases fault tolerance to the entire system. Use two new drives or use an existing drive and a new drive for this setup. The new drive must be of the same size or larger than the existing drive.

**RAID 5** stripes both data and parity information across three or more hard disk drives. Among the advantages of RAID 5 configuration include better HDD performance, fault tolerance, and higher storage capacity. The RAID 5 configuration is best suited for transaction processing, relational database applications, enterprise resource planning, and other business systems. Use a minimum of three identical hard disk drives for this setup.

**RAID 10** is data striping and data mirroring combined without parity (redundancy data) having to be calculated and written. With the RAID 10 configuration you get all the benefits of both RAID 0 and RAID 1 configurations. Use four new hard disk drives or use an existing drive and three new drives for this setup.

## 4.4.2 Installing Serial ATA hard disks

The motherboard supports Serial ATA hard disk drives. For optimal performance, install identical drives of the same model and capacity when creating a disk array.

To install the SATA hard disks for a RAID configuration:

1. Install the SATA hard disks into the drive bays.
2. Connect the SATA signal cables.
3. Connect a SATA power cable to the power connector on each drive.

## 4.4.3 Setting the RAID item in BIOS

You must enable the RAID function in the BIOS Setup before creating RAID set(s) using SATA HDDs. To do this:

1. Enter the BIOS Setup during POST.
2. Go to the **Advanced** menu > **SATA Configuration**, and then press <Enter>.
3. Set the type of the SATA connectors to **[RAID]**.
4. Save your changes, and then exit the BIOS Setup.



---

See section **3.5.2 SATA Configuration** for details.

---

## 4.4.4 AMD® Option ROM Utility

To enter the AMD® Option ROM utility:

1. Boot up your computer.
2. During POST, press <Ctrl> + <F> to display the utility main menu.

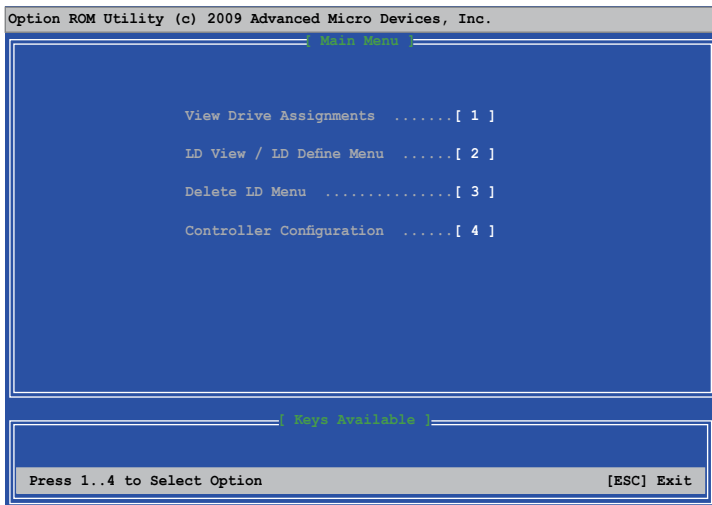

The Main Menu allows you to select an operation to perform. The Main Menu options include:

- **View Drive Assignments:** shows the status of the hard disk drives.
- **LD View / LD Define Menu:** displays the existing RAID set information / creates a RAID 0, RAID 1, or RAID 10 configuration.
- **Delete LD Menu:** deletes a selected RAID set and partition.
- **Controller Configuration:** shows the system resources configuration.

Press <1>, <2>, <3>, or <4> to enter the option you need; press <ESC> to exit the utility.



---

The RAID BIOS setup screens shown in this section are for reference only, and may not exactly match the items on your screen.

---



---

To create a RAID volume using more than four hard disk drives, ensure that the SATA connectors 5/6 are set to [RAID] mode.

---



## Creating a RAID volume

To create a RAID volume:

1. In the Main Menu, press <2> to enter the **LD View / LD Define Menu** function.
2. Press <Ctrl> + <C>, and the following screen appears.

```
Option ROM Utility (c) 2009 Advanced Micro Devices, Inc.
| LD Define Menu |
+-----+
| LD No  LD Name          RAID Mode  Drv  |
| LD 1   Logical Drive 1   RAID 0    2   |
| Strip Block      64 KB      Fast Init  ON  |
| Gigabyte Boundary ON      Cache Mode  WriteThru |
+-----+
| Drives Assignments |
+-----+
| Port:ID  Drive Model  Capabilities  Capacity (GB)  Assignment |
| 01:00  XXXXXXXXXXXX  XXXXXXXX    XXXXXX        Y   |
| 02:00  XXXXXXXXXXXX  XXXXXXXX    XXXXXX        Y   |
| 03:00  XXXXXXXXXXXX  XXXXXXXX    XXXXXX        N   |
| 04:00  XXXXXXXXXXXX  XXXXXXXX    XXXXXX        N   |
+-----+
| Keys Available |
+-----+
| [F1] Up  [F2] Down  [PaUp/PaDn] Switch page  [Space] Change Option |
| [Ctrl-Y] Save  [ESC] Exit |
+-----+
```

3. Move to the **RAID Mode** item and press <Space> to select a RAID mode to create.
4. Move to the **Assignment** item by using the down arrow key and set **Y** to select the hard disk drives you want to include in the RAID set.
5. Press <Ctrl> + <Y> to save the setting.
6. The utility prompts the following message. Press <Ctrl> + <Y> to input the LD name.

```
Please press Ctrl-Y key to input the LD Name
or press any key to exit.
If you do not input any LD name, the default LD
name will be used.
```

7. Enter an LD name, and then press any key to continue.

```
Enter the LD name here:
```

8. Press <Ctrl> + <Y> to erase the MBR, or you may press any key to abort the settings.

```
Fast Initialization Option has been selected
It will erase the MBR data of the disks.
<Press Ctrl-Y Key if you are sure to erase it>
<Press any other key to ignore this option>
```

9. Press <Ctrl> + <Y> to enter the screen to modify the array capacity, or press any key to use the maximum capacity.

## Deleting a RAID configuration



Take caution when deleting a RAID volume. You will lose all data on the hard disk drives when you delete a RAID volume.

### To delete a RAID volume:

1. In the Main Menu, press <3> to enter the **Delete LD** function.
2. Select the RAID item you want to delete and press <Del> or <Alt> + <D>.

```
Option ROM Utility (c) 2009 Advanced Micro Devices, Inc.
[Delete LD Menu]
+-----+
| LD No  RAID Mode  Drv  Capacity(GB)  Status |
+-----+
| LD 1    RAID 0    2    xxxxxx    Functional |
+-----+
|                                     |
|                                     |
|                                     |
|                                     |
|                                     |
|                                     |
|                                     |
|                                     |
|                                     |
|                                     |
+-----+
[Keys Available]
[↑] Up [↓] Down [PaUp/PaDn] Switch page [Del/Alt+D] Delete LD
```

3. The utility prompts the following messages:

```
Press Ctrl-Y to delete the data in the disk!
or press any other key to abort...
```

Press <Ctrl> + <Y> to delete the RAID volume.

## Displaying a RAID set information

### To display a RAID set information:

1. In the Main Menu, press <2> to enter the “LD View / LD Define Menu” function.
2. Select a RAID item and press <Enter> to display its information.

```
Option ROM Utility (c) 2009 Advanced Micro Devices, Inc.
[View LD Definition Menu]
+-----+
| LD No  LD Name  RAID Mode  Drv  Capacity(GB) |
+-----+
| LD 1    xxxxxx  RAID 0    2    157.99       |
+-----+
| Strip Block 64 KB  Cache Mode WriteThru |
+-----+
| Drive Information |
+-----+
| Port:ID  Drive Model  Capabilities  Capacity(GB) |
+-----+
| 01:00  xxxxxxxxxxxx  xxxxxxxx    xxxxxx      |
| 02:00  xxxxxxxxxxxx  xxxxxxxx    xxxxxx      |
+-----+
|                                     |
|                                     |
|                                     |
|                                     |
|                                     |
|                                     |
|                                     |
|                                     |
|                                     |
|                                     |
+-----+
| Any Key To Continue..... |
+-----+
```

## 4.5 Creating a RAID driver disk

A floppy disk with the RAID driver is required when installing a Windows® operating system on a hard disk drive that is included in a RAID set.



- **The motherboard does not provide a floppy drive connector.** You have to use a USB floppy disk drive when creating a **SATA** RAID driver disk.
- Windows® XP may not recognize the USB floppy disk drive due to Windows® XP limitation.

### 4.5.1 Creating a RAID driver disk without entering the OS

To create a RAID driver disk without entering the OS:

1. Boot your computer.
2. Press <Del> during POST to enter the BIOS setup utility.
3. Set the optical drive as the primary boot device.
4. Insert the support DVD into the optical drive.
5. Save changes and exit BIOS.
6. When the **Make Disk** menu appears, press <1> to create a RAID driver disk.
7. Insert a formatted floppy disk into the USB floppy disk drive, then press <Enter>.
8. Follow the succeeding screen instructions to complete the process.

### 4.5.2 Creating a RAID driver disk in Windows®

To create a RAID driver disk in Windows®:

1. Start Windows®.
2. Plug the USB floppy disk drive and insert a floppy disk.
3. Place the motherboard support DVD into the optical drive.
4. Go to the **Make Disk** menu, and then click **AMD AHCI/RAID Driver Disk** to create a RAID driver disk.
5. Select USB floppy disk drive as the destination disk.
6. Follow the succeeding screen instructions to complete the process.



Write-protect the floppy disk to avoid a computer virus infection.

### 4.5.3 Installing the RAID driver during Windows® OS installation

To install the RAID driver in Windows® XP:

1. During the OS installation, the system prompts you to press the F6 key to install third-party SCSI or RAID driver.
2. Press <F6>, and then insert the floppy disk with RAID driver into the USB floppy disk drive.
3. When prompted to select the SCSI adapter to install, select the RAID driver for the corresponding OS version.
4. Follow the succeeding screen instructions to complete the installation.

To install the RAID driver for Windows® Vista or later OS:

1. During the OS installation, click **Load Driver** to allow you to select the installation media containing the RAID driver.
2. Insert the USB flash drive with RAID driver into the USB port or the support DVD into the optical drive, and then click **Browse**.
3. Click the name of the device you've inserted, go to **Drivers > RAID**, and then select the RAID driver for the corresponding OS version. Click **OK**.
4. Follow the succeeding screen instructions to complete the installation.



---

Before loading the RAID driver from a USB flash drive, you have to use another computer to copy the RAID driver from the support DVD to the USB flash drive.

---

# Chapter 5

## 5.1 AMD® CrossFireX™ technology

The motherboard supports the AMD® CrossFireX™ technology that allows you to install multi-graphics processing units (GPU) graphics cards. Follow the installation procedures in this section.

### 5.1.1 Requirements

- In Dual CrossFireX mode, you should have two identical CrossFireX-ready graphics cards or one CrossFireX-ready dual-GPU graphics card that are AMD® certified.
- Ensure that your graphics card driver supports the AMD CrossFireX technology. Download the latest driver from the AMD website ([www.amd.com](http://www.amd.com)).
- Ensure that your power supply unit (PSU) can provide at least the minimum power required by your system. See Chapter 2 for details.



- 
- We recommend that you install additional chassis fans for better thermal environment.
  - Visit the AMD Game website (<http://game.amd.com>) for the latest certified graphics card and the supported 3D application list.
- 

### 5.1.2 Before you begin

For AMD CrossFireX to work properly, you have to uninstall all existing graphics card drivers before installing AMD CrossFireX graphics cards to your system.

To uninstall existing graphics card drivers:

1. Close all current applications.
2. For Windows® XP, go to **Control Panel > Add/Remove Programs**.  
For Windows® 8.1 / Windows® 8 / Windows® 7 / Vista, go to **Control Panel > Programs and Features**.
3. Select your current graphics card driver/s.
4. For Windows® XP, select **Add/Remove**.  
For Windows® 8.1 / Windows® 8 / Windows® 7 / Vista, select **Uninstall**.
5. Turn off your computer.

### 5.1.3 Installing two CrossFireX™ graphics cards



The following pictures are for reference only. The graphics cards and the motherboard layout may vary with models, but the installation steps remain the same.

1. Prepare two CrossFireX-ready graphics cards.
2. Insert the two graphics card into the PCIEX16 slots. If your motherboard has more than two PCIEX16 slots, refer to Chapter 2 in this user manual for the locations of the PCIEX16 slots recommended for multi-graphics card installation.
3. Ensure that the cards are properly seated on the slots.
4. Align and firmly insert the CrossFireX bridge connector to the goldfingers on each graphics card. Ensure that the connector is firmly in place.

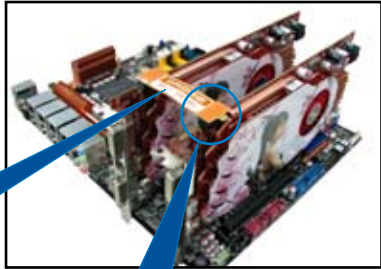
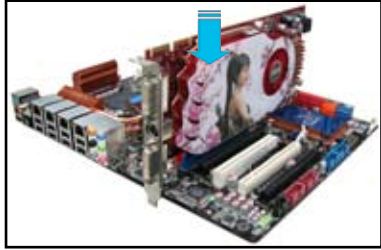

CrossFireX bridge  
(bundled with  
graphics cards)

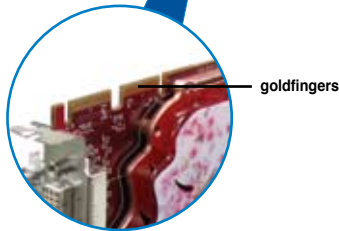

5. Connect two independent auxiliary power sources from the power supply to the two graphics cards separately.
6. Connect a VGA or a DVI cable to the graphics card.

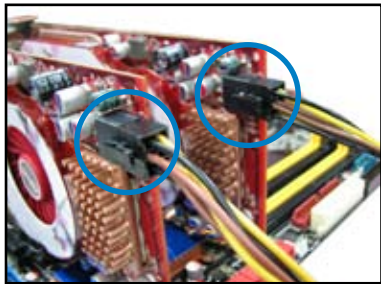

### 5.1.4 Installing the device drivers

Refer to the documentation that came with your graphics card package to install the device drivers.



Ensure that your PCI Express graphics card driver supports the AMD® CrossFireX™ technology. Download the latest driver from the AMD website ([www.amd.com](http://www.amd.com)).

### 5.1.5 Enabling the AMD® CrossFireX™ technology

After installing your graphics cards and the device drivers, enable the CrossFireX™ feature through the AMD VISION Engine Control Center in Windows environment.

#### Launching the AMD VISION Engine Control Center

To launch the AMD VISION Engine Control Center:

Right-click on the Windows® desktop and select **AMD VISION Engine Control Center**.

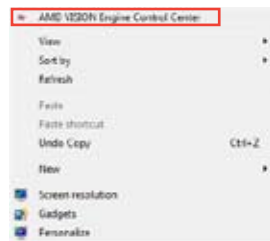

## Enabling Dual CrossFireX technology

1. In the AMD VISION Engine Control Center window, click **Performance > AMD CrossFireX™**.
2. Select **Enable CrossFireX™**.
3. Select a GPU combination from the drop-down list.
4. Click **Apply** to save and activate the GPU settings made.

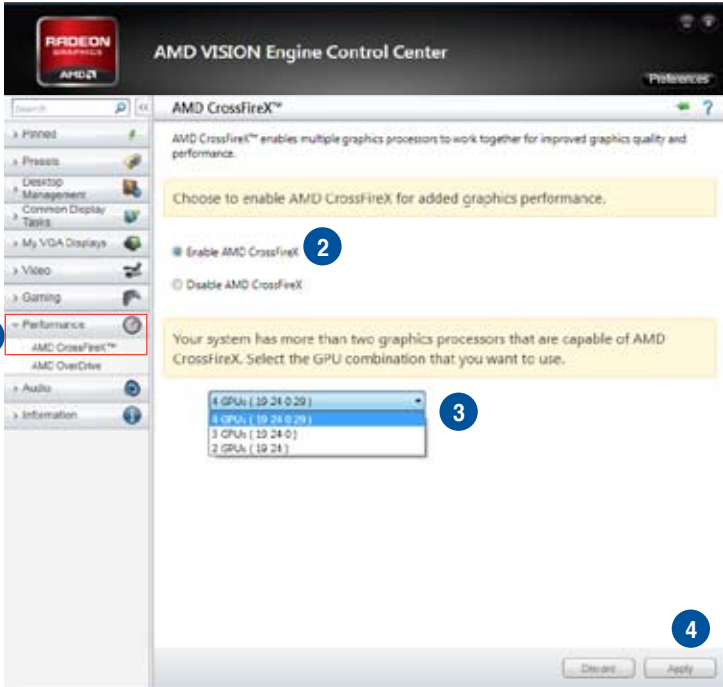



## 5.2 AMD® Dual Graphics technology

The motherboard supports the AMD® Dual Graphics technology that allows you to install multi-graphics processing units (GPU) CrossFireX cards.

### 5.2.1 System requirements

Before using AMD Dual Graphics, ensure that your system meets the following basic requirements:

- Operating System: Windows® 7 or later versions
- Memory capacity: Minimum 2GB
- APU: A-Series
- One graphics card with Dual Graphics support



---

Visit the AMD website for the latest graphics card support list.

---

### 5.2.2 Before you proceed

Configure the BIOS settings for the graphics card to support AMD Dual Graphics.

#### To set Internal Graphics:

1. Press **<Del>** during the Power-On-Self-Test (POST) to enter the BIOS Setup utility.
2. Go to **Advanced > NB configuration > IGFX Multi-Monitor**, set **IGFX Multi-Monitor** to **[Enabled]**.
3. Press **<F10>** to save the changes and exit BIOS settings. Select **OK** to confirm.

### 5.2.3 Installing AMD Graphics Driver

#### To install the driver that supports Dual Graphics technology:

1. Insert the Support DVD that comes with your motherboard into the optical drive. The DVD automatically displays the Specials menu if Autorun is enabled on your computer.



---

If Autorun is NOT enabled in your computer, browse the contents of the support DVD to locate the file ASSETUP.EXE from the BIN folder. Double-click the ASSETUP.EXE to run the DVD.

---

2. From the Drivers menu, click **AMD Graphics Driver** to install it. Follow the onscreen instructions to finish the installation.
3. Restart your computer after the installation is completed.
4. When the system restarts, wait for a few seconds for the driver to load automatically.

## 5.2.4 Using the AMD® VISION Engine Control Center

Install a graphics card onto your motherboard. Refer to the User Guide that comes with your graphics card for details. The add-on graphics card is set to be the main monitor as default.



If you are using both an add-on and the on-board graphics cards at the same time and want to set the onboard graphics card as your main monitor, follow the instructions below.

1. Right-click on the Windows® desktop and select **AMD VISION Engine Control Center**.
2. In the AMD VISION Engine Control Center window, click **Performance > AMD Radeon™ Dual Graphics**, then select **Disable AMD Radeon Dual Graphics**. Click **Apply**.



3. From the next screen, select the desktop you want to configure from the drop-down list. Click **Apply**.



4. Click **Performance > AMD Radeon™ Dual Graphics**, then select **Enable AMD Radeon Dual Graphics**. Click **Apply**. The onboard graphics card is set to be the main monitor.

## Notices

### Federal Communications Commission Statement

This device complies with Part 15 of the FCC Rules. Operation is subject to the following two conditions:

- This device may not cause harmful interference.
- This device must accept any interference received including interference that may cause undesired operation.

This equipment has been tested and found to comply with the limits for a Class B digital device, pursuant to Part 15 of the FCC Rules. These limits are designed to provide reasonable protection against harmful interference in a residential installation. This equipment generates, uses and can radiate radio frequency energy and, if not installed and used in accordance with manufacturer's instructions, may cause harmful interference to radio communications. However, there is no guarantee that interference will not occur in a particular installation. If this equipment does cause harmful interference to radio or television reception, which can be determined by turning the equipment off and on, the user is encouraged to try to correct the interference by one or more of the following measures:

- Reorient or relocate the receiving antenna.
- Increase the separation between the equipment and receiver.
- Connect the equipment to an outlet on a circuit different from that to which the receiver is connected.
- Consult the dealer or an experienced radio/TV technician for help.



---

The use of shielded cables for connection of the monitor to the graphics card is required to assure compliance with FCC regulations. Changes or modifications to this unit not expressly approved by the party responsible for compliance could void the user's authority to operate this equipment.

---

### IC: Canadian Compliance Statement

Complies with the Canadian ICES-003 Class B specifications. This device complies with RSS 210 of Industry Canada. This Class B device meets all the requirements of the Canadian interference-causing equipment regulations.

This device complies with Industry Canada license exempt RSS standard(s). Operation is subject to the following two conditions: (1) this device may not cause interference, and (2) this device must accept any interference, including interference that may cause undesired operation of the device.

Cet appareil numérique de la Classe B est conforme à la norme NMB-003 du Canada.  
Cet appareil numérique de la Classe B respecte toutes les exigences du Règlement sur le matériel brouilleur du Canada.

Cet appareil est conforme aux normes CNR exemptes de licence d'Industrie Canada. Le fonctionnement est soumis aux deux conditions suivantes :

- (1) cet appareil ne doit pas provoquer d'interférences et
- (2) cet appareil doit accepter toute interférence, y compris celles susceptibles de provoquer un fonctionnement non souhaité de l'appareil.

## Canadian Department of Communications Statement

This digital apparatus does not exceed the Class B limits for radio noise emissions from digital apparatus set out in the Radio Interference Regulations of the Canadian Department of Communications.

This class B digital apparatus complies with Canadian ICES-003.

## VCCI: Japan Compliance Statement

### VCCI Class B Statement

情報処理装置等電波障害自主規制について

この装置は、情報処理装置等電波障害自主規制協議会（VCCI）の基準に基づくクラスB情報技術装置です。この装置は家庭環境で使用することを目的としていますが、この装置がラジオやテレビジョン受信機に近接して使用されると、受信障害を引き起こすことがあります。

取扱説明書に従って正しい取り扱いをして下さい。

## KC: Korea Warning Statement

B급 기기 (가정용 방송통신기자재)

이 기기는 가정용(B급) 전자파적합기기로서 주로 가정에서 사용하는 것을 목적으로 하며, 모든 지역에서 사용할 수 있습니다.

\*당해 무선설비는 전파혼신 가능성이 있으므로 인명안전과 관련된 서비스는 할 수 없습니다.

## REACH

Complying with the REACH (Registration, Evaluation, Authorisation, and Restriction of Chemicals) regulatory framework, we published the chemical substances in our products at ASUS REACH website at <http://csr.asus.com/english/REACH.htm>.



**DO NOT** throw the motherboard in municipal waste. This product has been designed to enable proper reuse of parts and recycling. This symbol of the crossed out wheeled bin indicates that the product (electrical and electronic equipment) should not be placed in municipal waste. Check local regulations for disposal of electronic products.



**DO NOT** throw the mercury-containing button cell battery in municipal waste. This symbol of the crossed out wheeled bin indicates that the battery should not be placed in municipal waste.

## ASUS Recycling/Takeback Services

ASUS recycling and takeback programs come from our commitment to the highest standards for protecting our environment. We believe in providing solutions for you to be able to responsibly recycle our products, batteries, other components as well as the packaging materials. Please go to <http://csr.asus.com/english/Takeback.htm> for the detailed recycling information in different regions.

## **ASUS contact information**

### **ASUSTeK COMPUTER INC.**

Address 15 Li-Te Road, Peitou, Taipei, Taiwan 11259  
Telephone +886-2-2894-3447  
Fax +886-2-2890-7798  
E-mail [info@asus.com.tw](mailto:info@asus.com.tw)  
Web site <http://www.asus.com>

#### ***Technical Support***

Telephone +86-21-3842-9911  
Fax +86-21-5866-8722 ext. 9101#  
Online support <http://support.asus.com/techserv/techserv.aspx>

### **ASUS COMPUTER INTERNATIONAL (America)**

Address 800 Corporate Way, Fremont, CA 94539, USA  
Telephone +1-510-739-3777  
Fax +1-510-608-4555  
Web site <http://usa.asus.com>

#### ***Technical Support***

Support fax +1-812-284-0883  
General support +1-812-282-2787  
Online support <http://support.asus.com/techserv/techserv.aspx>

### **ASUS COMPUTER GmbH (Germany and Austria)**

Address Harkort Str. 21-23, D-40880 Ratingen, Germany  
Fax +49-2102-959931  
Web site <http://www.asus.com/de>  
Online contact <http://eu-rma.asus.com/sales>

#### ***Technical Support***

Telephone +49-2102-5789555  
Support Fax +49-2102-959911  
Online support <http://support.asus.com/techserv/techserv.aspx>



# EC Declaration of Conformity

We, the undersigned,

Manufacturer: ASUSTeK COMPUTER INC.  
 Address, City: 4F, No. 150, LITE Rd., PEITOU, TAIPEI 112, TAIWAN  
 Country: TAIWAN  
 Authorized representative in Europe: ASUS COMPUTER GmbH  
 Address, City: HARKORT STR. 21-23, 40880 RATINGEN  
 Country: GERMANY

declare the following apparatus:

Product name : Motherboard  
 Model name : A88X-PRO

conform with the essential requirements of the following directives:

- EN 55022:2010
- EN 55024:2010
- EN 55013:2011/A1:2003/A2:2006
- EN 55020:2007/A1:2011
- 1989/EC-R&TTE Directive
  - EN 300 328 V1.7 (12006-10)
  - EN 300 440-1 V1.6 (12010-08)
  - EN 300 440-2 V1.6 (12010-08)
  - EN 301 908-1 V1.5 (12014-05)
  - EN 301 908-2 V1.5 (12014-05)
  - EN 301 908-3 V1.5 (12014-05)
  - EN 301 908-4 V1.5 (12014-05)
  - EN 301 908-5 V1.5 (12014-05)
  - EN 301 908-6 V1.5 (12014-05)
  - EN 301 908-7 V1.5 (12014-05)
  - EN 301 908-8 V1.5 (12014-05)
  - EN 301 908-9 V1.5 (12014-05)
  - EN 301 908-10 V1.5 (12014-05)
  - EN 301 908-11 V1.5 (12014-05)
  - EN 301 908-12 V1.5 (12014-05)
  - EN 301 908-13 V1.5 (12014-05)
  - EN 301 908-14 V1.5 (12014-05)
  - EN 301 908-15 V1.5 (12014-05)
  - EN 301 908-16 V1.5 (12014-05)
  - EN 301 908-17 V2.1 (12006-06)
  - EN 301 908-18 V2.1 (12006-06)
  - EN 301 908-19 V2.1 (12006-06)
  - EN 301 908-20 V2.1 (12006-06)
  - EN 301 908-21 V2.1 (12006-06)
  - EN 301 908-22 V2.1 (12006-06)
  - EN 301 908-23 V2.1 (12006-06)
  - EN 301 908-24 V2.1 (12006-06)
  - EN 301 908-25 V2.1 (12006-06)
  - EN 301 908-26 V2.1 (12006-06)
  - EN 301 908-27 V2.1 (12006-06)
  - EN 301 908-28 V2.1 (12006-06)
  - EN 301 908-29 V2.1 (12006-06)
  - EN 301 908-30 V2.1 (12006-06)
  - EN 301 908-31 V2.1 (12006-06)
  - EN 301 908-32 V2.1 (12006-06)
  - EN 301 908-33 V2.1 (12006-06)
  - EN 301 908-34 V2.1 (12006-06)
  - EN 301 908-35 V2.1 (12006-06)
  - EN 301 908-36 V2.1 (12006-06)
  - EN 301 908-37 V2.1 (12006-06)
  - EN 301 908-38 V2.1 (12006-06)
  - EN 301 908-39 V2.1 (12006-06)
  - EN 301 908-40 V2.1 (12006-06)
  - EN 301 908-41 V2.1 (12006-06)
  - EN 301 908-42 V2.1 (12006-06)
  - EN 301 908-43 V2.1 (12006-06)
  - EN 301 908-44 V2.1 (12006-06)
  - EN 301 908-45 V2.1 (12006-06)
  - EN 301 908-46 V2.1 (12006-06)
  - EN 301 908-47 V2.1 (12006-06)
  - EN 301 908-48 V2.1 (12006-06)
  - EN 301 908-49 V2.1 (12006-06)
  - EN 301 908-50 V2.1 (12006-06)
  - EN 301 908-51 V2.1 (12006-06)
  - EN 301 908-52 V2.1 (12006-06)
  - EN 301 908-53 V2.1 (12006-06)
  - EN 301 908-54 V2.1 (12006-06)
  - EN 301 908-55 V2.1 (12006-06)
  - EN 301 908-56 V2.1 (12006-06)
  - EN 301 908-57 V2.1 (12006-06)
  - EN 301 908-58 V2.1 (12006-06)
  - EN 301 908-59 V2.1 (12006-06)
  - EN 301 908-60 V2.1 (12006-06)
  - EN 301 908-61 V2.1 (12006-06)
  - EN 301 908-62 V2.1 (12006-06)
  - EN 301 908-63 V2.1 (12006-06)
  - EN 301 908-64 V2.1 (12006-06)
  - EN 301 908-65 V2.1 (12006-06)
  - EN 301 908-66 V2.1 (12006-06)
  - EN 301 908-67 V2.1 (12006-06)
  - EN 301 908-68 V2.1 (12006-06)
  - EN 301 908-69 V2.1 (12006-06)
  - EN 301 908-70 V2.1 (12006-06)
  - EN 301 908-71 V2.1 (12006-06)
  - EN 301 908-72 V2.1 (12006-06)
  - EN 301 908-73 V2.1 (12006-06)
  - EN 301 908-74 V2.1 (12006-06)
  - EN 301 908-75 V2.1 (12006-06)
  - EN 301 908-76 V2.1 (12006-06)
  - EN 301 908-77 V2.1 (12006-06)
  - EN 301 908-78 V2.1 (12006-06)
  - EN 301 908-79 V2.1 (12006-06)
  - EN 301 908-80 V2.1 (12006-06)
  - EN 301 908-81 V2.1 (12006-06)
  - EN 301 908-82 V2.1 (12006-06)
  - EN 301 908-83 V2.1 (12006-06)
  - EN 301 908-84 V2.1 (12006-06)
  - EN 301 908-85 V2.1 (12006-06)
  - EN 301 908-86 V2.1 (12006-06)
  - EN 301 908-87 V2.1 (12006-06)
  - EN 301 908-88 V2.1 (12006-06)
  - EN 301 908-89 V2.1 (12006-06)
  - EN 301 908-90 V2.1 (12006-06)
  - EN 301 908-91 V2.1 (12006-06)
  - EN 301 908-92 V2.1 (12006-06)
  - EN 301 908-93 V2.1 (12006-06)
  - EN 301 908-94 V2.1 (12006-06)
  - EN 301 908-95 V2.1 (12006-06)
  - EN 301 908-96 V2.1 (12006-06)
  - EN 301 908-97 V2.1 (12006-06)
  - EN 301 908-98 V2.1 (12006-06)
  - EN 301 908-99 V2.1 (12006-06)
  - EN 301 908-100 V2.1 (12006-06)
- 2006/95/EC-LVD Directive
  - EN 60950-1 /A12:2011
- 2009/125/EC-EPP Directive
  - Regulation (EC) No. 1275/2008
  - Regulation (EC) No. 642/2009

Ver. 13/2008



(EC conformity marking)

Position : CEO  
Name : Jerry Shen



Declaration Date: 19/08/2013  
Year to begin affixing CE marking: 2013

Signature : \_\_\_\_\_

# DECLARATION OF CONFORMITY

Per FCC Part 2, Section 2.1077(a)



Responsible Party Name: **Asus Computer International**  
Address: **800 Corporate Way, Fremont, CA 94539.**

Phone/Fax No: **(510)739-3777/(510)608-4555**

hereby declares that the product

**Product Name : Motherboard**  
**Model Number : A88X-PRO**

Conforms to the following specifications:

- FCC Part 15, Subpart B, Unintentional Radiators

### Supplementary Information:

This device complies with part 15 of the FCC Rules. Operation is subject to the following two conditions: (1) This device may not cause harmful interference, and (2) this device must accept any interference received, including interference that may cause undesired operation.

Representative Person's Name : **Steve Chang / President**



Signature : \_\_\_\_\_  
Date : **Aug. 19, 2013**

Ver. 12/06/01