

F2A85-M LE



Motherboard

Copyright © 2013 ASUSTeK COMPUTER INC. All Rights Reserved.

No part of this manual, including the products and software described in it, may be reproduced, transmitted, transcribed, stored in a retrieval system, or translated into any language in any form or by any means, except documentation kept by the purchaser for backup purposes, without the express written permission of ASUSTeK COMPUTER INC. ("ASUS").

Product warranty or service will not be extended if: (1) the product is repaired, modified or altered, unless such repair, modification of alteration is authorized in writing by ASUS; or (2) the serial number of the product is defaced or missing.

ASUS PROVIDES THIS MANUAL "AS IS" WITHOUT WARRANTY OF ANY KIND, EITHER EXPRESS OR IMPLIED, INCLUDING BUT NOT LIMITED TO THE IMPLIED WARRANTIES OR CONDITIONS OF MERCHANTABILITY OR FITNESS FOR A PARTICULAR PURPOSE. IN NO EVENT SHALL ASUS, ITS DIRECTORS, OFFICERS, EMPLOYEES OR AGENTS BE LIABLE FOR ANY INDIRECT, SPECIAL, INCIDENTAL, OR CONSEQUENTIAL DAMAGES (INCLUDING DAMAGES FOR LOSS OF PROFITS, LOSS OF BUSINESS, LOSS OF USE OR DATA, INTERRUPTION OF BUSINESS AND THE LIKE), EVEN IF ASUS HAS BEEN ADVISED OF THE POSSIBILITY OF SUCH DAMAGES ARISING FROM ANY DEFECT OR ERROR IN THIS MANUAL OR PRODUCT.

SPECIFICATIONS AND INFORMATION CONTAINED IN THIS MANUAL ARE FURNISHED FOR INFORMATIONAL USE ONLY, AND ARE SUBJECT TO CHANGE AT ANY TIME WITHOUT NOTICE, AND SHOULD NOT BE CONSTRUED AS A COMMITMENT BY ASUS. ASUS ASSUMES NO RESPONSIBILITY OR LIABILITY FOR ANY ERRORS OR INACCURACIES THAT MAY APPEAR IN THIS MANUAL, INCLUDING THE PRODUCTS AND SOFTWARE DESCRIBED IN IT.

Products and corporate names appearing in this manual may or may not be registered trademarks or copyrights of their respective companies, and are used only for identification or explanation and to the owners' benefit, without intent to infringe.

Offer to Provide Source Code of Certain Software

This product contains copyrighted software that is licensed under the General Public License ("GPL"), under the Lesser General Public License Version ("LGPL") and/or other Free Open Source Software Licenses. Such software in this product is distributed without any warranty to the extent permitted by the applicable law. Copies of these licenses are included in this product.

Where the applicable license entitles you to the source code of such software and/or other additional data, you may obtain it for a period of three years after our last shipment of the product, either

(1) for free by downloading it from <http://support.asus.com/download>

or

(2) for the cost of reproduction and shipment, which is dependent on the preferred carrier and the location where you want to have it shipped to, by sending a request to:

ASUSTeK Computer Inc.
Legal Compliance Dept.
15 Li Te Rd.,
Beitou, Taipei 112
Taiwan

In your request please provide the name, model number and version, as stated in the About Box of the product for which you wish to obtain the corresponding source code and your contact details so that we can coordinate the terms and cost of shipment with you.

The source code will be distributed WITHOUT ANY WARRANTY and licensed under the same license as the corresponding binary/object code.

This offer is valid to anyone in receipt of this information.

ASUSTeK is eager to duly provide complete source code as required under various Free Open Source Software licenses. If however you encounter any problems in obtaining the full corresponding source code we would be much obliged if you give us a notification to the email address gpl@asus.com, stating the product and describing the problem (please DO NOT send large attachments such as source code archives, etc. to this email address).

Contents

Safety information.....	vi
About this guide.....	vii
F2A85-M LE specifications summary.....	ix
Package contents.....	xii

Chapter 1: Product introduction

1.1 Special features.....	1-1
1.1.1 Product highlights	1-1
1.1.2 ASUS DIGI+ VRM.....	1-2
1.1.3 ASUS Exclusive Features.....	1-2
1.2 Before you proceed.....	1-4
1.3 Motherboard overview.....	1-5
1.3.1 Placement direction	1-5
1.3.2 Screw holes	1-5
1.3.3 Motherboard layout	1-6
1.3.4 Layout contents.....	1-7
1.4 Accelerated Processing Unit (APU).....	1-7
1.4.1 APU installation.....	1-8
1.4.2 APU heatsink and fan assembly installation	1-9
1.5 System memory.....	1-11
1.5.1 Overview	1-11
1.5.2 Memory configurations.....	1-12
1.5.3 Installing a DIMM	1-17
1.6 Expansion slots.....	1-18
1.6.1 Installing an expansion card	1-18
1.6.2 Configuring an expansion card	1-18
1.6.3 PCI slot	1-18
1.6.4 PCI Express x1 slot.....	1-18
1.6.5 PCI Express x16 slots.....	1-18
1.7 Jumpers.....	1-20
1.8 Connectors.....	1-21
1.8.1 Rear panel ports	1-21
1.8.2 Internal connectors	1-23
1.9 Software support.....	1-30
1.9.1 Installing an operating system	1-30
1.9.2 Support DVD information	1-30

Chapter 2: BIOS information

2.1 Managing and updating your BIOS.....	2-1
2.1.1 ASUS Update utility	2-1

2.1.2	ASUS EZ Flash 2.....	2-2
2.1.3	ASUS CrashFree BIOS 3 utility	2-3
2.1.4	ASUS BIOS Updater.....	2-4
2.2	BIOS setup program.....	2-6
2.3	Main menu.....	2-10
2.3.1	System Language [English]	2-10
2.3.2	System Date [Day xx/xx/xxxx].....	2-10
2.3.3	System Time [xx:xx:xx]	2-10
2.3.4	Security	2-10
2.4	Ai Tweaker menu	2-12
2.4.1	Ai Overclock Tuner [Auto]	2-13
2.4.2	Memory Frequency [Auto].....	2-13
2.4.3	APU Multiplier [Auto].....	2-13
2.4.4	NB Frequency [Auto].....	2-13
2.4.5	EPU Power Saving Mode [Disabled]	2-13
2.4.6	GPU Boost [Auto].....	2-14
2.4.7	OC Tuner	2-14
2.4.8	DRAM Timing Control	2-14
2.4.9	CPU Voltage [Offset Mode].....	2-14
2.4.10	DRAM Voltage [Auto]	2-15
2.4.11	SB 1.1V Voltage [Auto]	2-15
2.4.12	1.1Vsb Voltage [Auto]	2-15
2.4.13	APU1.2V Voltage [Auto].....	2-15
2.4.14	VDDA Voltage [Auto].....	2-15
2.4.15	DIGI+ VRM.....	2-15
2.5	Advanced menu.....	2-17
2.5.1	CPU Configuration	2-17
2.5.2	SATA Configuration	2-18
2.5.3	USB Configuration	2-19
2.5.4	NB Configuration.....	2-19
2.5.5	Onboard Devices Configuration	2-20
2.5.6	APM	2-21
2.5.7	Network Stack	2-22
2.6	Monitor menu.....	2-23
2.6.1	CPU Temperature / MB Temperature [xxx°C/xxx°F].....	2-23
2.6.2	CPU_FAN / CHA_FAN / PWR_FAN Speed [xxxx RPM] or [Ignore] / [N/A]	2-23
2.6.3	CPU Q-Fan Control [Enabled]	2-23
2.6.4	CPU Voltage, 3.3V Voltage, 5V Voltage, 12V Voltage	2-24

2.6.5	Anti Surge Support [Enabled]	2-24
2.7	Boot menu	2-25
2.7.1	Bootup NumLock State [On]	2-25
2.7.2	Full Screen Logo [Enabled].....	2-25
2.7.3	Fast Boot [Enabled]	2-26
2.7.4	Post Delay Time [3 sec]	2-26
2.7.5	Wait for 'F1' If Error [Enabled].....	2-26
2.7.6	Option ROM Messages [Force BIOS].....	2-26
2.7.7	Next boot after AC Power Loss [Normal Boot].....	2-27
2.7.8	CSM Parameters	2-27
2.7.9	Security Boot parameters	2-27
2.7.10	Setup Mode [EZ Mode]	2-28
2.7.11	Boot Option Priorities	2-29
2.7.12	Boot Override	2-29
2.8	Tools menu.....	2-30
2.8.1	ASUS EZ Flash 2 Utility	2-30
2.8.2	ASUS SPD Information	2-30
2.8.3	ASUS O.C. Profile.....	2-30
2.9	Exit menu	2-31

Appendices

Notices	A-1
---------------	-----

Safety information

Electrical safety

- To prevent electrical shock hazard, disconnect the power cable from the electrical outlet before relocating the system.
- When adding or removing devices to or from the system, ensure that the power cables for the devices are unplugged before the signal cables are connected. If possible, disconnect all power cables from the existing system before you add a device.
- Before connecting or removing signal cables from the motherboard, ensure that all power cables are unplugged.
- Seek professional assistance before using an adapter or extension cord. These devices could interrupt the grounding circuit.
- Ensure that your power supply is set to the correct voltage in your area. If you are not sure about the voltage of the electrical outlet you are using, contact your local power company.
- If the power supply is broken, do not try to fix it by yourself. Contact a qualified service technician or your retailer.

Operation safety

- Before installing the motherboard and adding devices on it, carefully read all the manuals that came with the package.
- Before using the product, ensure all cables are correctly connected and the power cables are not damaged. If you detect any damage, contact your dealer immediately.
- To avoid short circuits, keep paper clips, screws, and staples away from connectors, slots, sockets and circuitry.
- Avoid dust, humidity, and temperature extremes. Do not place the product in any area where it may become wet.
- Place the product on a stable surface.
- If you encounter technical problems with the product, contact a qualified service technician or your retailer.

About this guide

This user guide contains the information you need when installing and configuring the motherboard.

How this guide is organized

This guide contains the following parts:

- **Chapter 1: Product introduction**
This chapter describes the features of the motherboard and the new technology it supports.
- **Chapter 2: BIOS information**
This chapter tells how to change system settings through the BIOS Setup menus. Detailed descriptions of the BIOS parameters are also provided.

Where to find more information

Refer to the following sources for additional information and for product and software updates.

1. **ASUS websites**
The ASUS website provides updated information on ASUS hardware and software products. Refer to the ASUS contact information.
2. **Optional documentation**
Your product package may include optional documentation, such as warranty flyers, that may have been added by your dealer. These documents are not part of the standard package.

Conventions used in this guide

To ensure that you perform certain tasks properly, take note of the following symbols used throughout this manual.



DANGER/WARNING: Information to prevent injury to yourself when trying to complete a task.



CAUTION: Information to prevent damage to the components when trying to complete a task.



IMPORTANT: Instructions that you **MUST** follow to complete a task.



NOTE: Tips and additional information to help you complete a task.

Typography

Bold text

Indicates a menu or an item to select.

Italics

Used to emphasize a word or a phrase.

<Key>

Keys enclosed in the less-than and greater-than sign means that you must press the enclosed key.

Example: <Enter> means that you must press the Enter or Return key.

<Key1> + <Key2> + <Key3>

If you must press two or more keys simultaneously, the key names are linked with a plus sign (+).

F2A85-M LE specifications summary

APU	<p>FM2 socket for AMD® A-Series accelerated processors (APU) with AMD Radeon™ HD 7000 Series graphics, up to 4 CPU cores</p> <p>AMD® Turbo Core Technology 3.0 support</p> <p>Microsoft® DirectX® 11 support</p> <ul style="list-style-type: none"> • The AMD® Turbo Core Technology 3.0 support depends on the APU types. • Refer to www.asus.com for the AMD® APU support list.
Chipset	AMD® A85X FCH (Hudson D4)
Memory	<p>2 x 240-pin DIMM slots support maximum 32GB unbuffered non-ECC DDR3 2400(O.C.)/1866/1600/1333/1066MHz memory modules</p> <p>Dual-channel memory architecture</p> <ul style="list-style-type: none"> • The maximum 32GB memory capacity can be supported with 16GB or above DIMMs. ASUS will update the memory QVL once the DIMMs are available in the market. • Refer to www.asus.com for the latest Memory QVL (Qualified Vendors List). • When you install a total memory of 4GB capacity or more, Windows® 32-bit operation system may only recognize less than 3GB. We recommend a maximum of 3GB system memory if you are using a Windows® 32-bit operating system.
Graphics	<p>Integrated AMD Radeon™ HD 7000 Series Graphics in Trinity APU</p> <p>Multi-VGA output support: HDMI, DVI, D-Sub ports</p> <ul style="list-style-type: none"> - Supports HDMI with max. resolution 1920x1080@60Hz - Supports DVI with max. resolution 2560x1600@60Hz - Supports D-Sub with max. resolution 1920x1200@60Hz - Supports Microsoft® DirectX 11 - Maximum shared memory of 2G - Supports AMD® Dual Graphics technology <p>* Refer to www.amd.com for the discrete GPUs which support Dual Graphics technology.</p>
Expansion slots	<p>2 x PCI Express 2.0 x16 slots (blue @ x16 mode, black @ x4 mode)</p> <p>1 x PCI Express 2.0 x1 slot</p> <p>1 x PCI slot</p>
Multi-GPU support	Supports AMD® 2-Way CrossFireX™ Technology
Storage	<p>AMD® A85X FCH:</p> <ul style="list-style-type: none"> - 7x Serial ATA 6Gb/s connectors with RAID 0, RAID 1, RAID 5, RAID 10 and JBOD support - 1x eSerial ATA 6Gb/s at the back I/O
LAN	Realtek® 8111F PCIe Gigabit LAN controller
Audio	<p>Realtek® ALC887 8-Channel High Definition Audio CODEC</p> <ul style="list-style-type: none"> - Supports Jack-Detection, Multi-streaming, Front Panel Jack-Retasking - Optical S/PDIF out port at back I/O <p>• Use a chassis with HD audio module in the front panel to support an 8-channel audio output.</p>
USB	<p>AMD® A85X FCH:</p> <ul style="list-style-type: none"> - 4 x USB 3.0 ports (2 ports at the back panel [blue], 2 ports at mid-board)* - 10 x USB 2.0 ports (4 ports at the back panel, 6 ports at mid-board) <p>* Supports ASUS USB 3.0 Boost</p>

(continued on the next page)

F2A85-M LE specifications summary

ASUS unique features	<p>ASUS DIGI+ VRM:</p> <ul style="list-style-type: none">- DIGI+ Power Design: Industry leading digital 3+2 phase power design for APU- APU Power Utility <p>ASUS EPU</p> <ul style="list-style-type: none">- EPU <p>ASUS Exclusive Features</p> <ul style="list-style-type: none">- ASUS USB 3.0 Boost- ASUS Network iControl*- ASUS AI Charger- ASUS GPU Boost- ASUS Turbo V- ASUS Disk Unlocker- ASUS AI Suite II- ASUS Anti Surge- ASUS ESD- 100% All High-quality Conductive Polymer Capacitors <p>ASUS Quiet Thermal Solution</p> <ul style="list-style-type: none">- ASUS Fanless Design: Stylish heatsink solution- ASUS Fan Xpert <p>ASUS EZ DIY</p> <ul style="list-style-type: none">- ASUS UEFI BIOS EZ Mode featuring friendly graphics user interface- ASUS CrashFree BIOS 3- ASUS EZ Flash 2- ASUS My Logo 2 <p>* The ASUS Network iControl feature does not support Windows® XP/Vista operating systems.</p>
ASUS Exclusive overclocking features	<p>Precision Tweaker 2</p> <ul style="list-style-type: none">- vCore: Adjustable CPU voltage at 0.00625V increment- vDDNB: Adjustable CPU/NB voltage at 0.00625V increment- vDRAM Bus: Adjustable DRAM voltage at 0.005V increment- vFCH: Adjustable FCH voltage at 0.01V increment <p>SFS (Stepless Frequency Selection)</p> <ul style="list-style-type: none">- APU Frequency tuning from 90MHz up to 300MHz at 1MHz increment <p>Overclocking Protection</p> <ul style="list-style-type: none">- ASUS C.P.R.(CPU Parameter Recall)

(continued on the next page)

F2A85-M LE specifications summary

Back Panel I/O ports	<ul style="list-style-type: none"> 1 x PS/2 keyboard/mouse combo port 1 x HDMI port 1 x DVI port 1 x D-Sub port 1 x Optical S/PDIF Output port 1 x LAN (RJ-45) port 1 x eSATA port 4 x USB 2.0/1.1 ports 2 x USB 3.0/2.0 ports (blue) 8-channel audio I/O ports (3 jacks)
Internal I/O connectors	<ul style="list-style-type: none"> 1 x USB 3.0/2.0 connector supports additional 2 USB ports (19-pin) 3 x USB 2.0/1.1 connectors support additional 6 USB ports 7 x SATA 6Gb/s connectors 1 x CPU fan connector (4-pin) 1 x Chassis fan connector (4-pin) 1 x Power fan connector (3-pin) 1 x Front panel audio connector 1 x S/PDIF Out connector 1 x LPT connector 1 x Speaker header 1 x COM connector 1 x System panel connector 1 x 24-pin EATX power connector 1 x 4-pin ATX 12V power connector
BIOS features	<p>64 Mb Flash ROM, UEFI AMI BIOS, PnP, DMI 2.0, WfM 2.0, SM BIOS 2.7, ACPI 2.0a, Multi-language BIOS, ASUS EZ Flash 2, ASUS CrashFree BIOS 3, F12 Printsreen function, F3 Shortcut function and ASUS DRAM SPD (Serial Presence Detect) memory information</p>
Support DVD	<ul style="list-style-type: none"> Drivers ASUS utilities ASUS Update Anti-virus software (OEM version)
Form factor	<p>MicroATX form factor: 9.6 in x 9.2 in (24.4 cm x 23.4 cm)</p>



Specifications are subject to change without notice.

Package contents

Check your motherboard package for the following items.

<p style="text-align: center;">ASUS F2A85-M LE motherboard</p>	<p style="text-align: center;">2 x Serial ATA 6.0 Gb/s cables</p>	
<p style="text-align: center;">1 x I/O-Shield</p>	<p style="text-align: center;">User Guide</p>	<p style="text-align: center;">Support DVD</p>



- If any of the above items is damaged or missing, contact your retailer.
- The illustrated items above are for reference only. Actual product specifications may vary with different models.

Product introduction

1

1.1 Special features

1.1.1 Product highlights

AMD® A-series accelerated processors with AMD® Radeon™ HD 7000 series graphics

This motherboard supports AMD® A-series accelerated processor with AMD® Radeon™ HD 7000 series graphics. This revolutionary APU (Accelerated Processing Unit) combines processing power and advanced DirectX 11 graphics in one small, energy-efficient design to enable accelerated performance and an industry-leading visual experience. It features Dual-channel DDR3 memory support and accelerates data transfer rate up to 5GT/s.

AMD® A85X FCH (Hudson D4) chipset

AMD® A85X FCH (Hudson D4) is designed to support up to 5GT/s interface speed and AMD® CrossFireX™ multi-GPU technology. It also supports 8 x SATA 6.0Gb/s ports and 4 x USB 3.0 ports.

Complete USB 3.0 integration

This motherboard offers you the strategic USB 3.0 accessibility for both the front and rear panels, allowing you to experience the convenience of the latest plug and play connectivity solution at speed up to ten times faster than USB 2.0.

AMD® CrossFireX™ Technology

AMD's CrossFireX™ boosts image quality along with rendering speed, eliminating the need to scale down screen resolution to get high quality images. CrossFireX™ allows higher antialiasing, anisotropic filtering, shading, and texture settings. Adjust your display configurations, experiment with the advanced 3D settings, and check the effects with a real-time 3D-rendered previews within AMD Catalyst™ Control Center.

Native SATA 6.0 Gb/s support

With AMD® A85X FCH natively support for the next-generation Serial ATA (SATA) storage interface, this motherboard delivers up to 6.0 Gb/s data transfer rates. It also provides enhanced scalability, faster data retrieval, double the bandwidth of current bus systems.

100% All High-quality Conductive Polymer Capacitors

This motherboard uses all high-quality conductive polymer capacitors for durability, improved lifespan, and enhanced thermal capacity.

1.1.2 ASUS DIGI+ VRM

DIGI+ Power Control: Digital Power Design for the APU*

ASUS motherboards using the AMD® A85 chipset employ precise digital voltage regulation for the APU, called DIGI+ VRM (Voltage Regulation Modules) digital power design. The APU voltage is adjusted via either carefully developed automated modes, or by using user-defined profiles. The effect is that DIGI+ VRM technology ensures greater energy efficiency and the most precise power delivery. Boosted by world-renowned ASUS quality, it creates an ideal computing platform for a diverse range of applications, from gaming to multimedia or office work and heavy multitasking. Engineered and tested to assure unmitigated performance, ASUS A55 boards with DIGI+ VRM remain efficient and accurate, for reliable application in every scenario.

* DIGI+ VRM functions also available in FM2 socket compatible CPUs

1.1.3 ASUS Exclusive Features

USB 3.0 Boost

With USB 3.0 Boost technology, USB transfer speeds are significantly increased up to 132%, enhancing an already impressive USB 3.0 transfer rate. ASUS software automatically accelerates data speeds for compatible USB 3.0 peripherals without the need for any further user configuration.

Network iControl

Network iControl is an intuitive one-step network control center that makes it easier for you to manage your bandwidth and allows you to set, monitor, and schedule the bandwidth priorities for your network programs. It allows you to automatically connect to a PPPoE network for a more convenient online experience.

* The ASUS Network iControl feature does not support Windows® XP/Vista operating systems.

Ai Charger

Ai Charger is ASUS fast-charging software that supports iPod, iPhone, and iPad.



-
- Check your USB mobile device if it fully supports the BC 1.1 function.
 - The actual charging speed may vary with your USB device's conditions.
-

ASUS UEFI BIOS (EZ Mode)

ASUS UEFI BIOS, a UEFI compliant architecture, offers the first mouse-controlled intuitive graphical BIOS interface that goes beyond the traditional keyboard-only BIOS controls, providing you with more flexibility, convenience, and easy to navigate EFI BIOS than the traditional BIOS versions. It offers you with dual selectable modes and native support for hard drives larger than 2.2 TB.

ASUS UEFI BIOS includes the following new features:

- F12 BIOS snapshot hotkey
- F3 Shortcut for most accessed information
- ASUS DRAM SPD (Serial Presence Detect) information detecting faulty DIMMs, and helping with difficult POST situations.

ASUS TurboV

With its user-friendly interface, ASUS TurboV offers you the adrenaline rush of real-time overclocking without exiting or rebooting the OS. It also provides you with the ASUS OC profiles for the best overclocking settings in different scenarios.

GPU Boost

GPU Boost accelerates the integrated GPU for extreme graphics performance, facilitates flexible frequency adjustments, and easily delivers stable system-level upgrades for every use.

EPU

EPU (Energy Processing Unit), the world's first real-time system power-saving chip, automatically detects the current system load and intelligently moderates power usage. It offers a total system-wide energy optimization, reduces fan noise, and extends the component's lifespan.

ASUS Anti-Surge Protection

This special design protects expensive devices and the motherboard from damage caused by power surges from switching power supply unit (PSU).

AI Suite II

With its user interface, ASUS AI Suite II integrates several ASUS utilities and allows you to launch and operate these utilities simultaneously. It allows you to configure the overclocking settings, adjust the frequencies and related voltages, remotely control the system via a mobile device, and other easy-to-use helpful utilities.

ASUS Fan Xpert

ASUS Fan Xpert intelligently allows you to adjust the CPU fan speed based on different ambient temperatures, resulting to a quiet and cool computing environment.

ASUS EZ Flash 2

ASUS EZ Flash 2 is a user-friendly utility that allows you to update the BIOS without using a bootable floppy disk or an OS-based utility.

ASUS MyLogo2™

Turn your favorite photos into 256-color boot logos to personalize your system.

ASUS CrashFree BIOS 3

ASUS CrashFree BIOS 3 allows you to restore a corrupted BIOS file from a USB storage device that contains the BIOS file.

C.P.R. (CPU Parameter Recall)

The BIOS C.P.R. feature automatically restores the CPU default settings when the system hangs due to overclocking failure. C.P.R. eliminates the need to open the system chassis and clear the RTC data. Simply shut down and reboot the system, and the BIOS automatically restores the CPU parameters to their default settings.

ErP ready

The motherboard is European Union's Energy-related Products (ErP) ready, and ErP requires products to meet certain energy efficiency requirements in regards to energy consumptions. This is in line with ASUS vision of creating environment-friendly and energy-efficient products through product design and innovation to reduce carbon footprint of the product and thus mitigate environmental impacts.

1.2 Before you proceed

Take note of the following precautions before you install motherboard components or change any motherboard settings.



- Unplug the power cord from the wall socket before touching any component.
- Before handling components, use a grounded wrist strap or touch a safely grounded object or a metal object, such as the power supply case, to avoid damaging them due to static electricity.
- Hold components by the edges to avoid touching the ICs on them.
- Whenever you uninstall any component, place it on a grounded antistatic pad or in the bag that came with the component.
- Before you install or remove any component, switch off the ATX power supply and detach its power cord. Failure to do so may cause severe damage to the motherboard, peripherals, or components.

Standby Power LED

The motherboard comes with a standby power LED that lights up to indicate that the system is ON, in sleep mode, or in soft-off mode. This is a reminder that you should shut down the system and unplug the power cable before removing or plugging in any motherboard component. The illustration below shows the location of the onboard LED.

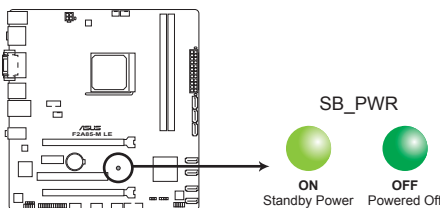

F2A85-M LE Onboard LED

1.3 Motherboard overview

1.3.1 Placement direction

When installing the motherboard, ensure that you place it into the chassis in the correct orientation. The edge with external ports goes to the rear part of the chassis as indicated in the image below.

1.3.2 Screw holes

Place six screws into the holes indicated by circles to secure the motherboard to the chassis.



DO NOT overtighten the screws! Doing so can damage the motherboard.

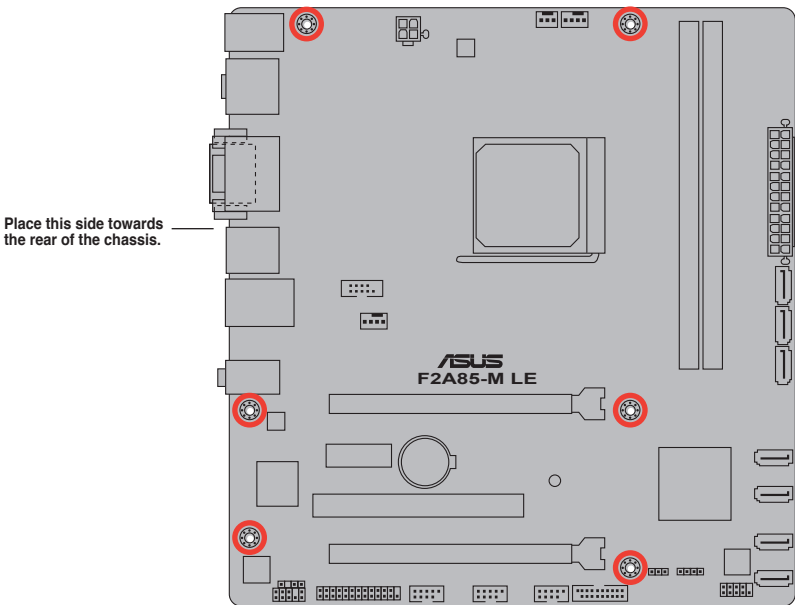

1.3.3 Motherboard layout

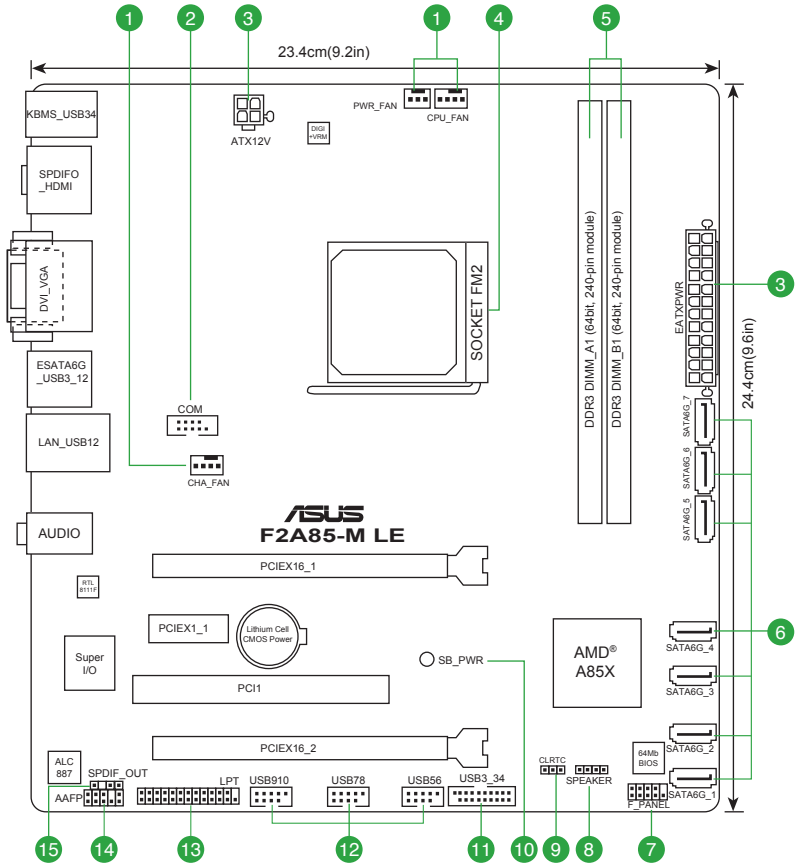

1.3.4 Layout contents

Connectors/Jumpers/Slots/LED	Page
1. Power, CPU, and chassis fan connectors (3-pin PWR_FAN, 4-pin CPU_FAN, and 4-pin CHA_FAN)	1-23
2. Serial port connector (10-1 pin COM)	1-29
3. ATX power connectors (24-pin EATXPWR, 4-pin ATX12V)	1-24
4. AMD FM2 socket	1-7
5. DDR3 DIMM slots	1-11
6. SATA 6.0Gb/s connectors (7-pin SATA6G_1~7)	1-25
7. System panel connector (10-1 pin F_PANEL)	1-26
8. Speaker connector (4-pin SPEAKER)	1-26
9. Clear RTC RAM (3-pin CLRTC)	1-20
10. Standby power LED (SB_PWR)	1-4
11. USB 3.0 connector (20-1 pin USB3_34)	1-28
12. USB 2.0 connectors (10-1 pin USB56, USB78, USB910)	1-28
13. LPT connector (26-1 pin LPT)	1-29
14. Front panel audio connector (10-1 pin AAFP)	1-27
15. Digital audio connector (4-1 pin SPDIF_OUT)	1-27

1.4 Accelerated Processing Unit (APU)

This motherboard comes with an FM2 socket designed for AMD® A-series accelerated processors with AMD® Radeon™ HD 7000 series graphics.



Ensure that you use a APU designed for the FM2 socket. The APU fits in only one correct orientation. DO NOT force the APU into the socket to prevent bending the pins and damaging the APU!

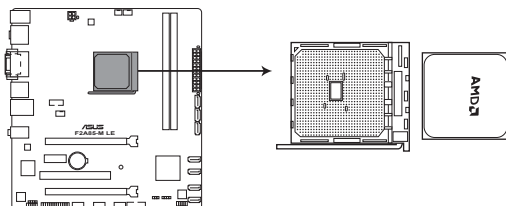

F2A85-M LE APU socket FM2

1.4.1 APU installation

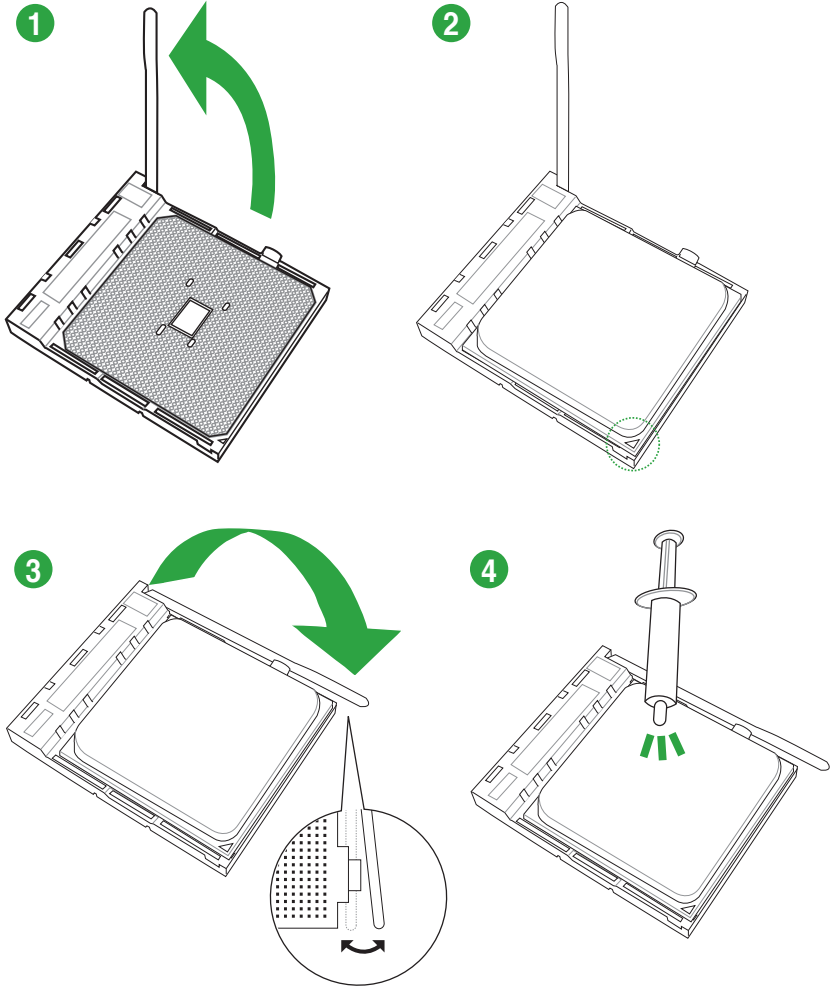

1.4.2 APU heatsink and fan assembly installation

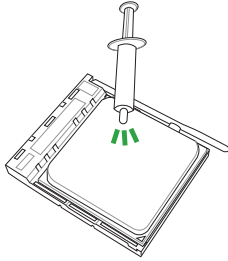

Apply the Thermal Interface Material to the APU heatsink and APU before you install the heatsink and fan if necessary.

To install the APU heatsink and fan assembly

1

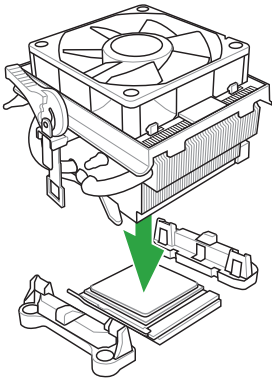

2

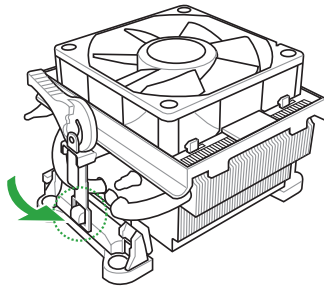

3

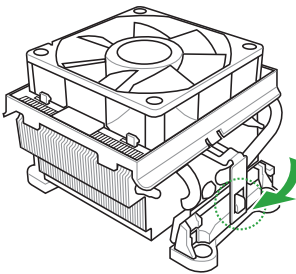

4

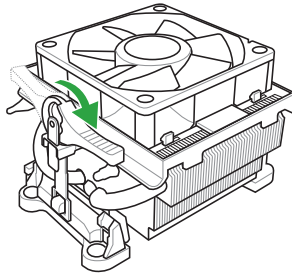

5

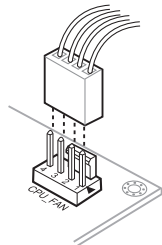

To uninstall the APU heatsink and fan assembly

1

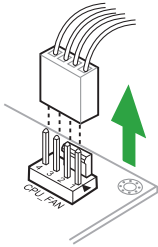

2

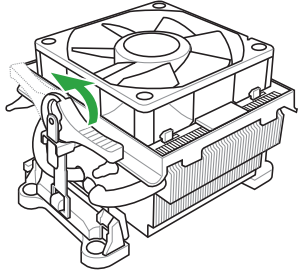

3

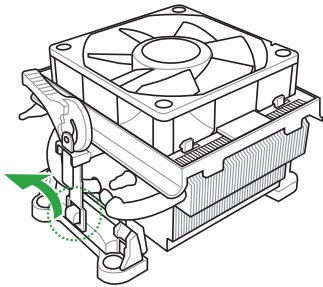

4

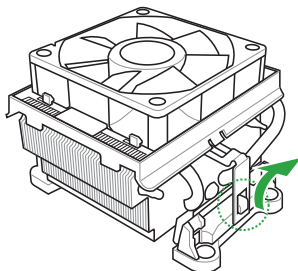

5

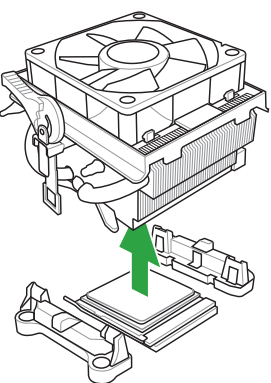

1.5 System memory

1.5.1 Overview

This motherboard comes with two Double Data Rate 3 (DDR3) Dual Inline Memory Modules (DIMM) sockets.

A DDR3 module has the same physical dimensions as a DDR2 DIMM but is notched differently to prevent installation on a DDR2 DIMM socket. DDR3 modules are developed for better performance with less power consumption.

The figure illustrates the location of the DDR3 DIMM sockets:

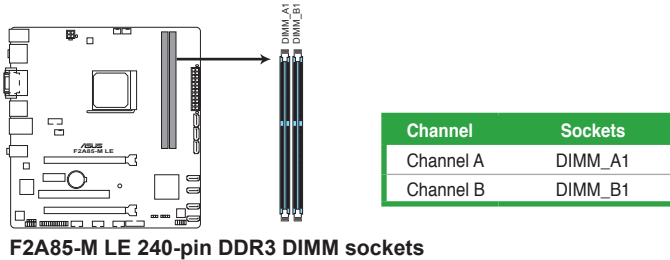

1.5.2 Memory configurations

You may install 1GB, 2GB, 4GB, and 8GB unbuffered non-ECC DDR3 DIMMs into the DIMM sockets.



- You may install varying memory sizes in Channel A and Channel B. The system maps the total size of the lower-sized channel for the dual-channel configuration. Any excess memory from the higher-sized channel is then mapped for single-channel operation.
- We recommend that you install the memory modules from the blue slots for better overclocking capability.
- Always install DIMMs with the same CAS latency. For optimal compatibility, we recommend that you install memory modules of the same version or date code (D/C) from the same vendor. Check with the retailer to get the correct memory modules.
- Due to the memory address limitation on 32-bit Windows® OS, when you install 4GB or more memory on the motherboard, the actual usable memory for the OS can be about 3GB or less. For effective use of memory, we recommend that you do any of the following:
 - Install a maximum of 3GB system memory if you are using a 32-bit Windows® OS.
 - Use a 64-bit Windows® OS if you want to install 4GB or more memory on the motherboard.
- This motherboard does not support DIMMs made up of 512Mb (64MB) chips or less.
- The maximum 32GB memory capacity can be supported with 16GB or above DIMMs. ASUS will update the memory QVL once the DIMMs are available in the market.



- The default memory operation frequency is dependent on its Serial Presence Detect (SPD), which is the standard way of accessing information from a memory module. Under the default state, some memory modules for overclocking may operate at a lower frequency than the vendor-marked value. To operate at the vendor-marked or at a higher frequency, refer to section **2.4 Ai Tweaker menu** for manual memory frequency adjustment.
- For system stability, use a more efficient memory cooling system to support a full memory load (2 DIMMs) or overclocking condition.

F2A85-M LE Motherboard Qualified Vendors Lists (QVL)

DDR3 2400 (O.C.) MHz capability

Vendors	Part No.	Size	SS/DS	Chip Brand	Chip NO.	Timing	Voltage	DIMM socket support (Optional)	
								1 DIMM	2 DIMMs
G.SKILL	F3-19200CL9D-4GBPIS(XMP)	4GB(2x 2GB)	DS	-	-	9-11-9-28	1.65V	•	•
KINGMAX	FLLE88F-C8KKA H AIS(XMP)	2GB	SS	-	-	10-11-10-30	1.8V	•	•
Team	TXD34096M2400HC9N-L	4GB	DS	SEC 128 HCH9	K4B2G0846D	9-11-11-28	1.65V	•	•

DDR3 2250 (O.C.) MHz capability

Vendors	Part No.	Size	SS/DS	Chip Brand	Chip NO.	Timing	Voltage	DIMM socket support (Optional) 1 DIMM 2 DIMMs
KINGSTON	KHX2250C9D3T1K2/4GX(XMP)	4GB(2x 2GB)	DS	-	-	-	1.65V	• •

DDR3 2200 (O.C.) MHz capability

Vendors	Part No.	Size	SS/DS	Chip Brand	Chip NO.	Timing	Voltage	DIMM socket support (Optional) 1 DIMM 2 DIMMs
GEIL	GET34GB2200C9DC(XMP)	2GB	DS	-	-	9-10-9-28	1.65V	•
GEIL	GET38GB2200C9ADC(XMP)	4GB	DS	-	-	9-11-9-28	1.65V	•
KINGMAX	FLKE85F-B8KJA-FEIS(XMP)	2GB	DS	-	-	-	-	•
KINGMAX	FLKE85F-B8KJA FEIH(XMP)	4GB(2 x 2GB)	DS	-	-	-	1.5V-1.7V	• •

DDR3 2133 (O.C.) MHz capability

Vendors	Part No.	Size	SS/DS	Chip Brand	Chip NO.	Timing	Voltage	DIMM socket support (Optional) 1 DIMM 2 DIMMs
A-DATA	AX3U2133GC2G8B-DG2(XMP)	2GB	SS	-	-	9-11-9-27	1.55~1.75V	• •
CORSAIR	CMT16GX3M4X2133C9(XMP 1.3)	16GB(4GB x 4)	DS	-	-	9-11-10-27	1.50V	• •
CORSAIR	CMT4GX3M2A2133C9(XMP)	4GB(2 x 2GB)	DS	-	-	9-10-9-24	1.65V	• •
CORSAIR	CMT4GX3M2B2133C9(XMP)	4GB(2 x 2GB)	DS	-	-	9-10-9-27	1.50V	• •
CORSAIR	CMT8GX3M2B2133C9(XMP)	8GB(4GB x 2)	DS	-	-	9-11-9-27	1.50V	• •
G.SKILL	F3-17000CL9Q-16GBZH(XMP1.3)	16GB(4GB x 4)	DS	-	-	9-11-10-28	1.65V	• •
GEIL	GU34GB2133C9DC(XMP)	4GB(2 x 2GB)	DS	-	-	9-9-9-28	1.65V	• •
KINGSTON	KHX2133C11D3T1K2/16GX(XMP)	16GB(8GB x 2)	DS	-	-	-	1.6V	• •
KINGSTON	KHX21C11T1BK2/16X(XMP)	16GB(8GB x 2)	DS	-	-	-	1.6V	• •
KINGSTON	KHX2133C9AD3T1K2/4GX(XMP)	4GB(2 x 2GB)	DS	-	-	-	1.65V	• •
KINGSTON	KHX2133C9AD3T1K4/8GX(XMP)	8GB(4 x 2GB)	DS	-	-	9-11-9-27	1.65V	• •
KINGSTON	KHX2133C9AD3T1FK4/8GX(XMP)	8GB(4 x 2GB)	DS	-	-	-	1.65V	• •
KINGSTON	KHX21C11T1BK2/16X(XMP)	16GB(8GB x 2)	DS	-	-	-	1.6V	• •
KINGSTON	KHX21C11T1BK2/8X(XMP)	8GB(4GB x 2)	DS	-	-	-	1.6V	• •
Team	TXD34096M2133HC9N-L	4GB	DS	SEC 128 HCH9	K4B2G0846D	9-11-11-28	1.65V	• •

DDR3 2000 (O.C.) MHz capability

Vendors	Part No.	Size	SS/DS	Chip Brand	Chip NO.	Timing	Voltage	DIMM socket support (Optional) 1 DIMM 2 DIMMs
CORSAIR	CM24GX3M2A2000C10(XMP)	4GB(2 x 2GB)	SS	-	-	10-10-10-27	1.50V	• •
CORSAIR	CMT6GX3M3A2000C8(XMP)	6GB(3 x 2GB)	DS	-	-	8-9-9-24	1.65V	• •
G.SKILL	F3-16000CL9D-4GBFLS(XMP)	4GB(2 x 2GB)	DS	-	-	9-9-9-24	1.65V	• •
G.SKILL	F3-16000CL6T-6GBPIIS(XMP)	6GB(3 x 2GB)	DS	-	-	6-9-6-24	1.65V	• •
GEIL	GUP34GB2000C9DC(XMP)	4GB(2 x 2GB)	DS	-	-	9-9-9-28	1.65V	• •
KINGSTON	KHX2000C9AD3W1K2/4GX(XMP)	4GB(2 x 2GB)	DS	-	-	-	1.65V	• •
KINGSTON	KHX2000C9AD3W1K3/6GX(XMP)	6GB(3 x 2GB)	DS	-	-	-	1.65V	• •
KINGSTON	KHX2000C9AD3T1K3/6GX(XMP)	6GB(3 x 2GB)	DS	-	-	-	1.65V	• •

DDR3 1866 MHz capability

Vendors	Part No.	Size	SS/DS	Chip Brand	Chip NO.	Timing	Voltage	DIMM socket support (Optional) 1 DIMM 2 DIMMs
CORSAIR	CMT4GX3M2A1866C9(XMP)	4GB(2 x 2GB)	DS	-	-	9-9-9-24	1.65V	• •
CORSAIR	CMT6GX3MA1866C9(XMP)	6GB(3 x 2GB)	DS	-	-	9-9-9-24	1.65V	• •
CORSAIR	CM28GX3M2A1866C9(XMP)	8GB(2 x 4GB)	DS	-	-	9-10-9-27	1.50V	• •
G.SKILL	F3-14900CL9Q-16GBZL(XMP1.3)	16GB(4GB x 4)	DS	-	-	9-10-9-28	1.5V	• •
G.SKILL	F3-14900CL10Q2-64GBZLD(XMP1.3)	64GB(8GB x 8)	DS	-	-	10-11-10-30	1.5V	• •
G.SKILL	F3-14900CL9D-8GBXL(XMP)	8GB(2 x 4GB)	DS	-	-	9-10-9-28	1.5V	• •
G.SKILL	F3-14900CL9Q-8GBXL(XMP)	8GB(2GB x 4)	DS	-	-	9-9-9-24	1.6V	• •
KINGSTON	KHX1866C9D3K4/16GX(XMP)	16GB(4GB x 4)	DS	-	-	-	1.65V	• •
KINGSTON	KHX1866C9D3T1K3/8GX(XMP)	8GB(3 x 2GB)	DS	-	-	-	1.65V	• •
KINGSTON	KHX1866C11D3P1K2/8G	8GB(4GB x 2)	DS	-	-	-	1.5V	• •
KINGSTON	KHX1866C9D3K2/8GX(XMP)	8GB(4GB X 2)	DS	-	-	-	1.65V	• •

DDR3 1600 MHz capability

Vendors	Part No.	Size	SS/DS	Chip Brand	Chip NO.	Timing	Voltage	DIMM socket support (Optional) 1 DIMM 2 DIMMs
A-DATA	AM2U16BC2P1	2GB	SS	A-DATA	3CCD-1509A EL1126T	-	-	*
A-DATA	AM2U16BC4P2	4GB	DS	A-DATA	3CCD-1509A EL1126T	-	-	*
A-DATA	AX3U1600GC4G9-2G(XMP)	8GB(2 x 4GB)	DS	-	-	9-9-9-24	1.55V-1.75V	*
A-DATA	AX3U1600XC4G79-2X(XMP)	8GB(2 x 4GB)	DS	-	-	7-9-7-21	1.55V-1.75V	*
Apacer	78.B1GE3.9L10C	4GB	DS	Apacer KZZC	AM5D5908D EQSCK	-	-	*
CORSAIR	CMD12GX3M6A1600C8(XMP)	12GB(6 x 2GB)	DS	-	-	8-8-8-24	1.65V	*
CORSAIR	CMZ32GX3M4X1600C10(XMP)	32GB(8GB x 4)	DS	-	-	10-10-10-27	1.50V	*
CORSAIR	CMP4GX3M2A1600C8(XMP)	4GB(2 x 2GB)	DS	-	-	8-8-8-24	1.65V	*
CORSAIR	CMP4GX3M2A1600C9(XMP)	4GB(2 x 2GB)	DS	-	-	9-9-9-24	1.65V	*
CORSAIR	CMP4GX3M2C1600C7(XMP)	4GB(2 x 2GB)	DS	-	-	7-8-7-20	1.65V	*
CORSAIR	CMX4GX3M2A1600C9(XMP)	4GB(2 x 2GB)	DS	-	-	9-9-9-24	1.65V	*
CORSAIR	CMX4GX3M2A1600C9(XMP)	4GB(2 x 2GB)	DS	-	-	9-9-9-24	1.65V	*
CORSAIR	TR3X6G1600C8 G(XMP)	6GB(3 x 2GB)	DS	-	-	8-8-8-24	1.65V	*
CORSAIR	TR3X6G1600C8D G(XMP)	6GB(3 x 2GB)	DS	-	-	8-8-8-24	1.65V	*
CORSAIR	TR3X6G1600C9 G(XMP)	6GB(3 x 2GB)	DS	-	-	9-9-9-24	1.65V	*
CORSAIR	CMP8GX3M2A1600C9(XMP)	8GB(2 x 4GB)	DS	-	-	9-9-9-24	1.65V	*
CORSAIR	CMZ8GX3M2A1600C7R(XMP)	8GB(2 x 4GB)	DS	-	-	7-8-7-20	1.50V	*
CORSAIR	CMX8GX3M4A1600C9(XMP)	8GB(4 x 2GB)	DS	-	-	9-9-9-24	1.65V	*
Crucial	BL25664B1608.16FF(XMP)	6GB(3 x 2GB)	DS	-	-	-	-	*
G.SKILL	F3-12800CL7D-4GBRRH(XMP)	4GB(2 x 2GB)	SS	-	-	7-7-7-24	1.6V	*
G.SKILL	F3-12800CL7D-4GBECCO(XMP)	4GB(2 x 2GB)	DS	-	-	7-7-8-24	XMP 1.35V	*
G.SKILL	F3-12800CL7D-4GBRM(XMP)	4GB(2 x 2GB)	DS	-	-	7-8-7-24	1.6V	*
G.SKILL	F3-12800CL8D-4GBRM(XMP)	4GB(2 x 2GB)	DS	-	-	8-8-8-24	1.60V	*
G.SKILL	F3-12800CL9D-4GBECCO(XMP)	4GB(2 x 2GB)	DS	-	-	9-9-9-24	XMP 1.35V	*
G.SKILL	F3-12800CL9D-4GBRLL(XMP)	4GB(2 x 2GB)	DS	-	-	9-9-9-24	1.5V	*
G.SKILL	F3-12800CL9T-6GBNQP(XMP)	6GB(3 x 2GB)	DS	-	-	9-9-9-24	1.5V~1.6V	*
G.SKILL	F3-12800CL7D-8GBRRH(XMP)	8GB(2 x 4GB)	DS	-	-	7-8-7-24	1.6V	*
G.SKILL	F3-12800CL8D-8GBECCO(XMP)	8GB(2 x 4GB)	DS	-	-	8-8-8-24	XMP 1.35V	*
G.SKILL	F3-12800CL9D-8GBRLL(XMP)	8GB(2 x 4GB)	DS	-	-	9-9-9-24	1.5V	*
GEIL	GET316GB1600C9QC(XMP)	16GB(4 x 4GB)	DS	-	-	9-9-9-28	1.6V	*
GEIL	GV34GB1600C8DC(XMP)	2GB	DS	-	-	8-8-8-28	1.6V	*
HYNIX	HMT351U6CFR8C-PB	4GB	DS	HYNIX	H5TO2G83 CFR PBC	-	-	*
KINGMAX	FLGE85F-B8KJ9A FEIS(XMP)	2GB	DS	-	-	-	-	*
KINGMAX	FLGE85F-B8MF7 MEEH(XMP)	2GB	DS	-	-	7	-	*
KINGSTON	KHX1600C9D3P1K2/4G	4GB(2 x 2GB)	SS	-	-	-	1.5V	*
KINGSTON	KHX1600C9D3K3/12GX(XMP)	12GB(3 x 4GB)	DS	-	-	9-9-9-27	1.65V	*
KINGSTON	KHX1600C9D3T1BK3/12GX(XMP)	12GB(3 x 4GB)	DS	-	-	9-9-9-27	1.65V	*
KINGSTON	KHX1600C9D3K4/16GX(XMP)	16GB(4GB x4)	DS	-	-	-	1.65V	*
KINGSTON	KHX1600C10D3B1K2/16G	16GB(8GB x 2)	DS	-	-	-	1.5V	*
KINGSTON	KHX16C9K2/16	16GB(8GB x 2)	DS	-	-	-	1.5V	*
KINGSTON	KHX1600C9AD3/2G	2GB	DS	-	-	-	1.65V	*
KINGSTON	KVR1600D3N112G-ES	2GB	DS	KTC	D1288JPN DFPLD9U	11-11-11-28	1.35V-1.5V	*
KINGSTON	KHX1600C7D3K2/4GX(XMP)	4GB(2 x 2GB)	DS	-	-	-	1.65V	*
KINGSTON	KHX1600C8D3K2/4GX(XMP)	4GB(2 x 2GB)	DS	-	-	8	1.65V	*
KINGSTON	KHX1600C8D3T1K2/4GX(XMP)	4GB(2 x 2GB)	DS	-	-	8	1.65V	*
KINGSTON	KHX1600C9D3K2/4GX(XMP)	4GB(2 x 2GB)	DS	-	-	9	1.65V	*
KINGSTON	KHX1600C9D3L1K2/4GX(XMP)	4GB(2 x 2GB)	DS	-	-	9	XMP 1.35V	*
KINGSTON	KHX1600C9D3K2K2/4GX(XMP)	4GB(2 x 2GB)	DS	-	-	9-9-9-27	1.65V	*
KINGSTON	KHX1600C9D3T1K3/6GX(XMP)	6GB(3 x 2GB)	DS	-	-	-	1.65V	*
KINGSTON	KHX1600C9D3K3/6GX(XMP)	6GB(3 x 2GB)	DS	-	-	9	1.65V	*
KINGSTON	KHX1600C9D3T1BK3/6GX(XMP)	6GB(3 x 2GB)	DS	-	-	9-9-9-27	1.65V	*
KINGSTON	KHX1600C9D3K2/8GX(XMP)	8GB(2 x 4GB)	DS	-	-	9-9-9-27	1.65V	*
KINGSTON	KHX1600C9D3P1K2/8G	8GB(2 x 4GB)	DS	-	-	-	1.5V	*
Super Talent	WA160UX6G9	6GB(3 x 2GB)	DS	-	-	9	-	*
SanMax	SMD-4G68HP-16KZ	4GB	DS	HYNIX	H5TO2G83 BFR PBC	-	-	*
Apacer	78.B1GE3.9L10C	4GB	DS	Apacer KZZC	AM5D5908 DEQSCK	-	-	*
KINGSTON	KHX1600C10D3B1K2/16G	16GB(8GB x 2)	DS	-	-	-	1.5V	*
KINGSTON	KHX16C9K2/16	16GB(8GB x 2)	DS	-	-	-	1.5V	*
Elixir	M2X8G64C8BH85N-DG(XMP)	8GB	DS	Elixir 1213	N2CB4G8 BOBN-DG	-	-	*

DDR3 1333 MHz capability

Vendors	Part No.	Size	SS/DS	Chip Brand	Chip NO.	Timing	Voltage	DIMM socket support (Optional)	
								1 DIMM	2 DIMMs
A-DATA	AD3U1333C2G9	2GB	SS	A-DATA	3CCD-1509HNA1126L	-	-	*	*
A-DATA	AM2U139C2P1	2GB	SS	ADATA	3CCD-1509A EL1127T	-	-	*	*
A-DATA	AX3U1333C2G9-BP	2GB	SS	-	-	-	-	*	*
A-DATA	AXDU1333GC2G9-2G(XMP)	4GB(2 x 2GB)	SS	-	-	9-9-9-24	1.25V-1.35V(low voltage)	*	*
A-DATA	AD6311C1624EV	4GB	DS	A-Data	3CCA-1509A	-	-	*	*
A-DATA	AM2U139C4P2	4GB	DS	ADATA	3CCD-1509A EL1127T	-	-	*	*
A-DATA	SUGU1333W8G9-B	8GB	DS	ELPIDA	J4208BASE-DJ-F	-	-	*	*
Apacer	78.A1GC6.9L1	2GB	DS	Apacer	AM5D5808DEWSBG	-	-	*	*
Apacer	78.A1GC6.9L1	2GB	DS	Apacer	AM5D5808FEQSBG	9	-	*	*
Apacer	AU02GFA33C9NDBG	2GB	DS	Apacer	AM5D5808APQSBG	-	-	*	*
Apacer	78.B1GDE.9L10C	4GB	DS	Apacer	AM5D5908CEHSBG	-	-	*	*
CORSAIR	TR3X6G1333C9 G	6GB(3x 2GB)	SS	-	-	9-9-9-24	1.50V	*	*
CORSAIR	CMD24GX3M6A1333C9(XMP)	24GB(6x4GB)	DS	-	-	9-9-9-24	1.60V	*	*
CORSAIR	TW3X4G1333C9D G	4GB(2 x 2GB)	DS	-	-	9-9-9-24	1.50V	*	*
CORSAIR	CM3X4GA1333C9N2	4GB	DS	CORSAIR	256MBDCJGELC0401136	9-9-9-24	-	*	*
CORSAIR	CMX4GX3M1A1333C9	4GB	DS	-	-	9-9-9-24	1.50V	*	*
CORSAIR	CMD8GX3M4A1333C7	8GB(4 x 2GB)	DS	-	-	7-7-7-20	1.60V	*	*
Crucial	CT25664BA1339.16FF	2GB	DS	Micron	9KF27D9KPT	9	-	*	*
Crucial	BL25664BN1337.16FF (XMP)	6GB(3 x 2GB)	DS	-	-	7-7-7-24	1.65V	*	*
ELPIDA	EBJ21UE8DJF-DJ-F	2GB	DS	ELPIDA	J1108EDSE-DJ-F	-	1.35V(low voltage)	*	*
G.SKILL	F3-10666CL8D-4GBECO(XMP)	4GB(2 x 2GB)	DS	-	-	8-8-8-24	XMP 1.35V	*	*
G.SKILL	F3-10666CL7D-8GBRHX(XMP)	8GB(2 x 4GB)	DS	-	-	7-7-7-21	1.5V	*	*
GEIL	GG34GB1333C9DC	4GB(2 x 2GB)	DS	GEIL	GL1L128M88BA12N	9-9-9-24	1.3V(low voltage)	*	*
GEIL	GV34GB1333C9DC	4GB(2 x 2GB)	DS	-	-	9-9-9-24	1.5V	*	*
GEIL	GV34GB1333C7DC	4GB(2 x 2GB)	DS	-	-	7-7-7-24	1.5V	*	*
Hynix	HMT325U6BFR8C-H9	2GB	SS	Hynix	H5TQ2G83BFRH9C	-	-	*	*
Hynix	HMT125U6TFR8A-H9	2GB	DS	Hynix	H5TC1G83TFRH9A	-	1.35V(low voltage)	*	*
Hynix	HMT351U6BFR8C-H9	4GB	DS	Hynix	H5TQ2G83BFRH9C	-	-	*	*
KINGMAX	FLFE85F-C8KF9 CAES	2GB	SS	KINGMAX	KFC8FMFXF-DXX-15A	-	-	*	*
KINGMAX	FLFE85F-C8KL9 NAES	2GB	SS	KINGMAX	KFC8FNLFX-DXX-15A	-	-	*	*
KINGMAX	FLFE85F-C8KM9 NAES	2GB	SS	KINGMAX	KFC8FNMXF-BXX-15A	-	-	*	*
KINGMAX	FLFE85F-C8KL9 NEES	2GB	DS	KINGMAX	KKB8FNWBFNGMX-26A	-	-	*	*
KINGMAX	FLFF65F-C8KL9 NEES	4GB	DS	KINGMAX	KFC8FNLFX-DXX-15A	-	-	*	*
KINGMAX	FLFF65F-C8KM9 NEES	4GB	DS	KINGMAX	KFC8FNMXF-BXX-15A	-	-	*	*
KINGSTON	KVR1333D3N9/2G(low profile)	2GB	SS	Hynix	H5TQ2G83AFFFH9C	9	-	*	*
KINGSTON	KVR1333D3S8N9/2G	2GB	SS	Micron	IID77 D9LKG	-	1.5V	*	*
KINGSTON	KVR1333D3S8N9/2G-SP(low profile)	2GB	SS	ELPIDA	J2108BCSE-DJ-F	-	1.5V	*	*
KINGSTON	KVR1333D3N9/2G(low profile)	2GB	DS	ELPIDA	J1108BFBG-DJ-F	9	1.5V	*	*
KINGSTON	KVR1333D3N9/2G	2GB	DS	KTC	D1288JPNDFLD9U	9	1.5V	*	*
KINGSTON	KVR1333D3N9/2G	2GB	DS	ELPIDA	J1108BDSE-DJ-F	9	1.5V	*	*
KINGSTON	KVR1333D3N9/2G-SP(low profile)	2GB	DS	KTC	D1288JEMFNGD9U	-	1.5V	*	*
KINGSTON	KVR1333D3N9/2G-SP(low profile)	2GB	DS	KINGSTON	D1288JPSFFPGD9U	-	1.5V	*	*
KINGSTON	KHX1333C7D3K2/4GX(XMP)	4GB(2 x 2GB)	DS	-	-	7	1.65V	*	*
KINGSTON	KHX1333C9D3UK2/4GX(XMP)	4GB(2 x 2GB)	DS	-	-	9	XMP 1.25V	*	*
KINGSTON	KVR1333D3N9/4G(low profile)	4GB	DS	ELPIDA	J2108BCSE-DJ-F	9	1.5V	*	*
KINGSTON	KVR1333D3N9/4G(low profile)	4GB	DS	ELPIDA	J2108BCSE-DJ-F	-	1.5V	*	*
KINGSTON	KVR1333D3N9/4G	4GB	DS	KTC	D2568JENCNGD9U	-	1.5V	*	*
KINGSTON	KVR1333D3N9/4G	4GB	DS	Hynix	H5TQ2G83AFR	-	-	*	*
KINGSTON	KVR1333D3N9/4G-SP(low profile)	4GB	DS	KINGSTON	D2568JENCNGD9U	-	1.5V	*	*
Micron	MT8JTF25664AZ-1G4D1	2GB	SS	Micron	OJD12D9LKG	-	-	*	*
Micron	MT8JTF25664AZ-1G4M1	2GB	SS	MICRON	IJM22 D9PFJ	-	-	*	*
Micron	MT16JTF25664AZ-1G4F1	2GB	DS	Micron	9KF27D9KPT	9	-	*	*
Micron	MT16JTF51264AZ-1G4D1	4GB	DS	Micron	OLD22D9LKG	-	-	*	*
NANYA	NT4GC64B8HG0NF-CG	4GB	DS	NANYA	NT5CB256M8GN-CG	-	-	*	*
PSC	AL8F8G73F-DJ2	2GB	DS	PSC	A3P1GF3FGF	-	-	*	*
SAMSUNG	M378B5773CH0-CH9	2GB	SS	SAMSUNG	K4B2G0846D	-	-	*	*
SAMSUNG	M378B5673FH0-CH9	2GB	DS	SAMSUNG	K4B1G0846F	-	-	*	*
SAMSUNG	M378B5273CH0-CH9	4GB	DS	SAMSUNG	K4B2G0846C	-	-	*	*
Super Talent	W1333U82GS	2GB	DS	SAMSUNG	K4B1G0846F	9	-	*	*
Super Talent	W1333U84GS	4GB	DS	SAMSUNG	K4B2G0846C	-	-	*	*
Super Talent	W1333U6GM	6GB(3x 2GB)	DS	Micron	0BF27D9KPT	9-9-9-24	1.5V	*	*
KINGSTEK	KSTD3PC-10600	2GB	SS	MICRON	PE911-125E	-	-	*	*

DDR3 1066 MHz capability

Vendors	Part No.	Size	SS/DS	Chip Brand	Chip NO.	Timing	Voltage	DIMM socket support (Optional)	
								1 DIMM	2 DIMMs
Crucial	CT12864BA1067.8FF	1GB	SS	Micron	9GF22D9KPT	7	-	•	•
ELPIDA	EBJ21UE8EDF0-AE-F	2GB	DS	ELPIDA	J1108EDSE-DJ-F	-	1.35V(low voltage)	•	•
KINGSTON	KVR1066D3N7/1G(low profile)	1GB	SS	ELPIDA	J1108BFSE-DJ-F	7	1.5V	•	•
KINGSTON	KVR1066D3N7/4G	4GB	DS	Hynix	H5TQ2G83AFR	7	1.5V	•	•



Side(s): **SS - Single-sided DS - Double-sided**

DIMM support:

- **1 DIMM:** Supports one module inserted into any slot as Single-channel memory configuration.
- **2 DIMMs:** Supports two modules inserted into both the blue slots as one pair of Dual-channel memory configuration.



Visit the ASUS website at www.asus.com for the latest QVL.

1.5.3 Installing a DIMM

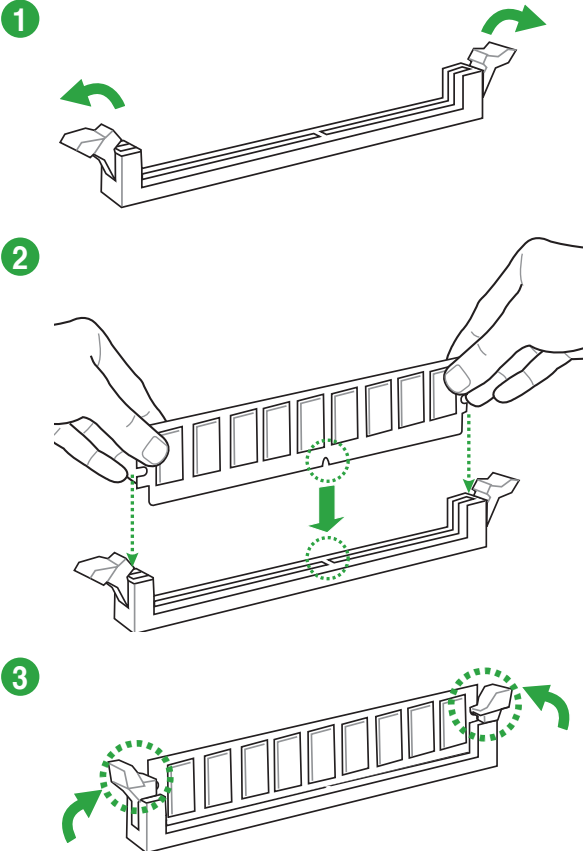

To remove a DIMM

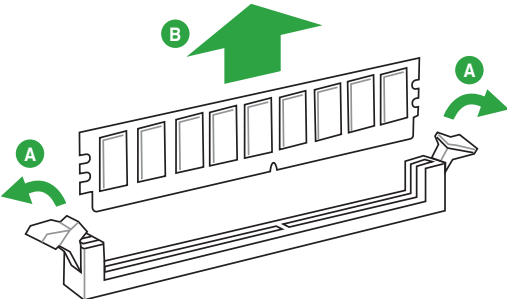

1.6 Expansion slots

In the future, you may need to install expansion cards. The following sub-sections describe the slots and the expansion cards that they support.



Unplug the power cord before adding or removing expansion cards. Failure to do so may cause you physical injury and damage motherboard components.

1.6.1 Installing an expansion card

To install an expansion card:

1. Before installing the expansion card, read the documentation that came with it and make the necessary hardware settings for the card.
2. Remove the system unit cover (if your motherboard is already installed in a chassis).
3. Remove the bracket opposite the slot that you intend to use. Keep the screw for later use.
4. Align the card connector with the slot and press firmly until the card is completely seated on the slot.
5. Secure the card to the chassis with the screw you removed earlier.
6. Replace the system cover.

1.6.2 Configuring an expansion card

After installing the expansion card, configure it by adjusting the software settings.

1. Turn on the system and change the necessary BIOS settings, if any. See Chapter 2 for information on BIOS setup.
2. Assign an IRQ to the card.
3. Install the software drivers for the expansion card.



When using PCI cards on shared slots, ensure that the drivers support "Share IRQ" or that the cards do not need IRQ assignments. Otherwise, conflicts will arise between the two PCI groups, making the system unstable and the card inoperable.

1.6.3 PCI slot

The PCI slot supports cards such as a LAN card, SCSI card, USB card, and other cards that comply with PCI specifications.

1.6.4 PCI Express x1 slot

This motherboard supports PCI Express x1 network cards, SCSI cards, and other cards that comply with the PCI Express specifications.

1.6.5 PCI Express x16 slots

This motherboard supports two PCI Express x16 graphics cards that comply with the PCI Express specifications.

VGA configuration	PCI Express operating mode	
	PCIe x16_1	PCIe x16_2
Single VGA/PCIe card	x16 (Recommended for single VGA card)	N/A
Dual VGA/PCIe card	x16	x4



- In single VGA card mode, use the PCIe 2.0 x16_1 slot (blue) for a PCI Express x16 graphics card to get better performance.
- We recommend that you provide sufficient power when running CrossFireX™ mode. See page 1-24 for details.
- Connect a chassis fan to the motherboard connector labeled CHA_FAN when using multiple graphics cards for better thermal environment.

IRQ assignments for this motherboard

	A	B	C	D	E	F	G	H
PCIEx16_1	-	-	shared	-	-	-	-	-
PCIEx16_2	shared	-	-	-	-	-	-	-
PCIEx1_1	shared	-	-	-	-	-	-	-
PCI1 slot	-	-	-	-	shared	-	-	-
Realtek LAN controller	-	shared	-	-	-	-	-	-
HD audio	shared	-	-	-	-	-	-	-
SATA controller	-	-	-	shared	-	-	-	-
OnChip XHCI controller1	-	-	shared	-	-	-	-	-
OnChip XHCI controller2	-	shared	-	-	-	-	-	-
OnChip USB EHCI 1/2/3	-	shared	-	-	-	-	-	-
OnChip USB OHCI 1/2/3/4	-	-	shared	-	-	-	-	-

1.7 Jumpers

Clear RTC RAM (CLRTC)

This jumper allows you to clear the Real Time Clock (RTC) RAM in CMOS. You can clear the CMOS memory of date, time, and system setup parameters by erasing the CMOS RTC RAM data. The onboard button cell battery powers the RAM data in CMOS, which include system setup information such as system passwords.

To erase the RTC RAM:

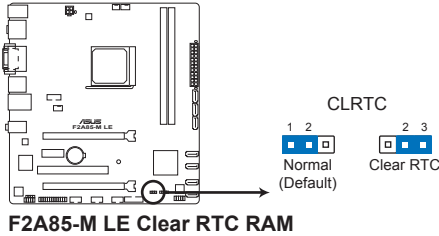

1. Turn OFF the computer and unplug the power cord.
2. Move the jumper cap from pins 1-2 (default) to pins 2-3. Keep the cap on pins 2-3 for about 5~10 seconds, then move the cap back to pins 1-2.
3. Plug the power cord and turn ON the computer.
4. Hold down the **** key during the boot process and enter BIOS setup to reenter data.



Except when clearing the RTC RAM, never remove the cap on CLRTC jumper default position. Removing the cap will cause system boot failure!



- If the steps above do not help, remove the onboard battery and move the jumper again to clear the CMOS RTC RAM data. After clearing the CMOS, reinstall the battery.
 - You do not need to clear the RTC when the system hangs due to overlocking. For system failure due to overlocking, use the CPU Parameter Recall (C.P.R) feature. Shut down and reboot the system so the BIOS can automatically reset parameter settings to default values.
-

1.8 Connectors

1.8.1 Rear panel ports

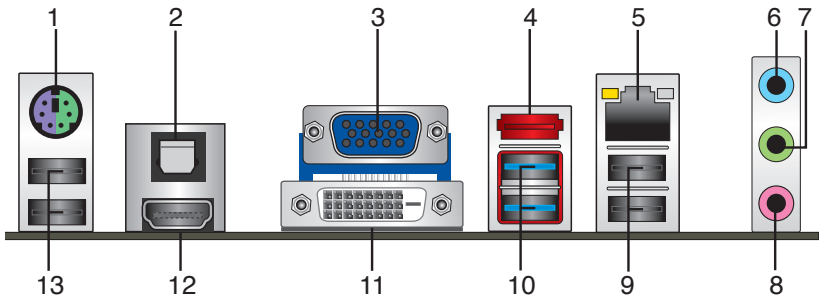

1. **PS/2 keyboard/mouse combo port.** This port is for a PS/2 mouse or PS/2 keyboard.
2. **Optical S/PDIF Out port.** This port connects an external audio output device via an optical S/PDIF cable.
3. **Video Graphics Adapter (VGA) port.** This 15-pin port is for a VGA monitor or other VGA-compatible devices.
4. **eSATA 6Gb/s port.** This port connects to an external Serial ATA hard disk drive.
5. **LAN (RJ-45) port.** This port allows Gigabit connection to a Local Area Network (LAN) through a network hub.

LAN port LED indications

Activity/Link LED		Speed LED	
Status	Description	Status	Description
OFF	No link	OFF	10Mbps connection
ORANGE	Linked	ORANGE	100Mbps connection
BLINKING	Data activity	GREEN	1Gbps connection

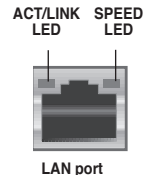

6. **Line In port (light blue).** This port connects to the tape, CD, DVD player, or other audio sources.
7. **Line Out port (lime).** This port connects to a headphone or a speaker. In the 4, 6, and 8-channel configurations, the function of this port becomes Front Speaker Out.
8. **Microphone port (pink).** This port connects to a microphone.



Refer to the audio configuration table on the next page for the function of the audio ports in 2, 4, 6, or 8-channel configuration.

Audio 2, 4, 6, or 8-channel configuration

Port	Headset 2-channel	4-channel	6-channel	8-channel
Light Blue (Rear panel)	Line In	Rear Speaker Out	Rear Speaker Out	Rear Speaker Out
Lime (Rear panel)	Line Out	Front Speaker Out	Front Speaker Out	Front Speaker Out
Pink (Rear panel)	Mic In	Mic In	Bass/Center	Bass/Center
Lime (Front panel)	—	—	—	Side Speaker Out



To configure an 8-channel audio output:

Use a chassis with HD audio module in the front panel to support an 8-channel audio output.

- 9. USB 2.0 ports 1 and 2.** These two 4-pin Universal Serial Bus (USB) ports are for USB 2.0/1.1 devices.
- 10. USB 3.0 ports 1 and 2.** These two 9-pin Universal Serial Bus (USB) ports are for USB 3.0/2.0 devices.



- DO NOT connect a keyboard / mouse to any USB 3.0 port when installing Windows® operating system.
- Due to USB 3.0 controller limitation, USB 3.0 devices can only be used under Windows® OS environment and after the USB 3.0 driver installation.
- USB 3.0 devices can only be used as data storage only.
- We strongly recommend that you connect USB 3.0 devices to USB 3.0 ports for faster and better performance for your USB 3.0 devices.

- 11. DVI-D port.** This port is for any DVI-D compatible device. DVI-D can't be converted to output RGB Signal to CRT and isn't compatible with DVI-I.
- 12. HDMI port.** This port is for a High-Definition Multimedia Interface (HDMI) connector, and is HDCP compliant allowing playback of HD DVD, Blu-ray, and other protected content.
- 13. USB 2.0 ports 3 and 4.** These two 4-pin Universal Serial Bus (USB) ports are for USB 2.0/1.1 devices.

1.8.2 Internal connectors

1. Power, CPU, and chassis fan connectors (3-pin PWR_FAN, 4-pin CPU_FAN, and 4-pin CHA_FAN)

Connect the fan cables to the fan connectors on the motherboard, ensuring that the black wire of each cable matches the ground pin of the connector.

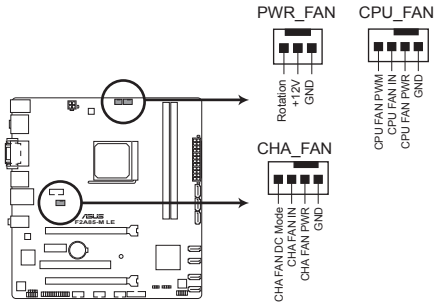

F2A85-M LE Fan connectors



DO NOT forget to connect the fan cables to the fan connectors. Insufficient air flow inside the system may damage the motherboard components. These are not jumpers! DO NOT place jumper caps on the fan connectors.



- The CPU_FAN connector supports a CPU fan of maximum 2A (24 W) fan power.
- Only the CPU_FAN connector support the ASUS Fan Xpert feature.
- If you install two VGA cards, we recommend that you plug the rear chassis fan cable to the motherboard connector labeled CHA_FAN for better thermal environment.

2. ATX power connectors (24-pin EATXPWR, 4-pin ATX12V)

These connectors are for an ATX power supply. The plugs from the power supply are designed to fit these connectors in only one orientation. Find the proper orientation and push down firmly until the connectors completely fit.

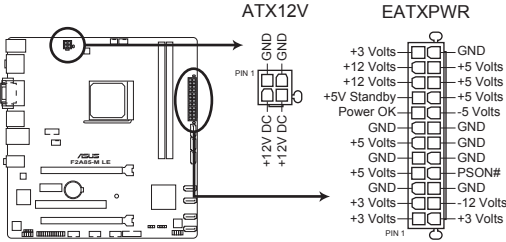

F2A85-M LE ATX power connectors



- We recommend that you use an ATX 12V Specification 2.0-compliant power supply unit (PSU) with a minimum of 300W power rating. This PSU type has 24-pin and 4-pin power plugs.
- If you intend to use a PSU with 20-pin and 4-pin power plugs, ensure that the 20-pin power plug can provide at least 15 A on +12 V and that the PSU has a minimum power rating of 300W. The system may become unstable or may not boot up if the power is inadequate.
- DO NOT forget to connect the 4-pin ATX +12V power plug. Otherwise, the system will not boot up.
- We recommend that you use a PSU with higher power output when configuring a system with more power-consuming devices or when you intend to install additional devices. The system may become unstable or may not boot up if the power is inadequate.
- If you are uncertain about the minimum power supply requirement for your system, refer to the Recommended Power Supply Wattage Calculator at <http://support.asus.com/PowerSupplyCalculator/PSCalculator.aspx?SLanguage=en-us> for details.

3. Serial ATA 6.0 Gb/s connectors (7-pin SATA6G 1~7)

These connectors are for the Serial ATA 6.0 Gb/s signal cables for Serial ATA hard disk drives and optical disc drives. If you installed Serial ATA hard disk drives, you can create a RAID 0, RAID 1, RAID 5, or RAID 10 configuration through the onboard controller.

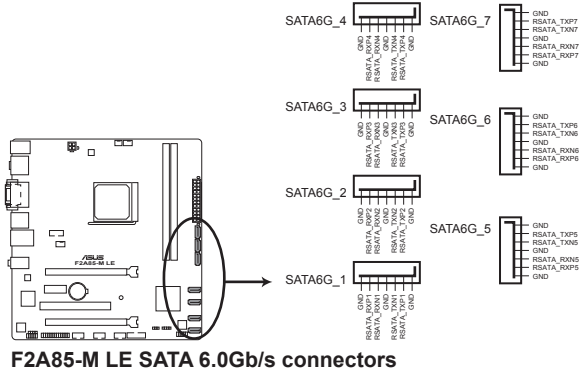

F2A85-M LE SATA 6.0Gb/s connectors



- These connectors are set to AHCI mode by default. If you intend to create a Serial ATA RAID set using these connectors, set the type of the SATA connectors in the BIOS to **[RAID]**. See section **2.5.2 SATA Configuration** for details.
- You must install Windows® XP Service Pack 3 or later version before using Serial ATA hard disk drives. The Serial ATA RAID feature is available only if you are using Windows® XP SP3 or later version.
- When using hot-plug and NCQ, set the type of the SATA connectors in the BIOS to **[AHCI]**. See section **2.5.2 SATA Configuration** for details.

4. System panel connector (10-1 pin PANEL)

This connector supports several chassis-mounted functions.

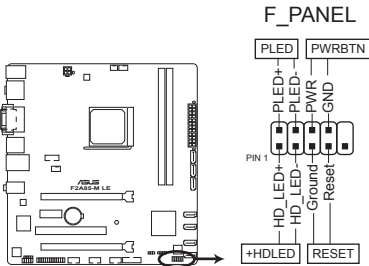

F2A85-M LE System panel connector

- **System power LED (2-pin PLED)**

This 2-pin connector is for the system power LED. Connect the chassis power LED cable to this connector. The system power LED lights up when you turn on the system power, and blinks when the system is in sleep mode.

- **Hard disk drive activity LED (2-pin +IDELED)**

This 2-pin connector is for the HDD Activity LED. Connect the HDD Activity LED cable to this connector. The IDE LED lights up or flashes when data is read from or written to the HDD.

- **ATX power button/soft-off button (2-pin PWRBTN)**

This 2-pin connector is for the system power button.

- **Reset button (2-pin RESET)**

This 2-pin connector is for the chassis-mounted reset button for system reboot without turning off the system power.

5. Speaker connector (4-pin SPEAKER)

The 4-pin connector is for the chassis-mounted system warning speaker. The speaker allows you to hear system beeps and warnings.

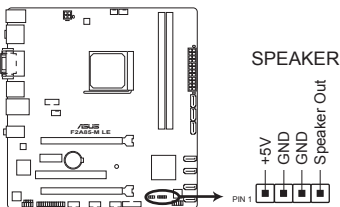

F2A85-M LE Speaker out connector

6. Digital audio connector (4-1 pin SPDIF_OUT)

This connector is for an additional Sony/Philips Digital Interface (S/PDIF) port.

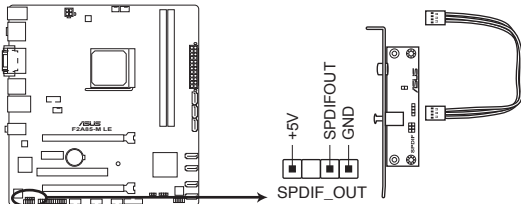

F2A85-M LE Digital audio connector



The S/PDIF module is purchased separately.

7. Front panel audio connector (10-1 pin AAFP)

This connector is for a chassis-mounted front panel audio I/O module that supports either High Definition Audio or AC'97 audio standard. Connect one end of the front panel audio I/O module cable to this connector.

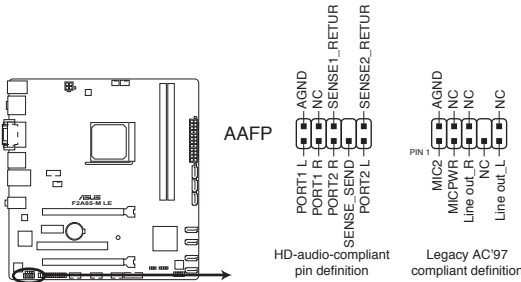

F2A85-M LE Front panel audio connector



- We recommend that you connect a high-definition front panel audio module to this connector to avail of the motherboard high-definition audio capability.
- If you want to connect a high definition front panel audio module to this connector, set the **Front Panel Type** item in the BIOS to **[HD]**. See section 2.5.5 **Onboard Devices Configuration** for details.
- The front panel audio I/O module is purchased separately.

8. USB 2.0 connectors (10-1 pin USB56, USB78, USB910)

These connectors are for USB 2.0 ports. Connect the USB module cable to any of these connectors, then install the module to a slot opening at the back of the system chassis. These USB connectors comply with USB 2.0 specification that supports up to 480Mbps connection speed.

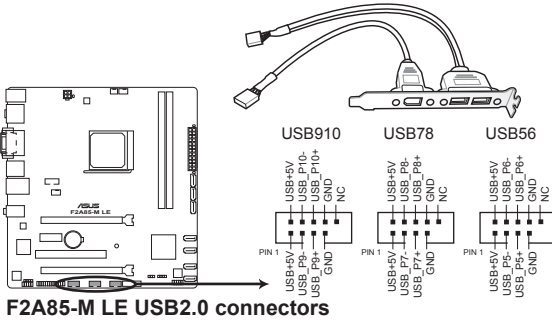

F2A85-M LE USB2.0 connectors



Never connect a 1394 cable to the USB connectors. Doing so will damage the motherboard!



The USB 2.0 module is purchased separately.

9. USB 3.0 connector (20-1 pin USB3_34)

This connector is for the additional USB 3.0 ports, and complies with the USB 3.0 specification that supports up to 4.8Gbps connection speed. If the USB 3.0 front panel cable is available from your system chassis, with this USB 3.0 connector, you can have a front panel USB 3.0 solution.

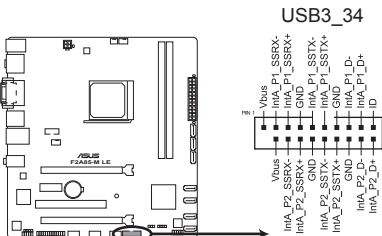

F2A85-M LE USB3.0 front panel connector



You can connect the ASUS front panel USB 3.0 bracket to this connector to obtain the front panel USB 3.0 solution.

10. Serial port connector (10-1 pin COM)

This connector is for a serial (COM) port. Connect the serial port module cable to this connector, then install the module to a slot opening at the back of the system chassis.

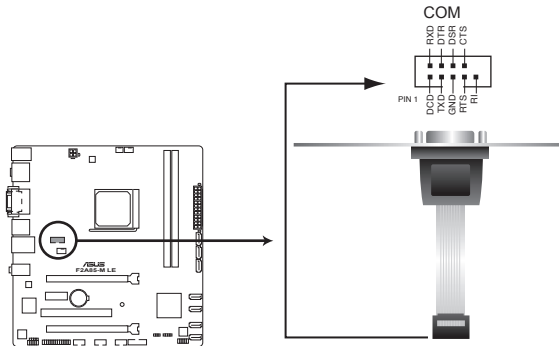

F2A85-M LE Serial port (COM) connector



The COM module is purchased separately.

11. LPT connector (26-1 pin LPT)

The LPT (Line Printing Terminal) connector supports devices such as a printer. LPT standardizes as IEEE 1284, which is the parallel port interface on IBM PC-compatible computers.

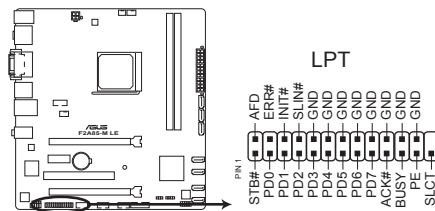

F2A85-M LE LPT connector

1.9 Software support

1.9.1 Installing an operating system

This motherboard supports Windows® XP / Vista / Windows® 7 / Windows® 8 Operating Systems (OS). Always install the latest OS version and corresponding updates to maximize the features of your hardware.



- Motherboard settings and hardware options vary. Refer to your OS documentation for detailed information.
- Ensure that you install Windows® XP Service Pack 3 or later versions / Windows® Vista Service Pack 1 or later versions before installing the drivers for better compatibility and system stability.
- BIOS and drivers updates are required to support Windows® 8.

1.9.2 Support DVD information

The Support DVD that comes with the motherboard package contains the drivers, software applications, and utilities that you can install to avail all motherboard features.



The contents of the Support DVD are subject to change at any time without notice. Visit the ASUS website at www.asus.com for updates.

To run the Support DVD

Place the Support DVD into the optical drive. If Autorun is enabled in your computer, the DVD automatically displays the Specials screen. Click Drivers, Utilities, Make Disk, Manual, and Contact tabs to display their respective menus.



The following screen is for reference only.



Click an icon to display Support DVD/motherboard information

Click an item to install



If Autorun is NOT enabled on your computer, browse the contents of the Support DVD to locate the file ASSETUP.EXE from the BIN folder. Double-click the ASSETUP.EXE to run the DVD.

BIOS information

2

2.1 Managing and updating your BIOS



Save a copy of the original motherboard BIOS file to a USB flash disk in case you need to restore the BIOS in the future. Copy the original motherboard BIOS using the ASUS Update utility.

2.1.1 ASUS Update utility

The ASUS Update is a utility that allows you to manage, save, and update the motherboard BIOS in Windows® environment.



-
- ASUS Update requires an Internet connection either through a network or an Internet Service Provider (ISP).
 - This utility is available in the support DVD that comes with the motherboard package.
-

Installing ASUS Update

To install ASUS Update:

1. Place the support DVD in the optical drive. The **Specials** menu appears.
2. Click the **Utilities** tab, then click **AI Suite II**.
3. Follow the onscreen instructions to complete the installation.



Quit all Windows® applications before you update the BIOS using this utility.

Updating the BIOS

To update the BIOS:

1. From the Windows® desktop, click **Start > Programs > ASUS > AI Suite II > AI Suite II X.XX.XX** to launch the AI Suite II utility. The AI Suite II Quick Bar appears.
2. Click **Update** button from the Quick Bar, and then click **ASUS Update** from the popup menu. The **ASUS Update** main screen appears. From the list, select either of the following methods:

Updating from the Internet

- a. Select **Update BIOS from the Internet**, then click **Next**.
- b. Select the ASUS FTP site nearest you to avoid network traffic, then click **Next**.
- c. From the FTP site, select the BIOS version that you wish to download then click **Next**.



The ASUS Update utility is capable of updating itself through the Internet. Always update the utility to avail all its features.

Updating from a BIOS file

- a. Select **Update BIOS from file**, then click **Next**.
 - b. Locate the BIOS file from the **Open** window, then click **Open**.
3. Follow the onscreen instructions to complete the updating process.

2.1.2 ASUS EZ Flash 2

The ASUS EZ Flash 2 feature allows you to update the BIOS without using an OS-based utility.



Before you start using this utility, download the latest BIOS file from the ASUS website at www.asus.com.

To update the BIOS using EZ Flash 2:

1. Insert the USB flash disk that contains the latest BIOS file to the USB port.
2. Enter the **Advanced Mode** of the BIOS setup program. Go to the **Tool** menu to select **ASUS EZ Flash 2 Utility** and press <Enter> to enable it.
3. Press <Tab> to switch to the **Drive** field.
4. Press the Up/Down arrow keys to find the USB flash disk that contains the latest BIOS, and then press <Enter>.
5. Press <Tab> to switch to the **Folder Info** field.
6. Press the Up/Down arrow keys to find the BIOS file, and then press <Enter> to perform the BIOS update process. Reboot the system when the update process is done.



-
- This function supports USB flash disks with FAT 32/16 format and single partition only.
 - DO NOT shut down or reset the system while updating the BIOS to prevent system boot failure!
-

2.1.3 ASUS CrashFree BIOS 3 utility

The ASUS CrashFree BIOS 3 is an auto recovery tool that allows you to restore the BIOS file when it fails or gets corrupted during the updating process. You can restore a corrupted BIOS file using the motherboard support DVD or a USB flash drive that contains the updated BIOS file.



-
- Before using this utility, rename the BIOS file in the removable device into **F2A85MLE.CAP**.
 - The BIOS file in the support DVD may not be the latest version. Download the latest BIOS file from the ASUS website at www.asus.com.
-

Recovering the BIOS

To recover the BIOS:

1. Turn on the system.
2. Insert the support DVD to the optical drive or the USB flash drive that contains the BIOS file to the USB port.
3. The utility automatically checks the devices for the BIOS file. When found, the utility reads the BIOS file and enters ASUS EZ Flash 2 utility automatically.
4. The system requires you to enter BIOS Setup to recover BIOS setting. To ensure system compatibility and stability, we recommend that you press <F5> to load default BIOS values.



DO NOT shut down or reset the system while updating the BIOS! Doing so can cause system boot failure!

2.1.4 ASUS BIOS Updater

The ASUS BIOS Updater allows you to update BIOS in DOS environment. This utility also allows you to copy the current BIOS file that you can use as a backup when the BIOS fails or gets corrupted during the updating process.



The succeeding utility screens are for reference only. The actual utility screen displays may not be same as shown.

Before updating BIOS

1. Prepare the motherboard support DVD and a USB flash drive in FAT32/16 format and single partition.
2. Download the latest BIOS file and BIOS Updater from the ASUS website at <http://support.asus.com> and save them on the USB flash drive.



NTFS is not supported under DOS environment. Do not save the BIOS file and BIOS Updater to a hard disk drive or USB flash drive in NTFS format.

3. Turn off the computer and disconnect all SATA hard disk drives (optional).

Booting the system in DOS environment

1. Insert the USB flash drive with the latest BIOS file and BIOS Updater to the USB port.
2. Boot your computer. When the ASUS Logo appears, press <F8> to show the **BIOS Boot Device Select Menu**. Insert the support DVD into the optical drive and select the optical drive as the boot device.

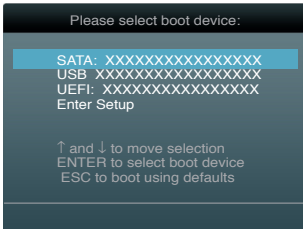

3. When the **Make Disk** menu appears, select the **FreeDOS command prompt** item by pressing the item number.
4. At the FreeDOS prompt, type `d:` and press <Enter> to switch the disk from Drive C (optical drive) to Drive D (USB flash drive).

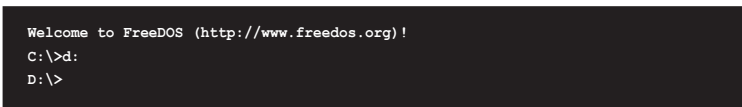

Updating the BIOS file

To update the BIOS file using BIOS Updater

1. At the FreeDOS prompt, type `bupdater /pc /g` and press <Enter>.

```
D:\>bupdater /pc /g
```

2. The BIOS Updater screen appears as below.

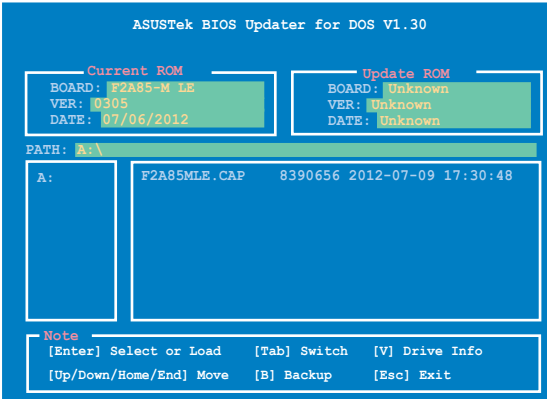

3. Press <Tab> to switch between screen fields and use the <Up/Down/Home/End> keys to select the BIOS file and press <Enter>. BIOS Updater checks the selected BIOS file and prompts you to confirm BIOS update.



4. Select Yes and press <Enter>. When BIOS update is done, press <ESC> to exit BIOS Updater. Restart your computer.



DO NOT shut down or reset the system while updating the BIOS to prevent system boot failure!



- For BIOS Updater version 1.30 or later, the utility automatically exits to the DOS prompt after updating BIOS.
- Ensure to load the BIOS default settings to ensure system compatibility and stability. Select the **Load Optimized Defaults** item under the Exit menu. Refer to section 2.9 **Exit menu** for details.
- Ensure to connect all SATA hard disk drives after updating the BIOS file if you have disconnected them.

2.2 BIOS setup program

Use the BIOS Setup program to update the BIOS or configure its parameters. The BIOS screens include navigation keys and brief online help to guide you in using the BIOS Setup program.

Entering BIOS Setup at startup

To enter BIOS Setup at startup:

- Press <Delete> during the Power-On Self Test (POST). If you do not press <Delete>, POST continues with its routines.

Entering BIOS Setup after POST

To enter BIOS Setup after POST:

- Press <Ctrl>+<Alt>+ simultaneously.
- Press the reset button on the system chassis.
- Press the power button to turn the system off then back on. Do this option only if you failed to enter BIOS Setup using the first two options.



Using the **power button**, **reset button**, or the <Ctrl>+<Alt>+ keys to force reset from a running operating system can cause damage to your data or system. We recommend to always shut down the system properly from the operating system.



- The BIOS setup screens shown in this section are for reference purposes only, and may not exactly match what you see on your screen.
 - Ensure that a USB mouse is connected to your motherboard if you want to use the mouse to control the BIOS setup program.
 - The default BIOS settings for this motherboard apply for most conditions to ensure optimum performance. If the system becomes unstable after changing any BIOS settings, load the default settings to ensure system compatibility and stability. Select the **Load Optimized Defaults** item under the Exit Menu. See section 2.9 **Exit Menu**.
 - If the system fails to boot after changing any BIOS setting, try to clear the CMOS and reset the motherboard to the default value. Refer to section 1.7 **Jumpers** on how to erase the RTC RAM.
 - The BIOS setup program does not support the bluetooth devices.
-

BIOS menu screen

The BIOS setup program can be used under two modes: **EZ Mode** and **Advanced Mode**. You can change modes from the **Exit** menu or from the **Exit/Advanced Mode** button in the **EZ Mode/Advanced Mode** screen.

EZ Mode

By default, the **EZ Mode** screen appears when you enter the BIOS setup program. The **EZ Mode** provides you an overview of the basic system information, and allows you to select the display language, system performance mode and boot device priority. To access the **Advanced Mode**, click **Exit/Advanced Mode**, then select **Advanced Mode** or press F7 hot key for the advanced BIOS settings.



The default screen for entering the BIOS setup program can be changed. Refer to the **Setup Mode** item in section 2.7 **Boot menu** for details.

Selects the display language of the BIOS setup program

Displays the CPU/motherboard temperature, CPU/5V/3.3V/12V voltage output, CPU/chassis fan speed

Exits the BIOS setup program without saving the changes, saves the changes and resets the system, or enters the Advanced Mode

Selects the Advanced mode functions

Selects the boot device priority

Displays the system properties of the selected mode on the right hand side

Power Saving mode

Normal mode

ASUS Optimal mode

Loads optimized default

Displays the Advanced mode menus



- The boot device options vary depending on the devices you installed to the system.
- The **Boot Menu(F8)** button is available only when the boot device is installed to the system.

Advanced Mode

The Advanced Mode provides advanced options for experienced end-users to configure the BIOS settings. The figure below shows an example of the Advanced Mode. Refer to the following sections for the detailed configurations.



To access the EZ Mode, click **Exit**, then select **ASUS EZ Mode**.

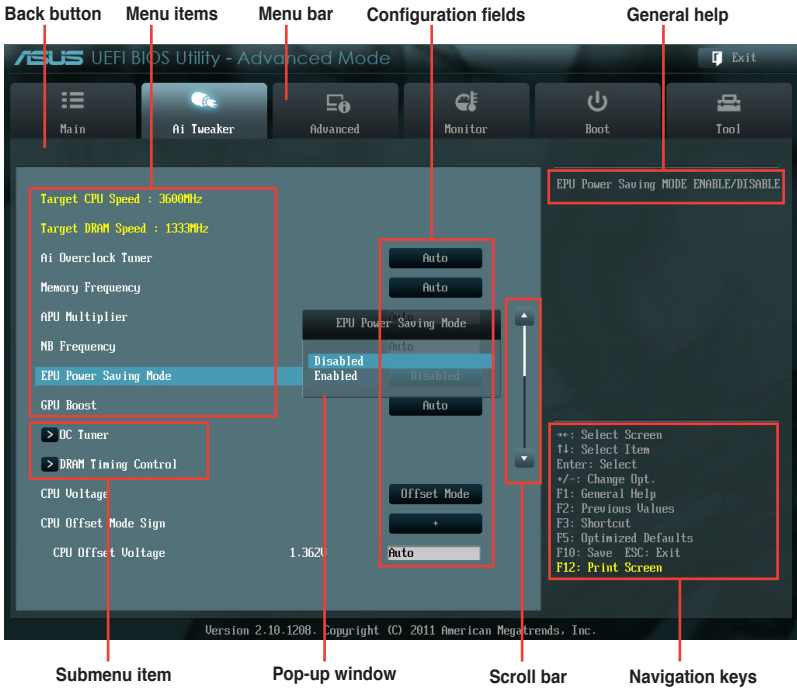

Menu bar

The menu bar on top of the screen has the following main items:

Main	For changing the basic system configuration
Ai Tweaker	For changing the overclocking settings
Advanced	For changing the advanced system settings
Monitor	For displaying the system temperature, power status, and changing the fan settings
Boot	For changing the system boot configuration
Tool	For configuring options for special functions
Exit	For selecting the exit options and loading default settings

Menu items

The highlighted item on the menu bar displays the specific items for that menu. For example, selecting **Main** shows the Main menu items.

The other items (Ai Tweaker, Advanced, Monitor, Boot, Tool, and Exit) on the menu bar have their respective menu items.

Back button

This button appears when entering a submenu. Press <Esc> or use the USB mouse to click this button to return to the previous menu screen.

Submenu items

A greater than sign (>) before each item on any menu screen means that the item has a submenu. To display the submenu, select the item and press <Enter> or double-click the item.

Pop-up window

Select a menu item and press <Enter> to display a pop-up window with the configuration options for that item.

Scroll bar

A scroll bar appears on the right side of a menu screen when there are items that do not fit on the screen. Press the Up/Down arrow keys or <Page Up> / <Page Down> keys to display the other items on the screen.

Navigation keys

At the bottom right corner of the menu screen are the navigation keys for the BIOS setup program. Use the navigation keys to select items in the menu and change the settings.

General help

At the top right corner of the menu screen is a brief description of the selected item.

Configuration fields

These fields show the values for the menu items. If an item is user-configurable, you can change the value of the field opposite the item. You cannot select an item that is not user-configurable.

A configurable field is highlighted when selected. To change the value of a field, select it and press <Enter> or click on it to display a list of options.

2.3 Main menu

The Main menu screen appears when you enter the Advanced Mode of the BIOS Setup program. The Main menu provides you an overview of the basic system information, and allows you to set the system date, time, language, and security settings.



2.3.1 System Language [English]

Allows you to choose the BIOS language version from the options. Configuration options: [English] [Français] [Español] [Deutsch] [Русский] [日本語] [繁體中文] [简体中文]

2.3.2 System Date [Day xx/xx/xxxx]

Allows you to set the system date.

2.3.3 System Time [xx:xx:xx]

Allows you to set the system time.

2.3.4 Security

The Security menu items allow you to change the system security settings.



- If you have forgotten your BIOS password, erase the CMOS Real Time Clock (RTC) RAM to clear the BIOS password. See section 1.7 **Jumpers** for information on how to erase the RTC RAM.
- The **Administrator** or **User Password** items on top of the screen show the default **Not Installed**. After you set a password, these items show **Installed**.

Administrator Password

If you have set an administrator password, we recommend that you enter the administrator password for accessing the system. Otherwise, you might be able to see or change only selected fields in the BIOS setup program.

To set an administrator password:

1. Select the **Administrator Password** item and press <Enter>.
2. From the **Create New Password** box, key in a password, then press <Enter>.
3. Confirm the password when prompted.

To change an administrator password:

1. Select the **Administrator Password** item and press <Enter>.
2. From the **Enter Current Password** box, key in the current password, then press <Enter>.
3. From the **Create New Password** box, key in a new password, then press <Enter>.
4. Confirm the password when prompted.

To clear the administrator password, follow the same steps as in changing an administrator password, but press <Enter> when prompted to create/confirm the password. After you clear the password, the **Administrator Password** item on top of the screen shows **Not Installed**.

User Password

If you have set a user password, you must enter the user password for accessing the system. The **User Password** item on top of the screen shows the default **Not Installed**. After you set a password, this item shows **Installed**.

To set a user password:

1. Select the **User Password** item and press <Enter>.
2. From the **Create New Password** box, key in a password, then press <Enter>.
3. Confirm the password when prompted.

To change a user password:

1. Select the **User Password** item and press <Enter>.
2. From the **Enter Current Password** box, key in the current password, then press <Enter>.
3. From the **Create New Password** box, key in a new password, then press <Enter>.
4. Confirm the password when prompted.

To clear the user password, follow the same steps as in changing a user password, but press <Enter> when prompted to create/confirm the password. After you clear the password, the **User Password** item on top of the screen shows **Not Installed**.

2.4 Ai Tweaker menu

The Ai Tweaker menu items allow you to configure overclocking-related items.



Be cautious when changing the settings of the Ai Tweaker menu items. Incorrect field values can cause the system to malfunction.



The configuration options for this section vary depending on the CPU and DIMM model you installed on the motherboard.

ASUS EFI BIOS Utility - Advanced Mode

Exit

Main | **Ai Tweaker** | Advanced | Monitor | Boot | Tool

Target CPU Speed: 3600MHz
Target DRAM Speed: 1333MHz

Ai Overclock Tuner Auto

Memory Frequency Auto

APU Multiplier Auto

NB Frequency Auto

EPU Power Saving Mode Disabled

GPU Boost Auto

> OC Tuner

> DRAM Timing Control

CPU Voltage Offset Mode

CPU Offset Mode Sign +

CPU Offset Voltage 1.362V Auto

VDDNB Offset Mode Sign +

VDDNB Offset Voltage 1.187V Auto

Select the target CPU frequency, and the relevant parameters will be auto-adjusted.

--+-- Select Screen
↑↓ Select Item
Enter Select
+/- Change Opt.
F1: General Help
F2: Previous Values
F5: Optimized Defaults
F10: Save ESC: Exit
F12: Print Screen

Version 2.10.1208. Copyright (C) 2012 American Megatrends, Inc.

Scroll down to display the following items:

DRAM Voltage 1.500V Auto

SB 1.1V Voltage 1.100V Auto

1.1Vsb Voltage 1.100V Auto

APU1.2V Voltage 1.200V Auto

VDDA Voltage 2.500V Auto

Digi + VRM

CPU Load Line Calibration Auto

CPU/NB Load Line Calibration Auto

CPU Current Capability 100%

CPU/NB Current Capability 100%

CPU Power Phase Control Standard

CPU Voltage Frequency Auto

CPU Power Duty Control T.Probe

--+-- Select Screen
↑↓ Select Item
Enter Select
+/- Change Opt.
F1: General Help
F2: Previous Values
F5: Optimized Defaults
F10: Save ESC: Exit
F12: Print Screen

Version 2.10.1208. Copyright (C) 2012 American Megatrends, Inc.

Target CPU Speed : xxxxMHz

Displays the current CPU speed.

Target DRAM Speed : xxxxMHz

Displays the current DRAM speed.

2.4.1 Ai Overclock Tuner [Auto]

Allows you to select the CPU overclocking options to achieve the desired CPU internal frequency. Select any of these preset overclocking configuration options:

- [Auto] Loads the optimal settings for the system.
- [Manual] Allows you to individually set overclocking parameters.

APU Frequency [XXX]

This item appears only when you set the **Ai Overclock Tuner** item to [Manual]. Use the <+> and <-> keys to adjust the value. You can also key in the desired value using the numeric keypad. The values range from 90.0MHz to 300.0MHz.

2.4.2 Memory Frequency [Auto]

Allows you to set the memory operating frequency. Configuration options: [Auto] [DDR3-800MHz] [DDR3-1066MHz] [DDR3-1333MHz] [DDR3-1600MHz] [DDR3-1866MHz] [DDR3-2133MHz] [DDR3-2400MHz]



Selecting a very high memory frequency may cause the system to become unstable! If this happens, revert to the default setting.

2.4.3 APU Multiplier [Auto]

Allows you to set the multiplier between the CPU Core Clock and the FSB Frequency. Use the <+> and <-> keys to adjust the ratio. The valid value ranges vary according to your CPU model.

2.4.4 NB Frequency [Auto]

Allows you to adjust the NB frequency. Use the <+> and <-> keys to adjust the value. You can also key in the desired value using the numeric keypad.

2.4.5 EPU Power Saving Mode [Disabled]

Allows you to enable or disable the EPU power saving function. Configuration options: [Disabled] [Enabled]

EPU Setting [Auto]

This item appears only when The EPU Power Saving Mode is set to [Enabled] and allows you to set power saving mode. Configuration options: [Auto] [Light Power Saving Mode] [Medium Power Saving Mode] [Max Power Saving Mode]

2.4.6 GPU Boost [Auto]

- [Auto] Automatic configuration.
- [Turbo Mode] Set to [Turbo Mode] to achieve better 3D performance.
- [Extreme Mode] Set to [Extreme Mode] for the excellent visual experience.
- [Manual Mode] Set to [Manual Mode] if you want to manually select the desired GPU Engine frequency.



The following item appears only when you set the GPU Boost item to [Manual Mode].

GPU Engine Frequency [Auto]

Allows you to set the GPU Engine Frequency. Configuration options: [Auto] [GPU O.C. 434MHz] [GPU O.C. 447MHz] [GPU O.C. 460MHz] [GPU O.C. 475MHz] ~ [GPU O.C. 1381MHz] [GPU O.C. 1520MHz] [GPU O.C. 1688MHz] [GPU O.C. 1900MHz]

2.4.7 OC Tuner

OC Tuner automatically overclocks the frequency and voltage of CPU and DRAM for enhancing the system performance. Press <Enter> and select **OK** to start automatic overclocking.

2.4.8 DRAM Timing Control

The sub-items in this menu allow you to set the DRAM timing control features. Use the <+> and <-> keys to adjust the value. To restore the default setting, type [auto] using the keyboard and press <Enter>.



Changing the values in this menu may cause the system to become unstable! If this happens, revert to the default settings.

2.4.9 CPU Voltage [Offset Mode]

[Offset Mode] To offset the voltage by a positive or negative value.

CPU Offset Mode Sign [+]

- [+] To offset the voltage by a positive value.
- [-] To offset the voltage by a negative value.

CPU Offset Voltage [Auto]

Allows you to set the CPU Offset voltage. The values range from 0.00625V to 0.325V with a 0.00625V interval.



Refer to the CPU documentation before setting the CPU voltage. Setting a high voltage may damage the CPU permanently, and setting a low voltage may make the system unstable.

VDDNB Offset Mode Sign [+]

- [+] To offset the voltage by a positive value.
- [-] To offset the voltage by a negative value.

VDDNB Offset Voltage [Auto]

Allows you to set the VDDNB Offset voltage. The values range from 0.00625V to 0.500V with a 0.00625V interval.

2.4.10 DRAM Voltage [Auto]

Allows you to set the DRAM voltage. The values range from 1.35V to 2.00V with a 0.005V interval.

2.4.11 SB 1.1V Voltage [Auto]

Allows you to set the Southbridge 1.1V voltage. The values range from 1.1V to 1.4V with a 0.01V interval.

2.4.12 1.1Vsb Voltage [Auto]

Allows you to set the 1.1Vsb voltage. The values range from 1.1000V to 1.4000V with a 0.1V interval.

2.4.13 APU1.2V Voltage [Auto]

Allows you to set the APU (Accelerated Processor Unit) 1.2V voltage. The values range from 1.2000V to 1.8000V with a 0.01V interval.

2.4.14 VDDA Voltage [Auto]

Allows you to set the VDDA voltage. The values range from 2.5000V to 2.8000V with a 0.1V interval.



-
- The values of the **CPU Offset Voltage**, **VDDNB Offset Voltage**, **DRAM Voltage**, **SB 1.1V Voltage**, **1.1Vsb Voltage**, **APU1.2V Voltage**, and **VDDA Voltage** items are labeled in different color, indicating the risk levels of high voltage settings.
 - The system may need better cooling system to work stably under high voltage settings.
-

2.4.15 DIGI+ VRM

CPU Load Line Calibration [Auto]

Load-line Calibration is defined by AMD VRM specifications and affects CPU voltage. The CPU working voltage will decrease proportionally to CPU loading. Higher load-line calibration would get higher voltage and better overclocking performance, but increase the CPU and VRM thermal. This item allows you to adjust the voltage range from the following percentages to boost the system performance: 0% (Regular), 60% (Medium), 80% (High), and 100% (Extreme). Configuration options: [Auto] [Regular] [Medium] [High] [Extreme]



The actual performance boost may vary depending on your CPU specification.

CPU/NB Load Line Calibration [Auto]

Allows you to select the CPU/NB Load-Line Calibration mode. Configuration options: [Auto] [Regular] [High] [Extreme]

CPU Current Capability [100%]

This item provides wider total power range for overclocking. A higher value brings a wider total power range and extends the overclocking frequency range simultaneously. Configuration options: [100%] [110%] [120%] [130%]

CPU/NB Current Capability [100%]

This item provides wider total power range for overclocking. A higher value brings a wider total power range and extends the overclocking frequency range simultaneously. Configuration options: [100%] [110%] [120%] [130%]

CPU Power Phase Control [Standard]

Phase number is the number of working VRM phase. Increasing phase number under heavy system loading to get more transient and better thermal performance. Reducing phase number under light system loading to increase VRM efficiency.

- [Standard] Proceeds phase control depending on the CPU loading.
- [Optimized] Loads the ASUS optimized phase tuning profile.
- [Extreme] Proceeds the full phase mode.
- [Manual Adjustment] Allows manual adjustment.

Manual Adjustment [Fast]

Select [Ultra Fast] for a faster response. The reaction time will be longer when [Regular] is selected. Configuration options: [Ultra Fast] [Fast] [Medium] [Regular]

CPU Voltage Frequency [Auto]

Switching frequency will affect the VRM transient response and component thermal. Setting a higher frequency gets faster transient response. Configuration options: [Auto] [Normal] [Medium] [High] [Extreme]

CPU Power Duty Control [T.Probe]

- [T.Probe] Maintains the VRM thermal balance.
- [Extreme] Maintains the VRM current balance.



Do not remove the thermal module while changing the DIGI+VRM related parameters. The thermal conditions should be monitored.

2.5 Advanced menu

The Advanced menu items allow you to change the settings for the CPU and other system devices.



Be cautious when changing the settings of the Advanced menu items. Incorrect field values can cause the system to malfunction.

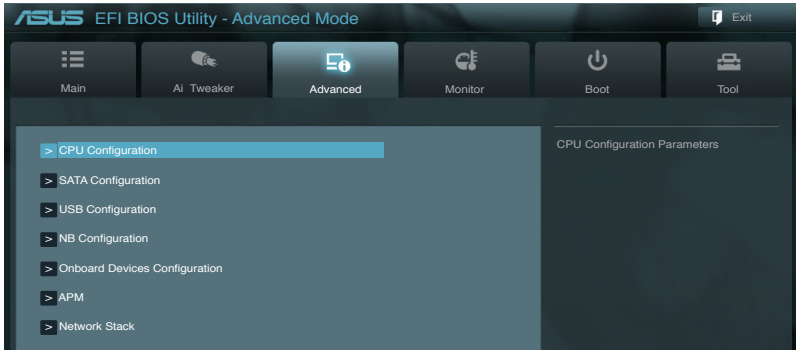

2.5.1 CPU Configuration

The items in this menu show the CPU-related information that the BIOS automatically detects.



The items shown in submenu may be different due to the CPU you installed.

AMD PowerNow function [Enabled]

Enables or disables the AMD PowerNow function. Configuration options: [Enabled] [Disabled]

NX Mode [Enabled]

Enables or disables the No-execute page protection function. Configuration options: [Enabled] [Disabled]

SVM [Enabled]

Enables or disables CPU virtualization. Configuration options: [Disabled] [Enabled]

CPB Mode [Auto]

Disables the CPB (Core Performance Boost) mode or set it to [Auto] for automatic configuration. Configuration options: [Disabled] [Auto]

C6 Mode [Disabled]

Enables or disables C6 mode. Configuration options: [Enabled] [Disabled]

IOMMU [Disabled]

Set this item to [Enabled] to show IOMMU Mode. Configuration options: [Enabled] [Disabled]

2.5.2 SATA Configuration

While entering Setup, the BIOS automatically detects the presence of SATA devices. The SATA Port items show **Not Present** if no SATA device is installed to the corresponding SATA port.

OnChip SATA Channel [Enabled]

Enables or disables onboard channel SATA port. Configuration options: [Disabled] [Enabled]

OnChip SATA Type [AHCI]

Allows you to set the SATA configuration.

- [IDE] Set to [IDE] when you want to use the Serial ATA hard disk drives as Parallel ATA physical storage devices.
- [RAID] Set to [RAID] when you want to create a RAID configuration from the SATA hard disk drives.
- [AHCI] Set to [AHCI] when you want the SATA hard disk drives to use the AHCI (Advanced Host Controller Interface). The AHCI allows the onboard storage driver to enable advanced Serial ATA features that increases storage performance on random workloads by allowing the drive to internally optimize the order of commands.

SATA Port 5, 6, 7, eSATA [AHCI]

This item only appears when **OnChip SATA Type** is set to [AHCI]. If SATA ports 5, 6, 7, and the eSATA port are configured as [AHCI], the ports can only be used under OS with driver installed. Set to [IDE] instead of [AHCI] to access devices on SATA ports 5, 6, 7, and the eSATA port before entering OS. Configuration options: [AHCI] [IDE]

SATA Port 5, 6, 7, eSATA [RAID]

This item only appears when **OnChip SATA Type** is set to [RAID]. If SATA ports 5, 6, 7, and the eSATA port are configured as [RAID], the ports can only be used under OS with driver installed. Set to [IDE] instead of [RAID] to access devices on SATA ports 5, 6, 7, and the eSATA port before entering OS. Configuration options: [RAID] [IDE]

Board SATA RAID ROM [Legacy ROM]

This item only appears when **OnChip SATA Type** is set to [RAID].

- [Disabled] Disables this function.
- [Legacy ROM] Select this option when using legacy operating systems.
- [UEFI DRIVER] Select this option when using UEFI operating systems.

OnChip SATA MAX Speed [SATA 6.0Gb/s]

Sets the maximum onboard SATA port speed. Configuration options: [SATA 3.0Gb/s] [SATA 6.0Gb/s]

S.M.A.R.T. Status Check [Enabled]

S.M.A.R.T. (Self-Monitoring, Analysis and Reporting Technology) is a monitor system. When read/write of your hard disk errors occur, this feature allows the hard disk to report warning messages during the POST. Configuration options: [Enabled] [Disabled]

2.5.3 USB Configuration

The items in this menu allow you to change the USB-related features.



The **USB Devices** item shows the auto-detected values. If no USB device is detected, the item shows None.

Legacy USB Support [Enabled]

[Enabled] Enables the support for USB devices on legacy operating systems (OS).

[Disabled] The USB devices can be used only for the BIOS setup program.

[Auto] Allows the system to detect the presence of USB devices at startup. If detected, the USB controller legacy mode is enabled. If no USB device is detected, the legacy USB support is disabled.

Legacy USB3.0 Support [Enabled]

[Enabled] Enables the support for USB 3.0 devices on legacy operating systems (OS).

[Disabled] Disables the function.

EHCI Hand-off [Disabled]

[Enabled] Enables the support for operating systems without an EHCI hand-off feature.

[Disabled] Disables the function.

2.5.4 NB Configuration

IGFX Multi-Monitor [Disabled]

Enables or disables the Internal Graphics Device Multi-Monitor support for add-on VGA devices. And the memory size of Internal Graphics Device will keep memory reserved.

Configuration options: [Disabled] [Enabled]



The **IGFX Multi-Monitor** item must be enabled before using AMD® Dual Graphics and LucidLogix Virtu MVP technologies.

Primary Video Device [PCIe / PCI Video]

Selects the primary display device. Configuration options: [IGFX Video] [PCIe / PCI Video]

Integrated Graphics [Auto]

Enables the integrated graphics controller. Configuration options: [Auto] [Force]

UMA Frame Buffer Size [Auto]

This item appears only when you set the previous item to [Force]. Configuration options: [Auto] [32M] [64M] [128M] [256M]

2.5.5 Onboard Devices Configuration

HD Audio Device [Enabled]

[Enabled] Enables the High Definition Audio Controller.

[Disabled] Disables the controller.



The following two items appear only when you set the **HD Audio Device** item to [Enabled].

Front Panel Type [HD]

Allows you to set the front panel audio connector (AAFP) mode to legacy AC'97 or high-definition audio depending on the audio standard that the front panel audio module supports.

[HD] Sets the front panel audio connector (AAFP) mode to high definition audio.

[AC97] Sets the front panel audio connector (AAFP) mode to legacy AC'97.

SPDIF Out Type [SPDIF]

[SPDIF] Sets to [SPDIF] for SPDIF audio output.

[HDMI] Sets to [HDMI] for HDMI audio output.

Realtek LAN Controller [Enabled]

[Enabled] Enables the Realtek LAN controller.

[Disabled] Disables the controller.

Realtek PXE OPROM [Disabled]

This item appears only when you set the **Realtek LAN Controller** item to [Enabled] and allows you to enable or disable the Rom Help of the Realtek LAN controller. Configuration options: [Enabled] [Disabled]

Serial Port Configuration

The sub-items in this menu allow you to set the serial port configuration.

Serial Port [Enabled]

Allows you to enable or disable the serial port (COM). Configuration options: [Enabled] [Disabled]

Change Settings [IO=3F8h; IRQ=4]

Allows you to select the Serial Port base address. Configuration options: [IO=3F8h; IRQ=4] [IO=2F8h; IRQ=3] [IO=3E8h; IRQ=4] [IO=2E8h; IRQ=3]

Parallel Port Configuration [Enabled]

The sub-items in this menu allow you to set the parallel port configuration.

Parallel Port [Enabled]

Allows you to enable or disable the parallel port (LPT/LPTE). Configuration options: [Enabled] [Disabled]

Change Settings [Auto]

Allows you to select the Parallel Port base address. Configuration options: [IO=378h; IRQ=5] [IO=378h; IRQ=5,6,7,9,10,11,12] [IO=278h; IRQ=5,6,7,9,10,11,12] [IO=3BCh; IRQ=5,6,7,9,10,11,12]

Device Mode [Auto]

Allows you to set the Printer port mode. Configuration options: [STD Printer Mode] [SPP Mode] [EPP-1.9 and SPP Mode] [EPP-1.7 and SPP Mode]

2.5.6 APM

Restore AC Power Loss [Power Off]

- [Power On] The system goes into on state after an AC power loss.
- [Power Off] The system goes into off state after an AC power loss.
- [Last State] The system goes into either off or on state, whatever the system state was before the AC power loss.

Power On By PS/2 Keyboard [Disabled]

- [Disabled] Disables the Power On by a PS/2 keyboard.
- [Space Bar] Sets the Space Bar on the PS/2 keyboard to turn on the system.
- [Ctrl-Esc] Sets the Ctrl+Esc key on the PS/2 keyboard to turn on the system.
- [Power Key] Sets Power key on the PS/2 keyboard to turn on the system. This feature requires an ATX power supply that provides at least 1A on the +5VSB lead.

Power On By PS/2 Mouse [Disabled]

- [Disabled] Disables the Power On by a PS/2 mouse.
- [Enabled] Enables the Power On by a PS/2 mouse. This feature requires an ATX power supply that provides at least 1A on the +5VSB lead.

Power On By PME [Disabled]

- [Disabled] Disables the PME to wake up by PCI/PCIE devices.
- [Enabled] Allows you to turn on the system through a PCI/PCIE LAN or modem card. This feature requires an ATX power supply that provides at least 1A on the +5VSB lead.

Power On By Ring [Disabled]

- [Disabled] Disables Ring to generate a wake event.
- [Enabled] Enables Ring to generate a wake event.

Power On By RTC [Disabled]

- [Disabled] Disables RTC to generate a wake event.
- [Enabled] When set to [Enabled], the items **RTC Alarm Date (Days) and Hour/Minute/Second** will become user-configurable with set values.

RTC Alarm Date (Days)

This item appears only when you set the previous item to [Enabled] and allows you to select RTC alarm time (days). When you set the time to zero, the RTC alarms everyday. Use <+> and <-> keys to adjust the time.

- Hour / - Minute / - Second

Allows you to set the RTC alarm time. Use <+> and <-> keys to adjust the time.

2.5.7 Network Stack

Network Stack [Disable Link]

This item allows user to disable or enable the UEFI network stack. Configuration options: [Disable Link] [Enabled]

Ipv4 PXE Support [Enabled]

This item appears only when you set the Network Stack item to [Enabled]. When this item is disabled, the IPV4 PXE boot option will not be created. Configuration options: [Disable Link] [Enabled]

Ipv6 PXE Support [Enabled]

This item appears only when you set the Network Stack item to [Enabled]. When this item is disabled, the IPV6 PXE boot option will not be created. Configuration options: [Disable Link] [Enabled]

2.6 Monitor menu

The Monitor menu displays the system temperature/power status, and allows you to change the fan settings.



2.6.1 CPU Temperature / MB Temperature [xxx°C/xxx°F]

The onboard hardware monitor automatically detects and displays the CPU and motherboard temperatures. Select **Ignore** if you do not wish to display the detected temperatures.

2.6.2 CPU_FAN / CHA_FAN / PWR_FAN Speed [xxxx RPM] or [Ignore] / [N/A]

The onboard hardware monitor automatically detects and displays the CPU / chassis fan speeds in rotations per minute (RPM). If the fan is not connected to the motherboard, the field shows **N/A**. Select **Ignore** if you do not wish to display the detected speed.

2.6.3 CPU Q-Fan Control [Enabled]

[Disabled] Disables the CPU Q-Fan control feature.

[Enabled] Enables the CPU Q-Fan control feature.

CPU Speed Low Limit [200 RPM]

This item appears only when you enable the **CPU Q-Fan Control** feature and allows you to disable or set the CPU fan warning speed. Configuration options: [Ignore] [200RPM] [300 RPM] [400 RPM] [500 RPM] [600 RPM]

CPU Profile [Standard]

This item appears only when you enable the **CPU Q-Fan Control** feature and allows you to set the appropriate performance level of the CPU fan.

[Standard] Sets to [Standard] to make the CPU fan automatically adjust depending on the CPU temperature.

[Silent] Sets to [Silent] to minimize the fan speed for quiet CPU fan operation.

[Turbo] Sets to [Turbo] to achieve maximum CPU fan speed.

[Manual] Sets to [Manual] to assign detailed fan speed control parameters.



The following four items appear only when you set **CPU Profile** to [Manual].

CPU_FAN Upper Temperature [70°C]

Use the <+> and <-> keys to adjust the upper limit of the CPU temperature. The values range from 20°C to 90°C.

CPU_FAN Fan Max. Duty Cycle(%) [100%]

Use the <+> and <-> keys to adjust the maximum CPU fan duty cycle. The values range from 40% to 100%. When the CPU temperature reaches the upper limit, the CPU fan will operate at the maximum duty cycle.

CPU_FAN Lower Temperature [20°C]

Displays the lower limit of the CPU temperature.

CPU_FAN Fan Min. Duty Cycle(%) [40%]

Use the <+> and <-> keys to adjust the minimum CPU fan duty cycle. The values range from 40% to 100%. When the CPU temperature is under the lower limit, the CPU fan will operate at the minimum duty cycle.

2.6.4 CPU Voltage, 3.3V Voltage, 5V Voltage, 12V Voltage

The onboard hardware monitor automatically detects the voltage output through the onboard voltage regulators. Select **Ignore** if you do not want to detect this item.

2.6.5 Anti Surge Support [Enabled]

This item allows you to enable or disable the Anti Surge function. Configuration options:
[Disabled] [Enabled]

2.7 Boot menu

The Boot menu items allow you to change the system boot options.



Scroll down to display the following items:

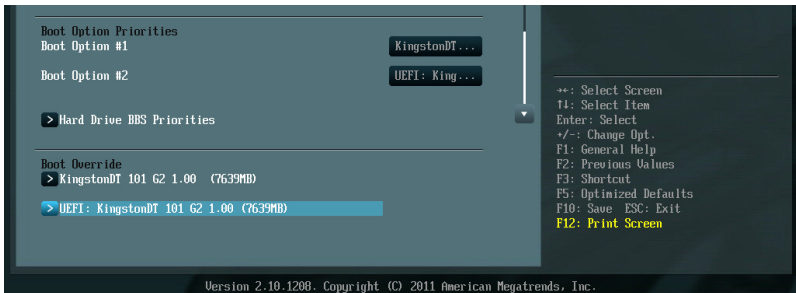

2.7.1 Bootup NumLock State [On]

[On] Sets the power-on state of the NumLock to [On].

[Off] Sets the power-on state of the NumLock to [Off].

2.7.2 Full Screen Logo [Enabled]

[Enabled] Enables the full screen logo display feature.

[Disabled] Disables the full screen logo display feature.



Set this item to [Enabled] to use the ASUS MyLogo 2™ feature.

Post Report [5 sec]

This item appears only when the Full Screen Logo item is set to [Disabled] and allows you to set the waiting time for the system to display the post report. Configuration options: [1 sec] [2 sec] [3 sec] [4 sec] [5 sec] [6 sec] [7 sec] [8 sec] [9 sec] [10 sec] [Until Press ESC]

2.7.3 Fast Boot [Enabled]

Enable or disable boot with initialization of a minimal set of devices to launch active boot option. Configuration options: [Disabled] [Enabled]



The following three items appear only when you set **Fast Boot** to [Enabled].

USB Support [Partial Initial]

- [Disabled] All USB devices will not be available until OS boot up for a fastest POST time.
- [Full Initial] All USB devices will be available during POST. This process will extend the POST time.
- [Partial Initial] For a faster POST time, only the USB ports with keyboard and mouse connections will be detected.

PS2 Devices Support [Enabled]

- [Disabled] The BIOS skips over the PS/2 keyboard and mouse and tries to boot from the next device.
- [Enabled] Allows the BIOS to boot from PS/2 devices.

Network Stack Driver Support [Disabled]

- [Disabled] The BIOS skips over the Network Stack Driver and tries to boot from the next device.
- [Enabled] Allows the BIOS to boot from the Network Stack Driver.

2.7.4 Post Delay Time [3 sec]

Allows you to set the POST Report wait time. This configuration only functions in Normal Boot mode. Configuration options: [0 sec] [1 sec] [2 sec] [3 sec] [4 sec] [5 sec] [6 sec] [7 sec] [8 sec] [9 sec] [10 sec]

2.7.5 Wait for 'F1' If Error [Enabled]

When this item is set to [Enabled], the system waits for the F1 key to be pressed when error occurs. Configuration options: [Disabled] [Enabled]

2.7.6 Option ROM Messages [Force BIOS]

- [Force BIOS] The third-party ROM messages will be forced to display during the boot sequence.
- [Keep Current] The third-party ROM messages will be displayed only if the third-party manufacturer had set the add-on device to do so.

2.7.7 Next boot after AC Power Loss [Normal Boot]

[Normal Boot] Returns to normal boot on the next boot after an AC power loss.

[Fast Boot] Accelerates the boot speed on the next boot after an AC power loss.

2.7.8 CSM Parameters

This option controls whether or not CSM (Compatibility Support Module) will be launched.

Launch CSM [Auto]

Configuration option: [Auto] [Enabled] [Disabled]



The following four items appear only when you set **Launch CSM** to [Enabled].

Boot Device Control [UEFI and Legacy OpROM]

Configuration option: [UEFI and Legacy OpRom] [Legacy OpROM only] [UEFI only]

Boot from Network Devices [Legacy OpROM first]

Configuration option: [Legacy OpROM first] [UEFI driver first] [Ignore]

Boot from Storage Devices [Legacy OpRom first]

Configuration option: [Both, Legacy OpROM first] [Both, UEFI driver first] [Legacy OpROM first] [UEFI driver first] [Ignore]

Boot from PCIe/PCI Expansion Devices [Legacy OpROM first]

Configuration option: [Legacy OpROM first] [UEFI driver first]

2.7.9 Security Boot parameters

This option allows you to configure the Secure Boot related parameters.

OS Type [Windows 8 UEFI]

Configuration option: [Windows 8 UEFI] [Other Legacy & UEFI]

Secure Boot Mode [Standard]

This item appears only when you set the OS Type to [Windows 8 UEFI]. Configuration option: [Standard] [Custom]



The following items appear when **Secure Boot Mode** is set to [Custom].

Key Management

Default Key Provisioning [Disabled]

Configuration options: [Enabled] [Disabled]

Manage All Factory Keys (PK, KEK, DB, DBX)

Install default Secure Boot Keys

Configuration options: [Yes] [No]

Platform Key (PK)

Set PK from File

Configuration options: [Acpi (a0341d0, 0)\PCI (1212)\USB (2, 0)]

Get PK to File

Configuration options: [OK]

Delete the PK

Configuration options: [Yes] [No]

Key Exchange Key Database (KEK)

Set KEK from File

Configuration options: [OK]

Get KEK to File

Configuration options: [OK]

Delete the KEK

Configuration options: [Yes] [No]

Append an entry to KEK

Configuration options: [OK]

Authorized Signature Database

Set DB from File

Configuration options: [OK]

Get DB to File

Configuration options: [OK]

Delete the DB

Configuration options: [Yes] [No]

Append an entry to DB

Configuration options: [OK]

Forbidden Signature Database

Set DBX from File

Configuration options: [OK]

Get DBX to File

Configuration options: [OK]

Delete the DBX

Configuration options: [Yes] [No]

Append an entry to DBX

Configuration options: [OK]

2.7.10 Setup Mode [EZ Mode]

[Advanced Mode] Sets Advanced Mode as the default screen for entering the BIOS setup program.

[EZ Mode] Sets EZ Mode as the default screen for entering the BIOS setup program.

2.7.11 Boot Option Priorities

These items specify the boot device priority sequence from the available devices. The number of device items that appears on the screen depends on the number of devices installed in the system.



-
- To select the boot device during system startup, press <F8> when ASUS Logo appears.
 - To access Windows OS in Safe Mode, press <F8> after POST.
-

2.7.12 Boot Override

These items displays the available devices. The number of device items that appears on the screen depends on the number of devices installed in the system. Click an item to start booting from the selected device.

2.8 Tools menu

The Tools menu items allow you to configure options for special functions. Select an item then press <Enter> to display the submenu.

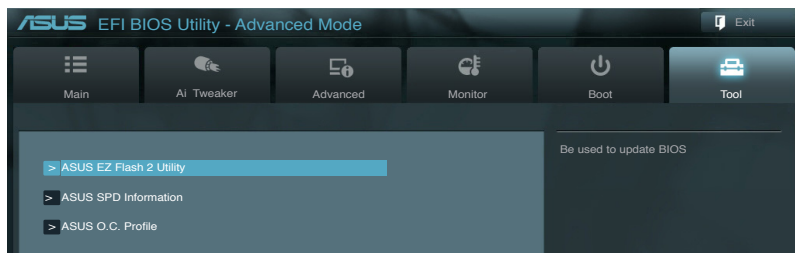

2.8.1 ASUS EZ Flash 2 Utility

Allows you to run ASUS EZ Flash 2. Press [Enter] to launch the ASUS EZ Flash 2 screen.



For more details, see section 2.1.2 **ASUS EZ Flash 2**.

2.8.2 ASUS SPD Information

DIMM Slot # [DIMM_A1]

Displays the Serial Presence Detect (SPD) information of the DIMM module installed on the selected slot. Configuration options: [DIMM_A1] [DIMM_B1]

2.8.3 ASUS O.C. Profile

This item allows you to store or load multiple BIOS settings.



The **Setup Profile Status** items show **Not Installed** if no profile is created.

Label

Allows you to input the label of the setup profile.

Save to Profile

Allows you to save the current BIOS settings to the BIOS Flash, and create a profile. Key in a profile number from one to eight, press <Enter>, and then select **Yes**.

Load from Profile

Allows you to load the previous BIOS settings saved in the BIOS Flash. Key in the profile number that saved your CMOS settings, press <Enter>, and then select **Yes**.



- DO NOT shut down or reset the system while updating the BIOS to prevent the system boot failure!
 - We recommend that you update the BIOS file only coming from the same memory/CPU configuration and BIOS version.
-

2.9 Exit menu

The Exit menu items allow you to load the optimal default values for the BIOS items, and save or discard your changes to the BIOS items. You can access the **EZ Mode** from the Exit menu.

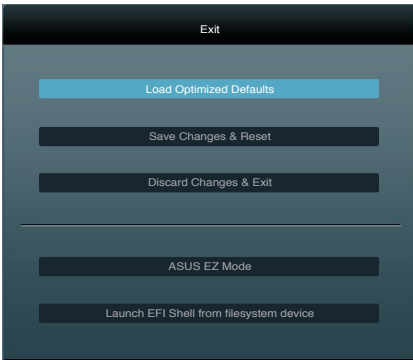

Load Optimized Defaults

This option allows you to load the default values for each of the parameters on the Setup menus. When you select this option or if you press <F5>, a confirmation window appears. Select **Yes** to load the default values.

Save Changes & Reset

Once you are finished making your selections, choose this option from the Exit menu to ensure the values you selected are saved. When you select this option or if you press <F10>, a confirmation window appears. Select **Yes** to save changes and exit.

Discard Changes & Exit

This option allows you to exit the Setup program without saving your changes. **When you** select this option or if you press <Esc>, a confirmation window appears. Select **Yes** to discard changes and exit.

ASUS EZ Mode

This option allows you to enter the EZ Mode screen.

Launch EFI Shell from filesystem device

This option allows you to attempt to launch the UEFI Shell application (shellx64.efi) from one of the available devices that have a filesystem.

Appendices

Notices

Federal Communications Commission Statement

This device complies with Part 15 of the FCC Rules. Operation is subject to the following two conditions:

- This device may not cause harmful interference.
- This device must accept any interference received including interference that may cause undesired operation.

This equipment has been tested and found to comply with the limits for a Class B digital device, pursuant to Part 15 of the FCC Rules. These limits are designed to provide reasonable protection against harmful interference in a residential installation. This equipment generates, uses and can radiate radio frequency energy and, if not installed and used in accordance with manufacturer's instructions, may cause harmful interference to radio communications. However, there is no guarantee that interference will not occur in a particular installation. If this equipment does cause harmful interference to radio or television reception, which can be determined by turning the equipment off and on, the user is encouraged to try to correct the interference by one or more of the following measures:

- Reorient or relocate the receiving antenna.
- Increase the separation between the equipment and receiver.
- Connect the equipment to an outlet on a circuit different from that to which the receiver is connected.
- Consult the dealer or an experienced radio/TV technician for help.



The use of shielded cables for connection of the monitor to the graphics card is required to assure compliance with FCC regulations. Changes or modifications to this unit not expressly approved by the party responsible for compliance could void the user's authority to operate this equipment.

IC: Canadian Compliance Statement

Complies with the Canadian ICES-003 Class B specifications. This device complies with RSS 210 of Industry Canada. This Class B device meets all the requirements of the Canadian interference-causing equipment regulations.

This device complies with Industry Canada license exempt RSS standard(s). Operation is subject to the following two conditions: (1) this device may not cause interference, and (2) this device must accept any interference, including interference that may cause undesired operation of the device.

Cet appareil numérique de la Classe B est conforme à la norme NMB-003 du Canada.

Cet appareil respecte toutes les exigences du Règlement sur le matériel brouilleur du Canada.

Cet appareil est conforme aux normes CNR exemptes de licence d'Industrie Canada. Le fonctionnement est soumis aux deux conditions suivantes :

- (1) cet appareil ne doit pas provoquer d'interférences et
- (2) cet appareil doit accepter toute interférence, y compris celles susceptibles de provoquer un fonctionnement non souhaité de l'appareil.

Canadian Department of Communications Statement

This digital apparatus does not exceed the Class B limits for radio noise emissions from digital apparatus set out in the Radio Interference Regulations of the Canadian Department of Communications.

This class B digital apparatus complies with Canadian ICES-003.

VCCI: Japan Compliance Statement

VCCI Class B Statement

情報処理装置等電波障害自主規制について

この装置は、情報処理装置等電波障害自主規制協議会（VCCI）の基準に基づくクラスB情報技術装置です。この装置は家庭環境で使用されることを目的としていますが、この装置がラジオやテレビジョン受信機に近接して使用されると、受信障害を引き起こすことがあります。

取扱説明書に従って正しい取り扱いをして下さい。

KC: Korea Warning Statement

B급 기기 (가정용 방송통신기자재)

이 기기는 가정용(B급) 전자파적합기기로서 주로 가정에서 사용하는 것을 목적으로 하며, 모든 지역에서 사용할 수 있습니다.

*당해 무선설비는 전파혼신 가능성이 있으므로 인명안전과 관련된 서비스는 할 수 없습니다.

REACH

Complying with the REACH (Registration, Evaluation, Authorisation, and Restriction of Chemicals) regulatory framework, we published the chemical substances in our products at ASUS REACH website at <http://csr.asus.com/english/REACH.htm>.



DO NOT throw the motherboard in municipal waste. This product has been designed to enable proper reuse of parts and recycling. This symbol of the crossed out wheeled bin indicates that the product (electrical and electronic equipment) should not be placed in municipal waste. Check local regulations for disposal of electronic products.



DO NOT throw the mercury-containing button cell battery in municipal waste. This symbol of the crossed out wheeled bin indicates that the battery should not be placed in municipal waste.

ASUS Recycling/Takeback Services

ASUS recycling and takeback programs come from our commitment to the highest standards for protecting our environment. We believe in providing solutions for you to be able to responsibly recycle our products, batteries, other components as well as the packaging materials. Please go to <http://csr.asus.com/english/Takeback.htm> for detailed recycling information in different regions.

ASUS contact information

ASUSTeK COMPUTER INC.

Address 15 Li-Te Road, Peitou, Taipei, Taiwan 11259
Telephone +886-2-2894-3447
Fax +886-2-2890-7798
E-mail info@asus.com.tw
Web site www.asus.com.tw

Technical Support

Telephone +86-21-38429911
Online support support.asus.com

ASUS COMPUTER INTERNATIONAL (America)

Address 800 Corporate Way, Fremont, CA 94539, USA
Telephone +1-812-282-3777
Fax +1-510-608-4555
Web site usa.asus.com

Technical Support

Telephone +1-812-282-2787
Support fax +1-812-284-0883
Online support support.asus.com

ASUS COMPUTER GmbH (Germany and Austria)

Address Harkort Str. 21-23, D-40880 Ratingen, Germany
Fax +49-2102-959911
Web site www.asus.de
Online contact www.asus.de/sales

Technical Support

Telephone +49-1805-010923*
Support Fax +49-2102-9599-11
Online support support.asus.com

* EUR 0.14/minute from a German fixed landline; EUR 0.42/minute from a mobile phone.

DECLARATION OF CONFORMITY

Per FCC Part 2 Section 2.1077(a)



Responsible Party Name: **Asus Computer International**

Address: **800 Corporate Way, Fremont, CA 94539.**

Phone/Fax No: **(510)739-3777/(510)608-4555**

hereby declares that the product

Product Name : Motherboard

Model Number : F2A85-M LE

Conforms to the following specifications:

- FCC Part 15, Subpart B, Unintentional Radiators

Supplementary Information:

This device complies with part 15 of the FCC Rules. Operation is subject to the following two conditions: (1) This device may not cause harmful interference, and (2) this device must accept any interference received, including interference that may cause undesired operation.

Representative Person's Name : Steve Chang / President

Signature : Steve Chang

Date : Jun. 13, 2012

Ver. 120601

EC Declaration of Conformity



Inspiring Innovation • Persistent Perfection

We, the undersigned,

Manufacturer: **ASUSTEK COMPUTER INC.**
 Address, City: **#F, No. 150, LI-TE Rd., PEITOU, TAIPEI 112, TAIWAN**
 Country: **TAIWAN**
 Authorized representative in Europe: **ASUS COMPUTER GmbH**
 Address, City: **HARKORT STR. 21-23, 40880 RATINGEN**
 Country: **GERMANY**

declare the following apparatus:

Product name : **Motherboard**
 Model name : **F2A85-M LE**

conform with the essential requirements of the following directives:

2004/108/EC-EMC Directive
 EN 55022:2010
 EN 61000-3-2:2006+A2:2009
 EN 61000-3-3:2008
 EN 55022:2007/AT:2011
 1989/EEC-R & TTE Directive
 EN 300 440-1 V1.6 (12010-08)
 EN 300 440-2 V1.4 (12010-08)
 EN 300 440-3 V1.2 (12010-08)
 EN 301 908-1 V0.5.2 (12011-09)
 EN 301 908-2 V0.5.2 (12011-07)
 EN 302 542 V1.1 (2009-01)
 EN 302 623 V1.1 (2009-01)
 EN 300 335-1 V1.7 (12010-02)
 EN 300 335-2 V1.5 (12010-02)
 EN 60960:2001
 EN 62479:2010
 EN 301 684-1 V1.9 (2011-09)
 EN 301 684-3 V1.4 (2012-08)
 EN 301 684-4 V1.4 (2009-05)
 EN 301 684-5 V1.4 (2009-05)
 EN 301 684-6 V1.4 (2007-11)
 EN 301 684-9 V1.4 (2007-11)
 EN 301 684-17 V2.1 (2009-08)
 EN 301 684-18 V2.1 (2009-08)
 EN 302 585-3 V1.3 (2007-08)
 EN 302 585-3 V1.4 (2009-11)
 EN 301 357-2 V1.4 (2009-11)
 EN 62311:2008

2006/95/EC-LVD Directive
 EN 60065:2002 / A2:2010
 EN 60950-1/A12:2011
 EN 60065:2002 / A12:2011

2009/128/EC-EP Directive
 Regulation (EC) No. 1275/2008
 Regulation (EC) No. 642/2009

2011/65/EU-RoHS Directive
 CE marking



(EC conformity marking)

Position : **CEO**
 Name : **Jerry Shei**

Jerry Shei

Signature : _____

Declaration Date: **Dec. 10, 2012**
 Year to begin affixing CE marking: **2012**