



P4B-FX

User Guide

Motherboard

E860

First Edition September 2001

Copyright © 2001 ASUSTeK COMPUTER INC. All Rights Reserved.

No part of this manual, including the products and software described in it, may be reproduced, transmitted, transcribed, stored in a retrieval system, or translated into any language in any form or by any means, except documentation kept by the purchaser for backup purposes, without the express written permission of ASUSTeK COMPUTER INC. ("ASUS").

Product warranty or service will not be extended if: (1) the product is repaired, modified or altered, unless such repair, modification or alteration is authorized in writing by ASUS; or (2) the serial number of the product is defaced or missing.

ASUS PROVIDES THIS MANUAL "AS IS" WITHOUT WARRANTY OF ANY KIND, EITHER EXPRESS OR IMPLIED, INCLUDING BUT NOT LIMITED TO THE IMPLIED WARRANTIES OR CONDITIONS OF MERCHANTABILITY OR FITNESS FOR A PARTICULAR PURPOSE. IN NO EVENT SHALL ASUS, ITS DIRECTORS, OFFICERS, EMPLOYEES OR AGENTS BE LIABLE FOR ANY INDIRECT, SPECIAL, INCIDENTAL, OR CONSEQUENTIAL DAMAGES (INCLUDING DAMAGES FOR LOSS OF PROFITS, LOSS OF BUSINESS, LOSS OF USE OR DATA, INTERRUPTION OF BUSINESS AND THE LIKE), EVEN IF ASUS HAS BEEN ADVISED OF THE POSSIBILITY OF SUCH DAMAGES ARISING FROM ANY DEFECT OR ERROR IN THIS MANUAL OR PRODUCT.

SPECIFICATIONS AND INFORMATION CONTAINED IN THIS MANUAL ARE FURNISHED FOR INFORMATIONAL USE ONLY, AND ARE SUBJECT TO CHANGE AT ANY TIME WITHOUT NOTICE, AND SHOULD NOT BE CONSTRUED AS A COMMITMENT BY ASUS. ASUS ASSUMES NO RESPONSIBILITY OR LIABILITY FOR ANY ERRORS OR INACCURACIES THAT MAY APPEAR IN THIS MANUAL, INCLUDING THE PRODUCTS AND SOFTWARE DESCRIBED IN IT.

Products and corporate names appearing in this manual may or may not be registered trademarks or copyrights of their respective companies, and are used only for identification or explanation and to the owners' benefit, without intent to infringe.

Contents

FCC/CDC statements	vi
Safety information	vii
About this guide	viii
How this guide is organized	viii
Conventions used in this guide	ix
Where to find more information	ix
ASUS contact information	x
Chapter 1: Product introduction	1-1
1.1 Welcome!	1-1
1.2 Package contents	1-1
1.3 Overview	1-2
1.3.1 Identifying the motherboard components	1-2
1.3.2 Pre-installed accessory	1-5
1.4 Special features	1-6
Chapter 2: Hardware information	2-1
2.1 Motherboard installation	2-1
2.1.1 Placement direction	2-1
2.1.2 Screw holes	2-1
2.2 Motherboard layout	2-2
2.3 Before you proceed	2-3
2.4 Central Processing Unit (CPU)	2-4
2.4.1 Overview	2-4
2.4.2 Installing the CPU	2-5
2.4.3 Installing the heatsink and fan	2-7
2.4.4 Connecting the CPU fan cable	2-9
2.5 System memory	2-10
2.5.1 Overview	2-10
2.5.2 Memory configurations	2-10
2.5.3 Installing a DIMM	2-11
2.5.4 Removing a DIMM	2-12
2.6 Expansion slots	2-13
2.6.1 Installing an expansion card	2-13
2.6.2 Configuring an expansion card	2-14
2.6.3 PCI slots	2-15

Contents

2.6.4	AGP slot	2-15
2.6.5	CNR slot	2-16
2.7	Jumpers	2-17
2.8	Connectors	2-20
Chapter 3: Powering up		3-1
3.1	Starting up for the first time	3-1
3.3	Powering off the computer	3-2
Chapter 4: BIOS setup		4-1
4.1	Managing and updating your BIOS	4-1
4.1.1	Using the computer system for the first time	4-1
4.1.2	Updating BIOS procedures	4-3
4.2	BIOS Setup program	4-5
4.2.1	BIOS menu bar	4-6
4.2.2	Legend bar	4-6
4.3	Main menu	4-8
4.3.1	Primary & Secondary Master/Slave	4-9
4.3.2	Keyboard Features	4-13
4.4	Advanced Menu	4-15
4.4.1	Chip Configuration	4-17
4.4.2	I/O Device Configuration	4-19
4.4.3	PCI Configuration	4-21
4.5	Power Menu	4-23
4.5.1	Power Up Control	4-25
4.5.2	Hardware Monitor	4-27
4.6	Boot Menu	4-28
4.7	Exit Menu	4-30
Chapter 5: Software support		5-1
5.1	Install an operating system	5-1
5.1.1	Windows 98 first time installation	5-1
5.2	Support CD information	5-1
5.2.1	Running the support CD	5-1
5.2.2	Main menu	5-2
5.2.3	Software menu	5-3
5.2.4	Drivers menu	5-5

Contents

5.2.5	DOS Utilities menu	5-6
5.2.6	ASUS Contact Information	5-6
5.2.7	Other information	5-7
5.3	Software information	5-9
5.3.1	ASUS Update	5-9
Glossary		G-1
Index		I-1

FCC/CDC statements

Federal Communications Commission Statement

This device complies with FCC Rules Part 15. Operation is subject to the following two conditions:

- This device may not cause harmful interference, and
- This device must accept any interference received including interference that may cause undesired operation.

This equipment has been tested and found to comply with the limits for a Class B digital device, pursuant to Part 15 of the FCC Rules. These limits are designed to provide reasonable protection against harmful interference in a residential installation. This equipment generates, uses and can radiate radio frequency energy and, if not installed and used in accordance with manufacturer's instructions, may cause harmful interference to radio communications. However, there is no guarantee that interference will not occur in a particular installation. If this equipment does cause harmful interference to radio or television reception, which can be determined by turning the equipment off and on, the user is encouraged to try to correct the interference by one or more of the following measures:

- Reorient or relocate the receiving antenna.
- Increase the separation between the equipment and receiver.
- Connect the equipment to an outlet on a circuit different from that to which the receiver is connected.
- Consult the dealer or an experienced radio/TV technician for help.



The use of shielded cables for connection of the monitor to the graphics card is required to assure compliance with FCC regulations. Changes or modifications to this unit not expressly approved by the party responsible for compliance could void the user's authority to operate this equipment.

Canadian Department of Communications Statement

This digital apparatus does not exceed the Class B limits for radio noise emissions from digital apparatus set out in the Radio Interference Regulations of the Canadian Department of Communications.

This class B digital apparatus complies with Canadian ICES-003.

Safety information

Electrical safety

- To prevent electrical shock hazard, disconnect the power cable from the electrical outlet before relocating the system.
- When adding or removing devices to or from the system, ensure that the power cables for the devices are unplugged before the signal cables are connected. If possible, disconnect all power cables from the existing system before you add a device.
- Before connecting or removing signal cables from the motherboard, ensure that all power cables are unplugged.
- Seek professional assistance before using an adapter or extension cord. These devices could interrupt the grounding circuit.
- Make sure that your power supply is set to the correct voltage in your area. If you are not sure about the voltage of the electrical outlet you are using, contact your local power company.
- If the power supply is broken, do not try to fix it by yourself. Contact a qualified service technician or your retailer.

Operation safety

- Before installing the motherboard and adding devices on it, carefully read all the manuals that came with the package.
- Before using the product, make sure all cables are correctly connected and the power cables are not damaged. If you detect any damage, contact your dealer immediately.
- To avoid short circuits, keep paper clips, screws, and staples away from connectors, slots, sockets and circuitry.
- Avoid dust, humidity, and temperature extremes. Do not place the product in any area where it may become wet.
- Place the product on a stable surface.
- If you encounter technical problems with the product, contact a qualified service technician or your retailer.

About this guide

This user guide contains the information you need when installing the ASUS P4B-FX motherboard.

How this guide is organized

This manual contains the following parts:

- **Chapter 1: Product introduction**

This chapter describes the features of the P4B-FX motherboard. It includes brief descriptions of the special attributes of the motherboard and the new technology it supports.
- **Chapter 2: Hardware information**

This chapter lists the hardware setup procedures that you have to perform when installing system components. It includes description of the switches, jumpers, and connectors on the motherboard.
- **Chapter 3: Powering up**

This chapter describes the power up sequence and gives information on the BIOS beep codes.
- **Chapter 4: BIOS setup**

This chapter tells how to change system settings through the BIOS Setup menus. Detailed descriptions of the BIOS parameters are also provided.
- **Chapter 5: Software support**

This chapter describes the contents of the support CD that comes with the motherboard package.
- **Glossary**

This part lists the technical terms that you may encounter when reading this document.
- **Index**

This part contains an alphabetical list of the topics found in this document.

Conventions used in this guide

To make sure that you perform certain tasks properly, take note of the following symbols used throughout this manual.



WARNING: Information to prevent injury to yourself when trying to complete a task.



CAUTION: Information to prevent damage to the components when trying to complete a task.



IMPORTANT: Information that you **MUST** follow to complete a task.



NOTE: Tips and additional information to aid in completing a task.

Where to find more information

Refer to the following sources for additional information and for product and software updates.

1. **ASUS Websites**

The ASUS websites worldwide provide updated information on ASUS hardware and software products. The ASUS websites are listed in the ASUS contact information on page x.

2. **Optional Documentation**

Your product package may include optional documentation, such as warranty flyers, that may have been added by your dealer. These documents are not part of the standard package.

ASUS contact information

ASUSTeK COMPUTER INC. (Asia-Pacific)

Address: 150 Li-Te Road, Peitou, Taipei, Taiwan 112
General Tel: +886-2-2894-3447
General Fax: +886-2-2894-3449
General Email: info@asus.com.tw

Technical Support

MB/Others (Tel): +886-2-2890-7121 (English)
Notebook (Tel): +886-2-2890-7122 (English)
Desktop/Server (Tel): +886-2-2890-7123 (English)
Support Fax: +886-2-2890-7698
Support Email: tsd@asus.com.tw
Web Site: www.asus.com.tw
Newsgroup: cscnews.asus.com.tw

ASUS COMPUTER INTERNATIONAL (America)

Address: 6737 Mowry Avenue, Mowry Business Center,
Building 2, Newark, CA 94560, USA
General Fax: +1-510-608-4555
General Email: tmd1@asus.com

Technical Support

Support Fax: +1-510-608-4555
Notebook (Tel): 1-877-918-ASUS (2787)
Web Site: www.asus.com
Support Email: tsd@asus.com

ASUS COMPUTER GmbH (Europe)

Address: Harkortstr. 25, 40880 Ratingen, BRD, Germany
General Fax: +49-2102-442066
General Email: sales@asuscom.de (for marketing requests only)

Technical Support

Support Hotline: MB/Others: +49-2102-9599-0
Notebook (Tel): +49-2102-9599-10
Support Fax: +49-2102-9599-11
Support (Email): www.asuscom.de/de/support (for online support)
Web Site: www.asuscom.de

Chapter 1

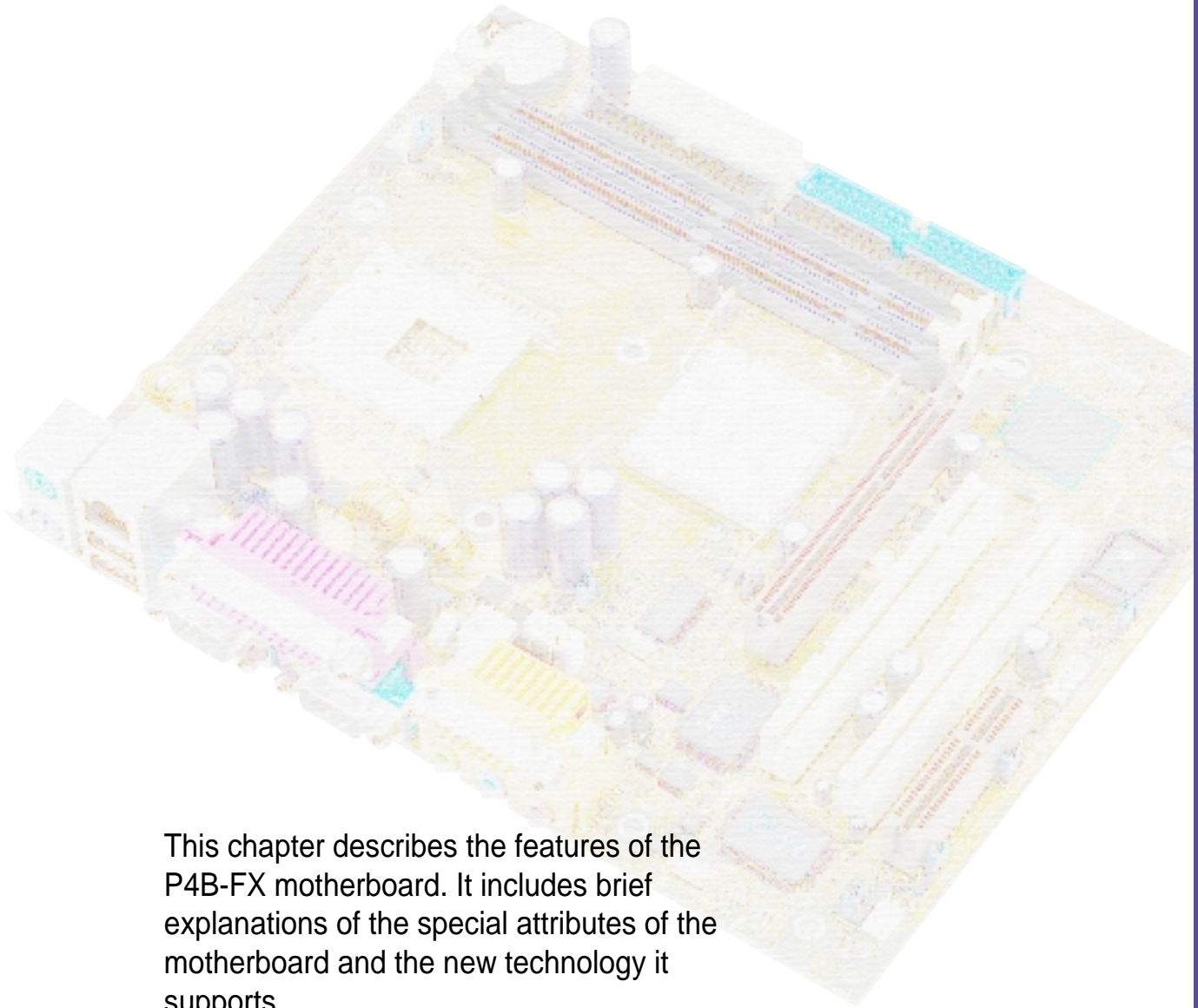

This chapter describes the features of the P4B-FX motherboard. It includes brief explanations of the special attributes of the motherboard and the new technology it supports.

Product introduction

1.1 Welcome!

Thank you for buying the ASUS® P4B-FX motherboard!

The ASUS P4B-FX motherboard delivers a host of new features and latest technology making it another standout in the long line of ASUS quality motherboards!

The P4B-FX incorporates the Intel® Pentium® 4 Processor in 478-pin package/Northwood Processor coupled with the Intel® 845 (Brookdale) chipset to set a new benchmark for an effective desktop platform solution.

Supporting up to 2GB of system memory with PC133 unbuffered SDRAM, high-resolution graphics via an AGP 4X slot, high-speed data transfers using the ATA100 protocol, and AC '97-compliant audio features, the P4B-FX is your perfect vehicle to get ahead in the world of power computing!

Before you start installing the motherboard, and hardware devices on it, check the items in your package with the list below.

1.2 Package contents

Check your P4B-FX package for the following items.

- ✓ ASUS P4B-FX motherboard (Flex-ATX form factor: 9.0 x 7.5 inches)
- ✓ ASUS P4B-FX support CD
- ✓ ASUS 2-port USB module
- ✓ 80-conductor ribbon cable for UltraDMA/33/66/100 IDE drives
- ✓ Ribbon cable for a 3.5-inch floppy drive
- ✓ Bag of extra jumper caps
- ✓ User Guide
- ✓ I/O shield (LAN models only)



If any of the above items is damaged or missing, contact your retailer.

1.3 Overview

Before you install the P4B-FX motherboard, take some time to familiarize yourself with its physical configuration and available features. This will facilitate the motherboard installation and future upgrades. A sufficient knowledge of the motherboard specifications will also help you avoid mistakes that may damage the board and its components.

This section presents the motherboard components and points out their specific locations. A brief description of each component follows. Refer to Chapter 2 for detailed information on these components.

1.3.1 Identifying the motherboard components

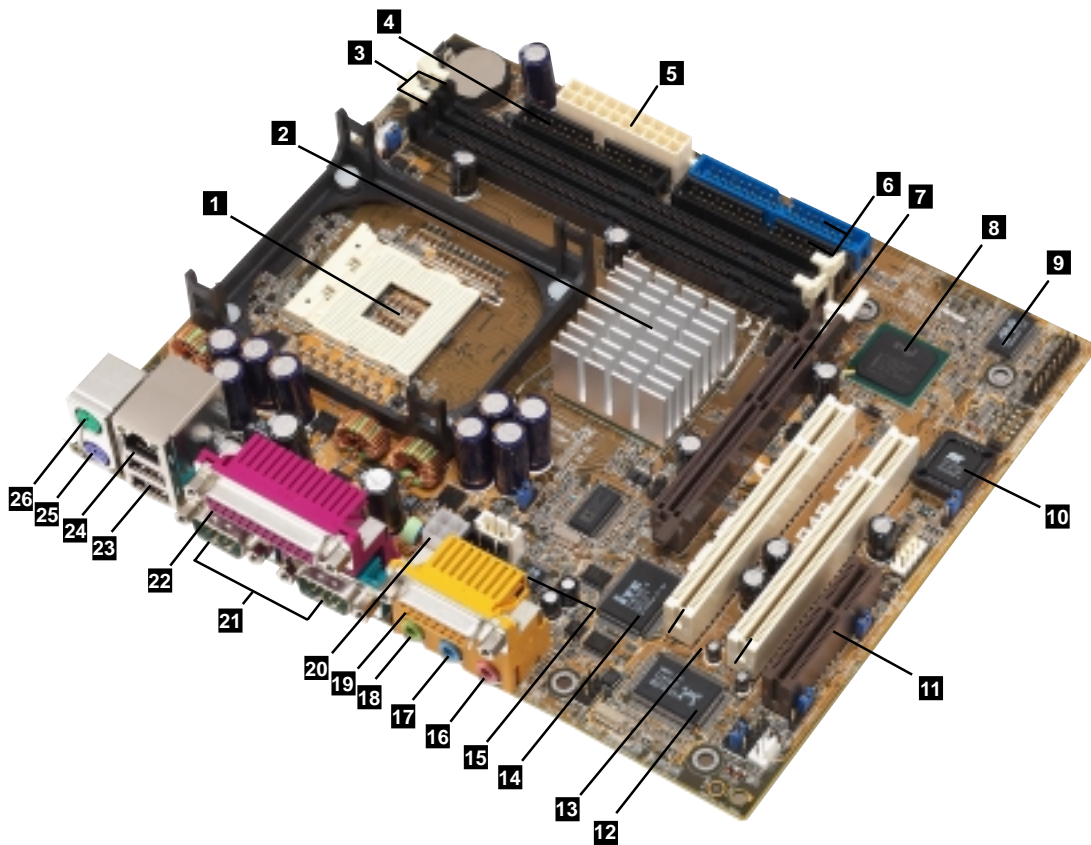

Figure 1-1 Motherboard Components

Proceed to the succeeding pages for a brief description of each component.

- 1 CPU socket.** A 478-pin surface mount, Zero Insertion Force (ZIF) socket called mPGA478 B. This socket accommodates the Intel® Pentium® 4 478/Northwood Processor with 400MHz system bus.
- 2 North bridge controller.** This controller called the Intel Memory Controller Hub (MCH) is one of the two major components of the Intel 845 (Brookdale) chipset. The MCH along with the south bridge Intel I/O Controller Hub 2 (ICH2) are interconnected through the Intel proprietary Hub interface. The MCH provides the processor interface, system memory interface, AGP interface, and Hub Interface.
- 3 SDRAM DIMM sockets.** These two 168-pin DIMM sockets support up to 2GB using unbuffered ECC or non-ECC PC133 SDRAM DIMMs.
- 4 Floppy disk connector.** This connector accommodates the provided ribbon cable for the floppy disk drive. One side of the connector is slotted to prevent incorrect insertion of the floppy disk cable.
- 5 ATX power connector.** This 20-pin connector connects to an ATX 12V power supply. The power supply must have at least 1A on the +5V standby lead (+5VSB).
- 6 IDE connectors.** These dual-channel bus master IDE connectors support up to four Ultra DMA/100/66, PIO Modes 3 & 4 IDE devices. Both the primary (blue) and secondary (black) connectors are slotted to prevent incorrect insertion of the IDE ribbon cable.
- 7 AGP slot.** This Accelerated Graphics Port (AGP) slot supports 1.5V AGP 4X mode graphics cards for 3D graphical applications.
- 8 South bridge controller.** Referred to as the Intel I/O Controller Hub 2 (ICH2) of the Intel 845 chipset, this controller provides the I/O subsystem that allows access to the rest of the system. The ICH2 integrates I/O functions such as system bus interface, Ultra ATA/100, Low Pin Count (LPC) interface, Universal Serial Bus (USB) 1.1 interface, PCI interface, and CNR interface.
- 9 ASUS ASIC.** This chip performs multiple system functions that include hardware and system voltage monitoring, IRQ routing, among others.

- 10** **Flash EEPROM.** This 2Mb firmware contains the programmable BIOS program.
- 11** **CNR slot.** This slot is specifically designed for the Communications and Networking Riser (CNR) card. The CNR supports V.90 analog modem, six-channel audio, HPNA, USB Hub, and 10BASE-T/100BASE-TX Ethernet networking.
- 12** **LAN controller.** This RealTek 8100B PCI LAN controller fully supports 10BASE-T and 100BASE-TX networking protocols.
- 13** **PCI slots.** These two 32-bit PCI 2.2 expansion slots support bus master PCI cards like SCSI or LAN cards with 133MB/s maximum throughput.
- 14** **Super I/O chipset.** This Low Pin Count (LPC) chipset combines the commonly used Super I/O functionality and system hardware monitoring capability. The chipset incorporates event wake-up feature, floppy disk controller, keyboard/mouse controller, a parallel port, two enhanced serial ports (one with infrared support), and a MIDI interface compatible with MPU-401 UART mode.
- 15** **Audio CODEC.** This AC '97 audio codec provides stereo analog I/O on the motherboard and peripheral devices to deliver high quality audio to PC-connected speakers, headphones, and microphones. The codec includes analog-to-digital and digital-to-analog sample rate converters, as power amplifiers and programmable gain blocks.
- 16** **Microphone jack.** This Mic (pink) jack connects a microphone.
- 17** **Line In jack.** This Line In (light blue) jack connects a tape player or other audio sources.
- 18** **Line Out jack.** This Line Out (lime) jack connects a headphone or a speaker.
- 19** **Game/MIDI connector.** This connector supports a joystick or a game pad for playing games, and MIDI devices for playing or editing audio files.
- 20** **ATX 12V connector.** This power connector connects the 4-pin 12V plug from the ATX 12V power supply.
- 21** **Serial ports.** These two 9-pin COM1/COM2 ports are for pointing devices or other serial devices.

- 22** **Parallel port.** This 25-pin port connects a parallel printer, a scanner, or other devices.
- 23** **USB ports.** These two 4-pin Universal Serial Bus (USB) ports are available for connecting USB devices such as a mouse and PDA.
- 24** **RJ-45 port.** This port allows connection to a Local Area Network (LAN) through a network hub.
- 25** **PS/2 keyboard port.** This purple 6-pin connector is for a PS/2 keyboard.
- 26** **PS/2 mouse port.** This green 6-pin connector is for a PS/2 mouse.

1.3.2 Pre-installed accessory



This motherboard is shipped with the heatsink retention module base already installed. This module should fit the retention mechanism that comes with a boxed CPU.

You do not have to remove the retention module base when installing the CPU or installing other motherboard components.

Retention Module Base

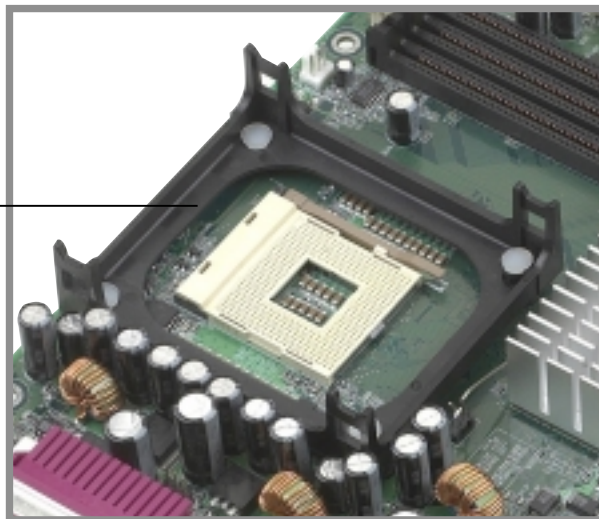

Figure 1-2 Pre-installed Heatsink Retention Module Base

1.4 Special features

Latest processor technology

The P4B-FX motherboard supports the latest Intel Pentium 4 478/ Northwood Processor, also known as P4, via a 478-pin surface mount ZIF socket. The Pentium 4 processor utilizes the advanced 0.18 micron processor core in FC-PGA2 package for a 2.0GHz frequency, while the Northwood processor uses the 0.13 micron processor core with 512KB L2 cache for up to a speedy 2.4GHz frequency. The P4 offers optimized performance for audio, video, and Internet applications.

Onboard LAN *(optional)*

The motherboard incorporates the RealTek 8100B LAN chip to support 10BASE-T/100BASE-TX Fast Ethernet networking.

Chapter 2

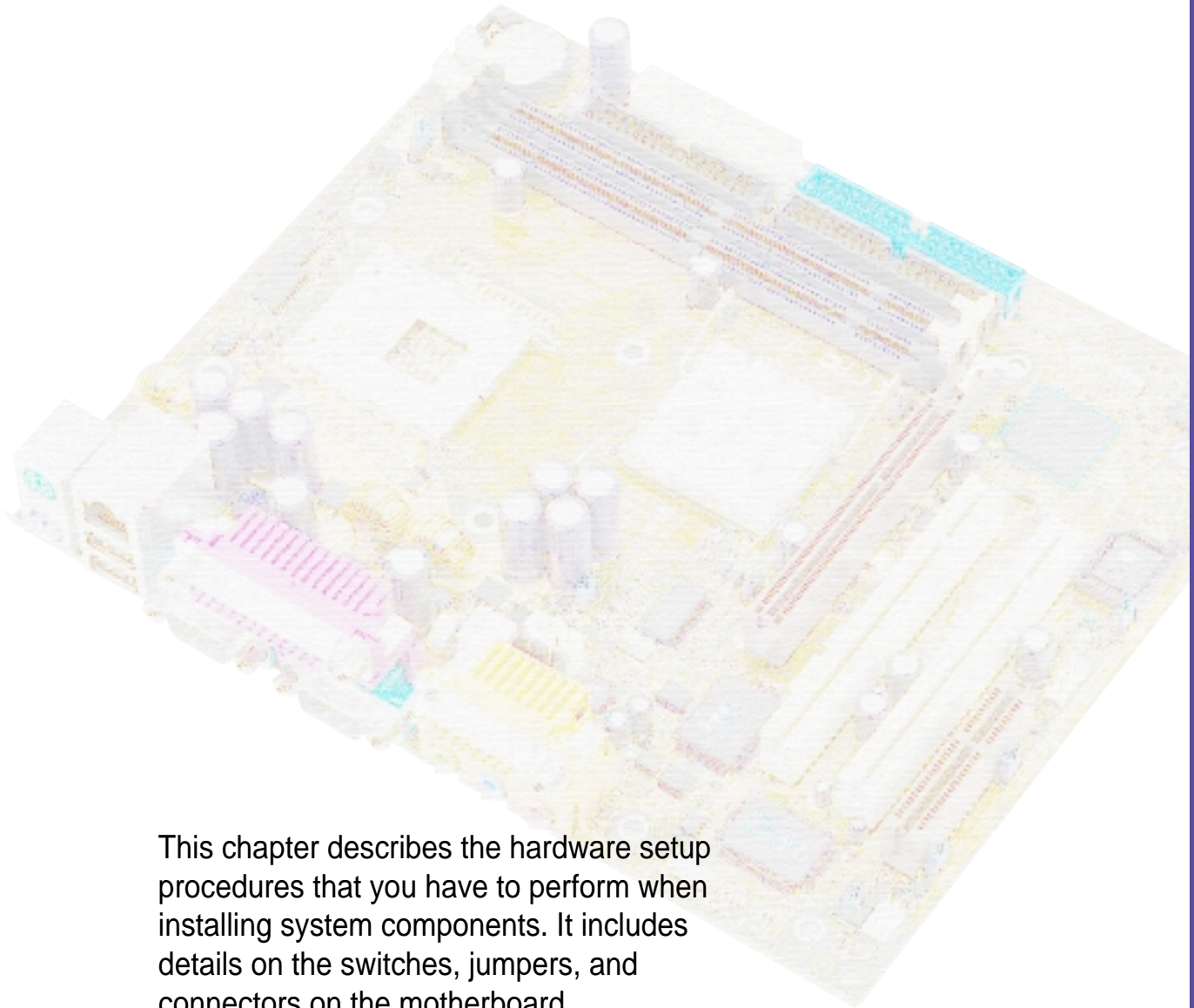

This chapter describes the hardware setup procedures that you have to perform when installing system components. It includes details on the switches, jumpers, and connectors on the motherboard.

Hardware information

2.1 Motherboard installation

Before you install the motherboard, study the configuration of your chassis to ensure that the motherboard fits into it. The P4B-FX uses the Flex-ATX form factor that measures 9.6 inches x 7.5 inches, a standard fit for most chassis.



Make sure to unplug the power cord before installing or removing the motherboard. Failure to do so may cause you physical injury and damage motherboard components.

2.1.1 Placement direction

When installing the motherboard, make sure that you place it into the chassis in the correct orientation. The edge with external ports goes to the rear part of the chassis. Refer to the image below.

2.1.2 Screw holes

Place six (6) screws into the holes indicated by circles to secure the motherboard to the chassis.



Do not overtighten the screws! Doing so may damage the motherboard.

Place this side towards
the rear of the chassis



Figure 2-1 Motherboard placement and screw holes

2.2 Motherboard layout

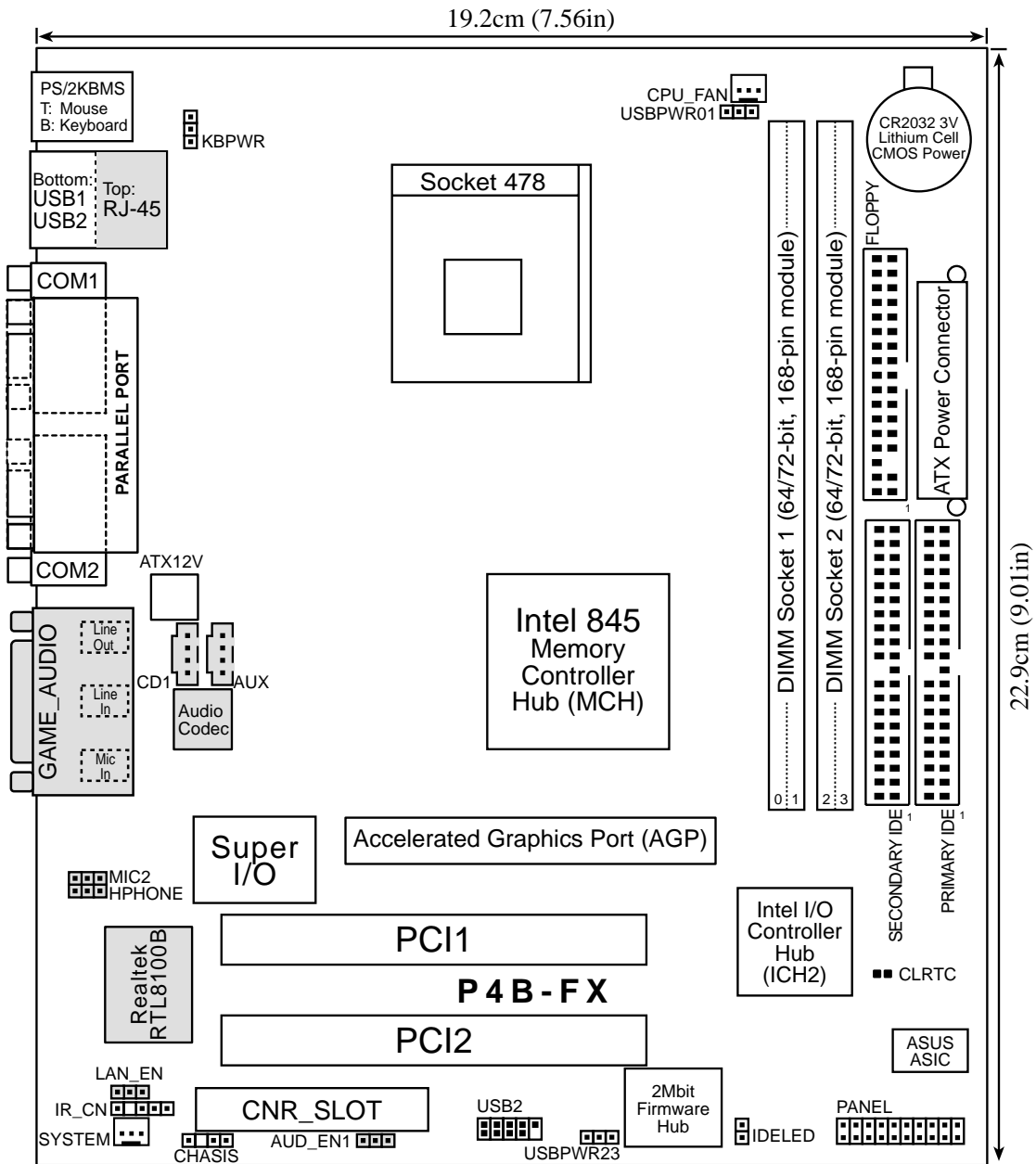

Figure 2-2 Motherboard Layout



The audio codec, external and internal audio connectors, and LAN features are optional components. The components are grayed out in the above motherboard layout.

2.3 Before you proceed

Take note of the following precautions before you install motherboard components or change any motherboard settings.



-
1. Unplug the power cord from the wall socket before touching any component.
 2. Use a grounded wrist strap or touch a safely grounded object or to a metal object, such as the power supply case, before handling components to avoid damaging them due to static electricity.
 3. Hold components by the edges and do not touch the ICs on them.
 4. Whenever you uninstall any component, place it on a grounded antistatic pad or in the bag that came with the component.
 5. **Before you install or remove any component, ensure that the ATX power supply is switched off or the power cord is detached from the power supply.** Failure to do so may cause severe damage to the motherboard, peripherals, and/or components.
-

2.4 Central Processing Unit (CPU)

2.4.1 Overview

The motherboard comes with a surface mount 478-pin Zero Insertion Force (ZIF) socket. This socket is specifically designed for the Intel® Pentium® 4 478/Northwood Processor.

The Intel Pentium 4 Processor in the 478-pin package uses the Flip-Chip Pin Grid Array 2 (FC-PGA2) package technology, and includes the Intel® NetBurst™ micro-architecture. The Intel NetBurst micro-architecture features the hyper-pipelined technology, rapid execution engine, 400MHz system bus, and execution trace cache. Together, these attributes improve system performance by allowing higher processor frequencies, faster execution of integer instructions, and a data transfer rate of 3.2GB/s.

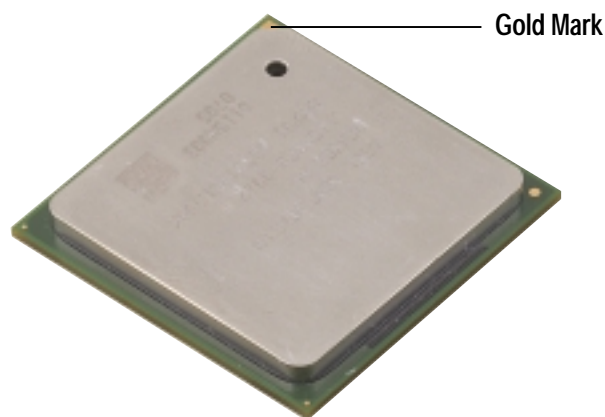

Figure 2-3 Intel Pentium 4 478/Northwood Processor

Note in the illustration that the CPU has a gold triangular mark on one corner. This mark indicates the processor Pin 1 that should match a specific corner of the CPU socket.



Incorrect installation of the CPU into the socket may bend the pins and severely damage the CPU!

2.4.2 Installing the CPU

Follow these steps to install a CPU.

1. Locate the 478-pin ZIF socket on the motherboard.

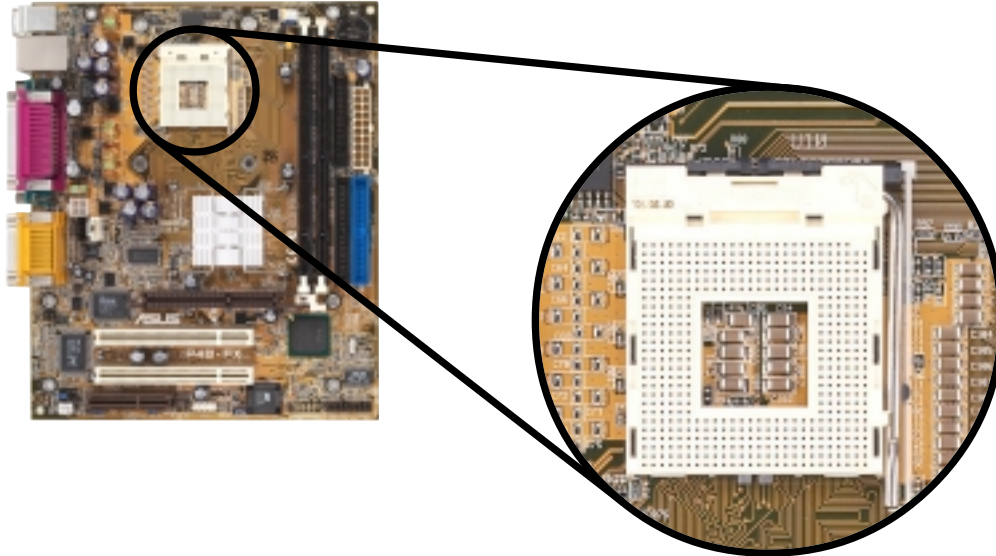

Figure 2-4 Intel 478-pin ZIF Socket

2. Unlock the socket by pressing the lever sideways, then lift it up to a 90°-100° angle.

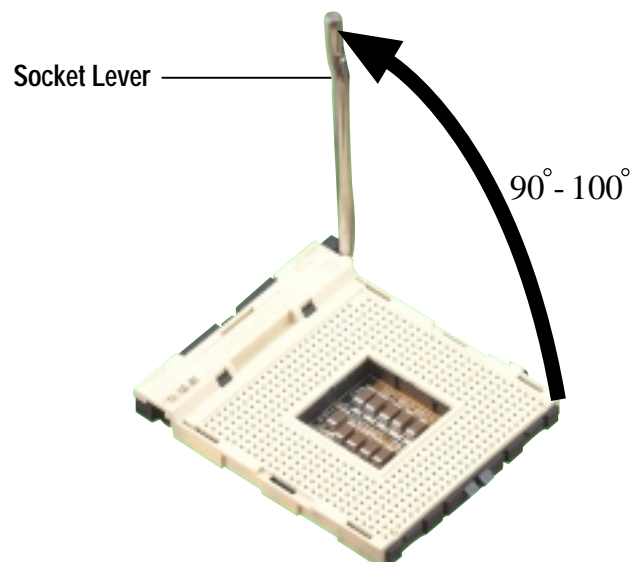

Figure 2-5 CPU Socket Lever at 90° - 100° Angle



Make sure that the socket lever is lifted up to 90°-100° angle, otherwise the CPU does not fit in completely.

3. Position the CPU above the socket such that its marked corner matches the base of the socket lever.
4. Carefully insert the CPU into the socket until it fits in place.



The CPU fits only in one correct orientation. DO NOT force the CPU into the socket to prevent bending the pins and damaging the CPU!

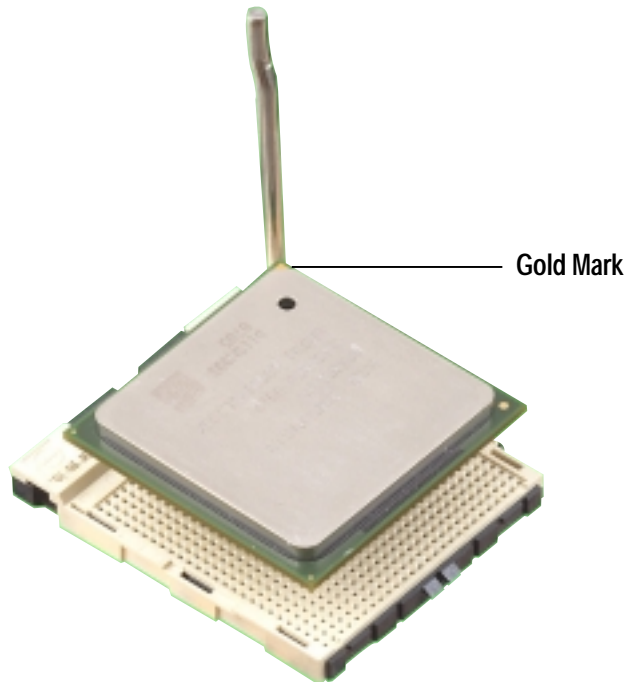

Figure 2-6 *Installing the CPU*

5. When the CPU is in place, press it firmly on the socket while you push down the socket lever to secure the CPU. The lever clicks on the side tab to indicate that it is locked.

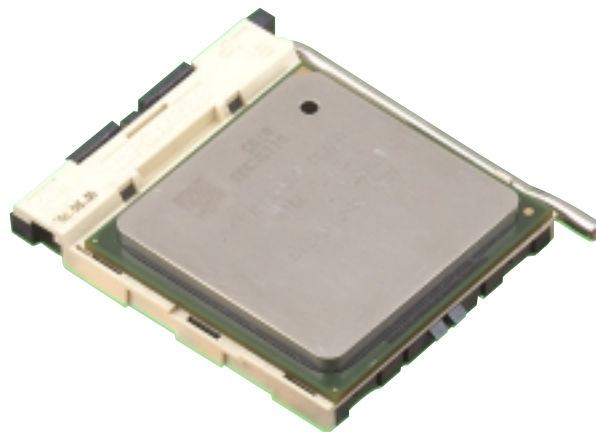

Figure 2-7 *Installed CPU*

2.4.3 Installing the heatsink and fan

The Intel® Pentium® 4 478/Northwood Processor requires a specially designed heatsink and fan assembly to ensure optimum thermal condition and performance.



When you buy a boxed Intel Pentium 4 478/Northwood Processor, the package usually includes the heatsink, fan, and retention mechanism.

In case you buy a CPU separately, make sure that you use only Intel certified heatsink and fan.

Follow these steps to install the CPU heatsink and fan.

1. Place the heatsink on top of the installed CPU, making sure that the heatsink fits properly on the retention module base.



The retention module base is already installed on the motherboard.

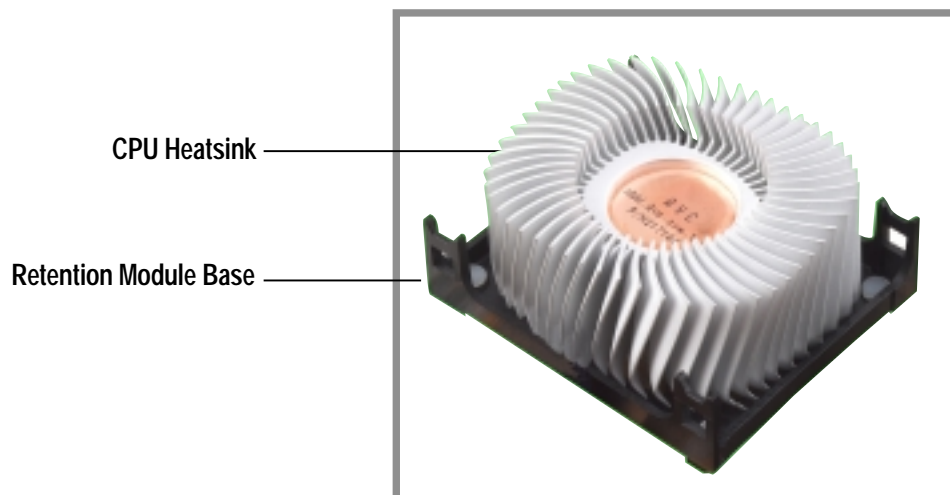

Figure 2-8 Installing the CPU Heatsink



Your boxed Intel Pentium 4 478/Northwood Processor package should come with installation instructions for the CPU, heatsink, and the retention mechanism. If the instructions in this section do not match the CPU documentation, follow the latter.

2. Position the fan with the retention mechanism on top of the heatsink. Align and snap the four hooks of the retention mechanism to the holes on each corner of the module base.



Make sure that the fan and retention mechanism assembly perfectly fits the heatsink and module base, otherwise you cannot snap the hooks into the holes.

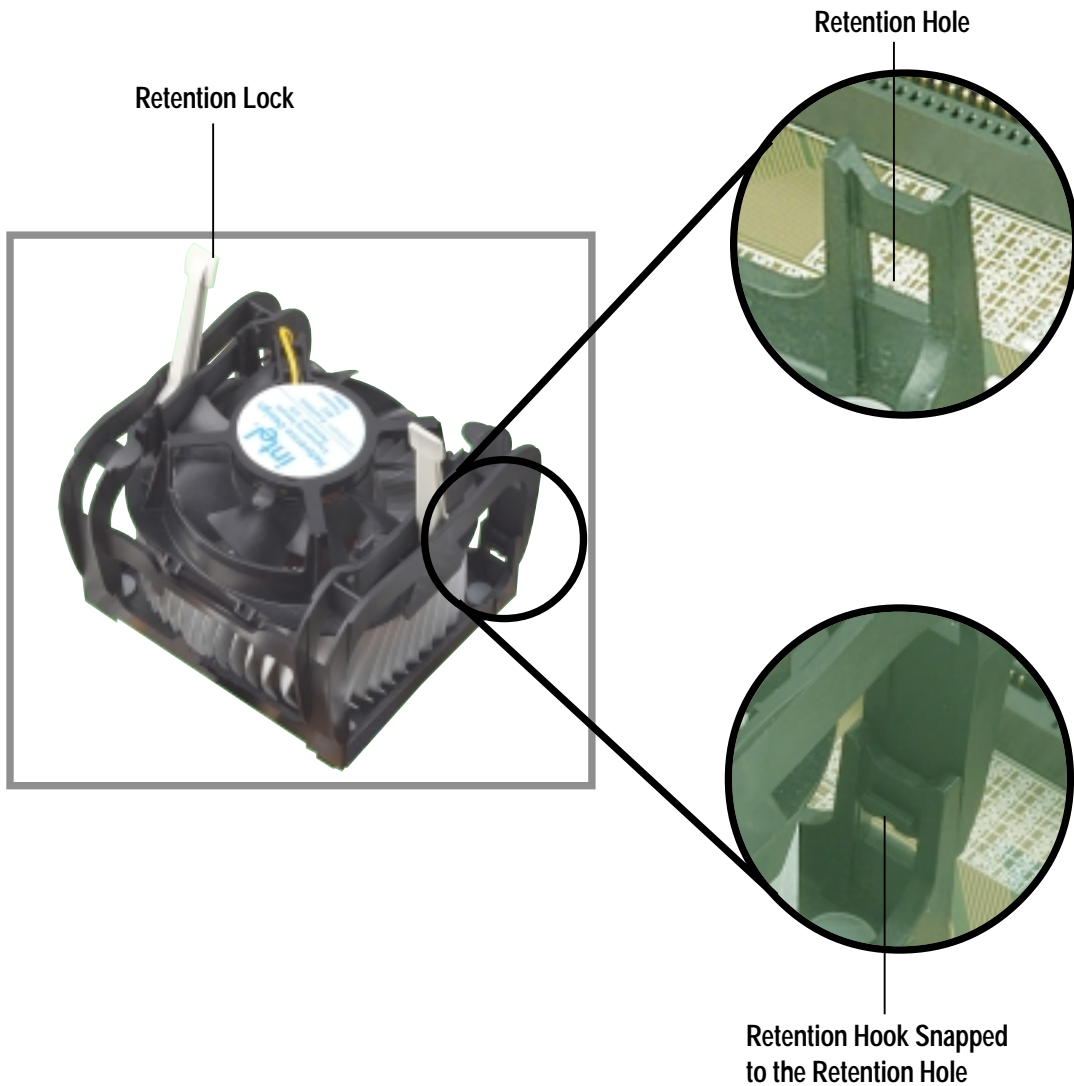

Figure 2-9 Installing the Fan and Retention Mechanism



Keep the retention locks lifted upward while fitting the retention mechanism to the module base.

3. Push down the locks on the retention mechanism to secure the heatsink and fan to the module base.



When secure, the retention locks should point to opposite directions.

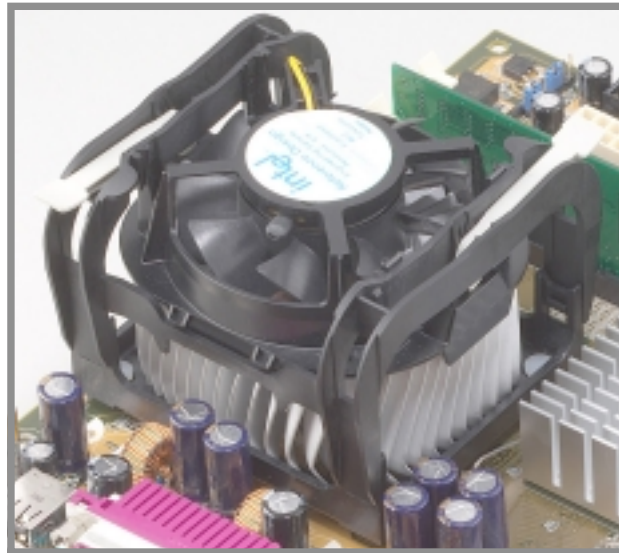

Figure 2-10 Fan and Retention Mechanism Installed and Locked

2.4.4 Connecting the CPU fan cable

When the fan, heatsink, and the retention mechanism are in place, connect the CPU fan cable to the connector on the motherboard labeled CPUFAN.

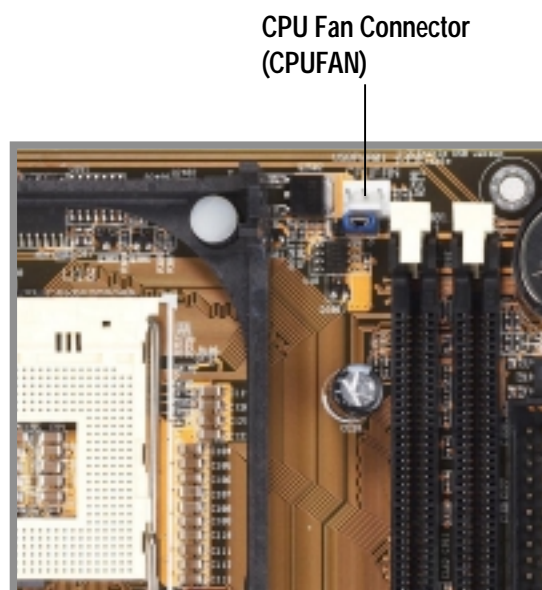

Figure 2-11 CPU Fan Connector

2.5 System memory

2.5.1 Overview

The motherboard comes with two Single Data Rate (SDR) Dual Inline Memory Module (DIMM) sockets. These sockets support up to 2GB system memory using unbuffered ECC or non-ECC PC133 DIMMs.

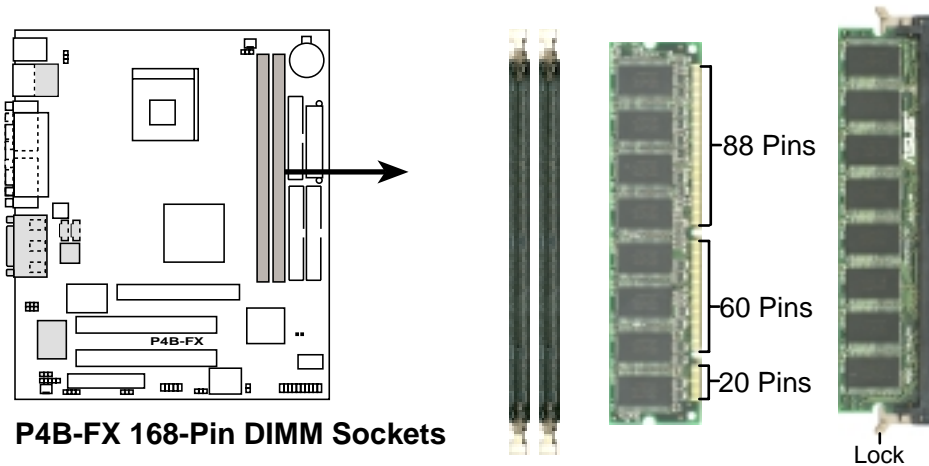

Figure 2-12 DIMM Sockets Location and SDR DIMMs



DIMMs are keyed with notches so that they fit in only one direction. DO NOT force a DIMM into a socket to avoid damaging the DIMM.

2.5.2 Memory configurations

Install DIMMs in any of the following combinations.

DIMM Location	168-pin DIMM (SDR)	Total Memory
Socket 1 (Rows 0&1)	64MB, 128MB, 256MB, 512MB, 1GB x1	
Socket 2 (Rows 2&3)	64MB, 128MB, 256MB, 512MB, 1GB x1	
Total system memory (Max. 2GB)		=

2.5.3 Installing a DIMM



Make sure to unplug the power supply before adding or removing DIMMs or other system components. Failure to do so may cause severe damage to both the motherboard and the components.

Follow these steps to install a DIMM.

1. Unlock a DIMM socket by pressing the retaining clips outward.
2. Align a DIMM on the socket such that the notches on the DIMM match the breaks on the socket.
3. Firmly insert the DIMM into the socket until the retaining clips snap back in place and the DIMM is properly seated.

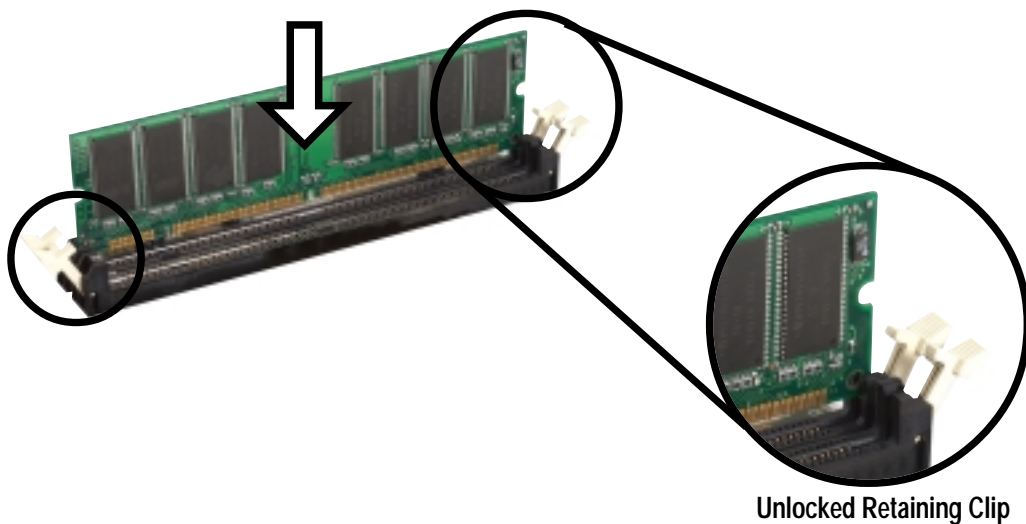

Unlocked Retaining Clip

Figure 2-13 Installing a DIMM

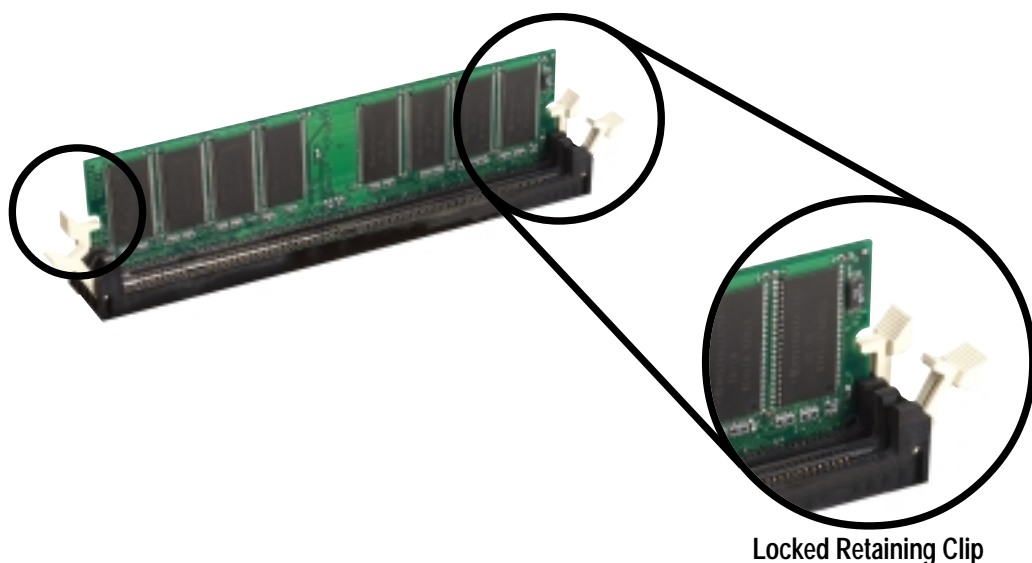

Locked Retaining Clip

Figure 2-14 Installed DIMM

2.5.4 Removing a DIMM

Follow these steps to remove a DIMM.

1. Simultaneously press the retaining clips outward to unlock the DIMM.



Support the DIMM lightly with your fingers when pressing the retaining clips. The DIMM might get damaged when it flips out with extra force.

2. Remove the DIMM from the socket.

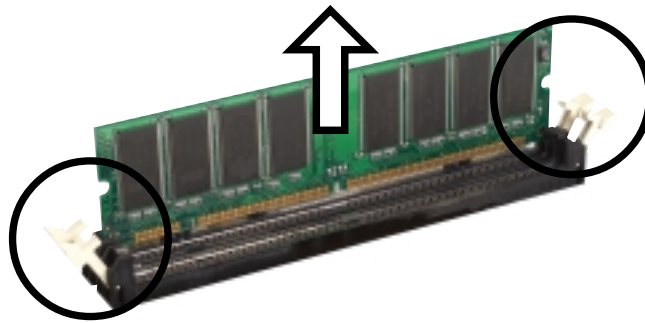

Figure 2-15 Removing a DIMM

2.6 Expansion slots

In the future, you may need to install expansion cards. The motherboard has three PCI slots and one Accelerated Graphics Port (AGP) slot. The following sub-sections describe the slots and the expansion cards that they support.



Make sure to unplug the power cord before adding or removing expansion cards. Failure to do so may cause you physical injury and damage motherboard components.

2.6.1 Installing an expansion card

Follow these steps to install an expansion card.

1. Before installing the expansion card, read the documentation that came with it and make the necessary hardware settings for the card.
2. Remove the system unit cover (if your motherboard is already installed in a chassis).
3. Remove the bracket opposite the slot that you intend to use. Keep the screw for later use.
4. Align the card connector with the slot and press firmly until the card is completely seated on the slot.
5. Secure the card to the chassis with the screw you removed earlier.
6. Replace the system cover.

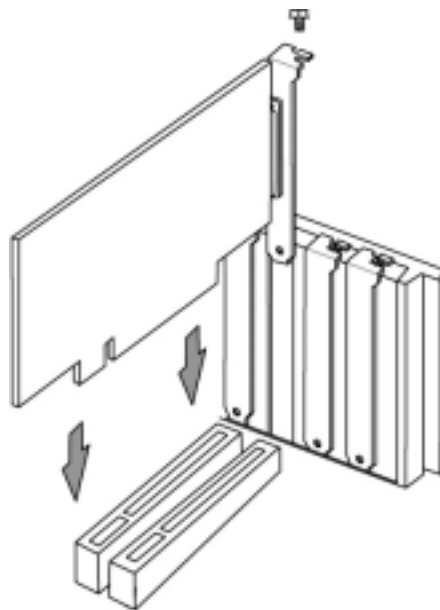

Figure 2-16 Installing a PCI Card

2.6.2 Configuring an expansion card

After physically installing the expansion card, configure the card by adjusting the software settings.

1. Turn on the system and change the necessary BIOS settings, if any.
See Chapter 4 for information on BIOS setup.
2. Assign an IRQ to the card. Refer to the tables below.
3. Install the software drivers for the expansion card.

Standard Interrupt Assignments

IRQ	Priority	Standard Function
0	1	System Timer
1	2	Keyboard Controller
2	N/A	Programmable Interrupt
3*	11	Communications Port (COM2)
4*	12	Communications Port (COM1)
5*	13	Sound Card (sometimes LPT2)
6	14	Floppy Disk Controller
7*	15	Printer Port (LPT1)
8	3	System CMOS/Real Time Clock
9*	4	ACPI Mode when used
10*	5	IRQ Holder for PCI Steering
11*	6	IRQ Holder for PCI Steering
12*	7	PS/2 Compatible Mouse Port
13	8	Numeric Data Processor
14*	9	Primary IDE Channel
15*	10	Secondary IDE Channel

*These IRQs are usually available for ISA or PCI devices.

IRQ assignments for this motherboard

	A	B	C	D	E	F	G	H
PCI slot 1	—	—	—	—	—	shared	—	—
PCI slot 2	—	—	used	—	—	—	—	—
Onboard USB controller HC0	—	—	—	used	—	—	—	—
Onboard USB controller HC1	—	—	—	—	—	—	—	shared
CNR LAN	—	—	—	—	shared	—	—	—
CNR Audio/Modem	—	shared	—	—	—	—	—	—
AGP	used	—	—	—	—	—	—	—
Onboard Audio	—	shared	—	—	—	—	—	—
Onboard LAN	—	—	—	—	shared	—	—	—



When using PCI cards on shared slots, ensure that the drivers support “Share IRQ” or that the cards do not need IRQ assignments. Otherwise, conflicts will arise between the two PCI groups, making the system unstable and the card inoperable.

2.6.3 PCI slots

There are two 32-bit PCI slots in this motherboard. The slots support PCI cards such as a LAN card, SCSI card, USB card, and other cards that comply with PCI specifications.

The following figure shows a LAN card installed on a PCI slot.

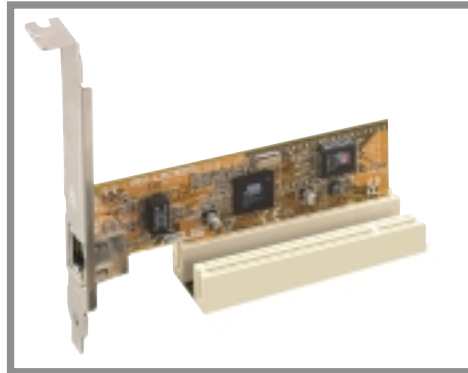

Figure 2-17 Installed PCI Card

2.6.4 AGP slot

This motherboard has an Accelerated Graphics Port (AGP) slot that supports +1.5V AGP cards. When you buy an AGP card, make sure that you ask for one with +1.5V specification.

Take note of the notches on the card golden fingers to ensure that they fit the AGP slot on your motherboard. Below is an example of a +1.5V AGP card.



The AGP slot supports only 1.5V AGP cards. NEVER install a 3.3V AGP card into the slot. Doing so will severely damage the motherboard!

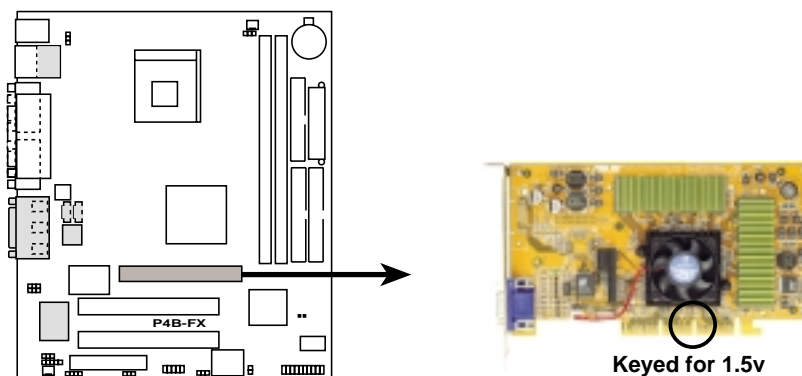

P4B-FX Accelerated Graphics Port (AGP)

Figure 2-18 Accelerated Graphics Port (AGP) Slot Location

2.6.5 CNR slot

The Communications and Networking Riser (CNR) slot supports interface cards that integrates audio, modem, and network functionality.

The CNR specification supports interfaces including:

- Audio Codec '97 (AC '97) - for audio and/or modem functions
- Local Area Network (LAN) - for networking functions
- Universal Serial Bus (USB) - for functions implemented in the USB interface, and technologies such as broadband, DSL, and wireless
- System Management Bus (SMB) - for Plug-n-Play functionality
- Power - to provide the signals required for power management, and the main power supplies to operate the CNR circuitry

The CNR is tagged to replace the current Audio Modem Riser (AMR) slot because of its flexibility and added features. Also, the CNR slot does not take up the motherboard space for one PCI slot because it is a shared slot; rather, it provides you more options.

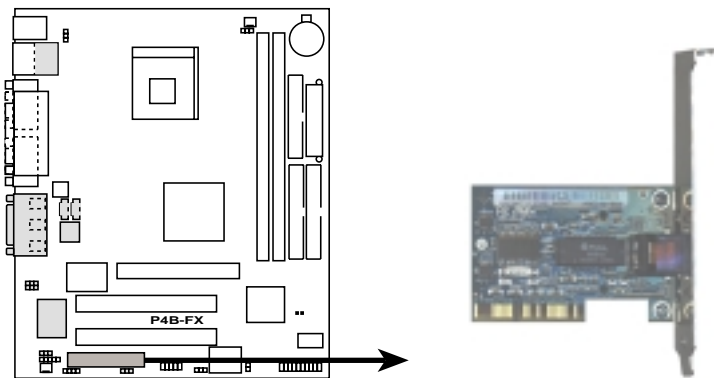

P4B-FX Communication & Networking Riser Connector

Figure 2-19 Communications and Networking Riser (CNR) Slot Location

2.7 Jumpers

The jumpers on the motherboard allow you to change some feature settings to suit your customized system configuration.



Before changing any jumper setting, make sure to read the jumper descriptions and setting requirements in this section.

1. USB device wake-up (3-pin USBPWR01, USBPWR23)

Set these jumpers to pins 1-2 (Enabled) to wake up the computer using the connected USB devices. Set to pins 2-3 to disable the USB wake-up feature. These jumpers are set to pins 2-3 (Disabled) by default.



The USB device wake-up feature requires a power supply that can provide at least 1A on the +5VSB lead. If this requirement is not met, the system does not power up. The total current consumed must NOT exceed the power supply capability (+5VSB) whether under normal condition or in sleep mode.

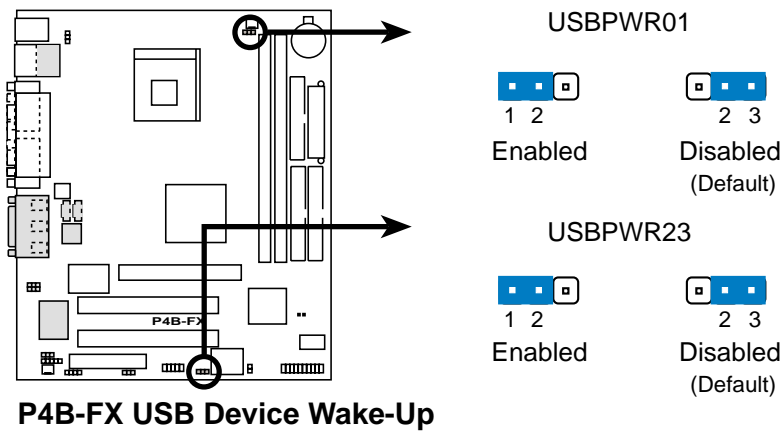

Figure 2-20 USB Device Wake-up Settings

2. Keyboard power (3-pin KB_PWR)

This jumper allows you to enable or disable the keyboard wake-up feature. Set this jumper to pins 1-2 if you wish to wake up the computer when you press a key on the keyboard (the default is the Space Bar). Set this jumper to pins 2-3 to disable this feature. This jumper is set to pins 2-3 (Disabled) by default.



The keyboard wake-up feature requires a power supply that can provide at least 1A on the +5VSB lead. If this requirement is not met, the system does not power up. The total current consumed must NOT exceed the power supply capability (+5VSB) whether under normal condition or in sleep mode.

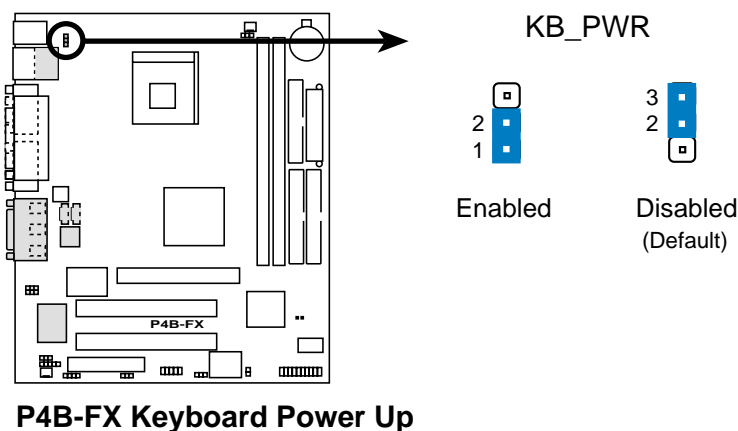

Figure 2-21 Keyboard Power Settings

3. Audio CODEC (3-pin AUD_EN1) (on audio models only)

This jumper allows you to enable or disable the audio CODEC on the motherboard. Disable the audio CODEC if you desire to install a PCI audio card into one of the PCI slots. The default setting is Enabled.

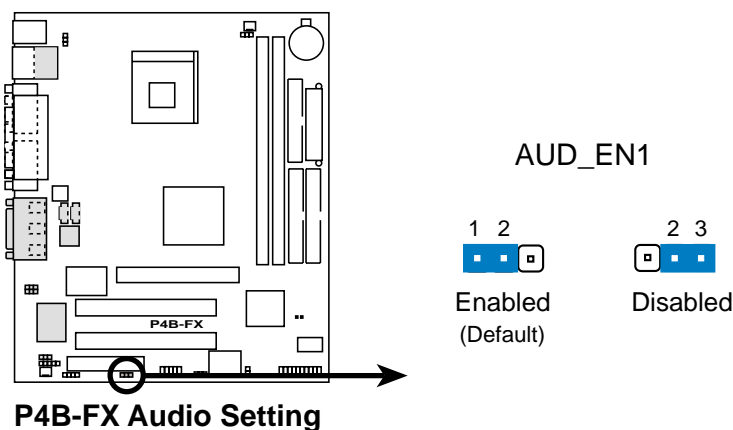

Figure 2-22 Audio CODEC Settings

4. LAN controller (3-pin LAN_EN) (on LAN models only)

This jumper allows you to enable or disable the onboard Local Area Network (LAN) feature. The default setting is Enabled.

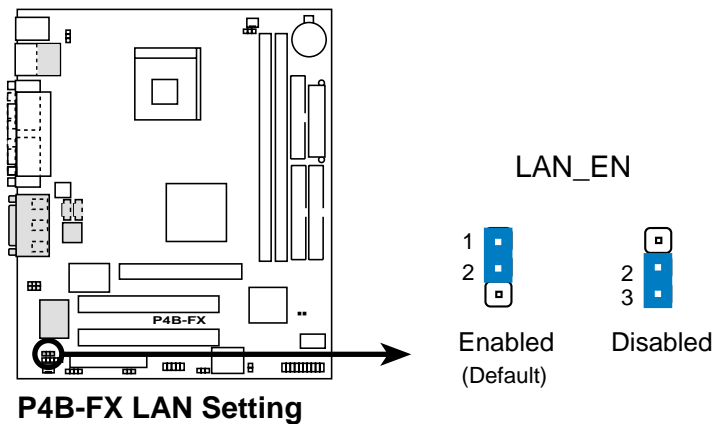

Figure 2-23 LAN Settings

5. Clear RTC RAM (CLRRTC)

These pads allow you to clear the Real Time Clock (RTC) RAM in CMOS. You can clear the CMOS memory of date, time, and system setup parameters by erasing the CMOS RTC RAM data. The RAM data in CMOS, that include system setup information such as system passwords, is powered by the onboard button cell battery.

To erase the RTC RAM:

1. Turn OFF the computer and unplug the power cord.
2. Remove the battery.
3. Short the two pads for a few seconds.
4. Re-install the battery.
5. Plug the power cord and turn ON the computer.
6. Hold down the key during the boot process and enter BIOS setup to re-enter data.

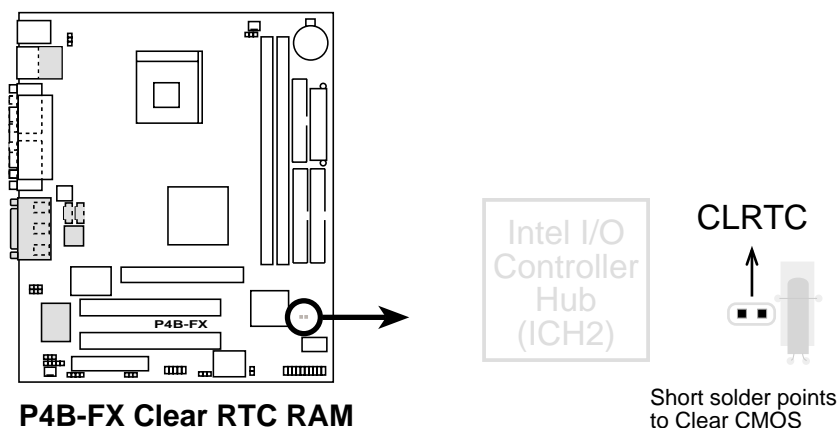

Figure 2-24 Clear RTC RAM

2.8 Connectors

This section describes and illustrates the internal connectors on the motherboard.



Do not place jumper caps over connector pins. Doing so may damage your motherboard.



Always connect ribbon cables with the red stripe to Pin 1 on the connectors. Pin 1 is usually on the side closest to the power connector on hard drives and CD-ROM drives, but may be on the opposite side on floppy disk drives.

1. Hard disk activity LED (2-pin IDELED)

This connector supplies power to the hard disk activity LED. The read or write activities of any device connected to the primary or secondary IDE connector cause this LED to light up.

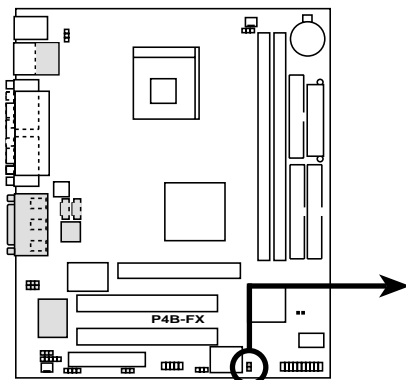

P4B-FX IDE Activity LED

IDELED



TIP: If the case-mounted LED does not light up, try reversing the 2-pin plug.

Figure 2-25 Hard Disk LED Connector

2. IDE connectors (40-1 pin PRIMARY IDE/SECONDARY IDE)

These connectors support the provided UltraDMA/100/66 IDE hard disk ribbon cable. Connect the cable's blue connector to the primary (recommended) or secondary IDE connector, then connect the gray connector to the UltraDMA/100/66 slave device (hard disk drive) and the black connector to the UltraDMA/100/66 master device. It is recommended that you connect non-UltraDMA/100/66 devices to the secondary IDE connector. If you install two hard disks, you must configure the second drive as a slave device by setting its jumper accordingly. Refer to the hard disk documentation for the jumper settings. BIOS supports specific device bootup. If you have more than two UltraDMA/100/66 devices, purchase another UltraDMA/100/66 cable. You may configure two hard disks to be both master devices with two ribbon cables – one for the primary IDE connector and another for the secondary IDE connector.



1. Pin 20 on each IDE connector is removed to match the covered hole on the UltraDMA cable connector. This prevents incorrect orientation when you connect the cables.
2. The hole near the blue connector on the UltraDMA/100/66 cable is intentional.

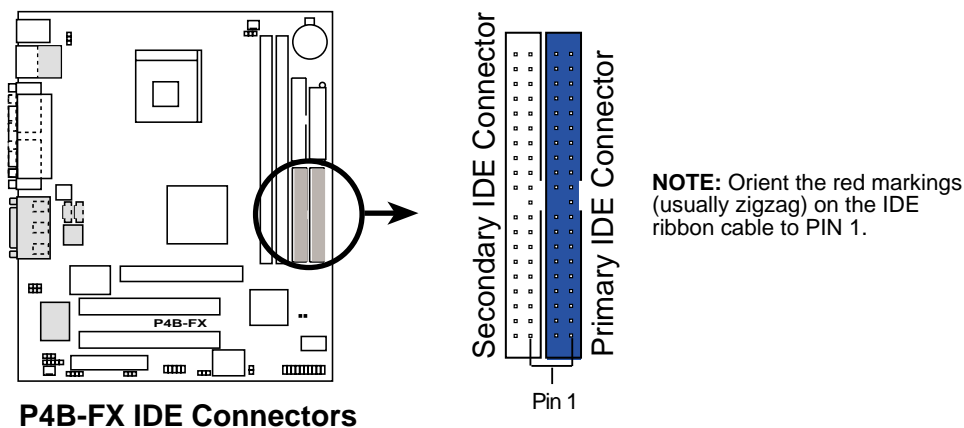

Figure 2-26 IDE Connectors



For UltraDMA/100/66 IDE devices, use an 80-conductor IDE cable. The UltraDMA/66 cable included in the motherboard package also supports UltraDMA/100.

3. Floppy disk drive connector (34-1 pin FLOPPY)

This connector supports the provided floppy drive ribbon cable. After connecting one end to the motherboard, connect the other end to the floppy drive. (Pin 5 is removed to prevent incorrect insertion when using ribbon cables with pin 5 plug).

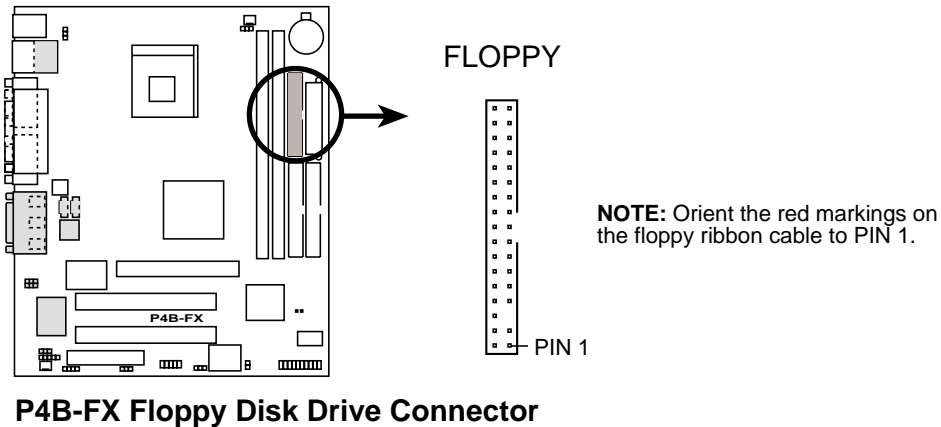

Figure 2-27 Floppy Disk Drive Connector

4. Fan connectors (3-pin CPUFAN, SYSTEM)

The fan connectors support a CPU fan and a system fan at +12V. Orient the fans properly to allow air flow to go across the onboard heat sinks instead of the expansion slots. The fan wiring and plug may vary depending on the fan manufacturer. Connect the fan cable to the connector matching the black wire to the ground pin.



Do not forget to connect the fan cables to the fan connectors. Lack of sufficient air flow within the system may damage the motherboard components. These are not jumpers! DO NOT place jumper caps on the fan connectors!

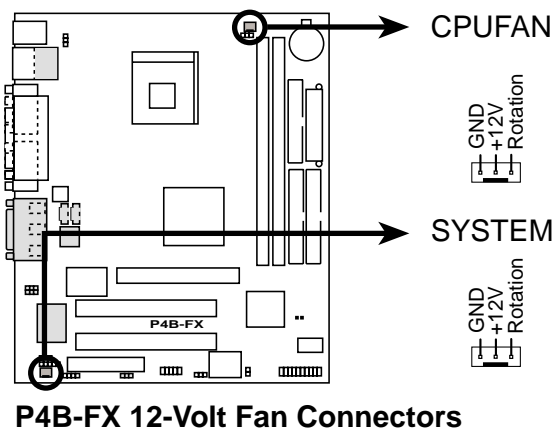

Figure 2-28 CPU and System Fan Connectors

5. USB header (10-1 pin USB2)

If the USB ports on the rear panel are inadequate, a USB header is available for two additional USB ports. Connect a 2-port USB connector set to the USB header and mount the USB bracket to an open slot in the chassis.

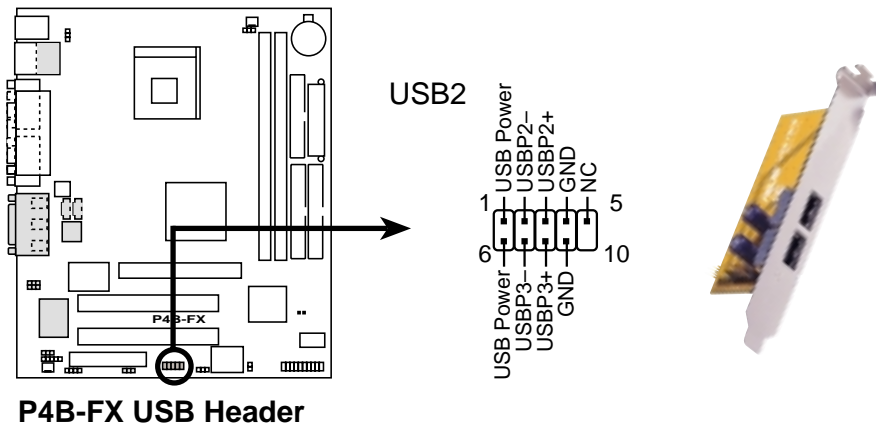

Figure 2-29 USB Header

6. Infrared module connector (5-1 pin IR_CN)

This connector supports an optional wireless transmitting and receiving infrared module. This module mounts to a small opening on system chassis that support this feature. Use the five pins as shown in Back View and connect a ribbon cable from the module to the motherboard SIR connector according to the pin definitions.

If you installed an infrared module, enable the **UART2 Use Standard Infrared** parameter in BIOS to set UART2 for use with IR. See section "4.4.2 I/O Device Configuration" for details.



If you enable the onboard infrared feature for use with an infrared module, the COM2 port does not work.

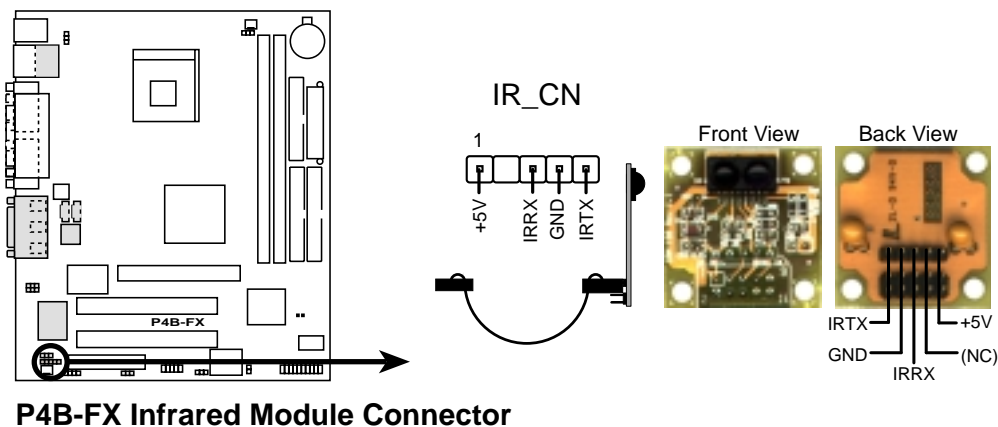

Figure 2-30 Infrared Module Connector

7. Power supply connectors (20-pin ATXPWR, 4-pin ATX+12V)

These connectors connect the power plugs from an ATX +12V power supply. The power plugs are designed to fit these connectors in only one orientation. Find the proper orientation and push down firmly until the connectors completely fit.

In addition to the 20-pin ATXPWR connector, this motherboard requires that you connect the 4-pin ATX +12V power plug to provide power to the CPU.



1. Make sure that your system has an ATX 12V power supply designed for the P4 CPU. This type of power supply should have a 4-pin +12V power plug.
2. Make sure that the power supply can provide at least 8A on the +12V lead and at least 1A on the +5-volt standby lead (+5VSB). The minimum recommended wattage is 230W, or 300W for a fully configured system. The system may become unstable and may experience difficulty powering up if the power supply is inadequate.

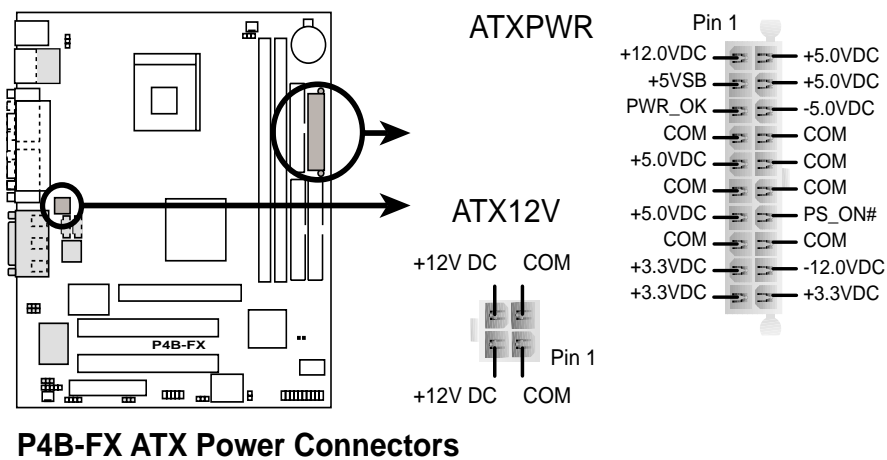

Figure 2-31 Power Supply Connectors

8. Internal audio connectors (4-pin CD1, AUX) *(on audio models only)*

These connectors allow you to receive stereo audio input from sound sources such as a CD-ROM, TV tuner, or MPEG card.

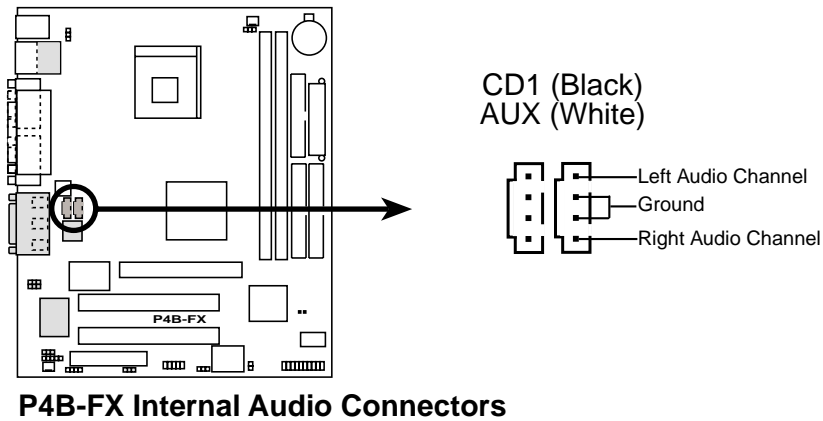

Figure 2-32 Internal Audio Connectors

9. Headphone true-level line out connector (3-pin HPHONE) *(on audio models only)*

This connector connects to an optional front panel audio module using a 3-pin audio cable. If your chassis has this audio module, you can connect a headphone/speaker to the front panel connector.



This connector is disabled when there is a line out device connected to the Line Out (lime) jack on the rear panel.

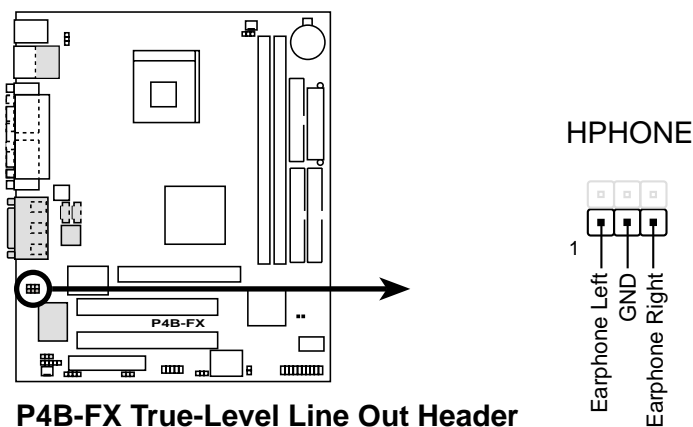

Figure 2-33 Headphone True-level Line Out Connector

10. Internal microphone connector (3-pin MIC2) *(on audio models only)*

This connector connects to an optional front panel audio module using a 3-pin audio cable. If your chassis has this audio module, you can connect a microphone to the front panel connector .



The front panel microphone may not work properly when there is another microphone connected to the Microphone (pink) jack on the rear panel. You may only use one microphone at a time.

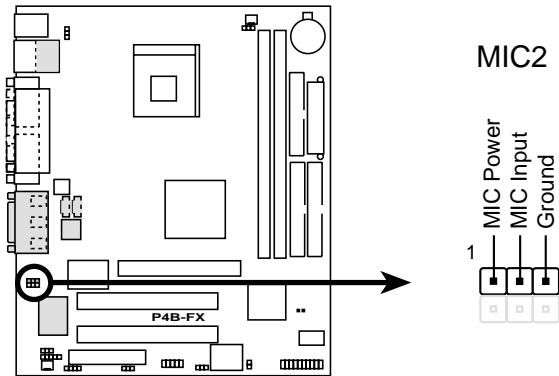

P4B-FX Internal Microphone Connector

Figure 2-34 Internal Microphone Connector

11. Chassis alarm lead (4-1 pin CHASSIS)

This lead is for a chassis designed with intrusion detection feature. This requires an external detection mechanism such as a chassis intrusion sensor or microswitch. When you remove any chassis component, the sensor triggers and sends a high-level signal to this lead to record a chassis intrusion event.



If you do not wish to use the chassis intrusion lead, place a jumper cap over the pins labeled “Chassis Signal” and “Ground” to close the circuit.

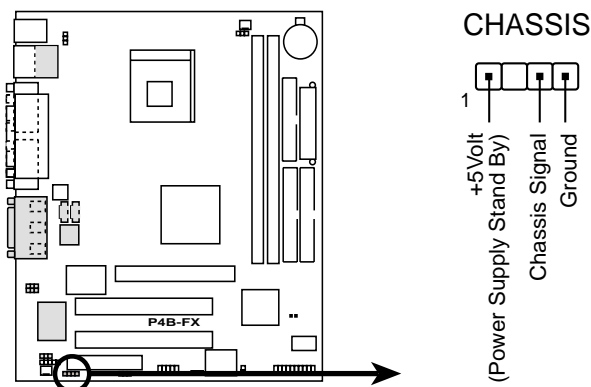

P4B-FX Chassis Alarm Lead

Figure 2-35 Chassis Alarm Lead

12. System panel connectors (20-pin PANEL)

This connector accommodates several system front panel functions.

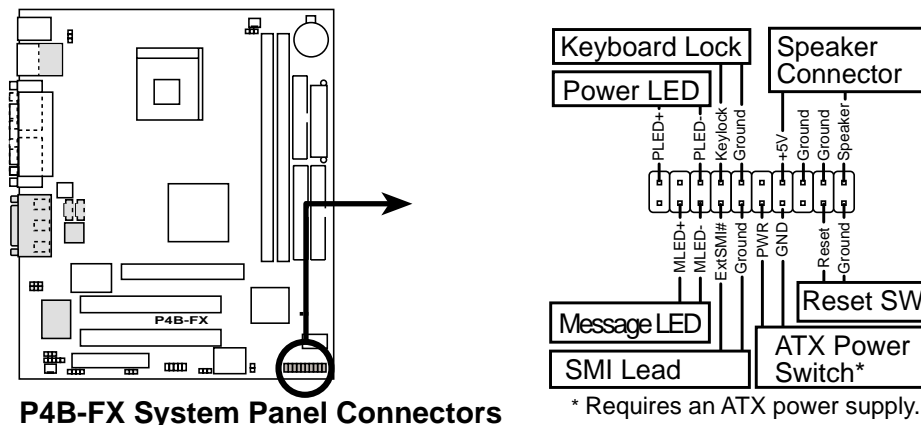

Figure 2-36 System Panel Connectors

- **System Power LED Lead (3-1 pin PWRLLED)**
This 3-1 pin connector connects to the system power LED. The LED lights up when you turn on the system power, and blinks when the system is in sleep mode.
- **Keyboard Lock Lead (1-pin KEYLOCK)**
This lead connects to a chassis-mounted switch to allow the use of the keyboard lock feature.
- **System Warning Speaker Lead (4-pin SPEAKER)**
This 4-pin connector connects to the case-mounted speaker and allows you to hear system beeps and warnings.
- **System Message LED Lead (2-pin MSGLED)**
This 2-pin connector is for the system message LED that indicates receipt of messages from a fax/modem. The normal status for this LED is ON, when there is no incoming data signal. The LED blinks when data is received. The system message LED feature requires an ACPI OS and driver support.

- **System Management Interrupt Lead (2-pin SMISW)**

This 2-pin connector allows you to manually place the system into a suspend mode, or “green” mode, where system activity is instantly decreased to save power and to expand the life of certain system components. Attach the case-mounted suspend switch to this 2-pin connector.

- **ATX Power Switch / Soft-Off Switch Lead (2-pin PWRSW)**

This connector connects a switch that controls the system power. Pressing the power switch turns the system between ON and SLEEP, or ON and SOFT OFF, depending on the BIOS or OS settings. Pressing the power switch while in the ON mode for more than 4 seconds turns the system OFF.

- **Reset Switch Lead (2-pin RESET)**

This 2-pin connector connects to the case-mounted reset switch for rebooting the system without turning off the system power.

Chapter 3

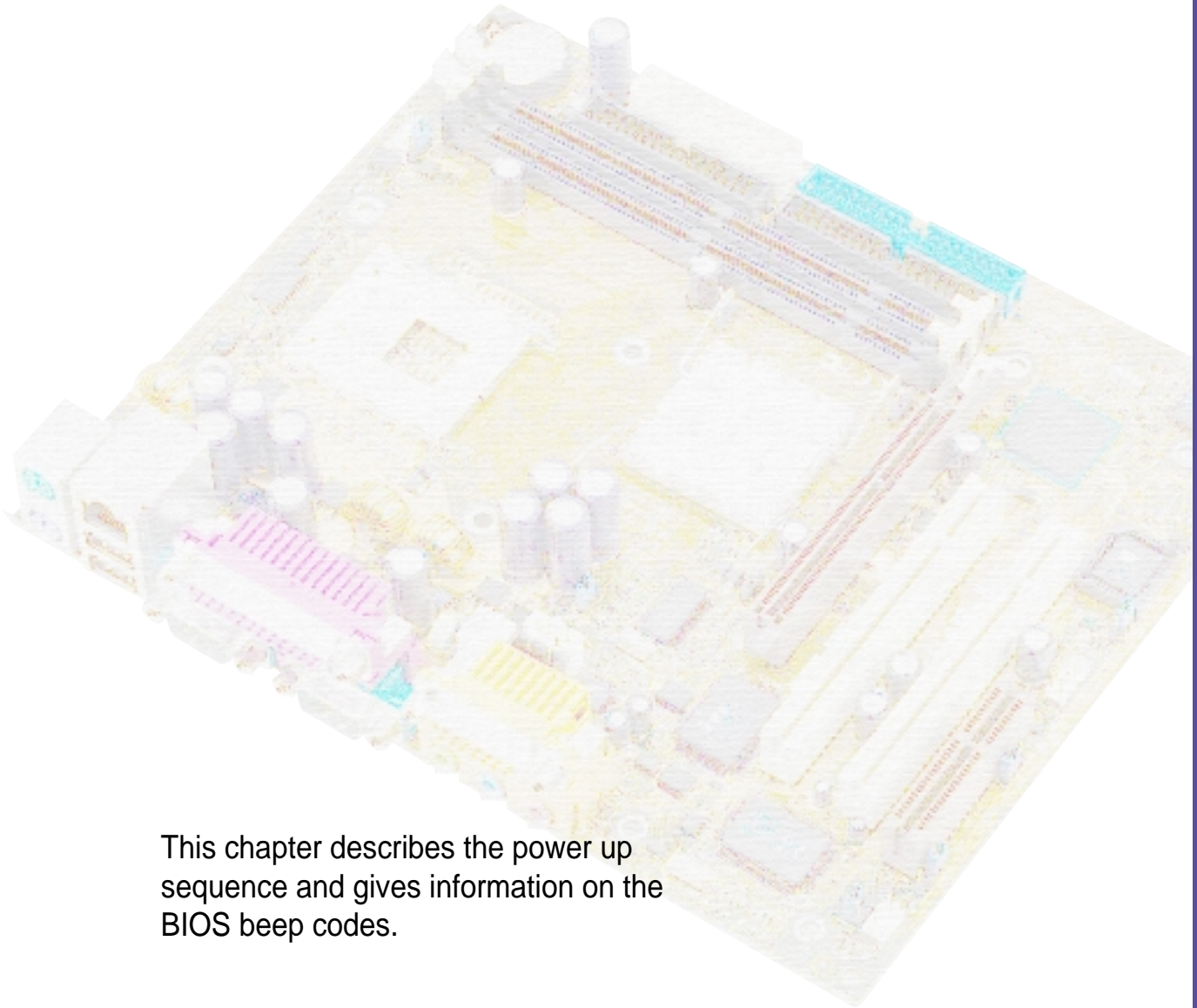

This chapter describes the power up sequence and gives information on the BIOS beep codes.

Powering up

3.1 Starting up for the first time

1. After making all the connections, replace the system case cover.
2. Be sure that all switches are off.
3. Connect the power cord to the power connector at the back of the system chassis.
4. Connect the power cord to a power outlet that is equipped with a surge protector.
5. Turn on the devices in the following order:
 - a. Monitor
 - b. External SCSI devices (starting with the last device on the chain)
 - c. System power (if you are using an ATX power supply, you need to switch on the power supply as well as press the ATX power switch on the front of the chassis).
6. After applying power, the power LED on the system front panel case lights up. For ATX power supplies, the system LED lights up when you press the ATX power switch. If your monitor complies with “green” standards or if it has a “power standby” feature, the monitor LED may light up or switch between orange and green after the system LED turns on. The system then runs the power-on tests. While the tests are running, the BIOS beeps or additional messages appear on the screen. If you do not see anything within 30 seconds from the time you turned on the power, the system may have failed a power-on test. Check the jumper settings and connections or call your retailer for assistance.

Award BIOS Beep Codes

Beep	Meaning
One short beep when displaying logo	No error during POST
Long beeps in an endless loop	No DRAM installed or detected
One long beep followed by three short beeps	Video card not found or video card memory bad
High frequency beeps when system is working	CPU overheated; System running at a lower frequency

7. At power on, hold down <Delete> to enter BIOS Setup. Follow the instructions in Chapter 4.

3.3 Powering off the computer

You must first exit the operating system and shut down the system before switching off the power. For ATX power supplies, you can press the ATX power switch after exiting or shutting down the operating system. If you use Windows 95/98/2000/XP, click the Start button, click Shut Down, then click the OK button to shut down the computer. The power supply should turn off after Windows shuts down.



The message “You can now safely turn off your computer” does not appear when shutting down with ATX power supplies.

Chapter 4

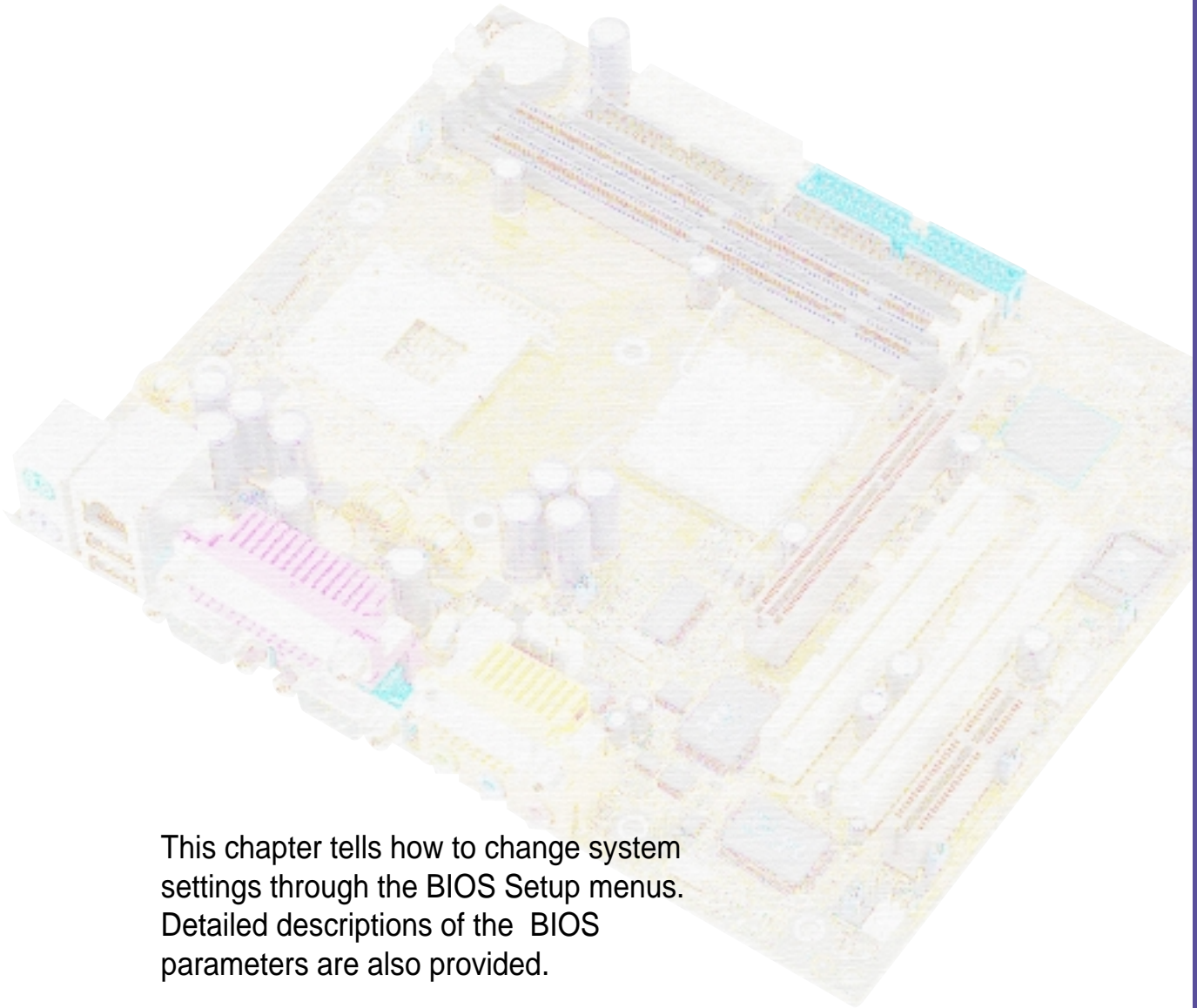

This chapter tells how to change system settings through the BIOS Setup menus. Detailed descriptions of the BIOS parameters are also provided.

BIOS setup

4.1 Managing and updating your BIOS

4.1.1 Using the computer system for the first time

It is recommended that you save a copy of the original motherboard BIOS along with a Flash Memory Writer utility (AFLASH.EXE) to a bootable floppy disk in case you need to reinstall the BIOS later. AFLASH.EXE is a Flash Memory Writer utility that updates the BIOS by uploading a new BIOS file to the programmable flash ROM on the motherboard. This file works only in DOS mode. To determine the BIOS version of your motherboard, check the last four numbers of the code displayed on the upper left-hand corner of your screen during bootup. Larger numbers represent a newer BIOS file.

1. Type `FORMAT A:/S` at the DOS prompt to create a bootable system disk. DO NOT copy `AUTOEXEC.BAT` and `CONFIG.SYS` to the disk.
2. Type `COPY D:\AFLASH\AFLASH.EXE A:\` (assuming D is your CD-ROM drive) to copy `AFLASH.EXE` to the boot disk you created.



AFLASH works only in DOS mode. It does not work in the DOS prompt within Windows and does not work with certain memory drivers that may be loaded when you boot from the hard drive. It is recommended that you reboot using a floppy disk.

3. Reboot the computer from the floppy disk.



BIOS setup must specify “Floppy” as the first item in the boot sequence.

4. In DOS mode, type `A:\AFLASH <Enter>` to run AFLASH.

```
ASUS ACPI BIOS
FLASH MEMORY WRITER V1.29
Copyright (C) 1994-99, ASUSTeK COMPUTER INC.

Flash Memory: Winbond W29C020 or SST 29EE020 or Intel B2082AB

Current BIOS Version: ASUS XXX-XX ACPI BIOS Revision 100X
BIOS Model           : XXX-XX
BIOS Built Date      : 09/25/98

Choose one of the following:

1. Save Current BIOS To File
2. Update BIOS Including Boot Block and ESCD

Enter choice: [1]

Press ESC To Exit
```



If the word “unknown” appears after Flash Memory:, the memory chip is either not programmable or is not supported by the ACPI BIOS and therefore, cannot be programmed by the Flash Memory Writer utility.

5. Select 1. Save Current BIOS to File from the Main menu and press <Enter>. The Save Current BIOS To File screen appears.

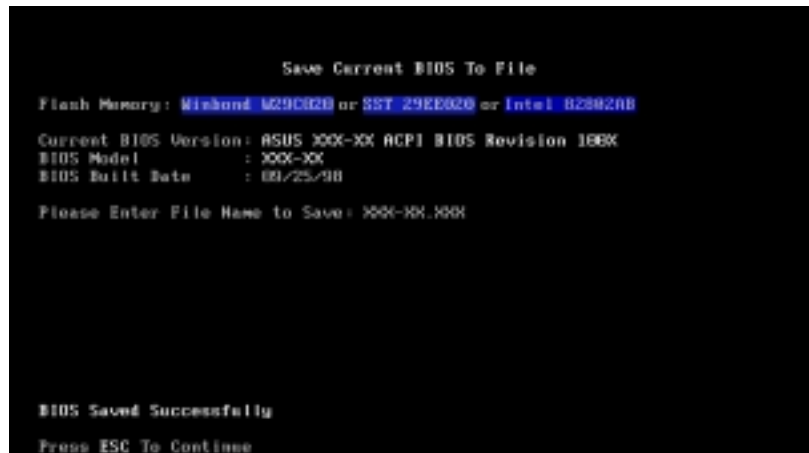

6. Type a filename and the path, for example, A:\XXX-XX.XXX, then press <Enter>.

4.1.2 Updating BIOS procedures



Update the BIOS only if you have problems with the motherboard and you are sure that the new BIOS revision will solve your problems. Careless updating may result to more problems with the motherboard!

1. Download an updated ASUS BIOS file from the Internet (see the ASUS Contact Information on page x for details) and save to the boot floppy disk you created earlier.
2. Boot from the floppy disk.
3. At the "A:" prompt, type AFLASH and then press <Enter>.
4. At the Main Menu, type 2 then press <Enter>. The Update BIOS Including Boot Block and ESCD screen appears.
5. Type the filename of your new BIOS and the path, for example, A:\XXX-XX.XXX, then press <Enter>.

To cancel this operation, press <Enter>.

```
Update BIOS Including Boot Block and ESCD
Flash Memory: Winbond W29C020 or SST 29EE020 or Intel B28020
Current BIOS Version: ASUS XXX-XX ACPI BIOS Revision 180K
BIOS Model      : XXX-XX
BIOS Built Date   : 09/25/99
Please Enter File Name for NEW BIOS: a:\XXX-XX\XXX
```

6. When prompted to confirm the BIOS update, press Y to start the update.

```
Update BIOS Including Boot Block and ESCD
Flash Memory: Winbond W29C020 or SST 29EE020 or Intel B28020
BIOS Version
(CURRENT) ASUS XXX-XX ACPI BIOS Revision 180K
(test.awd) ASUS XXX-XX ACPI BIOS Revision 180K
BIOS Model
(CURRENT) XXX-XX
(test.awd) XXX-XX
Date of BIOS Built
(CURRENT) 09/25/99
(XXXX,XXX) 05/29/99
Check sum of 1001.010 is F266.
Are you sure (Y/N) ? [Y]
Press ESC To Return to Main Menu
```

7. The utility starts to program the new BIOS information into the Flash ROM. The boot block is updated automatically only when necessary. This minimizes the possibility of boot problems in case of update failures. When the programming is done, the message “*Flashed Successfully*” appears.

```
Update BIOS Including Boot Block and ESCD
Flash Memory: Winbond W29C020 or SST 29EE020 or Intel B28020B
BIOS Version
(CURRENT) ASUS XXX-XX ACPI BIOS Revision 100X
(test.amd) ASUS XXX-XX ACPI BIOS Revision 100X
BIOS Model
(CURRENT) XXX-XX
(test.amd) XXX-XX
Date of BIOS Built
(CURRENT) 09/25/99
(test.amd) 05/29/99
Check sum of 1001.010 is F256.
Are you sure (Y/N) ? (Y)
Block Erasing -- Done
Programming -- 3FFF
Flashed Successfully
Press ESC To Continue
```

8. Follow the onscreen instructions to continue.

```
ASUS ACPI BIOS
FLASH MEMORY WRITER V1.29
Copyright (C) 1994-99, ASUSTeK COMPUTER INC.
Flash Memory: Winbond W29C020 or SST 29EE020 or Intel B28020B
Current BIOS Version: ASUS XXX-XX ACPI BIOS Revision 100X
BIOS Model : XXX-XX
BIOS Built Date : 05/29/99
Choose one of the following:
1. Save Current BIOS To File
2. Update BIOS Including Boot Block and ESCD
Enter choice: [1]
You have flashed the EPROM. It is recommended that you turn off
the power, enter SETUP and Load Setup Defaults to have CMOS
updated with new BIOS when exits.
Press ESC To Exit
```



If you encounter problems while updating the new BIOS, DO NOT turn off the system because this may cause boot problems. Just repeat the process, and if the problem persists, load the original BIOS file you saved to the boot disk. If the Flash Memory Writer utility is not able to successfully update a complete BIOS file, the system may not boot. If this happens, call the ASUS service center for support.

4.2 BIOS Setup program

This motherboard supports a programmable EEPROM that you can update using the provided utility described in section “4.1 Managing and updating your BIOS.”

Use the BIOS Setup program when you are installing a motherboard, reconfiguring your system, or prompted to “Run Setup”. This section explains how to configure your system using this utility.

Even if you are not prompted to use the Setup program, you may want to change the configuration of your computer in the future. For example, you may want to enable the security password Feature or make changes to the power management settings. This requires you to reconfigure your system using the BIOS Setup program so that the computer can recognize these changes and record them in the CMOS RAM of the EEPROM.

The EEPROM on the motherboard stores the Setup utility. When you start up the computer, the system provides you with the opportunity to run this program. Press <Delete> during the Power-On Self Test (POST) to enter the Setup utility, otherwise, POST continues with its test routines.

If you wish to enter Setup after POST, restart the system by pressing <Ctrl> + <Alt> + <Delete>, or by pressing the reset button on the system chassis. You can also restart by turning the system off and then back on. Do this last option only if the first two failed.

The Setup program is designed to make it as easy to use as possible. It is a menu-driven program, which means you can scroll through the various sub-menus and make your selections among the predetermined choices.



Because the BIOS software is constantly being updated, the following BIOS setup screens and descriptions are for reference purposes only, and may not exactly match what you see on your screen.

4.2.1 BIOS menu bar

The top of the screen has a menu bar with the following selections:

- MAIN** Use this menu to make changes to the basic system configuration.
- ADVANCED** Use this menu to enable and make changes to the advanced features.
- POWER** Use this menu to configure and enable Power Management features.
- BOOT** Use this menu to configure the default system device used to locate and load the Operating System.
- EXIT** Use this menu to exit the current menu or to exit the Setup program.

To access the menu bar items, press the right or left arrow key on the keyboard until the desired item is highlighted.

4.2.2 Legend bar

At the bottom of the Setup screen is a legend bar. The keys in the legend bar allow you to navigate through the various setup menus. The following table lists the keys found in the legend bar with their corresponding functions.

Navigation Key(s)	Function Description
<F1> or <Alt + H>	Displays the General Help screen from anywhere in the BIOS Setup
<Esc>	Jumps to the Exit menu or returns to the main menu from a sub-menu
Left or Right arrow	Selects the menu item to the left or right
Up or Down arrow	Moves the highlight up or down between fields
- (minus key)	Scrolls backward through the values for the highlighted field
+ (plus key) or spacebar	Scrolls forward through the values for the highlighted field
<Enter>	Brings up a selection menu for the highlighted field
<Home> or <PgUp>	Moves the cursor to the first field
<End> or <PgDn>	Moves the cursor to the last field
<F5>	Resets the current screen to its Setup Defaults
<F10>	Saves changes and exits Setup

General help

In addition to the Item Specific Help window, the BIOS setup program also provides a General Help screen. You may launch this screen from any menu by simply pressing <F1> or the <Alt> + <H> combination. The General Help screen lists the legend keys and their corresponding functions.

Saving changes and exiting the Setup program

See “4.7 Exit Menu” for detailed information on saving changes and exiting the setup program.

Scroll bar

When a scroll bar appears to the right of a help window, it indicates that there is more information to be displayed that will not fit in the window. Use <PgUp> and <PgDn> or the up and down arrow keys to scroll through the entire help document. Press <Home> to display the first page, press <End> to go to the last page. To exit the help window, press <Enter> or <Esc>.

Sub-menu

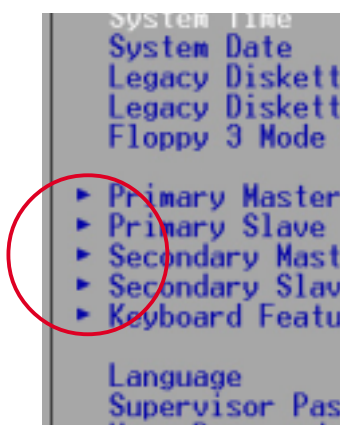

Note that a right pointer symbol (as shown on the left) appears to the left of certain fields. This pointer indicates that you can display a sub-menu from this field. A sub-menu contains additional options for a field parameter. To display a sub-menu, move the highlight to the field and press <Enter>. The sub-menu appears. Use the legend keys to enter values and move from field to field within a sub-menu as you would within a menu. Use the <Esc> key to return to the main menu.

Take some time to familiarize yourself with the legend keys and their corresponding functions. Practice navigating through the various menus and sub-menus. If you accidentally make unwanted changes to any of the fields, use the set default hot key <F5> to load the Setup default values. While moving around through the Setup program, note that explanations appear in the Item Specific Help window located to the right of each menu. This window displays the help text for the currently highlighted field.

4.3 Main menu

When you enter the Setup program, the following screen appears.

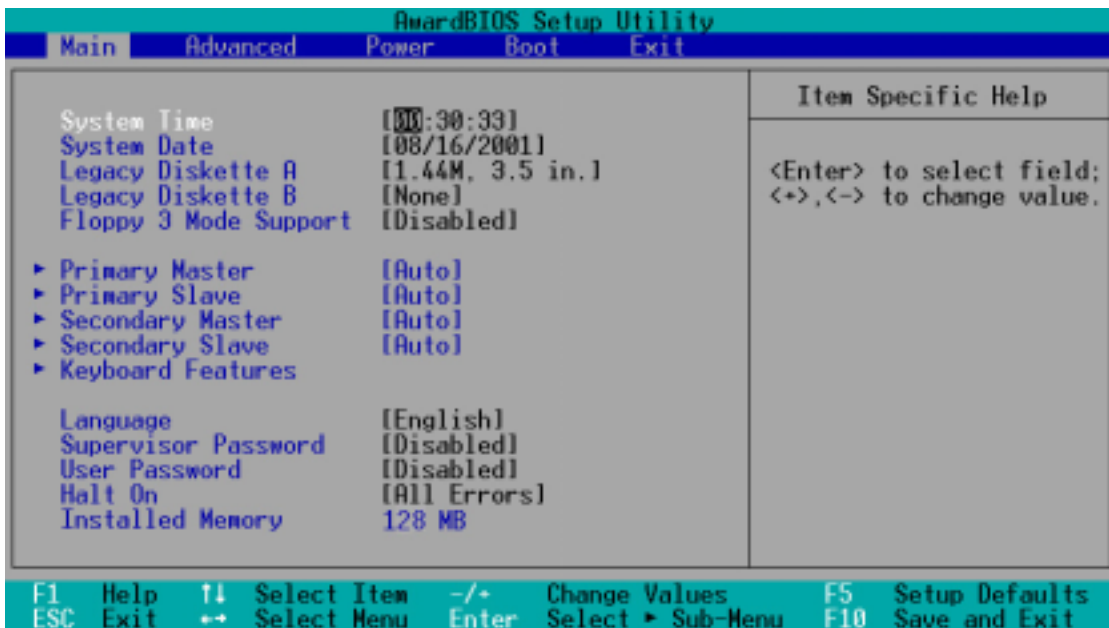

System Time [XX:XX:XX]

Sets the system to the time that you specify (usually the current time). The format is hour, minute, second. Valid values for hour, minute and second are Hour: (00 to 23), Minute: (00 to 59), Second: (00 to 59). Use the <Tab> or <Shift> + <Tab> keys to move between the hour, minute, and second fields.

System Date [XX/XX/XXXX]

Sets the system to the date that you specify (usually the current date). The format is month, day, year. Valid values for month, day, and year are Month: (1 to 12), Day: (1 to 31), Year: (up to 2084). Use the <Tab> or <Shift> + <Tab> keys to move between the month, day, and year fields.

Legacy Diskette A, Legacy Diskette B [1.44M, 3.5 in.]

Sets the type of floppy drive installed. Configuration options: [None] [360K, 5.25 in.] [1.2M , 5.25 in.] [720K , 3.5 in.] [1.44M, 3.5 in.] [2.88M, 3.5 in.]

Floppy 3 Mode Support [Disabled]

This is required to support older Japanese floppy drives. The Floppy 3 Mode feature allows reading and writing of 1.2MB (as opposed to 1.44MB) on a 3.5-inch diskette. Configuration options: [Disabled] [Enabled]

4.3.1 Primary & Secondary Master/Slave

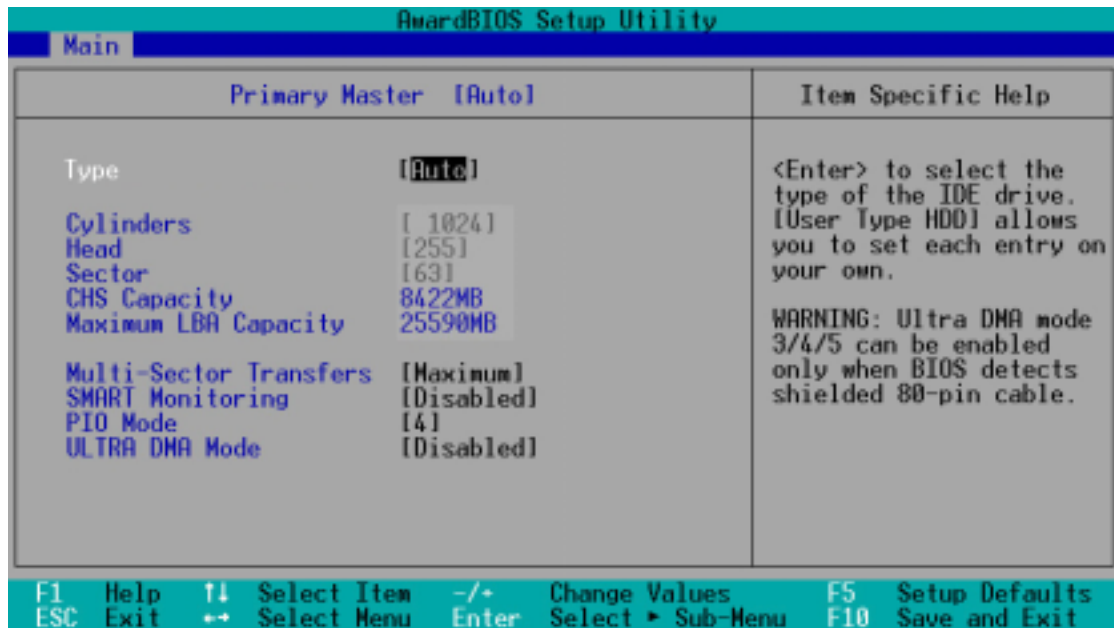

Type [Auto]

Select [Auto] to automatically detect an IDE hard disk drive. If automatic detection is successful, Setup automatically fills in the correct values for the remaining fields on this sub-menu. If automatic detection fails, this may be because the hard disk drive is too old or too new. If the hard disk was already formatted on an older system, Setup may detect incorrect parameters. In these cases, select [User Type HDD] to manually enter the IDE hard disk drive parameters. Refer to the next section for details.



Before attempting to configure a hard disk drive, make sure you have the correct configuration information supplied by the drive manufacturer. Incorrect settings may cause the system to fail to recognize the installed hard disk.

[User Type HDD]

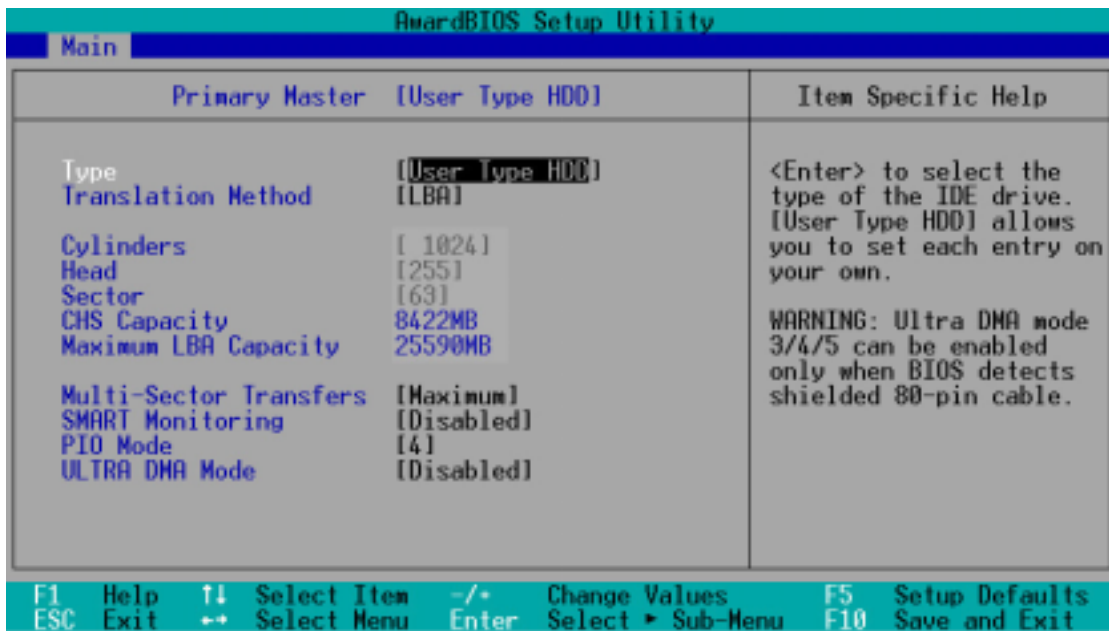

Manually enter the number of cylinders, heads and sectors per track for the drive. Refer to the drive documentation or on the drive label for this information.



After entering the IDE hard disk drive information into BIOS, use a disk utility, such as FDISK, to partition and format new IDE hard disk drives. This is necessary so that you can write or read data from the hard disk. Make sure to set the partition of the Primary IDE hard disk drives to active.

If no drive is installed or if you are removing a drive and not replacing it, select [None].

Other options for the Type field are:

[CD-ROM] - for IDE CD-ROM drives

[LS-120] - for LS-120 compatible floppy disk drives

[ZIP] - for ZIP-compatible disk drives

[MO] - for IDE magneto optical disk drives

[Other ATAPI Device] - for IDE devices not listed here

After making your selections on this sub-menu, press the <Esc> key to return to the Main menu. When the Main menu appears, the hard disk drive field displays the size for the hard disk drive that you configured.

Translation Method [LBA]

Select the hard disk drive type in this field. When Logical Block Addressing (LBA) is enabled, the 28-bit addressing of the hard drive is used without regard for cylinders, heads, or sectors. Note that LBA Mode is necessary for drives with more than 504MB storage capacity. Configuration options: [LBA] [LARGE] [Normal] [Match Partition Table] [Manual]

Cylinders

This field configures the number of cylinders. Refer to the drive documentation to determine the correct value. To make changes to this field, set the Type field to [User Type HDD] and the Translation Method field to [Manual].

Head

This field configures the number of read/write heads. Refer to the drive documentation to determine the correct value. To make changes to this field, set the Type field to [User Type HDD] and the Translation Method field to [Manual].

Sector

This field configures the number of sectors per track. Refer to the drive documentation to determine the correct value. To make changes to this field, set the Type field to [User Type HDD] and the Translation Method field to [Manual].

CHS Capacity

This field shows the drive's maximum CHS capacity as calculated by the BIOS based on the drive information you entered.

Maximum LBA Capacity

This field shows the drive's maximum LBA capacity as calculated by the BIOS based on the drive information you entered.

Multi-Sector Transfers [Maximum]

This option automatically sets the number of sectors per block to the highest number that the drive supports. Note that when this field is automatically configured, the set value may not always be the fastest value for the drive. You may also manually configure this field. Refer to the documentation that came with the hard drive to determine the optimum value and set it manually. To make changes to this field, set the Type field to [User Type HDD]. Configuration options: [Disabled] [2 Sectors] [4 Sectors] [8 Sectors] [16 Sectors] [32 Sectors] [Maximum]

SMART Monitoring [Disabled]

This field allows you to enable or disable the S.M.A.R.T. (Self-Monitoring, Analysis and Reporting Technology) system that utilizes internal hard disk drive monitoring technology. This parameter is normally disabled because the resources used in the SMART monitoring feature may decrease system performance. Configuration options: [Disabled] [Enabled]

PIO Mode [4]

This option lets you set a PIO (Programmed Input/Output) mode for the IDE device. Modes 0 through 4 provide successive increase in performance. Configuration options: [0] [1] [2] [3] [4]

Ultra DMA Mode [Disabled]

Ultra DMA capability allows improved transfer speeds and data integrity for compatible IDE devices. Set to [Disabled] to suppress Ultra DMA capability. To make changes to this field, set the Type field to [User Type HDD]. Configuration options: [0] [1] [2] [3] [4] [5] [Disabled]

4.3.2 Keyboard Features

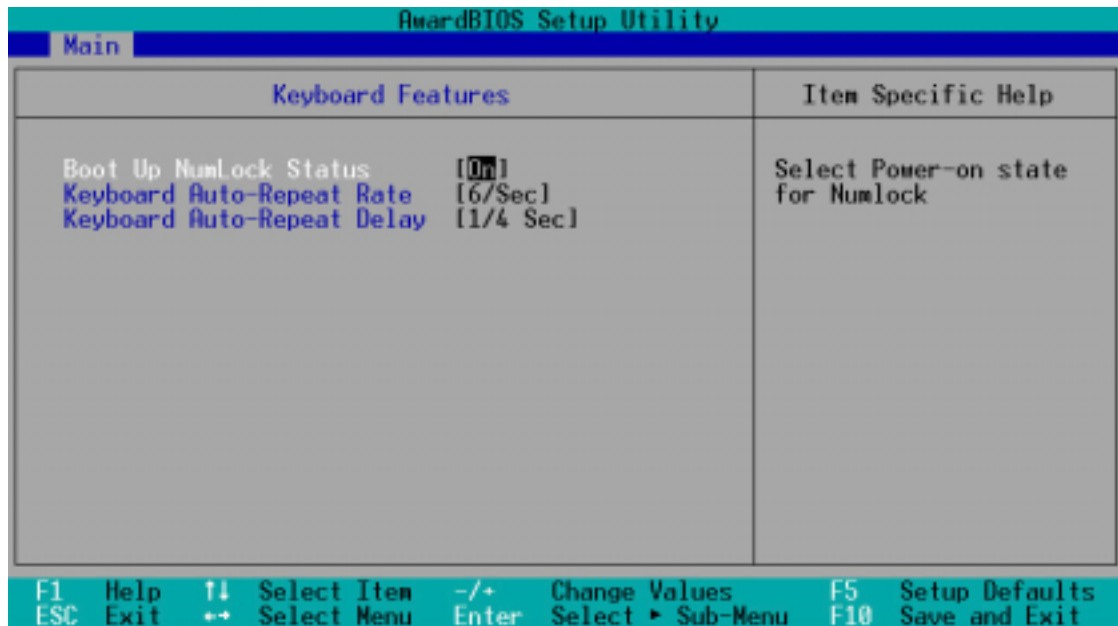

Boot Up NumLock Status [On]

This field enables users to activate the Number Lock function upon system boot. Configuration options: [Off] [On]

Keyboard Auto-Repeat Rate [6/Sec]

This controls the speed at which the system registers repeated keystrokes. Options range from 6 to 30 characters per second. Configuration options: [6/Sec] [8/Sec] [10/Sec] [12/Sec] [15/Sec] [20/Sec] [24/Sec] [30/Sec]

Keyboard Auto-Repeat Delay [1/4 Sec]

This field sets the time interval for displaying the first and second characters. Configuration options: [1/4 Sec] [1/2 Sec] [3/4 Sec] [1 Sec]

Main menu items continued...

Language [English]

This field displays the BIOS language version.

Supervisor Password [Disabled] / User Password [Disabled]

These fields allow you to set passwords. To set a password, highlight the appropriate field and press <Enter>. Type in a password then press <Enter>. You can type up to eight alphanumeric characters. Symbols and other characters are ignored. To confirm the password, type the password again and press <Enter>. The password is now set to [Enabled]. This password allows full access to the BIOS Setup menus. To clear the password, highlight this field and press <Enter>. The same dialog box as above appears. Press <Enter>. The password is set to [Disabled].

A note about passwords

The BIOS Setup program allows you to specify passwords in the Main menu. The passwords control access to the BIOS during system startup. Passwords are not case sensitive, meaning, passwords typed in either uppercase or lowercase letters are accepted. The BIOS Setup program allows you to specify two different passwords: a Supervisor password and a User password. If you did not set a Supervisor password, anyone can access the BIOS Setup program. If you did, the Supervisor password is required to enter the BIOS Setup program and to gain full access to the configuration fields.

Halt On [All Errors]

This field specifies the types of errors that will cause the system to halt. Configuration options: [All Errors] [No Error] [All but Keyboard] [All but Disk] [All but Disk/Keyboard]

Installed Memory [XXX MB]

This field automatically displays the amount of conventional memory detected by the system during the boot process.

4.4 Advanced Menu

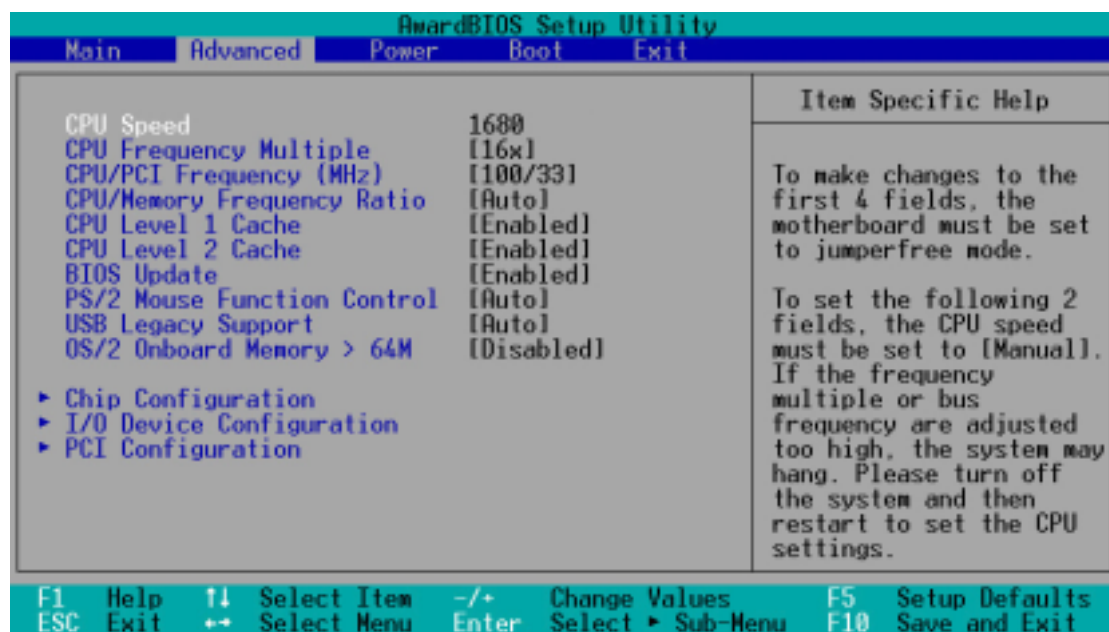

CPU Speed

This parameter displays the auto-detected CPU speed.

CPU Frequency Multiple

This field is for unlocked processors only. If your processor frequency multiple is locked, you cannot access this field. This field sets the frequency multiple between the CPU's internal frequency (CPU speed) and external frequency.

CPU/PCI Frequency (MHz)

This feature tells the clock generator what frequency to send to the system bus and PCI bus. The bus frequency (external frequency) multiplied by the bus multiple equals the CPU speed. The setting of this field depends on the CPU Frequency Multiple.

CPU/Memory Frequency Ratio [Auto]

This field determines whether the memory clock frequency is set to be in synchronous or asynchronous mode with respect to the system frequency. The options that appear in the popup menu vary according to the CPU/PCI Frequency (MHz). Configuration options: [Auto] [1:1] [3:4]

CPU Level 1 Cache, CPU Level 2 Cache [Enabled]

These fields allow you to choose from the default of [Enabled] or choose [Disabled] to turn on or off the CPU Level 1 and Level 2 built-in cache. Configuration options: [Disabled] [Enabled]

BIOS Update [Enabled]

This field functions as an update loader integrated into the BIOS to supply the processor with the required data. When set to [Enabled], the BIOS loads the update on all processors during system bootup. Configuration options: [Disabled] [Enabled]

PS/2 Mouse Function Control [Auto]

The default setting [Auto] allows the system to detect a PS/2 mouse at startup. If a mouse is detected, the BIOS assigns IRQ12 to the PS/2 mouse. Otherwise, IRQ12 can be used for expansion cards. When you set this field to [Enabled], BIOS reserves IRQ12, whether or not a PS/2 mouse is detected at startup. Configuration options: [Enabled] [Auto]

USB Legacy Support [Auto]

This motherboard supports Universal Serial Bus (USB) devices. The default of [Auto] allows the system to detect a USB device at startup. If detected, the USB controller legacy mode is enabled. If not detected, the USB controller legacy mode is disabled.

When you set this field to [Disabled], the USB controller legacy mode is disabled whether or not you are using a USB device. Configuration options: [Disabled] [Enabled] [Auto]

OS/2 Onboard Memory > 64M [Disabled]

When using OS/2 operating systems with installed DRAM of greater than 64MB, you need to set this option to [Enabled]. Otherwise, leave to the default setting [Disabled]. Configuration options: [Disabled] [Enabled]

4.4.1 Chip Configuration

AwardBIOS Setup Utility		
Advanced		
Chip Configuration	Item Specific Help	
SDRAM Configuration	[By SPD]	<Enter> to select SDRAM configuration. [By SPD] is recommended. [User Defined] allows you to set each configuration on your own.
SDRAM CAS Latency	[3T]	
SDRAM RAS to CAS Delay	[3T]	
SDRAM RAS Precharge Delay	[3T]	
SDRAM Active Precharge Delay	[6T]	
SDRAM Idle Timer	[Infinite]	
Graphics Aperture Size	[64MB]	
AGP Capability	[4X Mode]	
Video Memory Cache Mode	[UC]	
Memory Hole At 15M-16M	[Disabled]	
Delay Transaction	[Disabled]	
Onboard PCI IDE	[Both]	

F1 Help ↑↓ Select Item -/+ Change Values F5 Setup Defaults
ESC Exit ↔ Select Menu Enter Select ▶ Sub-Menu F10 Save and Exit

SDRAM Configuration [By SPD]

This parameter allows you to set the optimal timings for items 2–5, depending on the memory modules that you are using. The default setting is [By SPD], which configures items 2–5 by reading the contents in the SPD (Serial Presence Detect) device. The EEPROM on the memory module stores critical information about the module, such as memory type, size, speed, voltage interface, and module banks.

Configuration options: [User Defined] [By SPD]

SDRAM CAS Latency [3T]

This item controls the latency between the SDRAM read command and the time the data actually becomes available.



The SDRAM CAS Latency parameter appears only when you set the SDRAM Configuration to [User Defined].

SDRAM RAS to CAS Delay [3T]

This item controls the latency between the SDRAM active command and the read/write command.



The SDRAM RAS to CAS Delay parameter appears only when you set the SDRAM Configuration to [User Defined].

SDRAM RAS Precharge Delay [3T]

This item controls the idle clocks after issuing a precharge command to the SDRAM.



The SDRAM RAS Precharge Delay parameter appears only when you set the SDRAM Configuration to [User Defined].

SDRAM Active Precharge Delay [6T]

This item controls the number of SDRAM clocks used for SDRAM parameters.



The SDRAM Active Precharge Delay parameter appears only when you set the SDRAM Configuration to [User Defined].

SDRAM Idle Timer [Infinite]

Configuration options: [Infinite] [0T] [8T] [16T] [64T]

Graphics Aperture Size [64MB]

This feature allows you to select the size of mapped memory for AGP graphic data. Configuration options: [4MB] [8MB] [16MB] [32MB] [64MB] [128MB] [256MB]

AGP Capability [4X Mode]

This motherboard supports the AGP 4X interface that transfers video data at 1066MB/s. AGP 4X is backward-compatible, so you may keep the default [4X Mode] even if you are using an AGP 1X video card. When set to [1X Mode], the AGP interface only provides a peak data throughput of 266MB/s even if you are using an AGP 4x card.

Configuration options: [1X Mode] [4X Mode]

Video Memory Cache Mode [UC]

USWC (uncacheable, speculative write combining) is a new cache technology for the video memory of the processor. It can greatly improve the display speed by caching the display data. You must set this to UC (uncacheable) if your display card does not support this feature, otherwise the system may not boot. Configuration options: [UC] [USWC]

Memory Hole At 15M-16M [Disabled]

This field allows you to reserve an address space for ISA expansion cards. Setting the address space to a particular setting makes that memory space unavailable to other system components. Expansion cards can only access memory up to 16MB. Configuration options: [Disabled] [Enabled]

Delayed Transaction [Disabled]

When set to [Enabled], this feature frees the PCI bus when the CPU is accessing 8-bit ISA cards. This process normally consumes about 50-60 PCI Clocks without PCI delayed transaction. Set this field to [Disabled] when using ISA cards that are not PCI 2.1 compliant. Configuration options: [Enabled] [Disabled]

Onboard PCI IDE [Both]

This field allows you to enable either the primary IDE channel or secondary IDE channel, or both. You can also set both channels to [Disabled]. Configuration options: [Both] [Primary] [Secondary] [Disabled]

4.4.2 I/O Device Configuration

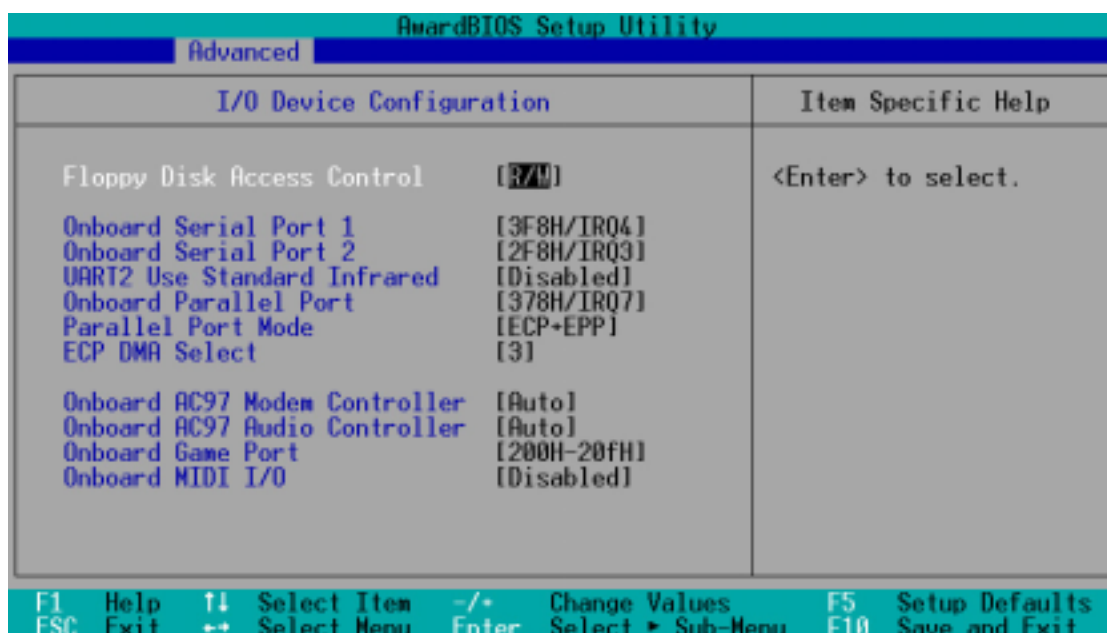

Floppy Disk Access Control [R/W]

When set to [Read Only], this parameter protects files from being copied to floppy disks by allowing reads from, but not writes to, the floppy disk drive. The default setting [R/W] allows both reads and writes. Configuration options: [R/W] [Read Only]

Onboard Serial Port 1 [3F8H/IRQ4]

Onboard Serial Port 2 [2F8H/IRQ3]

These fields allow you to set the addresses for the onboard serial connectors. Serial Port 1 and Serial Port 2 must have different addresses. Configuration options: [3F8H/IRQ4] [2F8H/IRQ3] [3E8H/IRQ4] [2E8H/IRQ10] [Disabled]

UART2 Use Standard Infrared [Disabled]

This field allows you to select the device on which to assign UART2.
Configuration options: [Disabled] [Enabled]

Onboard Parallel Port [378H/IRQ7]

This field sets the address of the onboard parallel port connector. If you disable this field, the Parallel Port Mode and ECP DMA Select configurations are not available. Configuration options: [Disabled] [378H/IRQ7] [278H/IRQ5]

Parallel Port Mode [ECP+EPP]

This field allows you to set the operation mode of the parallel port. [Normal] allows normal-speed operation but in one direction only; [EPP] allows bidirectional parallel port operation; [ECP] allows the parallel port to operate in bidirectional DMA mode; [ECP+EPP] allows normal speed operation in a two-way mode. Configuration options: [Normal] [EPP] [ECP] [ECP+EPP]

ECP DMA Select [3]

This field allows you to configure the parallel port DMA channel for the selected ECP mode. This selection is available only if you select [ECP] or [ECP+EPP] in Parallel Port Mode above. Configuration options: [1] [3]

Onboard AC97 Audio Controller [Auto]

Onboard AC97 Modem Controller [Auto]

[Auto] allows the BIOS to detect whether you are using any modem/audio device. If a modem/audio device is detected, the onboard modem/audio controller is enabled; if no modem/audio device is detected, the controller is disabled. If there are conflicts with the onboard modem/audio controller, set the appropriate field to [Disabled]. Configuration options: [Disabled] [Auto]

Onboard Game Port [200H-207H]

This field allows you to select the I/O address for the game port.
Configuration options: [Disabled] [200H-207H] [208H-20FH]

Onboard MIDI I/O [Disabled]

This field allows you to select the I/O address for the game port.
Configuration options: [Disabled] [330H-331H] [300H-301H]

4.4.3 PCI Configuration

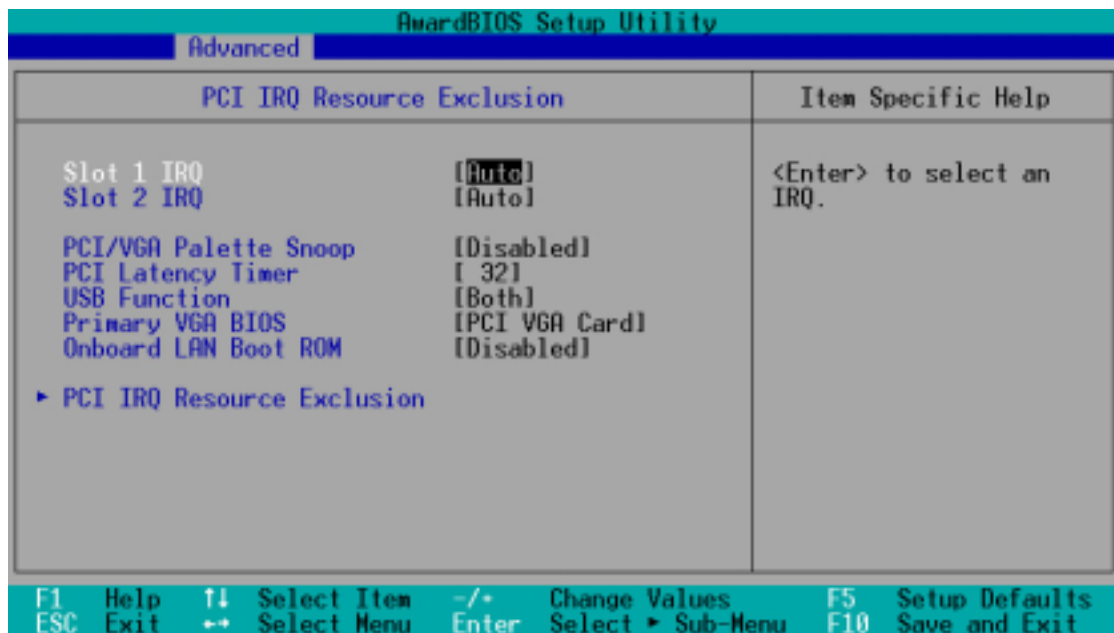

Slot 1 IRQ, Slot 2 IRQ [Auto]

These fields automatically assign the IRQ for each PCI slot. The default setting for each field is [Auto], which utilizes auto-routing to determine IRQ assignments. Configuration options: [Auto] [NA] [3] [4] [5] [7] [9] [10] [11] [12] [14] [15]

PCI/VGA Palette Snoop [Disabled]

Some non-standard VGA cards, like graphics accelerators or MPEG video cards, may not show colors properly. Setting this field to [Enabled] corrects this problem. If you are using standard VGA cards, leave this field to the default setting [Disabled]. Configuration options: [Disabled] [Enabled]

PCI Latency Timer [32]

Leave this field to the default setting [32] for best performance and stability.

USB Function [Both]

This motherboard supports Universal Serial Bus (USB) devices. Set this field to [Primary] or [Both] if you want to connect USB devices. Configuration options: [Disabled] [Primary] [Both]

Primary VGA BIOS [PCI VGA Card]

This field allows you to select the primary graphics card. Configuration options: [PCI VGA Card] [AGP VGA Card]

Onboard LAN Boot ROM [Disabled]

This parameter allows you to enable or disable the boot ROM on the onboard LAN chipset. Set this field to [Enabled] if you wish to use the onboard LAN boot ROM. Configuration options: [Disabled] [Enabled]

4.4.3.1 PCI IRQ Resource Exclusion

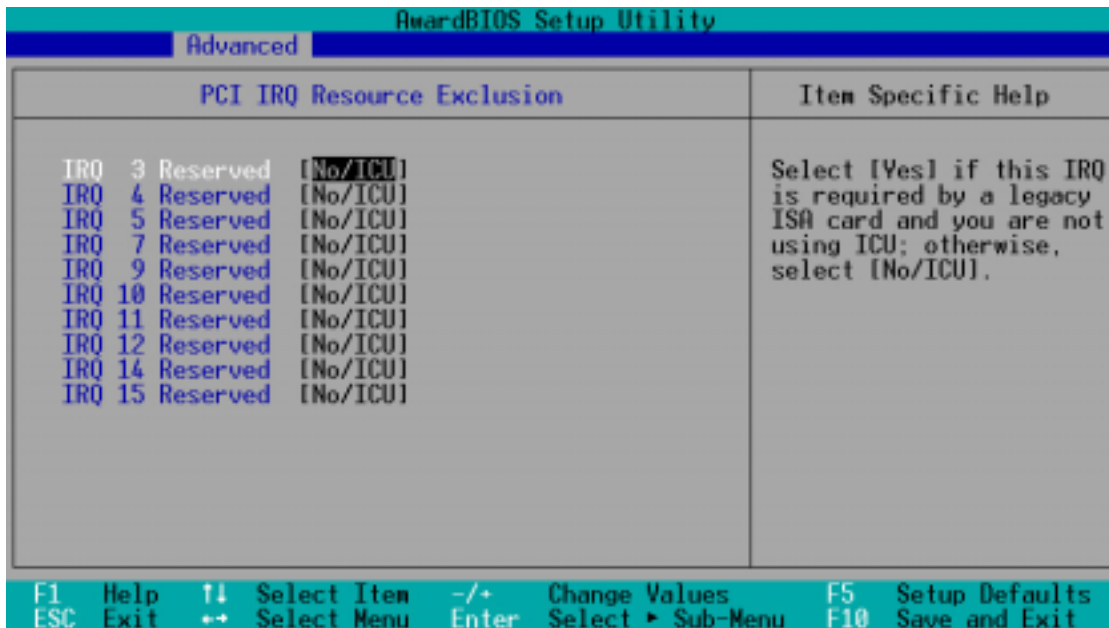

IRQ XX Reserved [No/ICU]

These fields indicate whether or not the displayed IRQ for each field is being used by a legacy (non-PnP) ISA card. The setting [No/ICU] for an IRQ field indicates that you are using the ISA Configuration Utility (ICU), and that this particular IRQ is NOT required by a legacy ISA card. Set the IRQ field to [Yes] if you install a legacy ISA card that requires a unique IRQ and you are NOT using ICU. Configuration options: [No/ICU] [Yes]

4.5 Power Menu

The Power menu allows you to reduce power consumption. This feature turns off the video display and shuts down the hard disk after a period of inactivity.

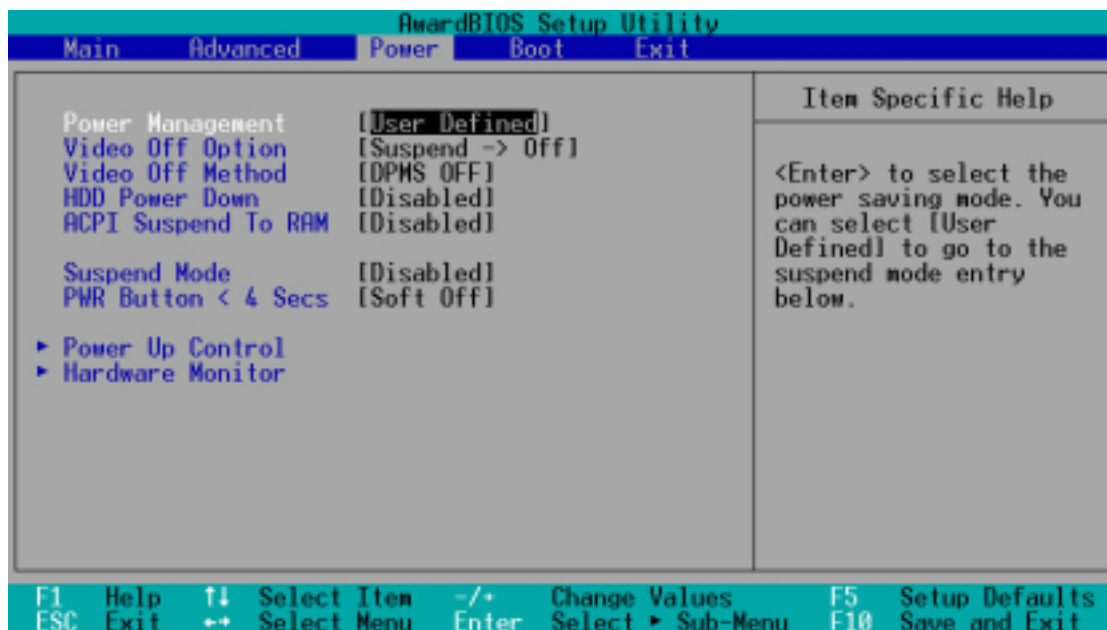

Power Management [User Defined]

This field allows you to activate or deactivate the automatic power saving features. When set to [Disabled], the power management features do not function regardless of the other settings on this menu. The [User Defined] option allows you to set the period of inactivity before the system enters suspend mode. Refer to “Suspend Mode” later in this section.

When set to [Max Saving], system power is conserved to its greatest amount. This setting automatically puts the system into suspend mode after a brief period of system inactivity. [Min Saving] allows the least power saving as the system enters suspend mode only after a long period of inactivity. Configuration options: [User Defined] [Disabled] [Min Saving] [Max Saving]



You should install the Advanced Power Management (APM) utility to keep the system time updated even when the computer enters suspend mode. In Windows 3.x and Windows 95, you need to install Windows with the APM feature. In Windows 98 or later, APM is automatically installed as indicated by a battery and power cord icon labeled “Power Management” in the Control Panel. Select the item “Advanced” in the Power Management Properties dialog box.

Video Off Option [Suspend -> Off]

This field determines when to activate the video off feature for monitor power management. Configuration options: [Always On] [Suspend -> Off]

Video Off Method [DPMS OFF]

This field defines the video off features. The Display Power Management System (DPMS) feature allows the BIOS to control the video display card if it supports the DPMS feature. [Blank Screen] only blanks the screen. Use this for monitors without power management or “green” features.



Even if installed, your screen saver does not display when you select [Blank Screen] for the above field.

[V/H SYNC+Blank] blanks the screen and turns off vertical and horizontal scanning. Configuration options: [Blank Screen] [V/H SYNC+Blank] [DPMS Standby] [DPMS Suspend] [DPMS OFF] [DPMS Reduce ON]

HDD Power Down [Disabled]

Shuts down any IDE hard disk drives in the system after a period of inactivity as set in this user-configurable field. This feature does not affect SCSI hard drives. Configuration options: [Disabled] [1 Min] [2 Min] [3 Min]...[15 Min]

ACPI Suspend To RAM [Disabled]

This field allows you to enable or disable the ACPI Suspend-to-RAM feature. To support this feature, the +5VSB of the power supply should have the capacity to provide more than 720mA current. Configuration options: [Disabled] [Enabled]

Suspend Mode [Disabled]

Sets the time period before the system goes into suspend mode. Configuration options: [Disabled] [1~2 Min] [2~3 Min] [4~5 min] [8~9 Min] [20 Min] [30 Min]

PWR Button < 4 Secs [Soft Off]

When set to [Soft off], the ATX switch can be used as a normal system power-off button when pressed for less than 4 seconds. [Suspend] allows the button to have a dual function where pressing less than 4 seconds puts the system in sleep mode. Regardless of the setting, holding the ATX switch for more than 4 seconds powers off the system. Configuration options: [Soft off] [Suspend]

4.5.1 Power Up Control

AwardBIOS Setup Utility	
Power	
Power Up Control	Item Specific Help
AC Power Loss Restart [Disabled]	<Enter> to select whether or not to restart the system after AC power loss.
Wake/Power Up On Ext. Modem [Disabled]	
Power Up On PCI Card [Disabled]	
Power On By PS/2 Keyboard [Space Bar]	
Power On By PS/2 Mouse [Disabled]	
Automatic Power Up [Disabled]	

F1 Help ↑ Select Item -/+ Change Values F5 Setup Defaults
ESC Exit ↔ Select Menu Enter Select ► Sub-Menu F10 Save and Exit

AC PWR Loss Restart [Disabled]

This allows you to set whether or not to reboot the system after power interruptions. [Disabled] leaves your system off while [Enabled] reboots the system. [Previous State] sets the system back to the state it was before the power interruption. Configuration options: [Disabled] [Enabled] [Previous State]

Wake/Power Up On Ext. Modem [Disabled]

This allows either settings of [Enabled] or [Disabled] for powering up the computer when the external modem receives a call while the computer is in Soft-off mode. Configuration options: [Disabled] [Enabled]



The computer cannot receive or transmit data until the computer and applications are fully running. Thus, connection cannot be made on the first try. Turning an external modem off and then back on while the computer is off causes an initialization string that turns the system power on.

Power Up On PCI Card [Disabled]

When set to [Enabled], this parameter allows you to turn on the system through a PCI modem. This feature requires an ATX power supply that provides at least 1A on the +5VSB lead. Configuration options: [Disabled] [Enabled]

Power On By PS/2 Keyboard [Space Bar]

This parameter allows you to use specific keys on the keyboard to turn on the system. This feature requires an ATX power supply that provides at least 1A on the +5VSB lead. Configuration options: [Disabled] [Space Bar] [Ctrl-Esc] [Power Key]

Power On By PS/2 Mouse [Disabled]

When set to [Enabled], this parameter allows you to use the PS/2 mouse to turn on the system. This feature requires an ATX power supply that provides at least 1A on the +5VSB lead. Configuration options: [Disabled] [Enabled]

Automatic Power Up [Disabled]

This allows an unattended or automatic system power up. You may configure your system to power up at a certain time of the day by selecting [Everyday] or at a certain time and day by selecting [By Date]. Configuration options: [Disabled] [Everyday] [By Date]

4.5.2 Hardware Monitor

AwardBIOS Setup Utility	
Power	
Hardware Monitor	Item Specific Help
MB Temperature	30°C/86°F
CPU Temperature	41°C/105.5°F
CPU Fan Speed	7500RPM
System Fan Speed	5335RPM
VCORE Voltage	1.52V
+3.3V Voltage	3.33V
+5V Voltage	5.00V
+12V Voltage	12.00V

<Enter> to switch between monitoring or ignoring.

F1 Help ↑↓ Select Item -/+ Change Values F5 Setup Defaults
ESC Exit ↔ Select Menu Enter Select ▶ Sub-Menu F10 Save and Exit

MB Temperature [xxxC/xxxF]

CPU Temperature [xxxC/xxxF]

The onboard hardware monitor automatically detects the MB (motherboard) and CPU temperatures.

CPU Fan Speed [xxxxRPM] or N/A

System Fan Speed [xxxxRPM] or N/A

The onboard hardware monitor automatically detects the CPU and system speeds in rotations per minute (RPM). If any of the fans is not connected to the fan connectors on the motherboard, the specific field will show N/A.

VCORE Voltage, +3.3V Voltage, +5V Voltage, +12V Voltage

The onboard hardware monitor automatically detects the voltage output through the onboard voltage regulators and show the values on these fields.



If any of the monitored items is out of range, the following error message appears: "Hardware Monitor found an error. Enter Power setup menu for details". You will then be prompted to "Press F1 to continue or DEL to enter SETUP".

4.6 Boot Menu

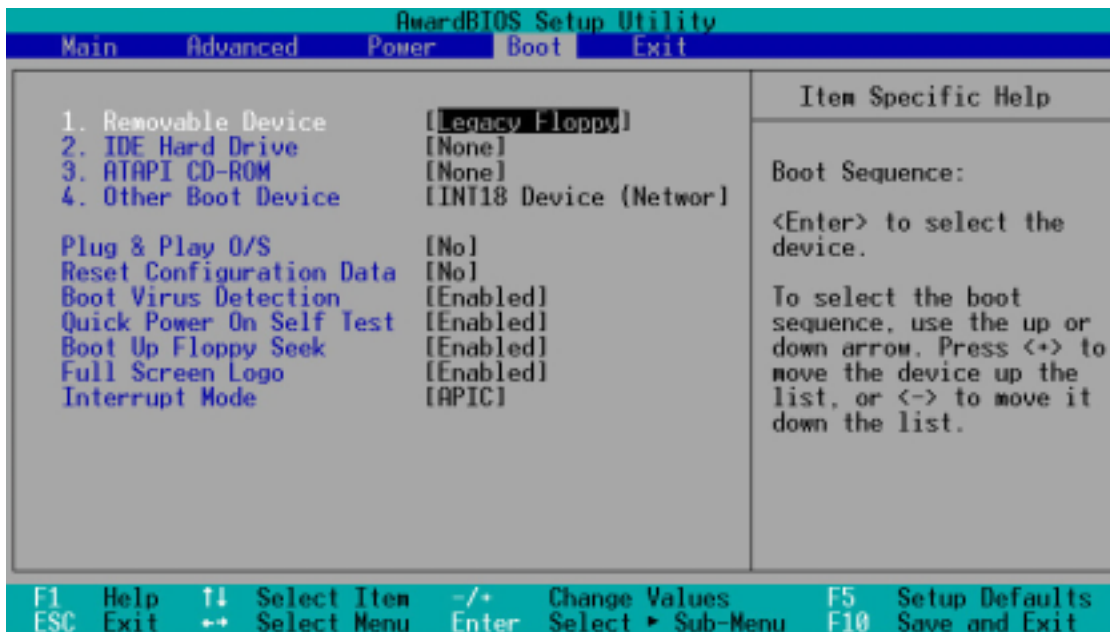

Boot Sequence

The Boot menu allows you to select among the four possible types of boot devices listed using the up and down arrow keys. By using the <+> or <Space> key, you can promote devices and by using the <-> key, you can demote devices. Promotion or demotion of devices alters the priority which the system uses to search for a boot device on system power up. Configuration fields include Removable Devices, IDE Hard Drive, ATAPI CD-ROM, and Other Boot Device.

Removable Device [Legacy Floppy]

Configuration options: [Disabled] [Legacy Floppy] [LS-120] [ZIP] [ATAPI MO]

IDE Hard Drive

This field allows you to select which IDE hard disk drive to use in the boot sequence. Pressing [Enter] will show the product IDs of all connected IDE hard disk drives.

ATAPI CD-ROM

This field allows you to select which ATAPI CD-ROM drive to use in the boot sequence. Pressing [Enter] will show the product IDs of all your connected ATAPI CD-ROM drives.

Other Boot Device Select [INT18 Device (Network)]

Configuration options: [Disabled] [SCSI Boot Device] [INT18 Device (Network)]

Plug & Play O/S [No]

This field allows you to use a Plug-and-Play (PnP) operating system to configure the PCI bus slots instead of using the BIOS. When [Yes] is selected, interrupts may be reassigned by the OS. If you installed a non-PnP OS or if you want to prevent reassigning of interrupt settings, keep the default setting [No]. Configuration options: [No] [Yes]

Reset Configuration Data [No]

The Extended System Configuration Data (ESCD) contain information about non-PnP devices. It also holds the complete record of how the system was configured the last time it was booted. Select [Yes] if you want to clear these data during the Power-On-Self-Test (POST). Configuration options: [Disabled] [Enabled]

Boot Virus Detection [Enabled]

This field allows you to set boot virus detection, ensuring a virus-free boot sector. The system halts and displays a warning message when it detects a virus. If this occurs, you can either allow the operation to continue or use a virus-free bootable floppy disk to restart and investigate your system. Configuration options: [Disabled] [Enabled]

Quick Power On Self Test [Enabled]

This field speeds up the Power-On-Self Test (POST) routine by skipping retesting a second, third, and fourth time. Configuration options: [Disabled] [Enabled]

Boot Up Floppy Seek [Enabled]

When enabled, the BIOS will seek the floppy disk drive to determine whether the drive has 40 or 80 tracks. Configuration options: [Disabled] [Enabled]

Full Screen Logo [Enabled]

This allows you to enable or disable the full screen logo display feature. Configuration options: [Disabled] [Enabled]

Interrupt Mode [APIC]

The Advanced Programmable Interrupt Controller (APIC) setting allows you to distribute interrupt routings other than the 16 IRQs. The Programmable Interrupt Controller (PIC) setting allows you to use the 16 IRQs only. Configuration options: [PIC] [APIC]

4.7 Exit Menu

When you have made all of your selections from the various menus in the Setup program, save your changes and exit Setup. Select Exit from the menu bar to display the following menu.

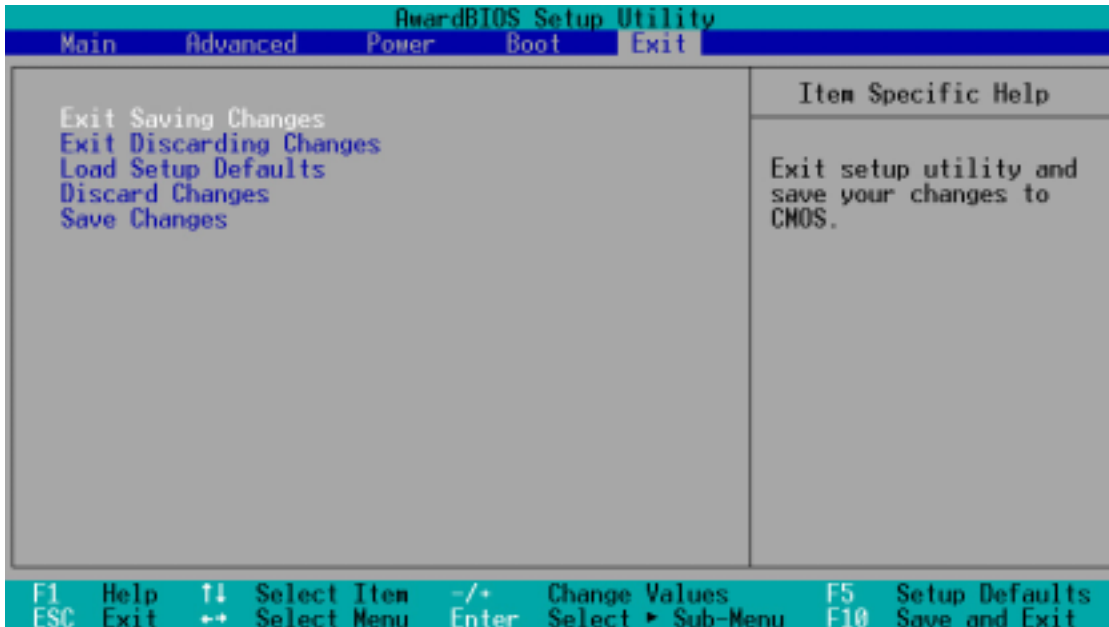

Pressing <Esc> does not immediately exit this menu. Select one of the options from this menu or <F10> from the legend bar to exit.

Exit Saving Changes

Once you are finished making your selections, choose this option from the Exit menu to ensure the values you selected are saved to the CMOS RAM. The CMOS RAM is sustained by an onboard backup battery and stays on even when the PC is turned off. When you select this option, a confirmation window appears. Select [Yes] to save changes and exit.



If you attempt to exit the Setup program without saving your changes, the program prompts you with a message asking if you want to save your changes before exiting. Pressing <Enter> saves the changes while exiting.

Exit Discarding Changes

Select this option only if you do not want to save the changes that you made to the Setup program. If you made changes to fields other than system date, system time, and password, the BIOS asks for a confirmation before exiting.

Load Setup Defaults

This option allows you to load the default values for each of the parameters on the Setup menus. When you select this option or if you press <F5>, a confirmation window appears. Select [Yes] to load default values. Select Exit Saving Changes or make other changes before saving the values to the non-volatile RAM.

Discard Changes

This option allows you to discard the selections you made and restore the previously saved values. After selecting this option, a confirmation appears. Select [Yes] to discard any changes and load the previously saved values.

Save Changes

This option saves your selections without exiting the Setup program. You can then return to other menus and make further changes. After you select this option, a confirmation window appears. Select [Yes] to save any changes to the non-volatile RAM.

Chapter 5

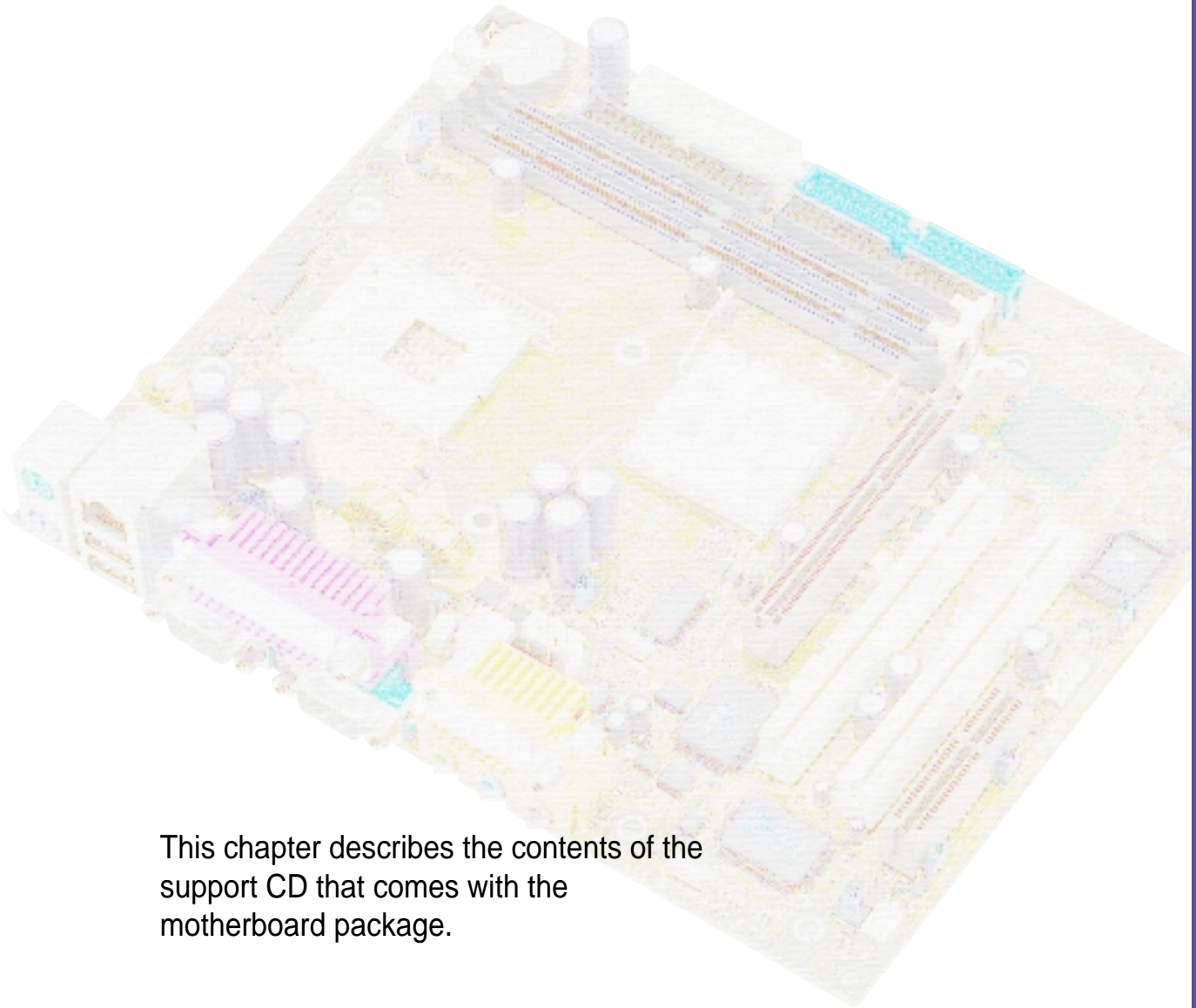

This chapter describes the contents of the support CD that comes with the motherboard package.

Software support

5.1 Install an operating system

This motherboard supports Windows 98/ME/NT/2000/XP and OS/2 operating system (OS). Always install the latest OS version and corresponding updates so you can maximize the features of your hardware.

5.1.1 Windows 98 first time installation

When you start Windows for the first time after installing the motherboard, Windows 98 detects all Plug-n-Play devices. Follow the **Add New Hardware** wizard to install the necessary device drivers. When prompted to restart, select **No**. Refer to the following sections in this chapter to install the software and drivers contained in the support CD.



Because motherboard settings and hardware options vary, use the setup procedures presented in this chapter for general reference only. Refer to your OS documentation for more information.

5.2 Support CD information

The support CD that came with the motherboard contains useful software and several utility drivers that enhance the motherboard features.



The contents of the support CD are subject to change at any time without notice. Visit the ASUS website for updates.

5.2.1 Running the support CD

To begin using the support CD, simply insert the CD into your CD-ROM drive. The CD automatically displays the welcome screen and the installation menus if Autorun is enabled in your computer.



If the welcome screen did not appear automatically, locate and double-click on the file ASSETUP.EXE from the BIN folder in the support CD to display the menus.

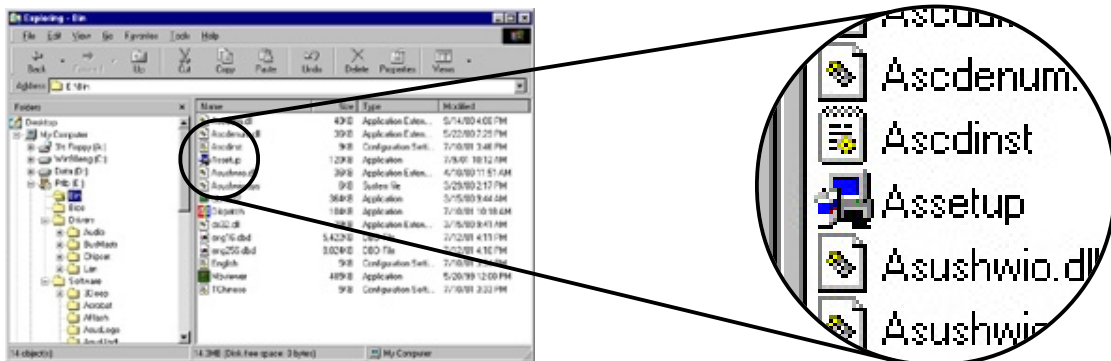

5.2.2 Main menu

From the welcome screen, the program takes you directly to the main menu. The main menu displays an image of the motherboard, and the buttons and icons that link you to the software, drivers, utilities, and other information contained in the support CD.



Place your mouse cursor on an icon and click to display the specified item

Click on a button to display the available options

5.2.3 Software menu

The software menu shows the applications and other software that the motherboard supports. The highlighted items indicate that they are available for your motherboard. Simply click on a specific item then follow the installation wizard to install it.

The software menu is composed of two screens. Click on the **Next** button on the lower right corner of the first screen to display the second menu screen. To return to the first menu screen, click on the **Back** button on the lower right corner of the second screen.

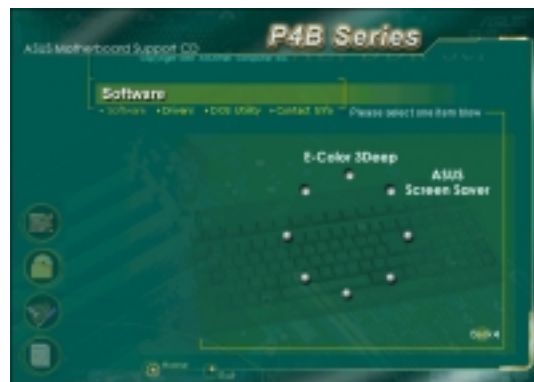

ASUS Update

This program allows you to download the latest version of the BIOS from the ASUS website.



Before using the ASUS Update, make sure that you have an Internet connection so you can connect to the ASUS website.

Intel® LDCM Administrator Setup

This program is for monitoring PC systems on the network within the same bridge as the installed Client software.



The administrator should install both the Administrator and the Client software.

Intel® LDCM Client Setup

This program is for monitoring the Client system. Install the LANDesk Client Manager to use the hardware manager features.

ASUS BIOS Flash Utility

This utility allows you to remotely flash the Client PC's BIOS when used with the Intel LDCM Administrator.

ASUS PC Probe

This smart utility monitors the fan speed, CPU temperature, and system voltages, and alerts you on any detected problems. This utility helps you keep your computer at a healthy operating condition.

Cyberlink Video and Audio Applications

This item installs the Cyberlink PowerPlayer SE 5.0 and Cyberlink VideoLive Mail 4.0.

Direct X

This item installs the Microsoft V8.0a driver.

PC-cillin

This item installs the PC-cillin 2000 V7.0 anti-virus software. View the PC-cillin online help for detailed information.

Acrobat Reader

This item installs the Adobe Acrobat Reader V5.0. The Acrobat Reader software is for viewing files saved in Portable Document Format (PDF).

E-Color 3Deep

This item installs the 3Deep software. 3Deep is the first application that gives online gamers the competitive edge in multi-player skirmishes. This application eliminates dark washed-out graphics to deliver true vibrant colors.

ASUS Screen Saver

This item installs the ASUS screen saver.

5.2.4 Drivers menu

The drivers menu shows the available device drivers if the system detects installed devices. Install the necessary drivers to activate the devices.



INF Driver

This item installs the Intel® Chipset Software Installation Utility that enables Plug-n-Play INF support for Intel chipset components. This utility installs to the target system the Windows INF files that outline to the operating system how the chipset components will be configured.

You may install this utility in three modes: interactive, silent, and unattended preload. The interactive mode requires user input during installation. This is not required in the silent and unattended preload modes.

Refer to the online help or readme file that came with the utility.

Intel® Application Accelerator

This item installs the Intel Application Accelerator for Microsoft® Windows® 98/98SE/ME/NT4.0/2000. This program is designed to improve performance of the storage sub-system and overall system performance.



Install the INF Driver before installing the Intel Application Accelerator.

LAN

This item installs the RealTek 8100B PCI Fast Ethernet driver.

Audio

This item installs the AC '97 PCI audio driver.

5.2.5 DOS Utilities menu

The DOS utilities menu includes items that you can run in DOS mode. These items are also present in the software menu.



5.2.6 ASUS Contact Information

Clicking the ASUS Contact Information button displays as stated. You may also find this information on page x of this user guide.

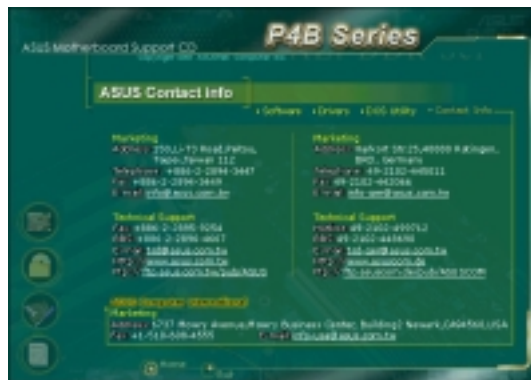

5.2.7 Other information

The icons on the left side of the screen give additional information on the motherboard and the contents of the support CD. This section shows the pop-up windows that appear when you click the icons.



The screens in this section are for reference only and may not exactly reflect the details you see on your screen.

Motherboard Info

The window displays the general specifications of the P4B-FX motherboard.

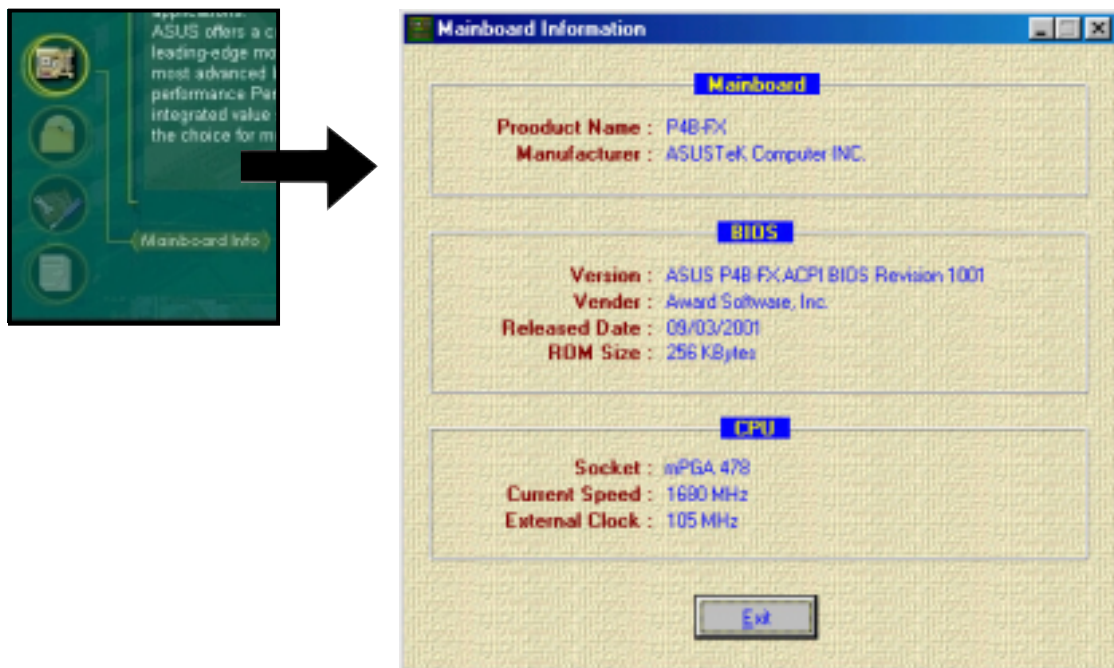

Browse this CD

The window displays the support CD contents in graphical format.

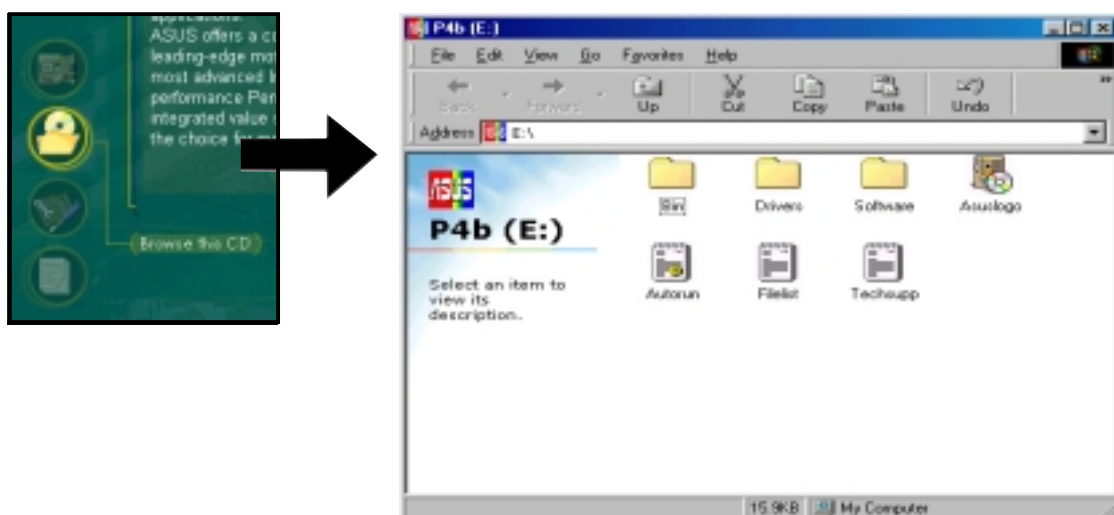

Technical Support Form

The window displays the ASUS Technical Support Request Form that you have to fill up when requesting technical support.

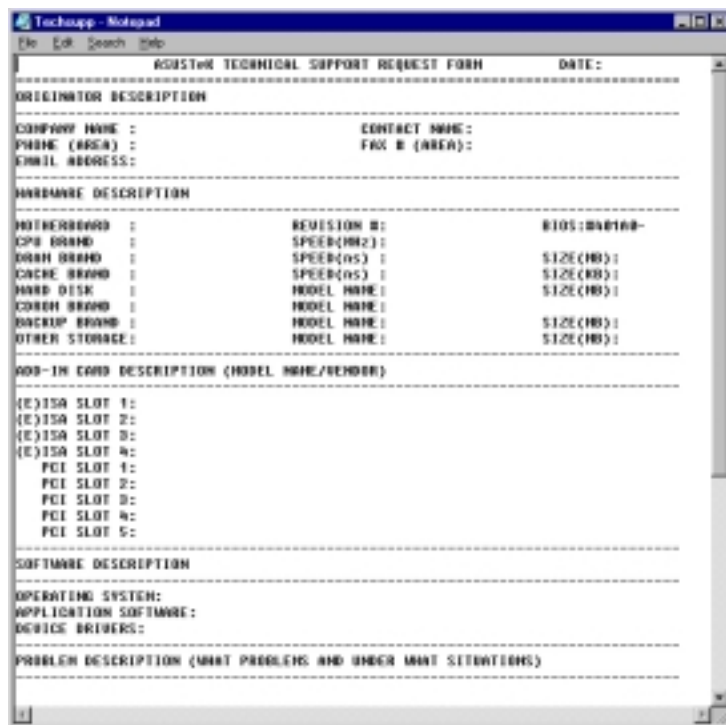
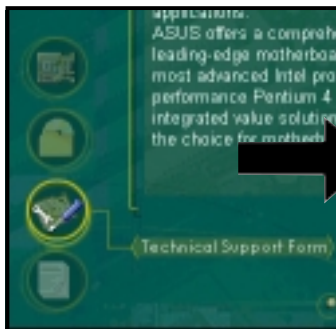

ASUS TECHNICAL SUPPORT REQUEST FORM DATE: _____

ORIGINATOR DESCRIPTION

COMPANY NAME : _____ CONTACT NAME : _____
PHONE (AREA) : _____ FAX # (AREA) : _____
EMAIL ADDRESS : _____

HARDWARE DESCRIPTION

MOTHERBOARD :	REVISION #:	BIOS: (MB) #:
CPU BRAND :	SPEED (MHz) :	
DRAM BRAND :	SPEED (MHz) :	SIZE (MB) :
CACHE BRAND :	SPEED (MHz) :	SIZE (MB) :
HARD DISK :	MODEL NAME :	SIZE (MB) :
CDROM BRAND :	MODEL NAME :	
DVDROM BRAND :	MODEL NAME :	SIZE (MB) :
OTHER STORAGE :	MODEL NAME :	SIZE (MB) :

ADD-IN CARD DESCRIPTION (MODEL NAME/RENDER)

(E)ISA SLOT 1: _____
(E)ISA SLOT 2: _____
(E)ISA SLOT 3: _____
(E)ISA SLOT 4: _____
PCI SLOT 1: _____
PCI SLOT 2: _____
PCI SLOT 3: _____
PCI SLOT 4: _____
PCI SLOT 5: _____

SOFTWARE DESCRIPTION

OPERATING SYSTEM: _____
APPLICATION SOFTWARE: _____
DEVICE DRIVERS: _____

PROBLEM DESCRIPTION (WHAT PROBLEMS AND UNDER WHAT SITUATIONS)

Readme

The window displays the contents of the support CD and a brief description of each in text format.

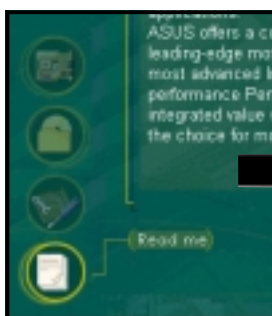

File list for the included support software for P4B series motherboard

File Name	Description
---Drivers	
-BD1	-SoundBlaster Integrated Digital Audio Driver
-M1A	-M1A11 SoundBlaster Windows NT 4.0 Driver 05.02.00.000a.
-M1B	-M1B11 SoundBlaster M1B Driver 05.12.01.0007.
-M1C00	-SoundBlaster AC'97 Drivers and Applications 04.55
-Linux	-Audio Driver For Linux.
-Windows	-Audio Drivers for Windows OS.
-AP	-Applications
-Win2000	-Audio Driver for Windows 2000 05.10.00.0040.
-WinXP	-Windows XP SE WH Driver 05.10.00.0550.
-Win9x	-Windows 95/98 SxD Driver 04.05.00.0000 and Modifiable Driver 02.1.0.0.
-Win9x	-Windows 98 WH Driver 05.10.00.0000.
-Win9x	-Windows NT 4.0 Audio Driver 05.02.00.0000 and Modifiable Driver 04.02.00.0001.
-C-Media	-C-Media CMI320/PCI-55 Audio Chip Driver 02.60
-Dedrw	-Audio Driver For Dell.
-Linux	-Audio Driver For Linux.
-Manual	-Audio Manual.
-M1A	-Windows NT 4.0 Audio Drivers 04.01.0020.
-M1B-HE	-Windows 2000/ME Audio Driver 05.02.00.0020.
-M1B-98	-Windows 95/98 Audio SxD Drivers 04.05.1005d.
---BusMaster	
-M1B51	-Bus Master IDE Driver 01.70 For WinNT3.51.
-Ultra166	-Intel Ultra 166 Storage Driver 05.10.011 For Windows 95/98/ME/NT40/2000.
---Chipset	
-Inf	-Intel(R) Chipset Software Installation Utility 05.50.1011.
---LAN	
-Intel	-Intel(R) PRO/100 BE Network Connection.
-R1120P	-Realtek RTL8129C PCI Fast Ethernet NIC Driver 05.276.0020.2000
-M1A2000	-Realtek RTL8129C PCI Fast Ethernet NIC Windows 2000 Driver.
-M1A98	-Realtek RTL8129C PCI Fast Ethernet NIC Windows 95 Driver.
-M1A98	-Realtek RTL8129C PCI Fast Ethernet NIC Windows 98 Driver.
-M1A98	-Realtek RTL8129C PCI Fast Ethernet NIC Windows ME Driver.

5.3 Software information

Most of the applications in the support CD have wizards that will conveniently guide you through the installation. View the online help or readme file that came with the software for more information.

This section provides details on the new software applications that the motherboard supports.

5.3.1 ASUS Update

The ASUS Update is a utility that allows you to update the motherboard BIOS and drivers. This utility requires an Internet connection either through a network or an Internet Service Provider (ISP).

Follow these steps to use the ASUS Update.

1. Launch the utility from your Windows Start menu:

**Programs/AsusUpdate Vx.xx.xx/
AsusUpdate**

The ASUS Update initial screen appears.

2. Select your desired update method, then click Next.



3. If you selected updating/downloading from the Internet, select the ASUS FTP site nearest you to avoid network traffic, or choose Auto Select. Click Next.



4. From the FTP site, select the BIOS version that you wish to download. Click Next.
5. Follow the instructions on the succeeding screens to complete the update process.



If you selected the option to update the BIOS from a file, a window pops up prompting you to locate the file. Select the file, click Save, then follow the screen instructions to complete the update process.

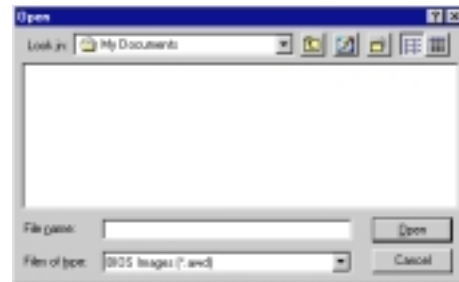

Glossary

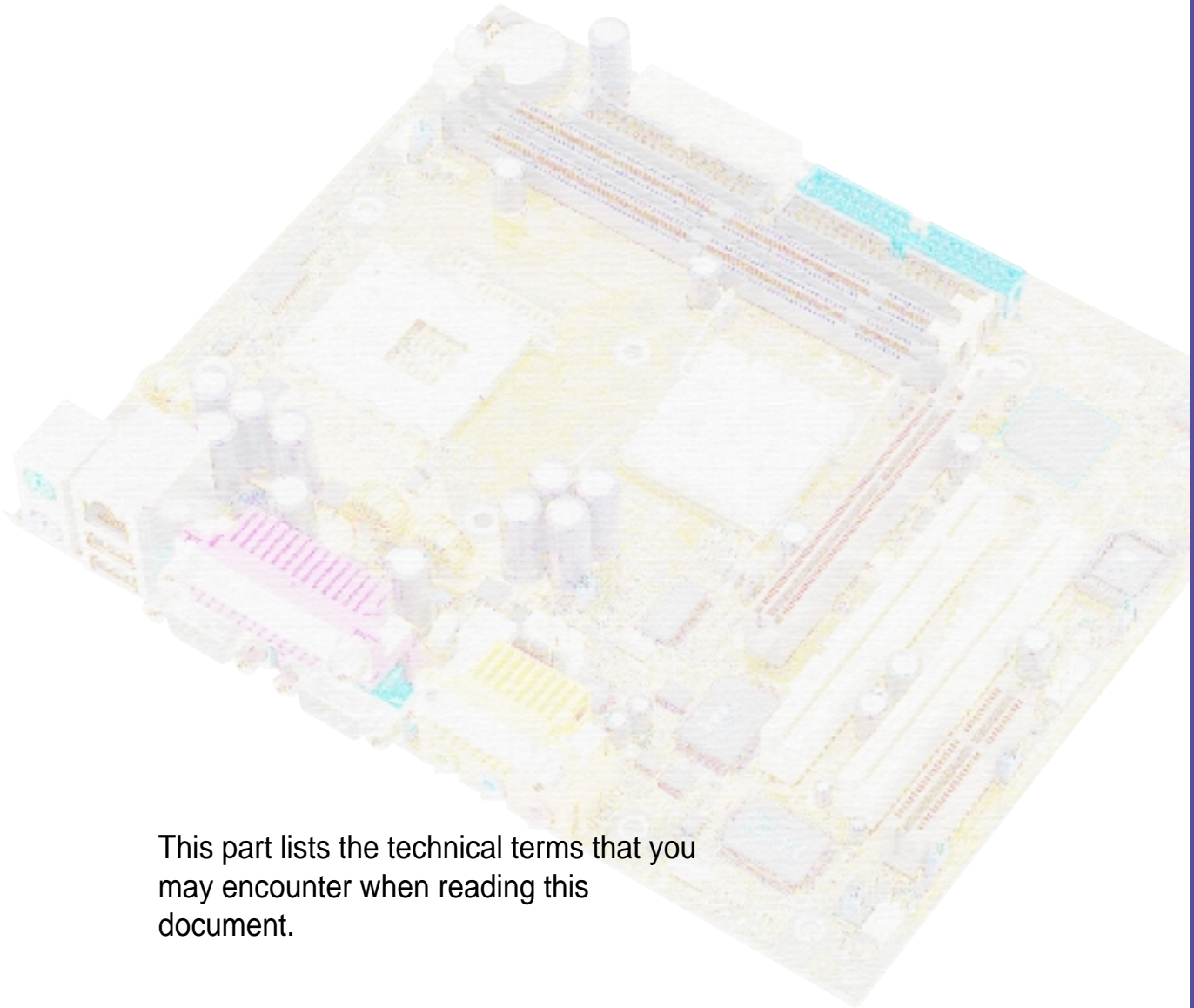

This part lists the technical terms that you may encounter when reading this document.



This glossary also includes some terms that are not found in this document but might be of help to you when operating, upgrading, or reconfiguring your computer.

AC'97 (Audio Codec '97). AC '97 is the next step in enabling PCs with audio quality comparable to consumer electronics devices. The specification defines new cost-effective options to help integrate the components necessary to support next-generation auto-intensive PC applications such as DVD, 3-D multiplayer gaming and interactive music. The specification also defines new extensions supporting modem and docking to help both desktop and mobile manufacturers adopt these new technologies more quickly and cost-effectively. This specification uses software emulation to compete with the PCI SoundBlaster specification.

ACPI (Advanced Configuration and Power Interface). The ACPI specification defines a cross-platform interface designed to support many operating systems. ACPI defines a flexible and abstract hardware interface that provides a standard way to integrate power management features in a PC system, including hardware, operating system and application software. This enables the system to automatically turn ON and OFF peripherals such as CD-ROMs, network cards, hard disk drives, and printers, as well as consumer devices connected to the PC such as VCRs, TVs, phones, and stereos. With this technology, peripherals are also able to activate the PC. For example, inserting a tape into a VCR can turn on the PC, which could then activate a large-screen TV and high-fidelity sound system.

AGP (Accelerated Graphics Port). An interface specification that enables high-performance 3D graphics on mainstream PCs. AGP was designed to offer the necessary bandwidth and latency to perform texture mapping directly from system memory.

Bus	Bus Frequency	Bandwidth	Data Transfer Rate
PCI	33MHz	33MHz	133MByte/sec
AGP 1X	66MHz	66MHz	266MByte/sec
AGP 2X	66MHz	133MHz	512MByte/sec
AGP 4X	66MHz	266MHz	1024MByte/sec

Backup. A copy of a file, directory, or volume on a separate storage device from the original. This copy is for the purpose of data retrieval in case the original is accidentally erased, damaged, or destroyed.

BIOS (Basic Input/Output System). BIOS is a set of routines that control how the computer transfers data between computer components, such as memory, disks, and the display adapter. The BIOS instructions are built into the computer's read-only memory. BIOS parameters are configurable through the BIOS Setup program. You can update the BIOS using the AFLASH utility by copying a new BIOS file into the EEPROM.

Bit (Binary Digit). Represents the smallest unit of data used by the computer. A bit can have one of two values: 0 or 1.

Boot. Boot means to start the computer operating system by loading it into system memory. When the manual instructs you to "boot" your system (or computer), it means to turn ON your computer. "Reboot" means to restart your computer. When using Windows 95 or later, selecting "Restart" from "Start | Shut Down..." will reboot your computer.

Bus Master IDE. PIO (Programmable I/O) IDE requires that the CPU be involved in IDE access and waiting for mechanical events. Bus master IDE transfers data to/from the memory without interrupting the CPU. Bus master IDE driver and bus master IDE hard disk drives are required to support bus master IDE mode.

Byte (Binary Term). One byte is a group of eight contiguous bits. A byte is used to represent a single alphanumeric character, punctuation mark, or other symbol.

Cache Memory. A type of RAM that allows a faster from the CPU than a regular RAM. The cache memory eliminates the CPU wait state. When the CPU reads data from the main memory, a copy of this data is stored in the cache memory. The next time the same address, the data is transferred from the cache memory instead of from the main memory.

CODEC (Compressor/Decompressor). A software component that translates video or audio between its uncompressed form and the compressed form in which it is stored.

COM Port. A connector with the accompanying circuitry that supports serial devices such as printers, mice, modems, and infrared modules. Each COM port is configured to use a different IRQ and address assignment. COM port is short for communication port, and is also called a serial port.

CPU (Central Processing Unit). The CPU, also called "Processor," actually functions as the "brain" of the computer. It interprets and executes program commands and processes data stored in the system memory.

Device Driver. A software routine that links a peripheral device to the operating system. It acts as a translator between the device and the applications that use it. Each device has its own set of specialized commands known only to its driver while the applications access devices using high-level generic commands. The driver translates these commands into the commands required by the devices.

DOS (Disk Operating System). A software that organizes how a computer reads, writes, and communicate to the disks and various input/output devices (such as keyboards, screens, serial and parallel ports, printers, modems, etc.) connected to it. DOS was the most popular PC operating system until the introduction of Windows.

DRAM (Dynamic Random Access Memory). A type of RAM that requires refresh cycles to prevent the loss of the data stored in it. See also RAM and SDRAM.

Expansion Card. A printed circuit card such as an audio card, a video card, or a LAN card that plugs into an expansion slot on the motherboard. An expansion card add functions that are not present in the motherboard.

Flash ROM. A non-volatile memory device that retains its data even when power is removed. This device is similar to EPROM, but unlike EPROM which can be erased only using an ultra-violet light, flash ROM can be electrically erased. Flash ROM is normally used for system BIOS, which initiates hardware devices and sets up necessary parameters for the OS. Since the flash ROM contents can be modified, you can update the BIOS by yourself.

IDE (Integrated Drive Electronics). IDE devices integrate the drive control circuitry directly on the drive itself, eliminating the need for a separate adapter card (in the case for SCSI devices). UltraDMA/100/6633 IDE devices can achieve up to 100MB/sec transfers.

Internet. The global computer network composed of WANs and LANs that uses TCP/IP to provide worldwide communications to homes, schools, businesses, and the government.

I/O (Input/Output). The data transfers from the input devices like a keyboard, mouse, or scanner, to the output devices like a printer or the monitor screen.

I/O Address. The specific memory location for a particular device. Two devices cannot share the same I/O address space.

IrDA (Infrared Data Association). An international organization that creates and promotes inter-operable, low cost, infrared data interconnection standards that support a walk-up, point-to-point model. The IrDA protocol is designed to support transmission of data between two devices over short-range point-to-point infrared at speeds between 9.6Kbps and 4Mbps.

ISP (Internet Service Provider). A company that provides customer access to the Internet and the World Wide Web for a fee. The ISP also provides Internet utilities and services like e-mail, newsgroup, weather reports, and a host of others. The user can connect to the ISP using a modem installed in the computer and connected to a phone line.

LAN (Local Area Network). A network technology designed to connect computers that are separated by a short distance. The local group of linked computers are normally connected to a single server. See also WAN (Wide Area Network)

Modem. A device that allows a computer to talk to another computer through the phone system.

Network. An interconnected computer system linked by telephone wires, or other means.

OS (Operating System). The software that controls the overall operation of a computer system. The OS tasks include memory allocation, input and output distribution, interrupt processing, job scheduling, and various other duties.

PC100/PC133. This is an industry-standard designation for memory capacity as a measure of the speed of the memory bus. New platform requirements ensure that memory does not become a bottleneck to system performance.

PCI Bus (Peripheral Component Interconnect Local Bus). PCI bus is a specification that defines a 32-bit data bus interface. PCI is a standard widely used by expansion card manufacturers.

PCI Bus Master. The PCI Bus Master can perform data transfer without local CPU help and furthermore, the CPU can be treated as one of the Bus Masters. PCI 2.1 supports concurrent PCI operation to allow the local CPU and bus master to work simultaneously.

POST (Power On Self Test). When you turn ON the computer, it will first run through the POST, a series of software-controlled diagnostic tests. The POST checks system memory, the motherboard circuitry, the display, the keyboard, the diskette drive, and other I/O devices.

PS/2 Port. PS/2 ports are based on IBM Micro Channel Architecture. This type of architecture transfers data through a 16-bit or 32-bit bus. A PS/2 mouse and/or keyboard may be used on ATX motherboards.

RAM (Random Access Memory). The computer's primary storage area used to write, store, and retrieve information and program instructions which are passed to the CPU for processing. The information in RAM can be repeatedly re-written with new data. Compared to other storage media like magnetic tape, floppy disk, and hard disk, RAM has an extraordinarily fast access rate. RAM, however, is volatile, which means that the data stored in it are lost when the system power is turned off, or if power glitches occur. See also DRAM and SDRAM.

ROM (Read Only Memory). An integrated circuit chip containing program and data that can be accessed and read but not modified.

SCSI (Small Computer System Interface). High speed multi-threaded I/O interface defined by the X3T9.2 committee of the American National Standards Institute (ANSI) for connecting many peripheral devices. The standard covers 10MBytes/sec to 160MBytes/sec data rates.

SDRAM (Synchronous DRAM). A type of DRAM with access signals that are synchronized with the CPU clock, eliminating the delay associated with data transfers between the CPU and memory. SDRAM takes memory access away from the CPU control; internal registers in the memory accept the request, and lets the CPU do something else while the data requested is assembled for the next time the CPU talks to the memory.

SIR (Serial IrDA). A SIR specification defines a short-range infrared asynchronous serial transmission mode with one start bit, eight data bits and one stop bit. The maximum data rate is 115.2Kbps.

SPD for SDRAM module. Serial Presence Detect (SPD) is most like an ID detect for SDRAM module, it uses an EEPROM component on a DIMM for storing module configuration information inside. The Serial Presence Detect function is implemented using a 2048 bit EEPROM component. This nonvolatile storage device contains data programmed by the DIMM manufacturer that identifies the module type and various SDRAM organization and timing parameters.

System Disk. A system disk contains the core file of an operating system and is used to boot up the operating system.

TCP/IP (Transmission Control Protocol/Internet Protocol). The communications protocol used by the UNIX system and the Internet. TCP checks for lost packets, puts the data from multiple packets into the correct order, and requests that missing or damaged packets be resent.

USB (Universal Serial Bus). A 4-pin serial cable bus that allows up to 127 Plug-n-Play computer peripherals (such as keyboard, mouse, joystick, scanner, printer, modem, and monitor) to share bandwidth through a host scheduled token-based protocols. This allows attaching or detaching while the host and other peripherals are in operation. Supports synchronous and asynchronous transfer types over the same set of wires up to 12Mbit/sec. USB 2.0 provides 40 times the transfer rate compared to USB 1.0 and competes with the 1394 standard.

WAN (Wide Area Network). A geographically dispersed network formed by linking several computers or Local Area Networks (LANs) together over long distances. WANs usually use leased long-distance lines to connect systems across towns, in different cities, or in different regions of the world.

Index

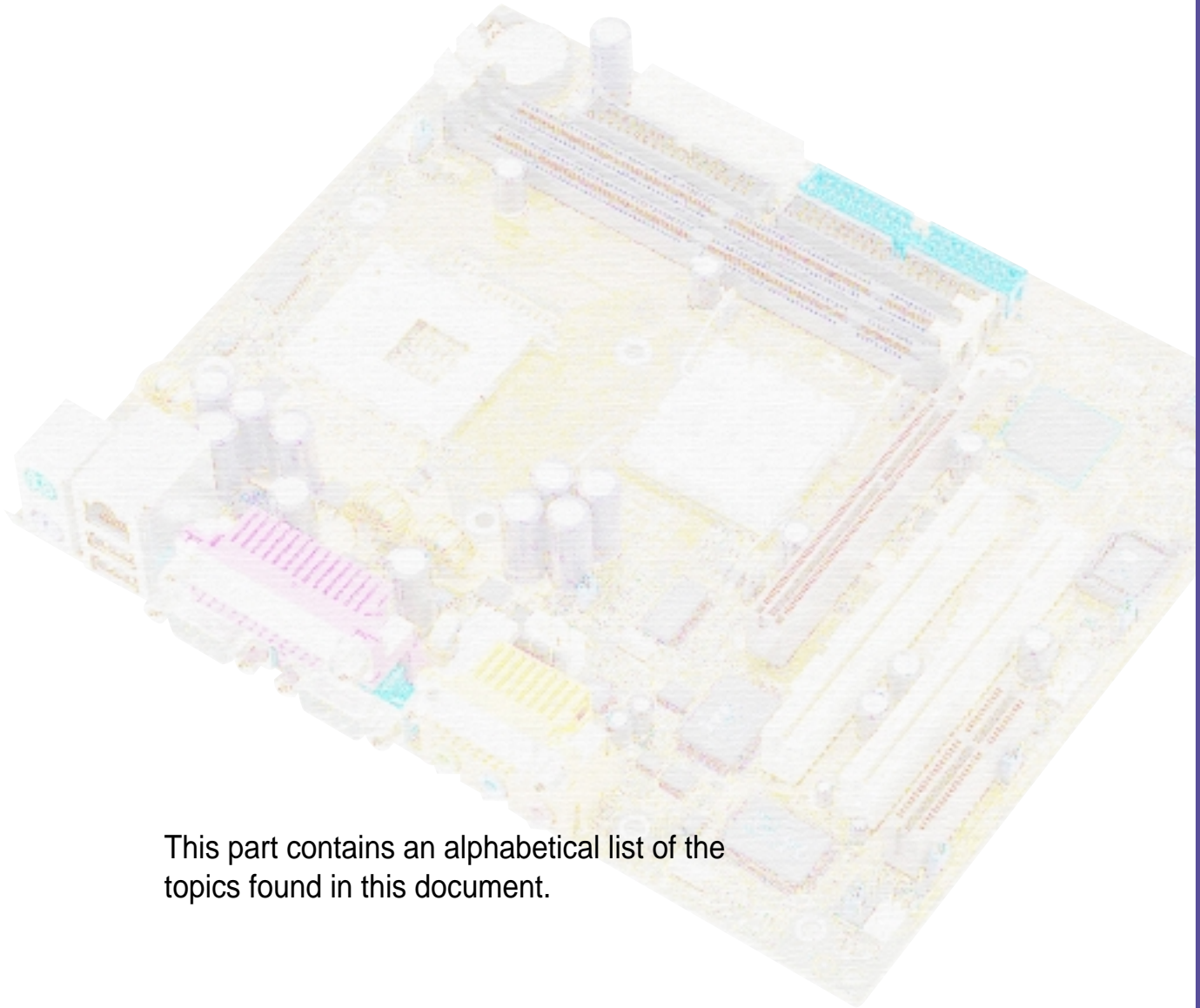

This part contains an alphabetical list of the topics found in this document.

A

Accelerated Graphics Port 2-15
Acrobat Reader 5-4
ASUS PC Probe 5-4
ASUS Update 5-9
ATAPI CD-ROM 4-28
Automatic Power Up 4-27

B

BIOS

Advanced Menu 4-15
Boot Menu 4-28
Boot Sequence 4-28
Exit Menu 4-30
Language 4-14
Legend Bar 4-6
Main Menu 4-8
Menu Bar 4-6
Power Menu 4-23
Setup Defaults, loading 4-31
Setup Program 4-5
Sub-menu launching 4-7
Updating 4-1
BIOS Beep Codes 3-1
BIOS Flash Utility 5-4
Boot Device
 Selection 4-28
Boot Up NumLock Status 4-13
Boot Virus Detection 4-29

C

Central Processing Unit (CPU) 2-4
 CPU socket 1-3
 fan connector 2-9
 installation 2-5
 Level 1/Level 2 Cache 4-15
 Speed 4-15
Chip Configuration 4-17
Clear RTC RAM 2-19
Communications and Networking
 Riser 2-16

Connectors

ATX 12V 1-4
ATX power 1-3
chassis alarm 2-22
fan 2-22
Floppy disk 1-3, 2-22
Game/MIDI 1-5
HDD LED 2-20
IDE 1-3
internal audio 2-25
panel 2-27
power supply 2-24
primary/secondary IDE 2-21
CPU frequency 2-17

D

DIMM

installing 2-11
removing 2-12
DIMM sockets 1-3
DIP switches 1-4, 2-16

E

E-Color 3Deep 5-4
Expansion card
 installation 2-13
 IRQ assignments 2-14
Expansion slots 1-4, 2-13
 AGP 1-4, 2-15
 PCI 1-4, 2-15
 CNR 2-16

F

Floppy 3 Mode 4-8

H

Hard Disk Drives (HDDs)
 CHS Capacity 4-11
 Cylinders 4-11
 Heads 4-11

- LBA Capacity 4-11
- Primary/Secondary Master 4-9
- Primary/Secondary Slave 4-9
- Sectors 4-11
- Types 4-9
- Hardware Monitor 4- 28
- Heatsink
 - installation 2-7
- Heatsink retention module 1-5

I

- Interrupt Assignments 2-14
- IRQ assignments 2-14

J

- Jumpers
 - USB device wake-up 2-17

K

- Keyboard
 - Auto-Repeat Delay 4-13
 - Auto-Repeat Rate 4-13
 - Features 4-13

L

- LAN
 - controller 1-4
- Legacy Diskette 4- 8

M

- Motherboard
 - components 1-2
 - IRQ Table 2-14
 - layout 2-2
 - placement 2-1
 - screws 2-1
- Multi-Sector Transfers 4-11

O

- Onboard LED 2-3

- Operating system
 - installation 5-1

P

- Parallel Port 1-5, 4-20
 - Modes 4-20
- Password
 - Supervisor 4-14
 - User 4-14
- PC-cillin 5-4
- PCI Configuration 4-21
- PCI Latency Timer 4-21
- PCI/VGA Palette Snoop 4-21
- PIO Mode 4-12
- Plug & Play O/S 4-30
- Power Management 4-24
- Power On Self Test 4-30
- Powering off 3-2
- PS/2 Keyboard Port 1-5
- PS/2 Mouse
 - Function Control 4-16
- PS/2 Mouse Port 1-5

R

- Retention Mechanism 2-8
- RJ-45 port 1-5

S

- SDRAM
 - Active to Precharge Delay 4-18
 - CAS Latency 4-17
 - Configuration 4-17
 - RAS Precharge Delay 4-18
 - RAS to CAS Delay 4-17
- Serial Ports 1-5, 4-19
- SMART Monitoring 4-12
- Starting up 3-1
- Support CD 5-1
 - ASUS Update 5-3
 - DOS Utilities 5-6

- Drivers menu 5-5
- Main menu 5-2
- Motherboard information 5-7
- Readme file 5-8
- Software menu 5-3
- Technical Support Form 5-8
- Welcome screen 5-1
- Suspend Mode 4-25
- System Controller
 - North Bridge 1-3
 - South Bridge 1-3
- System Date 4-8
- System memory
 - configurations 2-10
- System Time 4-8

U

- UART2 4-21
- Ultra DMA Mode 4-12
- USB Legacy Support 4-17
- USB ports 1-5
- USWC 4-18

V

- Video Memory 4-19

Z

- ZIF socket 2-4

