



# *P4P800 SE*

User Guide

# Motherboard

**E1886**

**Revised Edition V2  
February 2005**

**Copyright © 2005 ASUSTeK COMPUTER INC. All Rights Reserved.**

No part of this manual, including the products and software described in it, may be reproduced, transmitted, transcribed, stored in a retrieval system, or translated into any language in any form or by any means, except documentation kept by the purchaser for backup purposes, without the express written permission of ASUSTeK COMPUTER INC. ("ASUS").

Product warranty or service will not be extended if: (1) the product is repaired, modified or altered, unless such repair, modification or alteration is authorized in writing by ASUS; or (2) the serial number of the product is defaced or missing.

ASUS PROVIDES THIS MANUAL "AS IS" WITHOUT WARRANTY OF ANY KIND, EITHER EXPRESS OR IMPLIED, INCLUDING BUT NOT LIMITED TO THE IMPLIED WARRANTIES OR CONDITIONS OF MERCHANTABILITY OR FITNESS FOR A PARTICULAR PURPOSE. IN NO EVENT SHALL ASUS, ITS DIRECTORS, OFFICERS, EMPLOYEES OR AGENTS BE LIABLE FOR ANY INDIRECT, SPECIAL, INCIDENTAL, OR CONSEQUENTIAL DAMAGES (INCLUDING DAMAGES FOR LOSS OF PROFITS, LOSS OF BUSINESS, LOSS OF USE OR DATA, INTERRUPTION OF BUSINESS AND THE LIKE), EVEN IF ASUS HAS BEEN ADVISED OF THE POSSIBILITY OF SUCH DAMAGES ARISING FROM ANY DEFECT OR ERROR IN THIS MANUAL OR PRODUCT.

SPECIFICATIONS AND INFORMATION CONTAINED IN THIS MANUAL ARE FURNISHED FOR INFORMATIONAL USE ONLY, AND ARE SUBJECT TO CHANGE AT ANY TIME WITHOUT NOTICE, AND SHOULD NOT BE CONSTRUED AS A COMMITMENT BY ASUS. ASUS ASSUMES NO RESPONSIBILITY OR LIABILITY FOR ANY ERRORS OR INACCURACIES THAT MAY APPEAR IN THIS MANUAL, INCLUDING THE PRODUCTS AND SOFTWARE DESCRIBED IN IT.

Products and corporate names appearing in this manual may or may not be registered trademarks or copyrights of their respective companies, and are used only for identification or explanation and to the owners' benefit, without intent to infringe.

# Contents

Notices .....	vii
Safety information .....	viii
About this guide .....	ix
How this guide is organized .....	ix
Where to find more information .....	ix
Conventions used in this guide .....	x
Typography .....	x
P4P800 SE specifications summary .....	xi

## Chapter 1: Product introduction

1.1 Welcome! .....	1-1
1.2 Package contents .....	1-1
1.3 Special features .....	1-2
1.3.1 Product Highlights .....	1-2
1.3.2 Unique ASUS features .....	1-4

## Chapter 2: Hardware information

2.1 Before you proceed .....	2-1
2.2 Motherboard overview .....	2-2
2.2.1 Placement direction .....	2-2
2.2.2 Screw holes .....	2-2
2.2.3 Motherboard layout .....	2-3
2.2.4 Layout Contents .....	2-4
2.3 Central Processing Unit (CPU) .....	2-6
2.3.1 Overview .....	2-6
2.3.2 Installing the CPU .....	2-7
2.3.3 Installing the heatsink and fan .....	2-9
2.3.4 Connecting the CPU fan cable .....	2-11
2.4 System memory .....	2-12
2.4.1 Overview .....	2-12
2.4.2 Memory configurations .....	2-12
2.4.3 Qualified Vendor List .....	2-14
2.4.4 Installing a DIMM .....	2-15
2.4.5 Removing a DIMM .....	2-15
2.5 Expansion slots .....	2-16
2.5.1 Installing an expansion card .....	2-16
2.5.2 Configuring an expansion card .....	2-16

# Contents

2.5.3	Interrupt assignments .....	2-17
2.5.4	PCI slots .....	2-18
2.5.5	AGP slot .....	2-18
2.5.6	Wi-Fi slot .....	2-19
2.6	Jumpers .....	2-20
2.7	Connectors .....	2-23
2.7.1	Rear panel connectors .....	2-23
2.7.2	Internal connectors .....	2-25

## Chapter 3: Powering up

3.1	Starting up for the first time .....	3-1
3.2	Powering off the computer .....	3-2
3.2.1	Using the OS shut down function .....	3-2
3.2.2	Using the dual function power switch .....	3-2

## Chapter 4: BIOS setup

4.1	Managing and updating your BIOS .....	4-1
4.1.1	Creating a bootable floppy disk .....	4-1
4.1.2	Using AFUDOS to update the BIOS .....	4-2
4.1.3	Using AFUDOS to copy BIOS from PC .....	4-3
4.1.4	Using ASUS EZ Flash to update the BIOS .....	4-4
4.1.5	Recovering the BIOS with CrashFree BIOS 2 .....	4-5
4.1.6	ASUS Update .....	4-7
4.2	BIOS Setup program .....	4-9
4.2.1	BIOS menu screen .....	4-10
4.2.2	Menu bar .....	4-10
4.2.3	Navigation keys .....	4-10
4.2.4	Menu items .....	4-11
4.2.5	Sub-menu items .....	4-11
4.2.6	Configuration fields .....	4-11
4.2.7	Pop-up window .....	4-11
4.2.8	Scroll bar .....	4-11
4.2.9	General help .....	4-11
4.3	Main menu .....	4-12
4.3.1	System Time .....	4-12
4.3.2	System Date .....	4-12
4.3.3	Legacy Diskette A .....	4-12
4.3.4	Language .....	4-12

# Contents

4.3.5	Primary and Secondary IDE Master/Slave; Third and Fourth IDE Master .....	4-13
4.3.6	IDE Configuration .....	4-14
4.3.7	System Information .....	4-16
4.4	Advanced menu .....	4-16
4.4.1	JumperFree Configuration .....	4-17
4.4.2	CPU Configuration .....	4-19
4.4.3	Chipset .....	4-20
4.4.4	Onboard Devices Configuration .....	4-22
4.4.5	PCI PnP .....	4-24
4.4.6	USB Configuration .....	4-25
4.4.7	Instant Music Configuration .....	4-27
4.5	Power menu .....	4-28
4.5.1	Suspend Mode .....	4-28
4.5.2	Repost Video on S3 Resume .....	4-28
4.5.3	ACPI 2.0 Support .....	4-28
4.5.4	ACPI APIC Support .....	4-28
4.5.5	APM Configuration .....	4-29
4.5.6	Hardware Monitor .....	4-31
4.6	Boot menu .....	4-32
4.6.1	Boot Device Priority .....	4-33
4.6.2	Boot Settings Configuration .....	4-33
4.6.3	Security .....	4-35
4.7	Exit menu .....	4-37

## Chapter 5: Software support

5.1	Install an operating system .....	5-1
5.2	Support CD information .....	5-1
5.2.1	Running the support CD .....	5-1
5.2.2	Drivers menu .....	5-2
5.2.3	Utilities menu .....	5-3
5.2.4	ASUS Contact Information .....	5-4
5.2.5	Other information .....	5-5
5.3	Software Information .....	5-7
5.3.1	ASUS MyLogo2™ .....	5-7
5.3.2	ASUS Instant Music .....	5-9
5.4	AI Net feature .....	5-12

# Contents

5.5	SoundMAX® 4 XL software .....	5-13
	Setup wizards .....	5-14
5.6	Intel® RAID for Serial ATA configuration .....	5-17
5.6.1	BIOS Configuration .....	5-17
5.6.2	Installing Serial ATA (SATA) hard disks .....	5-17
5.6.3	Creating, Deleting, and Resetting RAID Sets .....	5-18
5.6.4	Creating a RAID Volume .....	5-18
5.6.5	Deleting a RAID Volume .....	5-19
5.6.6	Reset RAID Data .....	5-20
5.7	Creating a RAID driver disk .....	5-21

## Quick Reference Card

# Notices

## Federal Communications Commission Statement

This device complies with Part 15 of the FCC Rules. Operation is subject to the following two conditions:

- This device may not cause harmful interference, and
- This device must accept any interference received including interference that may cause undesired operation.

This equipment has been tested and found to comply with the limits for a Class B digital device, pursuant to Part 15 of the FCC Rules. These limits are designed to provide reasonable protection against harmful interference in a residential installation. This equipment generates, uses and can radiate radio frequency energy and, if not installed and used in accordance with manufacturer's instructions, may cause harmful interference to radio communications. However, there is no guarantee that interference will not occur in a particular installation. If this equipment does cause harmful interference to radio or television reception, which can be determined by turning the equipment off and on, the user is encouraged to try to correct the interference by one or more of the following measures:

- Reorient or relocate the receiving antenna.
- Increase the separation between the equipment and receiver.
- Connect the equipment to an outlet on a circuit different from that to which the receiver is connected.
- Consult the dealer or an experienced radio/TV technician for help.



---

The use of shielded cables for connection of the monitor to the graphics card is required to assure compliance with FCC regulations. Changes or modifications to this unit not expressly approved by the party responsible for compliance could void the user's authority to operate this equipment.

---

## Canadian Department of Communications Statement

This digital apparatus does not exceed the Class B limits for radio noise emissions from digital apparatus set out in the Radio Interference Regulations of the Canadian Department of Communications.

**This class B digital apparatus complies with Canadian ICES-003.**

# Safety information

## Electrical safety

- To prevent electrical shock hazard, disconnect the power cable from the electrical outlet before relocating the system.
- When adding or removing devices to or from the system, ensure that the power cables for the devices are unplugged before the signal cables are connected. If possible, disconnect all power cables from the existing system before you add a device.
- Before connecting or removing signal cables from the motherboard, ensure that all power cables are unplugged.
- Seek professional assistance before using an adapter or extension cord. These devices could interrupt the grounding circuit.
- Make sure that your power supply is set to the correct voltage in your area. If you are not sure about the voltage of the electrical outlet you are using, contact your local power company.
- If the power supply is broken, do not try to fix it by yourself. Contact a qualified service technician or your retailer.

## Operation safety

- Before installing the motherboard and adding devices on it, carefully read all the manuals that came with the package.
- Before using the product, make sure all cables are correctly connected and the power cables are not damaged. If you detect any damage, contact your dealer immediately.
- To avoid short circuits, keep paper clips, screws, and staples away from connectors, slots, sockets and circuitry.
- Avoid dust, humidity, and temperature extremes. Do not place the product in any area where it may become wet.
- Place the product on a stable surface.
- If you encounter technical problems with the product, contact a qualified service technician or your retailer.



# About this guide

This user guide contains the information you need when installing the motherboard.

## How this guide is organized

This manual contains the following parts:

- **Chapter 1: Product introduction**  
This chapter describes the motherboard features of the and the new technologies it supports.
- **Chapter 2: Hardware information**  
This chapter lists the hardware setup procedures that you have to perform when installing system components. It includes description of the jumpers and connectors on the motherboard.
- **Chapter 3: Powering up**  
This chapter describes the power up sequence, the vocal POST messages, and ways of shutting down the system.
- **Chapter 4: BIOS setup**  
This chapter tells how to change system settings through the BIOS Setup menus. Detailed descriptions of the BIOS parameters are also provided.
- **Chapter 5: Software support**  
This chapter describes the contents of the support CD that comes with the motherboard package.

## Where to find more information

Refer to the following sources for additional information and for product and software updates.

### 1. ASUS websites

The ASUS website provides updated information on ASUS hardware and software products. Refer to the ASUS contact information.

### 2. Optional documentation

Your product package may include optional documentation, such as warranty flyers, that may have been added by your dealer. These documents are not part of the standard package.

## Conventions used in this guide

To make sure that you perform certain tasks properly, take note of the following symbols used throughout this manual.



**DANGER/WARNING:** Information to prevent injury to yourself when trying to complete a task.



**CAUTION:** Information to prevent damage to the components when trying to complete a task.



**IMPORTANT:** Information that you **MUST** follow to complete a task.



**NOTE:** Tips and additional information to aid in completing a task.

## Typography

**Bold text**

Indicates a menu or an item to select.

*Italics*

Used to emphasize a word or a phrase.

<Key>

Keys enclosed in the less-than and greater-than sign indicates that you must press the enclosed key. Example: <Enter> indicates that you must press the Enter or Return key.

<Multiple key names>

If you must press two or more keys simultaneously, the key names are linked with a plus sign (+). Example: <Ctrl+Alt+D>

Command

Means that you must enter the command exactly as shown then supply the appropriate values that appear in brackets. Example:

At the DOS prompt, type the command line:

```
afudos /i[filename]
```

In this example, you must supply a filename for [filename].

```
afudos /iP4P800E.ROM
```

# P4P800 SE specifications summary

<b>CPU</b>	Socket 478 for Intel® Pentium® 4 / Celeron processors with speeds up to 3.2 GHz+ Supports Intel® Hyper-Threading Technology Supports Intel® Prescott CPU
<b>Chipset</b>	Intel® 865PE Intel® ICH5R
<b>Front Side Bus (FSB)</b>	800/533/400 MHz
<b>Memory</b>	Dual-channel memory architecture 4 x 184-pin DDR DIMM sockets for up to 4GB unbuffered non-ECC DDR400/333/266 SDRAM memory ASUS Hyper-Path Technology
<b>Expansion slots</b>	1 x AGP 8X (0.8V, 1.5V only) 5 x PCI 1 x ASUS WiFi slot for optional wireless LAN upgrade
<b>Storage</b>	ICH5R SouthBridge supports <ul style="list-style-type: none"> <li>- 2 x UltraDMA 100/66/33</li> <li>- 2 x Serial ATA with RAID 0, RAID 1 function</li> </ul>
<b>AI Audio</b>	ADI AD1985 SoundMAX® 6-channel CODEC Audio Sensing and Enumeration Technology S/PDIF out interface support
<b>AI Net</b>	Marvell® 88E8001 Gigabit Ethernet controller Virtual Cable Tester (VCT) Technology support
<b>AI BIOS</b>	ASUS CrashFree BIOS2 ASUS Q-Fan Technology
<b>AI Overclocking</b>	Intelligent CPU frequency tuner ASUS JumperFree CPU, Memory and AGP voltage adjustable SFS (Stepless Frequency Selection) from 100MHz up to 400MHz at 1MHz increment Adjustable FSB/DDR ratio. Fixed AGP/PCI frequencies ASUS C.P.R. (CPU Parameter Recall)
<b>Special features</b>	Power Loss Restart S/PDIF out interface support

*(continued on the next page)*

# P4P800 SE specifications summary

<b>Rear panel I/O</b>	1 x Parallel port 1 x Serial port 1 x S/PDIF output port 1 x PS/2 Keyboard port 1 x PS/2 Mouse port 1 x RJ45 port 4 x USB 2.0 ports 6-channel audio I/O ports
<b>Internal I/O</b>	2 x USB 2.0 connectors for four additional USB 2.0 ports CPU/Chassis/Power fan connectors 20-pin/4-pin ATX 12V power connectors Chassis intrusion S/PDIF-out connector GAME/MIDI connector CD/AUX/Modem audio connectors Front panel audio connector Serial port 2 connector
<b>BIOS features</b>	4Mb Flash ROM, AMI BIOS, PnP, DMI2.0, WfM2.0, SM BIOS 2.3, ASUS EZ Flash, ASUS Instant Music, ASUS MyLogo2, ASUS C.P.R., ASUS Multi-Language BIOS
<b>Industry standard</b>	PCI 2.2, PCI 2.3, USB 2.0
<b>Manageability</b>	WfM2.0, DMI 2.0, WOL, WOR, chassis intrusion
<b>Support CD contents</b>	Device drivers ASUS PC Probe ASUS AI Booster ASUS Live Update Utility Anti-virus software
<b>Form Factor</b>	ATX form factor: 12 in x 9.6 in (30.5 cm x 24.5 cm)

*\* Specifications are subject to change without notice.*

# ***Chapter 1***

This chapter describes the motherboard features and the new technologies it supports.

## **Product introduction**

## **Chapter summary**

<b>1.1</b>	<b>Welcome! .....</b>	<b>1-1</b>
<b>1.2</b>	<b>Package contents .....</b>	<b>1-1</b>
<b>1.3</b>	<b>Special features .....</b>	<b>1-2</b>

# 1.1 Welcome!

**Thank you for buying the ASUS® P4P800 SE motherboard!**

The motherboard delivers a host of new features and latest technologies making it another standout in the long line of ASUS quality motherboards!

The motherboard incorporates the Intel® Pentium® 4 processor in a 478-pin package coupled with the Intel® 865PE chipset to set a new benchmark for an effective desktop platform solution.

Supporting up to 4 GB of system memory with DDR400/333/266 SDRAM, high-resolution graphics via an AGP 8X slot, Serial ATA support, RAID, USB 2.0, and 6-channel audio features, the motherboard takes you ahead in the world of power computing!

Before you start installing the motherboard, and hardware devices on it, check the items in your package with the list below.

## 1.2 Package contents

Check your motherboard package for the following items.

- ✓ ASUS P4P800 SE motherboard
- ✓ ASUS motherboard support CD
- ✓ Intervideo® WinDVD Suite Platinum (Gold Version only)
- ✓ 2 x SATA cable
- ✓ 1 x 2-port USB+GAME module with cable (Retail boxes only)
- ✓ 1 x 80-conductor ribbon cable for UltraDMA IDE drives
- ✓ 1 x 40-conductor IDE cable
- ✓ 1 x Ribbon cable for a 3.5-inch floppy drive
- ✓ I/O shield
- ✓ Bag of extra jumper caps
- ✓ Instant Music keyboard label (Retail boxes only)
- ✓ User Guide (includes Quick Reference Card)
- ✓ Quick Setup Guide (Retail boxes only)
- ✓ Setting Sticker (Retail boxes only)



---

If any of the above items is damaged or missing, contact your retailer.

---

## 1.3 Special features

### 1.3.1 Product Highlights

#### Latest processor technology



The motherboard comes with a 478-pin surface mount, Zero Insertion Force (ZIF) socket for the Intel® Pentium® 4 processor in the 478-pin package with 512/256KB L2 cache on 0.13 micron process. This motherboard supports 800/533/400 MHz system front side bus that allows 6.4GB/s, 4.3GB/s and 3.2GB/s data transfer rates, respectively. The motherboard also supports the Intel® Hyper-Threading Technology and the next-generation Intel® Prescott CPU.

#### Dual Channel DDR memory support



Employing the Double Data Rate (DDR) memory technology, the motherboard supports up to 4GB of system memory using DDR400/333/266 DIMMs. The ultra-fast 400MHz memory bus delivers the required bandwidth for the latest 3D graphics, multimedia, and Internet applications.

#### ASUS Hyper-Path Technology



This unique technology from ASUS optimizes the true potential of the Intel® 865PE chipset to deliver the highest performance among competing 865PE-based solutions.

#### SouthBridge Integrated Serial ATA and RAID solution



The motherboard supports the next generation Serial ATA (SATA) specification with RAID 0 and RAID 1 function through the ICH5R SouthBridge controller. The Serial ATA specification provides scalable performance with up to 150MB/s data transfer rate and allows a maximum of two Serial ATA hard disks with RAID 0 and RAID 1 array.

#### AGP 8X support



AGP 8X (AGP 3.0) is the next generation VGA interface specification that enables enhanced graphics performance with high bandwidth speeds up to 2.12 GB/s.



## **S/PDIF out**

The motherboard supports S/PDIF out function turns your computer into a high-end entertainment system with digital connectivity to powerful speaker systems.

## **8 USB 2.0 ports**

The motherboard implements the new Universal Serial Bus (USB) 2.0 specification, extending the connection speed from 12 Mbps on USB 1.1 to a fast 480 Mbps on USB 2.0 - supporting up to 8 USB 2.0 ports. The higher bandwidth of USB 2.0 allows connection of devices such as high resolution video conferencing cameras, next generation scanners and printers, and fast storage units. USB 2.0 is backward compatible with USB 1.1.

## 1.3.2 Unique ASUS features

### ASUS Wi-Fi slot



The ASUS Wi-Fi slot is designed for the ASUS WiFi-b™ add-on card to set up an environment for wireless LAN. The ASUS WiFi-b™ add-on card bundles the exclusive software Access Point (AP) to save the extra cost of a stand-alone AP. In addition, the card comes with user-friendly utilities and applications that allow quick connection to notebooks, PDAs and other wireless LAN peripherals. See page 2-19.

### AI NET solution



The Marvell® Gigabit LAN controller chipset is onboard to provide a single-chip solution for LAN on Motherboard (LOM) applications. The controller integrates 32-bit 10/100/1000BASE-T Gigabit Ethernet Media Access Control (IEEE 802.3 compliant) and Physical Layer Transceiver solution to support high performance network applications. The controller is equipped with the Virtual Cable Tester (VCT) net-diagnosing utility, that intelligently diagnoses and reports cable faults from a remote location up to 100 meters. This feature helps maintain a more stable network connection. See page 5-12.

### AI Audio solution



The SoundMAX®-class ADI AD1985 AC '97 audio CODEC supports 6-channel 5.1 surround sound output, stereo microphone input, variable sample rate conversion (SRC), professional quality 103-dB output with 94-dB SNR, and analog enumeration capability. The SoundMAX® 4 XL software features the AudioESP™ (Audio Enumeration and Sensing Process) that allows intelligent detection of the peripherals plugged into the audio ports and identifies the incompatible devices, if any.. See 5-13.

### AI Overclocking



This feature allows convenient overclocking up to 30% (depending on the installed CPU and DRAM) to enhance system performance while maintaining system stability. See page 4-17.

### AI BIOS solution



The AI BIOS is a combination of three ASUS intelligent solutions: Q-Fan and CrashFree BIOS2.

## ASUS Q-Fan technology



The ASUS Q-Fan technology smartly adjusts the fan speeds according to the system loading to ensure quiet, cool, and efficient operation.

See page 4-31.

## CrashFree BIOS 2



This feature allows you to restore the original BIOS data from the ASUS support CD in case when the BIOS codes and data are corrupted. This protection eliminates the need to buy a replacement ROM chip.

See page 4-5.

## ASUS MyLogo2™



This new feature present in the motherboard allows you to personalize and add style to your system with customizable boot logos.

See pages 4-33, 5-7.

## C.P.R. (CPU Parameter Recall)



The C.P.R. feature of the motherboard BIOS allows automatic re-setting to the BIOS default settings in case the system hangs due to overclocking. When the system hangs due to overclocking, C.P.R. eliminates the need to open the system chassis and clear the RTC data. Simply reboot the system and the BIOS shows the previous setting so users can amend the CPU setting again.

## ASUS EZ Flash BIOS



With the ASUS EZ Flash, you can easily update the system BIOS even before loading the operating system. No need to use a DOS-based utility or boot from a floppy disk. See page 4-4.

## ASUS Multi-language BIOS



The multi-language BIOS allows you to select the language of your choice from the available options. The localized BIOS menus allow you to configure easier and faster. See page 4-12.

## ASUS Instant Music



This unique feature allows you to playback audio files even without booting the system to Windows™. Just press the ASUS Instant Music special function keys and enjoy the music! See pages 4-27, 5-9.

# ***Chapter 2***

This chapter lists the hardware setup procedures that you have to perform when installing system components. It includes description of the jumpers and connectors on the motherboard.

## **Hardware information**

## **Chapter summary**

<b>2.1</b>	<b>Before you proceed .....</b>	<b>2-1</b>
<b>2.2</b>	<b>Motherboard overview .....</b>	<b>2-2</b>
<b>2.3</b>	<b>Central Processing Unit (CPU) .....</b>	<b>2-6</b>
<b>2.4</b>	<b>System memory .....</b>	<b>2-12</b>
<b>2.5</b>	<b>Expansion slots .....</b>	<b>2-16</b>
<b>2.6</b>	<b>Jumpers .....</b>	<b>2-20</b>
<b>2.7</b>	<b>Connectors .....</b>	<b>2-23</b>

## 2.1 Before you proceed

Take note of the following precautions before you install motherboard components or change any motherboard settings.



- Unplug the power cord from the wall socket before touching any component.
- Use a grounded wrist strap or touch a safely grounded object or to a metal object, such as the power supply case, before handling components to avoid damaging them due to static electricity.
- Hold components by the edges to avoid touching the ICs on them.
- Whenever you uninstall any component, place it on a grounded antistatic pad or in the bag that came with the component.
- Before you install or remove any component, ensure that the ATX power supply is switched off or the power cord is detached from the power supply. Failure to do so may cause severe damage to the motherboard, peripherals, and/or components.

### Onboard LED

The motherboard comes with a standby power LED. When lit, this green LED indicates that the system is ON, in sleep mode, or in soft-off mode, a reminder that you should shut down the system and unplug the power cable before removing or plugging in any motherboard component. The illustration below shows the location of the onboard LED.

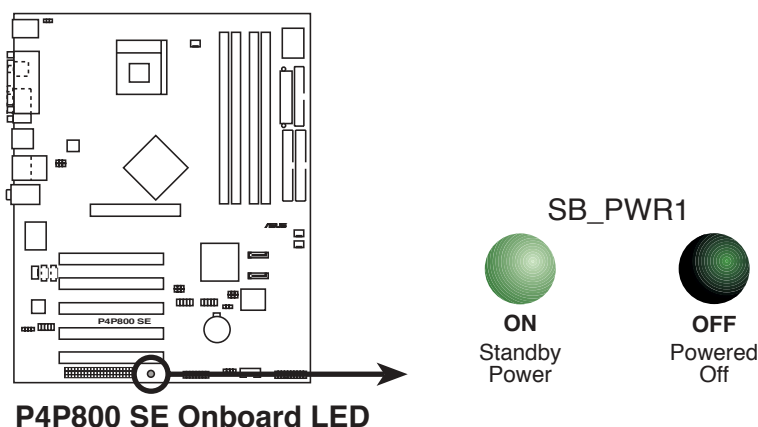

## 2.2 Motherboard overview

Before you install the motherboard, study the configuration of your chassis to ensure that the motherboard fits into it.



Make sure to unplug the power cord before installing or removing the motherboard. Failure to do so may cause you physical injury and damage motherboard components.

### 2.2.1 Placement direction

When installing the motherboard, make sure that you place it into the chassis in the correct orientation. The edge with external ports goes to the rear part of the chassis as indicated in the image below.

### 2.2.2 Screw holes

Place nine (9) screws into the holes indicated by circles to secure the motherboard to the chassis.



Do not overtighten the screws! Doing so may damage the motherboard.

Place this side towards the rear of the chassis

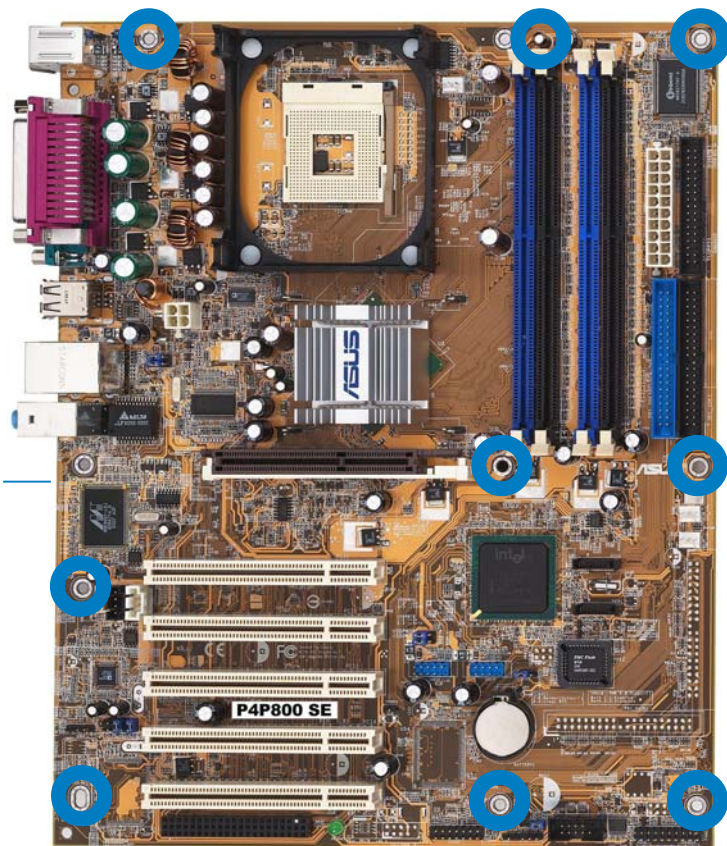



## 2.2.3 Motherboard layout

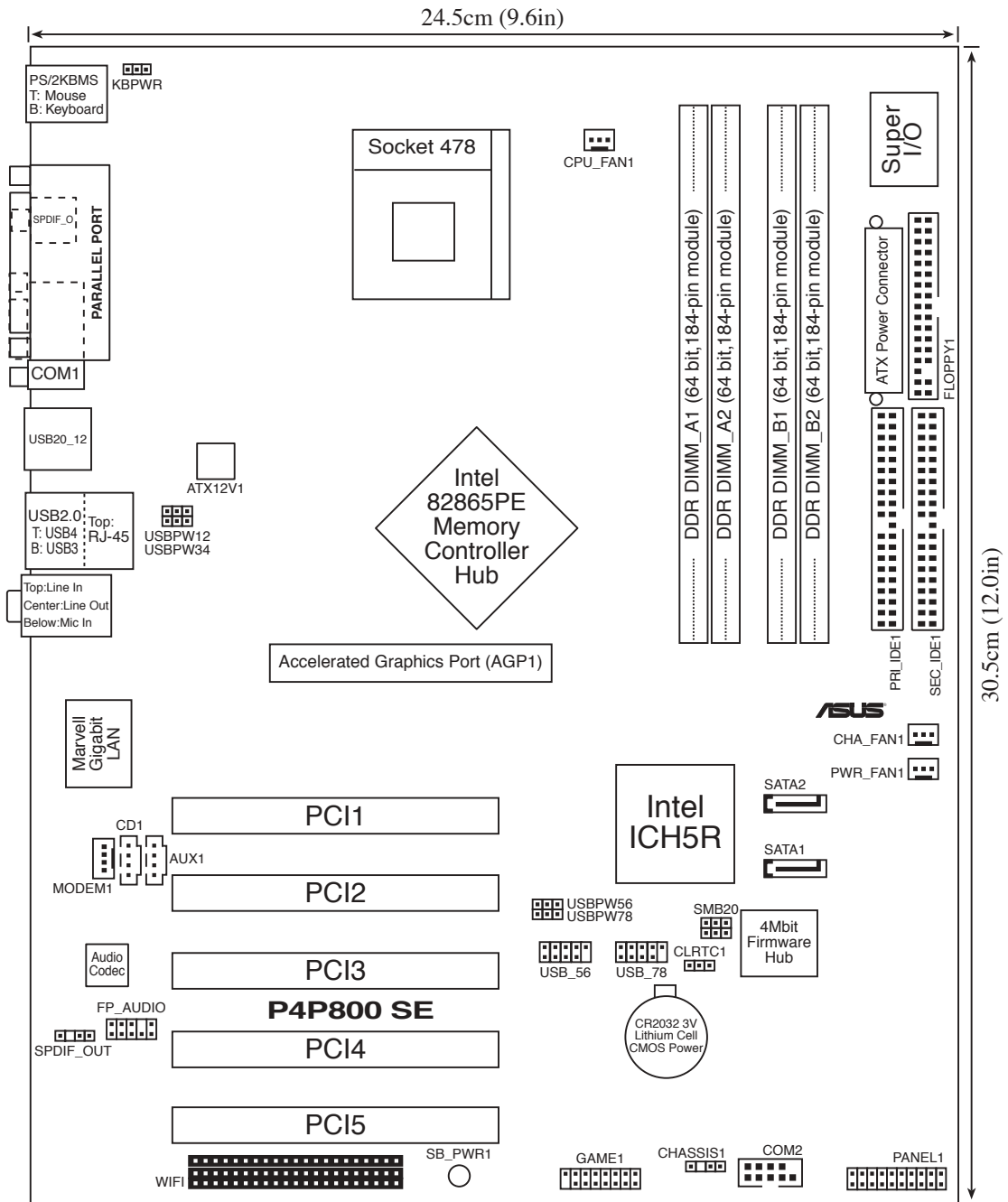

## 2.2.4 Layout Contents

Slots	Page
1. DDR DIMM slots	2-12
2. PCI slots	2-18
3. AGP slot	2-18
4. Wi-Fi slot	2-19

Jumpers	Page
1. Clear RTC RAM (3-pin CLRRTC)	2-20
2. USB device wake-up (3-pin USBPW12, USBPW34, USBPW56, USBPW78)	2-21
3. Keyboard power (3-pin KBPWR)	2-22
4. SMB 2.0 jumper	2-22

Rear Panel Connectors	Page
1. PS/2 mouse port	2-23
2. Parallel port	2-23
3. Line In jack	2-23
4. Line Out jack	2-23
5. Microphone jack	2-23
6. USB 2.0 ports 3 and 4	2-23
7. USB 2.0 ports 1 and 2	2-23
8. Serial connector	2-23
9. S/PDIF Coaxial cable jack	2-23
10. PS/2 keyboard port	2-23

<b>Internal Connectors</b>	<b>Page</b>
1. Floppy disk connector (34-1 pin FLOPPY)	2-25
2. Primary IDE connector (40-1 pin PRI_IDE1)	2-25
3. Secondary IDE connector (40-1 pin SEC_IDE1)	2-25
4. Serial ATA connectors (7-pin SATA1, SATA2)	2-26
5. CPU fan connector (3-pin CPU_FAN)	2-28
6. Power fan connector (3-pin PWR_FAN)	2-28
7. Chassis fan connector (3-pin CHA_FAN)	2-28
8. Serial Port 2 connector (10-1 pin COM2)	2-28
9. ATX power connector (20-pin ATXPWR)	2-29
10. ATX 12V power connector (4-pin ATX12V)	2-29
11. USB headers (10-1 pin USB_56, USB_78)	2-30
12. CD connector (4-pin CD)	2-31
13. AUX connector (4-pin AUX)	2-31
14. MODEM connector (4-pin MODEM)	2-31
15. Front panel audio connector (10-1 pin FP_AUDIO)	2-31
16. GAME/MIDI connector (16-1 pin GAME)	2-32
17. Chassis Intrusion connector (4-1 pin CHASSIS)	2-32
18. System panel connector (20-pin PANEL)	2-33
- System Power LED Lead (Green 3-1 pin PLED)	
- System Warning Speaker Lead (Orange 4-pin SPKR)	
- Reset Switch (Blue 2-pin RESET)	
- ATX Power Switch (Yellow 2-pin PWRBTN)	
- System Management Interrupt Lead (Light Blue 2-pin SMI)	
- Hard Disk Activity LED (Red 2-pin IDE_LED)	

## 2.3 Central Processing Unit (CPU)

### 2.3.1 Overview

The motherboard comes with a surface mount 478-pin Zero Insertion Force (ZIF) socket designed for the Intel® Pentium® 4 processor.

Take note of the marked corner (with gold triangle) on the CPU. This mark should match a specific corner on the socket to ensure correct installation.

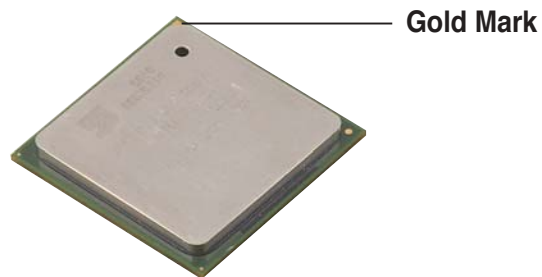

### Notes on Intel® Hyper-Threading Technology



- This motherboard supports Intel® Pentium® 4 CPUs with Hyper-Threading Technology.
- Hyper-Threading Technology is supported under Windows® XP and Linux 2.4.x (kernel) and later versions only. Under Linux, use the Hyper-Threading compiler to compile the code. If you are using any other operating systems, disable the Hyper-Threading Technology item in BIOS to ensure system stability and performance.
- It is recommended that you install Windows® XP Service Pack 1.
- Make sure to enable the Hyper-Threading Technology item in BIOS before installing a supported operating system.
- For more information on Hyper-Threading Technology, visit [www.intel.com/info/hyperthreading](http://www.intel.com/info/hyperthreading).

To use the Hyper-Threading Technology on this motherboard:

1. Buy an Intel® Pentium® 4 CPU that supports Hyper-Threading Technology. Install the CPU.
2. Power up the system and enter BIOS Setup (see Chapter 4). Under the Advanced Menu, make sure that the item **Hyper-Threading Technology** is set to Enabled. The item appears only if you installed a CPU that supports Hyper-Threading Technology.
3. Reboot the computer.

## 2.3.2 Installing the CPU

Follow these steps to install a CPU.

1. Locate the 478-pin ZIF socket on the motherboard.

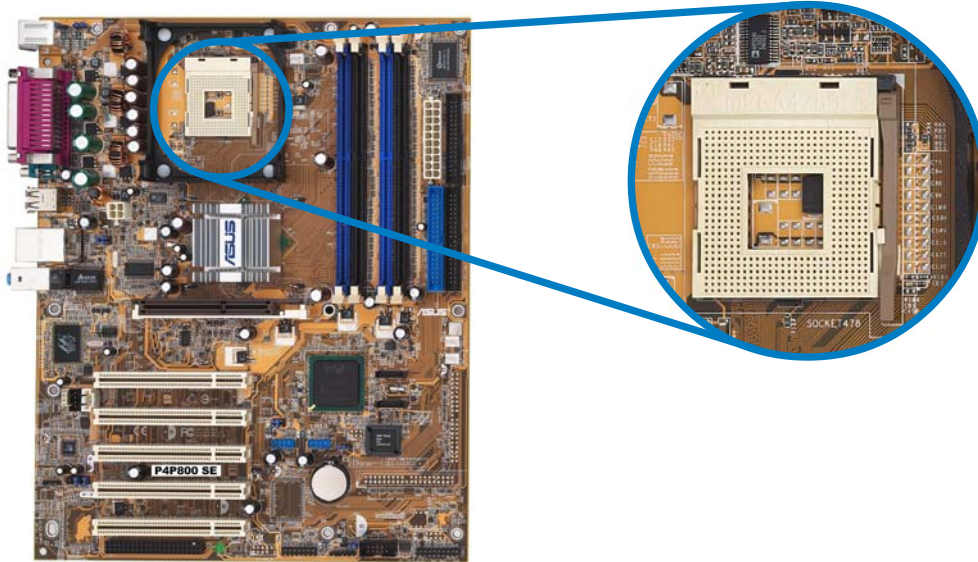

2. Unlock the socket by pressing the lever sideways, then lift it up to a 90°-100° angle.

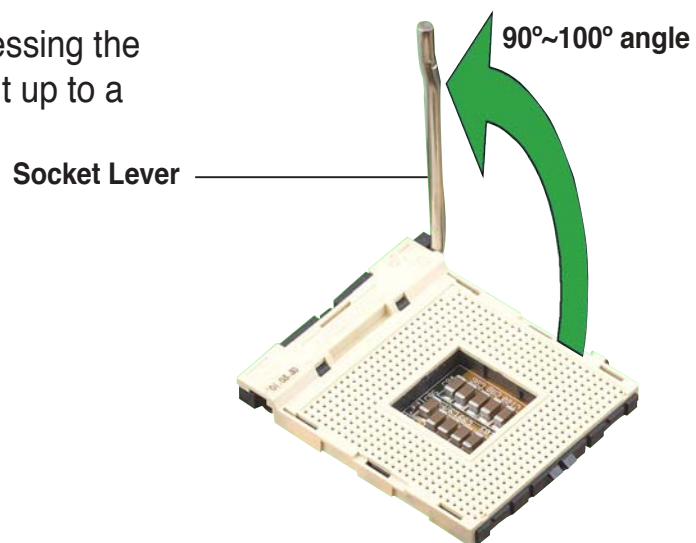

Make sure that the socket lever is lifted up to 90°-100° angle; otherwise, the CPU does not fit in completely.

3. Position the CPU above the socket such that its marked corner matches the base of the socket lever.

4. Carefully insert the CPU into the socket until it fits in place.

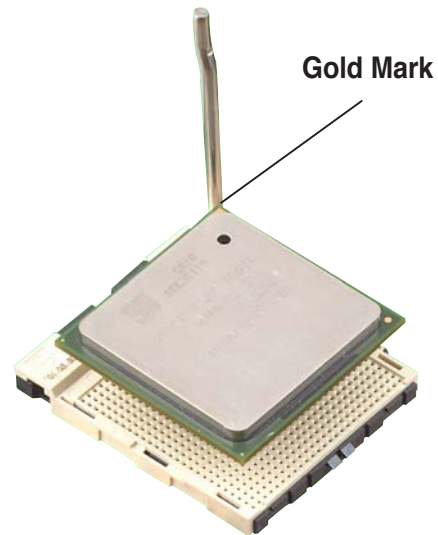

---

The CPU fits only in one correct orientation. DO NOT force the CPU into the socket to prevent bending the pins and damaging the CPU!

---

5. When the CPU is in place, push down the socket lever to secure the CPU. The lever clicks on the side tab to indicate that it is locked.

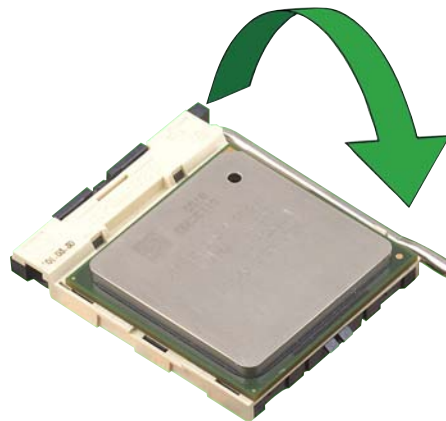

---

After installation, make sure to plug-in the 4-pin ATX power cable to the motherboard.

---



---

This motherboard does not support unlocked Intel® Willamette CPUs.

---

## 2.3.3 Installing the heatsink and fan

The Intel® Pentium® 4 Processor requires a specially designed heatsink and fan assembly to ensure optimum thermal condition and performance.



---

When you buy a boxed Intel® Pentium® 4 processor, the package includes the heatsink, fan, and retention mechanism.

In case you buy a CPU separately, make sure that you use only Intel®-certified heatsink and fan.

---

Follow these steps to install the CPU heatsink and fan.

1. Place the heatsink on top of the installed CPU, making sure that the heatsink fits properly on the retention module base.



---

The retention module base is already installed on the motherboard upon purchase.

You do not have to remove the retention module base when installing the CPU or installing other motherboard components.

---

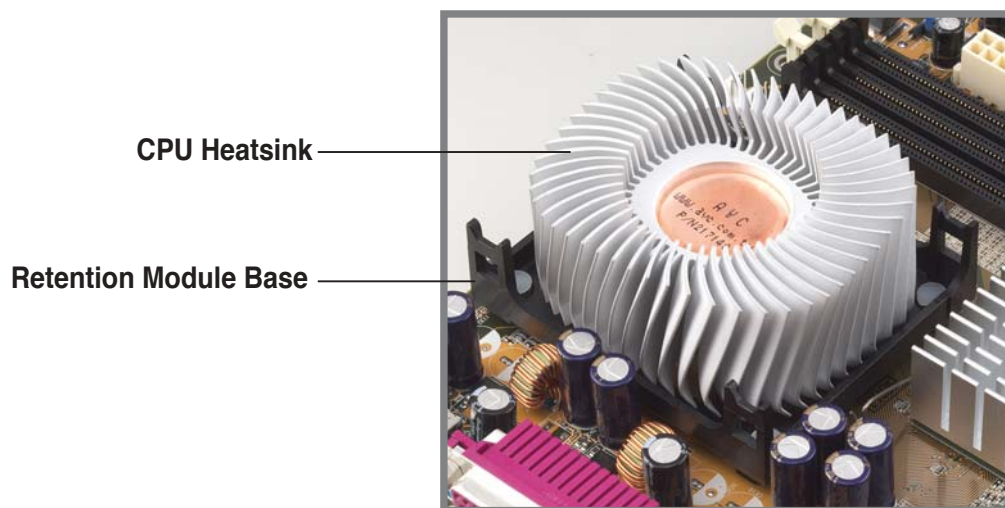

---

Your boxed Intel® Pentium® 4 processor package should come with installation instructions for the CPU, heatsink, and the retention mechanism. If the instructions in this section do not match the CPU documentation, follow the latter.

---



2. Position the fan with the retention mechanism on top of the heatsink. Align and snap the four hooks of the retention mechanism to the holes on each corner of the module base.



---

Make sure that the fan and retention mechanism assembly perfectly fits the heatsink and module base, otherwise you cannot snap the hooks into the holes.

---

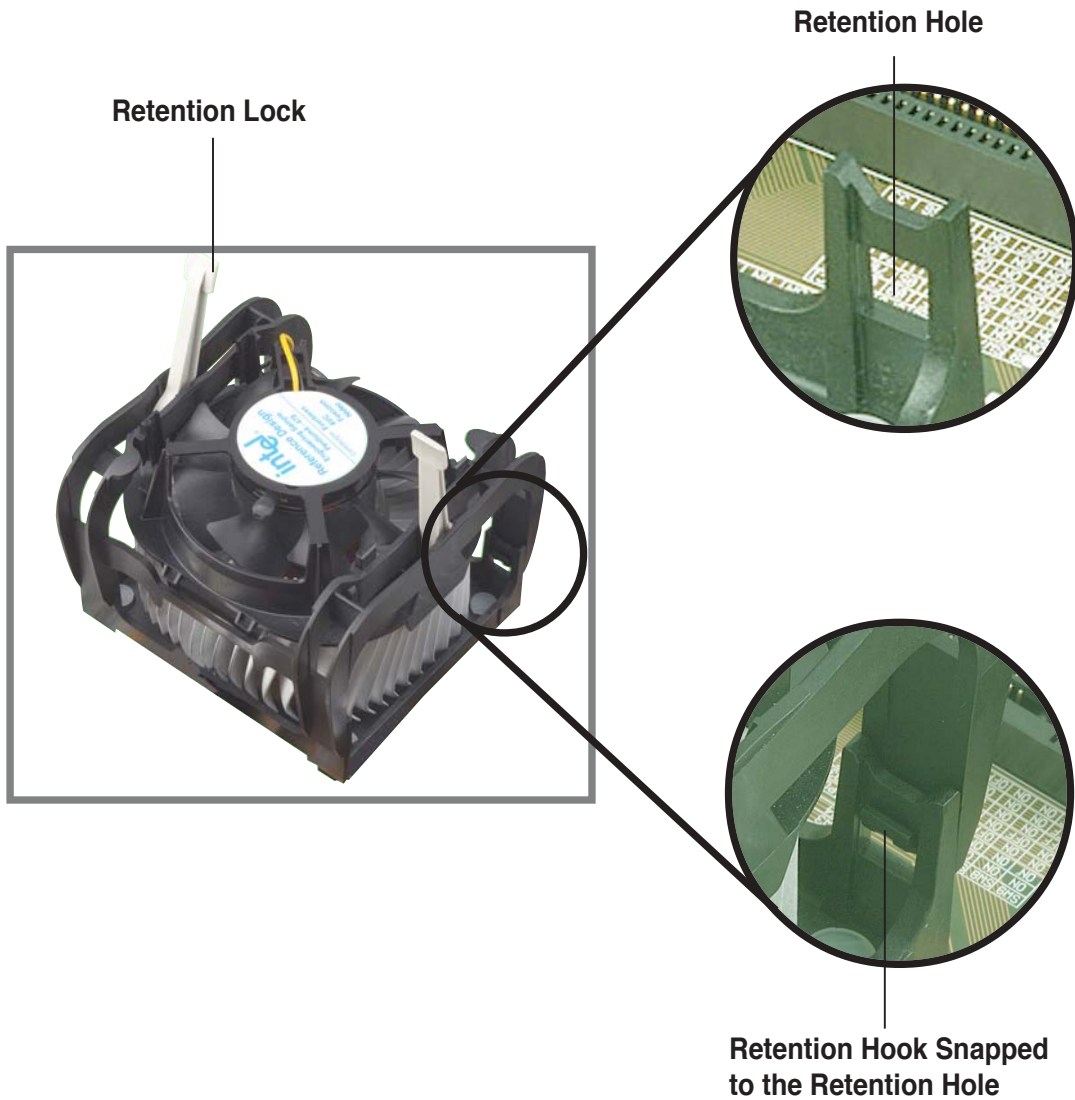

---

Keep the retention locks lifted upward while fitting the retention mechanism to the module base.

---



3. Push down the locks on the retention mechanism to secure the heatsink and fan to the module base.



---

When secure, the retention locks should point to opposite directions.

---



### 2.3.4 Connecting the CPU fan cable

When the fan, heatsink, and the retention mechanism are in place, connect the CPU fan cable to the connector on the motherboard labeled CPU\_FAN.

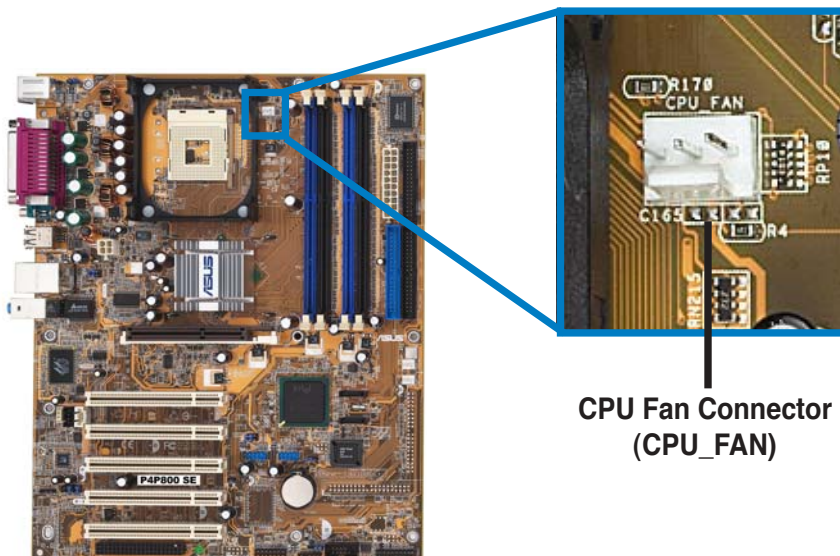

---

Do not forget to connect the CPU fan connector! Hardware monitoring errors may occur if you fail to plug this connector.

---

## 2.4 System memory

### 2.4.1 Overview

The motherboard comes with four Double Data Rate (DDR) Dual Inline Memory Module (DIMM) sockets.

The following figure illustrates the location of the sockets.

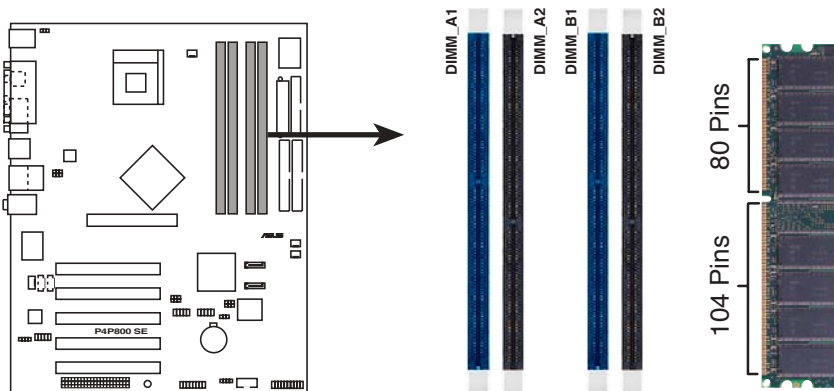

**P4P800 SE 184-Pin DDR DIMM Sockets**

### 2.4.2 Memory configurations

You may install 64 MB, 128 MB, 256 MB, 512 MB, and 1GB DDR DIMMs into the DIMM sockets using the memory configurations in this section.

#### Important notes on memory configurations



1. Installing DDR DIMMs other than the recommended configurations may cause memory sizing error or system boot failure. Use any of the recommended configurations in Table 1.
2. Use the blue DIMM slots first.
3. In Dual-channel configurations, install only identical (the same type and size) DDR DIMM pairs for each channel.
4. Always install DIMMs with the same CAS latency, otherwise, the system may run in a lower frequency. For optimum compatibility, it is recommended that you obtain memory modules from the same vendor. See list of Qualified Vendors List on page 2-13.
5. When all four sockets are populated with 1GB DIMMs (total 4 GB), the system may detect only 3+GB (a little less than 4 GB) due to the Southbridge resource allocation.
6. Three DDR DIMMs installed into any three memory sockets will function in single channel mode.
7. Make sure that the memory frequency matches the CPU FSB. Refer to Table 2 for configurations.

**Table 1 Recommended memory configurations**

Mode/DIMM Type		Sockets			
		DIMM_A1 (blue)	DIMM_A2 (black)	DIMM_B1 (blue)	DIMM_B2 (black)
Single-channel (DDR400/DDR333/ DDR266)	(1)	Populated	—	—	—
	(2)	—	Populated	—	—
	(3)	—	—	Populated	—
	(4)	—	—	—	Populated
Dual-channel (DDR400/DDR333/ DDR266)	(1)	Populated	—	Populated	—
	(2)	—	Populated	—	Populated
	(3)*	Populated	Populated	Populated	Populated

\* For dual-channel configuration (3), you may:

- install identical DIMMs in all four sockets or
- install identical DIMM pair in DIMM\_A1 and DIMM\_B1 (blue sockets) and identical DIMM pair in DIMM\_A2 and DIMM\_B2 (black sockets)

**Table 2 Memory frequency/CPU FSB synchronization**

CPU FSB	DDR DIMM Type	Memory Frequency
800 MHz	PC3200/PC2700*/PC2100	400/333*/266 MHz
533 MHz	PC2700/PC2100	333/266 MHz
400 MHz	PC2100	266 MHz



\*When using 800MHz CPU FSB, PC2700 DDR DIMMs may run only at 320MHz (not 333MHz) due to chipset limitation.

## 2.4.3 Qualified Vendor List

The following table lists the DDR400 memory modules that have been tested and qualified for use with this motherboard.

Size	Vendor	Model	Brand	SS/DS	Component	A*	B*	C*
256MB	A DATA	MDGA5F3G315B1EC2	ADATA	SS	ADD8608A8A-5B	•	•	•
256MB	A DATA	MDOWB5F3G316B1EAE	Winbond	SS	W942508BH-5	•	•	
256MB	A DATA	MDOSS6F3G31JB1EAE	SAMSUNG	SS	K4H560838D-TCC4	•	•	
256MB	Apacer	77.10636.465	SAMSUNG	SS	K4H560838D-TCC4	•	•	•
512MB	Apacer	77.10736.464	SAMSUNG	DS	K4H560838D-TCC4	•	•	•
256MB	Corsair	CMX256-3500C2 XMS3502v1.1	N/A	SS	N/A	•	•	
512MB	Corsair	CMX512-3500C2 XMS3502v1.1	N/A	DS	N/A	•	•	
256MB	Hynix	HYMD232646B8J-D43AA	Hynix	SS	HY5DU56822BT-D43	•	•	•
512MB	Hynix	HYMD232646B8J-D43AA	Hynix	DS	HY5DU56822BT-D43	•	•	•
128MB	Infineon	HYS64D16301GU-5-B	Infineon	SS	HYB25D256160BT-5B	•	•	•
256MB	Infineon	HYS64D32300GU-5-B	Infineon	SS	HYB25D256800BT-5B	•	•	•
512MB	Infineon	HYS64D64320GU-5-B	Infineon	SS	HYB25D256800BT-5B	•	•	•
256MB	Kingston	KVR400X64C25/256	Winbond	SS	W942508BH-5	•	•	•
512MB	Kingston	KVR400X64C25/512	Winbond	DS	W942508BH-5	•		
256MB	Kingston	KHX3500/256	N/A	SS	N/A	•	•	
256MB	MICRON	MT16VDDT3264AG-403B2	MICRON	DS	MT46V16M8-5TESB	•	•	
512MB	PSC	AL6D8A53TK1-5B	PSC	DS	A2S56D30ATP	•	•	•
256MB	SAMSUNG	M368L3223ETM-CCC	SAMSUNG	SS	K4H560838E-TCCC	•	•	•
512MB	SAMSUNG	M368L6423ETM-CCC	SAMSUNG	DS	K4H560838E-TCCC	•	•	•
256MB	Transcend	TS32MLD64V4F3	SAMSUNG	SS	K4H560838D-TCC4	•	•	
256MB	Transcend	TS32MLD64V4F3	Mosel	SS	V58C2256804SAT5	•	•	
512MB	Transcend	TS64MLD64V4F3	SAMSUNG	DS	K4H560838D-TCC4	•	•	
256MB	Transcend	TS64MLD64V4F3	Mosel	DS	V58C2256804SAT5	•	•	•
256MB	TwinMOS	M2G9108AFATT9FD81AA4T	TwinMOS	SS	TMD7608F8E50D	•	•	•
512MB	TwinMOS	M2G9J16AGATT9F081AA4T	TwinMOS	DS	TMD7608F8E50D	•	•	
256MB	TwinMOS	M2S9108AFAPS9F0811A-T	PSC	SS	A2S56D30ATP	•	•	•
256MB	Winbond	W9425GCDB-5	Winbond	SS	W942508CH-5	•	•	•
512MB	Winbond	W9451GCDB-5	Winbond	DS	W942508CH-5	•	•	•

- A\*** - supports one module inserted in the slot referred in Table 1, in a Single-channel memory configuration.
- B\*** - supports one pair of modules inserted into either the blue slots or the yellow slots as one pair of Dual-channel memory configuration .
- C\*** - support for 4 modules inserted into the blue & yellow slots as two pairs of Dual-channel memory configuration.



Obtain DDR DIMMs only from ASUS qualified vendors. Visit the ASUS website ([www.asus.com](http://www.asus.com)) for the latest QVL.

## 2.4.4 Installing a DIMM



Make sure to unplug the power supply before adding or removing DIMMs or other system components. Failure to do so may cause severe damage to both the motherboard and the components.

1. Unlock a DIMM socket by pressing the retaining clips outward.
2. Align a DIMM on the socket such that the notch on the DIMM matches the break on the socket.

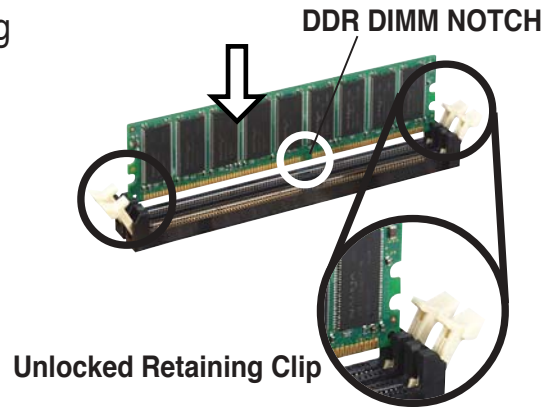

A DDR DIMM is keyed with a notch so that it fits in only one direction. DO NOT force a DIMM into a socket to avoid damaging the DIMM.

3. Firmly insert the DIMM into the socket until the retaining clips snap back in place and the DIMM is properly seated.

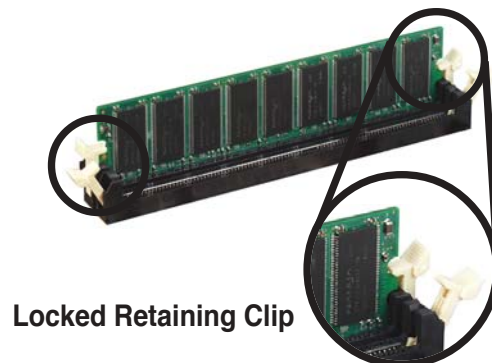

## 2.4.5 Removing a DIMM

Follow these steps to remove a DIMM.

1. Simultaneously press the retaining clips outward to unlock the DIMM.

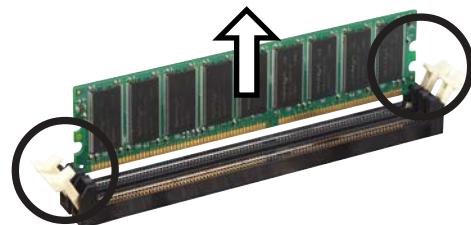

Support the DIMM lightly with your fingers when pressing the retaining clips. The DIMM might get damaged when it flips out with extra force.

2. Remove the DIMM from the socket.

## 2.5 Expansion slots

In the future, you may need to install expansion cards. The motherboard has available PCI slots and an Accelerated Graphics Port (AGP) slot. The following sub-sections describe the slots and the expansion cards that they support.



---

Make sure to unplug the power cord before adding or removing expansion cards. Failure to do so may cause you physical injury and damage motherboard components.

---

### 2.5.1 Installing an expansion card

Follow these steps to install an expansion card.

1. Before installing the expansion card, read the documentation that came with it and make the necessary hardware settings for the card.
2. Remove the system unit cover (if your motherboard is already installed in a chassis).
3. Remove the bracket opposite the slot that you intend to use. Keep the screw for later use.
4. Align the card connector with the slot and press firmly until the card is completely seated on the slot.
5. Secure the card to the chassis with the screw you removed earlier.
6. Replace the system cover.

### 2.5.2 Configuring an expansion card

After installing the expansion card, configure the card by adjusting the software settings.

1. Turn on the system and change the necessary BIOS settings, if any. See Chapter 4 for information on BIOS setup.
2. Assign an IRQ to the card. Refer to the tables on the next page.
3. Install the software drivers for the expansion card.

## 2.5.3 Interrupt assignments

### Standard Interrupt Assignments

IRQ	Priority	Standard Function
0	1	System Timer
1	2	Keyboard Controller
2	N/A	Programmable Interrupt
3*	11	Communications Port (COM2)
4*	12	Communications Port (COM1)
5*	13	Sound Card (sometimes LPT2)
6	14	Floppy Disk Controller
7*	15	Printer Port (LPT1)
8	3	System CMOS/Real Time Clock
9*	4	ACPI Mode when used
10*	5	IRQ Holder for PCI Steering
11*	6	IRQ Holder for PCI Steering
12*	7	PS/2 Compatible Mouse Port
13	8	Numeric Data Processor
14*	9	Primary IDE Channel
15*	10	Secondary IDE Channel

\* These IRQs are usually available for ISA or PCI devices.

### IRQ assignments for this motherboard

	A	B	C	D	E	F	G	H
PCI slot 1	—	—	—	—	—	shared	—	—
PCI slot 2	—	—	—	—	—	—	shared	—
PCI slot 3	—	—	—	—	—	—	—	shared
PCI slot 4	—	—	—	—	shared	—	—	—
PCI slot 5	—	—	—	—	—	shared	—	—
AGP slot	used	—	—	—	—	—	—	—
Onboard USB 1.1/2.0 controller	—	—	—	—	shared	shared	shared	shared
Onboard LAN	—	—	—	—	—	—	shared	—
Onboard Audio	—	—	used	—	—	—	—	—



When using PCI cards on shared slots, ensure that the drivers support “Share IRQ” or that the cards do not need IRQ assignments. Otherwise, conflicts will arise between the two PCI groups, making the system unstable and the card inoperable.



## 2.5.4 PCI slots

The PCI slots support PCI cards such as a LAN card, SCSI card, USB card, and other cards that comply with PCI specifications. The following figure shows a LAN card installed on a PCI slot.

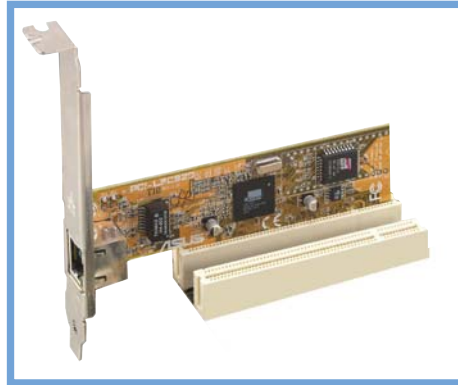

- When installing long PCI cards, it is recommended that you install it in PCI slots 3, 4, or 5. Long PCI cards installed in PCI slots 1 and 2 may interfere with the SATA and GAME connectors.
- The PCI slot 5 and Wi-Fi slot can not be used at the same time.

## 2.5.5 AGP slot

The Accelerated Graphics Port (AGP) slot that supports AGP8X/4X cards. When you buy an AGP card, make sure that you ask for one with +1.5V specification. Note the notches on the card golden fingers to ensure that they fit the AGP slot on your motherboard.



Install only 1.5V or 0.8V AGP cards on this motherboard! This motherboard does not support 3.3V AGP cards.

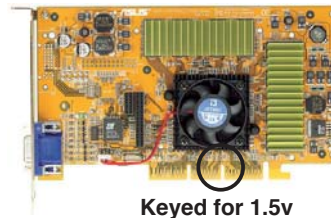
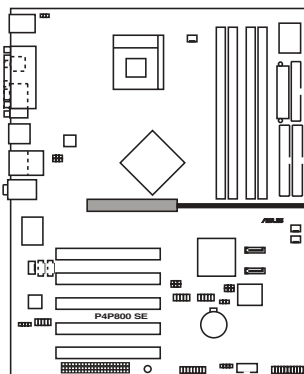

**P4P800 SE Accelerated Graphics Port (AGP)**



If installing the ATi 9500 or 9700 Pro Series VGA cards, use only the card version **PN xxx-xxxxx-30** or later, for optimum performance and overclocking stability.



## 2.5.6 Wi-Fi slot

The Wi-Fi (Wireless Fidelity) slot supports the ASUS WiFi-b™ module. Visit the ASUS website ([www.asus.com](http://www.asus.com)) for product updates.

The Wi-Fi slot conforms to the Institute of Electrical and Electronics Engineers (IEEE) 802.11b/g standard for wireless devices operating in the 2.4 GHz frequency band.

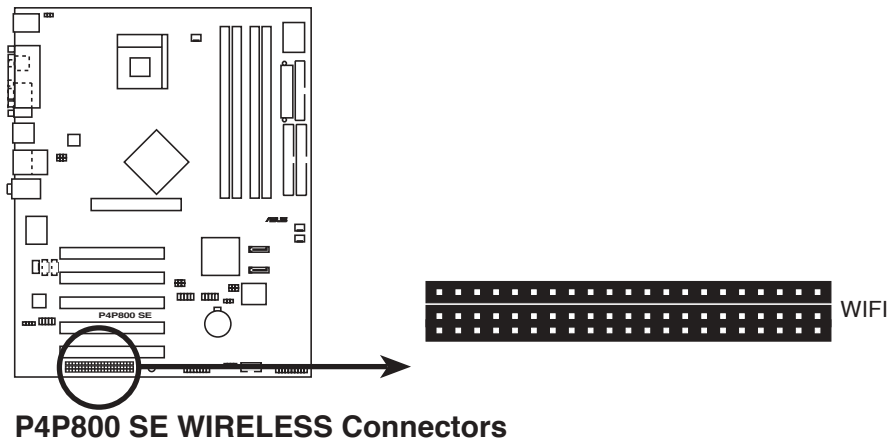

### ASUS WiFi-b™ Setup

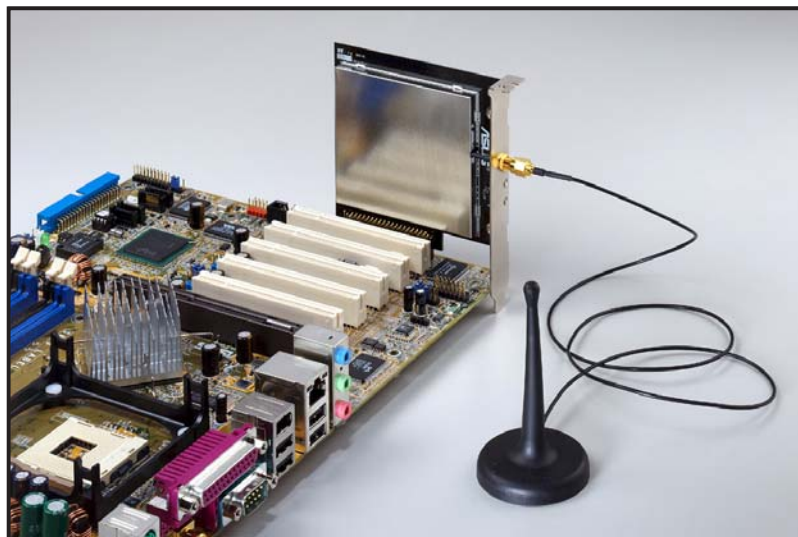

- The PCI 5 slot and the Wi-Fi slot can not be used at the same time.
- The ASUS WiFi-b™ module is purchased separately.

## 2.6 Jumpers

### 1. Clear RTC RAM (CLRRTC)

This jumper allows you to clear the Real Time Clock (RTC) RAM in CMOS. You can clear the CMOS memory of date, time, and system setup parameters by erasing the CMOS RTC RAM data. The RAM data in CMOS, that include system setup information such as system passwords, is powered by the onboard button cell battery.

To erase the RTC RAM:

1. Turn OFF the computer and unplug the power cord.
2. Remove the onboard battery.
3. Move the jumper from pins 1-2 (default) to pins 2-3. Keep the cap on pins 2-3 for about 5~10 seconds, then move the cap back to pins 1-2.
4. Replace the battery.
5. Plug the power cord and turn ON the computer.
6. Hold down the **<Del>** key during the boot process and enter BIOS setup to re-enter data.

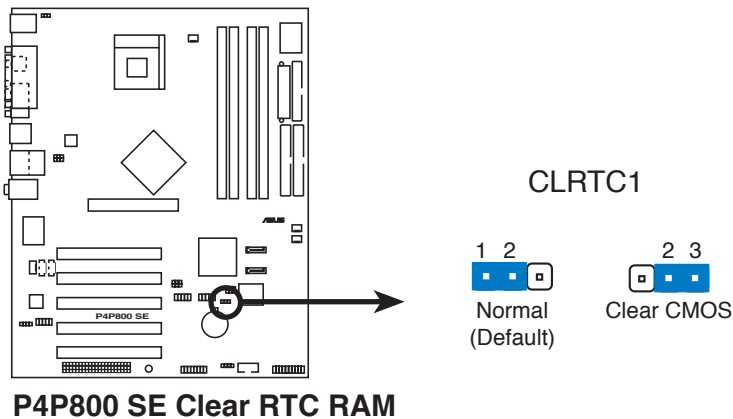

---

You do not need to clear the RTC when the system hangs due to overclocking. For system failure due to overclocking, use the C.P.R. (CPU Parameter Recall) feature. Shut down and reboot the system so BIOS can automatically reset parameter settings to default values.

---

## 2. USB device wake-up (3-pin USBPW12, USBPW34, USBPW56, USBPW78)

Set these jumpers to +5V to wake up the computer from S1 sleep mode (CPU stopped, DRAM refreshed, system running in low power mode) using the connected USB devices. Set to +5VSB to wake up from S3 and S4 sleep modes (no power to CPU, DRAM in slow refresh, power supply in reduced power mode).

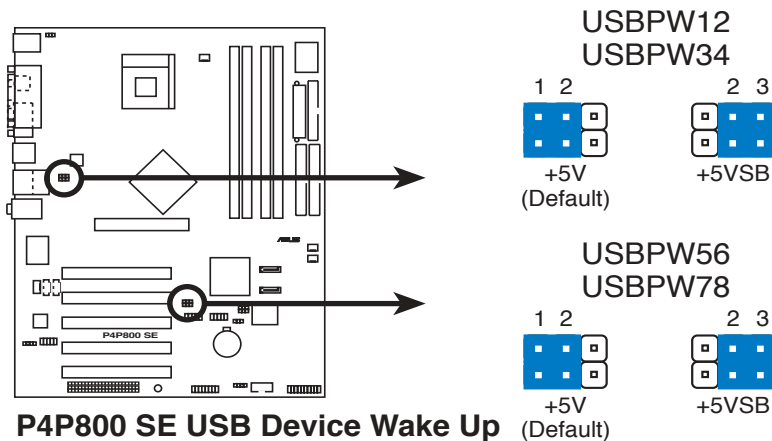

- The USB device wake-up feature requires a power supply that can provide 500mA on the +5VSB lead for each USB port. Otherwise, the system will not power up.
- The total current consumed must NOT exceed the power supply capability (+5VSB) whether under normal condition or in sleep mode.

### 3. Keyboard power (3-pin KBPWR)

This jumper allows you to enable or disable the keyboard wake-up feature. Set this jumper to pins 2-3 (+5VSB) if you wish to wake up the computer when you press a key on the keyboard (the default is the Space Bar). This feature requires an ATX power supply that can supply at least 1A on the +5VSB lead, and a corresponding setting in the BIOS (see section 4.5.1 Power Up Control).

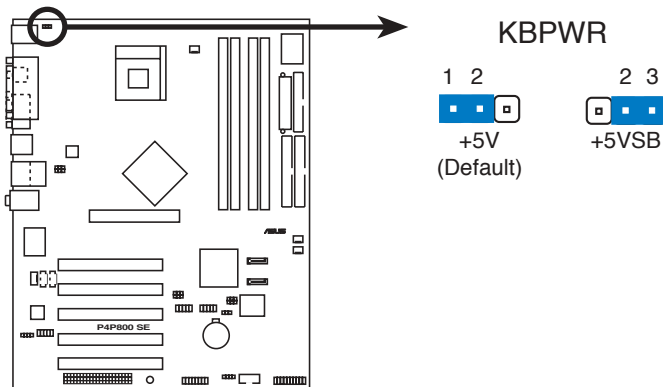

**P4P800 SE Keyboard Power Setting**

### 4. SMB2.0 (two 3-pin SMB20)

These jumpers allow you to enable or disable the SMBus 2.0 feature supported on the motherboard. By default, these jumpers are set to pins 2-3 to disable the feature. If you wish to install PCI devices that comply with SMBus 2.0 specification, move the jumper caps to pins 1-2 to enable the SMBus 2.0 feature.

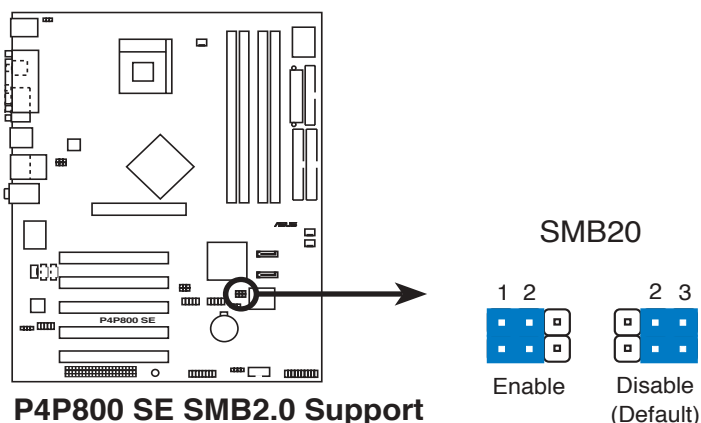

**P4P800 SE SMB2.0 Support**

## 2.7 Connectors

### 2.7.1 Rear panel connectors

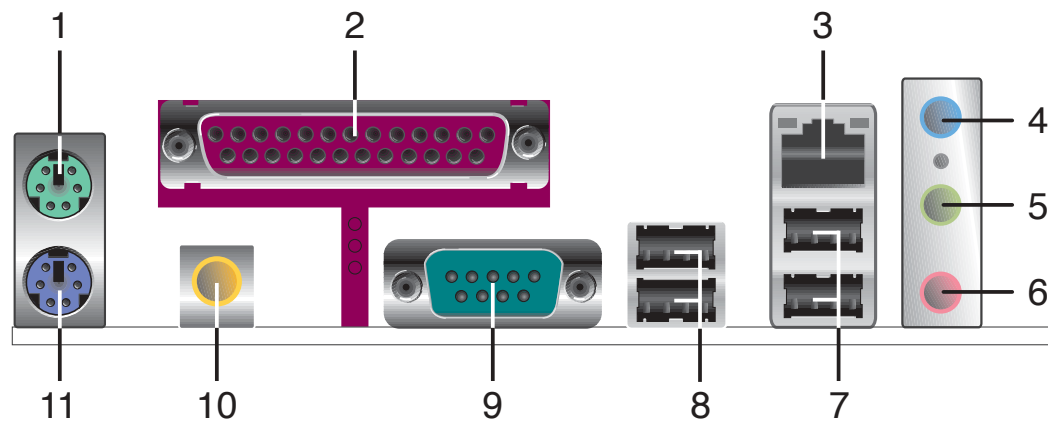

1. **PS/2 mouse port.** This green 6-pin connector is for a PS/2 mouse.
2. **Parallel port.** This 25-pin port connects a parallel printer, a scanner, or other devices.
3. **RJ-45 port.** This port allows connection to a Local Area Network (LAN) through a network hub.
4. **Line In jack.** This Line In (light blue) jack connects a tape player or other audio sources. In 4- and 6-channel modes, the function of this jack becomes Rear Speaker Out.
5. **Line Out jack.** This Line Out (lime) jack connects a headphone or a speaker. In 4- and 6-channel modes, the function of this jack becomes Front Speaker Out.
6. **Microphone jack.** This Mic (pink) jack connects a microphone. In 6-channel mode, the function of this jack becomes Bass/Center.
7. **USB 2.0 ports 3 and 4.** These two 4-pin Universal Serial Bus (USB) ports are available for connecting USB 2.0 devices.
8. **USB 2.0 ports 1 and 2.** These two 4-pin Universal Serial Bus (USB) ports are available for connecting USB 2.0 devices.
9. **Serial connector.** This 9-pin COM1 port is for serial devices.
10. **S/PDIF Coaxial out jack.** This jack connects to external audio output devices with coaxial cable connectors.
11. **PS/2 keyboard port.** This purple connector is for a PS/2 keyboard.

## Rear panel audio ports function variation

The functions of the Line Out (lime), Line In (blue), and Mic (pink) ports on the rear panel change when you select the 4-channel or 6-channel audio configuration as shown in the following table.

	Headphone/ 2-Speaker	4-Speaker	6-Speaker
Light Blue	Line In	Rear Speaker Out	Rear Speaker Out
Lime	Line Out	Front Speaker Out	Front Speaker Out
Pink	Mic In	Mic In	Bass/Center



---

Windows® 98SE only supports 4.1-channel speaker setting.

---

## 2.7.2 Internal connectors

### 1. Floppy disk drive connector (34-1 pin FLOPPY)

This connector supports the provided floppy drive ribbon cable. After connecting one end to the motherboard, connect the other end to the floppy drive. (Pin 5 is removed to prevent incorrect insertion when using ribbon cables with pin 5 plug).

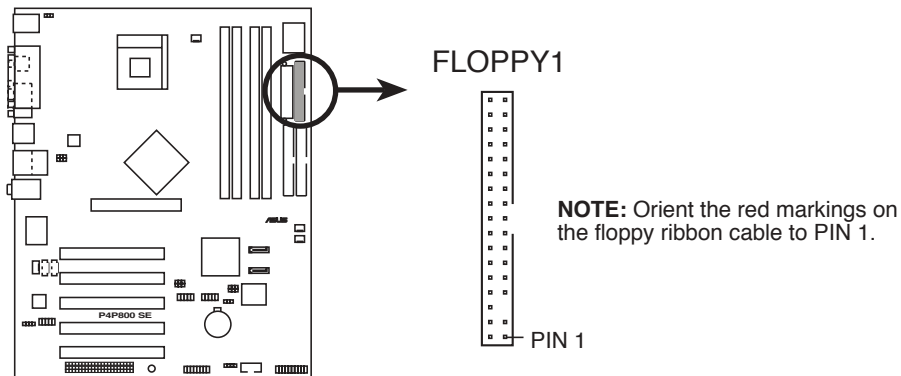

**P4P800 SE Floppy Disk Drive Connector**

### 2. IDE connectors (40-1 pin PRI\_IDE1, SEC\_IDE1)

This connector supports the provided UltraDMA100/66 IDE hard disk ribbon cable. Connect the cable's blue connector to the primary (recommended) or secondary IDE connector, then connect the gray connector to the UltraDMA100/66 slave device (hard disk drive) and the black connector to the UltraDMA100/66 master device.



1. Follow the hard disk drive documentation when setting the device in master or slave mode.
2. Pin 20 on each IDE connector is removed to match the covered hole on the UltraDMA cable connector. This prevents incorrect orientation when you connect the cables.
3. The hole near the blue connector on the UltraDMA cable is intentional.

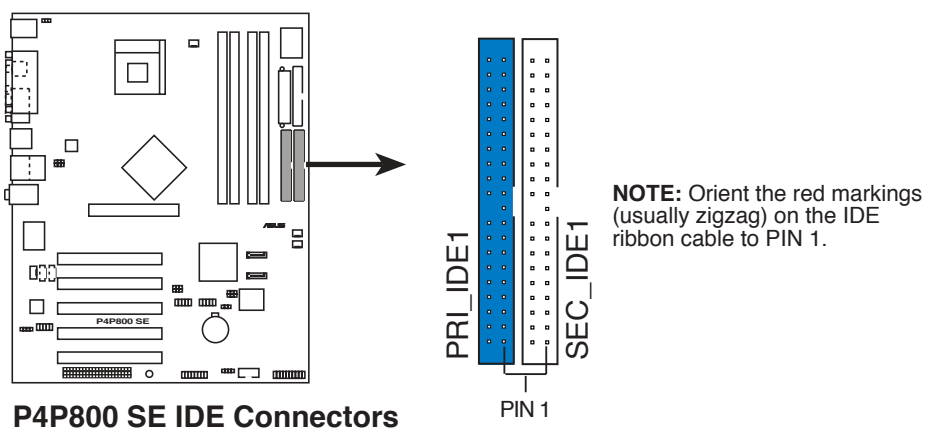

**P4P800 SE IDE Connectors**

### 3. Serial ATA connectors (7-pin SATA1, SATA2)

These next generation connectors support the thin Serial ATA cables for primary internal storage devices. The current Serial ATA interface allows up to 150 MB/s data transfer rate, faster than the standard parallel ATA with 133 MB/s (UltraDMA133).

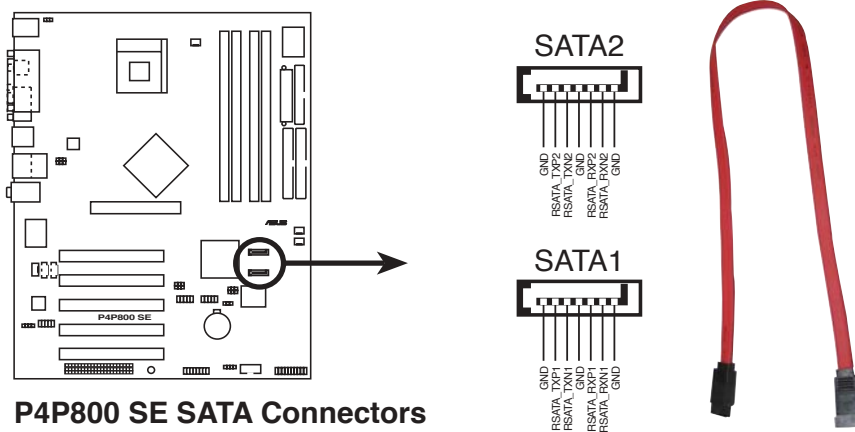

**P4P800 SE SATA Connectors**



#### Important notes on Serial ATA

- In a legacy operating system (DOS, Windows 98, Windows Me, Windows NT) environment, using the Serial ATA connectors will disable the ICHR chipset support to one of the IDE channels (either primary or secondary channel).
- The Serial ATA RAID feature (RAID 0,1) is available only if you are using Windows® XP and Windows® 2000.
- Hot plug support for Serial ATA drive and connections are not available in this motherboard.
- Install Windows® XP Service Pack 1 when using Serial ATA.



## Parallel ATA and Serial ATA device configurations

Following are the Parallel ATA and Serial ATA device configurations supported by Intel ICH5R specifications.

**Native** operating systems (OS) are Windows 2000/XP. ICH5R supports a maximum of six (6) devices using these OS.

**Legacy** OS are MS-DOS, Windows 98/Me/NT4.0. ICH5R supports a maximum of four (4) devices using these OS.

Operating System	P-ATA		S-ATA	
	Primary (2 devices)	Secondary (2 devices)	Port 0 (1 device)	Port 1 (1 device)
1. Windows 2000/XP	✓	✓	✓	✓
2. Windows 98/Me/NT4.0				
Configuration A	✓	—	✓	✓
Configuration B	—	✓	✓	✓
Configuration C	✓	✓	—	—

### Legend:

✓	Supported
—	Disabled

## Required IDE Configuration settings in BIOS

Refer to the following table for the appropriate BIOS settings of the above P-ATA and S-ATA device configurations. See section “4.3.6 IDE Configuration” for details on the related BIOS items.

BIOS item	Windows 2000/XP	Windows 98/Me/NT4.0		
		A	B	C
Onboard IDE Operate Mode	Enhanced Mode	Compatible Mode	Compatible Mode	Compatible Mode
Enhanced Mode Support On	S-ATA	—	—	—
IDE Port Settings	—	Primary P-ATA+S-ATA	Sec. P-ATA+S-ATA	P-ATA Ports Only

#### 4. CPU, Power and Chassis Fan Connectors (3-pin CPU\_FAN, PWR\_FAN, CHA\_FAN)

The fan connectors support cooling fans of 350mA~740mA (8.88W max.) or a total of 1A~2.22A (26.64W max.) at +12V. Connect the fan cables to the fan connectors on the motherboard, making sure that the black wire of each cable matches the ground pin of the connector.



Do not forget to connect the fan cables to the fan connectors. Lack of sufficient air flow within the system may damage the motherboard components. These are not jumpers! DO NOT place jumper caps on the fan connectors!

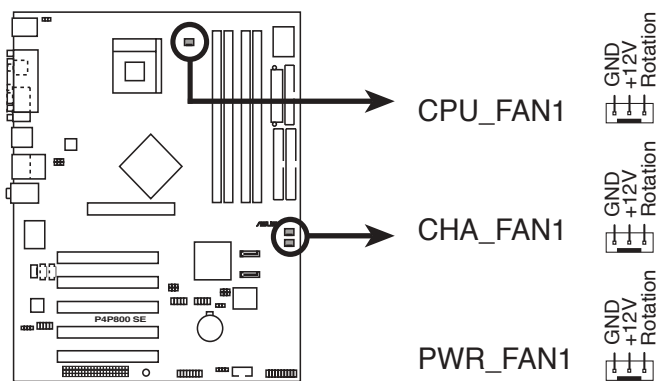

**P4P800 SE 12-Volt Fan Connectors**

#### 5. Serial Port 2 connector (10-1 pin COM2)

This connector accommodates a second serial port using a serial port bracket. Connect the bracket cable to this connector then install the bracket into a slot opening at the back of the system chassis.

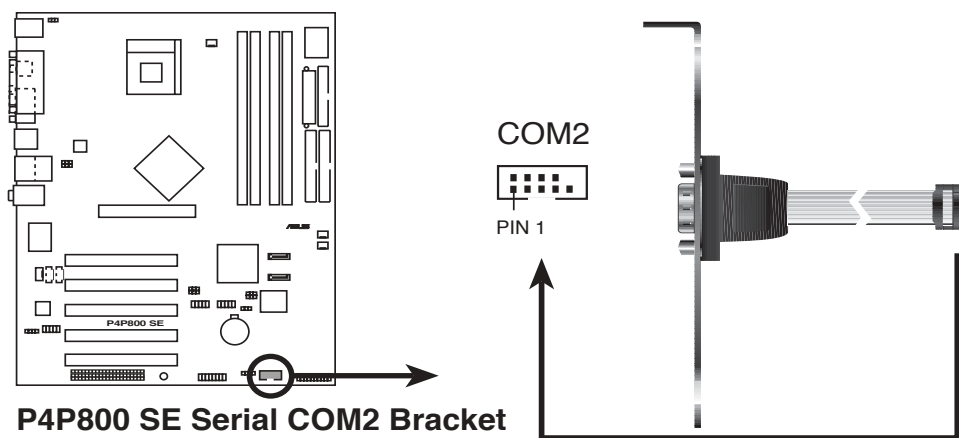

The serial port bracket is purchased separately.

## 6. ATX power connectors (20-pin ATXPWR, 4-pin ATX12V)

These connectors connect to an ATX 12V power supply. The plugs from the power supply are designed to fit these connectors in only one orientation. Find the proper orientation and push down firmly until the connectors completely fit.

In addition to the 20-pin ATX power connector, this motherboard requires that you connect the 4-pin ATX +12V power plug to provide sufficient power to the CPU.



1. Do not forget to connect the 4-pin ATX +12V power plug. Otherwise, the system does not boot up.
2. Make sure that your ATX 12V power supply can provide 8A on the +12V lead and at least 1A on the +5-volt standby lead (+5VSB). The minimum recommended wattage is 300W, or 350W for a fully configured system. The system may become unstable or may not boot up if the power is inadequate.

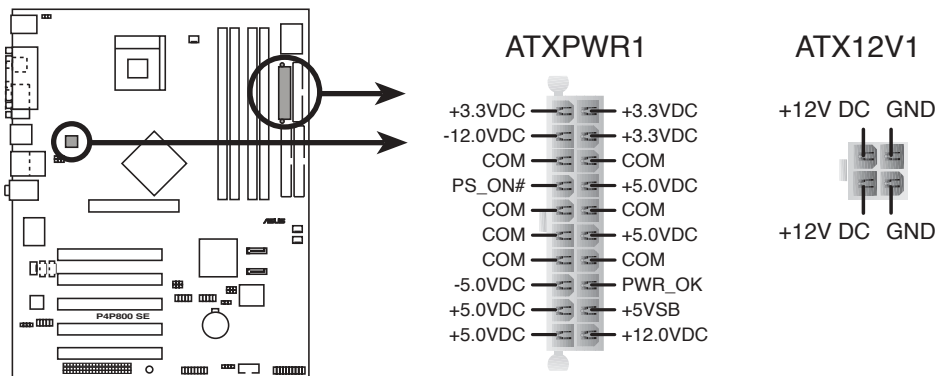

**P4P800 SE ATX Power Connector**

## 7. USB headers (10-1 pin USB\_56, USB\_78)

If the USB ports on the rear panel are inadequate, two USB headers are available for additional USB ports. The USB headers comply with USB 2.0 specification that supports up to 480 Mbps connection speed. This speed advantage over the conventional 12 Mbps on USB 1.1 allows faster Internet connection, interactive gaming, and simultaneous running of high-speed peripherals.



---

You must install the driver before you can use the USB 2.0 capability.

---

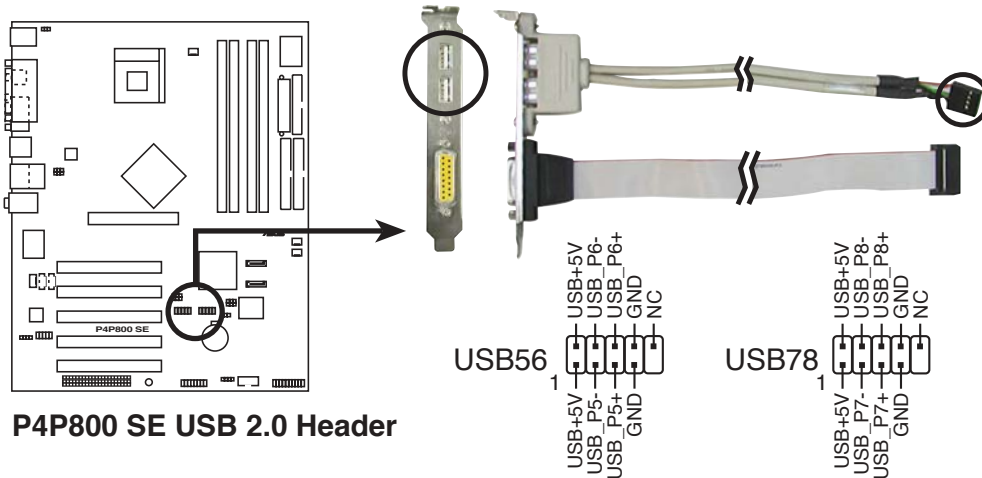

---

**NEVER** connect a 1394 cable to any of the USB (blue) connectors. Doing so will damage the motherboard!

---

## 8. Internal audio connectors (4-pin MODEM, CD, AUX)

These connectors allow you to receive stereo audio input from sound sources such as a CD-ROM, TV tuner, or MPEG card. The MODEM connector allows the onboard audio to interface with a voice modem card with a similar connector. It also allows the sharing of mono\_in (such as a phone) and a mono\_out (such as a speaker) between the audio and a voice modem card.

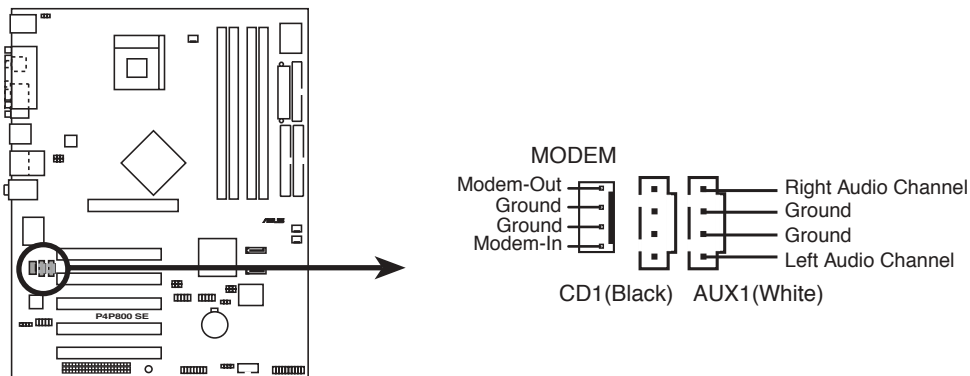

**P4P800 SE Internal Audio Connectors**

## 9. Front panel audio connector (10-1 pin FP\_AUDIO)

This is an interface for the front panel audio cable that allow convenient connection and control of audio devices.

By default, the pins labeled LINE\_OUT\_R/BLINE\_OUT\_R and the pins LINE\_OUT\_L/BLINE\_OUT\_L are shorted with jumper caps. Remove the caps only when you are connecting the front panel audio cable.

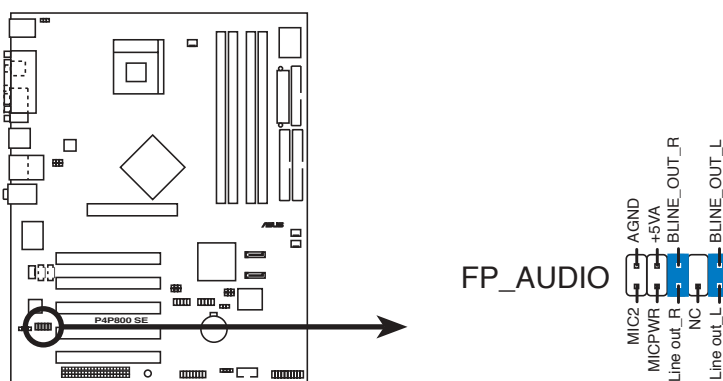

**P4P800 SE Front Panel Audio Connector**



The Front panel Line-Out connector and the Rear panel Line-Out jack can not work simultaneously.

## 10. GAME/MIDI connector (16-1 pin GAME)

This connector supports a GAME/MIDI module. If a GAME/MIDI module is available, connect the GAME/MIDI cable to this connector. The GAME/MIDI port on the module connects a joystick or a game pad for playing games, and MIDI devices for playing or editing audio files.

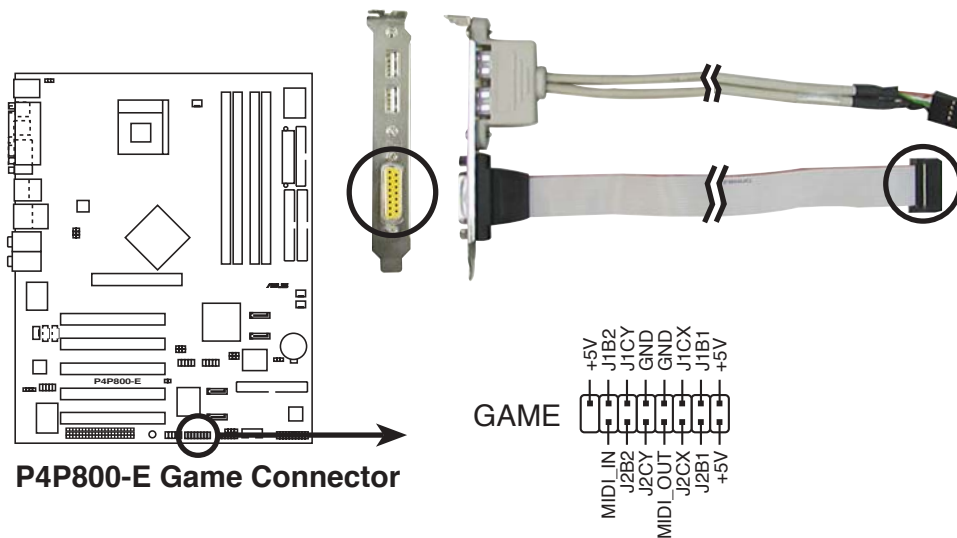

## 11. Chassis intrusion connector (4-1 pin CHASSIS)

This lead is for a chassis designed with intrusion detection feature. This requires an external detection mechanism such as a chassis intrusion sensor or microswitch. When you remove any chassis component, the sensor triggers and sends a high-level signal to this lead to record a chassis intrusion event.

By default, the pins labeled “Chassis Signal” and “Ground” are shorted with a jumper cap. If you wish to use the chassis intrusion detection feature, remove the jumper cap from the pins.

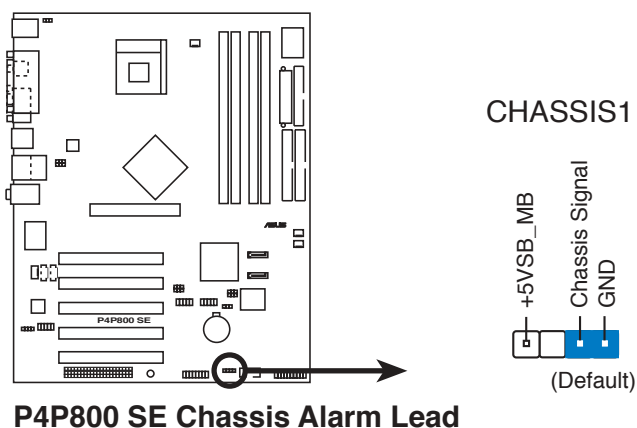

## 12. System panel connector (20-pin PANEL)

This connector accommodates several system front panel functions.

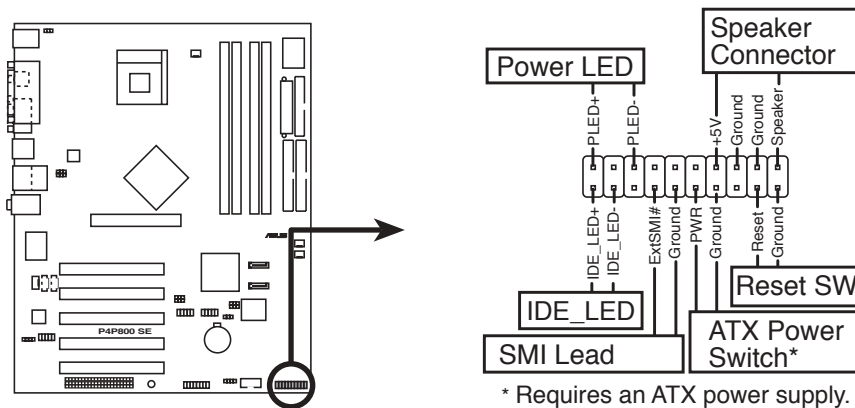

**P4P800 SE System Panel Connectors**

- **System Power LED Lead (Green 3-1 pin PLED)**  
This 3-1 pin connector connects to the system power LED. The LED lights up when you turn on the system power, and blinks when the system is in sleep mode.
- **System Warning Speaker Lead (Orange 4-pin SPKR)**  
This 4-pin connector connects to the case-mounted speaker and allows you to hear system beeps and warnings.
- **Reset Switch Lead (Blue 2-pin RESET)**  
This 2-pin connector connects to the case-mounted reset switch for rebooting the system without turning off the system power.
- **ATX Power Switch / Soft-Off Switch Lead (Yellow 2-pin PWRBTN)**  
This connector connects a switch that controls the system power. Pressing the power switch turns the system between ON and SLEEP, or ON and SOFT OFF, depending on the BIOS or OS settings. Pressing the power switch while in the ON mode for more than 4 seconds turns the system OFF.
- **System Management Interrupt Lead (Light Blue 2-pin SMI)**  
This 2-pin connector allows you to manually place the system into a suspended mode, or “green” mode, where system activity is instantly decreased to save power and to expand the life of certain system components. Attach the case-mounted suspend switch to this 2-pin connector.

- **Hard disk activity LED (Red 2-pin IDE\_LED)**

This connector supplies power to the hard disk activity LED. Any read or write activity of an IDE device cause this LED to light up.



---

The System Panel connector is color-coded for easy and foolproof connection. Take note of the specific connector colors as described.

---



# ***Chapter 3***

This chapter describes the power up sequence, the vocal POST messages and ways of shutting down the system.

## **Powering up**

## **Chapter summary**

- 3.1 Starting up for the first time ..... 3-1**
- 3.2 Powering off the computer ..... 3-2**

## 3.1 Starting up for the first time

1. After making all the connections, replace the system case cover.
2. Be sure that all switches are off.
3. Connect the power cord to the power connector at the back of the system chassis.
4. Connect the power cord to a power outlet that is equipped with a surge protector.
5. Turn on the devices in the following order:
  - a. Monitor
  - b. External SCSI devices (starting with the last device on the chain)
  - c. System power (if you are using an ATX power supply, you need to switch on the power supply as well as press the ATX power switch on the front of the chassis).
6. After applying power, the power LED on the system front panel case lights up. For ATX power supplies, the system LED lights up when you press the ATX power switch. If your monitor complies with “green” standards or if it has a “power standby” feature, the monitor LED may light up or switch between orange and green after the system LED turns on. The system then runs the power-on tests. While the tests are running, the BIOS beeps or additional messages appear on the screen. If you do not see anything within 30 seconds from the time you turned on the power, the system may have failed a power-on test. Check the jumper settings and connections or call your retailer for assistance.
7. At power on, hold down **<Del>** to enter BIOS Setup. Follow the instructions in Chapter 4.

## 3.2 Powering off the computer

### 3.2.1 Using the OS shut down function

If you are using Windows® 98/98SE/ME/2000:

1. Click the **Start** button then click **Shut Down...**
2. Make sure that the **Shut down** option button is selected, then click the **OK** button to shut down the computer.
3. The power supply should turn off after Windows shuts down.

If you are using Windows® XP:

1. Click the **Start** button then select **Turn Off Computer**.
2. Click the **Turn Off** button to shut down the computer.
3. The power supply should turn off after Windows shuts down.

### 3.2.2 Using the dual function power switch

While the system is ON, pressing the power switch for less than 4 seconds puts the system to sleep mode or to soft-off mode, depending on the BIOS setting. Pressing the power switch for more than 4 seconds lets the system enter the soft-off mode regardless of the BIOS setting. See section “4.5 Power Menu” in Chapter 4.

# ***Chapter 4***

This chapter tells how to change the system settings through the BIOS Setup menus. Detailed descriptions of the BIOS parameters are also provided.

## **BIOS setup**

## **Chapter summary**

<b>4.1</b>	<b>Managing and updating your BIOS .....</b>	<b>4-1</b>
<b>4.2</b>	<b>BIOS Setup program .....</b>	<b>4-9</b>
<b>4.3</b>	<b>Main menu .....</b>	<b>4-12</b>
<b>4.4</b>	<b>Advanced menu .....</b>	<b>4-16</b>
<b>4.5</b>	<b>Power menu .....</b>	<b>4-28</b>
<b>4.6</b>	<b>Boot menu .....</b>	<b>4-32</b>
<b>4.7</b>	<b>Exit menu .....</b>	<b>4-37</b>

## 4.1 Managing and updating your BIOS

The following utilities allow you to manage and update the motherboard Basic Input/Output System (BIOS) setup.

1. ASUS AFUDOS - Updates the BIOS using a bootable floppy disk in DOS mode.
2. ASUS EZ Flash - Updates the BIOS using a floppy disk during POST.
3. ASUS CrashFree BIOS 2 - Updates the BIOS using a bootable floppy disk or the motherboard support CD.
4. ASUS Update - Updates the BIOS in a Windows® environment.

Refer to the corresponding sections for details on these utilities.

### Important notes



---

Save a copy of the original motherboard BIOS file to a bootable floppy disk in case you need to restore the BIOS in the future. Copy the original motherboard BIOS using the ASUS Update or AFUDOS utilities.

Visit the ASUS website and download the latest BIOS file for this motherboard using the ASUS Update utility.

---

### 4.1.1 Creating a bootable floppy disk

1. Do either one of the following to create a bootable floppy disk.

#### DOS environment

Insert a 1.44 MB floppy disk into the drive. At the DOS prompt, type:

```
format A: /S then press <Enter>.
```

#### Windows® 98SE/ME/2000/XP environment

- a. Insert a 1.44 MB floppy disk into the floppy disk drive.
- b. From your Windows desktop, click on **Start**, then select **My Computer**.
- c. Select the **3 1/2 Floppy Drive** icon.
- d. Click **File** from the menu, then select **Format**. A **Format 3 1/2 Floppy Disk** window appears.
- e. If you are using Windows™ XP, select **Create an MS-DOS startup disk** from the format options field, then click **Start**.

OR

If you are using Windows® 98SE/ME/2000, select **Full** option button from the format type, then click **Start**.

2. Copy the original (or the latest) motherboard BIOS to the bootable floppy disk.

## 4.1.2 Using AFUDOS to update the BIOS

To update the BIOS using the AFUDOS.EXE utility:

1. Visit the ASUS website ([www.asus.com](http://www.asus.com)) to download the latest BIOS file for your motherboard. Save the BIOS file to a bootable floppy disk.



---

Write the BIOS file name on a piece of paper. You need to type the exact BIOS file name at the prompt.

---

2. Copy the AFUDOS.EXE utility from the support CD to the bootable floppy disk that contains the BIOS file.
3. Boot the system from the floppy disk.
4. At the DOS prompt, type the command line:

```
afudos /i[filename]
```

where **[filename]** means the latest (or original) BIOS file that you copied to the bootable floppy disk.

The screen displays the status of the update process.



---

The BIOS information on the screen is for reference only. What you see on your screen may not be exactly the same as shown.

---

```
A:\>afudos /iP4P800SE.rom
AMI Firmware Update Utility - Version 1.10
Copyright (C) 2002 American Megatrends, Inc. All rights reserved.

Reading file ..... done
Erasing flash .... done
Writing flash .... 0x0008CC00 (9%)
```



---

**DO NOT** shutdown or reset the system while updating the BIOS! Doing so may cause system boot failure!

---



When the BIOS update process is complete, the utility returns to the DOS prompt.

```
A:\>afudos /iP4P800SE.rom
AMI Firmware Update Utility - Version 1.10
Copyright (C) 2002 American Megatrends, Inc. All rights reserved.

Reading file ..... done
Erasing flash .... done
Writing flash .... 0x0008CC00 (9%)
Verifying flash .. done

A:\>
```

5. Reboot the system from the hard disk.

### 4.1.3 Using AFUDOS to copy BIOS from PC

You can use the AFUDOS.EXE utility to copy the current system BIOS to a floppy or hard disk and use it as backup in case the system BIOS fails or gets corrupted.

To copy the BIOS from your PC using AFUDOS:

1. At the DOS prompt, type the command line:

```
afudos /o[filename]
```

where **[filename]** is a string of not more than eight (8) alpha-numeric characters for the main filename and three (3) alpha-numeric characters for the extension name.

Press **<Enter>**.



---

The BIOS information on the screen is for reference only. What you see on your screen may not be exactly the same as shown.

---

Main filename  
Extension name

```
A:\>afudos /oMYBIOS03.rom
AMI Firmware Update Utility - Version 1.10
Copyright (C) 2002 American Megatrends, Inc. All rights reserved.

Reading flash ..... 0x0008CC00 (9%)
```

2. The utility will copy the current system BIOS by default to the floppy disk. Make sure that the floppy disk has at least 600KB free space to store the file, and is not write-protected.

```
A:\>afudos /oMYBIOS03.rom
AMI Firmware Update Utility - Version 1.10
Copyright (C) 2002 American Megatrends, Inc. All rights reserved.

Reading flash ..... done

A:\>
```

When the copy process is complete, the utility returns to the DOS prompt.

#### 4.1.4 Using ASUS EZ Flash to update the BIOS

The ASUS EZ Flash feature allows you to easily update the BIOS without having to go through the long process of booting from a diskette and using a DOS-based utility. The EZ Flash is built-in the BIOS firmware so it is accessible by simply pressing **<Alt + F2>** during the Power-On Self Tests (POST).

##### To update the BIOS using ASUS EZ Flash:

1. Visit the ASUS website ([www.asus.com](http://www.asus.com)) to download the latest BIOS file for your motherboard and rename the downloaded file as **P4P800SE.ROM**. Save the BIOS file to a floppy disk.
2. Reboot the system.
3. To launch EZ Flash, press **<Alt+F2>** during POST to display the following.

```
User recovery requested. Starting BIOS recovery...
Checking for floppy...
```



1. If there is no floppy disk in the drive, the error message “Floppy not found!” appears.
2. If the correct BIOS file is not in the floppy disk, the error message “Floppy not found!” is displayed. Make sure to rename the downloaded BIOS file as “P4P800SE.ROM”.

4. Insert the floppy disk that contains the BIOS file. If all the necessary files are found in the floppy disk, EZ Flash performs the BIOS update process and automatically reboots the system when done.



---

DO NOT shutdown or reset the system while updating the BIOS! Doing so may cause system boot failure!

---

```
User recovery requested. Starting BIOS recovery...
Checking for floppy...
Floppy found!
Reading file "P4P800SE.rom". Completed.
Start flashing...
Flashed successfully. Rebooting.
```

## 4.1.5 Recovering the BIOS with CrashFree BIOS 2

The CrashFree BIOS 2 auto recovery tool allows you to restore BIOS from the motherboard support CD, or from a floppy disk that contains the BIOS file, in case the current BIOS on the motherboard fails or gets corrupted.



1. Prepare the support CD that came with the motherboard or a floppy disk that contains the motherboard BIOS before proceeding with the BIOS update process.
  2. If you have saved a copy of the original motherboard BIOS to a bootable floppy disk, you may also use this disk to restore the BIOS. See section "4.1.1 Creating a bootable floppy disk."
- 

### To recover the BIOS from a floppy disk:

1. Boot the system.
2. When a corrupted BIOS is detected, the following screen message appears.

```
Bad BIOS checksum. Starting BIOS recovery...
Checking for floppy...
```

3. Insert a floppy disk that contains the original or the latest BIOS file for this motherboard. If all the necessary files are found in the floppy disk, the BIOS update process continues.



---

Make sure that the BIOS file in the floppy disk is renamed as "P4P800SE.ROM".

---

```
Bad BIOS checksum. Starting BIOS recovery...
Checking for floppy...
Floppy found!
Reading file "P4P800SE.ROM". Completed.
Start flashing...
```



---

DO NOT shutdown or reset the system while updating the BIOS! Doing so may cause system boot failure!

---

4. When the BIOS update process is complete, reboot the system.

### To recover the BIOS from the support CD:

1. Boot the system.
2. When a corrupted BIOS is detected, the following screen message appears.

```
Bad BIOS checksum. Starting BIOS recovery...
Checking for floppy...
```



---

If there is no floppy disk found in the drive, the system automatically checks the CD-ROM.

---

3. Place the support CD in the CD-ROM. The support CD contains the original BIOS for this motherboard.

```
Bad BIOS checksum. Starting BIOS recovery...
Checking for floppy...
Floppy not found!
Checking for CD-ROM...
CD-ROM found.
Reading file "P4P800SE.ROM". Completed.
Start flashing...
```



---

DO NOT shutdown or reset the system while updating the BIOS! Doing so may cause system boot failure!

---

4. When the BIOS update process is complete, reboot the system.



---

The recovered BIOS may not be the latest BIOS version for this motherboard. Visit ASUS website ([www.asus.com](http://www.asus.com)) to download the latest BIOS file.

---

## 4.1.6 ASUS Update

The ASUS Update is a utility that allows you to update the motherboard BIOS in Windows® environment. This utility is available in the support CD that comes with the motherboard package. ASUS Update requires an Internet connection either through a network or an Internet Service Provider (ISP).

To install ASUS Update:

1. Insert the support CD into the CD-ROM drive. The **Drivers** menu appears.
2. Click the **Utilities** tab, then click **Install ASUS Update VX.XX.XX**. See page 5-3 for the **Utilities** menu screen.
3. The ASUS Update utility is copied into your system.

To update the BIOS using ASUS Update:

1. Launch the utility from the Windows desktop by clicking **Start > Programs > ASUS > ASUSUpdate > ASUSUpdate**. The ASUS Update initial screen appears.
2. Select your desired update method, then click **Next**.

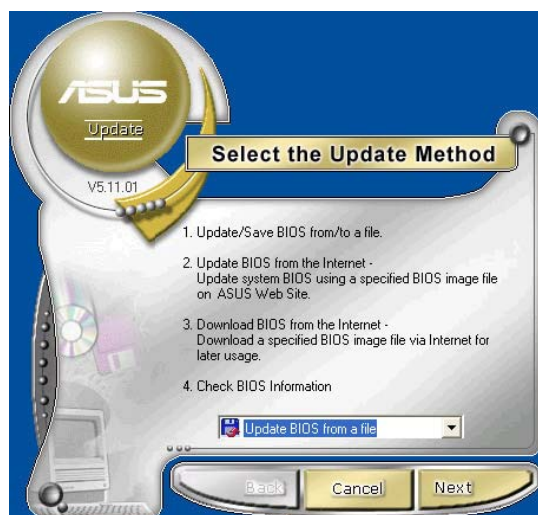

3. If you selected updating/downloading from the Internet, select the ASUS FTP site nearest you to avoid network traffic, or choose **Auto Select**. Click **Next**.

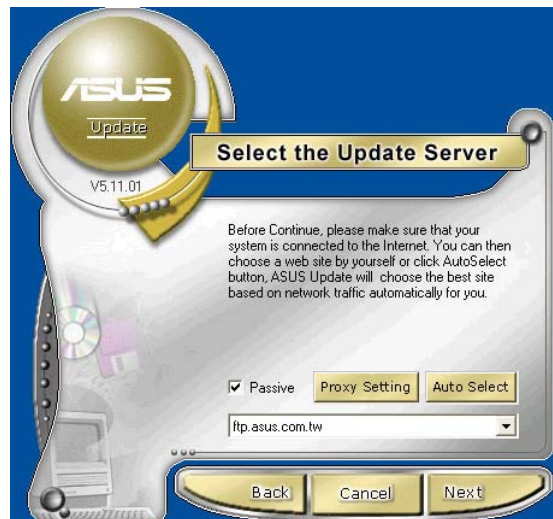

4. From the FTP site, select the BIOS version that you wish to download. Click **Next**.
5. Follow the instructions on the succeeding screens to complete the update process.

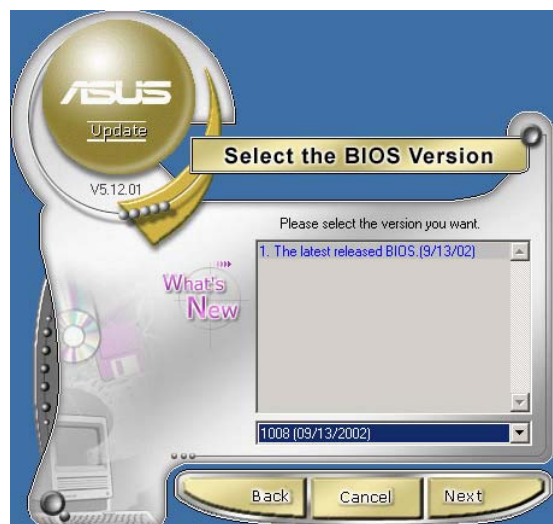

If you selected the option to update the BIOS from a file, a window prompts you to locate the file. Select the file, click **Save**, then follow the screen instructions to complete the update process.

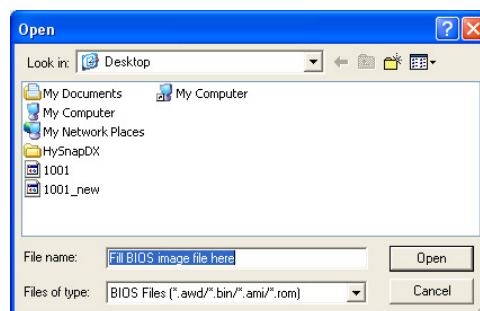

## 4.2 BIOS Setup program

This motherboard supports a programmable firmware chip that you can update using the provided utility described in section “4.1 Managing and updating your BIOS.”

Use the BIOS Setup program when you are installing a motherboard, reconfiguring your system, or prompted to “Run Setup”. This section explains how to configure your system using this utility.

Even if you are not prompted to use the Setup program, you may want to change the configuration of your computer in the future. For example, you may want to enable the security password feature or change the power management settings. This requires you to reconfigure your system using the BIOS Setup program so that the computer can recognize these changes and record them in the CMOS RAM of the firmware hub.

The firmware hub on the motherboard stores the Setup utility. When you start up the computer, the system provides you with the opportunity to run this program. Press **<Delete>** during the Power-On Self Test (POST) to enter the Setup utility. Otherwise, POST continues with its test routines.

If you wish to enter Setup after POST, restart the system by pressing **<Ctrl+Alt+Delete>**, or by pressing the reset button on the system chassis. You can also restart by turning the system off and then back on. Do this last option only if the first two failed.

The Setup program is designed to make it as easy to use as possible. It is a menu-driven program, which means you can scroll through the various sub-menus and make your selections from the available options using the navigation keys.



---

The default BIOS settings for this motherboard apply for most conditions to ensure optimum performance. If the system becomes unstable after changing any BIOS settings, load the default settings to ensure system compatibility and stability. Select the **Load Default Settings** item under the Exit Menu. See section “4.7 Exit Menu.”

---



1. The BIOS setup screens shown in this chapter are for reference purposes only, and may not exactly match what you see on your screen.
  2. Visit the ASUS website ([www.asus.com](http://www.asus.com)) to download the latest product and BIOS information.
-



## 4.2.1 BIOS menu screen

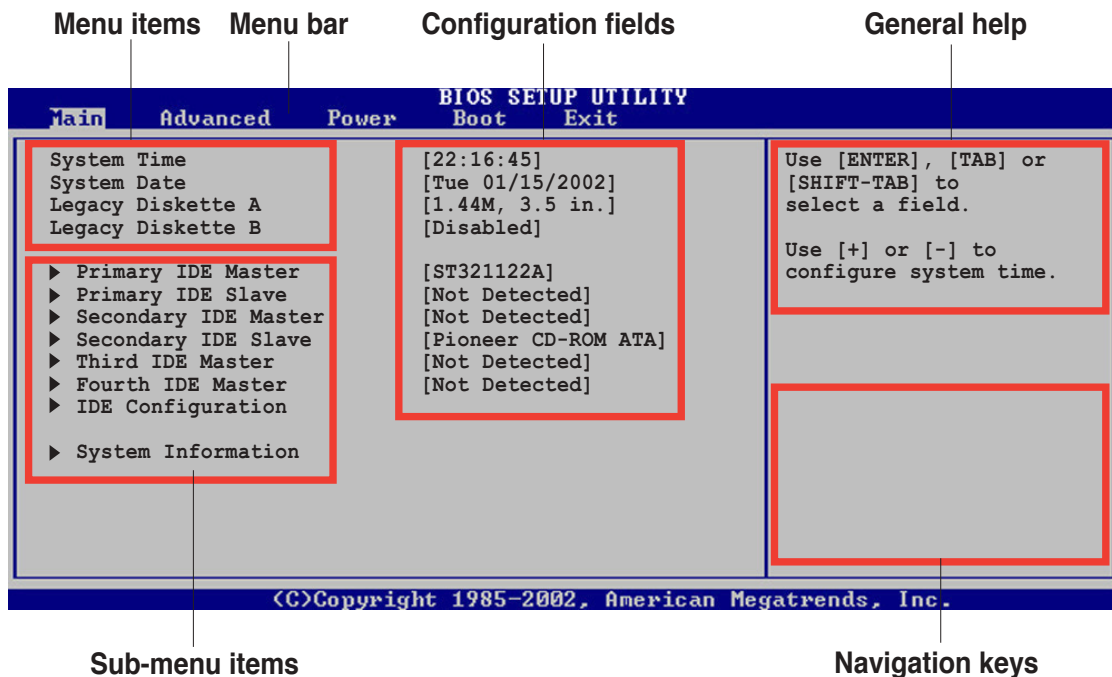

## 4.2.2 Menu bar

The menu bar on top of the screen has the following main items:

- Main** For changing the basic system configuration
- Advanced** For changing the advanced system settings
- Power** For changing the advanced power management (APM) configuration
- Boot** For changing the system boot configuration
- Exit** For selecting the exit options and loading default settings

To select an item on the menu bar, press the right or left arrow key on the keyboard until the desired item is highlighted.

## 4.2.3 Navigation keys

At the **bottom right corner** of a menu screen are the navigation keys for that particular menu. Use the navigation keys to select items in the menu and change the settings.



Some of the navigation keys differ from one screen to another.



## 4.2.4 Menu items

The highlighted item on the menu bar displays the specific items for that menu. For example, selecting **Main** shows the Main menu items.

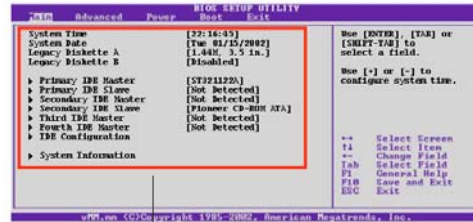

Main menu items

The other items (Advanced, Power, Boot, and Exit) on the menu bar have their respective menu items.

## 4.2.5 Sub-menu items

An item with a sub-menu on any menu screen is distinguished by a solid triangle before the item. To display the sub-menu, select the item and press Enter.

## 4.2.6 Configuration fields

These fields show the values for the menu items. If an item is user-configurable, you may change the value of the field opposite the item. You can not select an item that is not user-configurable.

A configurable field is enclosed in brackets, and is highlighted when selected. To change the value of a field, select it then press Enter to display a list of options. Refer to “4.2.7 Pop-up window.”

## 4.2.7 Pop-up window

Select a menu item then press Enter to display a pop-up window with the configuration options for that item.

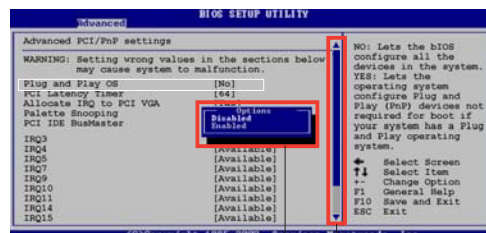

Pop-up window

Scroll bar

## 4.2.8 Scroll bar

A scroll bar appears on the right side of a menu screen when there are items that do not fit on the screen.

Press **Up/Down arrow keys** or **PageUp/PageDown keys** to display the other items on the screen.

## 4.2.9 General help

At the top right corner of the menu screen is a brief description of the selected item.

## 4.3 Main menu

When you enter the BIOS Setup program, the Main menu screen appears, giving you an overview of the basic system information.



Refer to section “4.2.1 BIOS menu screen” for information on the menu screen items and how to navigate through them.

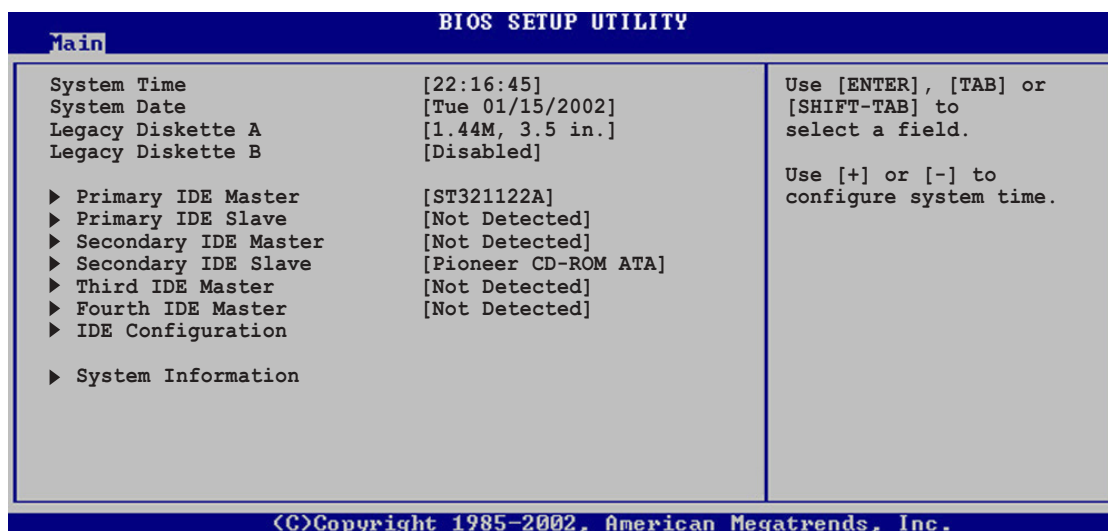

### 4.3.1 System Time [xx:xx:xxxx]

Allows you to set the system time

### 4.3.2 System Date [Day xx/xx/xxxx]

Allows you to set the system date

### 4.3.3 Legacy Diskette A [1.44M, 3.5 in.]

Sets the type of floppy drive installed. Configuration options: [Disabled] [360K, 5.25 in.] [1.2M, 5.25 in.] [720K, 3.5 in.] [1.44M, 3.5 in.] [2.88M, 3.5 in.]

### 4.3.4 Language [English]

Allows you to choose the BIOS language version from the options. Configuration options: [Français] [German] [English]

## 4.3.5 Primary and Secondary IDE Master/Slave; Third and Fourth IDE Master

While entering Setup, BIOS auto-detects the presence of IDE devices. There is a separate sub-menu for each IDE device. Select a device item then press Enter to display the IDE device information.

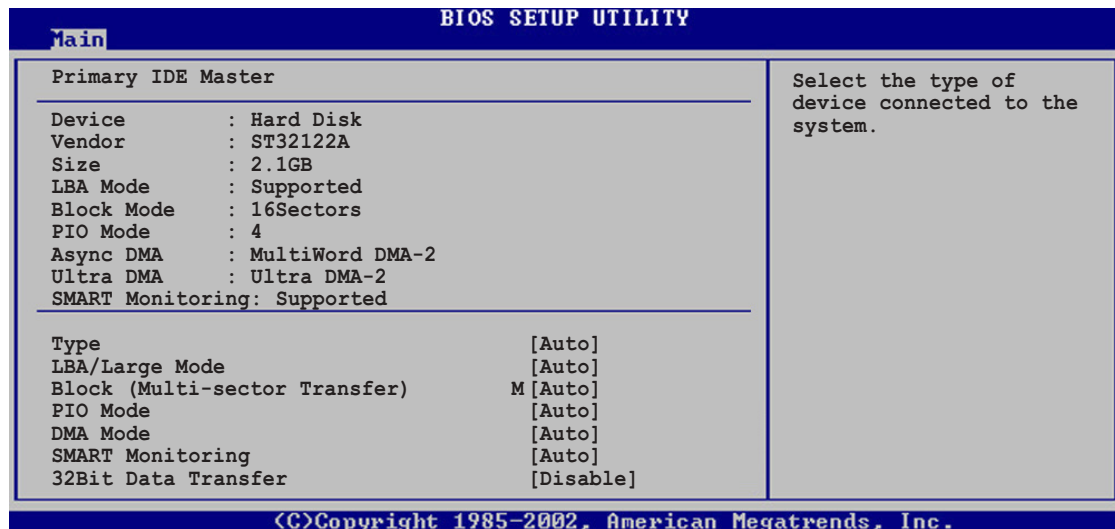

The values opposite the dimmed items (Device, Vendor, Size, LBA Mode, Block Mode, PIO Mode, Async DMA, Ultra DMA, and SMART monitoring) are auto-detected by BIOS and are not user-configurable. These items show N/A if no IDE device is installed in the system.

### Type [Auto]

Selects the type of IDE drive. Setting to Auto allows automatic selection of the appropriate IDE device type. Select CDROM if you are specifically configuring a CD-ROM drive. Select ARMD (ATAPI Removable Media Device) if your device is either a ZIP, LS-120, or MO drive. Configuration options: [Not Installed] [Auto] [CDROM] [ARMD]

### LBA/Large Mode [Auto]

Enables or disables the LBA mode. Setting to Auto enables the LBA mode if the device supports this mode, and if the device was not previously formatted with LBA mode disabled. Configuration options: [Disabled] [Auto]

### Block (Multi-sector Transfer) [Auto]

Enables or disables data multi-sectors transfers. When set to Auto, the data transfer from and to the device occurs multiple sectors at a time if the device supports multi-sector transfer feature. When set to Disabled, the data transfer from and to the device occurs one sector at a time. Configuration options: [Disabled] [Auto]

### PIO Mode [Auto]

Selects the PIO mode. Configuration options: [Auto] [0] [1] [2] [3] [4]

### DMA Mode [Auto]

Selects the DMA mode. Configuration options: [Auto] [SWDMA0] [SWDMA1] [SWDMA2] [MWDMA0] [MWDMA1] [MWDMA2] [UDMA0] [UDMA1] [UDMA2] [UDMA3] [UDMA4] [UDMA5]

### SMART Monitoring [Auto]

Sets the Smart Monitoring, Analysis, and Reporting Technology. Configuration options: [Auto] [Disabled] [Enabled]

### 32Bit Data Transfer [Disabled]

Enables or disables 32-bit data transfer. Configuration options: [Disabled] [Enabled]

## 4.3.6 IDE Configuration

The items in this menu allow you to set or change the configurations for the IDE devices installed in the system. Select an item then press Enter if you wish to configure the item.

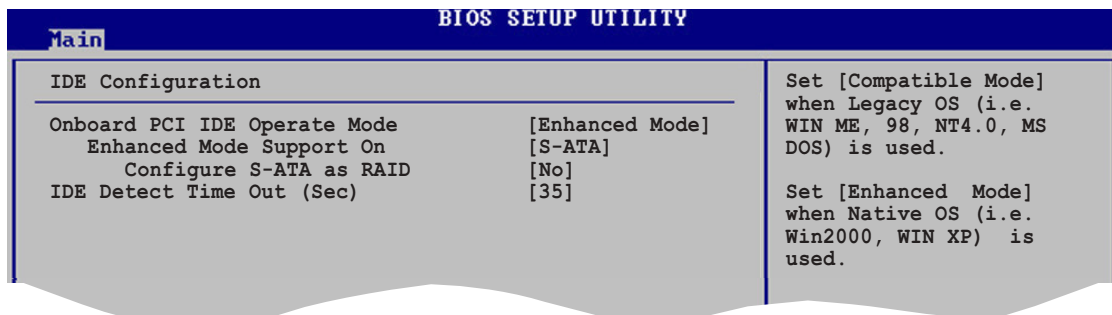

### **Onboard IDE Operate Mode [Enhanced Mode]**

Allows selection of the IDE operation mode depending on the operating system (OS) that you installed. Set to Enhanced Mode if you are using native OS, such as Windows 2000/XP. Set to Compatible Mode if you are using legacy OS including MS-DOS, Windows ME/98/NT4.0.

Configuration options: [Compatible Mode] [Enhanced Mode]

### Enhanced Mode Support On [S-ATA]

The default setting S-ATA allows you to use native OS on Serial ATA and Parallel ATA ports. We recommend that you do not change the default setting for better OS compatibility. In this setting, you may use legacy OS on the Parallel ATA ports **only if** you did not install any Serial ATA device.

The P-ATA+S-ATA and P-ATA options are for advanced users only. If you set to any of these options and encounter problems, revert to the default setting **S-ATA**.

Configuration options: [P-ATA+S-ATA] [S-ATA] [P-ATA]



---

The **Enhanced Mode Support On** appears only when the item **Onboard IDE Operate Mode** is set to **Enhanced Mode**.

---

#### IDE Port Settings [Primary P-ATA+S-ATA]

Allows selection of the IDE ports to activate if you are using a **legacy** operating system. Set to [Primary P-ATA+S-ATA] if you wish to use the primary Parallel ATA and Serial ATA ports, or set to [Secondary P-ATA+SATA] to enable the secondary P-ATA port instead. Setting to [P-ATA Ports Only] disables the two Serial ATA ports supported by ICH5. Configuration options: [Primary P-ATA+S-ATA] [Secondary P-ATA+S-ATA] [P-ATA Ports Only]



---

The **IDE Port Settings** appears only when the item **Onboard IDE Operate Mode** is set to **Compatible Mode**.

---

#### Configure S-ATA as RAID [No]

This field configures the S-ATA to function as an IDE controller or RAID. Configuration options: [Yes] [No]

#### Serial ATA BOOTROM [Enabled]

This field enables or disables the Serial ATA boot ROM. Configuration options: [Disabled] [Enabled]



---

The **Serial ATA BOOTROM** item appears only when the item **Configure S-ATA as RAID** is set to **[Yes]**.

---

### **IDE Detect Time Out [35]**

Selects the time out value for detecting ATA/ATAPI devices. Configuration options: [0] [5] [10] [15] [20] [25] [30] [35]

## 4.3.7 System Information

This menu gives you an overview of the general system specifications. The items in this menu are auto-detected by BIOS.

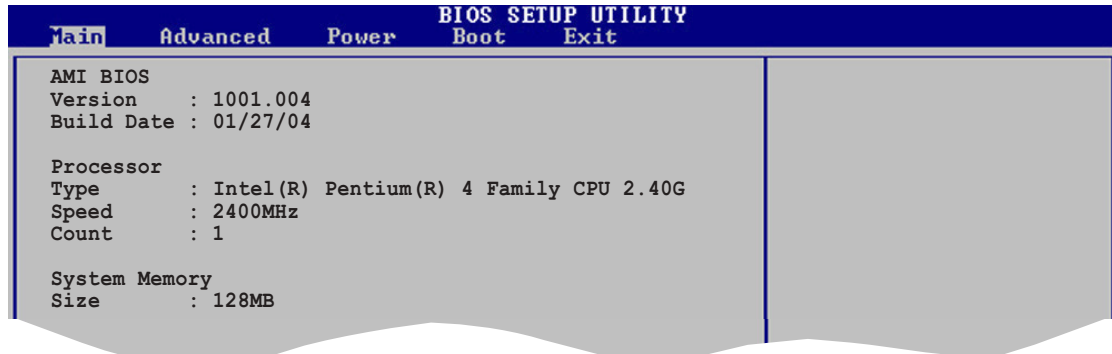

### AMI BIOS

Displays the auto-detected BIOS information

### Processor

Displays the auto-detected CPU specification

### System Memory

Displays the auto-detected system memory

## 4.4 Advanced menu

The Advanced menu items allow you to change the settings for the CPU and other system devices.



Take caution when changing the settings of the Advanced menu items. Incorrect field values may cause the system to malfunction.

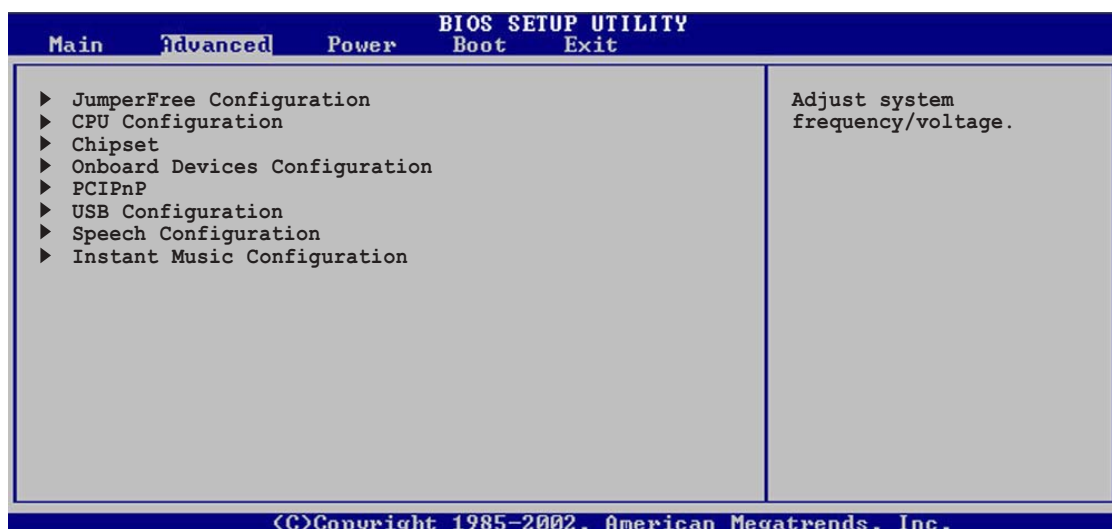

## 4.4.1 JumperFree Configuration

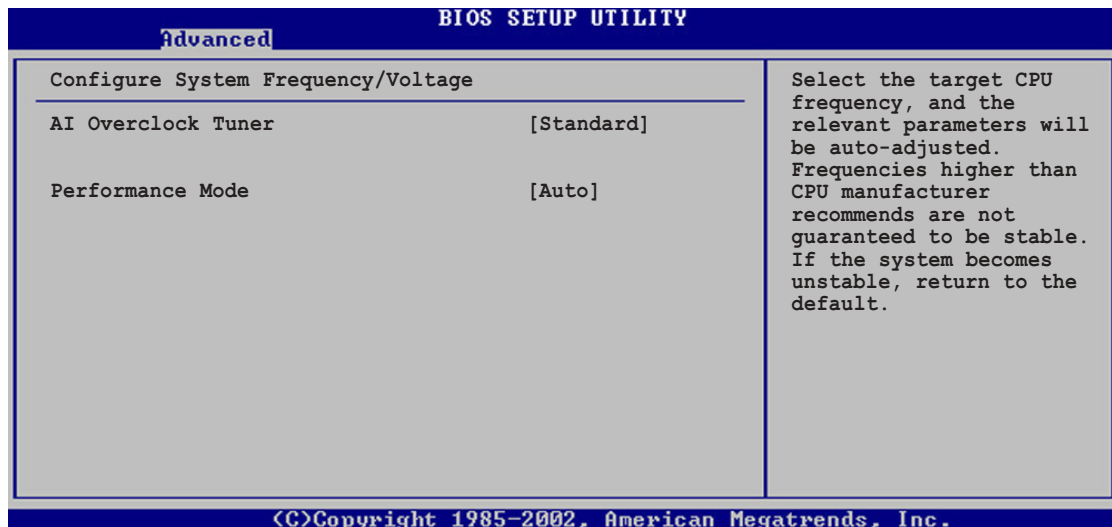

### AI Overclock Tuner [Standard]

Allows selection of CPU overclocking options to achieve desired CPU internal frequency. Select either one of the preset overclocking options. Configuration options: [Manual] [Standard] [Overclock 5%] [Overclock 10%] [Overclock 20%] [Overclock 30%]



Selecting a very high CPU frequency may cause the system to become unstable! If this happens, revert to the default setting.



If you are using an unlocked CPU, the item **CPU Ratio** appears under the AI Overclock Tuner item. You may select your desired ratio from the available options.

### CPU Ratio [12]

This field sets the ratio between the CPU Core Clock and the Front Side Bus (FSB) Frequency.



If an invalid ratio is set in CMOS, the actual and setpoint values may differ.

### Performance Mode [Auto]

Allows enhanced system performance. Setting to [Turbo] may cause the system to become unstable. If this happens, revert to the default setting [Auto]. Configuration options: [Auto] [Standard] [Turbo]



When you set the **AI Overclocking Tuner** item to [Manual], the related overclocking items appear.

Advanced		BIOS SETUP UTILITY
Configure System Frequency/Voltage		Select the target CPU frequency, and the relevant parameters will be auto-adjusted. Frequencies higher than CPU manufacturer recommends are not guaranteed to be stable. If the system becomes unstable, return to the default.
AI Overclock Tuner	[Manual]	
CPU External Frequency (MHz)	[133]	
DRAM Frequency	[Auto]	
AGP/PCI Frequency (MHz)	[Auto]	
CPU VCore Voltage	[Auto]	
DDR Reference Voltage	[Auto]	
AGP VDDQ Voltage	[1.50V]	
Performance Mode	[Auto]	

### CPU External Frequency (MHz) [XXX] (value is auto-detected)

Indicates the frequency sent by the clock generator to the system bus and PCI bus. The bus frequency (external frequency) multiplied by the bus multiple equals the CPU speed. The value of this item is auto-detected by BIOS and is not manually configurable. The values range from 100 to 400. Refer to the following table for the correct Front Side Bus and CPU External Frequency settings. Use the <+> and <-> keys to adjust the FSB.

Table 4.4.1 FSB/CPU External Frequency Synchronization

Front Side Bus	CPU External Frequency
FSB 800	200 MHz
FSB 533	133 MHz
FSB 400	100 MHz

### DRAM Frequency [Auto]

Allows you to set the DDR operating frequency. Configuration options: [266 MHz] [333 MHz] [400 MHz] [500 MHz] [533 MHz] [Auto]

### AGP/PCI Frequency (MHz) [Auto]

Allows you to adjust to a higher AGP/PCI frequency for better system performance and overclocking capability. Configuration options: [Auto] [66.66/33.33] [72.73/36.36] [80.00/40.00]



Selecting a very high AGP/PCI frequency may cause the system to become unstable! If this happens, revert to the default setting.

### CPU VCore Voltage [Auto]

Allows you to select a specific CPU VCore voltage. Configuration options: [Auto] [1.9500V] [1.9250V] [1.9000V] [1.8750V] [1.8500V] [1.8250V] [1.8000V] [1.7750V] [1.7500V] [1.7250V] [1.7000V] [1.6750V] [1.6500V] [1.6250] [1.6000V] [1.5875V] [1.5750V] [1.5625V] [1.5500V] [1.5375V] [1.5250V] [1.5125V] [1.5000V]





Refer to the CPU documentation before setting the CPU VCore voltage. A very high Vcore voltage may severely damage the CPU!

### **DDR Reference Voltage [Auto]**

Allows selection of the DDR SDRAM operating voltage. Configuration options: [2.85V] [2.75V] [2.65V] [2.55V] [Auto]

### **AGP VDDQ voltage [1.50V]**

Allows selection of the AGP operating voltage. Configuration options: [1.80V] [1.70V] [1.60V] [1.50V]

## **4.4.2 CPU Configuration**

The items in this menu show the CPU-related information auto-detected by BIOS.

Advanced		BIOS SETUP UTILITY	
Configure advanced CPU settings		Selects the VID setting at which the processor is to run.	
Manufacturer	: Intel(R)		
Brand String	: Intel(R) Pentium(R) 4 Family CPU 2.4G		
Frequency	: 2400MHz		
FSB Speed	: 533MHz		
Cache L1	: 8 KB		
Cache L2	: 512 KB		
Cache L3	: 0 KB		
Ratio Status	: Locked		
Ratio Actual Value	: 18		
VID CMOS Setting:	[ 62]		
Maximum Value Limit	[Disabled]		
CPU Internal Thermal Control	[Auto]		

<<Copyright 1985-2002, American Megatrends, Inc.

### **VID CMOS Setting [ 62]**

Allows you to set the VID CMOS setting at which the processor is to run. Use the arrow keys to adjust value.

### **Max Value Limit [Disabled]**

Enable this item if you want to boot legacy operating systems that cannot support CPUs with extended CPUID functions. Configuration options: [Disabled] [Enabled]

### **CPU Internal Thermal Control [Auto]**

This item allows you to disable or set to auto the CPU Internal Thermal Control function. Configuration options: [Auto] [Disabled]

## Hyper-Threading Technology [Enabled]

This item allows you to enable or disable the processor Hyper-Threading Technology. Configuration options: [Disabled] [Enabled]



The **Hyper-Threading Technology** item appears only when you install an Intel® Pentium® 4 CPU with Hyper-Threading Technology support.

## 4.4.3 Chipset

The Chipset menu items allow you to change the advanced chipset settings. Select an item then press Enter to display the sub-menu.

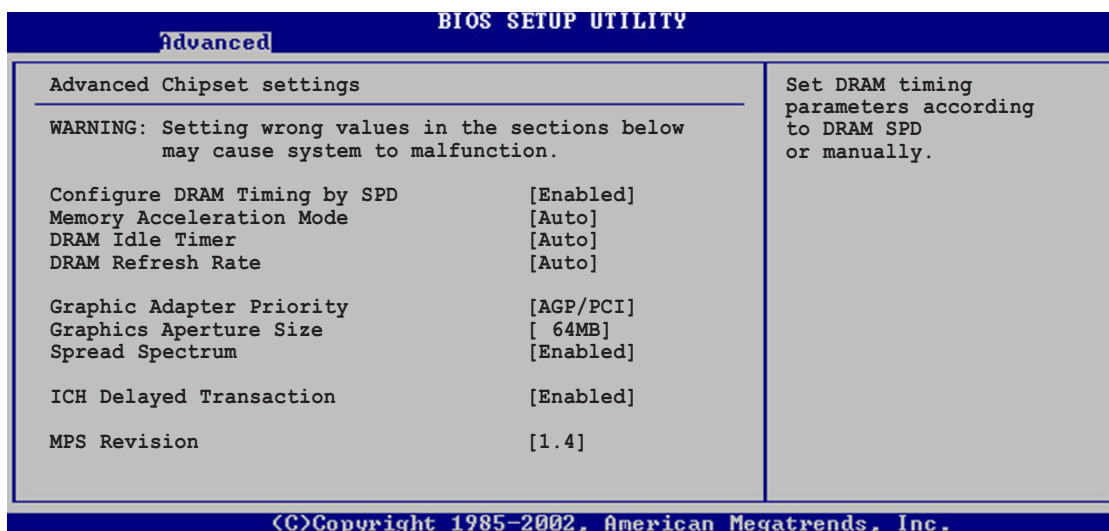

## Configure DRAM Timing by SPD [Enabled]

When this item is enabled, the DRAM timing parameters are set according to the DRAM SPD (Serial Presence Detect). When disabled, you can manually set the DRAM timing parameters through the DRAM sub-items. The following sub-items appear when this item is Disabled.

Configuration options: [Disabled] [Enabled]

### DRAM CAS# Latency [2.5 Clocks]

This item controls the latency between the SDRAM read command and the time the data actually becomes available. Configuration options: [2.0 Clocks] [2.5 Clocks] [3.0 Clocks]

### DRAM RAS# Precharge [4 Clocks]

This item controls the idle clocks after issuing a precharge command to the DDR SDRAM. Configuration options: [4 Clocks] [3 Clocks] [2 Clocks]

### DRAM RAS# to CAS# Delay [4 Clocks]

This item controls the latency between the DDR SDRAM active command and the read/write command. Configuration options: [4 Clocks] [3 Clocks] [2 Clocks]

### DRAM Precharge Delay [8 Clocks]

Configuration options: [8 Clocks] [7 Clocks] [6 Clocks] [5 Clocks]

### DRAM Burst Length [4 Clocks]

Configuration options: [4 Clocks] [8 Clocks]

## **Memory Acceleration Mode [Auto]**

This field when [Enabled] minimize latencies from CPU to memory to boost system performance. Enable this item to activate the ASUS HyperPath Technology feature. Configuration options: [Auto] [Enabled]



---

Setting to **[Enabled]** may cause the system to become unstable! If this happens, revert to the default setting **[Auto]**.

---

## **DRAM Idle Timer [Auto]**

Configuration options: [Infinite] [0T] [8T] [16T] [64T] [Auto]

## **DRAM Refresh Mode [Auto]**

Configuration options: [Auto] [15.6 uSec] [7.8 uSec] [64 uSec]



---

If the system becomes unstable after changing the settings of any of the above items, revert to the default settings.

---

## **Graphic Adapter Priority [AGP/PCI]**

Allows selection of the graphics controller to use as primary boot device. Configuration options: [AGP/PCI] [PCI/AGP]

## **Graphics Aperture Size [64MB]**

Allows you to select the size of mapped memory for AGP graphic data. Configuration options: [4MB] [8MB] [16MB] [32MB] [64MB] [128MB] [256MB]

## **Spread Spectrum [Enabled]**

This field enables or disables the clock generator spread spectrum. Configuration options: [Disabled] [Enabled]

## ICH Delayed Transaction [Enabled]

Configuration options: [Disabled] [Enabled]

## MPS Revision [1.1]

Configuration options: [1.1] [1.4]

### 4.4.4 Onboard Devices Configuration

BIOS SETUP UTILITY	
Advanced	
OnBoard AC'97 Audio	[Auto]
OnBoard LAN	[Enabled]
OnBoard LAN Boot ROM	[Disabled]
Serial Port1 Address	[3F8/IRQ4]
Serial Port2 Address	[2F8/IRQ3]
Parallel Port Address	[378]
Parallel Port Mode	[ECP]
ECP Mode DMA Channel	[DMA3]
Parallel Port IRQ	[IRQ7]
OnBoard Game/MIDI Port	[Disabled]

#### OnBoard AC'97 Audio [Auto]

[Auto] allows the BIOS to detect whether you are using any audio device. If an audio device is detected, the onboard audio controller is enabled; if no audio device is detected, the controller is disabled. Configuration options: [Disabled] [Auto]

#### OnBoard LAN [Enabled]

Allows you to enable or disable the onboard LAN controller. Configuration options: [Disabled] [Enabled]



Marvell® 88E8001 does NOT support S5 Wake-On-LAN function under DOS mode or Windows® ME™.

#### *OnBoard LAN Boot ROM [Disabled]*

Allows you to enable or disable the option ROM in the onboard LAN controller. This item appears only when the Onboard LAN item is set to Enabled. Configuration options: [Disabled] [Enabled]

### **Serial Port1 Address [3F8/IRQ4]**

Allows you to select the Serial Port1 base address.

Configuration options: [Disabled] [3F8/IRQ4] [3E8/IRQ4] [2E8/IRQ3]

### **Serial Port2 Address [2F8/IRQ3]**

Allows you to select the Serial Port2 base address.

Configuration options: [Disabled] [2F8/IRQ3] [3E8/IRQ4] [2E8/IRQ3]

### **Parallel Port Address [378]**

Allows you to select the Parallel Port base addresses.

Configuration options: [Disabled] [378] [278] [3BC]

### **Parallel Port Mode [ECP]**

Allows you to select the Parallel Port mode.

Configuration options: [Normal] [Bi-directional] [EPP] [ECP]

*ECP Mode DMA Channel [DMA3]*

Configuration options: [DMA0] [DMA1] [DMA3]

*Parallel Port IRQ [IRQ7]*

Configuration options: [IRQ5] [IRQ7]

### **Onboard Game/MIDI Port [Disabled]**

Allows you to select the Game Port address or to disable the port.

Configuration options: [Disabled] [200/300] [200/330] [208/300] [208/330]

## 4.4.5 PCI PnP

The PCI PnP menu items allow you to change the advanced settings for PCI/PnP devices. The menu includes setting IRQ and DMA channel resources for either PCI/PnP or legacy ISA devices, and setting the memory size block for legacy ISA devices.



Take caution when changing the settings of the PCI PnP menu items. Incorrect field values may cause the system to malfunction.

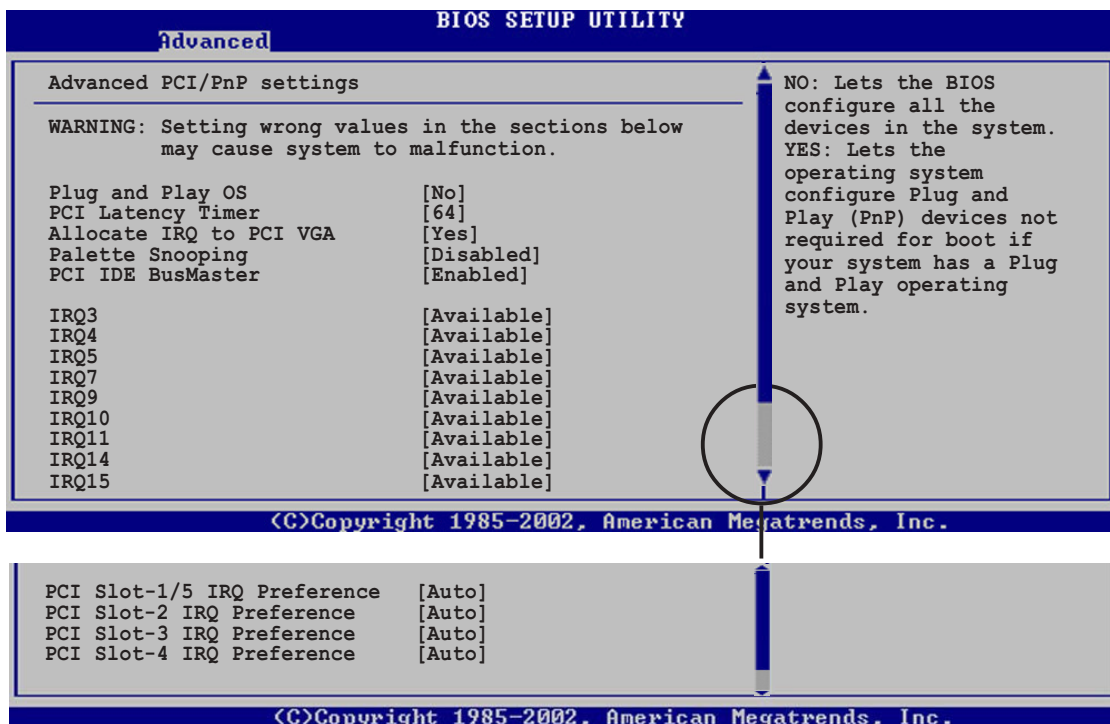

### Plug and Play O/S [No]

When set to [No], BIOS configures all the devices in the system. When set to [Yes] and if you installed a Plug & Play operating system, the operating system configures the Plug & Play devices not required for boot.

Configuration options: [No] [Yes]

### PCI Latency Timer [64]

Allows you to select the value in units of PCI clocks for the PCI device latency timer register. Configuration options: [32] [64] [96] [128] [160] [192] [224] [248]

### Allocate IRQ to PCI VGA [Yes]

When set to [Yes], BIOS assigns an IRQ to PCI VGA card if the card requests for an IRQ. When set to [No], BIOS does not assign an IRQ to the PCI VGA card even if requested. Configuration options: [No] [Yes]

## Pallete Snooping [Disabled]

When set to [Enabled], the pallete snooping feature informs the PCI devices that an ISA graphics device is installed in the system so that the latter can function correctly. Setting to [Disabled] deactivates this feature. Configuration options: [Disabled] [Enabled]

## PCI IDE BusMaster [Enabled]

Allows BIOS to use PCI bus mastering when reading/writing to IDE devices. Configuration options: [Disabled] [Enabled]

## IRQ xx [Available]

When set to [Available], the specific IRQ is free for use of PCI/PnP devices. When set to [Reserved], the IRQ is reserved for legacy ISA devices. Configuration options: [Available] [Reserved]

## PCI Slot - xx IRQ Preference [Auto]

Allows you to set the PCI slot IRQ Preference. Configuration options: [Auto] [3] [4] [5] [7] [9] [10] [11] [12] [14] [15]

## 4.4.6 USB Configuration

The items in this menu allows you to change the USB-related features. Select an item then press Enter to display the configuration options.

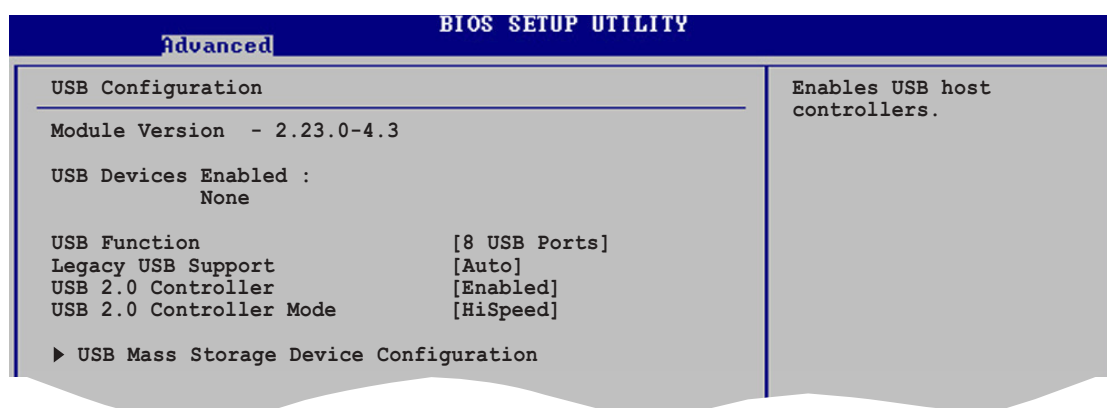

The Module Version and USB Devices Enabled items show the auto-detected values. If no USB device is detected, the item shows None.

## USB Function [8 USB Ports]

Allows you to enable or disable the USB function. Configuration options: [Disabled] [2 USB Ports] [4 USB Ports] [6 USB Ports] [8 USB Ports]

## Legacy USB Support [Auto]

Allows you to enable or disable support for legacy USB devices. Setting to Auto allows the system to detect the presence of USB devices at startup. If detected, the USB controller legacy mode is enabled. If no USB device is detected, the legacy USB support is disabled. Configuration options: [Disabled] [Enabled] [Auto]

## USB 2.0 Controller [Enabled]

Allows you to enable or disable the USB 2.0 controller. Configuration options: [Disabled] [Enabled]

## USB 2.0 Controller Mode [HiSpeed]

Allows you to configure the USB 2.0 controller in HiSpeed (480 Mbps) or Full Speed (12 Mbps). Configuration options: [HiSpeed ] [Full Speed]

## USB Mass Storage Device Configuration

BIOS SETUP UTILITY	
Advanced	
USB Mass Storage Device Configuration	
USB Mass Storage Reset Delay [20 Sec]	Number of seconds POST waits for the USB mass storage device after the start unit command.
No USB Mass Storage device detected	

### USB Mass Storage Reset Delay [20 Sec]

Allows you to select the number of seconds POST waits for the USB mass storage device after the start unit command. The message “No USB mass storage device detected” appears if none is installed in the system. Configuration options: [10 Sec ] [20 Sec] [30 Sec] [40 Sec]

### Emulation Type [N/A]

When set to Auto, USB devices less than 530MB will be emulated as floppy drive, and the remaining drives as hard drives. Forced FDD option can be used to force an HDD formatted drive to boot as FDD (for example, ZIP drive).



The Device and Emulation Type items appear only when there are installed USB devices.



## 4.4.7 Instant Music Configuration

Advanced		BIOS SETUP UTILITY
Instant Music Option		
Instant Music	[Disabled]	If enabled, power up by PS/2 keypboard function will be disabled.

### Instant Music [Disabled]

Allows you to enable or disable the Instant Music feature in BIOS.

Configuration options: [Disabled] [Enabled]



When Instant Music is enabled, the PS/2 keyboard power up feature is automatically disabled. See page 5-9 for details.

### Instant Music CD-ROM Drive [IDE Secondary Master]

Allows you to select the CD-ROM drive that you wish to use for the Instant Music CD playback. Configuration options: [IDE Primary Master] [IDE Primary Slave] [IDE Secondary Master] [IDE Secondary Slave]



The above item appears only if you enabled the Instant Music item.

## 4.5 Power menu

The Power menu items allow you to change the settings for the Advanced Power Management (APM). Select an item then press Enter to display the configuration options.

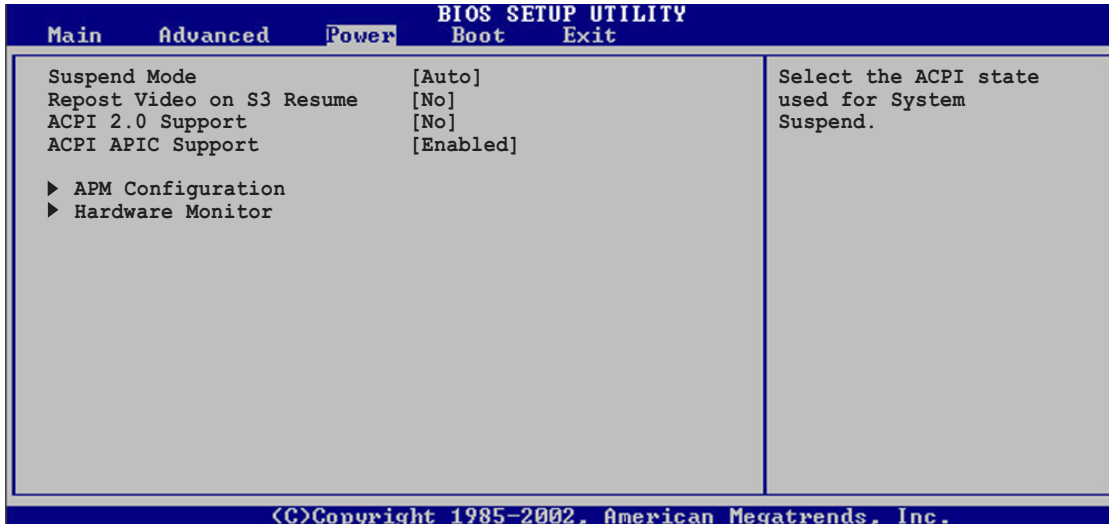

### 4.5.1 Suspend Mode [Auto]

Allows you to select the ACPI state to be used for system suspend.  
Configuration options: [S1 (POS) Only] [S3 Only] [Auto]

### 4.5.2 Repost Video on S3 Resume [No]

Determines whether to invoke VGA BIOS POST on S3/STR resume.  
Configuration options: [No] [Yes]

### 4.5.3 ACPI 2.0 Support [No]

Allows you to add more tables for ACPI 2.0 specifications. Configuration options: [No] [Yes]

### 4.5.4 ACPI APIC Support [Enabled]

Allows you to enable or disable the ACPI support in the ASIC. When set to Enabled, the ACPI APIC table pointer is included in the RSDT pointer list.  
Configuration options: [Disabled] [Enabled]

## 4.5.5 APM Configuration

BIOS SETUP UTILITY	
Power	
APM Configuration	
Power Management/APM	[Enabled]
Video Power Down Mode	[Suspend]
Hard Disk Power Down Mode	[Suspend]
Suspend Time Out	[Disabled]
Throttle Slow Clock Ratio	[50%]
Power Button Mode	[On/Off]
Restore on AC Power Loss	[Power Off]
Power On By RTC Alarm	[Disabled]
Power On By External Modems	[Disabled]
Power On By PCI Devices	[Disabled]
Power On PS/2 Keyboard	[Disabled]
Power On PS/2 Mouse	[Disabled]

Enable or disable APM.

<<Copyright 1985-2002, American Megatrends, Inc.

### Power Management/APM [Enabled]

Allows you to enable or disable the Advanced Power Management (APM) feature. Configuration options: [Disabled] [Enabled]

### Video Power Down Mode [Suspend]

Allows you to select the video power down mode. Configuration options: [Disabled] [Suspend]

### Hard Disk Power Down Mode [Suspend]

Allows you to select the hard disk power down mode. Configuration options: [Disabled] [Suspend]

### Suspend Time Out [Disabled]

Allows you to select the specified time at which the system goes on suspend. Configuration options: [Disabled] [1-2 Min] [2-3 Min] [4-5 Min] [8-9 Min] [10 Min] [20 Min] [30 Min] [40 Min] [50 Min] [60 Min]

### Throttle Slow Clock Ratio [50%]

Allows you to select the duty cycle in throttle mode. Configuration options: [87.5%] [75.0%] [62.5%] [50%] [37.5%] [25%] [12.5%]

### Power Button Mode [On/Off]

Allows the system to go into On/Off mode or suspend mode when the power button is pressed. Configuration options: [On/Off] [Suspend]

### **Restore on AC Power Loss [Power Off]**

When set to Power Off, the system goes into off state after an AC power loss. When set to Power On, the system goes on after an AC power loss. When set to Last State, the system goes into either off or on state whatever was the system state before the AC power loss. Configuration options: [Power Off] [Power On] [Last State]

### **Power On By RTC Alarm [Disabled]**

Allows you to enable or disable RTC to generate a wake event. When this item is set to Enabled, the items RTC Alarm Date, RTC Alarm Hour, RTC Alarm Minute, and RTC Alarm Second appear with set values. Configuration options: [Disabled] [Enabled]

### **Power On By External Modem [Disabled]**

This allows either settings of [Enabled] or [Disabled] for powering up the computer when the external modem receives a call while the computer is in Soft-off mode. Configuration options: [Disabled] [Enabled]



The computer cannot receive or transmit data until the computer and applications are fully running. Thus, connection cannot be made on the first try. Turning an external modem off and then back on while the computer is off causes an initialization string that turns the system power on.

---

### **Power On By PCI Devices [Disabled]**

When set to [Enabled], this parameter allows you to turn on the system through a PCI LAN or modem card. This feature requires an ATX power supply that provides at least 1A on the +5VSB lead. Configuration options: [Disabled] [Enabled]

### **Power On By PS/2 Keyboard [Disabled]**

Allows you to use specific keys on the keyboard to turn on the system. This feature requires an ATX power supply that provides at least 1A on the +5VSB lead. Configuration options: [Disabled] [Enabled]

### **Power On By PS/2 Mouse [Disabled]**

When set to [Enabled], this parameter allows you to use the PS/2 mouse to turn on the system. This feature requires an ATX power supply that provides at least 1A on the +5VSB lead. Configuration options: [Disabled] [Enabled]

## 4.5.6 Hardware Monitor

BIOS SETUP UTILITY	
Power	
Hardware Monitor	CPU Temperature
CPU Temperature	[31.5°C/86.5°F]
MB Temperature	[31°C/87.5°F]
Power Temperature	[N/A]
Q-Fan Control	[Disabled]
CPU Fan Speed	[5232RPM]
Chassis Fan Speed	[N/A]
Power Fan Speed	[N/A]
VCORE Voltage	[1.552V]
3.3V Voltage	[3.408V]
5V Voltage	[5.080V]
12V Voltage	[11.977V]

©Copyright 1985-2002, American Megatrends, Inc.

### **CPU Temperature [xxx°C/xxx°F]**

### **MB Temperature [xxx°C/xxx°F]**

### **Power Temperature [N/A]**

The onboard hardware monitor automatically detects and displays the motherboard, CPU, and power supply temperatures. Select Disabled if you do not wish to display the detected temperatures.

### **Q-Fan Control [Disabled]**

Allows you to enable or disable the ASUS Q-Fan feature that smartly adjusts the fan speeds for more efficient system operation. When this field is set to [Enabled], the **Fan Speed Ratio** item appears to allow selection of the appropriate fan speed ratio. Configuration options: [Disabled] [Enabled]

### **Fan Speed Ratio [11/16]**

Allows you to select the appropriate fan speed ratio for the system. The default [11/16] is the minimum fan speed ratio. Select a higher ratio if you installed additional devices and the system requires more ventilation.

Configuration options: [11/16] [12/16] [13/16] [14/16] [15/16]



The above item appears only when the **Q-Fan Control** item is set to Enabled.

**CPU Fan Speed [xxxxRPM] or [N/A]**  
**Chassis Fan Speed [xxxxRPM] or [N/A]**  
**Power Fan Speed [xxxxRPM] or [N/A]**

The onboard hardware monitor automatically detects and displays the CPU, chassis, and power fan speeds in rotations per minute (RPM). If any of the fans is not connected to the motherboard, the specific field shows N/A.

**VCORE Voltage, +3.3V Voltage, +5V Voltage, +12V Voltage**

The onboard hardware monitor automatically detects the voltage output through the onboard voltage regulators.



If any of the monitored items is out of range, the following error message appears: "Hardware Monitor found an error. Enter Power setup menu for details". You will then be prompted to "Press F1 to continue or DEL to enter SETUP".

## 4.6 Boot menu

The Boot menu items allow you to change the system boot options. Select an item then press Enter to display the sub-menu.

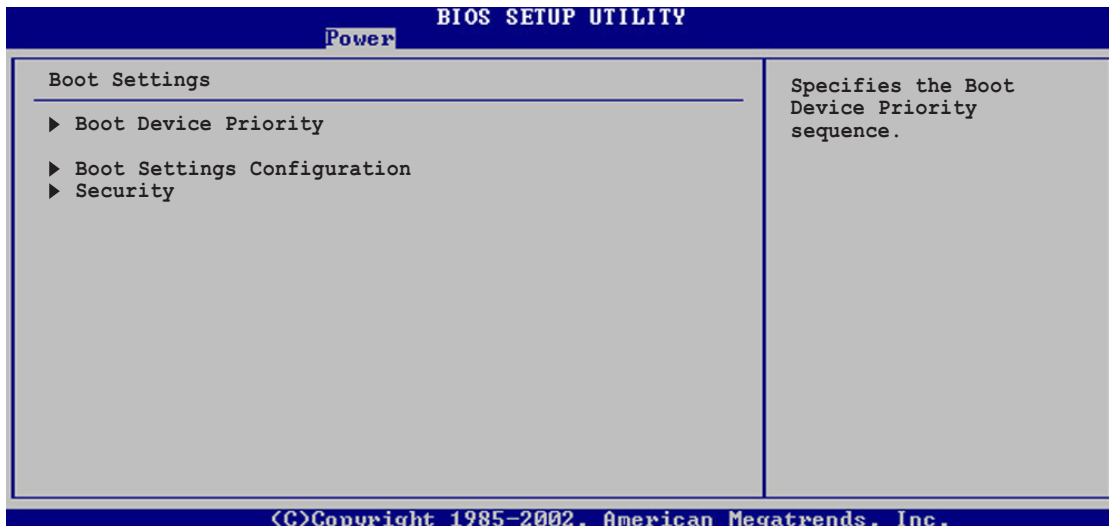

## 4.6.1 Boot Device Priority

BIOS SETUP UTILITY	
Boot	
Boot Device Priority	
1st Boot Device	[1st Floppy Drive]
2nd Boot Device	[PM-ST32122A]
3rd Boot Device	[SS-Pioneer CD-ROM]
4th Boot Device	[Yukon PXE]
Specifies the boot sequence from the available devices.	
A device enclosed in parenthesis has been disabled in the corresponding type menu.	

### 1st ~ xxth Boot Device [1st Floppy Drive]

These items specify the boot device priority sequence from the available devices. The number of device items that appear on the screen depends on the the number of devices installed in the system. Configuration options: [xxxxx Drive] [Disabled]

## 4.6.2 Boot Settings Configuration

BIOS SETUP UTILITY	
Boot	
Boot Settings Configuration	
Quick Boot	[Enabled]
Full Screen Logo	[Enabled]
Add On ROM Display Mode	[Force BIOS]
Bootup Num-Lock	[On]
PS/2 Mouse Support	[Auto]
Boot to OS/2	[No]
Wait for 'F1' If Error	[Enabled]
Hit 'DEL' Message Display	[Enabled]
Interrupt 19 Capture	[Disabled]
Allows BIOS to skip certain tests while booting. This will decrease the time needed to boot the system.	

(C)Copyright 1985-2002, American Megatrends, Inc.

### Quick Boot [Enabled]

Enabling this item allows the BIOS to skip some power on self tests (POST) while booting to decrease the time needed to boot the system. When set to [Disabled], BIOS performs all the POST items. Configuration options: [Disabled] [Enabled]

### Full Screen Logo [Enabled]

This allows you to enable or disable the full screen logo display feature. Configuration options: [Disabled] [Enabled]



Make sure that the above item is set to [Enabled] if you wish to use the ASUS MyLogo2™ feature.

### **Add On ROM Display Mode [Force BIOS]**

Sets the display mode for option ROM. Configuration options: [Force BIOS] [Keep Current]

### **Bootup Num-Lock [On]**

Allows you to select the power-on state for the NumLock. Configuration options: [Off] [On]

### **PS/2 Mouse Support [Auto]**

Allows you to enable or disable support for PS/2 mouse. Configuration options: [Disabled] [Enabled] [Auto]

### **Typematic Rate [Fast]**

Allows you to select the keyboard typematic rate. Configuration options: [Slow] [Fast]

### **Boot to OS/2 [No]**

Allows you to specify the OS/2 compatibility mode. Configuration options: [No] [Yes]

### **Wait for 'F1' If Error [Enabled]**

When set to Enabled, the system waits for F1 key to be pressed when error occurs. Configuration options: [Disabled] [Enabled]

### **Hit 'DEL' Message Display [Enabled]**

When set to Enabled, the system displays the message "Press DEL to run Setup" during POST. Configuration options: [Disabled] [Enabled]

### **Interrupt 19 Capture [Disabled]**

When set to [Enabled], this function allows the option ROMs to trap Interrupt 19. Configuration options: [Disabled] [Enabled]



## 4.6.3 Security

The Security menu items allow you to change the system security settings. Select an item then press **<Enter>** to display the configuration options.

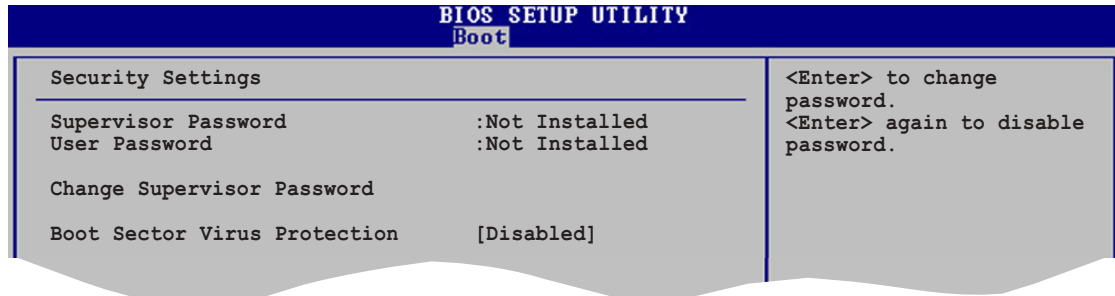

### Change Supervisor Password

Select this item to set or change the supervisor password. The Supervisor Password item on top of the screen shows the default **Not Installed**. After you have set a password, this item shows **Installed**.

To set a Supervisor Password:

1. Select the Change Supervisor Password item and press **<Enter>**.
2. From the password box, type a password combination of at least six (6) letters and/or numbers, then press **<Enter>**.
3. Confirm the password when prompted.  
The message "Password Installed" appears after you have successfully set your password.

To change the supervisor password, follow the same steps as in setting a user password.

To clear the supervisor password, select the Change Supervisor Password then press **<Enter>**. The message "Password Uninstalled" appears.



---

If you forget your BIOS password, you can clear it by erasing the CMOS Real Time Clock (RTC) RAM. See section "2.6 Jumpers" for information on how to erase the RTC RAM.

---

After you have set a supervisor password, the other items appear to allow you to change other security settings.

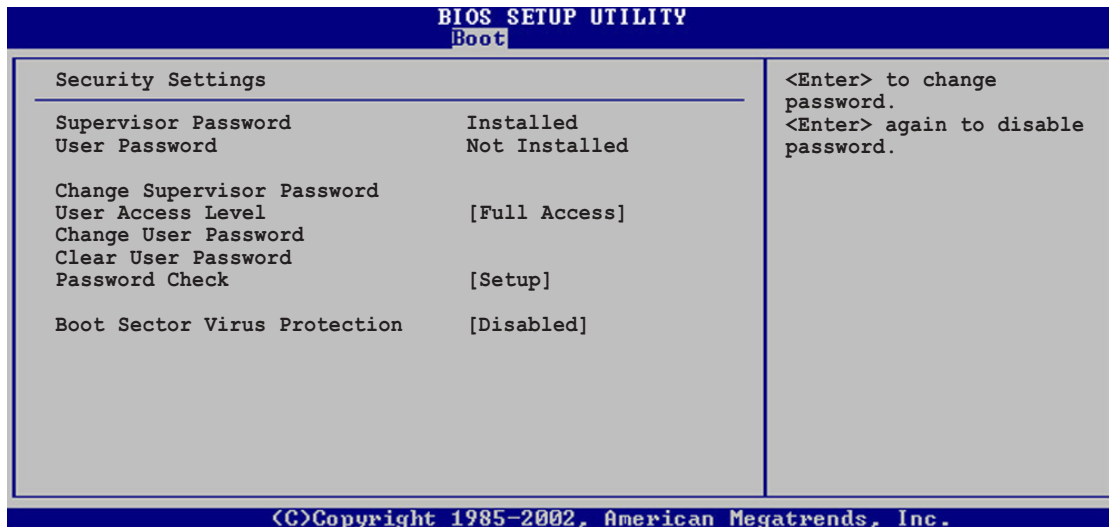

### User Access Level (Full Access)

This item allows you to select the access restriction to the Setup items. Configuration options: [No Access] [View Only] [Limited] [Full Access]

**No Access** prevents user access to the Setup utility.

**View Only** allows access but does not allow change to any field.

**Limited** allows change to only selected fields, such as Date and Time.

**Full Access** allows viewing and changing all the fields in the Setup utility.

### Change User Password

Select this item to set or change the user password. The User Password item on top of the screen shows the default **Not Installed**. After you have set a password, this item shows **Installed**.

To set a User Password:

1. Select the Change User Password item and press **<Enter>**.
2. On the password box that appears, type a password combination of at least six (6) letters and/or numbers, then press **<Enter>**.
3. Confirm the password when prompted.  
The message "Password Installed" appears after you have successfully set your password.

To change the user password, follow the same steps as in setting a user password.

### Clear User Password

Select this item if you wish to clear the user password.

### Password Check [Setup]

When set to [Setup], BIOS checks for user password when accessing the Setup utility. When set to [Always], BIOS checks for user password both when accessing Setup and booting the system. Configuration options:  
[Setup] [Always]

### Boot Sector Virus Protection [Disabled]

Allows you to enable or disable the boot sector virus protection.  
Configuration options: [Disabled] [Enabled]

## 4.7 Exit menu

The Exit menu items allow you to load the optimal or failsafe default values for the BIOS items, and save or discard your changes to the BIOS items.

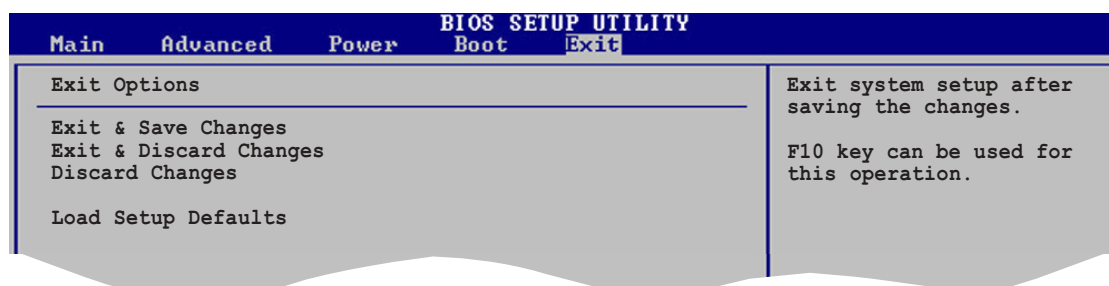

Pressing **<Esc>** does not immediately exit this menu. Select one of the options from this menu or **<F10>** from the legend bar to exit.

## Exit & Save Changes

Once you are finished making your selections, choose this option from the Exit menu to ensure the values you selected are saved to the CMOS RAM. The CMOS RAM is sustained by an onboard backup battery and stays on even when the PC is turned off. When you select this option, a confirmation window appears. Select **Yes** to save changes and exit.



---

If you attempt to exit the Setup program without saving your changes, the program prompts you with a message asking if you want to save your changes before exiting. Press **<Enter>** to save the changes while exiting.

---

## Exit & Discard Changes

Select this option only if you do not want to save the changes that you made to the Setup program. If you made changes to fields other than system date, system time, and password, the BIOS asks for a confirmation before exiting.

## Discard Changes

This option allows you to discard the selections you made and restore the previously saved values. After selecting this option, a confirmation appears. Select **Yes** to discard any changes and load the previously saved values.

## Load Setup Defaults

This option allows you to load the default values for each of the parameters on the Setup menus. When you select this option or if you press **<F5>**, a confirmation window appears. Select **Yes** to load default values. Select **Exit Saving Changes** or make other changes before saving the values to the non-volatile RAM.

# ***Chapter 5***

This chapter describes the contents of the support CD that comes with the motherboard package.

## **Software support**

## **Chapter summary**

<b>5.1</b>	<b>Install an operating system .....</b>	<b>5-1</b>
<b>5.2</b>	<b>Support CD information .....</b>	<b>5-1</b>
<b>5.3</b>	<b>Software Information .....</b>	<b>5-7</b>
<b>5.4</b>	<b>AI Net feature .....</b>	<b>5-12</b>
<b>5.5</b>	<b>SoundMAX® 4 XL software .....</b>	<b>5-13</b>
<b>5.6</b>	<b>Intel® RAID for Serial ATA configuration ....</b>	<b>5-19</b>
<b>5.7</b>	<b>Creating a RAID driver disk .....</b>	<b>5-23</b>

## 5.1 Install an operating system

This motherboard supports Windows® 98SE/ME/2000/2003 Server/XP operating systems (OS). Always install the latest OS version and corresponding updates so you can maximize the features of your hardware.



Because motherboard settings and hardware options vary, use the setup procedures presented in this chapter for general reference only. Refer to your OS documentation for more information.

## 5.2 Support CD information

The support CD that came with the motherboard contains useful software and several utility drivers that enhance the motherboard features.



The contents of the support CD are subject to change at any time without notice. Visit the ASUS website for updates.

### 5.2.1 Running the support CD

To begin using the support CD, simply insert the CD into your CD-ROM drive. The CD automatically displays the **Drivers** menu if Autorun is enabled in your computer.

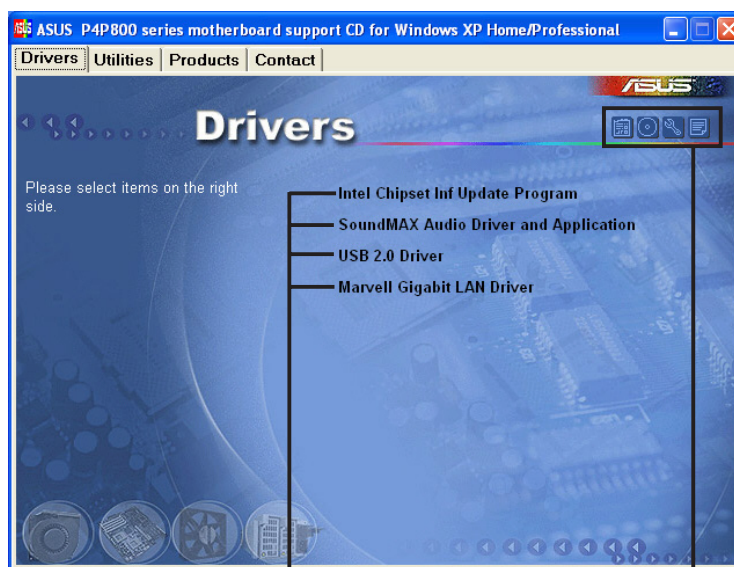

Click an item to install

Click an icon to display more information



If **Autorun** is NOT enabled in your computer, browse the contents of the support CD to locate the file **ASSETUP.EXE** from the **BIN** folder. Double-click the **ASSETUP.EXE** to run the CD.

## 5.2.2 Drivers menu

The drivers menu shows the available device drivers if the system detects installed devices. Install the necessary drivers to activate the devices.

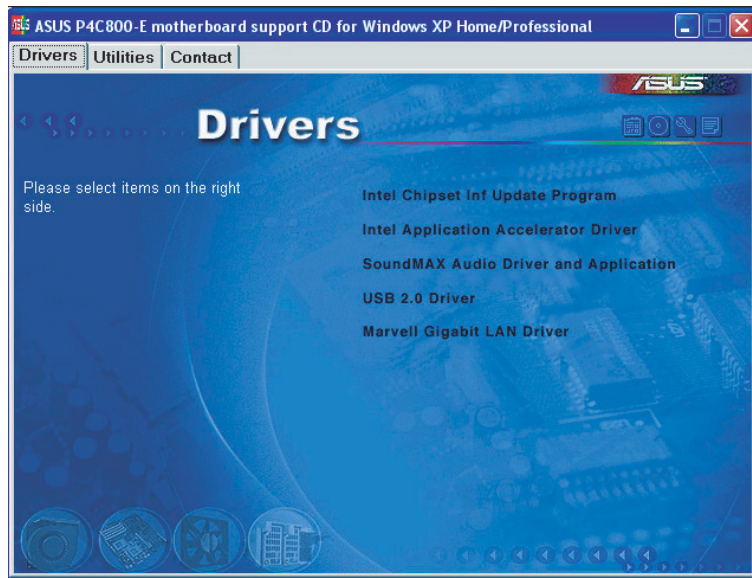

### Intel Chipset Inf Update Program

This item installs the Intel® Chipset INF Update Program that enables Plug-n-Play INF support for Intel® chipset components. This utility installs to the target system the Windows INF files that outline to the operating system how the chipset components will be configured.

You may install this utility in three modes: interactive, silent and unattended preload. The interactive mode requires user input during installation. This is not required in the silent and unattended preload modes.

Refer to the online help or readme file that came with the utility.

### Intel Application Accelerator Driver

This item installs the Intel Application Accelerator Driver. If you are using Windows® 2000 or Windows® XP, this driver allows RAID 0 and RAID 1 configuration for the Serial ATA channels. This driver can only be installed when the RAID function of Serial ATA is enabled.

### SoundMAX® Audio Driver and Application

This item executes the wizard to install the AD1985 audio driver and applications.



## USB 2.0 Driver

This item installs the Universal Serial Bus 2.0 (USB 2.0) driver.

## Marvell Gigabit LAN Driver

This item executes the interface for the Marvell® LAN driver and diagnostics installation.



---

The screen displays and driver options may not be the same for different operating system versions.

---

## 5.2.3 Utilities menu

The Utilities menu shows the applications and other software that the motherboard supports.

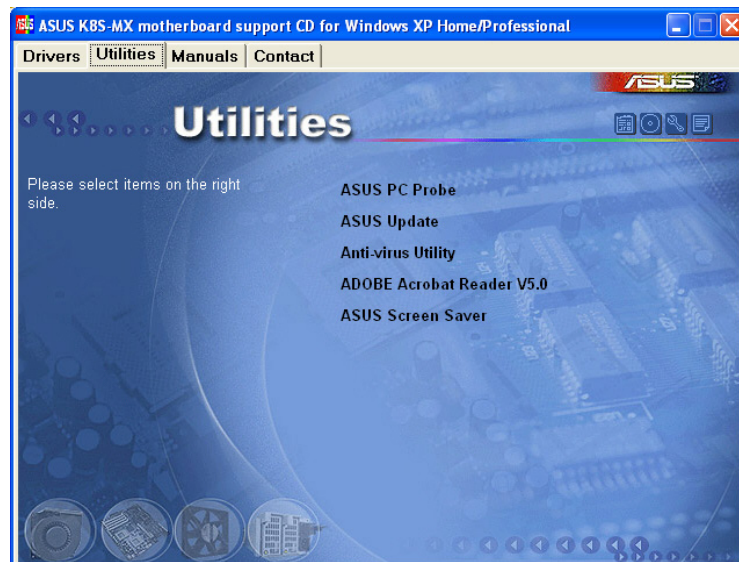

### ASUS PC Probe

This smart utility monitors the fan speed, CPU temperature, and system voltages, and alerts you on any detected problems. This utility helps you keep your computer at a healthy operating condition.

### Install ASUS Update

This program allows you to download the latest version of the BIOS from the ASUS website.



---

Before using the ASUS Update, make sure that you have an Internet connection so you can connect to the ASUS website.

---

## ASUS AI Booster

This item installs the ASUS AI Booster utility.

## Anti-virus application

The anti-virus application scans, identifies, and removes computer viruses. View the online help for detailed information.

## Adobe Acrobat Reader

This item installs the Adobe Acrobat Reader. The Acrobat Reader software is for viewing files saved in Portable Document Format (PDF).

## ASUS Screen Saver

This item installs the ASUS screen saver.



Screen display and utilities option may not be the same for other operating system versions.

## 5.2.4 ASUS Contact Information

Clicking the ASUS Contact Information tab displays as stated. You may also find this information in the inside front cover of this user guide.

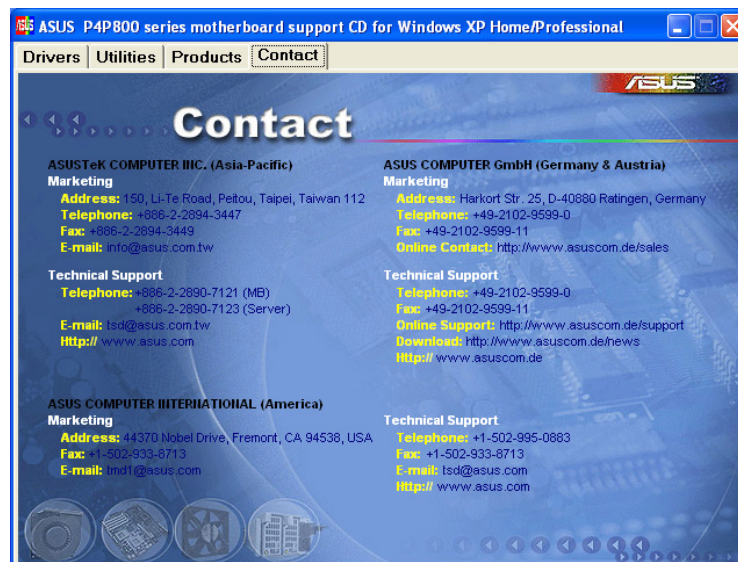

## 5.2.5 Other information

The icons on the top right corner of the screen give additional information on the motherboard and the contents of the support CD. Click an icon to display the specified information.

### Motherboard Info

The window displays the general specifications of the motherboard.

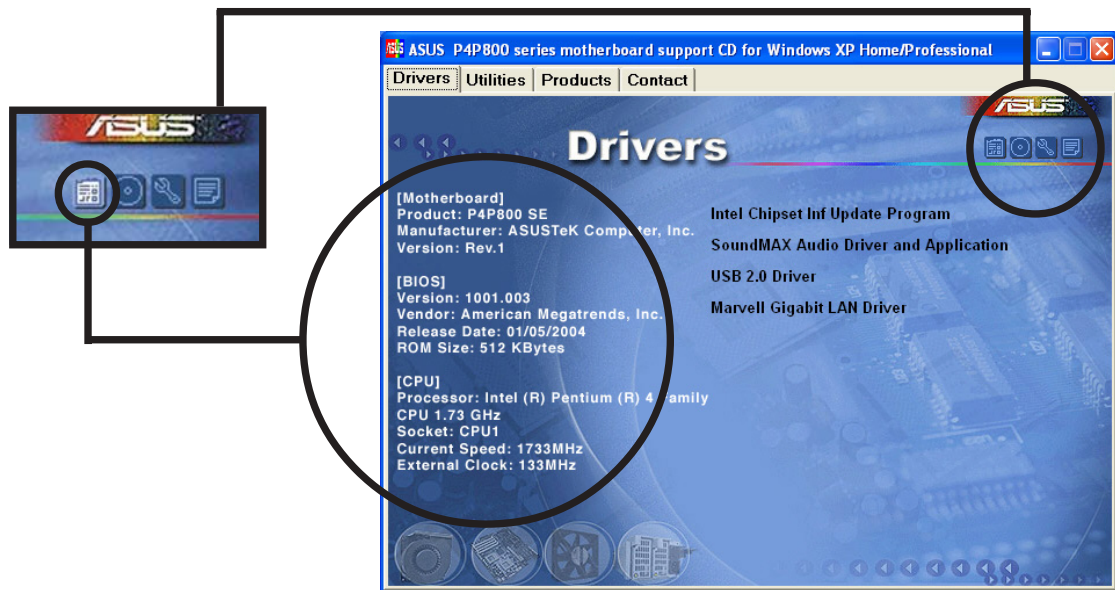

### Browse this CD

The window displays the support CD contents in graphical format.

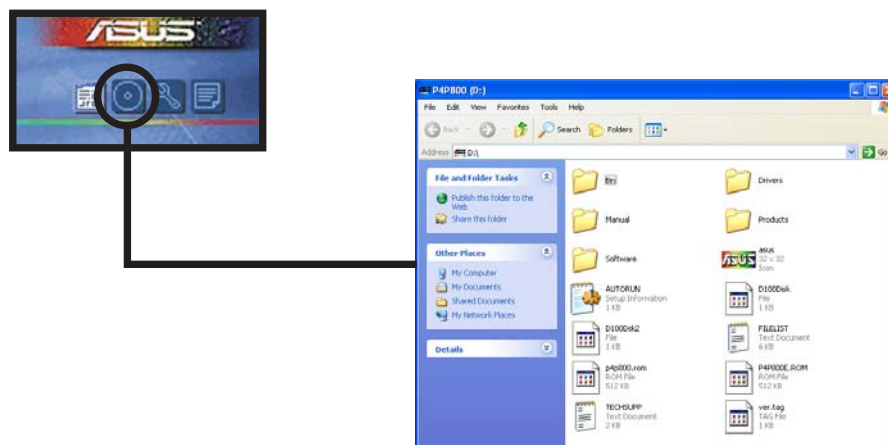

## Technical Support Form

The window displays the ASUS Technical Support Request Form that you have to fill up when requesting technical support.

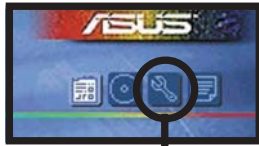

TECHSUPP - Notepad

```
ASUSTek TECHNICAL SUPPORT REQUEST FORM      DATE:
-----
ORIGINATOR DESCRIPTION
-----
COMPANY NAME :                               CONTACT NAME:
PHONE (AREA) :                               FAX # (AREA):
EMAIL ADDRESS:
-----
HARDWARE DESCRIPTION
-----
MOTHERBOARD :                               REVISION #:                               BIOS:#401A
CPU BRAND :                                   SPEED(MHZ):
DRAM BRAND :                                 SPEED(MS) :                               SIZE(MB):
CACHE BRAND :                               SPEED(NS) :                               SIZE(KB):
HARD DISK :                                  MODEL NAME:                               SIZE(MB):
CDROM BRAND :                               MODEL NAME:
BACKUP BRAND :                              MODEL NAME:                               SIZE(MB):
OTHER STORAGE:                             MODEL NAME:                               SIZE(MB):
-----
ADD-IN CARD DESCRIPTION (MODEL NAME/VENDOR)
-----
(E)ISA SLOT 1:
(E)ISA SLOT 2:
(E)ISA SLOT 3:
(E)ISA SLOT 4:
```

## Filelist

The window displays the contents of the support CD and a brief description of each in text format.

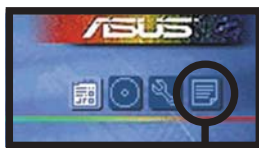

FILELIST - Notepad

```
File list for the included support software for Intel P4P800/P4P800-E series motherboard
-----
File Name      description
-----
--Drivers
-Audio
-AC97SS       -SoundMAX Audio driver version 5.12.03.3630 WHQL (98/ME/2000/XP)
-Linux        -SoundMAX Audio driver for Linux.
-nt40         -SoundMAX 40188/2980/2985 Audio driver v4.0.0.25 for Windows NT4.0.
-ALCB30       -ALCB30 Avance AC'97 driver and Applications A3.53.(98/ME/2000/XP/2003)
-Linux        -ALCB30 Avance AC'97 driver for Linux.
-Chipset
-LAA          -Intel(R) Application Accelerator RAI0 Edition 3.5R for Windows 2000/XP
-MakeDisk.exe -Make SATA driver floppy for Windows 2000/XP.
-Inf          -Intel(R) chipset software installation utility 5.0.2.1003.
-LAN
-3com         -3com 10gbit LOM (3C940) driver v1.0.0.46 WHQL for Windows
2000/XP/2003 & v1.0.0.44 for Windows NT4/98/ME.
-Marvell      -Marvell LAN driver v6.28 WHQL for Windows 2000/XP & v6.31 for Windows 0
-wIn2003     -Marvell LAN driver v6.32 for Windows 2003.
-Frontise
-378RAID      -FastTrak 378 driver.
-nt4         -Windows NT4 miniport driver 1.00.1.37.
-wIn2000     -Windows 2000 miniport driver 1.00.1.37 WHQL.
-wIn2003     -Windows Server 2003 miniport driver 1.00.1.37 WHQL.
-98-me       -Windows 98/ME miniport driver 1.00.1.37.
-wInxp       -Windows xp miniport driver 1.00.1.37 WHQL.
-MakeDisk    -Make Frontise RAID driver floppy for Windows NT4/2000/XP/2003.
-378ATA      -Promise SATA378 driver v1.00.0.26.
```

## 5.3 Software Information

Most of the applications in the support CD have wizards that will conveniently guide you through the installation. View the online help or readme file that came with the software for more information.

This section provides details on the software applications that the motherboard supports.

### 5.3.1 ASUS MyLogo2™

The ASUS MyLogo2™ is automatically installed when you install the ASUS Update utility from the software menu. See section “5.2.3 Utilities menu”.



Before using ASUS MyLogo2™ feature, use the AFUDOS utility to make a copy of your original BIOS file, or obtain the latest BIOS version from the ASUS website.



Make sure that the BIOS Item Full Screen Logo is set to [Enabled] if you wish to use ASUS MyLogo2. See section “4.6.2 Boot Settings Configuration”.

Follow these steps to use ASUS MyLogo2.

1. Launch the ASUS Update utility. See section “4.1.6 ASUS Update.”
2. When prompted for the BIOS update method, select the option “Update BIOS from a file.”
3. Specify the location of the BIOS file, such as from a floppy disk. Click **Next**.





- From the selection that appears, choose a logo image. Click **Next**.



If you wish, you may create your own boot logo image in GIF, JPG, or BMP file formats.



- When you click on an image, it displays larger on the MyLogo2 screen.



If you wish to make the logo image smaller, click on the arrow on the Ratio item and select your desired scale.



- The next screen prompts you to flash the original BIOS to update it with the new boot logo. Click **Flash** to update the BIOS.
- When finished, click **Exit**, then reboot your computer. Your system boots with the new boot logo.

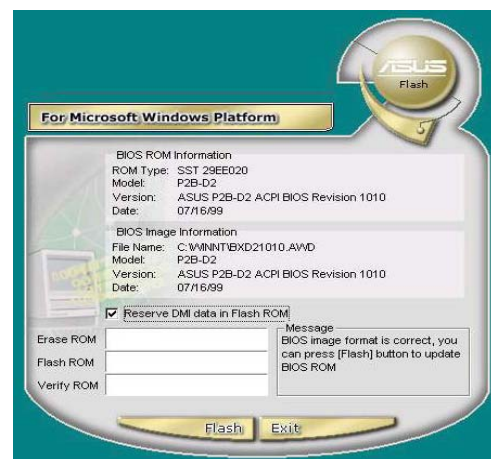

Instead of starting from ASUS Update, you may also launch ASUS MyLogo2 directly from the Windows Start menu to change your BIOS boot logo. After you have modified the BIOS file with the new logo, use the ASUS Update utility to upload the new BIOS.

## 5.3.2 ASUS Instant Music

The motherboard is equipped with a BIOS-based audio playback feature called **Instant Music**. The onboard audio AC'97 CODEC supports this feature, which requires an optical drive (CD-ROM, DVD-ROM, or CD-RW).



- 
1. Instant Music only supports CDs in audio format.
  2. Instant Music does not work if you installed and enabled an add-on sound card.
  3. Instant Music only supports PS/2 keyboard.
- 

To enable ASUS Instant Music:

1. Connect the analog audio cable from the optical drive (CD-ROM, DVD-ROM, or CD-RW drive) to the 4-pin CD-In connector (labeled CD) on the motherboard. See section “2.7 Connectors” for the location.



---

Make sure to connect the CD-ROM audio cable. Otherwise, you cannot control the audio volume using the Instant Music function keys.

---

2. Turn on the system and enter BIOS by pressing the **Delete** key during the Power On Self-Tests (POST).
3. From the BIOS screen select **Advanced** then **Instant Music Configuration**.
4. In the **Instant Music Configuration** menu, select the item **Instant Music** and set it to **Enabled**. See section “4.4.7 Instant Music Configuration.”
5. The **Instant Music CD-ROM Drive** item appears if you enabled Instant Music. Highlight the item then press **<Enter>** to display the CD-ROM options.
6. Save your changes and exit BIOS Setup.



- 
1. The Scroll Lock LED is fixed to ON after enabling Instant Music.
  2. The Caps Lock LED turns ON when you pause the CD playback.
  3. When set to Instant Music mode, the system wake-up features (LAN, keyboard, mouse, USB) are deactivated. In this case, power up the system using the power switch.
  4. If the system lost connection or did not detect any optical drive, the Instant Music feature turns OFF (disabled) automatically. A “beep” indicates this condition.
-

## To use ASUS Instant Music:

1. Ensure that the power cord is plugged to a grounded power source, so that the system has a standby power.
2. Use either one of the two sets of special function keys on your keyboard to play audio CDs. These keys only function as indicated if you enabled the Instant Music item in BIOS.

### *Instant Music function keys (Set 1)*

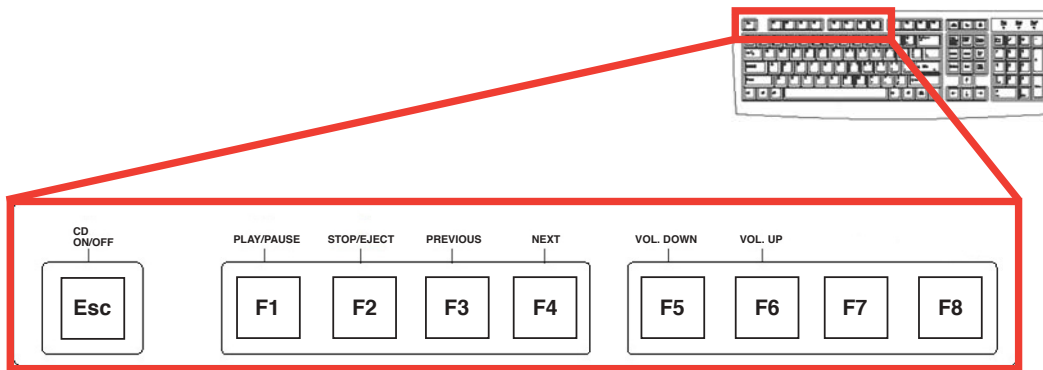

To guide you in using Instant Music, place the Instant Music label over the function keys on the keyboard. The Instant Music keyboard label comes with your motherboard package.

### *Instant Music function keys (Set 2)*

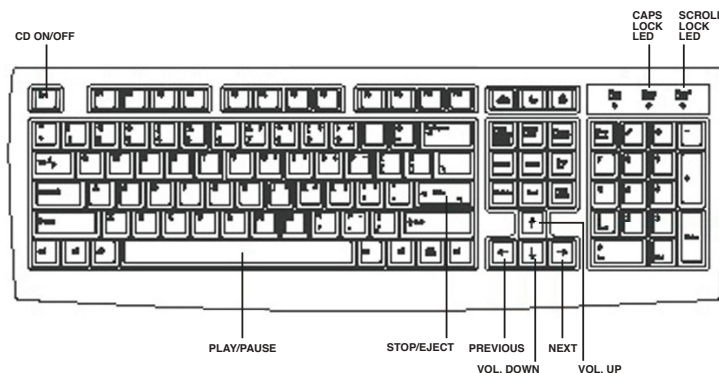

3. Connect speakers or a headphone to the Line Out (lime colored) port on the rear panel for audio output. You may also connect a headphone to the headphone jack on the CD-ROM drive front panel.
4. Press **<Esc>** to turn ON Instant Music.
5. Place an audio CD on the CD-ROM drive.
6. Press **<F1>** or the **<Space Bar>** to play the first track on the CD.





---

If there is no CD on the drive and you press **<F1>** or **<Space Bar>**, the drive tray ejects.

---

7. Refer to the Instant Music function key definitions on the previous page to select other tracks or control the volume.
8. Press **<F2>** or **<Enter>** *once* to stop playing the CD.  
Press **<F2>** or **<Enter>** *one more time* to eject the CD.

## 5.4 AI Net feature

The motherboard supports the Marvell® Virtual Cable Tester (VCT) Technology. The VCT virtually diagnoses and reports cable faults using the Time Domain Reflectometry (TDR) tool. The VCT technology detects and reports open and shorted cables with up to one meter of accuracy. It also detects impedance mismatches, pair swaps, pair polarity problems, and pair skew problems of up to 64 ns.

VCT remarkably reduces networking and support costs complementing a highly manageable and controlled network system. This tool can be incorporated in the network systems software making it ideal for field support as well as development diagnostics.

### Using the Virtual Cable Tester™

To use the the Marvell® Virtual Cable Tester™ on your computer:

1. Click the **Start** button. Select **All Programs->Marvell->Virtual Cable Tester**.
2. From the menu, click **Virtual Cable Tester**. The following screen appears.

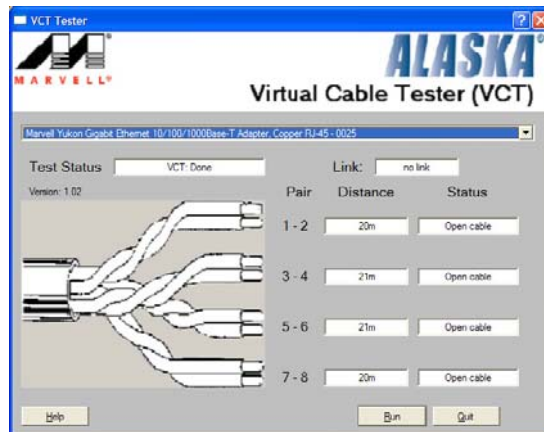

3. Click on **Run** to execute test.



1. The Virtual Cable Tester™ (VCT) feature is supported in Windows® XP™ and Windows® 2000™ operating systems only.
2. The Virtual Cable Tester™ (VCT) feature works on Gigabit LAN only.
3. The **Run** button on the VCT Tester dialog box is disabled if no problem is detected on the network.

## 5.5 SoundMAX® 4 XL software

The ADI AD1985 AC '97 audio CODEC provides 6-channel audio capability through the SoundMAX®4 XL with AudioESP™ software to deliver the ultimate audio experience on your PC. The software implements high quality audio synthesis/rendering, 3D sound positioning, and advanced voice-input technologies.

Follow the installation wizard install the **SoundMAX® Audio Driver and Application** from the support CD that came with the motherboard package to activate the 6-channel audio feature.



- You must use 4-channel or 6-channel speakers for this setup.
- SoundMAX® 4 XL requires Microsoft® Windows® 98SE/ME/2000/XP. Make sure that one of these operating systems is installed before installing SoundMAX®.

If the SoundMAX® 4 XL software is correctly installed, you will find the SoundMAX® 4 XL icon on the taskbar.



SoundMAX® 4 XL icon

From the taskbar, double-click on the **SoundMAX4® XL** icon to display the **SoundMAX® Control Panel**.



## Setup wizards

Use the speaker and microphone setup wizards to fine tune the gain/attenuation of the inputs/outputs for optimal audio performance. You may launch the setup wizards by clicking the Configuration button when AudioESP detects and verifies a newly connected peripheral, or by clicking on the  icon from the SoundMAX control panel.

### Speaker wizard

Follow the screen instructions to configure the speakers to your desired settings.

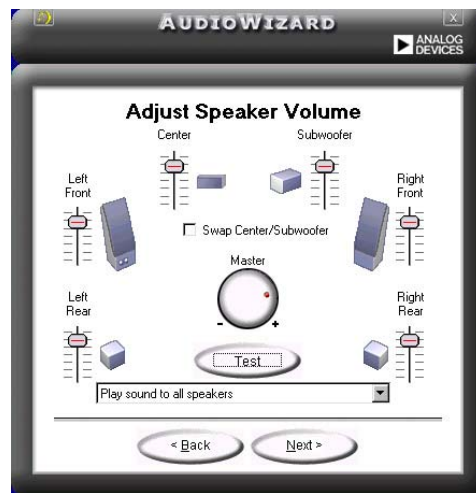
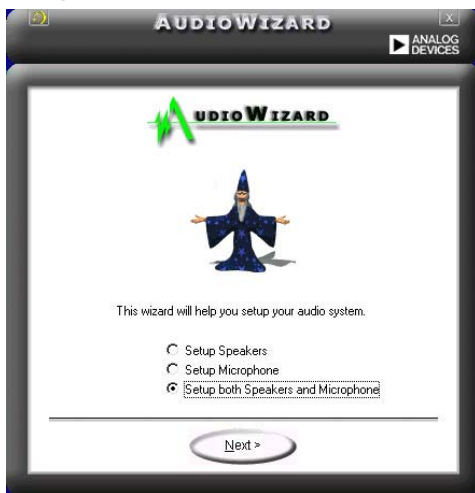

### Microphone wizard

Follow the screen instructions to configure the microphone to your desired settings.

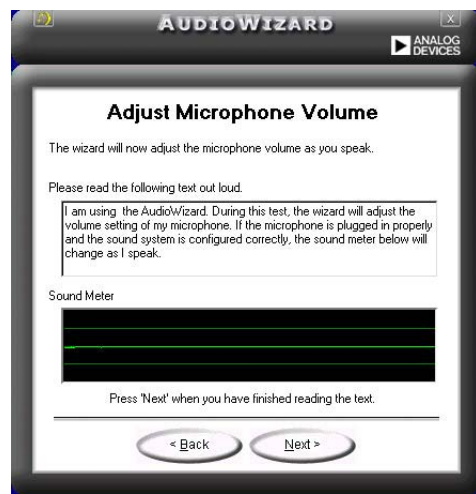

## Audio preferences

The Preferences page of the SoundMAX4 XL allows you to change various audio settings.

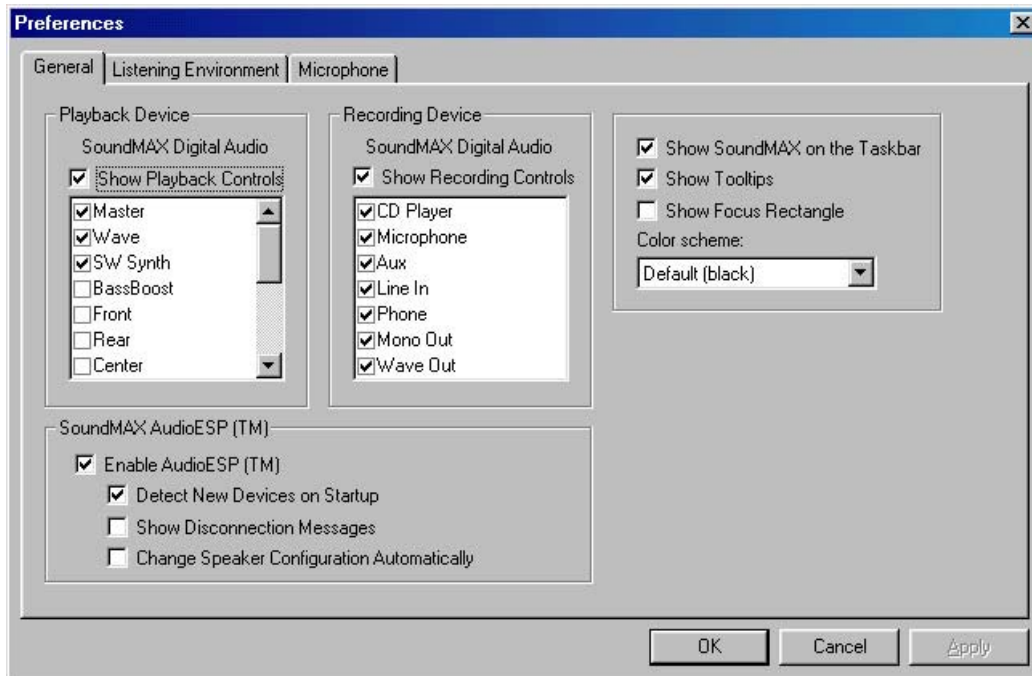

## Listening environment options

The SoundMAX4 XL support several audio technologies including SoundMAX SPX™ Animated Audio, 3DPA™, MultiDrive™ 5.1, EnvironmentFC™, MacroFX/ZoomFX™, and Virtual Theater Surround.

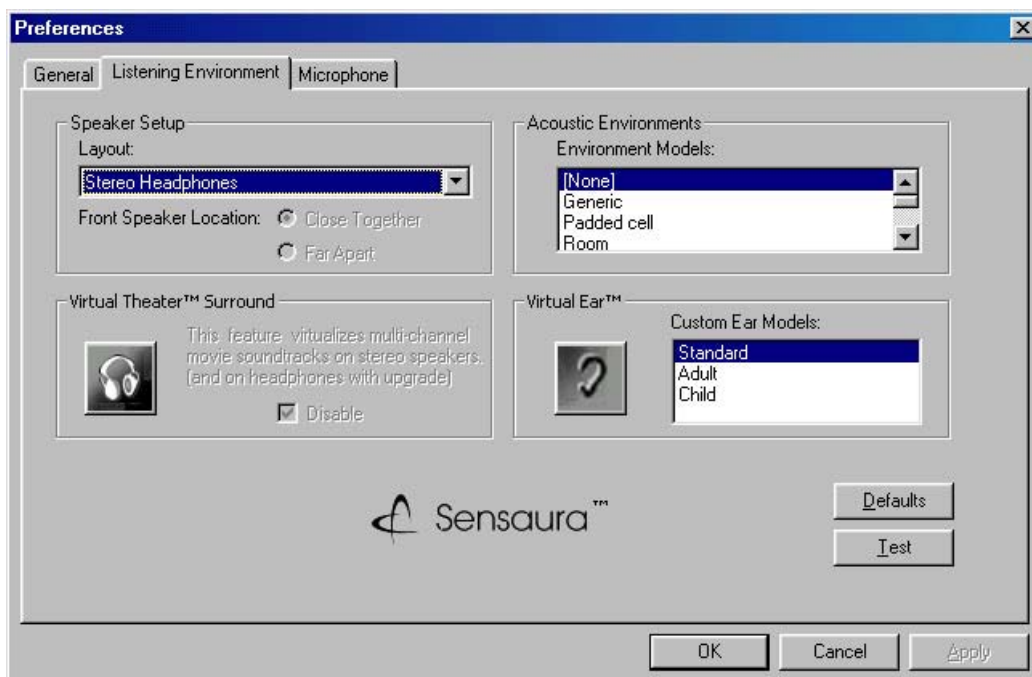

## Rear panel audio ports function variation

The functions of the Line Out (lime), Line In (blue), and Mic (pink) ports on the rear panel change when you select the 4-channel or 6-channel audio configuration as shown in the following table.

	<b>Headphone/ 2-Speaker</b>	<b>4-Speaker</b>	<b>6-Speaker</b>
Light Blue	Line In	Rear Speaker Out	Rear Speaker Out
Lime	Line Out	Front Speaker Out	Front Speaker Out
Pink	Mic In	Mic In	Bass/Center

## 5.6 Intel® RAID for Serial ATA configuration (for Windows 2000 and Windows XP only)

This motherboard supports Intel® RAID 0 and RAID 1 for Serial ATA drives through the Intel® ICH5R chipset. The **Serial ATA as RAID** option must be enabled in the BIOS before the system can load the Intel® RAID Option ROM code for Intel® RAID. The Intel® RAID Option ROM is a standard PnP (Plug and Play) option ROM that provides a pre-operating system user interface for the Intel® RAID implementation. It also allows the boot order to be selected from within the BIOS setup utility.



---

For more information about the Intel® RAID for SATA configuration, refer to the Intel Application Accelerator, RAID Edition, User's manual in "\Manual\NAA RAID Manual.doc" of the support CD.

---

### 5.6.1 BIOS Configuration

1. Turn ON the system and enter BIOS by pressing the **Delete** key during the Power-On Self Test (POST).
2. From the BIOS screen, select the **Main** menu then the **IDE Configuration** menu.
3. If necessary, switch the **Onboard IDE Operate Mode** option from [Legacy Mode] to [Enhanced Mode].
4. Switch the **Configure S-ATA as RAID** option to [Yes].
5. Press **<F10>** to save the BIOS settings and exit the BIOS setup program.

### 5.6.2 Installing Serial ATA (SATA) hard disks

Installing Serial ATA (SATA) hard disks requires the use of a new SATA data cable (4-conductor) which supports the Serial ATA protocol and a SATA power cable. Any end of the SATA data cable can be connected to the SATA hard disk or the SATA connector on the motherboard.



- 
1. Both the data and power SATA cables are new cables. You cannot use the older 40-pin 80-conductor IDE or regular IDE power cables with SATA hard drives.
  2. Carefully follow any technical instructions that come from the hard disk manufacturer.
- 

To install the Serial ATA cable:

1. Attach either cable end to the SATA connector on the motherboard.
2. Attach the other cable end to the SATA hard disk.
3. Connect the SATA power cables.

## 5.6.3 Creating, Deleting, and Resetting RAID Sets

The Serial ATA RAID set must be configured in the RAID Configuration utility. This configuration can be done by the Intel® RAID Option ROM. During the Power-On Self Test (POST), the following message will appear for a few seconds: “Press <Ctrl-I> to enter Raid Configuration Utility”. When this message appears, press <Ctrl+I> to launch the RAID configuration utility.

```
Copyright (C) 2003 Intel Corporation. All Rights Reserved. v3.x.x.xxxx
[ MAIN MENU ]
1. Create RAID Volume
2. Delete RAID Volume
3. Reset Disks to Non-RAID
4. Exit

[ DISK/VOLUME INFORMATION ]
RAID Volumes:
None defined.

Non-RAID Disks:
Port Drive Model      Serial #      Size      Status      Bootable
0 ST380013AS          xxxxxxxx    74.5GB    Normal      Yes
1 ST380013AS          xxxxxxxx    74.5GB    Normal      Yes

[ +↑ ] -Select      [ ESC ] Exit      [ Enter ] -Select Menu
```

## 5.6.4 Creating a RAID Volume

To create a RAID volume:

1. Select **1. Create RAID Volume** and press <Enter> . The following screen appears.

```
Copyright (C) 2003 Intel Corporation. All Rights Reserved. v3.x.x.xxxx
[ CREATE ARRAY MENU ]
Name: RAID Volume1
RAID Level: RAID0 (Stripe)
Strip Size: 128KB
Capacity: 149.0GB
Create Volume

[ HELP ]
Enter a string between 1 and 16 characters in length that can be used
to uniquely identify the RAID volume. This name is case sensitive and
can not contain special characters.

[ ↓↑ ] -Change      [ TAB ] -Next      [ ESC ] Previous Menu      [ Enter ] -Select
```



2. Key-in a unique name for your RAID volume then press **<Enter>**.
3. Use the Up and Down arrow keys to select your desired RAID Level then press **<Enter>**.
4. If you selected RAID 0 (Stripe), use the Up and Down arrow keys to select the stripe size for your RAID 0 array then press **<Enter>**. The available values range from 8 KB to 128 KB. The strip value should be chosen based on the planned drive usage. Some suggested selections are listed below. The default selection is 64 KB.
  - 16 KB - low disk usage
  - 64 KB - typical disk usage
  - 128 KB - performance disk usage
5. On the Create Volume prompt, press **<Enter>** to create the array. The utility prompts a confirmation message, press **<Y>**.

Are you sure you want to create this volume (Y/N)

6. Select **4 Exit** then press **<Enter>** to exit the RAID configuration utility. The utility prompts a confirmation message, press **<Y>**.

## 5.6.5 Deleting a RAID Volume

```

Copyright (C) 2003 Intel Corporation. All Rights Reserved. v3.x.x.xxxx
----- [ DELETE ARRAY MENU ] -----
Name          Level          Drives    Capacity  Status    Bootable
RAID Volume1  RAID0(Stripe)  2         149.0GB  Normal    Yes
-----
----- [ HELP ] -----
Deleting a volume will destroy the volume data on the drive(s) and
cause any member disks to become available as non-RAID disks.
WARNING: EXISTING DATA WITHING THIS VOLUME WILL BE LOST AND NON-RECOVERABLE
-----
[ ↓↑ ] -Change  [ TAB ] -Next  [ <ESC> ] -Previous Menu  [ <DEL> ] -Delete Volume

```



Take caution in using this option; All data on the RAID drives will be lost!

To delete a RAID volume:

1. Select **2 Delete RAID Volume** then press **<Enter>**.

2. Press **<Del>** to delete the RAID volume.

```
[ VOLUME DELETE VERIFICATION ]

Are you sure you want to delete this volume?
ALL DATA IN THE VOLUME WILL BE LOST!!

Are you sure you want to delete volume "RAID_Volume1"? (Y/N)
```

3. The utility prompts a verification message, press **<Y>**.

## 5.6.6 Reset RAID Data

```
Copyright(C) 2003 Intel Corporation. All Rights Reserved. v3.x.x.xxxx

[ MAIN MENU ]

1. Create RAID Volume
2. Delete RAID Volume
3. Reset Disks to Non-RaID
4. Exit

[ DISK/VOLUME INFORMATION ]

RAID Volumes:
None defined.

Non-RAID Disks:
Port Drive Model Serial # Size Status Bootable
0 ST380013AS xxxxxxxx 74.5GB Normal Yes
1 ST380013AS xxxxxxxx 74.5GB Normal Yes

[ ↓↑ ] -Select [ ESC ] Exit [ Enter ] -Select Menu
```



Take caution when using this option. All data on the RAID drives and all internal RAID structures will be lost!

To reset RAID data and remove any RAID structures in the drives:

1. Select **3 Reset RAID Data** and press **<Enter>**.

```
[ RESET ALL DATA RAID DATA ]

Resetting all RAID data will remove any internal RAID structures
from all RAID disks, including disks with working volumes. These
structures are used to maintain the RAID volumes. By removing
these structures, the drive will revert back to a Non-RAID disk
that can then be used or reallocated to a new RAID volume.

WARNING: Selecting "Yes" will cause all data on any RAID disk
(RAID Volume or Other RAID Disk) to be lost.

Are you sure you want to destroy all RAID data (Y/N):
```

2. The utility prompts a confirmation message, press **<Y>**.

## 5.7 Creating a RAID driver disk

A floppy disk with the Intel® RAID driver is required when installing Windows® XP/2000 operating system. You can create a RAID driver disk using the Makedisk.exe utility in the support CD.

To create a RAID driver disk:

1. Insert the motherboard support CD into the CD-ROM drive and locate the Makedisk.exe utility for your RAID controller.

The Makedisk.exe utility for the Intel® RAID driver is located in “\Drivers\Chipset\AA\Makedisk.exe” of the motherboard support CD.



---

The Makedisk.exe utility for Intel® RAID is supported in Windows® XP/2000 only.

---

2. Insert a clean floppy disk into the floppy disk drive and execute Makedisk.exe. Follow succeeding screen instructions to complete the process.
3. Write-protect the floppy disk to avoid computer virus infection.

To install the RAID driver:

1. During the OS installation, the system prompts you to press the **F6** key to install third-party SCSI or RAID driver.
2. Press **<F6>** then insert the RAID disk driver into the floppy disk drive.
3. Follow the succeeding screen instructions to complete the installation.



# QUICK REFERENCE CARD

## P4P800 SE

ASUS Motherboard

Refer to the Quick Setup Guide when installing components or devices for the items indicated in this reference card.

