



P4R800-VM

User Guide

Motherboard

E1662

Revised Edition V4

May 2004

Copyright © 2004 ASUSTeK COMPUTER INC. All Rights Reserved.

No part of this manual, including the products and software described in it, may be reproduced, transmitted, transcribed, stored in a retrieval system, or translated into any language in any form or by any means, except documentation kept by the purchaser for backup purposes, without the express written permission of ASUSTeK COMPUTER INC. ("ASUS").

Product warranty or service will not be extended if: (1) the product is repaired, modified or altered, unless such repair, modification or alteration is authorized in writing by ASUS; or (2) the serial number of the product is defaced or missing.

ASUS PROVIDES THIS MANUAL "AS IS" WITHOUT WARRANTY OF ANY KIND, EITHER EXPRESS OR IMPLIED, INCLUDING BUT NOT LIMITED TO THE IMPLIED WARRANTIES OR CONDITIONS OF MERCHANTABILITY OR FITNESS FOR A PARTICULAR PURPOSE. IN NO EVENT SHALL ASUS, ITS DIRECTORS, OFFICERS, EMPLOYEES OR AGENTS BE LIABLE FOR ANY INDIRECT, SPECIAL, INCIDENTAL, OR CONSEQUENTIAL DAMAGES (INCLUDING DAMAGES FOR LOSS OF PROFITS, LOSS OF BUSINESS, LOSS OF USE OR DATA, INTERRUPTION OF BUSINESS AND THE LIKE), EVEN IF ASUS HAS BEEN ADVISED OF THE POSSIBILITY OF SUCH DAMAGES ARISING FROM ANY DEFECT OR ERROR IN THIS MANUAL OR PRODUCT.

SPECIFICATIONS AND INFORMATION CONTAINED IN THIS MANUAL ARE FURNISHED FOR INFORMATIONAL USE ONLY, AND ARE SUBJECT TO CHANGE AT ANY TIME WITHOUT NOTICE, AND SHOULD NOT BE CONSTRUED AS A COMMITMENT BY ASUS. ASUS ASSUMES NO RESPONSIBILITY OR LIABILITY FOR ANY ERRORS OR INACCURACIES THAT MAY APPEAR IN THIS MANUAL, INCLUDING THE PRODUCTS AND SOFTWARE DESCRIBED IN IT.

Products and corporate names appearing in this manual may or may not be registered trademarks or copyrights of their respective companies, and are used only for identification or explanation and to the owners' benefit, without intent to infringe.

Contents

Notices	vi
Safety information	vii
About this guide	viii
P4R800-VM specifications summary	ix

Chapter 1: Product introduction

1.1 Welcome!	1-2
1.2 Package contents	1-2
1.3 Special features	1-2
1.4 Before you proceed	1-5
1.5 Motherboard overview	1-6
1.5.1 Motherboard layout	1-6
1.5.2 Placement direction	1-7
1.5.3 Screw holes	1-7
1.6 Central Processing Unit (CPU)	1-8
1.6.1 Overview	1-8
1.6.2 Installing the CPU	1-9
1.7 System memory	1-10
1.7.1 DIMM sockets location	1-10
1.7.2 Memory configurations	1-10
1.7.3 Installing a DIMM	1-12
1.8 Expansion slots	1-12
1.8.1 Standard interrupt assignments	1-13
1.8.2 IRQ assignments for this motherboard	1-13
1.8.3 PCI slots	1-14
1.8.4 AGP slot	1-14
1.9 Jumpers	1-15
1.10 Connectors	1-17
1.10.1 Rear panel connectors	1-17
1.10.2 Internal connectors	1-18

Contents

Chapter 2: BIOS information

2.1	Managing and updating your BIOS	2-2
2.1.1	Creating a bootable floppy disk	2-2
2.1.2	Using AFUDOS to copy the current BIOS	2-3
2.1.3	Using AFUDOS to update the BIOS	2-4
2.1.4	Using ASUS EZ Flash to update the BIOS	2-5
2.1.5	Recovering the BIOS with CrashFree BIOS 2	2-6
2.2	BIOS Setup program	2-8
2.2.1	BIOS menu screen	2-9
2.2.2	Menu bar	2-9
2.2.3	Navigation keys	2-9
2.2.4	Menu items	2-10
2.2.5	Sub-menu items	2-10
2.2.6	Configuration fields	2-10
2.2.7	Pop-up window	2-10
2.2.8	Scroll bar	2-10
2.2.9	General help	2-10
2.3	Main menu	2-11
2.3.1	System Time	2-11
2.3.2	System Date	2-11
2.3.3	Legacy Diskette A	2-11
2.3.4	Primary/IDE Master/Slave Secondary IDE Master/Slave	2-12
2.3.5	System Information	2-13
2.4	Advanced menu	2-14
2.4.1	CPU Configuration	2-14
2.4.2	Chipset	2-15
2.4.3	Onboard Devices Configuration	2-17
2.4.4	PCI PnP	2-18
2.5	Power menu	2-19
2.5.1	Suspend Mode	2-19
2.5.2	Repost Video on S3 Resume	2-19
2.5.3	ACPI 2.0 Support	2-19
2.5.4	ACPI APIC Support	2-19
2.5.5	APM Configuration	2-20
2.5.6	Hardware Monitor	2-21

Contents

2.6	Boot menu	2-22
2.6.1	Boot Device Priority	2-22
2.6.2	Boot Settings Configuration	2-23
2.6.3	Security	2-24
2.7	Exit menu	2-26

Chapter 3: Software support

3.1	Install an operating system	3-2
3.2	Support CD information	3-2
3.2.1	Running the support CD	3-2
3.2.2	Drivers menu	3-3
3.2.3	Utilities menu	3-3
3.2.4	ASUS Contact Information	3-4

Notices

Federal Communications Commission Statement

This device complies with FCC Rules Part 15. Operation is subject to the following two conditions:

- This device may not cause harmful interference, and
- This device must accept any interference received including interference that may cause undesired operation.

This equipment has been tested and found to comply with the limits for a Class B digital device, pursuant to Part 15 of the FCC Rules. These limits are designed to provide reasonable protection against harmful interference in a residential installation. This equipment generates, uses and can radiate radio frequency energy and, if not installed and used in accordance with manufacturer's instructions, may cause harmful interference to radio communications. However, there is no guarantee that interference will not occur in a particular installation. If this equipment does cause harmful interference to radio or television reception, which can be determined by turning the equipment off and on, the user is encouraged to try to correct the interference by one or more of the following measures:

- Reorient or relocate the receiving antenna.
- Increase the separation between the equipment and receiver.
- Connect the equipment to an outlet on a circuit different from that to which the receiver is connected.
- Consult the dealer or an experienced radio/TV technician for help.



The use of shielded cables for connection of the monitor to the graphics card is required to assure compliance with FCC regulations. Changes or modifications to this unit not expressly approved by the party responsible for compliance could void the user's authority to operate this equipment.

Canadian Department of Communications Statement

This digital apparatus does not exceed the Class B limits for radio noise emissions from digital apparatus set out in the Radio Interference Regulations of the Canadian Department of Communications.

This class B digital apparatus complies with Canadian ICES-003.

Safety information

Electrical safety

- To prevent electrical shock hazard, disconnect the power cable from the electrical outlet before relocating the system.
- When adding or removing devices to or from the system, ensure that the power cables for the devices are unplugged before the signal cables are connected. If possible, disconnect all power cables from the existing system before you add a device.
- Before connecting or removing signal cables from the motherboard, ensure that all power cables are unplugged.
- Seek professional assistance before using an adapter or extension cord. These devices could interrupt the grounding circuit.
- Make sure that your power supply is set to the correct voltage in your area. If you are not sure about the voltage of the electrical outlet you are using, contact your local power company.
- If the power supply is broken, do not try to fix it by yourself. Contact a qualified service technician or your retailer.

Operation safety

- Before installing the motherboard and adding devices on it, carefully read all the manuals that came with the package.
- Before using the product, make sure all cables are correctly connected and the power cables are not damaged. If you detect any damage, contact your dealer immediately.
- To avoid short circuits, keep paper clips, screws, and staples away from connectors, slots, sockets and circuitry.
- Avoid dust, humidity, and temperature extremes. Do not place the product in any area where it may become wet.
- Place the product on a stable surface.
- If you encounter technical problems with the product, contact a qualified service technician or your retailer.

About this guide

Conventions used in this guide

To make sure that you perform certain tasks properly, take note of the following symbols used throughout this guide.



WARNING: Information to prevent injury to yourself when trying to complete a task.



CAUTION: Information to prevent damage to the components when trying to complete a task.



IMPORTANT: Information that you **MUST** follow to complete a task.



NOTE: Tips and additional information to aid in completing a task.

Where to find more information

Refer to the following sources for additional information and for product and software updates.

1. ASUS websites

The ASUS websites worldwide provide updated information on ASUS hardware and software products. Refer to the ASUS contact information.

2. Optional documentation

Your product package may include optional documentation, such as warranty flyers, that may have been added by your dealer. These documents are not part of the standard package.

P4R800-VM specifications summary

CPU	Socket 478 for Intel® Pentium® 4 Northwood processor Intel® Hyper-Threading technology ready New power design for next generation Intel® Prescott CPU
Chipset	ATI RADEON™ 9100 IGP ATI IXP200
Front Side Bus (FSB)	800/533/400 MHz
Memory	4 x 184-pin DDR DIMM sockets Up to 4 GB system memory Supports unbuffered non-ECC PC3200*/2700/2100/1600 DDR DIMMs. (*Supports one single-sided PC3200 [DDR400] DIMM per channel only)
Expansion slots	1 x AGP 8X/4X (1.5V only) 3 x PCI
VGA	ATI Radeon™ 9200 integrated graphics
Storage	2 x UltraATA100/66, PIO Mode 0 ~ 4
Audio	ADI AD1888 6-channel audio CODEC
LAN	IXP200 built in MAC with Realtek 8201BL/CL LAN PHY
Hardware monitoring	Super I/O integrated monitoring of CPU/chassis fan rotation and MB/CPU temperature
Special features	Digital audio via an S/PDIF out interface TV out support ASUS MyLogo2 ASUS EZ Flash ASUS Q-Fan Technology ASUS CrashFree BIOS2
Rear panel I/O	1 x Parallel port 1 x VGA port 1 x S/PDIF port 1 x PS/2 keyboard port 1 x PS/2 mouse port 4 x USB 2.0/USB 1.1 ports 1 x LAN (RJ-45) port Line In/Line Out/Microphone ports

(continued on the next page)

P4R800-VM specifications summary

Internal I/O	1 x USB 2.0/1.1 connector for 2 additional USB ports CPU and chassis fan connectors 20-pin/4-pin ATX 12V power connectors CD/AUX audio connectors Front panel audio connector Panel connectors COM connector TV-out connector Power LED connector**
BIOS features	4Mb Flash EEPROM, AMI BIOS with enhanced ACPI, DMI, Green, PnP features, SM BIOS2.3, ASUS CrashFree BIOS2, ASUS MyLogo2, and ASUS EZ Flash
Industry standard	PCI 2.2, USB 2.0/1.1
Form Factor	Micro-ATX form factor: 9.6 in x 9.6 in (24.5 cm x 24.5 cm)
Support CD contents	Device drivers ASUS PC Probe ASUS LiveUpdate ASUS Screensaver Adobe Acrobat Reader Trend Micro™ PC-cillin 2002 anti-virus software Microsoft® DirectX 8.1

* Specifications are subject to change without notice.

** Present only on PCB version 1.03 or later.

Chapter 1

This chapter describes the features of this motherboard. It includes brief descriptions of the motherboard components, and illustrations of the layout, jumper settings, and connectors.

Product introduction

1.1 Welcome!

Thank you for buying the ASUS® P4R800-VM motherboard!

The ASUS P4R800-VM motherboard delivers a host of new features and latest technologies making it another standout in the long line of ASUS quality motherboards!

Before you start installing the motherboard, and hardware devices on it, check the items in your package with the list below.

1.2 Package contents

Check your P4R800-VM package for the following items.

- ✓ ASUS P4R800-VM motherboard
Micro-ATX form factor: 9.6 in x 9.6 in (24.5 cm x 24.5 cm)
- ✓ ASUS P4R800-VM series support CD
- ✓ Serial (COM) port module and cable
- ✓ 80-conductor Ultra ATA IDE cable
- ✓ Ribbon cable for a 3.5-inch floppy drive
- ✓ I/O shield
- ✓ Bag of extra jumper caps
- ✓ User Guide



If any of the above items is damaged or missing, contact your retailer.

1.3 Special features

Intel® 800MHz FSB CPU support



The motherboard comes with a 478-pin surface mount, Zero Insertion Force (ZIF) socket for the Intel® Pentium® 4 Northwood/Willamette processor in the 478-pin package with 512/256KB L2 cache on 0.13 micron process. This motherboard supports 800/533/400 MHz system front side bus that allows 6.4GB/s, 4.3GB/s and 3.2GB/s data transfer rates, respectively. The P4R800-VM also supports the Intel® Hyper-Threading Technology and the next-generation Intel® Prescott CPU.

See page 1-8.

ATi RADEON 9100 IGP/IXP200 chipset



The embedded RADEON™ 9100 Integrated Graphics Processor (IGP) Northbridge and the IXP200 Southbridge chipset control all interfaces to ensure an efficient and reliable computing performance. **See page 2-15 and 2-16.**

The RADEON™ 9100 IGP provides processor interface with 800/533/400 MHz frequency, system memory interface at 400/333/266/200MHz operation, and 1.5V AGP interface that supports AGP 8X specification.

The IXP 200 (SB200) is a subsystem that integrates various I/O functions including dual-channel ATA100 bus master IDE controller, up to six USB 2.0/1.1 ports, I/O APIC interrupt and Ethernet controllers, and LPC, AC'97 2.2 interfaces, Ethernet controller, and PCI 2.2 interface. The proprietary A-Link interface connects the IXP 200 with the RADEON™ IGP at up to 266MB/s data transfer rate.

Dual channel DDR400 memory support

The motherboard supports single or dual memory architecture for up to 4GB system memory. Four 184-pin DIMM sockets are available for installation of unbuffered non-ECC PC3200/2700/2100/1600 DDR DIMMs. **See page 1-10.**

ATi RADEON 9200-based GPU

Integrated in the IGP chipset is the ATi RADEON™ 9200-based 2D/3D graphics engine with maximum 128MB shared display memory. The integrated graphics also supports TV out function through a separate TV out module (AV/S). The RADEON 9200-based GPU achieves a maximum resolution of 2048x1536 at 32bpp. **See page 1-20.**

Integrated 10/100 Mbps LAN MAC

The integrated MAC in the IXP 200 Southbridge works with the onboard Realtek 8201BL/CL LAN PHY to fully support 10BASE-T/ 100BASE-TX Ethernet networking. **See page 1-17.**

SoundMAX digital audio system

The SoundMax Digital Audio System is the industry's highest performance and most reliable audio solution for business professionals, audiophiles, musicians, and gamers. SoundMAX Digital Audio System can output 5.1 channel surround and features state-of-the-art DLS2 MIDI synthesizer with Yamaha DLSbyXG sound set, 5.1 Virtual Theater™ and supports all major game audio technologies including Microsoft DirectX™8.0, Microsoft DirectSound 3D™, A3D, MacroFX, ZoomFX, MultiDrive 5.1 and EAX. **See page 1-17.**

USB 2.0 connectivity

The motherboard rear panel comes with four (4) Universal Serial Bus (USB) ports to connect USB 2.0 devices. A USB header is also available at mid-board to accommodate a USB module for two (2) additional USB ports. The USB ports and header comply with USB 2.0 specification that supports up to 480 Mbps connection speed. This speed advantage over the conventional USB 1.1 (12 Mbps) allows faster Internet connection, interactive gaming, and simultaneous running of high-speed peripherals. USB 2.0 is backward compatible with USB 1.1. **See pages 1-17 and 1-21.**

CrashFree BIOS2

This feature allows you to restore the original BIOS data from the support CD, or from a bootable floppy disk, when the BIOS codes and data are corrupted. This protection eliminates the need to buy a replacement ROM chip. **See page 2-6.**

ASUS Q-Fan technology

The ASUS Q-Fan technology smartly adjusts the fan speeds according to the system loading to ensure quiet, cool, and efficient operation. **See page 2-21.**

ASUS EZ Flash BIOS

With the ASUS EZ Flash, you can easily update the system BIOS even before loading the operating system. No need to use a DOS-based utility or boot from a floppy disk. **See page 2-5.**

ASUS MyLogo2

This new feature present in the motherboard allows you to personalize and add style to your system with customizable boot logos. The ASUS MyLogo2 is automatically installed when you install the ASUS Update utility from Utilities menu in the support CD. **See page 3-3.**

1.4 Before you proceed

Take note of the following precautions before you install motherboard components or change any motherboard settings.



1. Unplug the power cord from the wall socket before touching any component.
2. Use a grounded wrist strap or touch a safely grounded object or to a metal object, such as the power supply case, before handling components to avoid damaging them due to static electricity.
3. Hold components by the edges to avoid touching the ICs on them.
4. Whenever you uninstall any component, place it on a grounded antistatic pad or in the bag that came with the component.
5. **Before you install or remove any component, ensure that the ATX power supply is switched off or the power cord is detached from the power supply.** Failure to do so may cause severe damage to the motherboard, peripherals, and/or components.

Onboard LED

The motherboard comes with a stand-by power LED. The green LED lights up to indicate that the system is ON, in sleep mode, or in soft-off mode. The LED reminds you to shut down the system and unplug the power cable before removing or plugging in any motherboard component. The illustration below shows the location of the onboard LED.

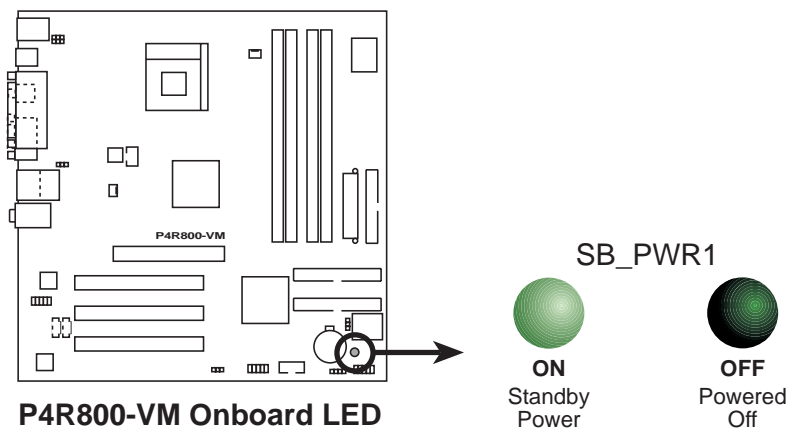

1.5 Motherboard overview

1.5.1 Motherboard layout

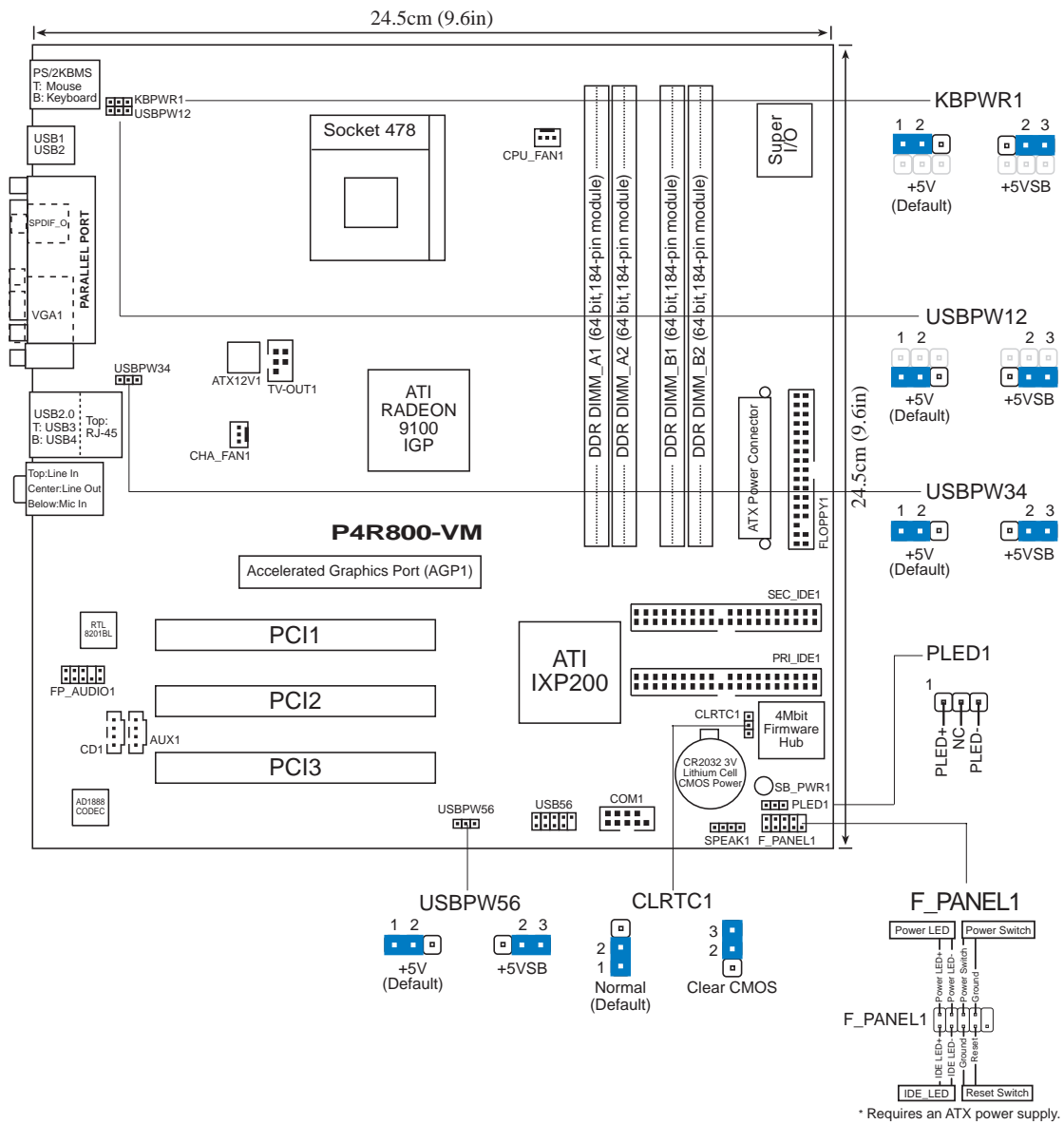

1.5.2 Placement direction

When installing the motherboard, make sure that you place it into the chassis in the correct orientation. The edge with external ports goes to the rear part of the chassis as indicated in the image below.

1.5.3 Screw holes

Place eight (8) screws into the holes indicated by circles to secure the motherboard to the chassis.



Do not overtighten the screws! Doing so may damage the motherboard.

Place this side towards
the rear of the chassis



1.6 Central Processing Unit (CPU)

1.6.1 Overview

The Intel® Pentium® 4 processor has a gold triangular mark on one corner. This mark indicates the processor Pin 1 that should match a specific corner of the CPU socket.

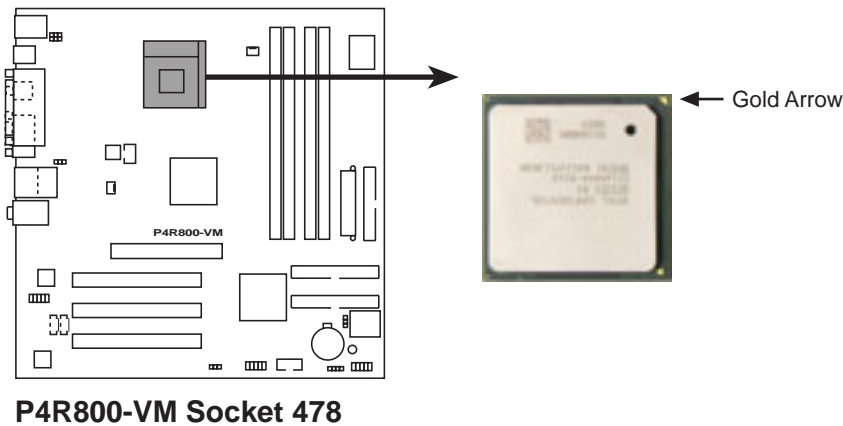

Incorrect installation of the CPU into the socket may bend the pins and severely damage the CPU!

Notes on Intel® Hyper-Threading Technology



- Hyper-Threading Technology is supported under **Windows® XP** and **Linux 2.4.x (kernel)** and later versions only. Under Linux, use the Hyper-Threading compiler to compile the code. If you are using any other operating systems, disable the Hyper-Threading Technology item in BIOS to ensure system stability and performance.
 - It is recommended that you install Windows® XP Service Pack 1.
 - Make sure to enable the Hyper-Threading Technology item in BIOS before installing a supported operating system.
 - For more information on Hyper-Threading Technology, visit www.intel.com/info/hyperthreading.
-

1.6.2 Installing the CPU

Follow these steps to install a CPU.

1. Locate the 478-pin ZIF socket on the motherboard.
2. Unlock the socket by pressing the lever sideways, then lift it up to a 90°-100° angle.



Make sure that the socket lever is lifted up to 90°-100° angle, otherwise the CPU does not fit in completely.

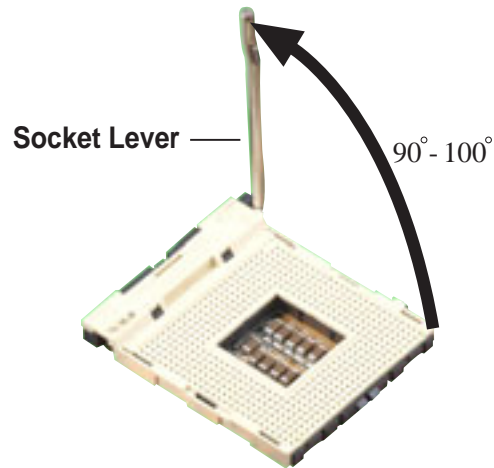

3. Position the CPU above the socket such that its marked corner matches the base of the socket lever.
4. Carefully insert the CPU into the socket until it fits in place.



The CPU fits only in one correct orientation. DO NOT force the CPU into the socket to prevent bending the pins and damaging the CPU!

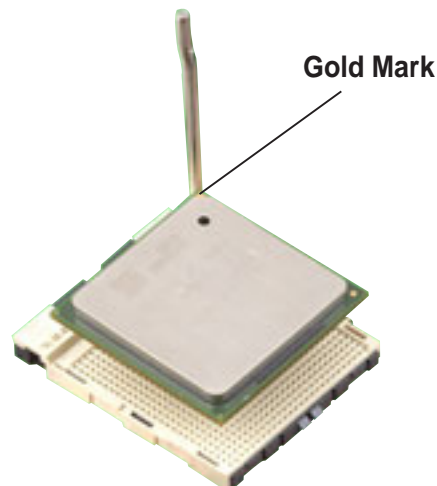

5. When the CPU is in place, push down the socket lever to secure the CPU. The lever clicks on the side tab to indicate that it is locked.
6. Install a CPU heatsink and fan following the instructions that came with the heatsink package.
7. Connect the CPU fan cable to the CPU_FAN1 connector on the motherboard.



1.7 System memory

1.7.1 DIMM sockets location

The following figure illustrates the location of the DDR DIMM sockets.

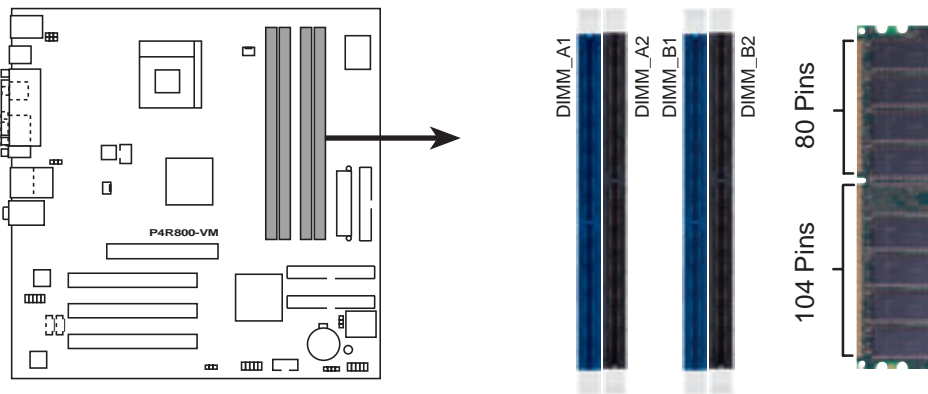

P4R800-VM 184-Pin DDR DIMM Sockets



Make sure to unplug the power supply before adding or removing DIMMs or other system components. Failure to do so may cause severe damage to both the motherboard and the components.

When installing long AGP cards, it is recommended to install the memory modules first. Long AGP cards, when installed, may interfere with the memory sockets.

1.7.2 Memory configurations

You may install 64MB, 128MB, 256MB, 512MB, and 1GB DDR DIMMs into the DIMM sockets using the memory configurations in this section.

Important notes



- Installing DDR DIMMs other than the recommended configurations may cause memory sizing error or system boot failure. Use any of the recommended configurations in Table 1.
- A three-DIMM configuration is not supported on this motherboard
- In dual-channel configurations, always install an **identical** (the same type and size) DDR DIMM pair on sockets of the same color.
- Always install DIMMs with the same CAS latency. For optimum compatibility, it is recommended that you obtain memory modules from the same vendor.

Table 1: Recommended memory configurations

Mode/DIMM Type		Sockets			
		DIMM_A1 (blue)	DIMM_A2 (black)	DIMM_B1 (blue)	DIMM_B2 (black)
Single-channel (PC3200/PC2700/ PC2100/PC1600)	(1)	Populated	—	—	—
	(2)	—	Populated	—	—
	(3)	—	—	Populated	—
	(4)	—	—	—	Populated
Dual-channel (PC2700/PC2100/ PC1600)	(1)	Populated	—	Populated	—
	(2)	—	Populated	—	Populated
	(3)*	Populated	Populated	Populated	Populated
Dual-channel (PC3200)	(1)	Populated <i>(Single-sided)</i>	—	Populated <i>(Single-sided)</i>	—

* For dual-channel configuration (3), you may:

- install identical DIMMs in all four sockets or
- install identical DIMM pair in DIMM_A1 and DIMM_B1 (blue sockets) and identical DIMM pair in DIMM_A2 and DIMM_B2 (black sockets)



- This motherboard supports one single-sided PC3200 (DDR400) DIMM per channel only.
- This motherboard may only detect PC2700 (DDR333) system memory when you install two PC3200 (DDR400) DIMMs in one channel or when you install double-sided PC3200 (DDR400) DIMMs.

Table 2: Qualified DDR400 vendors list

This table lists the memory modules that have been tested and qualified for use with this motherboard.

Size	Vendor	Part Number	Chip Brand	Sides	Chip Number
256MB	TwinMOS	—	Winbond	SS	W94508BH-5
256MB	HYNIX	HYMD232646A8J	HYNIX	SS	HY5DU56822AT-U43
256MB	Samsung	M368L3223DTM-CC4	Samsung	SS	K4H560838D TCC4
256MB	Corsair	CM256A-3500C2PT	—	SS	—
256MB	Kingston	VALUERAM KVR400X64C25/256	Winbond	SS	W942508BH-5
256MB	Transcend	TS32MLD64V4F3	MOSEL	SS	V58C2256804SAT5

Legend: DS — Double-sided SS — Single-sided



Obtain DDR DIMMs only from ASUS qualified vendors. Visit the ASUS website (www.asus.com) for the latest QVL.

1.7.3 Installing a DIMM

Follow these steps to install a DIMM.

1. Unlock a DIMM socket by pressing the retaining clips outward.
2. Align a DIMM on the socket such that the notch on the DIMM matches the break on the socket.
3. Firmly insert the DIMM into the socket until the retaining clips snap back in place and the DIMM is properly seated.

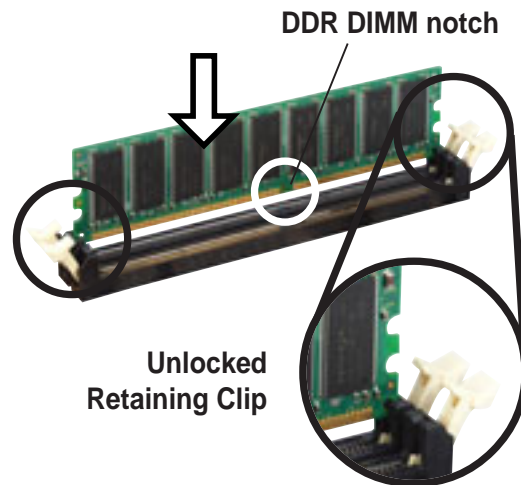

A DDR DIMM is keyed with a notch so that it fits in only one direction. **DO NOT** force a DIMM into a socket to avoid damaging the DIMM.

1.8 Expansion slots

To install and configure an expansion card:

1. Install an expansion card following the instructions that came with the chassis.
2. Turn on the system and change the necessary BIOS settings, if any. See Chapter 2 for BIOS information.
3. Assign an IRQ to the card. Refer to the tables next page.
4. Install the drivers and/or software applications for the expansion card according to the card documentation.

1.8.1 Standard interrupt assignments

IRQ	Priority	Standard Function
0	1	System Timer
1	2	Keyboard Controller
2	N/A	Programmable Interrupt
3*	11	Communications Port (COM2)
4*	12	Communications Port (COM1)
5*	13	IRQ holder for PCI steering
6	14	Floppy Disk Controller
7*	15	Printer Port (LPT1)
8	3	System CMOS/Real Time Clock
9*	4	IRQ holder for PCI steering
10*	5	Advance AC'97 CODEC
11*	6	Standard PCI Graphics Adapter (VGA)
12*	7	PS/2 Compatible Mouse Port
13	8	Numeric Data Processor
14*	9	Primary IDE Channel
15*	10	Secondary IDE Channel

* These IRQs are usually available for ISA or PCI devices.

1.8.2 IRQ assignments for this motherboard

	A	B	C	D
PCI slot 1	—	—	shared	—
PCI slot 2	—	—	—	shared
PCI slot 3	shared	—	—	—
AGP slot	shared	—	—	—
Onboard USB controller 1	—	—	—	shared
Onboard USB controller 2	—	—	—	shared
Onboard USB controller 3	—	—	—	shared
Onboard USB 2.0 controller	—	—	—	shared
Onboard LAN	—	—	shared	—
Onboard audio	—	used	—	—



When using PCI cards on shared slots, ensure that the drivers support “Share IRQ” or that the cards do not need IRQ assignments. Otherwise, conflicts will arise between the two PCI groups, making the system unstable and the card inoperable.

1.8.3 PCI slots

The PCI slots support PCI cards such as a LAN card, SCSI card, USB card, and other cards that comply with PCI specifications.

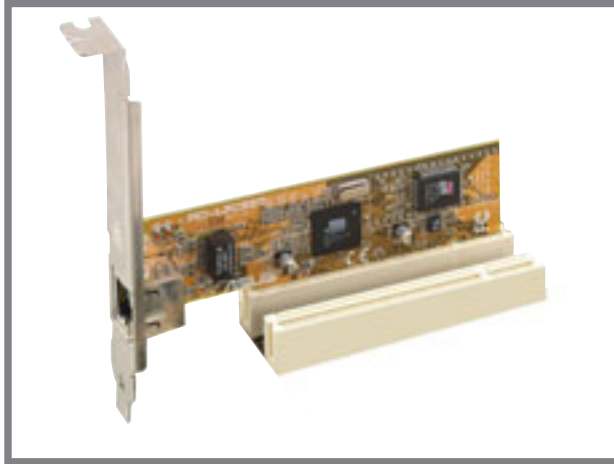

1.8.4 AGP slot

The Accelerated Graphics Port (AGP) slot that supports AGP 8X/4X (+1.5V) cards. When you buy an AGP card, make sure that you ask for one with +1.5V specification.

Note the notches on the card golden fingers to ensure that they fit the AGP slot on the motherboard.



This motherboard does not support 3.3V AGP cards. Install only +1.5V AGP cards.

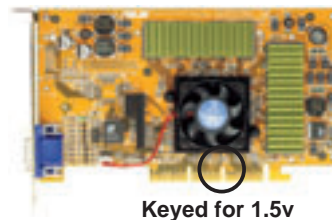
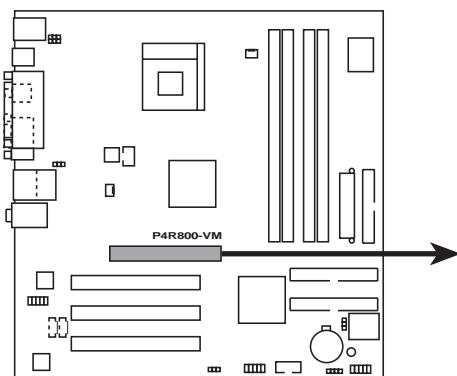

P4R800-VM Accelerated Graphics Port (AGP)

1.9 Jumpers

1. Clear RTC RAM (CLRRTC1)

This jumper allows you to clear the Real Time Clock (RTC) RAM in CMOS. You can clear the CMOS memory of date, time, and system setup parameters by erasing the CMOS RTC RAM data. The RAM data in CMOS, that include system setup information such as system passwords, is powered by the onboard button cell battery.

To erase the RTC RAM:

1. Turn OFF the computer and unplug the power cord.
2. Remove the onboard battery.
3. Move the jumper cap from pins 1-2 (default) to pins 2-3. Keep the cap on pins 2-3 for about 5~10 seconds, then move the cap back to pins 1-2.
4. Re-install the battery.
5. Plug the power cord and turn ON the computer.
6. Hold down the key during the boot process and enter BIOS setup to re-enter data.



Except when clearing the RTC RAM, never remove the cap on CLRRTC1 jumper default position. Removing the cap will cause system boot failure!

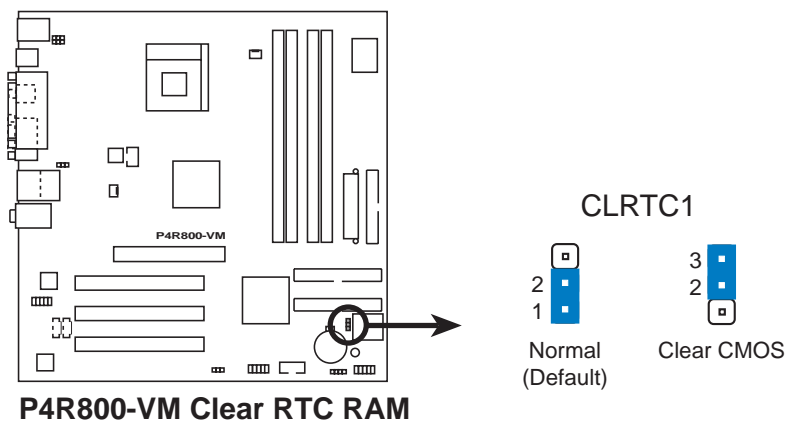

2. USB device wake-up (3-pin USBPW12, USBPW34, USBPW56)

Set these jumpers to +5V to wake up the computer from S1 sleep mode (CPU stopped, DRAM refreshed, system running in low power mode) using the connected USB devices. Set to +5VSB to wake up from S3 sleep mode (no power to CPU, DRAM in slow refresh, power supply in reduced power mode). Both jumpers are set to pins 1-2 (+5V) by default because not all computers have the appropriate power supply to support this feature.

The USBPW_12 and USBPW_34 jumpers are for the rear USB ports. The USBPW_56 jumper is for the internal USB connector that you can connect to the front USB ports.



1. This feature requires a power supply that can provide at least 1A on the +5VSB lead when these jumpers are set to +5VSB. Otherwise, the system would not power up.
2. The total current consumed must NOT exceed the power supply capability (+5VSB) whether under normal condition or in sleep mode.

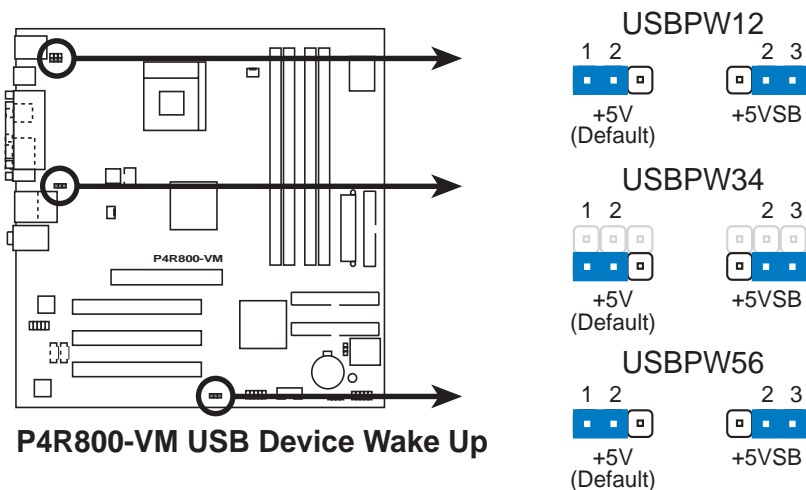

3. Keyboard power (3-pin KBPWR1)

This jumper allows you to enable or disable the keyboard wake-up feature. Set this jumper to pins 2-3 (+5VSB) if you wish to wake up the computer when you press a key on the keyboard (the default is the Space Bar). This feature requires an ATX power supply that can supply at least 1A on the +5VSB lead, and a corresponding setting in the BIOS (see 2.5.5 “**APM Configuration**”).

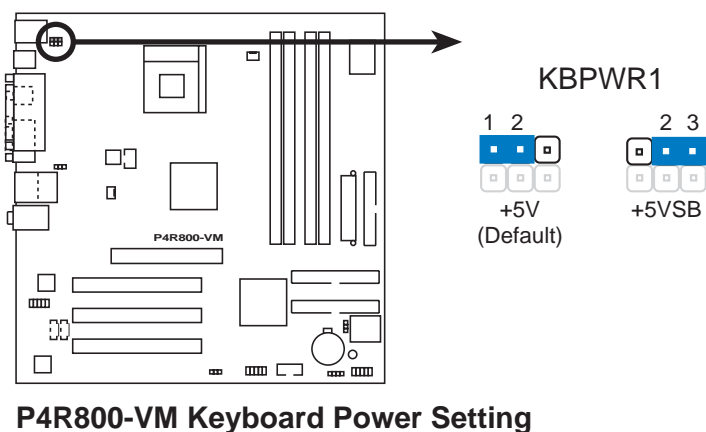

1.10 Connectors

This section describes and illustrates the motherboard rear panel and internal connectors.

1.10.1 Rear panel connectors

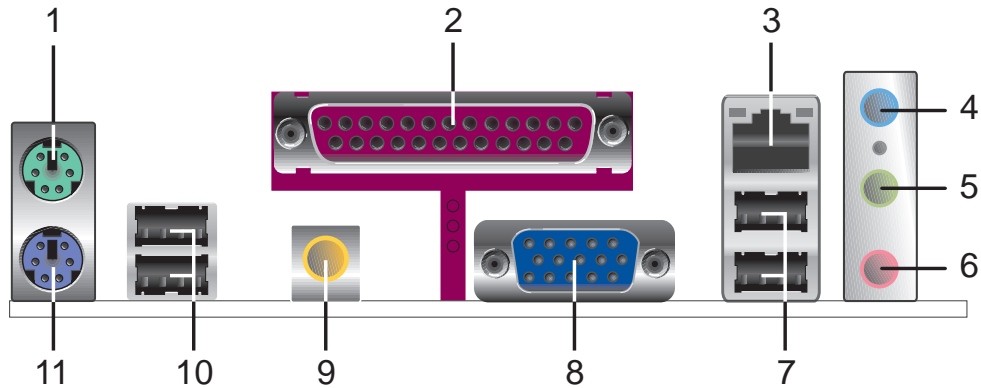

1. **PS/2 mouse port.** This green 6-pin port is for a PS/2 mouse.
2. **Parallel port.** This 25-pin port connects a parallel printer or a scanner.
3. **RJ-45 port.** This port allows connection to a Local Area Network (LAN) through a network hub.
4. **Line In port (light blue).** This port connects a tape player or other audio sources. In 6-channel mode, the function of this port becomes Bass/Center.
5. **Line Out port (lime).** This port connects a headphone or a speaker. In 6-channel mode, the function of this port becomes Front Speaker Out.
6. **Microphone port (pink).** This port connects a microphone. In 6-channel mode, the function of this port becomes Rear Speaker Out.



The functions of the Line Out, Line In, and Microphone ports change when you select the 6-channel audio configuration as shown in the following table.

Audio ports function variation

Port	Headphone/ 2-Speaker	4-Speaker	6-Speaker
Light Blue	Line In	Line In	Bass/Center
Lime	Line Out	Front Speaker Out	Front Speaker Out
Pink	Mic In	Rear Speaker Out	Rear Speaker Out

7. **USB 2.0 ports 1 and 2.** These two 4-pin Universal Serial Bus (USB) ports are available for connecting USB 2.0 devices.
8. **VGA port.** This port connects a VGA compatible monitor.
9. **S/PDIF out port.** This port connects to external audio output devices.
10. **USB 2.0 ports 3 and 4.** These two 4-pin Universal Serial Bus (USB) ports are available for connecting USB 2.0 devices.
11. **PS/2 keyboard port.** This purple port is for a PS/2 keyboard.

1.10.2 Internal connectors

1. IDE connectors (40-1 pin PRI_IDE1, SEC_IDE1)

This connector supports the provided Ultra ATA 100 IDE hard disk drive cable. Connect the cable's blue connector to the primary (recommended) or secondary IDE connector, then connect the gray connector to the Ultra ATA 100 slave device (hard disk drive) and the black connector to the Ultra ATA 100 master device.



- Follow the hard disk drive documentation when setting the device in master or slave mode.
- Pin 20 on each IDE connector is removed to match the covered hole on the Ultra ATA cable connector. This prevents incorrect orientation when you connect the cables.
- The hole near the blue connector on the Ultra ATA cable is intentional.

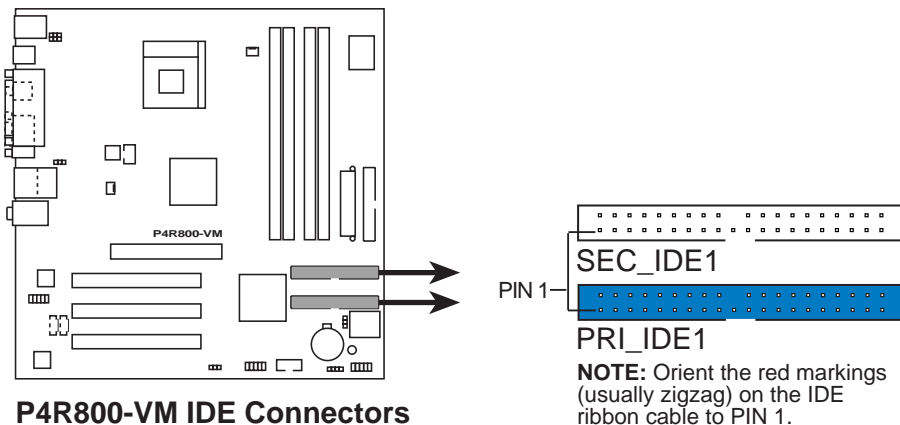

2. Floppy disk drive connector (34-1 pin FLOPPY1)

This connector supports the provided floppy disk drive cable. After connecting one end of the cable to this connector, insert the other end to the signal connector at the back of the floppy drive. (Pin 5 is removed to prevent incorrect insertion when using ribbon cables with pin 5 plug).

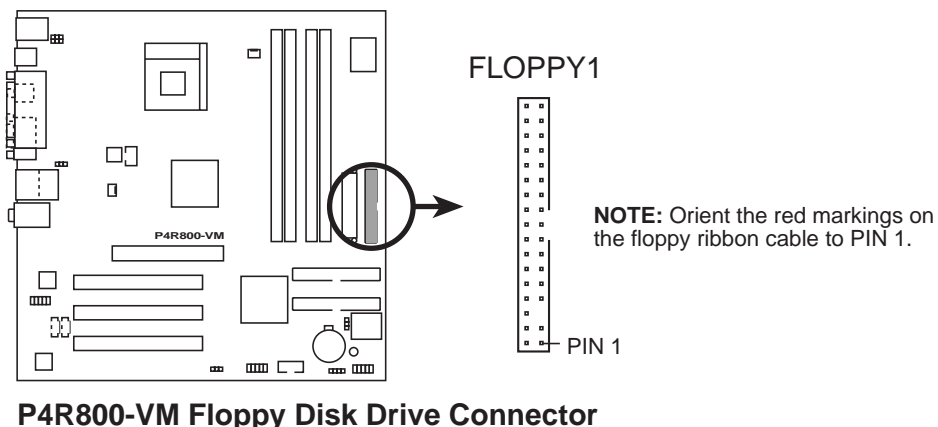

3. ATX power connectors (20-pin ATXPWR1, 4-pin ATX12V1)

These connectors are for the ATX power supply. The plugs from the power supply are designed to fit these connectors in only one orientation. Find the proper orientation and push down firmly until the connectors completely fit.

In addition to the 20-pin ATXPWR connector, this motherboard requires that you connect the 4-pin ATX +12V power plug to provide sufficient power to the CPU.



Make sure that your ATX 12V power supply can provide 8A on the +12V lead and at least 1A on the +5-volt standby lead (+5VSB). The minimum recommended wattage is 230W, or 300W for a fully configured system. The system may become unstable and may experience difficulty powering up if the power supply is inadequate.

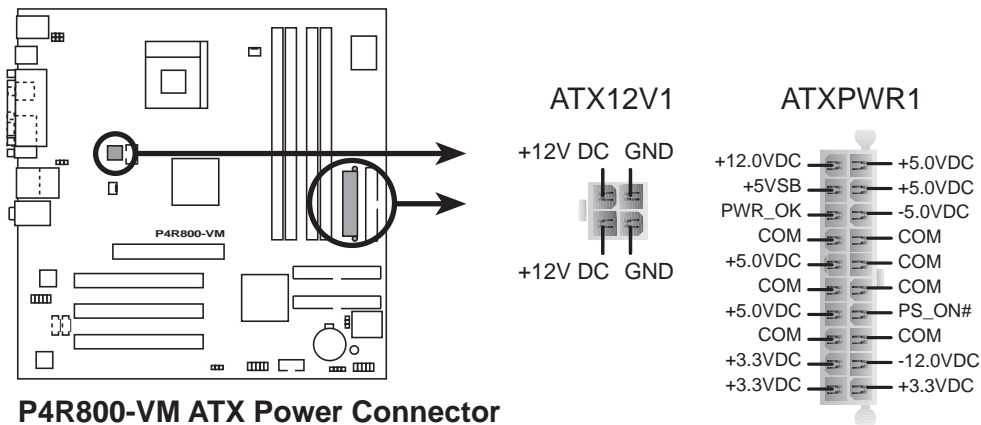

4. Internal audio connectors (4-pin CD1, AUX1)

These connectors allow you to receive stereo audio input from sound sources such as a optical drive, TV tuner, or MPEG card.

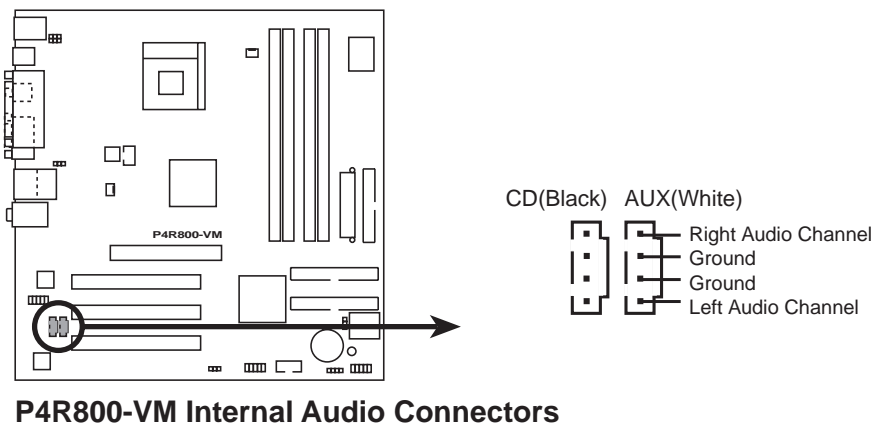

5. TV out connector (6-1 pin U38)

This connect is for a front or rear panel I/O board with an audio TV-out port.

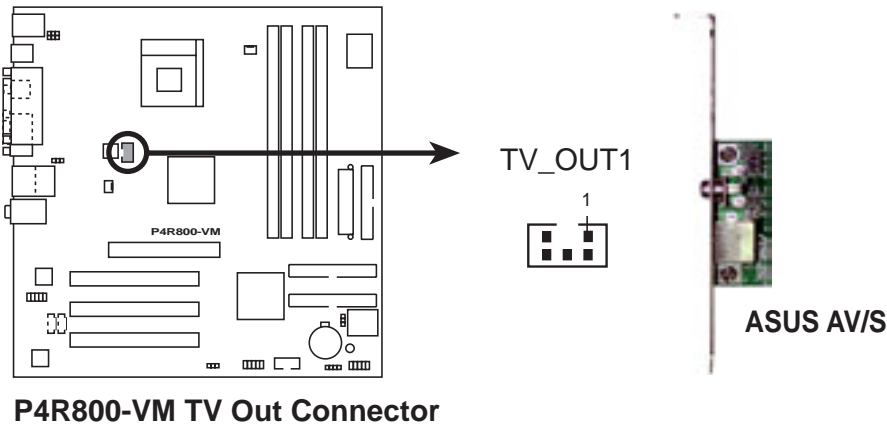

The ASUS AV/S module is purchased separately.

6. CPU and chassis fan connectors (3-pin CPU_FAN1, CHA_FAN1)

The fan connectors support cooling fans of 350mA~740mA (8.88W max.) or a total of 1A~2.22A (26.64W max.) at +12V. Connect the fan cables to the fan connectors on the motherboard, making sure that the black wire of each cable matches the ground pin of the connector.



Do not forget to connect the fan cables to the fan connectors. Lack of sufficient air flow within the system may damage the motherboard components. These are not jumpers! DO NOT place jumper caps on the fan connectors!

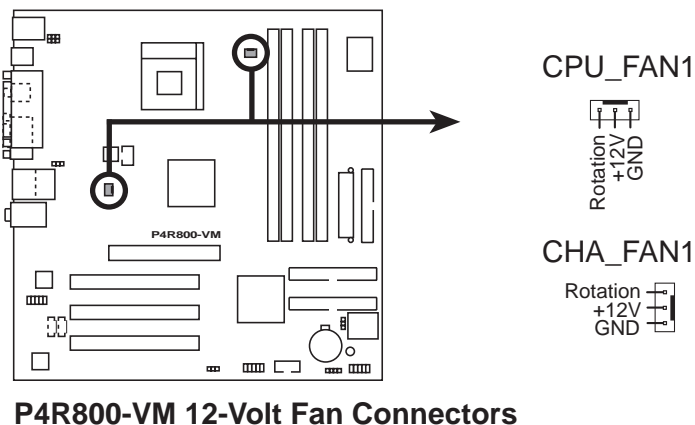

7. Speaker out connector (4-pin SPEAK1)

This connector connects to the case-mounted speaker and allows you to hear system beeps and warnings.

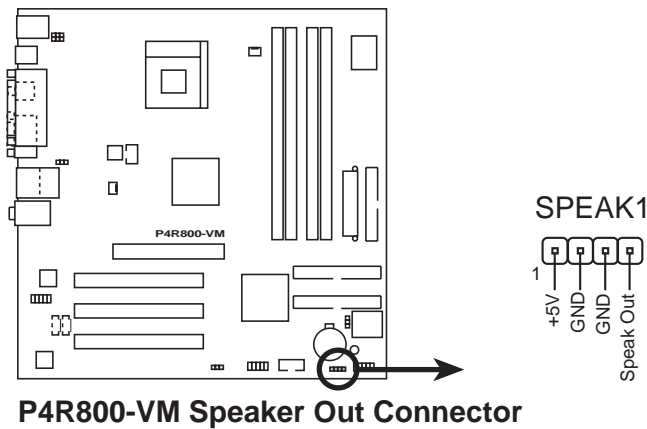

8. USB header (10-1 pin USB56)

If the USB ports on the rear panel are inadequate, a USB header is available for additional USB ports. Connect the USB cable of an optional USB 2.0 module to this header. You may install the USB module in the chassis front panel. The module has two USB 2.0 ports for connecting next generation USB peripherals such as high resolution cameras, scanners, and printers.

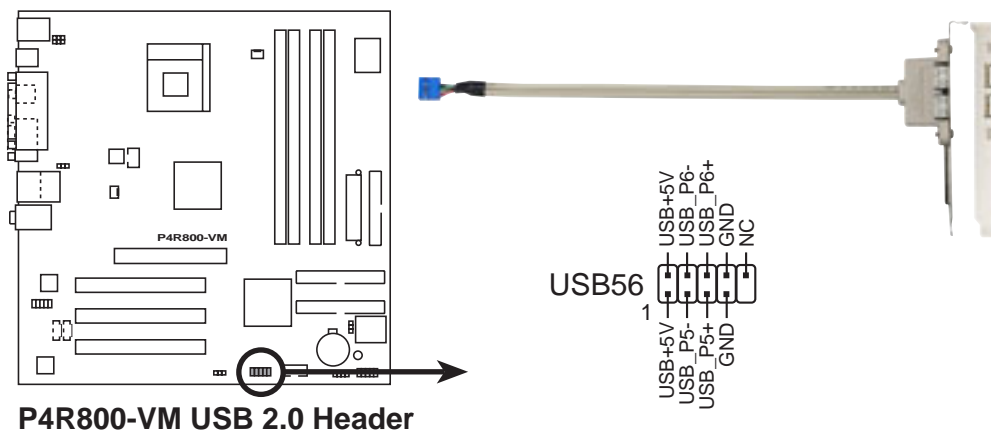

The USB module is purchased separately.

9. Front panel audio connector (10-1 pin FP_AUDIO1)

This is an interface for the front panel cable that allows convenient connection and control of audio devices.

By default, the pins labeled LINE OUT_R/BLINE_OUT_R and the pins LINE OUT_L/BLINE_OUT_L are shorted with jumper caps. Remove the caps only when you are connecting the front panel audio cable.

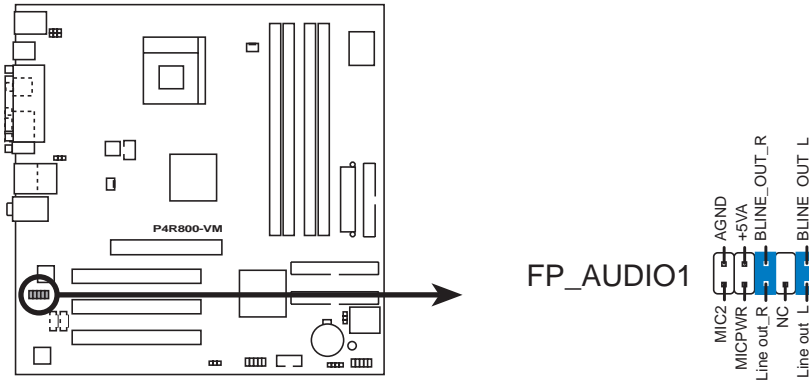

P4R800-VM Front Panel Audio Connector

10. Serial port connector (10-1 pin COM1)

This green connector accommodates the bundled serial port module. Install the module into a slot opening at the back of the system chassis, then insert the module's green cable plug to this connector.

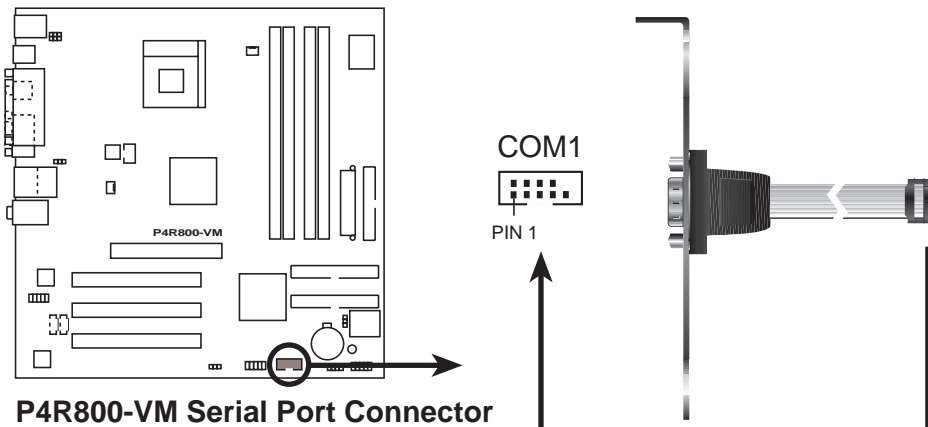

P4R800-VM Serial Port Connector

11. Power LED Lead (3-1 pin PLED1)

This 3-1 pin connector is for the system power LED. Connect the 3-pin power LED cable from the system chassis to this connector. The LED lights up when you turn on the system power, and blinks when the system is in sleep mode.



The power LED lead (PLED1) is present only on PCB versions 1.03 or later.

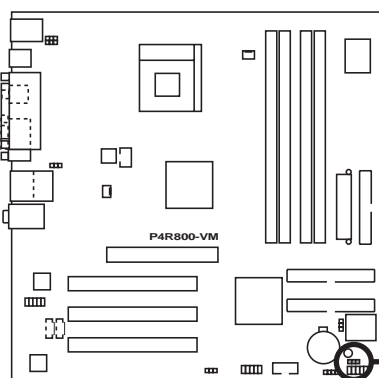

P4R800-VM PLED Setting

PLED1

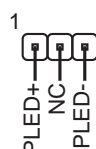

12. System panel connector (10-1 pin F_PANEL1)

This connector accommodates several chassis-mounted functions.

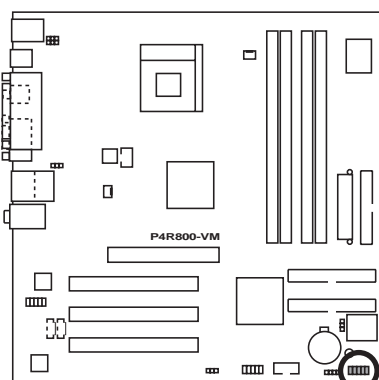

P4R800-VM F_Panel Connector

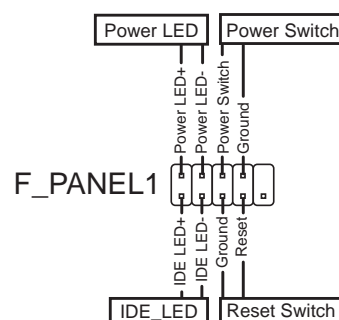

- **Power LED (2-pin PWR_LED)**

This connector is for the system power LED. The LED lights up when you turn on the system power, and blinks when the system is in sleep mode.

If your motherboard package comes with a 2-pin to 3-pin power LED converter, connect the 2-pin plug to this connector, and the other end to the 3-pin power LED plug from the system chassis.

- **Power Button/Soft-Off Button (2-pin PWR_BTN)**

This connector is for the system power button that controls the system power. Pressing the power button turns the system ON or puts the system to SLEEP or SOFT OFF mode, depending on the BIOS or OS settings. Pressing the power button more than 4 seconds while the system is ON turns the system OFF.

- **IDE LED (2-pin IDE_LED)**

This connector supplies power to the hard disk drive activity LED. The read or write activities of any device connected to the primary or secondary IDE connector cause this LED to light up.

- **Reset Button (2-pin RESET)**

This 2-pin connector is for the chassis-mounted reset button for rebooting the system without turning off the system power.

Chapter 2

This chapter tells how to change system settings through the BIOS Setup menus. Detailed descriptions of the BIOS parameters are also provided.

BIOS information

2.1 Managing and updating your BIOS

The following utilities allow you to manage and update the motherboard Basic Input/Output System (BIOS) setup.

1. **AFUDOS** (*Updates the BIOS in DOS mode using a bootable floppy disk.*)
2. **ASUS EZ Flash** (*Updates the BIOS using a floppy disk during POST.*)
3. **ASUS CrashFree BIOS 2** (*Updates the BIOS using a bootable floppy disk or the support CD when the BIOS gets corrupted.*)
4. **ASUS Update** (*Updates the BIOS in Windows® environment.*)

Refer to the corresponding section for each utility.



Important notes

- It is recommended that you save a copy of the **original motherboard BIOS file** to a **bootable floppy disk** in case you need to restore the BIOS in the future. Copy the original motherboard BIOS using the AFUDOS or the ASUS Update utilities.
 - A **working BIOS file** for this motherboard is in the support CD. Use this file only when you do not have a copy of the original motherboard BIOS file in a floppy disk.
 - Visit the ASUS website and download the latest BIOS file for this motherboard using the ASUS Update utility.
-

2.1.1 Creating a bootable floppy disk

1. Do either one of the following to create a bootable floppy disk.

DOS environment

Insert a 1.44 MB floppy disk into the drive. At the DOS prompt, type:

format A:/S then press <Enter>.

Windows® environment

- a. From your Windows desktop, click on **Start**, point to **Settings**, then click on **Control Panel**.
 - b. Double-click on **Add/Remove Programs** icon from the Control Panel window.
 - c. Click on the **Startup Disk** tab, then on **Create Disk...** button.
 - d. Insert a 1.44 MB floppy disk when prompted. Follow the succeeding screen instructions to complete the process.
2. Copy the original (or the latest) motherboard BIOS to the bootable floppy disk.

2.1.2 Using AFUDOS to copy the current BIOS

The AFUDOS is a DOS-based application that lets you update the BIOS file using a bootable floppy diskette. AFUDOS also allows you to copy the original BIOS file to a floppy diskette.

You can use the current BIOS file as backup in case the system BIOS file fails or gets corrupted during the flashing process.

To copy the current BIOS file:

1. At the DOS prompt, type the command line:

afudos /o<filename>

where “filename” can be any user provided filename of not more than eight (8) alpha-numeric characters for the main filename and three (3) alpha-numeric characters for the extension name.

Press the **Enter** key.



The BIOS information on the screen is for reference only. What you see on your screen may not be exactly the same as shown.

Main filename Extension name

```
A:\>afudos /oMYBIOS03.rom
AMI Firmware Update Utility - Version 1.10
Copyright (C) 2002 American Megatrends, Inc. All rights reserved.
Reading flash ..... 0x0008CC00 (9%)
```

2. The utility will copy the current system BIOS by default to the floppy disk. Make sure that the floppy disk is not write-protected and have enough space (at least 600KB) to store the file.

```
A:\>afudos /oMYBIOS03.rom
AMI Firmware Update Utility - Version 1.10
Copyright (C) 2002 American Megatrends, Inc. All rights reserved.
Reading flash ..... done

A:\>
```

When the BIOS copy process is complete, the utility returns to the DOS prompt.

2.1.3 Using AFUDOS to update the BIOS

To update the BIOS using the AFUDOS.EXE:

1. Visit the ASUS website (www.asus.com) to download the latest BIOS file for your motherboard. Save the BIOS file to a bootable floppy disk.



Write down the BIOS file name to a piece of paper. You need to type the **exact BIOS file name** at the prompt.

2. Copy the AFUDOS.EXE utility from the support CD to the bootable floppy disk that contains the BIOS file.
3. Boot the system from the floppy disk.
4. At the DOS prompt, type the command line:

afudos /i<filename.rom>

where “filename.rom” means the latest (or original) BIOS file that you copied to the bootable floppy disk.

The screen displays the status of the update process.



The BIOS information on the screen is for reference only. What you see on your screen may not be exactly the same as shown.

```
A:\>afudos /ip4r800vm.rom
AMI Firmware Update Utility - Version 1.10
Copyright (C) 2002 American Megatrends, Inc. All rights reserved.
Reading file ..... done
Erasing flash .... done
Writing flash .... 0x0008CC00 (9%)
```



DO NOT shutdown or reset the system while updating the BIOS! Doing so may cause system boot failure!

When the BIOS update process is complete, the utility returns to the DOS prompt.

```
A:\>afudos /ip4r800vm.rom
AMI Firmware Update Utility - Version 1.10
Copyright (C) 2002 American Megatrends, Inc. All rights reserved.
Reading file ..... done
Erasing flash .... done
Writing flash .... 0x0008CC00 (9%)
Verifying flash .. done

A:\>
```

5. Reboot the system from the hard disk.

2.1.4 Using ASUS EZ Flash to update the BIOS

The ASUS EZ Flash feature allows you to easily update the BIOS without having to go through the long process of booting from a floppy disk and using a DOS-based utility. The EZ Flash is built-in the BIOS LPC chip so it is accessible by simply pressing <Alt> + <F2> during the Power-On Self Tests (POST).

To update the BIOS using ASUS EZ Flash:

1. Visit the ASUS website (www.asus.com) to download the latest BIOS file for your motherboard and rename it to **P4R800VM.ROM**. Save the BIOS file to a floppy disk.
2. Reboot the system.
3. Press <Alt> + <F2> during POST to display the following.

```
User recovery requested. Starting BIOS recovery...
Checking for floppy...
```



- If there is no floppy disk found in the drive, the error message “**Floppy not found!**” appears.
- If the correct BIOS file is not found in the floppy disk, the error message “**P4R800VM.ROM not found!**”

4. Insert the floppy disk that contains the BIOS file. If the **P4R800VM.ROM** file is found in the floppy disk, EZ Flash performs the BIOS update process and automatically reboots the system when done.



DO NOT shutdown or reset the system while updating the BIOS! Doing so may cause system boot failure!

```
User recovery requested. Starting BIOS recovery...
Checking for floppy...
Floppy found!
Reading file "p4r800vm.rom". Completed.
Start flashing...
Flashed successfully. Rebooting.
```

2.1.5 Recovering the BIOS with CrashFree BIOS 2

The CrashFree BIOS 2 is an auto-recovery tool that allows you to restore BIOS from the motherboard support CD, or from a floppy disk in case the current BIOS file fails or gets corrupted.



- Prepare the **support CD** that came with the motherboard or a **floppy disk that contains the motherboard BIOS** (P4R800VM.ROM) before proceeding with the BIOS update process.
- If you have saved a copy of the original motherboard BIOS to a bootable floppy disk, you may also use this disk to restore the BIOS. See section “2.1.1 Creating a bootable floppy disk.”

To recover the BIOS from a floppy disk:

1. Boot the system.
2. When a corrupted BIOS is detected, the following message appears.

```
Bad BIOS checksum. Starting BIOS recovery...
Checking for floppy...
```

3. Insert a floppy disk that contains the original, or the latest, BIOS file for this motherboard (P4R800VM.ROM). If the BIOS file that you downloaded from the ASUS website has a different filename (e.g. P4R800VM11.ROM), rename it to **P4R800VM.ROM**. The BIOS update process continues when the P4R800VM.ROM is found.

```
Bad BIOS checksum. Starting BIOS recovery...
Checking for floppy...
Floppy found!
Reading file "p4r800vm.rom". Completed.
Start flashing...
```



DO NOT shutdown or reset the system while updating the BIOS! Doing so may cause system boot failure!

4. When the BIOS update process is complete, reboot the system.

To recover the BIOS from the support CD:

1. Boot the system.
2. When a corrupted BIOS is detected, the following screen message appears.

```
Bad BIOS checksum. Starting BIOS recovery...
Checking for floppy...
```



The utility automatically checks the optical drive when there is no floppy disk on the floppy disk drive.

3. Place the support CD in the CD-ROM. The support CD contains the original BIOS for this motherboard.

```
Bad BIOS checksum. Starting BIOS recovery...
Checking for floppy...
Floppy not found!
Checking for CD-ROM...
CD-ROM found.
Reading file "p4r800vm.rom". Completed.
Start flashing...
```



DO NOT shutdown or reset the system while updating the BIOS! Doing so may cause system boot failure!

4. When the BIOS update process is complete, reboot the system.



The recovered BIOS may not be the latest BIOS version for this motherboard. Visit the ASUS website (www.asus.com) to download the latest BIOS file.

2.2 BIOS Setup program

This motherboard supports a programmable Low Pin Count (LPC) chip that you can update using the provided utility described in section “2.1 Managing and updating your BIOS.”

Use the BIOS Setup program when you are installing a motherboard, reconfiguring your system, or prompted to “Run Setup”. This section explains how to configure your system using this utility.

Even if you are not prompted to use the Setup program, you may want to change the configuration of your computer in the future. For example, you may want to enable the security password feature or make changes to the power management settings. This requires you to reconfigure your system using the BIOS Setup program so that the computer can recognize these changes and record them in the CMOS RAM of the LPC chip.

The LPC chip on the motherboard stores the Setup utility. When you start up the computer, the system provides you with the opportunity to run this program. Press <Delete> during the Power-On Self Test (POST) to enter the Setup utility, otherwise, POST continues with its test routines.

If you wish to enter Setup after POST, restart the system by pressing <Ctrl> + <Alt> + <Delete>, or by pressing the reset button on the system chassis. You can also restart by turning the system off and then back on. Do this last option only if the first two failed.

The Setup program is designed to make it as easy to use as possible. It is a menu-driven program, which means you can scroll through the various sub-menus and make your selections among the predetermined choices.



Because the BIOS software is constantly being updated, the following BIOS setup screens and descriptions are for reference purposes only, and may not exactly match what you see on your screen.

2.2.1 BIOS menu screen

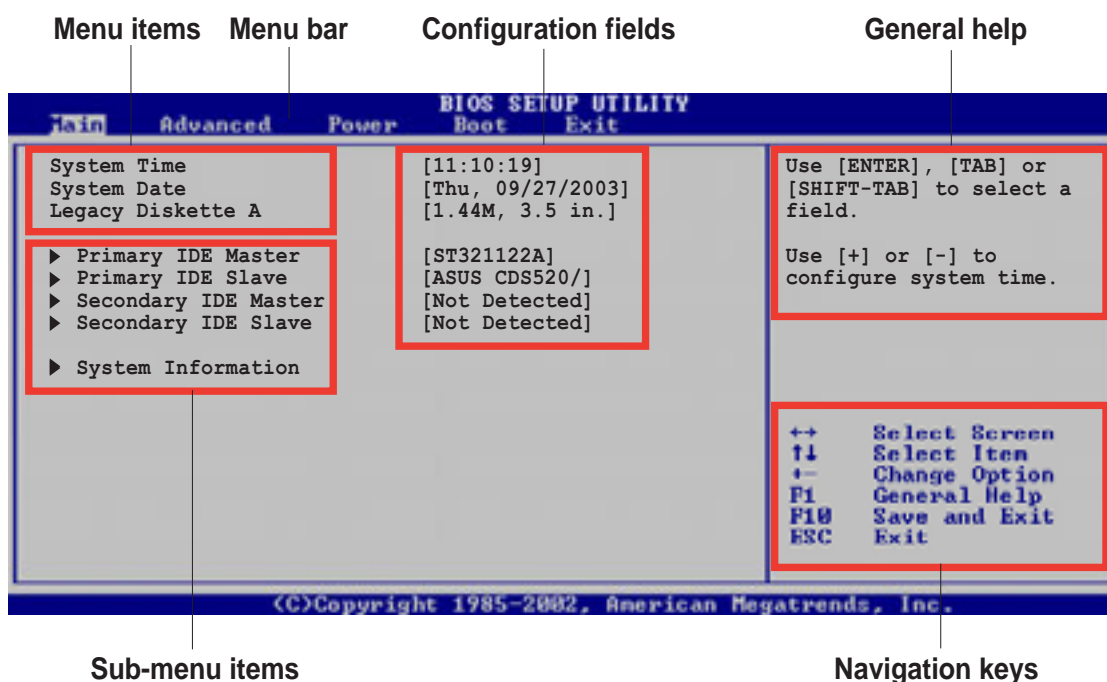

2.2.2 Menu bar

The menu bar on top of the screen has the following main items:

- Main** For changing the basic system configuration
- Advanced** For changing the advanced system settings
- Power** For changing the advanced power management (APM) configuration
- Boot** For changing the system boot configuration
- Exit** For selecting the exit options and loading default settings

To select an item on the menu bar, press the right or left arrow key on the keyboard until the desired item is highlighted.

2.2.3 Navigation keys

At the **bottom right corner** of a menu screen are the navigation keys for that particular menu. Use the navigation keys to select items in the menu and change the settings.



Some of the navigation keys differ from one screen to another.

2.2.4 Menu items

The highlighted item on the menu bar displays the specific items for that menu. For example, selecting **Main** shows the Main menu items.

The other items (Advanced, Power, Boot, and Exit) on the menu bar have their respective menu items.

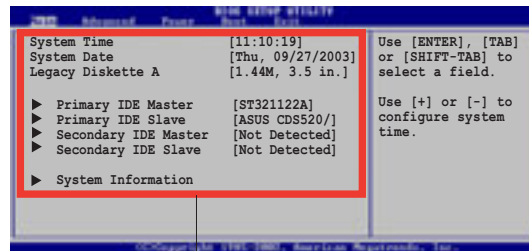

Menu items

2.2.5 Sub-menu items

An item with a sub-menu on any menu screen is distinguished by a solid triangle before the item. To display the sub-menu, select the item and press Enter.

2.2.6 Configuration fields

These fields show the values for the menu items. If an item is user-configurable, you may change the value of the field opposite the item. You can not select an item that is not user-configurable.

A configurable field is enclosed in brackets, and is highlighted when selected. To change the value of a field, select it then press Enter to display a list of options. Refer to “2.2.7 Pop-up window.”

2.2.7 Pop-up window

Select a menu item then press Enter to display a pop-up window with the configuration options for that item.

2.2.8 Scroll bar

A scroll bar appears on the right side of a menu screen when there are items that do not fit on the screen. Press **Up/Down arrow keys** or **PageUp/PageDown keys** to display the other items on the screen.

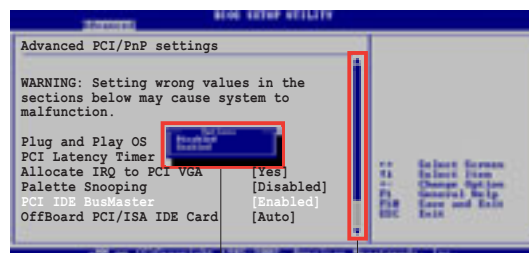

Pop-up window

Scroll bar

2.2.9 General help

At the top right corner of the menu screen is a brief description of the selected item.

2.3 Main menu

When you enter the BIOS Setup program, the Main menu screen appears giving you an overview of the basic system information.



Refer to section “2.2.1 BIOS menu screen” for information on the menu screen items and how to navigate through them.



2.3.1 System Time [xx:xx:xxxx]

This item allows you to set the system time.

2.3.2 System Date [Day xx/xx/xxxx]

This item allows you to set the system date.

2.3.3 Legacy Diskette A [1.44M, 3.5 in.]

Sets the type of floppy drive installed. Configuration options: [Disabled] [360K, 5.25 in.] [1.2M , 5.25 in.] [720K , 3.5 in.] [1.44M, 3.5 in.] [2.88M, 3.5 in.]

2.3.4 Primary IDE Master/Slave Secondary IDE Master/Slave

While entering Setup, BIOS auto-detects the presence of IDE devices. There is a separate sub-menu for each IDE device. Select a device item then press Enter to display the IDE device information.

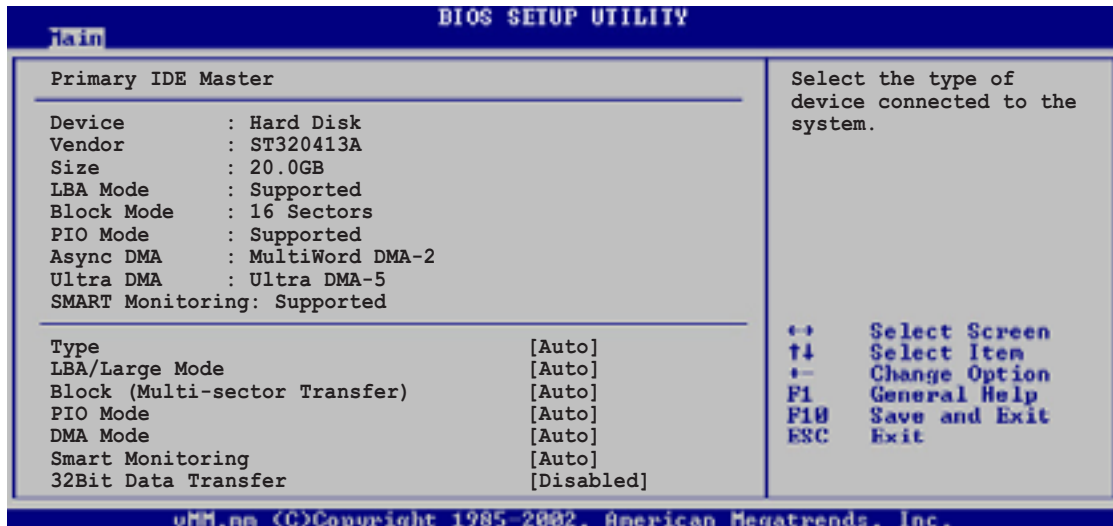

The values opposite the dimmed items (Device, Vendor, Size, LBA Mode, Block Mode, PIO Mode, Async DMA, Ultra DMA, and SMART monitoring) are auto-detected by BIOS and are not user-configurable. These items show N/A if no IDE device is installed in the system.

Type [Auto]

Selects the type of IDE drive. Configuration options: [Auto] [Not Installed] [CDROM] [ARMD]

LBA/Large Mode [Auto]

Enables or disables the LBA mode. Setting to Auto enables the LBA mode if the device supports this mode, and if the device was not previously formatted with LBA mode disabled. Configuration options: [Disabled] [Auto]

Block (Multi-sector Transfer) [Auto]

Enables or disables data multi-sectors transfers. When set to Auto, the data transfer from and to the device occurs multiple sectors at a time if the device supports multi-sector transfer feature. When set to Disabled, the data transfer from and to the device occurs one sector at a time. Configuration options: [Auto] [Disabled]

PIO Mode [Auto]

Selects the PIO mode. Configuration options: [Auto] [0] [1] [2] [3] [4]

DMA Mode [Auto]

Selects the DMA mode. Configuration options: [Auto] [SWDMA0] [SWDMA1] [SWDMA2] [MWDMA0] [MWDMA1] [MWDMA2] [UDMA0] [UDMA1] [UDMA2] [UDMA3] [UDMA4] [UDMA5]

SMART Monitoring [Auto]

Sets the Smart Monitoring, Analysis, and Reporting Technology. Configuration options: [Auto] [Disabled] [Enabled]

32Bit Data Transfer [Disabled]

Enables or disables 32-bit data transfer. Configuration options: [Disabled] [Enabled]

2.3.5 System Information

This menu gives you an overview of the general system specifications. The items in this menu are auto-detected by BIOS.

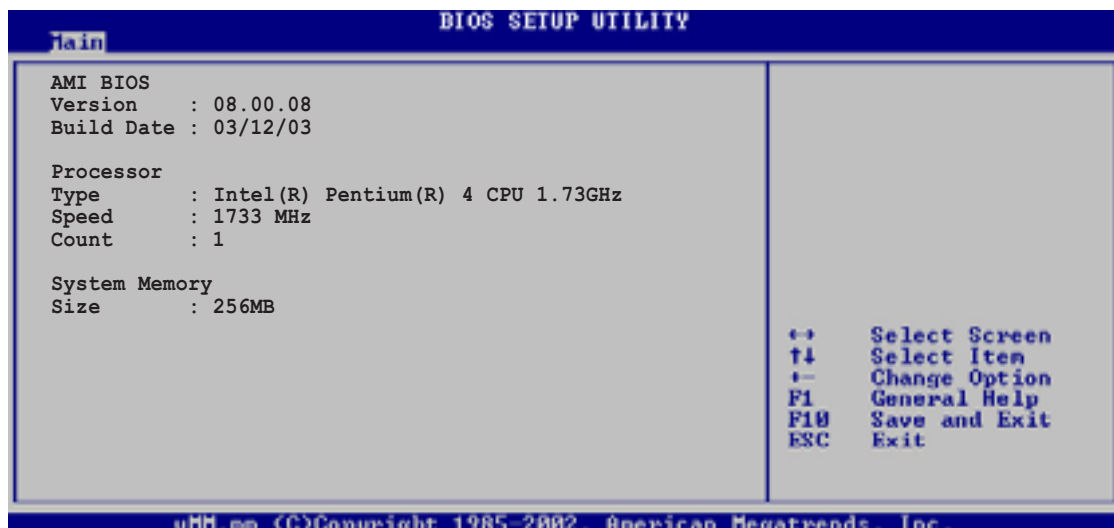

AMI BIOS

This item displays the auto-detected BIOS information.

Processor

This item displays the auto-detected CPU specification.

System Memory

This item displays the auto-detected system memory.

2.4 Advanced menu

The Advanced menu items allow you to change the settings for the CPU and other system devices.



Take caution when changing the settings of the Advanced menu items. Incorrect field values may cause the system to malfunction.

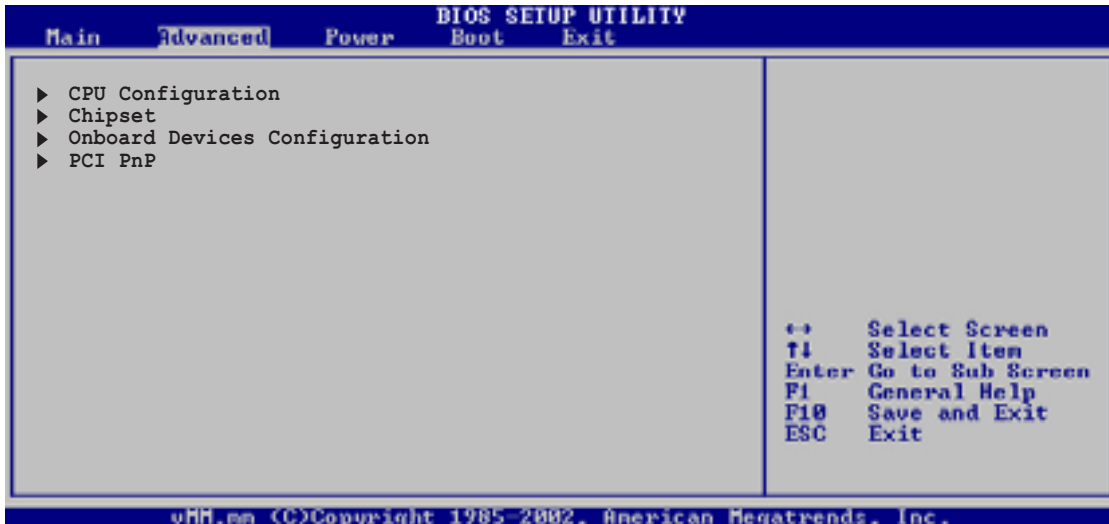

2.4.1 CPU Configuration

The items in this menu show the CPU-related information auto-detected by BIOS.

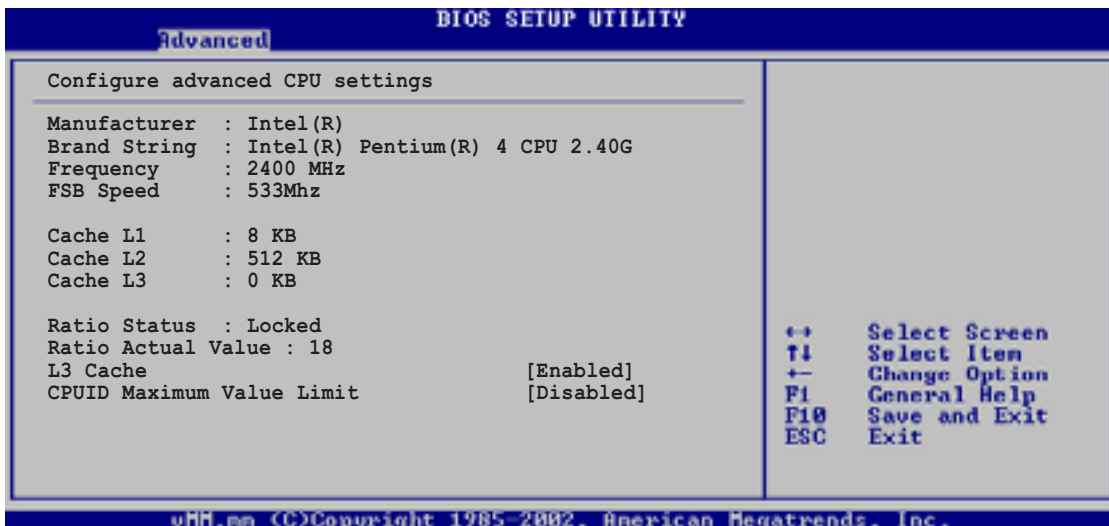

L3 Cache [Enabled]

This item allows you to enable or disable the Level 3 memory cache. Configuration options: [Enabled] [Disabled]

CPUID Maximum Value Limit [Disabled]

This item allows you to enable or disable support of older OS for CPUID maximum value limit. Certain operating systems do not support more than 3 CPUID functions. BIOS automatically detects these OS and allows the user to lower the CPUID maximum value limit. Configuration options: [Disabled] [Enabled]

2.4.2 Chipset

The Chipset menu items allow you to change the advanced chipset settings. Select an item then press Enter to display the sub-menu.

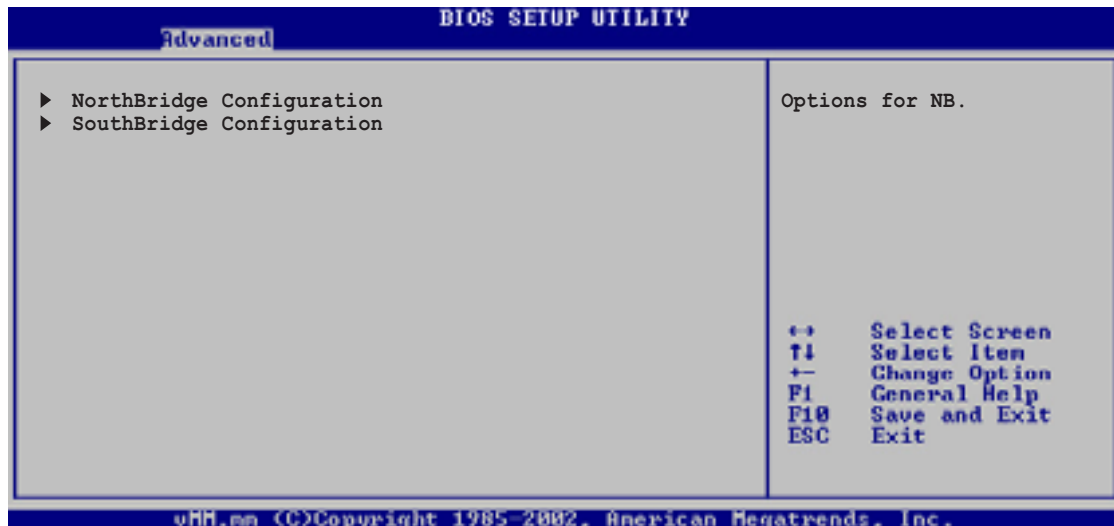

NorthBridge Configuration

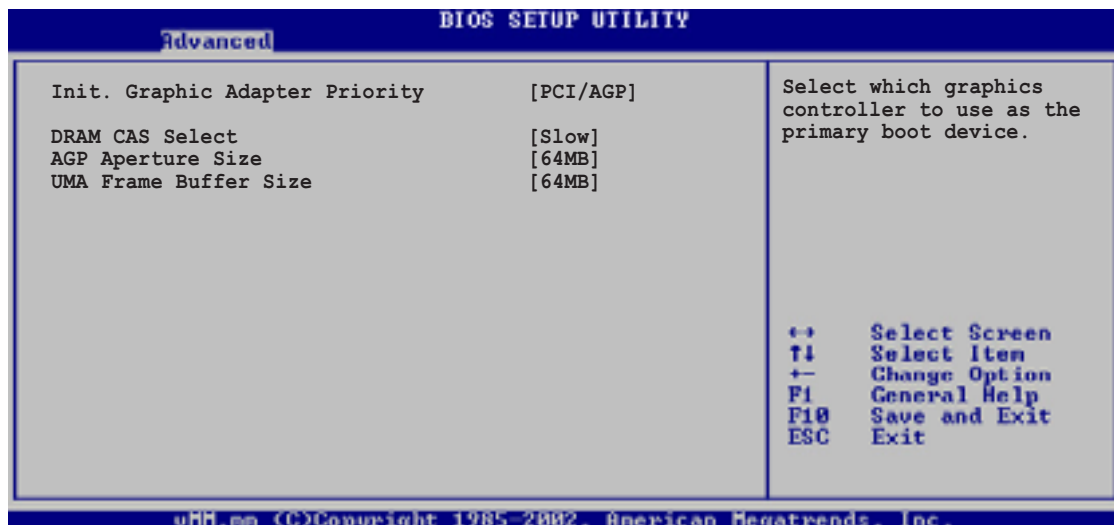

Init. Graphic Adapter Priority [PCI/AGP]

Allows selection of the graphics controller to use as primary boot device.

Configuration options: [PCI/AGP] [AGP/PCI]

DRAM CAS Select [Slow]

Allows you to select DRAM CAS speed. Configuration options: [Slow] [Fast]

AGP Aperture Size [64MB]

Allows you to select the size of mapped memory for AGP graphic data.

Configuration options: [32MB] [64MB] [128MB] [256MB] [512MB]

UMA Frame Buffer Size [64MB]

Allows you to select the size of the onboard graphics controller memory use.
Configuration options: [8MB] [16MB] [32MB] [64MB] [128MB] [None]

Southbridge Configuration

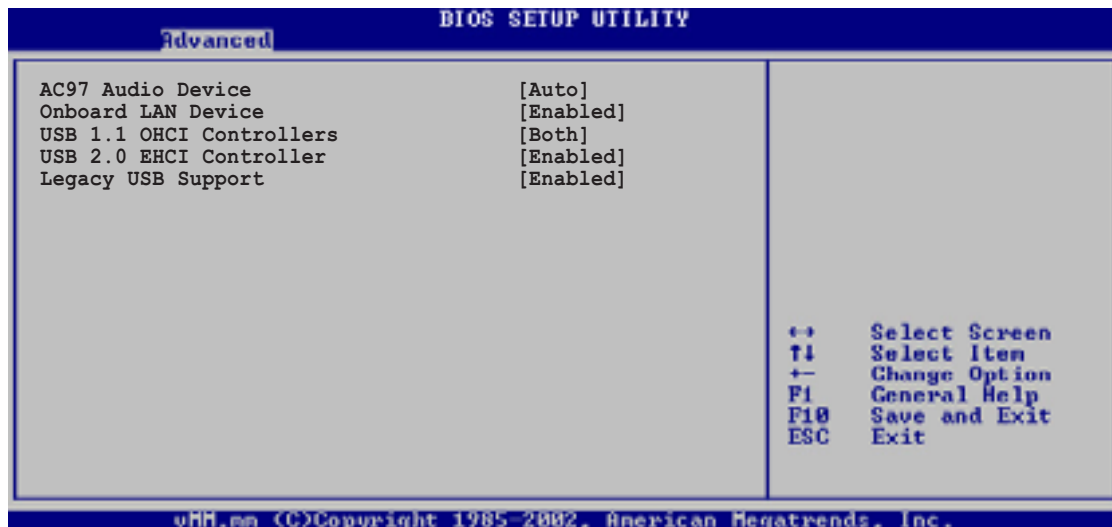

AC97 Audio Device [Auto]

[Auto] allows the BIOS to detect whether you are using any audio device. If an audio device is detected, the onboard audio controller is enabled; if no audio device is detected, the controller is disabled. Configuration options: [Auto] [Disabled]

OnBoard LAN Device [Enabled]

Allows you to enable or disable the onboard LAN controller. Configuration options: [Enabled] [Disabled]

USB 1.1 OHCI Controllers [Both]

Allows you to configure the USB 1.1 OHCI controller. Configuration options: [Both] [USB 1 Only] [USB 2 Only] [Disabled]

USB 2.0 EHCI Controller [Enabled]

Allows you to enable or disable the USB 2.0 EHCI controller.
Configuration options: [Enabled] [Disabled]

Legacy USB Support [Enabled]

Allows you to enable or disable support for legacy USB devices. Setting to Auto allows the system to detect the presence of USB devices at startup. If detected, the USB controller legacy mode is enabled. If no USB device is detected, the legacy USB support is disabled. Configuration options: [Enabled] [Disabled] [Auto]

2.4.3 Onboard Devices Configuration

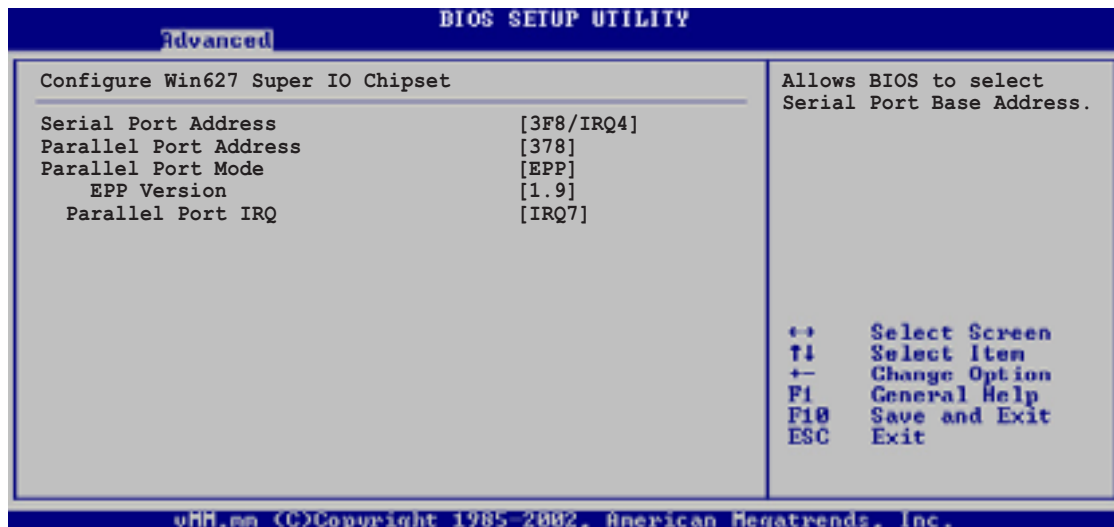

Serial Port Address [3F8/IRQ4]

Allows you to select the Serial Port1 base address.

Configuration options: [Disabled] [3F8/IRQ4] [3E8/IRQ4] [2E8/IRQ3]

Parallel Port Address [Disabled]

Allows you to select the Parallel Port base address.

Configuration options: [378] [278] [3BC] [Disabled]

Parallel Port Mode [EPP]

Allows you to select the Parallel Port mode. Configuration options: [Normal]

[Bi-Directional] [EPP] [ECP]

EPP Version [1.9]

Allows you to select the Enhanced Parallel Port version.

Configuration options: [1.9] [1.7]

Parallel Port IRQ [IRQ7]

Allows you to select the IRQ address for the Parallel Port.

Configuration options: [IRQ5] [IRQ7]

2.4.4 PCI PnP

The PCI PnP menu items allow you to change the advanced settings for PCI/PnP devices. The menu includes setting IRQ and DMA channel resources for either PCI/PnP or legacy ISA devices, and setting the memory size block for legacy ISA devices.



Take caution when changing the settings of the PCI PnP menu items. Incorrect field values may cause the system to malfunction.

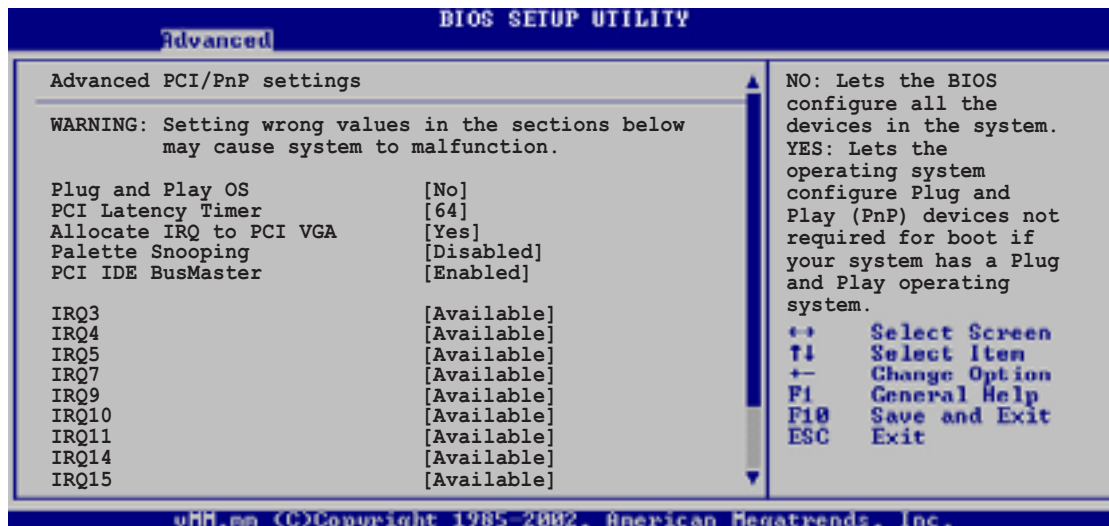

Plug and Play O/S [No]

When set to [No], BIOS configures all the devices in the system. When set to [Yes] and if you installed a Plug & Play operating system, the operating system configures the Plug & Play devices not required for boot.

Configuration options: [No] [Yes]

PCI Latency Timer [64]

Allows you to select the value in units of PCI clocks for the PCI device latency timer register. Configuration options: [32] [64] [96] [128] [160] [192] [224] [248]

Allocate IRQ to PCI VGA [Yes]

When set to [Yes], BIOS assigns an IRQ to PCI VGA card if the card requests for an IRQ. When set to [No], BIOS does not assign an IRQ to the PCI VGA card even if requested. Configuration options: [No] [Yes]

Pallete Snooping [Disabled]

When set to [Enabled], the pallete snooping feature informs the PCI devices that an ISA graphics device is installed in the system so that the latter can function correctly. Setting to [Disabled] deactivates this feature. Configuration options: [Disabled] [Enabled]

PCI IDE BusMaster [Enabled]

Allows BIOS to use PCI bus mastering when reading/writing to IDE devices. Configuration options: [Enabled] [Disabled]

IRQ xx [Available]

When set to [Available], the specific IRQ is free for use of PCI/PnP devices. When set to [Reserved], the IRQ is reserved for legacy ISA devices. Configuration options: [Available] [Reserved]

2.5 Power menu

The Power menu items allow you to change the power settings. Select an item then press Enter to display the configuration options.

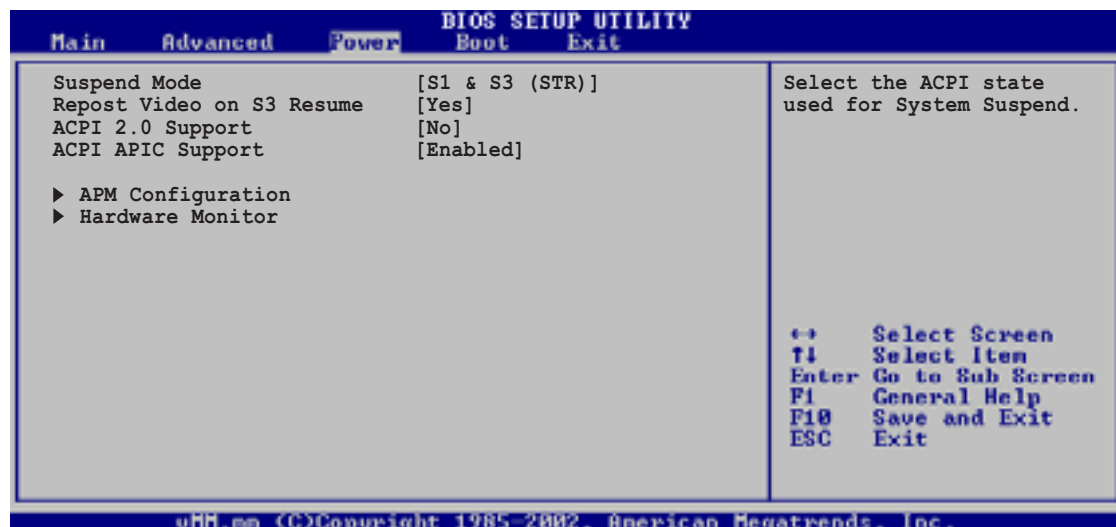

2.5.1 Suspend Mode [S1 & S3 (STR)]

Allows you to select the ACPI state to be used for system suspend. Configuration options: [S3 & S3 (STR)] [S1 (POS) Only]

2.5.2 Repost Video on S3 Resume [Yes]

Determines whether to invoke VGA BIOS POST on S3/STR resume. Configuration options: [Yes] [No]

2.5.3 ACPI 2.0 Support [No]

Allows you to add more tables for ACPI 2.0 specifications. Configuration options: [No] [Yes]

2.5.4 ACPI APIC Support [Enabled]

Allows you to enable or disable the ACPI support in the ASIC. When set to Enabled, the ACPI APIC table pointer is included in the RSDT pointer list. Configuration options: [Disabled] [Enabled]

2.5.5 APM Configuration

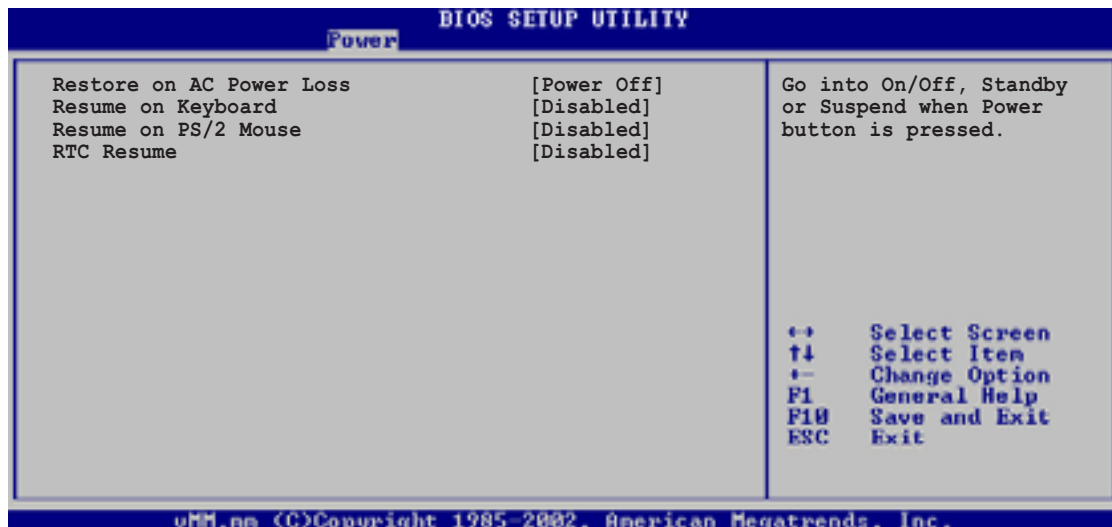

Restore on AC Power Loss [Power Off]

When set to Power Off, the system goes into off state after an AC power loss. When set to Power On, the system goes on after an AC power loss. When set to Last State, the system goes into either off or on state whatever was the system state before the AC power loss. Configuration options: [Power Off] [Power On] [Last State]

Resume on Keyboard [Disabled]

When set to [Enabled], this parameter allows you to use the keyboard to turn on the system. This feature requires an ATX power supply that provides at least 1A on the +5VSB lead. Configuration options: [Disabled] [Enabled]

Resume on PS/2 Mouse [Disabled]

When set to [Enabled], this parameter allows you to use the PS/2 mouse to turn on the system. This feature requires an ATX power supply that provides at least 1A on the +5VSB lead. Configuration options: [Disabled] [Enabled]

RTC Resume [Disabled]

Allows you to enable or disable RTC to generate a wake event. When this item is set to Enabled, the items RTC Alarm Date, RTC Alarm Hour, RTC Alarm Minute, and RTC Alarm Second appear with set values. Configuration options: [Disabled] [Enabled]

2.5.6 Hardware Monitor

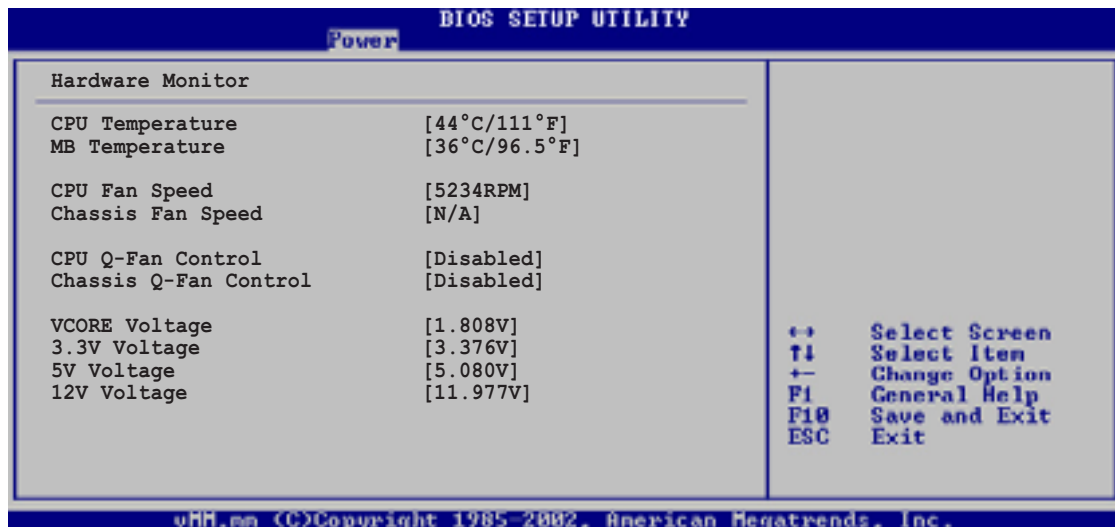

CPU Temperature [xxx°C/xxx°F]

MB Temperature [xxx°C/xxx°F]

The onboard hardware monitor automatically detects and displays the CPU, and motherboard temperatures.

CPU Fan Speed [xxxxRPM] or [N/A]

Chassis Fan Speed [xxxxRPM] or [N/A]

The onboard hardware monitor automatically detects and displays the CPU, and chassis fan speeds in rotations per minute (RPM). If any of the fans is not connected to the motherboard, the specific field shows N/A.

CPU Q-Fan Control [Disabled]

Chassis Q-Fan Control [Disabled]

These items allow you to enable or disable the ASUS Q-Fan feature that smartly adjusts the fan speeds for more efficient system operation. When these fields are set to [Enabled], the **Fan Speed Ratio** item appears to allow selection of the appropriate fan speed ratio. Configuration options: [Disabled] [Enabled]

CPU Q-Fan Ratio [11/16]

Chassis Q-Fan Ratio [11/16]

This item allows you to select the appropriate fan speed ratio for the system. The default [11/16] is the minimum fan speed ratio. Select a higher ratio if you installed additional devices and the system requires more ventilation.

Configuration options: [11/16] [12/16] [13/16] [14/16] [15/16]

VCORE Voltage, +3.3V Voltage, +5V Voltage, +12V Voltage

The onboard hardware monitor automatically detects the voltage output through the onboard voltage regulators.



If any of the monitored items is out of range, the following error message appears: "Hardware Monitor found an error. Enter Power setup menu for details". You will then be prompted to "Press F1 to continue or DEL to enter SETUP".

2.6 Boot menu

The Boot menu items allow you to change the system boot options. Select an item then press Enter to display the sub-menu.

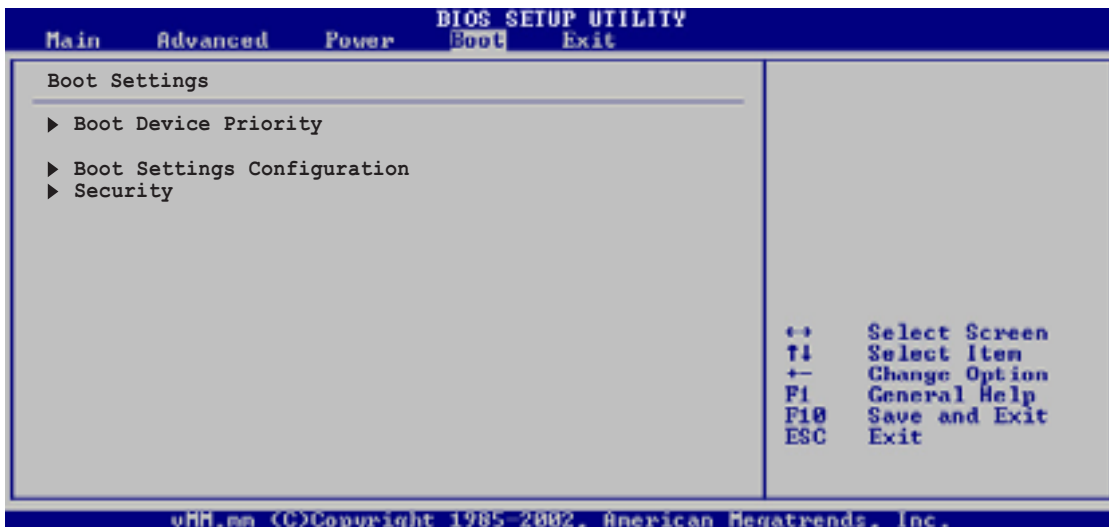

2.6.1 Boot Device Priority

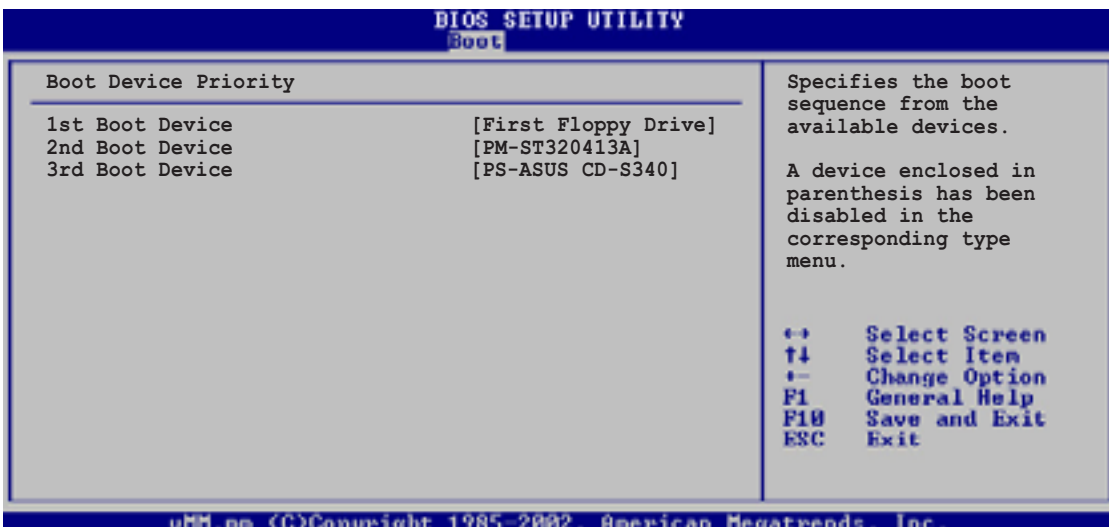

1st ~ xxth Boot Device [1st Floppy Drive]

These items specify the boot device priority sequence from the available devices. The number of device items that appear on the screen depends on the the number of devices installed in the system. Configuration options: [xxxxx Drive] [Disabled]

2.6.2 Boot Settings Configuration

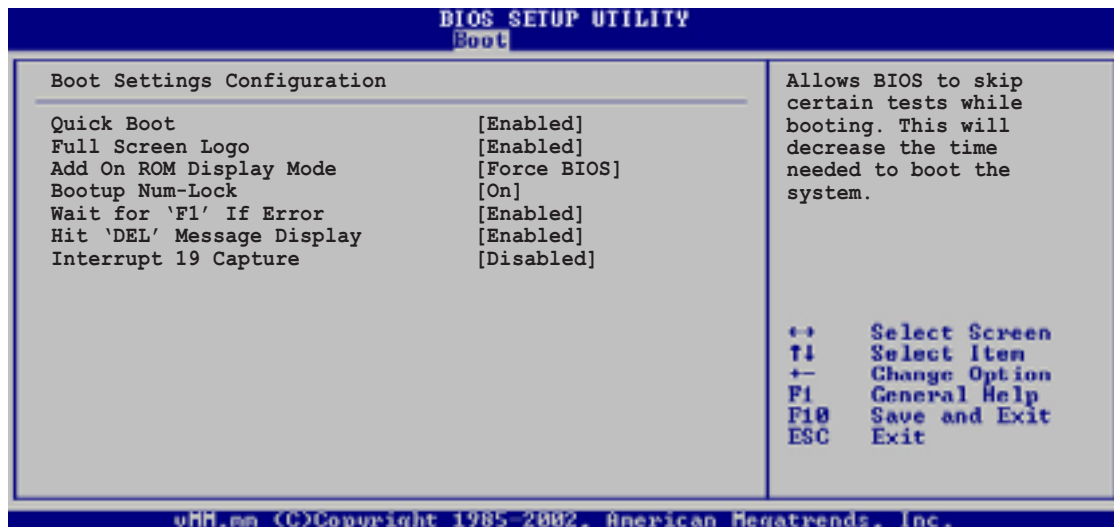

Quick Boot [Enabled]

Enabling this item allows BIOS to skip some power on self tests (POST) while booting to decrease the time needed to boot the system. When set to [Disabled], BIOS performs all the POST items. Configuration options: [Disabled] [Enabled]

Full Screen Logo [Enabled]

This allows you to enable or disable the full screen logo display feature. Configuration options: [Disabled] [Enabled]



Make sure the Full Screen Logo item is set to [Enabled] if you wish to use the ASUS MyLogo2™ feature.

Add On ROM Display Mode [Force BIOS]

Sets the display mode for option ROM. Configuration options: [Force BIOS] [Keep Current]

Bootup Num-Lock [On]

Allows you to select the power-on state for the NumLock. Configuration options: [Off] [On]

Wait for 'F1' If Error [Enabled]

When set to Enabled, the system waits for F1 key to be pressed when error occurs. Configuration options: [Disabled] [Enabled]

Hit 'DEL' Message Display [Enabled]

When set to Enabled, the system displays the message "Press DEL to run Setup" during POST. Configuration options: [Disabled] [Enabled]

Interrupt 19 Capture [Disabled]

When set to [Enabled], this function allows the option ROMs to trap Interrupt 19. Configuration options: [Disabled] [Enabled]

2.6.3 Security

The Security menu items allow you to change the system security settings. Select an item then press Enter to display the configuration options.

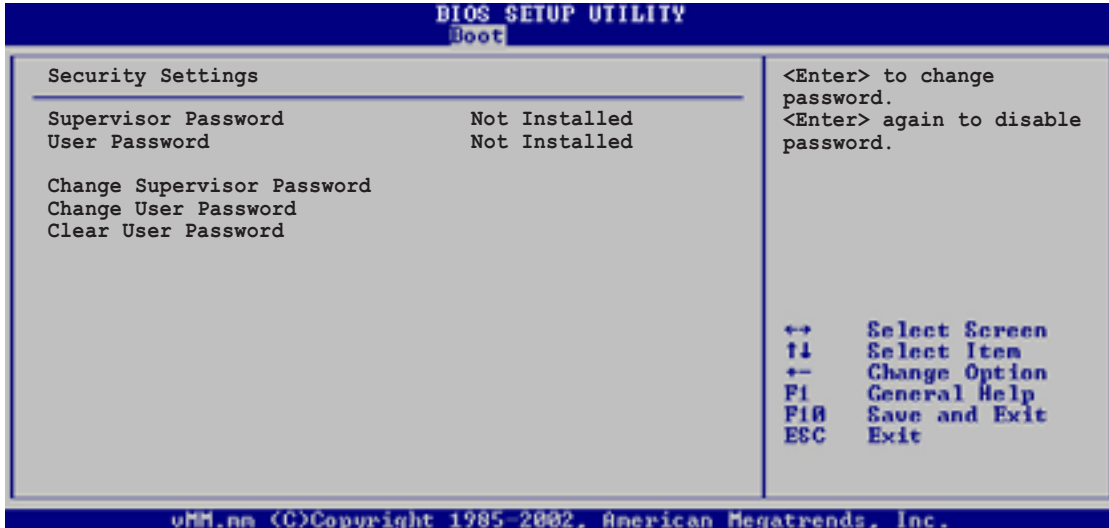

Change Supervisor Password

Select this item to set or change the supervisor password. The Supervisor Password item on top of the screen shows the default **Not Installed**. After you have set a password, this item shows **Installed**.

To set a Supervisor Password:

1. Select the Change Supervisor Password item and press Enter.
2. On the password box that appears, type a password composed of letters and/or numbers, then press Enter. Your password should have at least six characters.
3. Confirm the password when prompted.

The message "**Password Installed**" appears after you have successfully set your password. The Supervisor Password item now shows **Installed**. To change the supervisor password, follow the same steps as in setting a user password.

To clear the supervisor password, select the Change Supervisor Password then press Enter. The message "**Password Uninstalled**" appears.

After you have set a supervisor password, the other items appear to allow you to change other security settings.



User Access Level (Full Access)

This item allows you to select the access restriction to the Setup items.
 Configuration options: [No Access] [View Only] [Limited] [Full Access]

No Access prevents user access to the Setup utility.

View Only allows access but does not allow change to any field.

Limited allows change to only selected fields, such as Date and Time.

Full Access allows viewing and changing all the fields in the Setup utility.

Change User Password

Select this item to set or change the user password. The User Password item on top of the screen shows the default **Not Installed**. After you have set a password, this item shows **Installed**.

To set a User Password:

1. Select the Change User Password item and press Enter.
2. On the password box that appears, type a password composed of letters and/or numbers, then press Enter. Your password should have at least six characters.
3. Confirm the password when prompted.

The message "Password Installed" appears after you have successfully set your password. The User Password item now shows **Installed**. To change the user password, follow the same steps as in setting a user password.

Clear User Password

Select this item if you wish to clear the user password.

Password Check [Setup]

When set to [Setup], BIOS checks for user password when accessing the Setup utility. When set to [Always], BIOS checks for user password both when accessing Setup and booting the system. Configuration options: [Setup] [Always]

2.7 Exit menu

The Exit menu items allow you to load the optimal or failsafe default values for the BIOS items, and save or discard your changes to the BIOS items.

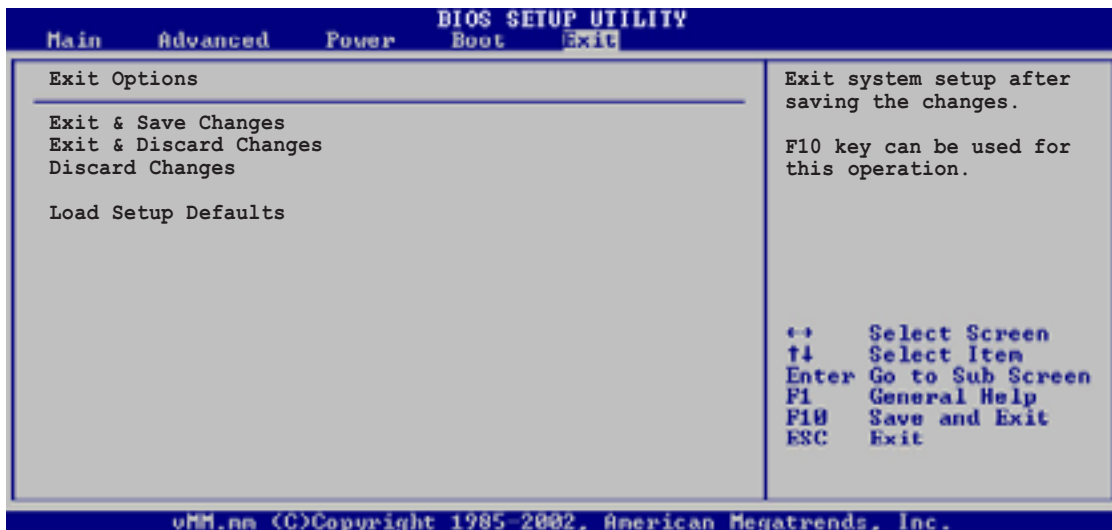

Pressing <Esc> does not immediately exit this menu. Select one of the options from this menu or <F10> from the legend bar to exit.

Exit & Save Changes

Once you are finished making your selections, choose this option from the Exit menu to ensure the values you selected are saved to the CMOS RAM. The CMOS RAM is sustained by an onboard backup battery and stays on even when the system is turned off. When you select this option, a confirmation window appears. Select [Yes] to save your changes and exit the BIOS setup.



If you attempt to exit the Setup program without saving your changes, the program prompts you with a message asking if you want to save your changes before exiting. Pressing <Enter> saves the changes while exiting.

Exit & Discard Changes

Select this option only if you do not want to save the changes that you made to the Setup program. If you made changes to fields other than system date, system time, and password, the BIOS asks for a confirmation before exiting.

Discard Changes

This option allows you to discard the selections you made and restore the previously saved values. After selecting this option, a confirmation appears. Select [Yes] to discard any changes and load the previously saved values.

Load Setup Defaults

This option allows you to load the default values for each of the parameters on the Setup menus. When you select this option or if you press <F5>, a confirmation window appears. Select [Yes] to load default values. Select Exit Saving Changes or make other changes before saving the values to the non-volatile RAM.

Chapter 3

This chapter describes the contents of the support CD that comes with the motherboard package.

Software support

3.1 Install an operating system

This motherboard supports Windows® ME/2000/XP operating system (OS). Always install the latest OS version and corresponding updates so you can maximize the features of your hardware.



- Because motherboard settings and hardware options vary, use the setup procedures presented in this chapter for general reference only. Refer to your OS documentation for more information.
- This motherboard does not support Windows® 98SE.

3.2 Support CD information

The support CD that came with the motherboard contains useful software and several utility drivers that enhance the motherboard features.



The contents of the support CD are subject to change at any time without notice. Visit the ASUS website for updates.

3.2.1 Running the support CD

To use the support CD, place the CD to the optical drive. The CD automatically runs and displays the **Drivers** menu if Autorun is enabled in your computer. Click an item on the window to install.



If **Autorun** is NOT enabled in your computer, browse the contents of the support CD to locate the file **ASSETUP.EXE** from the **BIN** folder. Double-click the **ASSETUP.EXE** to run the CD.

3.2.2 Drivers menu

The **Drivers** menu shows the available drivers for the devices auto-detected by the system. Install the necessary drivers to activate these devices.

ATI All in One Driver

The item installs the ATI All in One Driver.

AD1888 Driver and Application

This item installs the AD1888 audio driver and application.

3Com LAN Driver

This item installs the 3Com LAN driver.

3.2.3 Utilities menu

The **Utilities** menu shows the applications and other software that the motherboard supports.

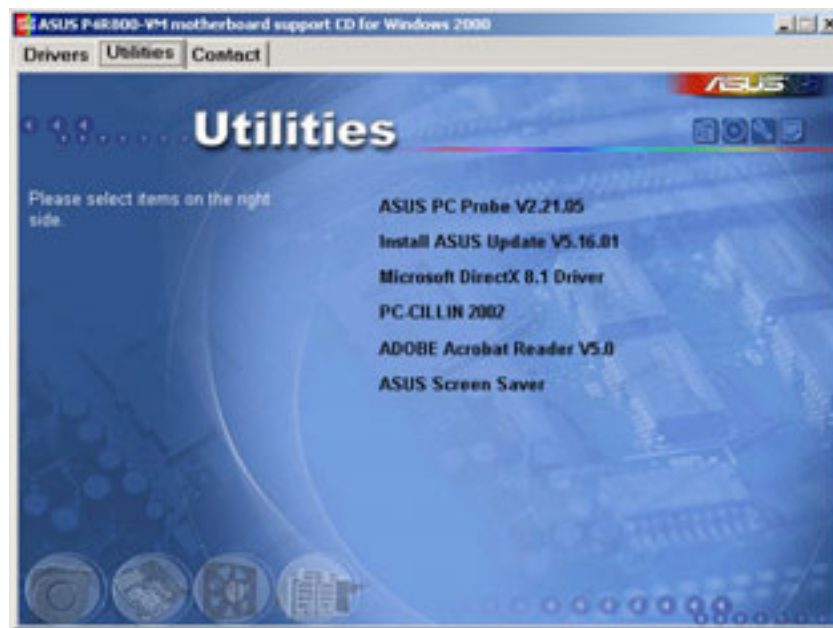

ASUS PC Probe

This smart utility monitors the fan speed, CPU temperature, and system voltages, and alerts you on any detected problems. This utility helps you keep your computer at a healthy operating condition.

Install ASUS Update

This program allows you to download the latest version of the BIOS from the ASUS website. Before using the ASUS Update, make sure that you have an Internet connection so you can connect to the ASUS website. Installing ASUS Update also installs ASUS Mylogo2™.

Microsoft® DirectX 8.1 Driver

This item installs the Microsoft® DirectX 8.1.

PC-CILLIN 2002

This item installs the PC-CILLIN 2002 anti-virus application. View the PC-CILLIN online help for details.

Adobe Acrobat Reader

This item installs the Adobe Acrobat Reader. The Acrobat Reader software is for viewing files saved in Portable Document Format (PDF).

ASUS Screen Saver

This item installs the ASUS screen saver.

3.2.4 ASUS contact information

Click the **Contact** tab to display the ASUS contact information.



The screen displays and menu options may vary depending on the operating system.