



# *P4V800-X*

User Guide

# Motherboard

**E1371**

**First Edition V1**

**August 2003**

**Copyright © 2003 ASUSTeK COMPUTER INC. All Rights Reserved.**

No part of this manual, including the products and software described in it, may be reproduced, transmitted, transcribed, stored in a retrieval system, or translated into any language in any form or by any means, except documentation kept by the purchaser for backup purposes, without the express written permission of ASUSTeK COMPUTER INC. ("ASUS").

Product warranty or service will not be extended if: (1) the product is repaired, modified or altered, unless such repair, modification or alteration is authorized in writing by ASUS; or (2) the serial number of the product is defaced or missing.

ASUS PROVIDES THIS MANUAL "AS IS" WITHOUT WARRANTY OF ANY KIND, EITHER EXPRESS OR IMPLIED, INCLUDING BUT NOT LIMITED TO THE IMPLIED WARRANTIES OR CONDITIONS OF MERCHANTABILITY OR FITNESS FOR A PARTICULAR PURPOSE. IN NO EVENT SHALL ASUS, ITS DIRECTORS, OFFICERS, EMPLOYEES OR AGENTS BE LIABLE FOR ANY INDIRECT, SPECIAL, INCIDENTAL, OR CONSEQUENTIAL DAMAGES (INCLUDING DAMAGES FOR LOSS OF PROFITS, LOSS OF BUSINESS, LOSS OF USE OR DATA, INTERRUPTION OF BUSINESS AND THE LIKE), EVEN IF ASUS HAS BEEN ADVISED OF THE POSSIBILITY OF SUCH DAMAGES ARISING FROM ANY DEFECT OR ERROR IN THIS MANUAL OR PRODUCT.

SPECIFICATIONS AND INFORMATION CONTAINED IN THIS MANUAL ARE FURNISHED FOR INFORMATIONAL USE ONLY, AND ARE SUBJECT TO CHANGE AT ANY TIME WITHOUT NOTICE, AND SHOULD NOT BE CONSTRUED AS A COMMITMENT BY ASUS. ASUS ASSUMES NO RESPONSIBILITY OR LIABILITY FOR ANY ERRORS OR INACCURACIES THAT MAY APPEAR IN THIS MANUAL, INCLUDING THE PRODUCTS AND SOFTWARE DESCRIBED IN IT.

Products and corporate names appearing in this manual may or may not be registered trademarks or copyrights of their respective companies, and are used only for identification or explanation and to the owners' benefit, without intent to infringe.

# Contents

Notices .....	v
Safety information .....	vi
About this guide .....	vii
ASUS contact information .....	viii
P4V800-X specifications summary .....	ix

## Chapter 1: Product introduction

1.1 Welcome! .....	1-2
1.2 Package contents .....	1-2
1.3 Special features .....	1-2
1.4 Motherboard components .....	1-4
1.5 Motherboard layout .....	1-7
1.6 Before you proceed .....	1-8
1.7 Motherboard installation .....	1-9
1.7.1 Placement direction .....	1-9
1.7.2 Screw holes .....	1-9
1.8 Central Processing Unit (CPU) .....	1-10
1.8.1 Overview .....	1-10
1.8.2 Installing the CPU .....	1-11
1.9 System memory .....	1-12
1.9.1 Installing a DIMM .....	1-12
1.9.2 Memory configurations .....	1-13
1.10 Expansion slots .....	1-14
1.10.1 Standard interrupt assignments .....	1-14
1.10.2 IRQ assignments for this motherboard .....	1-14
1.10.3 PCI slots .....	1-15
1.10.4 AGP slot .....	1-15
1.11 Jumper .....	1-16
1.12 Connectors .....	1-18

## Chapter 2: BIOS information

2.1 Managing and updating your BIOS .....	2-2
2.1.1 Creating a bootable floppy disk .....	2-2
2.1.2 Using AFUDOS to update the BIOS .....	2-2
2.1.3 Using AFUDOS to copy BIOS from PC .....	2-4
2.1.4 Using ASUS EZ Flash to update the BIOS .....	2-5
2.1.5 Using ASUS CrashFree BIOS 2 .....	2-6
2.2 BIOS Setup program .....	2-8

# Contents

2.2.1	BIOS menu screen .....	2-9
2.2.2	Menu bar .....	2-9
2.2.3	Navigation keys .....	2-9
2.2.4	Menu items .....	2-10
2.2.5	Sub-menu items .....	2-10
2.2.6	Configuration fields .....	2-10
2.2.7	Pop-up window .....	2-10
2.2.8	Scroll bar .....	2-10
2.2.9	General help .....	2-10
2.3	Main menu .....	2-11
2.3.1	System Time [xx:xx:xxxx] .....	2-11
2.3.2	System Date [Day xx/xx/xxxx] .....	2-11
2.3.3	Legacy Diskette A,B [1.44M, 3.5 in.] .....	2-11
2.3.4	Primary/Secondary/Third/Fourth IDE Master/Slave .....	2-12
2.3.5	System Information .....	2-13
2.4	Advanced menu .....	2-14
2.4.1	JumperFree Configuration .....	2-14
2.4.2	USB Configuration .....	2-15
2.4.3	CPU Configuration .....	2-17
2.4.3	Chipset .....	2-17
2.4.5	Onboard Devices Configuration .....	2-20
2.4.6	PCI PnP .....	2-21
2.5	Power menu .....	2-22
2.5.1	Suspend Mode [Auto] .....	2-22
2.5.2	Repost Video on S3 Resume [No] .....	2-22
2.5.3	ACPI 2.0 Support [No] .....	2-22
2.5.4	ACPI APIC Support [Enabled] .....	2-23
2.5.5	APM Configuration .....	2-23
2.5.6	Hardware Monitor .....	2-24
2.6	Boot menu .....	2-26
2.6.1	Boot Device Priority .....	2-26
2.6.2	Boot Settings Configuration .....	2-27
2.6.3	Security .....	2-28
2.7	Exit menu .....	2-30

## Chapter 3: Software support

3.1	Install an operating system .....	3-2
3.2	Support CD information .....	3-2
3.3	RAID 0 / RAID 1 configurations .....	3-5

# Notices

## Federal Communications Commission Statement

This device complies with FCC Rules Part 15. Operation is subject to the following two conditions:

- This device may not cause harmful interference, and
- This device must accept any interference received including interference that may cause undesired operation.

This equipment has been tested and found to comply with the limits for a Class B digital device, pursuant to Part 15 of the FCC Rules. These limits are designed to provide reasonable protection against harmful interference in a residential installation. This equipment generates, uses and can radiate radio frequency energy and, if not installed and used in accordance with manufacturer's instructions, may cause harmful interference to radio communications. However, there is no guarantee that interference will not occur in a particular installation. If this equipment does cause harmful interference to radio or television reception, which can be determined by turning the equipment off and on, the user is encouraged to try to correct the interference by one or more of the following measures:

- Reorient or relocate the receiving antenna.
- Increase the separation between the equipment and receiver.
- Connect the equipment to an outlet on a circuit different from that to which the receiver is connected.
- Consult the dealer or an experienced radio/TV technician for help.



---

The use of shielded cables for connection of the monitor to the graphics card is required to assure compliance with FCC regulations. Changes or modifications to this unit not expressly approved by the party responsible for compliance could void the user's authority to operate this equipment.

---

## Canadian Department of Communications Statement

This digital apparatus does not exceed the Class B limits for radio noise emissions from digital apparatus set out in the Radio Interference Regulations of the Canadian Department of Communications.

**This class B digital apparatus complies with Canadian ICES-003.**

# Safety information

## Electrical safety

- To prevent electrical shock hazard, disconnect the power cable from the electrical outlet before relocating the system.
- When adding or removing devices to or from the system, ensure that the power cables for the devices are unplugged before the signal cables are connected. If possible, disconnect all power cables from the existing system before you add a device.
- Before connecting or removing signal cables from the motherboard, ensure that all power cables are unplugged.
- Seek professional assistance before using an adapter or extension cord. These devices could interrupt the grounding circuit.
- Make sure that your power supply is set to the correct voltage in your area. If you are not sure about the voltage of the electrical outlet you are using, contact your local power company.
- If the power supply is broken, do not try to fix it by yourself. Contact a qualified service technician or your retailer.

## Operation safety

- Before installing the motherboard and adding devices on it, carefully read all the manuals that came with the package.
- Before using the product, make sure all cables are correctly connected and the power cables are not damaged. If you detect any damage, contact your dealer immediately.
- To avoid short circuits, keep paper clips, screws, and staples away from connectors, slots, sockets and circuitry.
- Avoid dust, humidity, and temperature extremes. Do not place the product in any area where it may become wet.
- Place the product on a stable surface.
- If you encounter technical problems with the product, contact a qualified service technician or your retailer.

# About this guide

## Conventions used in this guide

To make sure that you perform certain tasks properly, take note of the following symbols used throughout this manual.



**WARNING:** Information to prevent injury to yourself when trying to complete a task.



**CAUTION:** Information to prevent damage to the components when trying to complete a task.



**IMPORTANT:** Information that you **MUST** follow to complete a task.



**NOTE:** Tips and additional information to aid in completing a task.

## Where to find more information

Refer to the following sources for additional information and for product and software updates.

### 1. ASUS Websites

The ASUS websites worldwide provide updated information on ASUS hardware and software products. The ASUS websites are listed in the ASUS Contact Information on page viii.

### 2. Optional Documentation

Your product package may include optional documentation, such as warranty flyers, that may have been added by your dealer. These documents are not part of the standard package.

# ASUS contact information

## ASUSTeK COMPUTER INC. (Asia-Pacific)

Address: 150 Li-Te Road, Peitou, Taipei, Taiwan 112  
General Tel: +886-2-2894-3447  
General Fax: +886-2-2894-3449  
Web Site: [www.asus.com.tw](http://www.asus.com.tw)

### *Technical Support*

MB/Others (Tel): +886-2-2890-7121 (English)  
Notebook (Tel): +886-2-2890-7122 (English)  
Desktop/Server (Tel): +886-2-2890-7123 (English)  
Support Fax: +886-2-2890-7698

## ASUS COMPUTER INTERNATIONAL (America)

Address: 44370 Nobel Drive, Fremont, CA 94538, USA  
General Fax: +1-502-933-8713  
General Email: [tmd1@asus.com](mailto:tmd1@asus.com)  
Web Site: [usa.asus.com](http://usa.asus.com)

### *Technical Support*

Support Fax: +1-502-933-8713  
General Support: +1-502-995-0883  
Notebook Support: +1-510-739-3777 x5110  
Support Email: [tsd@asus.com](mailto:tsd@asus.com)

## ASUS COMPUTER GmbH (Germany and Austria)

Address: Harkortstr. 25, 40880 Ratingen, BRD, Germany  
General Email: [sales@asuscom.de](mailto:sales@asuscom.de) (for marketing requests only)  
General Fax: +49-2102-9599-31  
Web Site: [www.asuscom.de](http://www.asuscom.de)

### *Technical Support*

Components: +49-2102-9599-0  
Notebook PC: +49-2102-9599-10  
Support Fax: +49-2102-9599-11  
Support Email: [www.asuscom.de/support](http://www.asuscom.de/support) (for online support)

## ASUSTeK COMPUTER (Middle East and North Africa)

Address: P.O. Box 64133, Dubai, U.A.E.  
General Tel: +9714-283-1774  
General Fax: +9714-283-1775  
Web Site: [www.ASUSarabia.com](http://www.ASUSarabia.com)



# P4V800-X specifications summary

<b>CPU</b>	Socket 478 for Intel® Pentium® 4 / Celeron with speeds up to 3.2 GHz+ Supports Intel® Hyper-Threading technology New power design supports next generation Prescott CPU
<b>Chipset</b>	VIA PT800 VIA VT8237
<b>Front Side Bus (FSB)</b>	800/533/400 MHz
<b>Memory</b>	3 x 184-pin DDR DIMM sockets for up to 3GB memory Supports PC3200/PC2700/PC2100 non-ECC DDR DIMMs (Note: PC3200 DDR DIMMs max to 2 DIMM slots only.)
<b>Expansion slots</b>	1 x AGP 8X/4X (0.8V, 1.5V only) 5 x PCI
<b>Storage</b>	2 x UltraDMA 133 connectors 2 x Serial ATA connectors with RAID 0, RAID 1 function
<b>Audio</b>	ADI AD1980 SoundMax 6-channel audio CODEC support for S/PDIF out interface
<b>LAN</b>	Realtek RTL8201BL 10/100 Mbps LAN PHY
<b>USB</b>	Maximum of 8 USB 2.0 ports
<b>AI Overclocking</b>	Intelligent CPU frequency tuner ASUS JumperFree CPU and Memory voltage adjustable SFS (Stepless Frequency Selection) at 1 MHz increment Adjustable FSB/DDR ratio; Fixed AGP/PCI frequencies. ASUS C.P.R. (CPU Parameter Recall)
<b>Special features</b>	Power Loss Restart ASUS C.P.R. (CPU Parameter Recall) support S/PDIF out interface ASUS EZ Flash CrashFree BIOS 2 ASUS MyLogo2
<b>Back panel I/O</b>	1 x Parallel port 1 x Serial port 1 x PS/2 keyboard port 1 x PS/2 mouse port 4 x USB 2.0 ports 1 x S/PDIF out 1 x RJ-45 port Line In/Line Out/Microphone ports

(continued on the next page)

# P4V800-X specifications summary

<b>Internal I/O</b>	2 x USB 2.0 connector for 4 additional USB ports CPU/Chassis fan connectors 20-pin/4-pin ATX 12V power connectors CD/AUX connectors Game/MIDI connector 10-1 pin front panel connector
<b>BIOS features</b>	4Mb Flash ROM, AMI BIOS, ACPI, PnP, DMI2.0, ASUS EZ Flash, ASUS MyLogo2
<b>Industry standard</b>	PCI 2.2, USB 2.0/1.1
<b>Manageability</b>	DMI 2.0, WOL/WOR by PME, chassis intrusion
<b>Power Requirement</b>	ATX power supply (with 4-pin 12V plug)
<b>Support CD contents</b>	Device drivers ASUS PC Probe ASUS LiveUpdate Trend Micro™ PC-cillin 2002 anti-virus software
<b>Form Factor</b>	ATX form factor: 12 in x 7.6 in (30.5 cm x 19.3 cm)

\* Specifications are subject to change without notice.

# Chapter 1

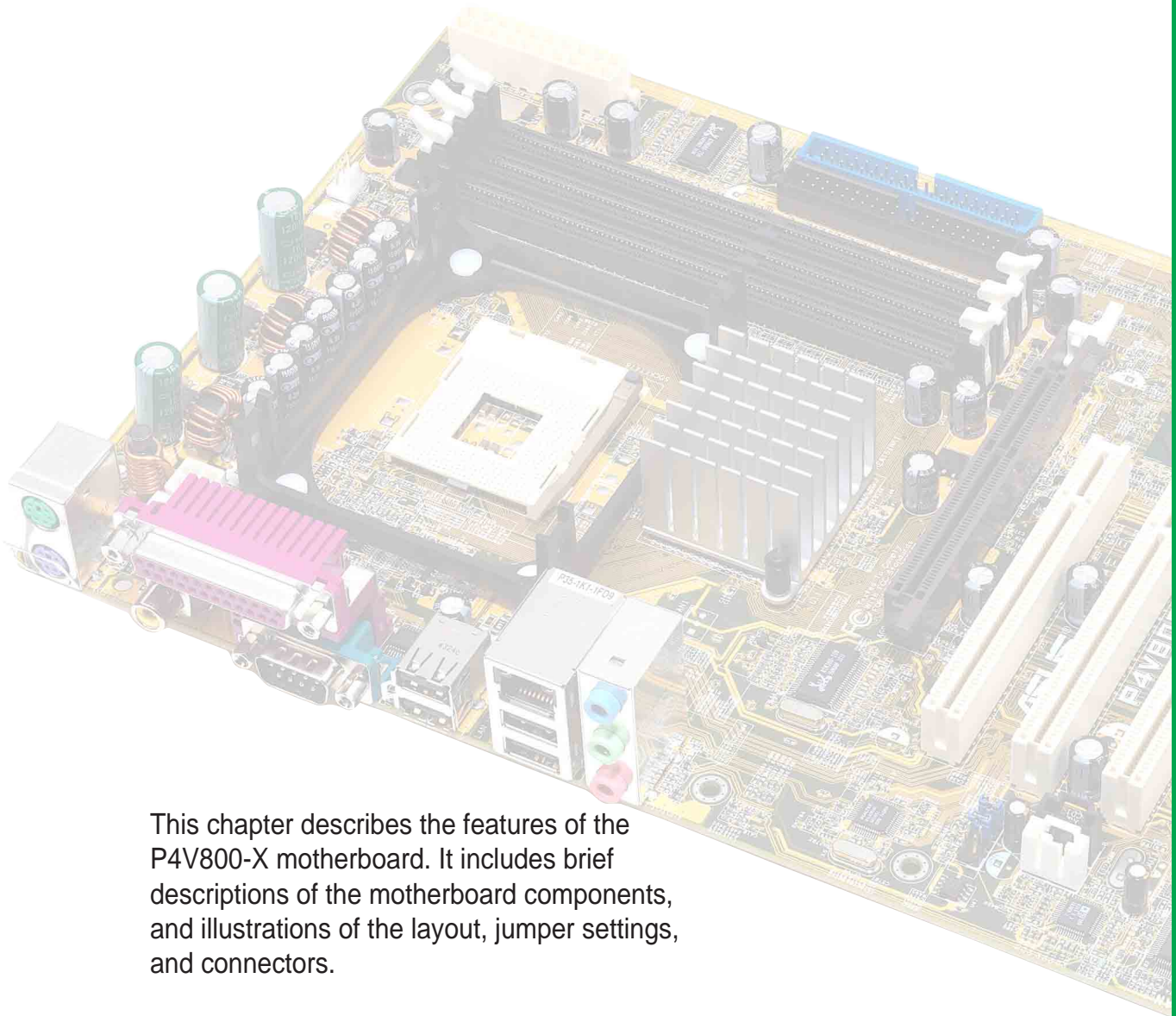

This chapter describes the features of the P4V800-X motherboard. It includes brief descriptions of the motherboard components, and illustrations of the layout, jumper settings, and connectors.

## Product introduction

# 1.1 Welcome!

**Thank you for buying the ASUS® P4V800-X motherboard!**

The ASUS P4V800-X motherboard delivers a host of new features and latest technologies making it another standout in the long line of ASUS quality motherboards!

The P4V800-X incorporates the Intel® Pentium® 4 / Celeron processors in 478-pin package coupled with the VIA® PT800 chipset to set a new benchmark for an effective desktop platform solution.

Supporting up to 3GB of system memory with PC3200/2700/2100 DDR SDRAM, high-resolution graphics via an AGP 8X slot, Serial ATA support, USB 2.0, and 6-channel audio features, the P4V800-X is your affordable vehicle to enter the world of computing!

Before you start installing the motherboard, and hardware devices on it, check the items in your package with the list below.

## 1.2 Package contents

Check your P4V800-X package for the following items.

- ✓ ASUS P4V800-X motherboard
- ✓ ASUS P4V800-X series support CD
- ✓ UltraDMA 133/100/66 cable
- ✓ 2 x Serial ATA cables
- ✓ Floppy disk cable
- ✓ I/O shield
- ✓ Bag of extra jumper caps
- ✓ User Guide



---

If any of the above items is damaged or missing, contact your retailer.

---

## 1.3 Special features

**Latest processor technology** 

The motherboard supports the Intel® Pentium® 4 processor with 512KB L2 cache and an 800/533/400 MHz system bus. The CPU features the Intel Hyper-Threading Technology and a new power design that allows up to 3.2GHz core frequencies with support for the Intel® next generation Prescott CPU. See page 1-10.

## DDR400 memory support



The motherboard supports up to 3GB of system memory using PC3200/2700/2100 non-ECC DDR DIMMs to deliver up to 3.2GB/s data transfer rate to provide enhanced system performance. See page 1-12.

## Serial ATA technology



The motherboard bundles the new Serial ATA technology through the SATA interfaces onboard. The SATA specification allows for thinner, more flexible cables with lower pin count, reduced voltage requirement, up to 150 MB/s data transfer rate, and software compatibility with the legacy Parallel ATA. See page 1-18.

## Integrated RAID



The VIA VT8237 SouthBridge integrated RAID controller enable users to create Serial ATA RAID0 and RAID1 configurations using a user-friendly graphical user interface for an easier and faster RAID installation and management.

## AGP 8X support



AGP8X (AGP 3.0) is the next generation VGA interface specification that enables enhanced graphics performance with high bandwidth up to 2.12GB/s. See pages 1-6 and 1-21.

## USB 2.0 technology



The motherboard implements the new Universal Serial Bus (USB) 2.0 specification, extending the connection speed from 12 Mbps on USB 1.1 to a fast 480 Mbps on USB 2.0. See pages 1-6 and 1-21.

## 6-channel digital audio

The ADI 1980 AC'97 audio CODEC is onboard to provide 6-channel audio playback for 5.1 surround sound and over 90dB dynamic range.

## Integrated 10/100 LAN



The onboard LAN controller is a highly integrated Fast Ethernet controller. It is enhanced with an ACPI management function to provide efficient power management for advanced operating systems.

## CrashFree BIOS 2



CrashFree BIOS 2 allows users to restore BIOS data from a floppy diskette or recovery CD when BIOS code and data are corrupted during upgrade or when invaded by a virus. ASUS motherboards now enable users to enjoy this protection feature without the need to pay for an optional ROM.

# 1.4 Motherboard components

Before you install the motherboard, learn about its major components and available features to facilitate the installation and future upgrades. Refer to the succeeding pages for the component descriptions.

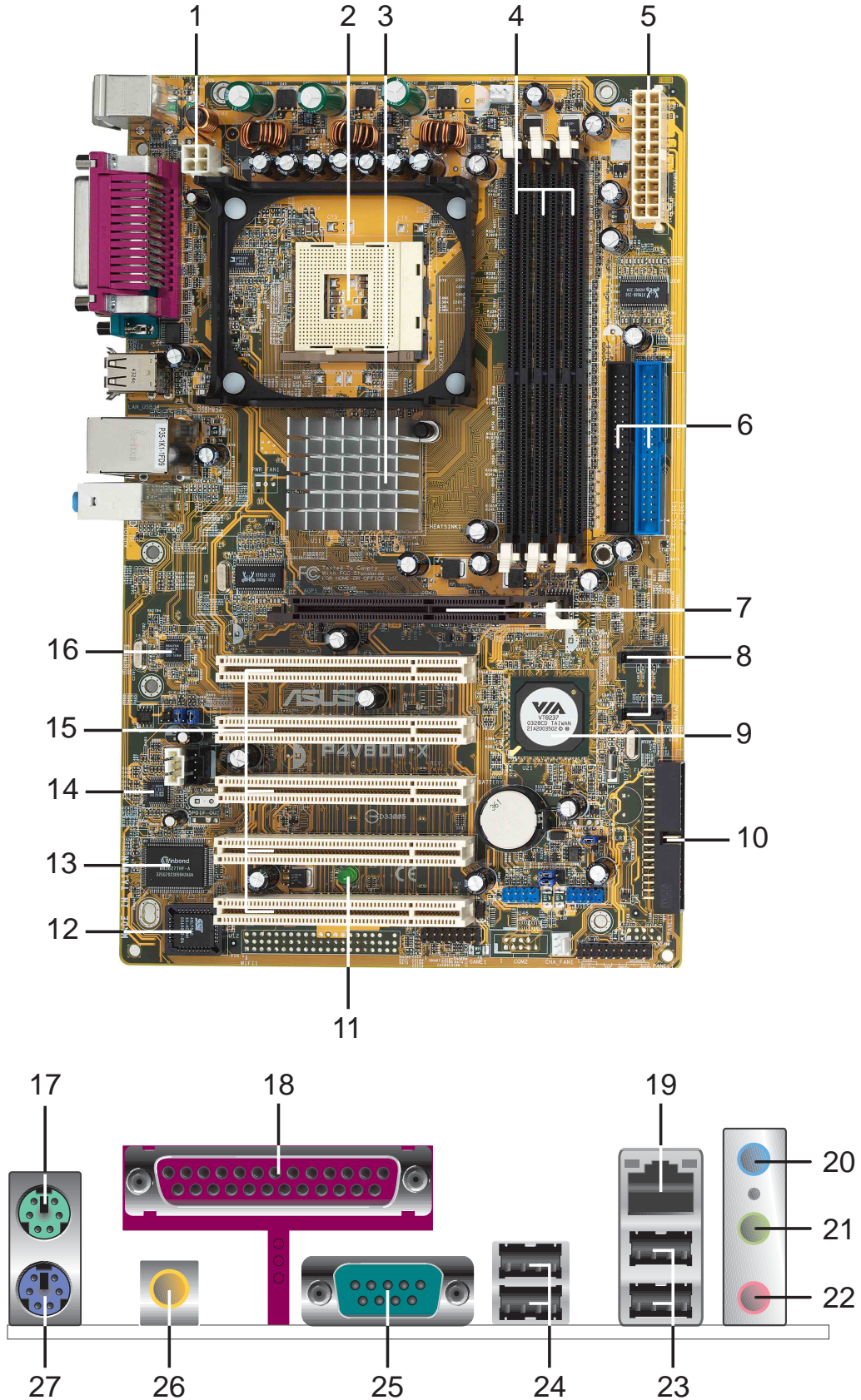

- 1 ATX 12V connector.** This power connector connects the 4-pin 12V plug from the ATX 12V power supply.
- 2 CPU socket.** A 478-pin surface mount, Zero Insertion Force (ZIF) socket for the Intel® Pentium® 4 or Celeron® processors, with 800/533/400 MHz system bus that allows 6.4GB/s, 4.3GB/s, and 3.2GB/s data transfer rates, respectively.
- 3 North bridge controller.** The VIA® PT800 provides the processor interface with 800/533/400 MHz frequency, system memory interface at 400/333/266MHz operation, and 1.5V/0.8V AGP interface that supports AGP 3.0 specification including 8X Fast Write protocol.
- 4 DDR DIMM sockets.** These three 184-pin DIMM sockets support up to 3GB system memory using unbuffered non-ECC PC3200/2700/2100 DDR DIMMs.
- 5 ATX power connector.** This 20-pin connector connects to an ATX power supply. The power supply must have at least 1A on the +5V standby lead (+5VSB).
- 6 IDE connectors.** These dual-channel bus master IDE connectors support Ultra DMA133/100/66, PIO Modes 3 & 4 IDE devices. Both the primary (blue) and secondary (black) connectors are slotted to prevent incorrect insertion of the IDE ribbon cable.
- 7 AGP 8X slot.** This Accelerated Graphics Port (AGP) slot supports 1.5V/0.8V AGP 8X/4X mode graphics cards for 3D graphical applications.
- 8 SATA connectors.** These connectors support Serial ATA HDDs and allow up to 150MB/s data transfer rate using thin 4-conductor SATA cables.
- 9 South bridge controller.** The VIA® VT8237 integrated peripheral controller supports various I/O functions including two Serial ATA ports, 2-channel ATA/133 bus master IDE controller, up to eight USB 2.0 ports, LPC Super I/O interface, AC'97 interface and PCI 2.2 interface.
- 10 Floppy disk connector.** This connector accommodates the provided ribbon cable for the floppy disk drive. One side of the connector is slotted to prevent incorrect insertion of the floppy disk cable.
- 11 Standby power LED.** This LED lights up if there is a standby power on the motherboard. This LED acts as a reminder to turn off the system power before plugging or unplugging devices.
- 12 Flash ROM.** This 4Mb firmware contains the programmable BIOS program.
- 13 Super I/O controller.** This Low Pin Count (LPC) interface provides the commonly used Super I/O functionality. The chipset supports a high-performance floppy disk controller for a 360K/720K/1.44M/2.88M floppy disk drive, a multi-mode parallel port, two standard compatible UARTs, and a Flash ROM interface.
- 14 Audio CODEC.** The ADI 1980 is an AC'97 CODEC that allows 6-channel audio playback.

- 15** **PCI slots.** These 32-bit PCI 2.2 expansion slots support bus master PCI cards like SCSI or LAN cards with 133MB/s maximum throughput.
- 16** **LAN controller.** This Realtek RTL8201BL LAN PHY supports 10BASE-T/100BASE-TX networking.
- 17** **PS/2 mouse port.** This green 6-pin connector is for a PS/2 mouse.
- 18** **Parallel port.** This 25-pin port connects a parallel printer, a scanner, or other devices.
- 19** **RJ-45 port.** This port allows connection to a Local Area Network (LAN) through a network hub.
- 20** **Line In jack.** This Line In (light blue) jack connects a tape player or other audio sources. In 6-channel mode, the function of this jack becomes Bass/Center.
- 21** **Line Out jack.** This Line Out (lime) jack connects a headphone or a speaker. In 6-channel mode, the function of this jack becomes Front Speaker Out.
- 22** **Microphone jack.** This Mic (pink) jack connects a microphone. In 6-channel mode, the function of this jack becomes Rear Speaker Out.



The functions of the Line Out, Line In, and Microphone jacks change when you select the 6-channel audio configuration as shown in the following table:

### Audio 2, 4 or 6-channel configuration

	Headphone/ 2-Speaker	4-Speaker	6-Speaker
Light Blue	Line In	Line In	Bass/Center
Lime	Line Out	Front Speaker Out	Front Speaker Out
Pink	Mic In	Rear Speaker Out	Rear Speaker Out

- 23** **USB 2.0 ports 3 and 4.** These two 4-pin Universal Serial Bus (USB) ports are available for connecting USB 2.0 devices.
- 24** **USB 2.0 ports 1 and 2.** These two 4-pin Universal Serial Bus (USB) ports are available for connecting USB 2.0 devices.
- 25** **Serial port.** This 9-pin COM1 port is for pointing devices or other serial devices.
- 26** **S/PDIF out jack.** This jack connects to external audio output devices.
- 27** **PS/2 keyboard port.** This purple connector is for a PS/2 keyboard.



# 1.5 Motherboard layout

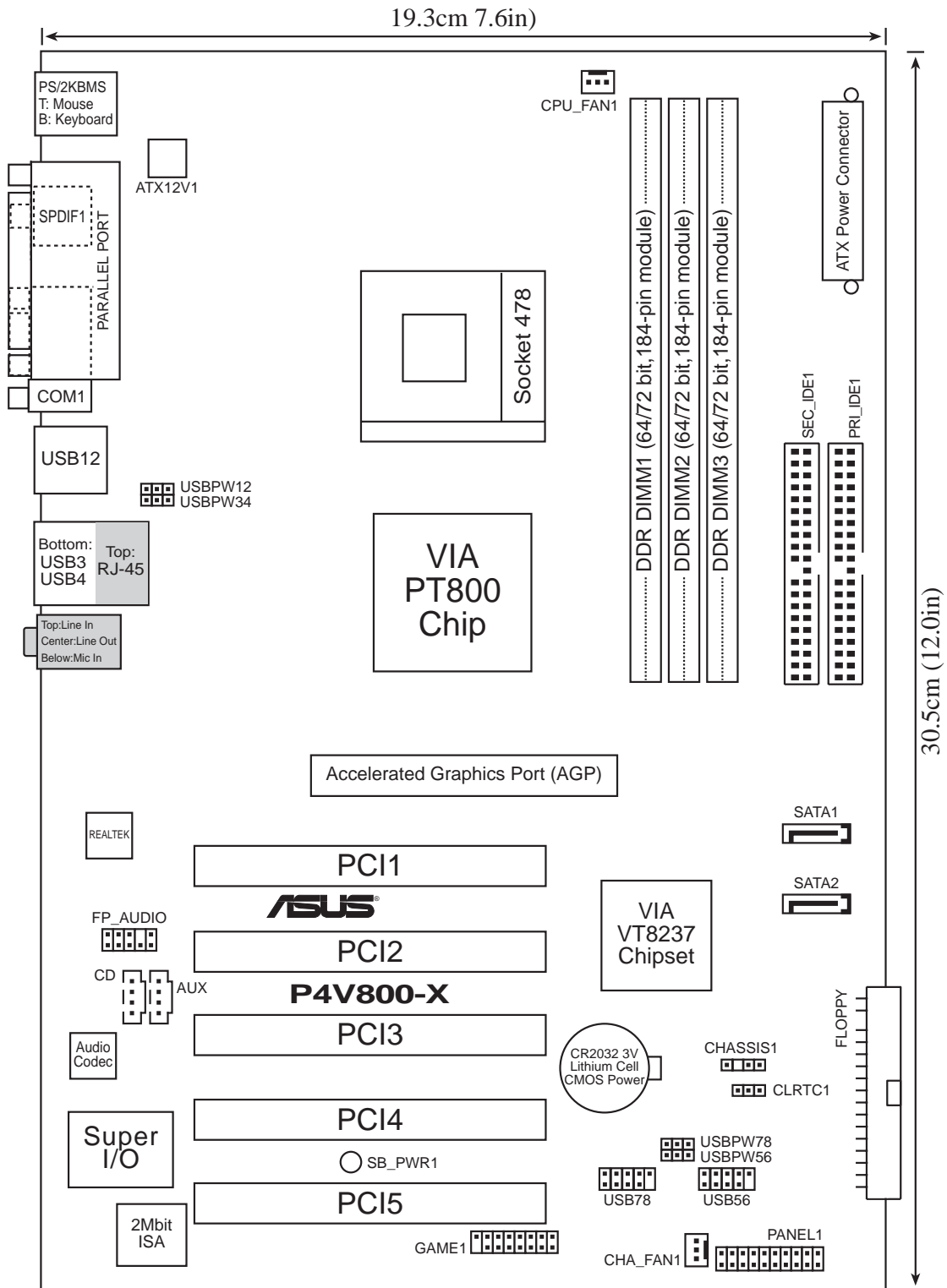

## 1.6 Before you proceed

Take note of the following precautions before you install motherboard components or change any motherboard settings.



1. Unplug the power cord from the wall socket before touching any component.
2. Use a grounded wrist strap or touch a safely grounded object or to a metal object, such as the power supply case, before handling components to avoid damaging them due to static electricity.
3. Hold components by the edges to avoid touching the ICs on them.
4. Whenever you uninstall any component, place it on a grounded antistatic pad or in the bag that came with the component.
5. **Before you install or remove any component, ensure that the ATX power supply is switched off or the power cord is detached from the power supply.** Failure to do so may cause severe damage to the motherboard, peripherals, and/or components.



When lit, the green LED (SB\_PWR) indicates that the system is ON, in sleep mode, or in soft-off mode, a reminder that you should shut down the system and unplug the power cable before removing or plugging in any motherboard component.

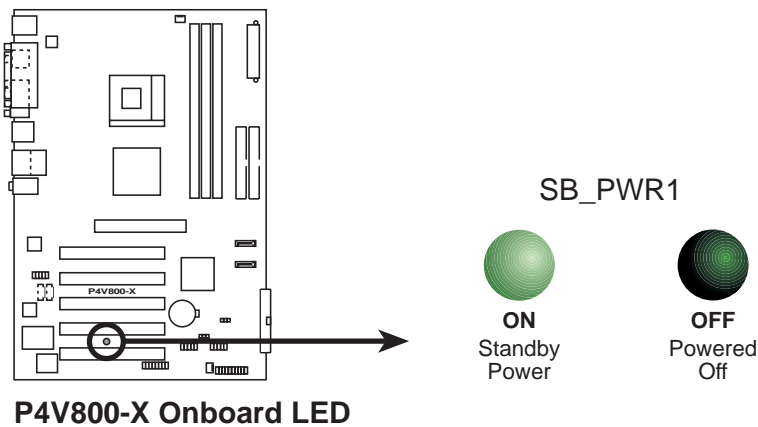

Install only 0.8V and 1.5V AGP cards on this motherboard to prevent damage to your AGP card or motherboard.

# 1.7 Motherboard installation

Before you install the motherboard, study the configuration of your chassis to ensure that the motherboard fits into it. The motherboard uses the ATX form factor that measures 12 inches x 7.6 inches (30.5 cm x 19.3 cm).



---

Make sure to unplug the power cord before installing or removing the motherboard. Failure to do so may cause you physical injury and damage motherboard components.

---

## 1.7.1 Placement direction

When installing the motherboard, make sure that you place it into the chassis in the correct orientation. The edge with external ports goes to the rear part of the chassis as indicated in the image below.

## 1.7.2 Screw holes

Place seven (7) screws into the holes indicated by circles to secure the motherboard to the chassis.



---

Do not overtighten the screws! Doing so may damage the motherboard.

---

Place this side towards  
the rear of the chassis

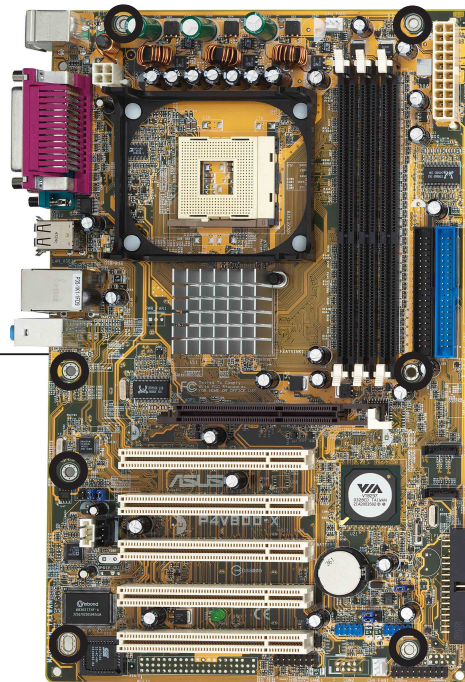

# 1.8 Central Processing Unit (CPU)

## 1.8.1 Overview

The motherboard comes with a surface mount 478-pin Zero Insertion Force (ZIF) socket. The socket is designed for the Intel® Pentium® 4 Processor in the 478-pin package with 512KB L2 cache. This processor supports 800/533/400MHz front side bus (FSB), and allows data transfer rates of up to 6.4GB/s. The socket will also support the Intel Prescott CPU when available.

Note in the illustration that the CPU has a gold triangular mark on one corner. This mark indicates the processor Pin 1 that should match a specific corner of the CPU socket.

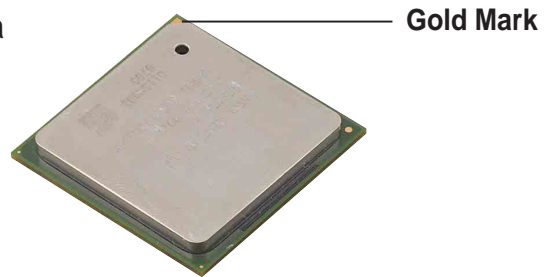

---

Incorrect installation of the CPU into the socket may bend the pins and severely damage the CPU!

---

## Notes on Intel® Hyper-Threading Technology



1. This motherboard supports Intel Pentium 4 CPUs with Hyper-Threading Technology.
  2. Hyper-Threading Technology is supported under **Windows XP** and later versions only.
  3. It is recommended that you install WinXP Service Pack 1.
  4. For more information on Hyper-Threading Technology, visit [www.intel.com/info/hyperthreading](http://www.intel.com/info/hyperthreading).
- 

To use the Hyper-Threading Technology on this motherboard:

1. Buy an Intel Pentium 4 CPU that supports Hyper-Threading Technology. Install the CPU.
2. Reboot the computer.

## 1.8.2 Installing the CPU

Follow these steps to install a CPU.

1. Locate the 478-pin ZIF socket on the motherboard.
2. Unlock the socket by pressing the lever sideways, then lift it up to a 90°-100° angle.



Make sure that the socket lever is lifted up to 90°-100° angle, otherwise the CPU does not fit in completely.

Socket Lever

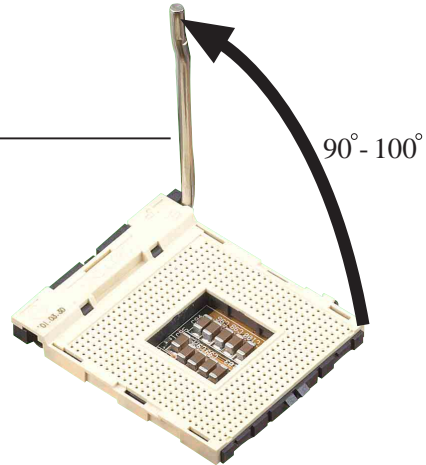

3. Position the CPU above the socket such that its marked corner matches the base of the socket lever.
4. Carefully insert the CPU into the socket until it fits in place.

Gold Mark

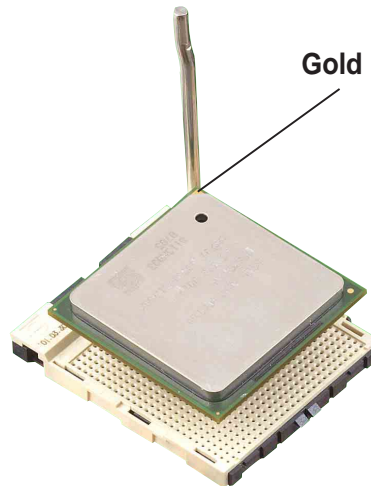

The CPU fits only in one correct orientation. **DO NOT** force the CPU into the socket to prevent bending the pins and damaging the CPU!

5. When the CPU is in place, push down the socket lever to secure the CPU. The lever clicks on the side tab to indicate that it is locked.
6. Install a CPU heatsink and fan following the instructions that came with the heatsink package.
7. Connect the CPU fan cable to the CPU\_FAN1 connector on the motherboard.



## 1.9 System memory

The motherboard comes with three Double Data Rate (DDR) Dual In-Line Memory Module (DIMM) sockets. These sockets support up to 3GB system memory using 184-pin unbuffered non-ECC PC3200/PC2700/PC2100 DDR DIMMs. The following figure shows the location of the DDR DIMM sockets.

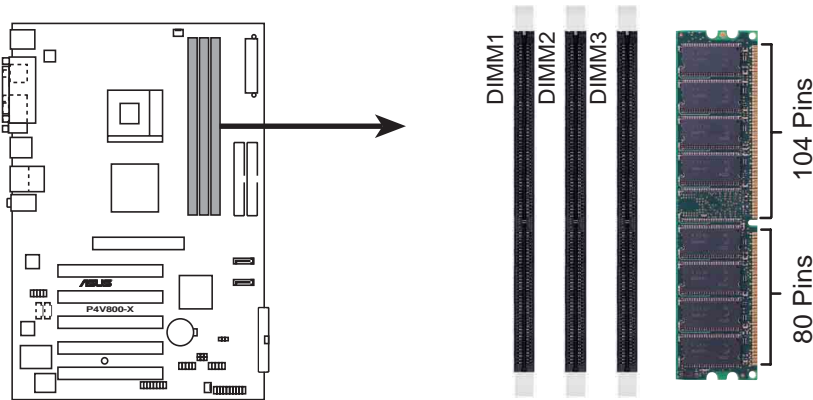

**P4V800-X 184-Pin DDR DIMM Sockets**

### 1.9.1 Installing a DIMM



Make sure to unplug the power supply before adding or removing DIMMs or other system components. Failure to do so may cause severe damage to both the motherboard and the components.

Follow these steps to install a DIMM.

1. Unlock a DIMM socket by pressing the retaining clips outward.
2. Align a DIMM on the socket such that the notch on the DIMM matches the break on the socket.
3. Firmly insert the DIMM into the socket until the retaining clips snap back in place and the DIMM is properly seated.

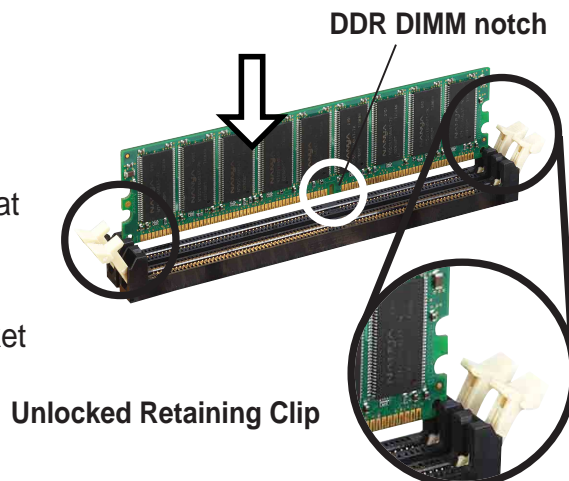

## 1.9.2 Memory configurations

You may install 64MB, 128MB, 256MB, 512MB, and 1GB DDR DIMMs into the DIMM sockets on this motherboard.



PC3200 DDR DIMMs max to 2 DIMMs only.

**Table 1 DDR400 Qualified Vendor List (QVL)**

Size	Vendor	Module	Brand	SS/DS	Component
256MB	TwinMos	M2G9I08AFATT9F081AA4T	TwinMos	SS	TMD7608F8E50D
256MB	TwinMos	M2G9I08AFTT9F0811DDT	TwinMos	SS	TMD7608F8E50B
256MB	TwinMos	M2S9I08AFAPS9F0811A-T	TwinMos	SS	A2S56D30ATP
256MB	Apacer	77.10636.465	Apacer	SS	K4H560838D-TCC4
512MB	Apacer	77.10736.464	Apacer	DS	K4H560838D-TCC4
256MB	Transcend	TS32MLD64V4F3	Transcend	SS	K4H560838D-TCCC
256MB	Transcend	TS32MLD64V4F3	Transcend	SS	V58C2256804SAT5
512MB	Transcend	TS64MLD64V4F3	Transcend	DS	V58C2256804SAT5
512MB	Transcend	TS64MLD64V4F3	Transcend	DS	HY5DU56822BT-D43
256MB	A DATA	MDOAD5F3G315B1EC2	A DATA	SS	ADD8608A8A-5B
256MB	A DATA	MDOWB5F3G316B1EAE	A DATA	SS	W942508BH-5
256MB	A DATA	MDOAD5F3G31YB1EZ2	A DATA	SS	ADD8608A8A-5B
256MB	GEIL	MAG32UL6464D2TG5A-KC	GEIL	SS	GL3LC32G88TG-5A
512MB	GEIL	MAG16UL3264D1TG5A-KC	GEIL	DS	GL3LC32G88TG-5A
256MB	KINGSTON	KVR400X64C25/256	KINGSTON	SS	W942508BH-5
256MB	KINGSTON	KVR400X64C3A/256	KINGSTON	SS	HY5DU56822BT-D43
512MB	KINGSTON	KVR400X64C3A/512	KINGSTON	DS	HY5DU56822BT-D43
256MB	Winbond	W9425GCDB-5	Winbond	SS	W942508CH-5
512MB	Infineon	HYS64D64320GU-5-B	Infineon	DS	HYB25D256800BT-5B
256MB	SAMSUNG	M368L3223ETM-CCC	SAMSUNG	SS	K4H560838E-TCCC
256MB	Hynix	HYMD232646B8J-D43 AA	Hynix	SS	HY5DU56822BT-D43
512MB	Hynix	HYMD264646B8J-D43 AA	Hynix	DS	HY5DU56822BT-D43
512MB	PSC	AL6D8A53T1-5B	PSC	DS	A2S56D30ATP
512MB	KINGMAX	MPXB62D-68KX3	KINGMAX	DS	KDL684T4AA-50
256MB	MICRON	MT8VDDT3264AG-40BC4	MICRON	SS	MT46V32M8TG-5BC
512MB	MICRON	MT16VDDT6464AG-40BC4	MICRON	DS	MT46V32M8TG-5BC
256MB	ATP	AG32L64T8SQC4S	ATP	SS	K4H560838D-TCC4
512MB	ATP	AG32L64T8SQC4S	ATP	DS	K4H560838D-TCC4
1024MB	ATP	AG28L64T8SMC4M	ATP	DS	MT46V64M4TG-5BC
128M	NANYA	NT128D64SH4B1G-5T	NANYA	SS	NT5DS16M16BT-5T
256MB	NANYA	NT256D64S88B1G-5T	NANYA	SS	NT5DS32M8BT-5T
512MB	NANYA	N512D64S8HB1G-5T	NANYA	DS	NT5DS32M8BT-5T
256MB	CENTURY	DXV6S8SSCCD3K27C	CENTURY	SS	K4H560838D-TCCC
512MB	CENTURY	DXV2S8SSCCD3K27C	CENTURY	DS	K4H560838D-TCCC
256MB	Elixir	M2U25664DS88B3G-5T	Elixir	SS	N2DS25680BT-5T
512MB	Elixir	M2U25664DS8HB3G-5T	Elixir	DS	N2DS25680BT-5T



Obtain DDR DIMMs only from ASUS qualified vendors for better system performance. Visit the ASUS website ([www.asus.com](http://www.asus.com)) for the latest QVL.

## 1.10 Expansion slots

The motherboard has five PCI slots and one Accelerated Graphics Port (AGP) slot.

To install and configure an expansion card:

1. Install an expansion card following the instructions that came with the chassis.  
NOTE: The AGP slot supports only 1.5V and 0.8V AGP cards.
2. Turn on the system and change the necessary BIOS settings, if any. See Chapter 2 for BIOS information.
3. Assign an IRQ to the card. Refer to the tables below.
4. Install the drivers and/or software applications for the expansion card according to the card documentation.

### 1.10.1 Standard interrupt assignments

IRQ	Priority	Standard Function
0	1	System Timer
1	2	Keyboard Controller
2	N/A	Programmable Interrupt
3*	11	Communications Port (COM2)
4*	12	Communications Port (COM1)
5*	13	Sound card (sometimes LPT2)
6	14	Floppy Disk Controller
7*	15	Printer Port (LPT1)
8	3	System CMOS/Real Time Clock
9*	4	ACPI Mode when used
10*	5	IRQ Holder for PCI Steering
11*	6	IRQ Holder for PCI Steering
12*	7	PS/2 Compatible Mouse Port
13	8	Numeric Data Processor
14*	9	Primary IDE Channel
15*	10	Secondary IDE Channel

\* These IRQs are usually available for ISA or PCI devices.

### 1.10.2 IRQ assignments for this motherboard

	A	B	C	D	E	F	G	H
PCI slot 1	—	shared	—	—	—	—	—	—
PCI slot 2	—	—	shared	—	—	—	—	—
PCI slot 3	—	—	—	used	—	—	—	—
PCI slot 4	shared	—	—	—	—	—	—	—
PCI slot 5	—	shared	—	—	—	—	—	—
AGP slot	shared	—	—	—	—	—	—	—
Onboard USB controller HC0	shared	—	—	—	—	—	—	—
Onboard USB controller HC1	shared	—	—	—	—	—	—	—
Onboard USB controller HC2	—	shared	—	—	—	—	—	—
Onboard USB controller HC3	—	shared	—	—	—	—	—	—
Onboard USB 2.0 controller	—	—	shared	—	—	—	—	—
Onboard LAN	shared	—	—	—	—	—	—	—
Onboard audio	—	—	shared	—	—	—	—	—



## 1.10.3 PCI slots

There are five 32-bit PCI slots on this motherboard. The slots support PCI cards such as a LAN card, SCSI card, USB card, and other cards that comply with PCI specifications.

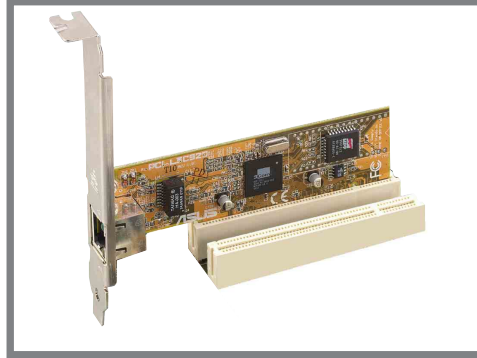

## 1.10.4 AGP slot

This motherboard has an Accelerated Graphics Port (AGP) slot that supports AGP 8X/4X cards. When you buy an AGP card, make sure that you ask for one with +1.5V or +0.8V specification.

Note the notches on the card golden fingers to ensure that they fit the AGP slot on your motherboard.



---

This motherboard does not support 3.3V AGP cards.

---

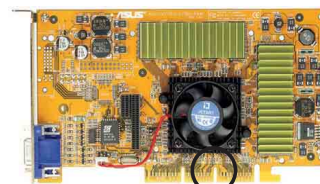
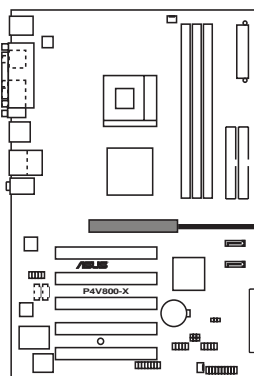

Keyed for 1.5v, 0.8v

**P4V800-X Accelerated Graphics Port (AGP)**

# 1.11 Jumper

## 1. Clear RTC RAM (CLRTC1)

This jumper allows you to clear the Real Time Clock (RTC) RAM in CMOS. You can clear the CMOS memory of date, time, and system setup parameters by erasing the CMOS RTC RAM data. The RAM data in CMOS, that include system setup information such as system passwords, is powered by the onboard button cell battery.

To erase the RTC RAM:

1. Turn OFF the computer and unplug the power cord.
2. Move the jumper cap from pins 2-3 (default) to pins 1-2. Keep the cap on pins 1-2 for about 5~10 seconds, then move the cap back to pins 2-3.
3. Plug the power cord and turn ON the computer.
4. Hold down the <Del> key during the boot process and enter BIOS setup to re-enter data.



Except when clearing the RTC RAM, never remove the cap on CLRTC1 jumper default position. Removing the cap will cause system boot failure!

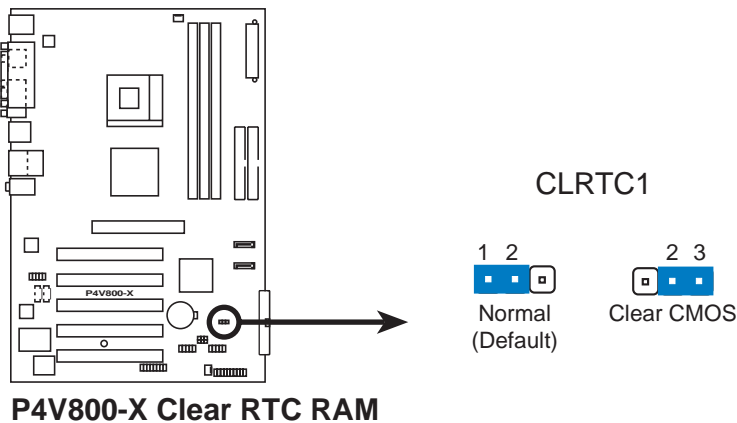

## 2. USB device wake-up (3-pin USBPW12, USBPW34, USBPW56, USBPW78)

Set these jumpers to +5V to wake up the computer from S1 sleep mode (CPU stopped, DRAM refreshed, system running in low power mode) using the connected USB devices. Set to +5VSB to wake up from S3 sleep mode (no power to CPU, DRAM in slow refresh, power supply in reduced power mode). All jumpers are set to pins 1-2 (+5V) by default because not all computers have the appropriate power supply to support this feature.

The USBPW12 and USBPW34 jumpers are for the rear USB ports. The USBPW56 and USBPW78 jumpers are for the internal USB header that you can connect to the front USB ports.



1. This feature requires a power supply that can provide 500mA on the +5VSB lead for each USB port.
2. The total current consumed must NOT exceed the power supply capability (+5VSB) whether under normal or in sleep mode.

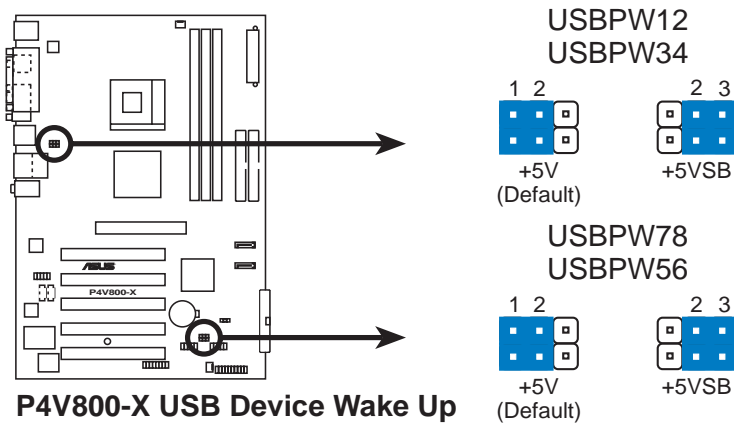

# 1.12 Connectors

This section describes and illustrates the internal connectors on the motherboard.

## 1. Floppy disk drive connector (34-1 pin FLOPPY1)

This connector supports the provided floppy drive ribbon cable. After connecting one end to the motherboard, connect the other end to the floppy drive. (Pin 5 is removed to prevent incorrect insertion when using ribbon cables with pin 5 plug).

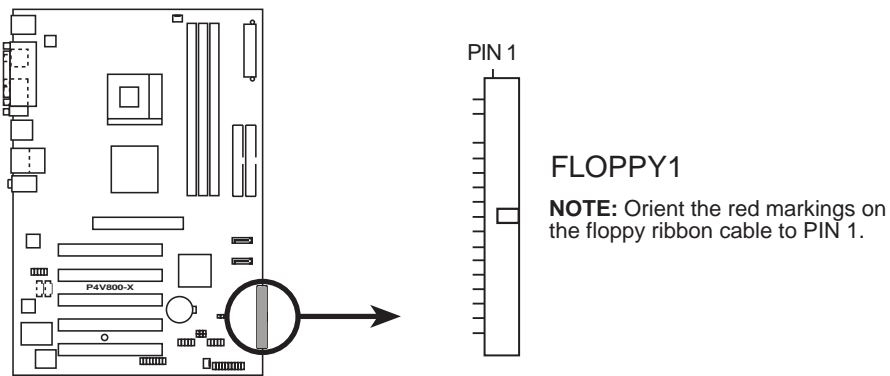

**P4V800-X Floppy Disk Drive Connector**

## 2. Serial ATA connectors (7-pin SATA1, SATA2)

These next generation connectors support the thin Serial ATA cables for Serial ATA hard disks. The current Serial ATA interface allows up to 150 MB/s data transfer rate, faster than the standard parallel ATA with 133 MB/s (Ultra ATA/133).

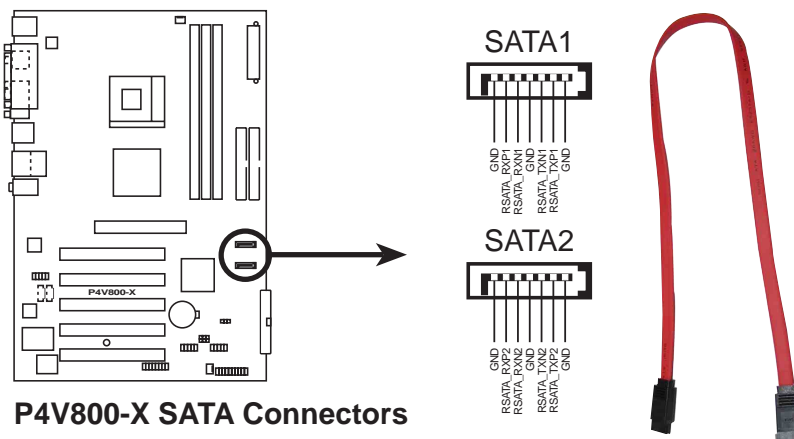

**P4V800-X SATA Connectors**

### 3. IDE connectors (40-1 pin PRI\_IDE, SEC\_IDE)

This connector supports the provided UltraDMA100/66 IDE ribbon cable. Connect the cable's blue connector to the primary (recommended) or secondary IDE connector, then connect the gray connector to the UltraDMA100/66 slave device (hard disk drive) and the black connector to the UltraDMA100/66 master device. It is recommended that you connect non-UltraDMA100/66 devices to the secondary IDE connector. If you install two hard disks, you must configure the second drive as a slave device by setting its jumper accordingly. Refer to the hard disk documentation for the jumper settings. BIOS supports specific device bootup. If you have more than two UltraDMA100/66/33 devices, purchase another UltraDMA100/66/33 cable. You may configure two hard disks to be both master devices with two ribbon cables – one for the primary IDE connector and another for the secondary IDE connector.



1. Pin 20 on each IDE connector is removed to match the covered hole on the UltraDMA cable connector. This prevents incorrect orientation when you connect the cables.
2. The hole near the blue connector on the UltraDMA100/66 cable is intentional.
3. For UltraDMA100/66 IDE devices, use the 80-conductor IDE cable.

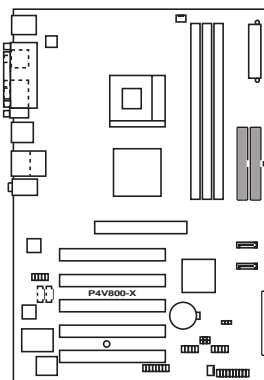

**P4V800-X IDE Connectors**

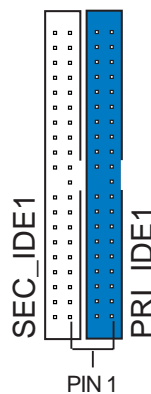

**NOTE:** Orient the red markings (usually zigzag) on the IDE ribbon cable to PIN 1.

#### 4. ATX power connectors (20-pin ATXPWR1, 4-pin ATX12V1)

These connectors connect to an ATX 12V power supply. The plugs from the power supply are designed to fit these connectors in only one orientation. Find the proper orientation and push down firmly until the connectors completely fit.

In addition to the 20-pin ATXPWR1 connector, connect the 4-pin ATX +12V power plug to provide sufficient power to the CPU.



Make sure that your ATX 12V power supply can provide 8A on the +12V lead and at least 1A on the +5-volt standby lead (+5VSB). The minimum recommended wattage is 230W, or 300W for a fully configured system. The system may become unstable and may experience difficulty powering up if the power supply is inadequate.

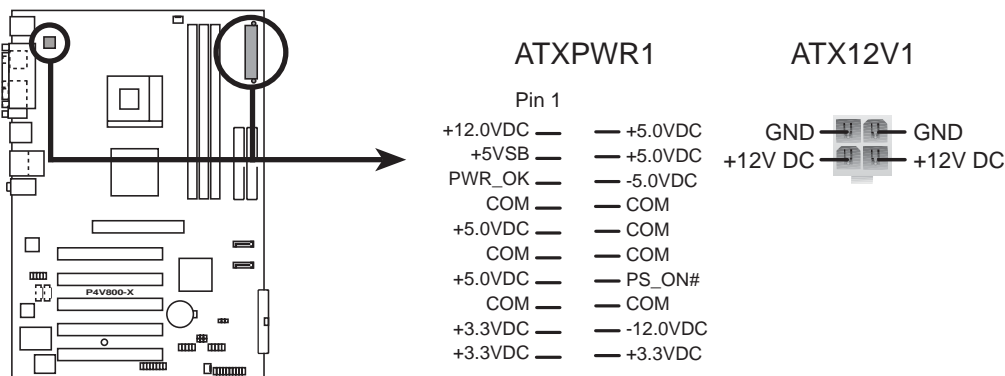

**P4V800-X ATX Power Connectors**

#### 5. CPU and chassis fan connectors (3-pin CPU\_FAN1, CHA\_FAN1)

The fan connectors support cooling fans of 350mA~740mA (8.88W max.) or a total of 1A~2.22A (26.64W max.) at +12V. Connect the fan cables to the fan connectors on the motherboard, making sure that the black wire of each cable matches the ground pin of the connector.



Do not forget to connect the fan cables to the fan connectors. Lack of sufficient air flow within the system may damage the motherboard components. These are not jumpers! DO NOT place jumper caps on the fan connectors!

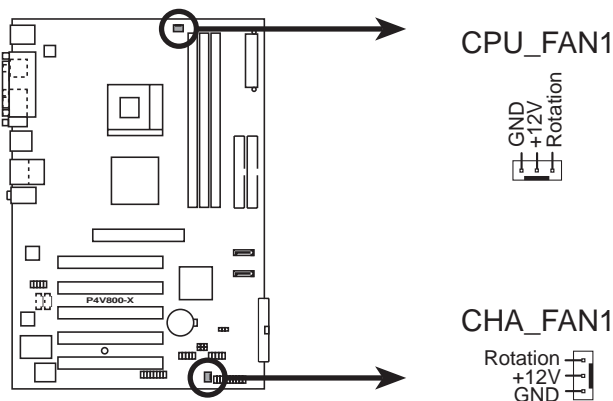

**P4V800-X 12-Volt Fan Connectors**

## 6. Internal audio connectors (4-pin CD1, AUX1)

These connectors allow you to receive stereo audio input from sound sources such as a CD-ROM, TV tuner, or MPEG card.

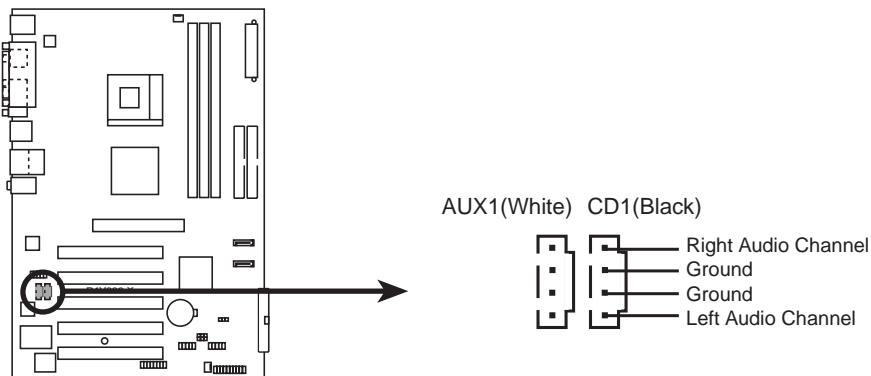

**P4V800-X Internal Audio Connectors**

## 7. USB header (10-1 pin USB56, USB78)

If the USB ports on the rear panel are inadequate, two USB headers are available for additional USB ports. The USB header complies with USB 2.0 specification that supports up to 480 Mbps connection speed. This speed advantage over the conventional 12 Mbps on USB 1.1 allows faster Internet connection, interactive gaming, and simultaneous running of high-speed peripherals.

Connect an optional USB 2.0/GAME module to this header. The module has two USB 2.0 ports that support the next generation USB peripherals such as high resolution cameras, scanners, and printers.



You must install the driver before you can use the USB 2.0 capability.

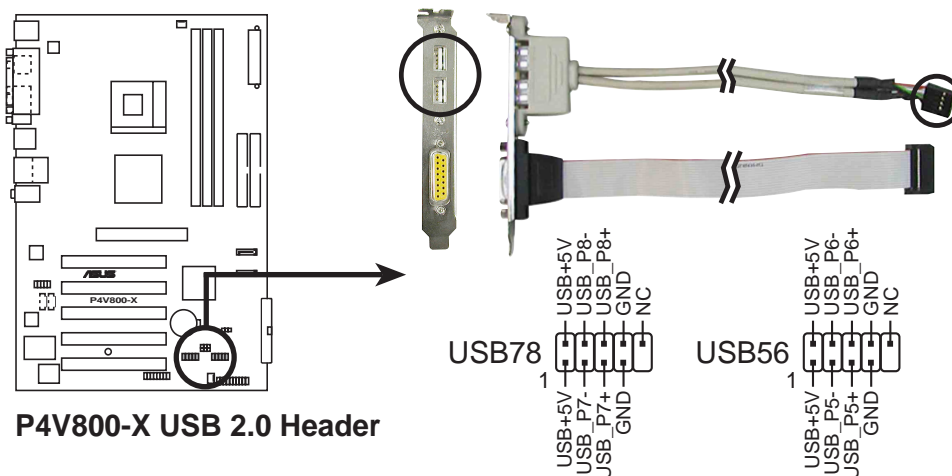

**P4V800-X USB 2.0 Header**



The USB2.0 module is purchased separately.

## 8. GAME/MIDI connector (16-1 pin GAME1)

This connector supports a GAME/MIDI module. Connect an optional GAME/MIDI cable to this connector. The GAME/MIDI port on the module connects a joystick or a game pad for playing games, and MIDI devices for playing or editing audio files.



The USB/GAME module is purchased separately.

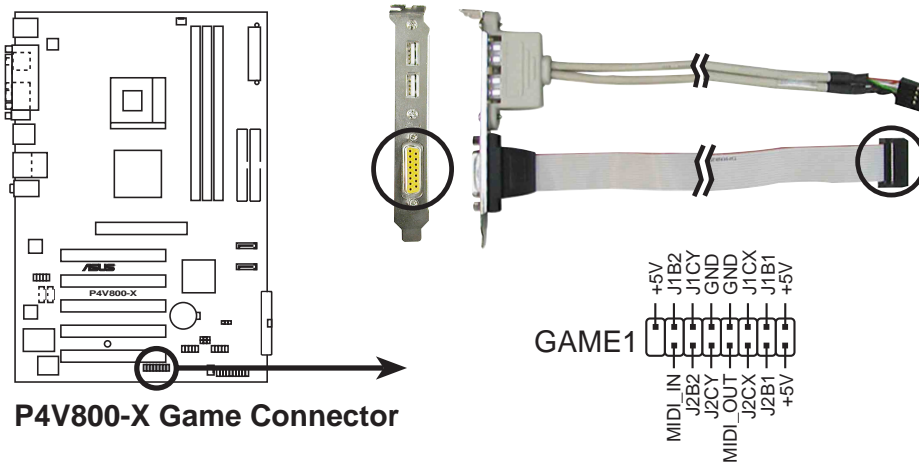

## 9. Front panel audio connector (10-1 pin FP\_AUDIO1)

This is an interface for the Intel front panel audio cable that allow convenient connection and control of audio devices.

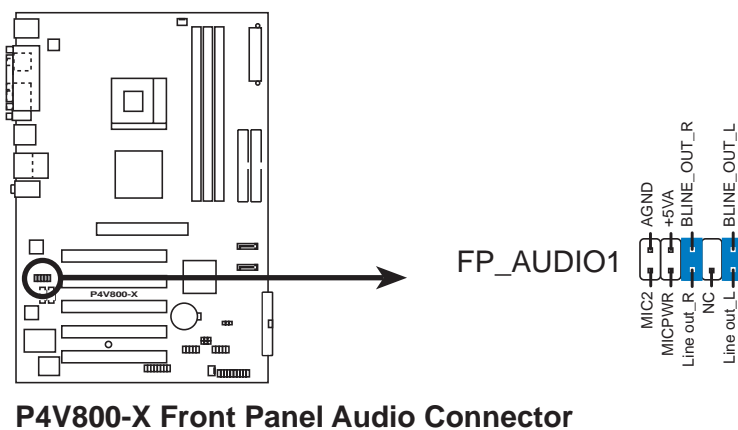



## 10. Chassis intrusion connector (4-1 pin CHASSIS1)

This lead is for a chassis designed with intrusion detection feature. This requires an external detection mechanism such as a chassis intrusion sensor or microswitch. When you remove any chassis component, the sensor triggers and sends a high-level signal to this lead to record a chassis intrusion event.

By default, the pins labeled “Chassis Signal” and “Ground” are shorted with a jumper cap. If you wish to use the chassis intrusion detection feature, remove the jumper cap from the pins.

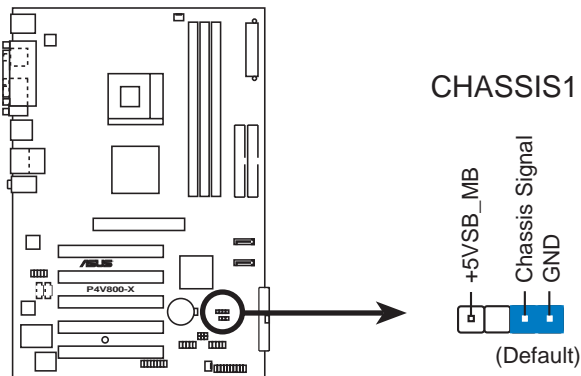

**P4V800-X Chassis Alarm Lead**

## 11. System panel connector (20-pin PANEL1)

This connector accommodates several system front panel functions.

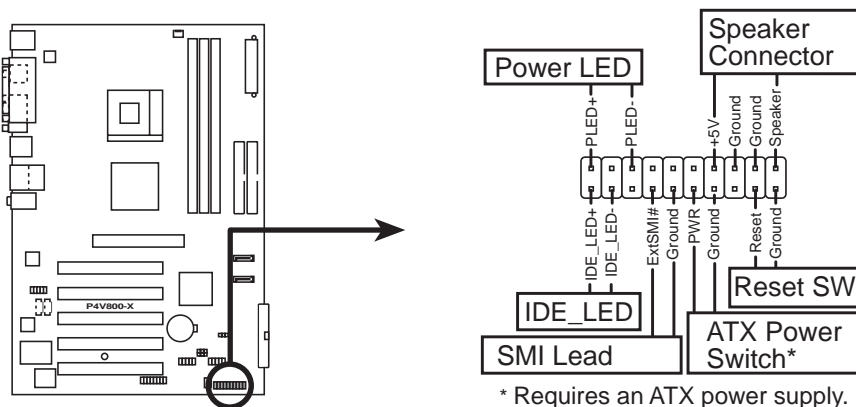

**P4V800-X System Panel Connector**

- **System Power LED Lead (3-1 pin PLED)**

This 3-1 pin connector connects to the system power LED. The LED lights up when you turn on the system power, and blinks when the system is in sleep mode.

- **System Warning Speaker Lead (4-pin SPKR)**

This 4-pin connector connects to the case-mounted speaker and allows you to hear system beeps and warnings.

- **Reset Switch Lead (2-pin RESET)**

This 2-pin connector connects to the case-mounted reset switch for rebooting the system without turning off the system power.
- **ATX Power Switch/Soft-off Switch Lead (2-pin PWR)**

This connector connects a switch that controls the system power. Pressing the power switch turns the system between ON and SLEEP, or ON and SOFT OFF, depending on the BIOS or OS settings. Pressing the power switch while in the ON mode for more than 4 seconds turns the system OFF.
- **System Management Interrupt Lead (2-pin SMI)**

This 2-pin connector allows you to manually place the system into a suspend mode, or “green” mode, where system activity is instantly decreased to save power and to expand the life of certain system components. Attach the case-mounted suspend switch to this 2-pin connector.
- **Hard Disk Activity Lead (2-pin IDE\_LED)**

This connector supplies power to the hard disk activity LED. The read or write activities of any device connected to the primary or secondary IDE connector cause this LED to light up.

# *Chapter 2*

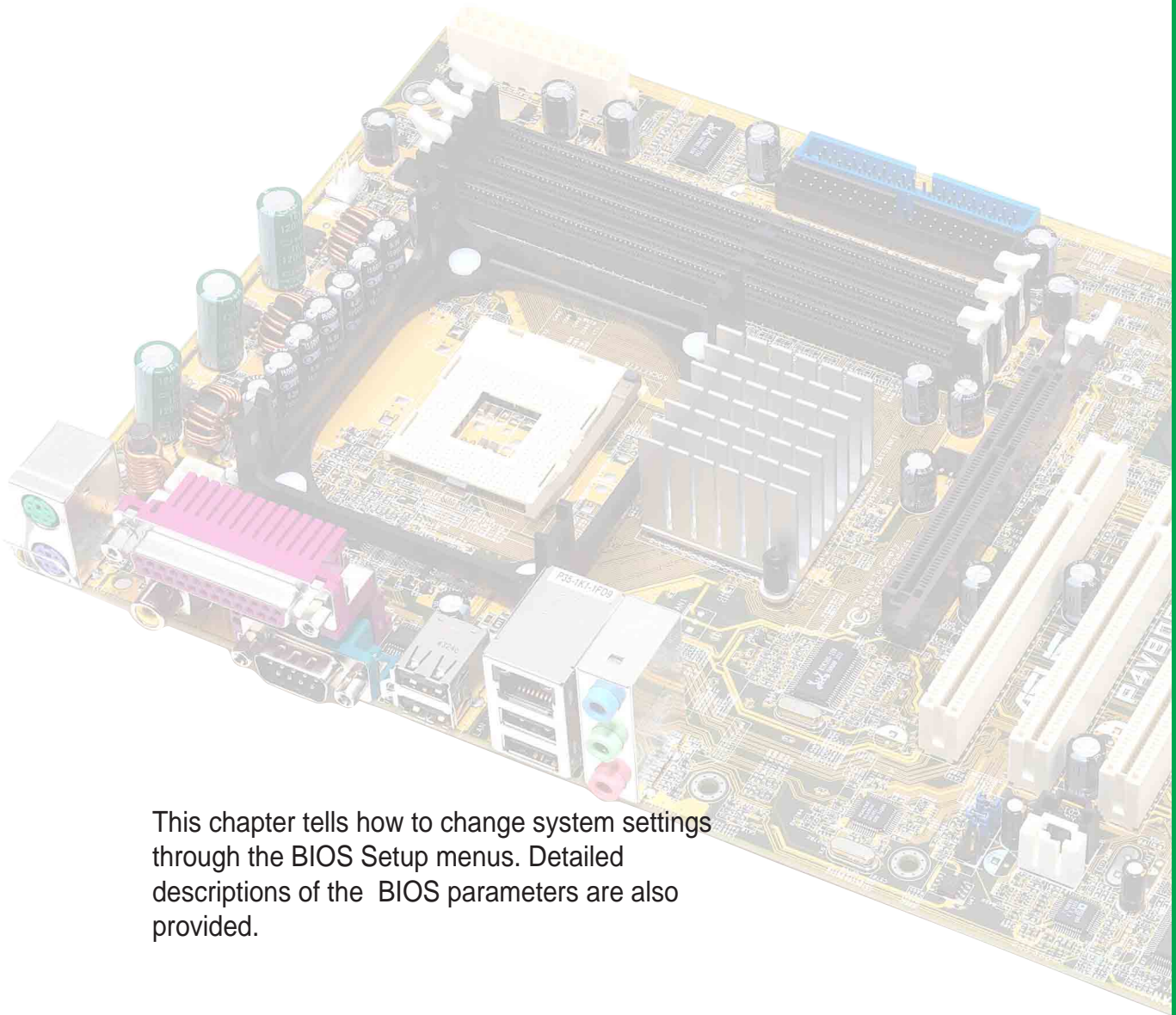

This chapter tells how to change system settings through the BIOS Setup menus. Detailed descriptions of the BIOS parameters are also provided.

## **BIOS information**

## 2.1 Managing and updating your BIOS



---

The **original BIOS file** for this motherboard is in the support CD.

Copy the original BIOS to a **bootable floppy disk** in case you need to restore the BIOS in the future.

---

### 2.1.1 Creating a bootable floppy disk

1. Do either one of the following to create a bootable floppy disk.

#### DOS environment

Insert a 1.44 MB floppy disk into the drive. At the DOS prompt, type:

```
format A:/S <Enter>
```

#### Windows environment

- a. From your Windows desktop, click on **Start**, point to **Settings**, then click on **Control Panel**.
  - b. Double-click on **Add/Remove Programs** icon from the Control Panel window.
  - c. Click on the **Startup Disk** tab, then on **Create Disk...** button.
  - d. Insert a 1.44 MB floppy disk when prompted. Follow the succeeding screen instructions to complete the process.
2. Copy the original (or the latest) motherboard BIOS to the bootable floppy disk.

### 2.1.2 Using AFUDOS to update the BIOS

Update the BIOS using the AFUDOS.EXE utility in DOS environment.

1. Visit the ASUS website ([www.asus.com](http://www.asus.com)) to download the latest BIOS file for your motherboard. Save the BIOS file to a bootable floppy disk.



---

Write down the BIOS file name to a piece of paper. You need to type the **exact BIOS file name** at the prompt.

---

2. Copy the AFUDOS.EXE utility from the support CD to the bootable floppy disk that contains the BIOS file.
3. Boot the system from the floppy disk.

4. At the DOS prompt, type the command line:

**afudos /i<filename.rom>**

where “filename.rom” means the latest (or original) BIOS file that you copied to the bootable floppy disk.

The screen displays the status of the update process.



---

The BIOS information on the screen is for reference only. What you see on your screen may not be exactly the same as shown.

---

```
A:\>afudos /ip4v800-x.rom
AMI Firmware Update Utility - Version 1.10
Copyright (C) 2002 American Megatrends, Inc. All rights reserved.

Reading file ..... done
Erasing flash .... done
Writing flash .... 0x0008CC00 (9%)
```



---

**DO NOT** shutdown or reset the system while updating the BIOS! Doing so may cause system boot failure!

---

When the BIOS update process is complete, the utility returns to the DOS prompt.

```
A:\>afudos /ip4v800-x.rom
AMI Firmware Update Utility - Version 1.10
Copyright (C) 2002 American Megatrends, Inc. All rights reserved.

Reading file ..... done
Erasing flash .... done
Writing flash .... 0x0008CC00 (9%)
Verifying flash .. done

A:\>
```

5. Reboot the system from the hard disk.

## 2.1.3 Using AFUDOS to copy BIOS from PC

The AFUDOS.EXE utility can also be used to copy the current system BIOS settings to a floppy or hard disk. The copy can be used as a backup in case the system BIOS fails or gets corrupted.

1. At the DOS prompt, type the command line:

**afudos /o<filename>**

where “filename” can be any user provided filename of not more than eight (8) alpha-numeric characters for the main filename and three (3) alpha-numeric characters for the extension name.

Press the **Enter** key.



---

The BIOS information on the screen is for reference only. What you see on your screen may not be exactly the same as shown.

---

```
A:\>afudos /oMYBIOS03.rom
AMI Firmware Update Utility - Version 1.10
Copyright (C) 2002 American Megatrends, Inc. All rights reserved.

Reading flash ..... 0x0008CC00 (9%)
```

2. The utility will copy the current system BIOS by default to the floppy disk. Make sure that the floppy disk is not write-protected and have enough space (at least 600KB) to store the file.

```
A:\>afudos /oMYBIOS03.rom
AMI Firmware Update Utility - Version 1.10
Copyright (C) 2002 American Megatrends, Inc. All rights reserved.

Reading flash ..... done

A:\>
```

When the BIOS copy process is complete, the utility returns to the DOS prompt.

## 2.1.4 Using ASUS EZ Flash to update the BIOS

The ASUS EZ Flash feature allows you to easily update the BIOS without having to go through the long process of booting from a diskette and using a DOS-based utility. The EZ Flash is built-in the BIOS firmware so it is accessible by simply pressing <Alt> + <F2> during the Power-On Self Tests (POST).

### To update the BIOS using ASUS EZ Flash:

1. Visit the ASUS website ([www.asus.com](http://www.asus.com)) to download the latest BIOS file for your motherboard and rename it to **P4V800-X.ROM**. Save the BIOS file to a floppy disk.
2. Reboot the system.
3. To launch EZ Flash, press <Alt> + <F2> during POST to display the following.

```
User recovery requested. Starting BIOS recovery...
Checking for floppy...
```



---

If there is no floppy disk found in the drive, the error message “**Floppy not found!**” appears.

If the correct BIOS file is not found in the floppy disk, the error message “**P4V800-X.ROM not found!**”

---

4. Insert the floppy disk that contains the BIOS file. If the **P4V800-X.ROM** file is found in the floppy disk, EZ Flash performs the BIOS update process and automatically reboots the system when done.



---

DO NOT shutdown or reset the system while updating the BIOS! Doing so may cause system boot failure!

---

```
User recovery requested. Starting BIOS recovery...
Checking for floppy...
Floppy found!
Reading file "p4v800-x.rom". Completed.
Start flashing...
Flashed successfully. Rebooting.
```

## 2.1.5 Recovering the BIOS with CrashFree BIOS 2

The CrashFree BIOS 2 auto recovery tool allows you to restore BIOS from the motherboard support CD, or from a floppy disk that contains the BIOS file, in case the current BIOS on the motherboard fails or gets corrupted.



1. Prepare the **support CD** that came with the motherboard or a **floppy disk that contains the motherboard BIOS** (P4V800-X.ROM) before proceeding with the BIOS update process.
2. If you have saved a copy of the original motherboard BIOS to a bootable floppy disk, you may also use this disk to restore the BIOS. See section “2.1.1 Creating a bootable floppy disk.”

### To recover the BIOS from a floppy disk:

1. Boot the system.
2. When a corrupted BIOS is detected, the following message appears.

```
Bad BIOS checksum. Starting BIOS recovery...
Checking for floppy...
```

3. Insert a floppy disk that contains the original, or the latest, BIOS file for this motherboard (P4V800-X.ROM). If the BIOS file that you downloaded from the ASUS website has a different filename (e.g. P4V800-X2.ROM), rename it to **P4V800-X.ROM**. The BIOS update process continues when the P4V800-X.ROM is found.

```
Bad BIOS checksum. Starting BIOS recovery...
Checking for floppy...
Floppy found!
Reading file "p4v800-x.rom". Completed.
Start flashing...
```



DO NOT shutdown or reset the system while updating the BIOS! Doing so may cause system boot failure!

4. When the BIOS update process is complete, reboot the system.



## To recover the BIOS from the support CD:

1. Boot the system.
2. When a corrupted BIOS is detected, the following screen message appears.

```
Bad BIOS checksum. Starting BIOS recovery...
Checking for floppy...
```



---

If there is no floppy disk found in the drive, the system automatically checks the CD-ROM.

---

3. Place the support CD in the CD-ROM. The support CD contains the original BIOS for this motherboard.

```
Bad BIOS checksum. Starting BIOS recovery...
Checking for floppy...
Floppy not found!
Checking for CD-ROM...
CD-ROM found.
Reading file "p4c800.rom". Completed.
Start flashing...
```



---

**DO NOT** shutdown or reset the system while updating the BIOS! Doing so may cause system boot failure!

---

4. When the BIOS update process is complete, reboot the system.



---

The recovered BIOS may not be the latest BIOS version for this motherboard. Visit the ASUS website ([www.asus.com](http://www.asus.com)) to download the latest BIOS file.

---

## 2.2 BIOS Setup program

This motherboard supports a programmable firmware hub (FWH) that you can update using the provided utility described in section “2.1 Managing and updating your BIOS.”

Use the BIOS Setup program when you are installing a motherboard, reconfiguring your system, or prompted to “Run Setup”. This section explains how to configure your system using this utility.

Even if you are not prompted to use the Setup program, you may want to change the configuration of your computer in the future. For example, you may want to enable the security password feature or change the power management settings. This requires you to reconfigure your system using the BIOS Setup program so that the computer can recognize these changes and record them in the CMOS RAM of the firmware hub.

The firmware hub on the motherboard stores the Setup utility. When you start up the computer, the system provides you with the opportunity to run this program. Press <Delete> during the Power-On Self Test (POST) to enter the Setup utility. Otherwise, POST continues with its test routines.

If you wish to enter Setup after POST, restart the system by pressing <Ctrl> + <Alt> + <Delete>, or by pressing the reset button on the system chassis. You can also restart by turning the system off and then back on. Do this last option only if the first two failed.

The Setup program is designed to make it as easy to use as possible. It is a menu-driven program, which means you can scroll through the various sub-menus and make your selections from the available options using the navigation keys.



---

If the system becomes unstable after changing any BIOS settings, load the default settings to ensure system stability. Select the **Load Default Settings** item under the Exit Menu. See section “2.7 Exit Menu.”

---



---

The BIOS setup screens shown in this chapter are for reference purposes only, and may not exactly match what you see on your screen.

Visit the ASUS website ([www.asus.com](http://www.asus.com)) to download the latest product and BIOS information.

---

## 2.2.1 BIOS menu screen

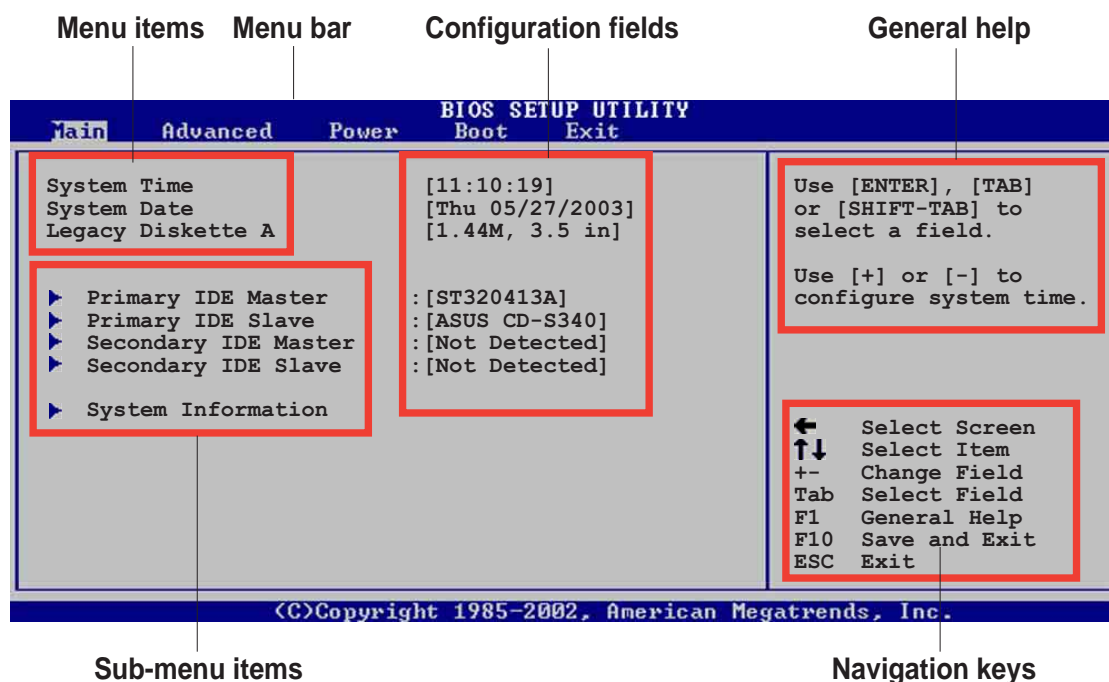

## 2.2.2 Menu bar

The menu bar on top of the screen has the following main items:

<b>Main</b>	For changing the basic system configuration
<b>Advanced</b>	For changing the advanced system settings
<b>Power</b>	For changing the advanced power management (APM) configuration
<b>Boot</b>	For changing the system boot configuration
<b>Exit</b>	For selecting the exit options and loading default settings

To select an item on the menu bar, press the right or left arrow key on the keyboard until the desired item is highlighted.

## 2.2.3 Navigation keys

At the **bottom right corner** of a menu screen are the navigation keys for that particular menu. Use the navigation keys to select items in the menu and change the settings.



Some of the navigation keys differ from one screen to another.

## 2.2.4 Menu items

The highlighted item on the menu bar displays the specific items for that menu. For example, selecting **Main** shows the Main menu items.

The other items (Advanced, Power, Boot, and Exit) on the menu bar have their respective menu items.

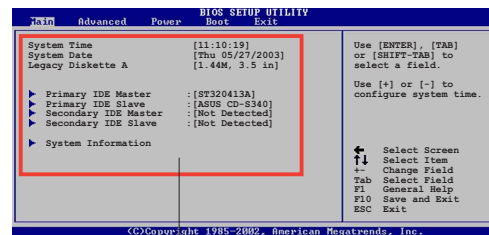

Main menu items

## 2.2.5 Sub-menu items

An item with a sub-menu on any menu screen is distinguished by a solid triangle before the item. To display the sub-menu, select the item and press Enter.

## 2.2.6 Configuration fields

These fields show the values for the menu items. If an item is user-configurable, you may change the value of the field opposite the item. You can not select an item that is not user-configurable.

A configurable field is enclosed in brackets, and is highlighted when selected. To change the value of a field, select it then press Enter to display a list of options. Refer to “2.2.7 Pop-up window.”

## 2.2.7 Pop-up window

Select a menu item then press Enter to display a pop-up window with the configuration options for that item.

## 2.2.8 Scroll bar

A scroll bar appears on the right side of a menu screen when there are items that do not fit on the screen. Press **Up/Down arrow keys** or **PageUp/PageDown keys** to display the other items on the screen.

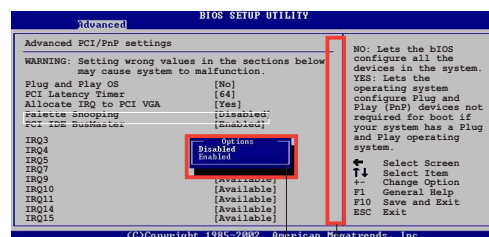

Pop-up window

Scroll bar

## 2.2.9 General help

At the top right corner of the menu screen is a brief description of the selected item.

## 2.3 Main menu

When you enter the BIOS Setup program, the Main menu screen appears giving you an overview of the basic system information.



Refer to section “2.2.1 BIOS menu screen” for information on the menu screen items and how to navigate through them.

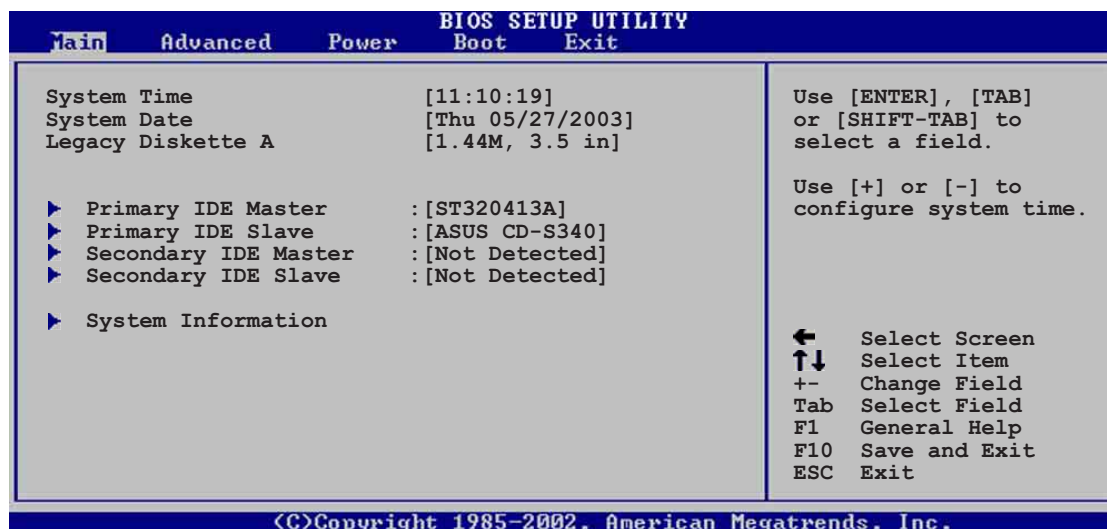

### 2.3.1 System Time [xx:xx:xxxx]

This item allows you to set the system time.

### 2.3.2 System Date [Day xx/xx/xxxx]

This item allows you to set the system date.

### 2.3.3 Legacy Diskette A [1.44M, 3.5 in.]

Sets the type of floppy drive installed. Configuration options: [Disabled] [360K, 5.25 in.] [1.2M , 5.25 in.] [720K , 3.5 in.] [1.44M, 3.5 in.] [2.88M, 3.5 in.]

## 2.3.4 Primary/Secondary/Third/Fourth IDE Master/Slave

While entering Setup, BIOS auto-detects the presence of IDE devices. There is a separate sub-menu for each IDE device. Select a device item then press Enter to display the IDE device information.

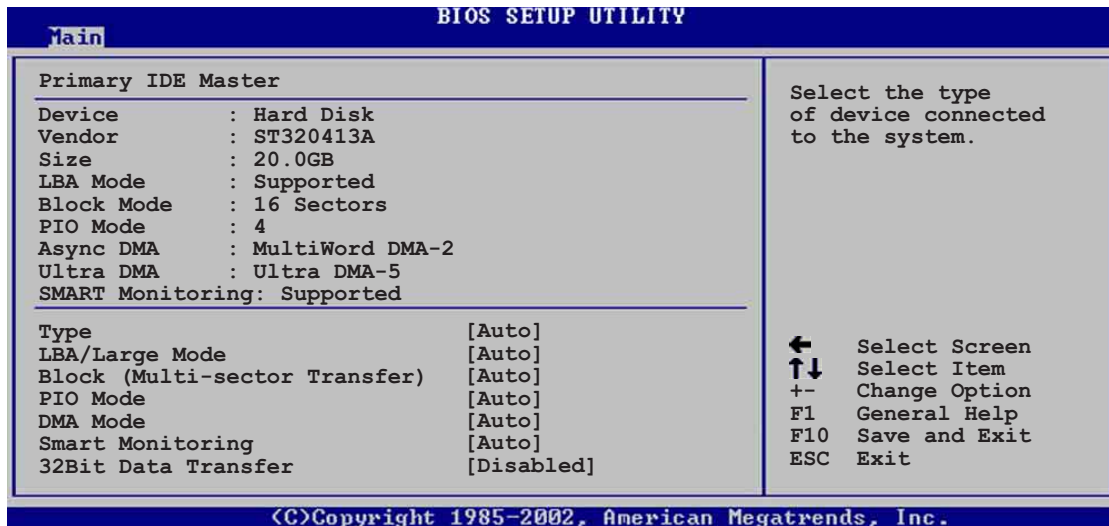

The values opposite the dimmed items (Device, Vendor, Size, LBA Mode, Block Mode, PIO Mode, Async DMA, Ultra DMA, and SMART monitoring) are auto-detected by BIOS and are not user-configurable. These items show N/A if no IDE device is installed in the system.

### Type [Auto]

Selects the type of IDE drive. Configuration options: [Not Installed] [Auto] [CDROM] [ARMD]

### LBA/Large Mode [Auto]

Enables or disables the LBA mode. Setting to Auto enables the LBA mode if the device supports this mode, and if the device was not previously formatted with LBA mode disabled. Configuration options: [Disabled] [Auto]

### Block (Multi-sector Transfer) [Auto]

Enables or disables data multi-sectors transfers. When set to Auto, the data transfer from and to the device occurs multiple sectors at a time if the device supports multi-sector transfer feature. When set to Disabled, the data transfer from and to the device occurs one sector at a time. Configuration options: [Disabled] [Auto]

### PIO Mode [Auto]

Selects the PIO mode. Configuration options: [Auto] [0] [1] [2] [3] [4]

### DMA Mode [Auto]

Selects the DMA mode. Configuration options: [Auto] [SWDMA0] [SWDMA1] [SWDMA2] [MWDMA0] [MWDMA1] [MWDMA2] [UDMA0] [UDMA1] [UDMA2] [UDMA3] [UDMA4] [UDMA5]

### SMART Monitoring [Auto]

Sets the Smart Monitoring, Analysis, and Reporting Technology. Configuration options: [Auto] [Disabled] [Enabled]

### 32Bit Data Transfer [Disabled]

Enables or disables 32-bit data transfer. Configuration options: [Disabled] [Enabled]

## 2.3.5 System Information

This menu gives you an overview of the general system specifications. The items in this menu are auto-detected by BIOS.

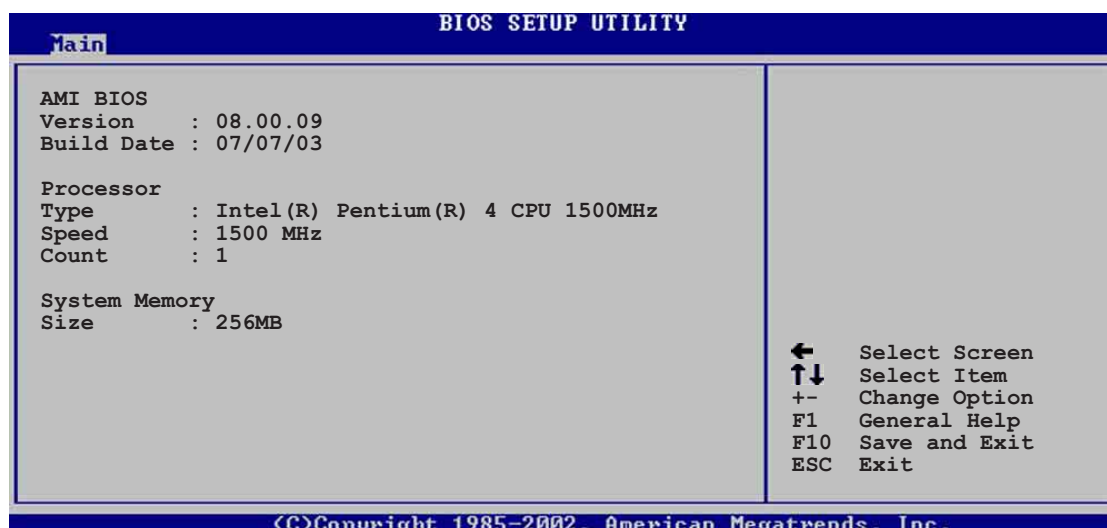

### AMI BIOS

This item displays the auto-detected BIOS information.

### Processor

This item displays the auto-detected CPU specification.

### System Memory

This item displays the auto-detected system memory.

## 2.4 Advanced menu

The Advanced menu items allow you to change the settings for the CPU and other system devices.



Take caution when changing the settings of the Advanced menu items. Incorrect field values may cause the system to malfunction.

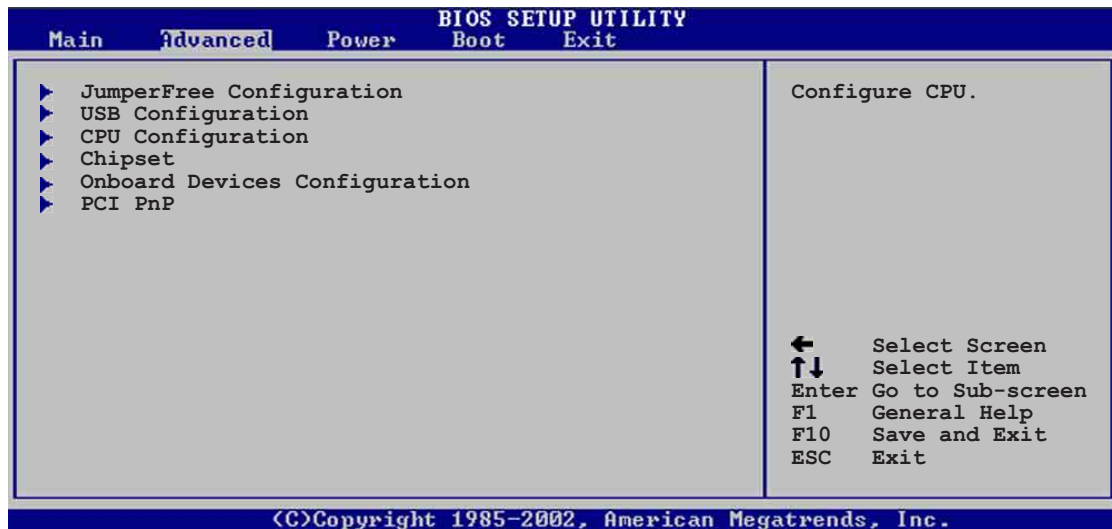

### 2.4.1 JumperFree Configuration

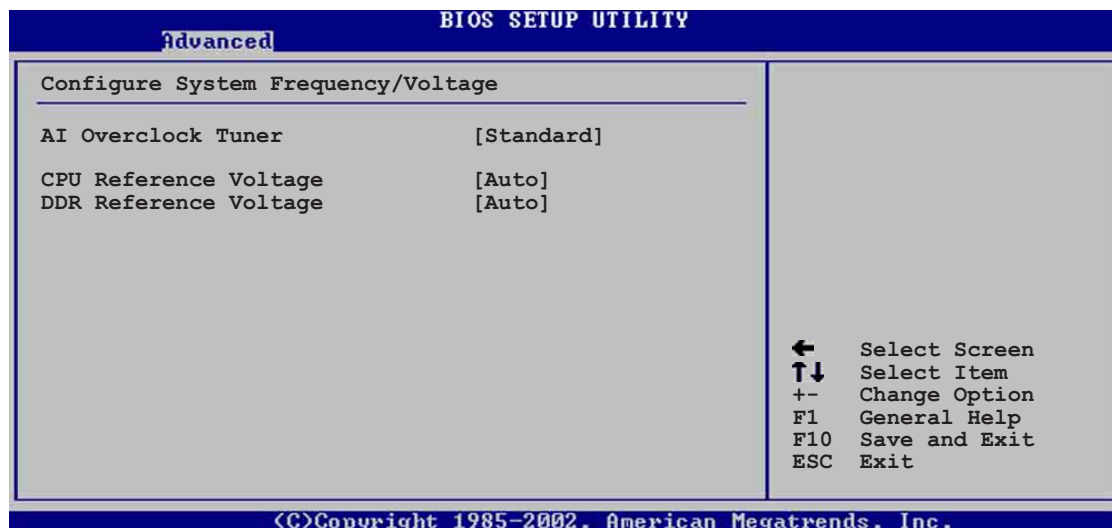

#### AI Overclock Tuner [Standard]

Allows selection of CPU overclocking options to achieve desired CPU internal frequency. Select either one of the preset overclocking options. Configuration options: [Manual] [Standard] [Overclock 5%] [Overclock 10%] [Overclock 20%] [Overclock 30%]



Selecting a very high CPU frequency may cause the system to become unstable! If this happens, revert to the default setting.





If you are using an unlocked CPU, the item **CPU Ratio** appears under the AI Overclock Tuner item. You may select your desired ratio from the available options.

### **CPU External Frequency (MHz) [XXX] (value is auto-detected)**

When the AI Overclocking item is set to [Manual] this item appears and indicates the frequency sent by the clock generator to the system bus and PCI bus. The bus frequency (external frequency) multiplied by the bus multiple equals the CPU speed. The value of this item is auto-detected by BIOS and is not manually configurable. The values range from 100 to 400. Press the “+” or “-” to adjust the CPU frequency.

### **CPU Reference Voltage [Auto]**

Allows selection of the Central Processing Unit (CPU) operating voltage. Configuration options: [Auto] [Over Voltage]

### **DDR Reference Voltage [Auto]**

Allows selection of the DDR SDRAM operating voltage. Configuration options: [Auto] [2.6V] [2.7V]

## **2.4.2 USB Configuration**

The items in this menu allows you to change the USB-related features. Select an item then press Enter to display the configuration options.

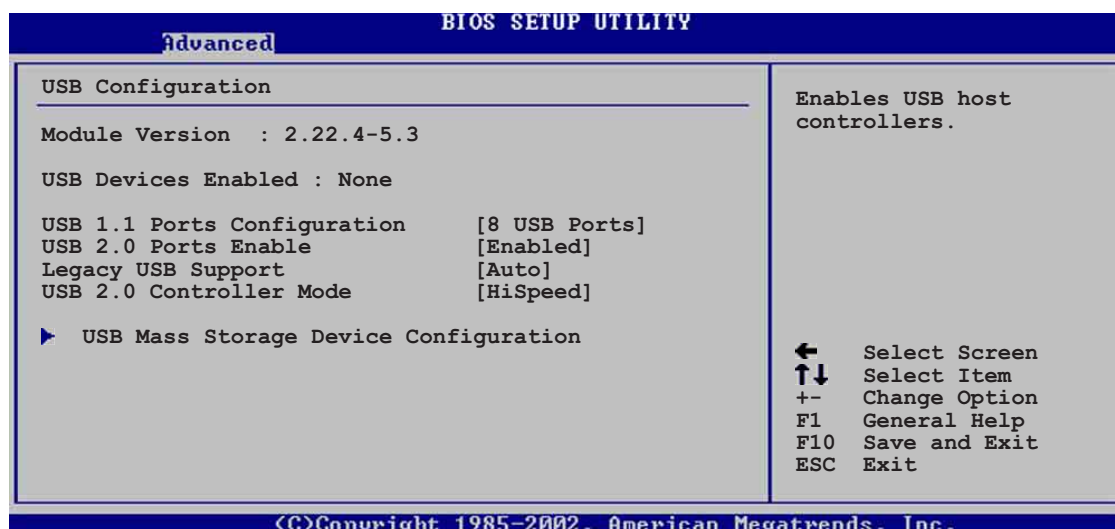

The Module Version and USB Devices Enabled items show the auto-detected values. If no USB device is detected, the item shows None.

### **USB 1.1 Ports Configuration [8 USB Ports]**

Allows you to set the number of USB ports to activate. Configuration options: [Disabled] [2 USB Ports] [4 USB Ports] [6 USB Ports] [8 USB Ports]

## USB 2.0 Ports Enabled [Enabled]

Allows you to enable or disable the USB 2.0 ports.

Configuration options: [Enabled] [Disabled]

## Legacy USB Support [Auto]

Allows you to enable or disable support for legacy USB devices. Setting to Auto allows the system to detect the presence of USB devices at startup. If detected, the USB controller legacy mode is enabled. If no USB device is detected, the legacy USB support is disabled. Configuration options: [Disabled] [Enabled] [Auto]

## USB 2.0 Controller Mode [HiSpeed]

This item allows you to configure the USB 2.0 controller mode. When set to [Hi-Speed] the USB 2.0 controller transfers data at 480 Mbps. Set to [Full-Speed] for 12Mbps of transfer speed. Configuration options: [Hi-Speed] [Full-Speed]

## USB Mass Storage Device Configuration

USB Mass Storage Device Configuration	
USB Mass Storage Reset Delay	[20 Sec]
No USB Mass Storage device detected	
Device #1	N/A
Emulation Type	[N/A]
Device #2	N/A
Emulation Type	[N/A]
Device #3	N/A
Emulation Type	[N/A]
Device #4	N/A
Emulation Type	[N/A]
Device #5	N/A
Emulation Type	[N/A]
Device #6	N/A
Emulation Type	[N/A]

Number of seconds POST waits for the USB mass storage device after that start unit command.

← Select Screen  
↑↓ Select Item  
+- Change Option  
F1 General Help  
F10 Save and Exit  
ESC Exit

(C)Copyright 1985-2002, American Megatrends, Inc.

### USB Mass Storage Reset Delay [20 Sec]

Allows you to select the number of seconds POST waits for the USB mass storage device after the start unit command. The message “No USB mass storage device detected” appears if none is installed in the system.

Configuration options: [10 Sec] [20 Sec] [30 Sec] [40 Sec]



The Device items appear only when there are installed USB devices.

### Emulation Type [N/A]

When set to Auto, USB devices less than 530MB will be emulated as floppy drive, and the remaining drives as hard drives. Forced FDD option can be used to force an HDD formatted drive to boot as FDD (for example, ZIP drive).

## 2.4.3 CPU Configuration

The items in this menu show the CPU-related information auto-detected by BIOS.

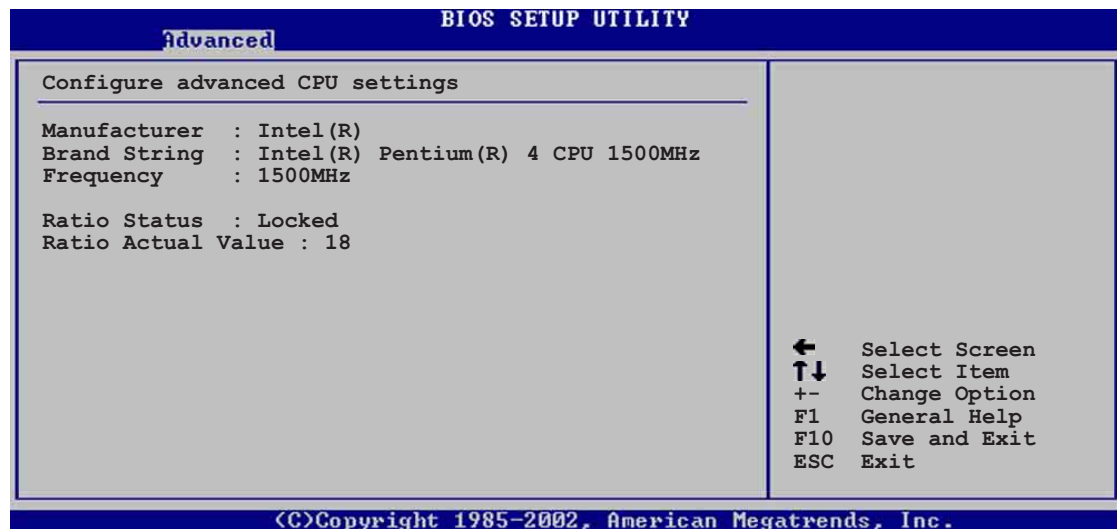

## 2.4.4 Chipset

The Chipset menu items allow you to change the advanced chipset settings. Select an item then press Enter to display the sub-menu.

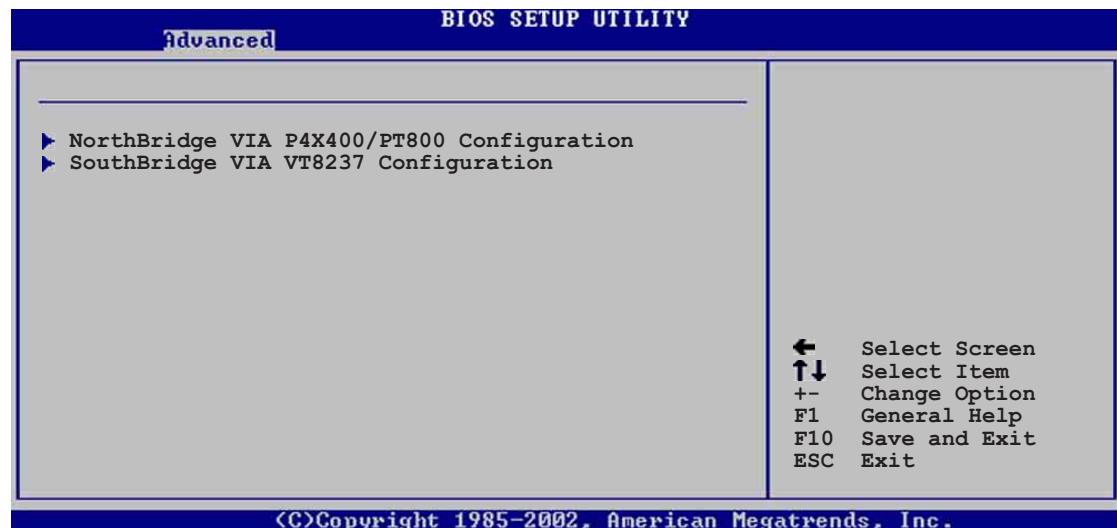

## NorthBridge VIA P4X400/PT800 Configuration

BIOS SETUP UTILITY	
Advanced	
***** DRAM Timing *****	
Configure SDRAM Timing by SPD	[Enabled]
SDRAM Frequency	[Auto]
SDRAM Burst Length	[4QW]
SDRAM Command Rate	[2T]
Primary Graphics Adapter	[AGP]
V-Link 8X Supported	[Enabled]
AGP Mode	Auto
Graphics Aperture Size	[64MB]
	← Select Screen
	↑↓ Select Item
	+ - Change Option
	F1 General Help
	F10 Save and Exit
	ESC Exit

©Copyright 1985-2002, American Megatrends, Inc.

### Configure DRAM Timing by SPD [Enabled]

When this item is enabled, the DRAM timing parameters are set according to the DRAM SPD (Serial Presence Detect). When disabled, you can manually set the DRAM timing parameters through the DRAM sub-items. Configuration options: [Disabled] [Enabled]



The following sub-items appear when the item **Configure DRAM Timing by SPD** is set to Disabled.

#### SDRAM Frequency [Auto]

Allows you to set the SDRAM operating frequency.  
Configuration options: [266Mhz] [333Mhz] [400Mhz] [Auto]

#### DRAM CAS# Latency [2.5]

This item controls the latency between the SDRAM read command and the time the data actually becomes available. Configuration options: [1.0 Clocks] [2.0 Clocks] [2.5 Clocks] [3.0 Clocks]

#### SDRAM Bank Interleave [Disabled]

This item controls the latency between the SDRAM read command and the time the data actually becomes available.  
Configuration options: [Disabled] [2-Way] [4-Way]

### SDRAM Burst Length [4QW]

Configuration options: [8QW] [4QW]

### SDRAM Command Rate [2T]

Configuration options: [2T] [1T]

## Primary Graphics Adapter [AGP]

Configuration options: [PCI] [AGP]

## V-Link 8X Supported [Enabled]

This item sets the bus link between the NorthBridge and SouthBridge.

Configuration options: [Disabled] [Enabled]

## AGP Mode

Displays the AGP mode setting.

## Graphics Aperture Size [64MB]

Allows you to select the size of mapped memory for AGP graphic data.

Configuration options: [256MB] [128MB] [64MB] [32MB] [16MB] [8MB] [4MB]

## SouthBridge VIA VT8237 Configuration

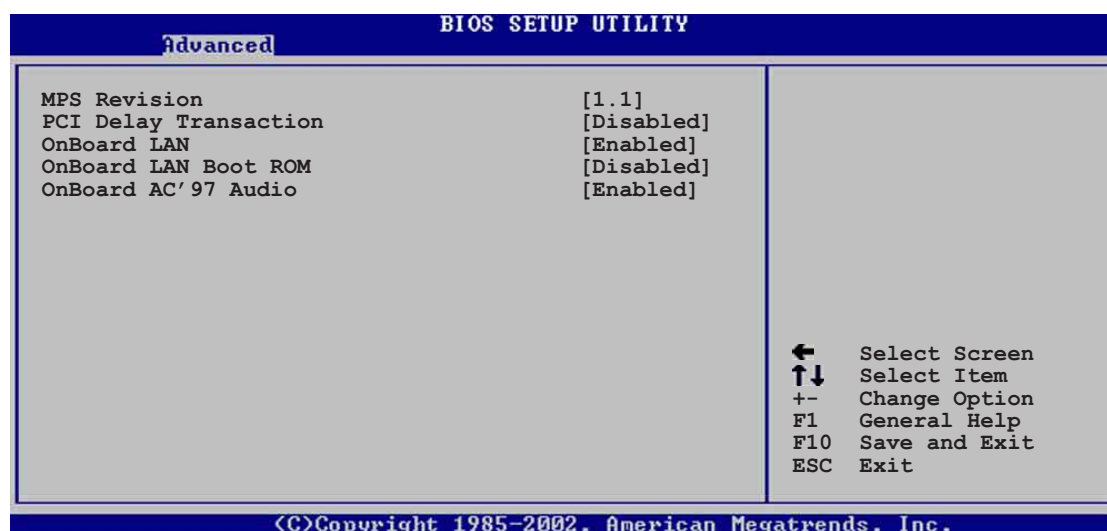

## MPS Revision [1.1]

Configuration options: [1.1] [1.4]

## PCI Delay Transaction [Enabled]

This item enables or disables the PCI Delay Transaction feature.

Configuration options: [Disabled] [Enabled]

## OnBoard LAN [Enabled]

This item enables or disables the onboard LAN controller.

Configuration options: [Disabled] [Enabled]

## OnBoard LAN Boot ROM [Disabled]

This item enables or disables the onboard LAN Boot ROM.

Configuration options: [Disabled] [Enabled]

## OnBoard AC'97 Audio [Auto]

This item disables or set to auto-detect the onboard AC'97 audio CODEC.

Configuration options: [Disabled] [Auto]

## 2.4.5 Onboard Devices Configuration

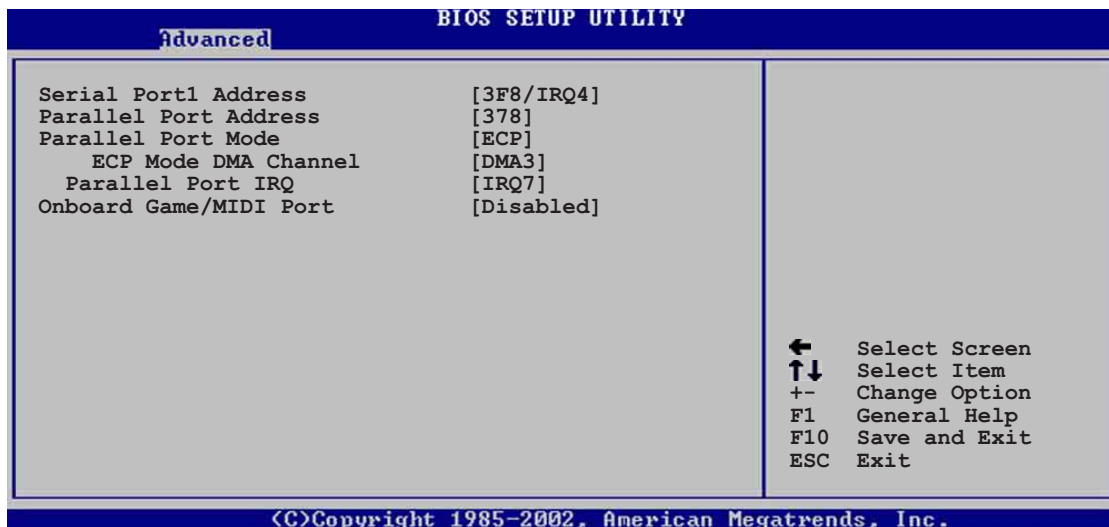

### Serial Port1 Address [3F8/IRQ4]

Allows you to select the Serial Port1 base address. Configuration options: [Disabled] [3F8/IRQ4] [2F8/IRQ3] [3E8/IRQ4] [2E8/IRQ3]

### Parallel Port Address [378]

Allows you to select the Parallel Port base addresses. Configuration options: [Disabled] [378] [278] [3BC]

### Parallel Port Mode [ECP]

Allows you to select the Parallel Port mode.  
Configuration options: [Normal] [Bi-directional] [EPP] [ECP]

#### *ECP Mode DMA Channel [DMA3]*

Allows selection of the Parallel Port ECP DMA channel. This item appears only when the **Parallel Port Mode** is set to **ECP**. Configuration options: [DMA0] [DMA1] [DMA3]

#### *Parallel Port IRQ [IRQ7]*

Allows you to select the Parallel Port IRQ. Configuration options: [IRQ5] [IRQ7]

#### *EPP Version [1.9]*

This item appears only when the Parallel Port Mode is set to [EPP]. It allows you to select the Parallel Port EPP version.  
Configuration options: [1.9] [1.7]

### OnBoard Game/MIDI Port [Disabled]

This item enable or disables the onboard Game/MIDI port.  
Configuration options: [Disabled] [200/300] [200/330] [208/300] [208/330]

## 2.4.6 PCI PnP

The PCI PnP menu items allow you to change the advanced settings for PCI/PnP devices. The menu includes setting IRQ and DMA channel resources for either PCI/PnP or legacy ISA devices, and setting the memory size block for legacy ISA devices.



Take caution when changing the settings of the PCI PnP menu items. Incorrect field values may cause the system to malfunction.

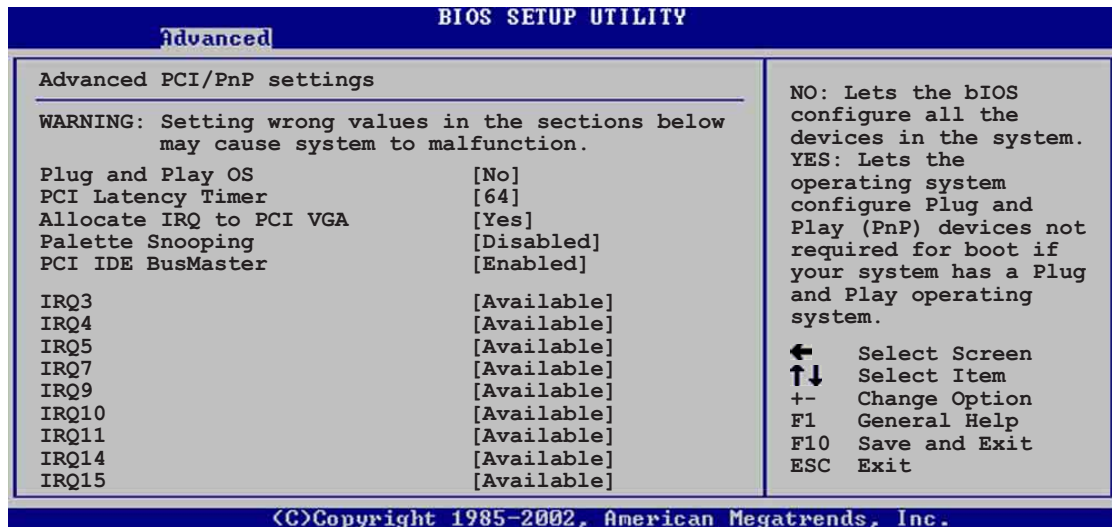

### Plug and Play O/S [No]

When set to [No], BIOS configures all the devices in the system. When set to [Yes] and if you installed a Plug & Play operating system, the operating system configures the Plug & Play devices not required for boot. Configuration options: [No] [Yes]

### PCI Latency Timer [64]

Allows you to select the value in units of PCI clocks for the PCI device latency timer register. Configuration options: [32] [64] [96] [128] [160] [192] [224] [248]

### Allocate IRQ to PCI VGA [Yes]

When set to [Yes], BIOS assigns an IRQ to PCI VGA card if the card requests for an IRQ. When set to [No], BIOS does not assign an IRQ to the PCI VGA card even if requested. Configuration options: [Yes] [No]

### Palette Snooping [Disabled]

When set to [Enabled], the palette snooping feature informs the PCI devices that an ISA graphics device is installed in the system so that the latter can function correctly. Setting to [Disabled] deactivates this feature. Configuration options: [Disabled] [Enabled]

## PCI IDE BusMaster [Enabled]

Allows BIOS to use PCI bus mastering when reading/writing to IDE devices.  
Configuration options: [Disabled] [Enabled]

## IRQ xx [Available]

When set to [Available], the specific IRQ is free for use of PCI/PnP devices. When set to [Reserved], the IRQ is reserved for legacy ISA devices. Configuration options: [Available] [Reserved]

# 2.5 Power menu

The Power menu items allow you to change the settings for the Advanced Power Management (APM). Select an item then press Enter to display the configuration options.

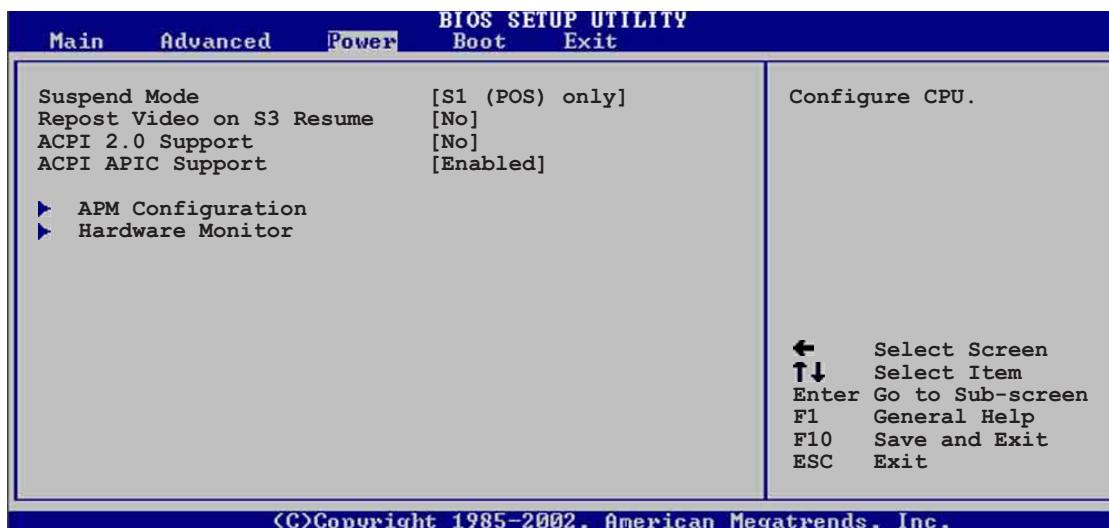

### 2.5.1 Suspend Mode [S1 (POS) only]

Allows you to select the ACPI state to be used for system suspend.  
Configuration options: [S1 (POS) Only] [S3 Only] [S1 (POS) & S3 (STR) Auto]

### 2.5.2 Repost Video on S3 Resume [No]

Allows you to set whether to repost video after an S3 resume event.  
Configuration options: [No] [Yes]

### 2.5.3 ACPI 2.0 Support [No]

Allows you to add more tables for ACPI 2.0 specifications.  
Configuration options: [No] [Yes]



## 2.5.4 ACPI APIC Support [Enabled]

Allows you to enable or disable the ACPI support in the ASIC. When set to Enabled, the ACPI APIC table pointer is included in the RSDT pointer list.  
Configuration options: [Disabled] [Enabled]

## 2.5.4 APM Configuration

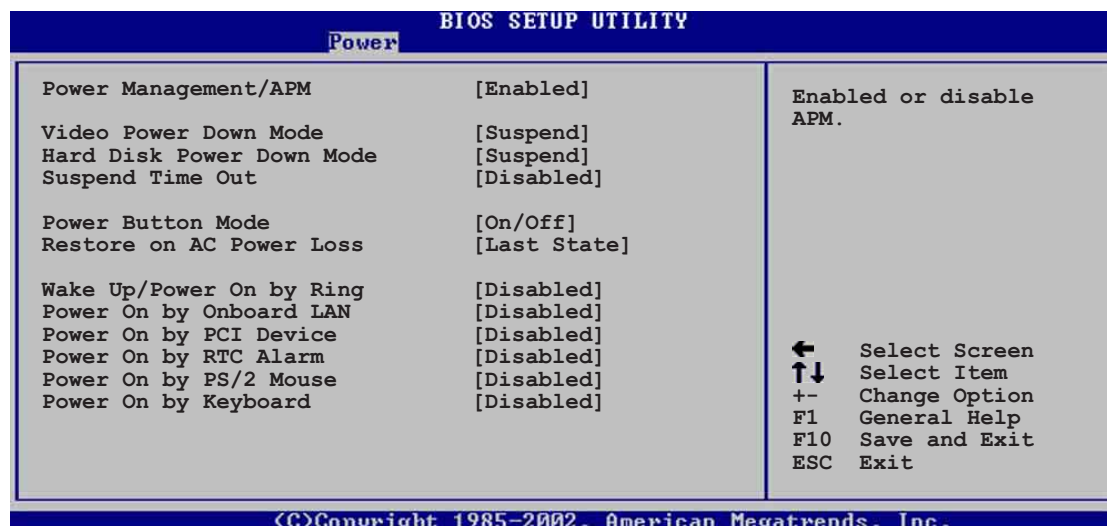

### Power Management/APM [Enabled]

Allows you to enable or disable the Advanced Power Management (APM) feature.  
Configuration options: [Disabled] [Enabled]



The following items appears only if the Power Management/APM item is set to [Enabled]

### Video Power Down Mode [Suspend]

Allows you to select the video power down mode.  
Configuration options: [Disabled] [Suspend]

### Hard Disk Power Down Mode [Suspend]

Allows you to set the hard disk power down mode.  
Configuration options: [Disabled] [Suspend]

### Suspend Time Out [Disabled]

Allows you to select the specified time at which the system goes on suspend.  
Configuration options: [Disabled] [1 Min] [2 Min] [4 Min] [8 Min] [10 Min] [20 Min] [30 Min] [40 Min] [50 Min] [60 Min]

### Power Button Mode [On/Off]

Allows the system to go into On/Off mode or suspend mode when the power button is pressed. Configuration options: [On/Off] [Suspend]

## **Restore on AC Power Loss [Power Off]**

This item sets the system status after restore on AC power loss.

Configuration options: [Power Off] [Power On] [Last State]

## **Wake Up/Power On by Ring [Disabled]**

This allows either settings of [Enabled] or [Disabled] for powering up the computer when the external modem receives a call while the computer is in Soft-off mode.

Configuration options: [Disabled] [Enabled]



---

The computer cannot receive or transmit data until the computer and applications are fully running. Thus, connection cannot be made on the first try. Turning an external modem off and then back on while the computer is off causes an initialization string that turns the system power on.

---

## **Power On by Onboard LAN [Disabled]**

Allows you to enable or disable the onboard LAN to generate PME in SoftOFF mode. Configuration options: [Disabled] [Enabled]

## **Power On by PCI Device [Disabled]**

When set to [Enabled], this parameter allows you to turn on the system through a PCI LAN or modem card. This feature requires an ATX power supply that provides at least 1A on the +5VSB lead. Configuration options: [Disabled] [Enabled]

## **Power On by RTC Alarm [Disabled]**

Allows you to enable or disable RTC to generate a wake event. When this item is set to Enabled, the items RTC Alarm Date, RTC Alarm Hour, RTC Alarm Minute, and RTC Alarm Second appear with set values.

Configuration options: [Disabled] [Enabled]

## **Power On by PS/2 Mouse [Disabled]**

When set to [Enabled], this parameter allows you to use the PS/2 mouse to resume the system. This feature requires an ATX power supply that provides at least 1A on the +5VSB lead. Configuration options: [Disabled] [Enabled]

## **Power On by PS/2 Keyboard [Disabled]**

This parameter allows you to use specific keys on the keyboard to turn on the system. When set to [S5], the item Wake-up Key is enabled. This feature requires an ATX power supply that provides at least 1A on the +5VSB lead.

Configuration options: [Disabled] [S5]

## 2.5.5 Hardware Monitor

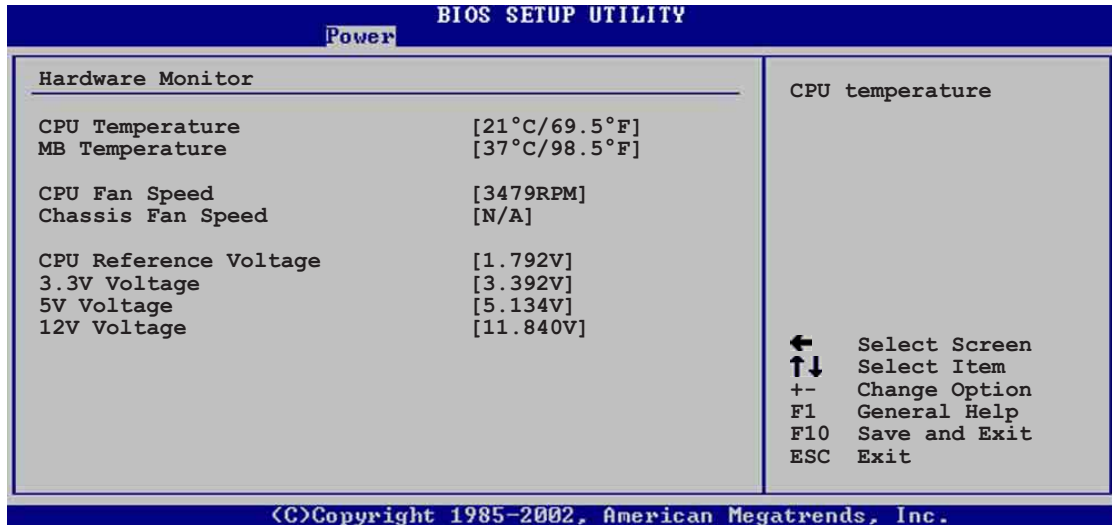

### MB Temperature [xxxC/xxxF]

### CPU Temperature [xxxC/xxxF]

The onboard hardware monitor automatically detects and displays the motherboard and CPU temperatures.

### CPU Fan Speed [xxxxRPM] or [N/A]

### Chassis Fan Speed [xxxxRPM] or [N/A]

The onboard hardware monitor automatically detects and displays the CPU and chassis fan speeds in rotations per minute (RPM). If any of the fans is not connected to the motherboard, the specific field shows N/A.

### CPU Reference Voltage, +3.3V Voltage, +5V Voltage, +12V Voltage

The onboard hardware monitor automatically detects the voltage output through the onboard voltage regulators.



If any of the monitored items is out of range, the following error message appears: "Hardware Monitor found an error. Enter Power setup menu for details". You will then be prompted to "Press F1 to continue or DEL to enter SETUP".

## 2.6 Boot menu

The Boot menu items allow you to change the system boot options. Select an item then press Enter to display the sub-menu.

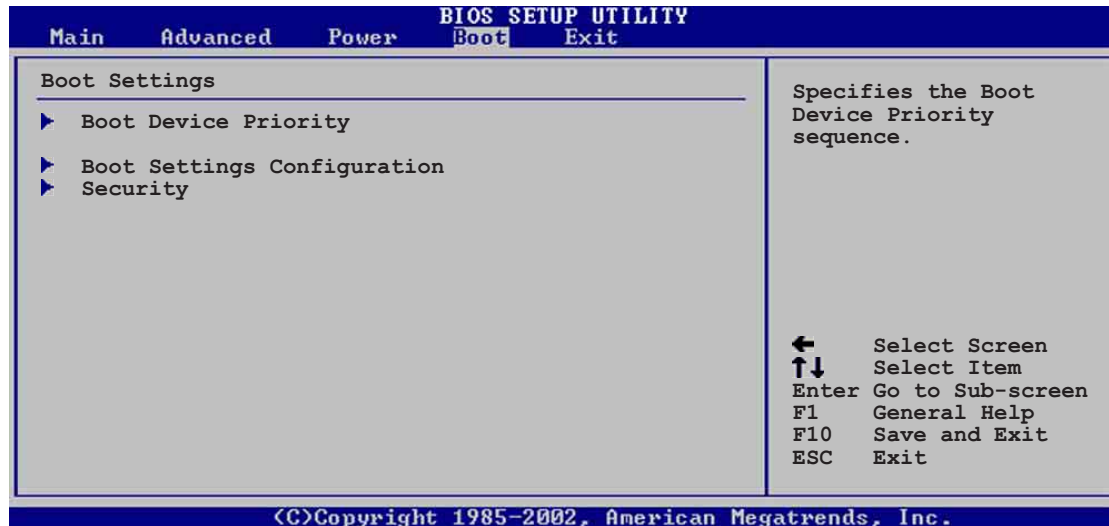

### 2.6.1 Boot Device Priority

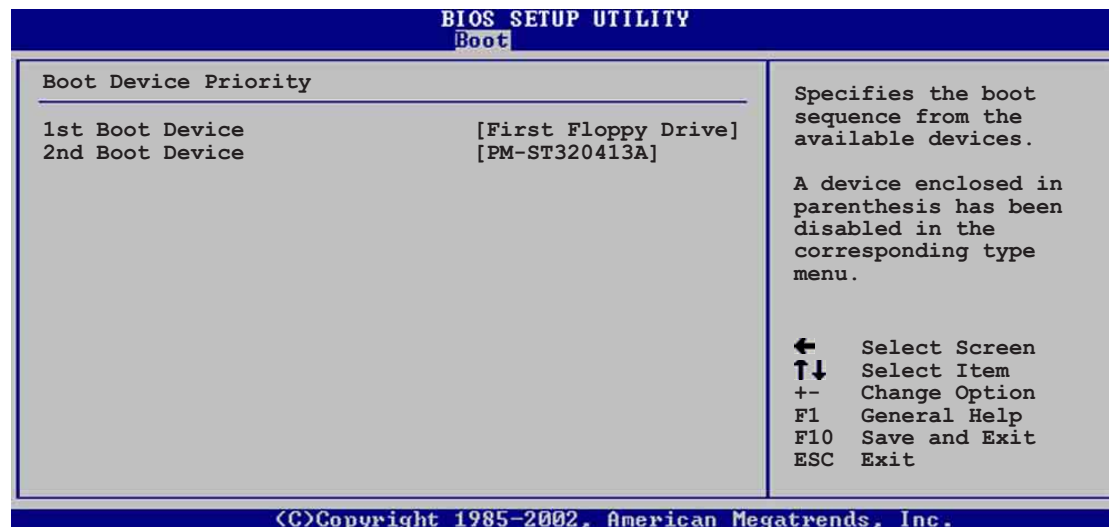

#### 1st ~ xxth Boot Device [1st Floppy Drive]

These items specify the boot device priority sequence from the available devices. The number of device items that appear on the screen depends on the the number of devices installed in the system. Configuration options: [xxxxx Drive] [Disabled]

## 2.6.2 Boot Settings Configuration

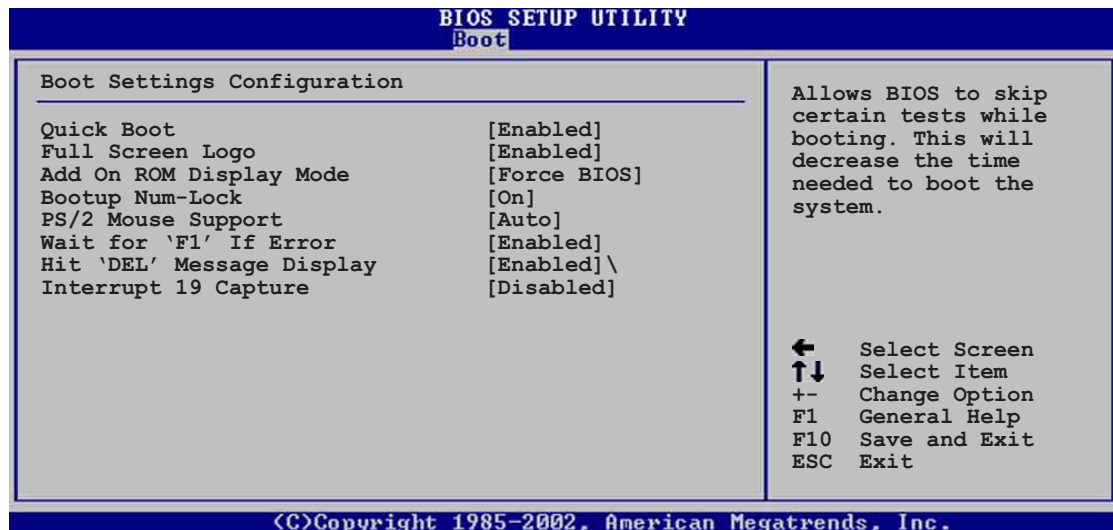

### Quick Boot [Enabled]

Enabling this item allows BIOS to skip some power on self tests (POST) while booting to decrease the time needed to boot the system. When set to [Disabled], BIOS performs all the POST items. Configuration options: [Disabled] [Enabled]

### Full Screen Logo [Enabled]

Setting to [Disabled] displays the normal POST messages. Setting to [Enabled] displays the OEM logo instead of the POST messages. Configuration options: [Disabled] [Enabled]

### Add On ROM Display Mode [Force BIOS]

Sets the display mode for option ROM. Configuration options: [Force BIOS] [Keep Current]

### Bootup Num-Lock [On]

Allows you to select the power-on state for the NumLock. Configuration options: [Off] [On]

### PS/2 Mouse Support [Auto]

Allows you to enable or disable support for PS/2 mouse. Configuration options: [Disabled] [Enabled] [Auto]

### Wait for 'F1' If Error [Enabled]

When set to Enabled, the system waits for F1 key to be pressed when error occurs. Configuration options: [Disabled] [Enabled]

### Hit 'DEL' Message Display [Enabled]

When set to Enabled, the system displays the message "Press DEL to run Setup" during POST. Configuration options: [Disabled] [Enabled]

## Interrupt 19 Capture [Disabled]

When set to Enabled, the system allows option ROMs to trap interrupt 19. This is required by some PCI cards that provide a ROM based setup utility.

Configuration options: [Disabled] [Enabled]

## 2.6.3 Security

The Security menu items allow you to change the system security settings. Select an item then press Enter to display the configuration options.

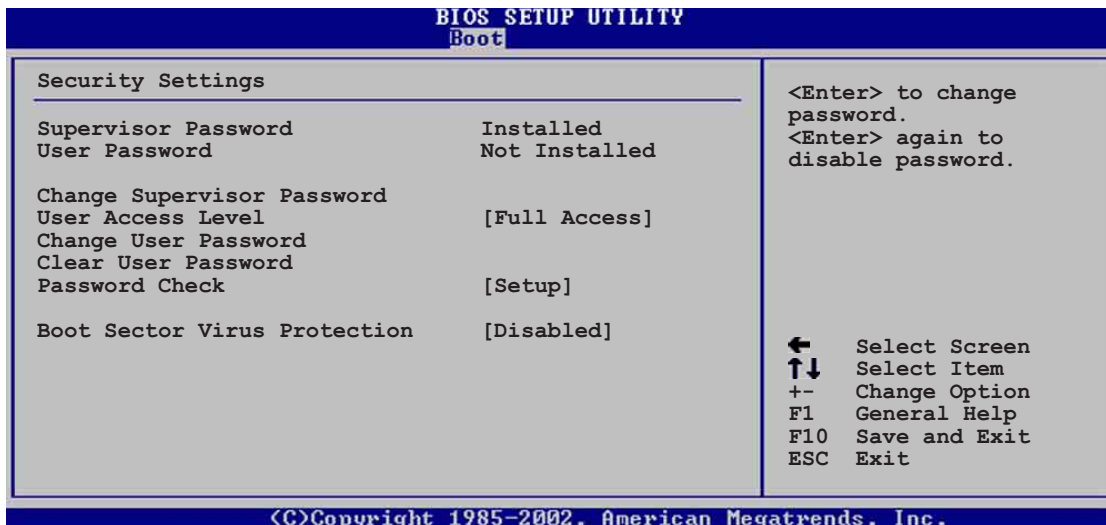

### Set a Supervisor Password

Select this item to set or change the supervisor password. The Supervisor Password item on top of the screen shows the default **Not Installed**. After you have set a password, this item shows **Installed**.

To set a Supervisor Password:

1. Select the Change Supervisor Password item and press Enter.
2. On the password box that appears, type a password composed of letters and/or numbers, then press Enter. Your password should have at least six characters.
3. Confirm the password when prompted.  
The message "**Password Installed**" appears after you have successfully set your password.

The Supervisor Password item now shows **Installed**.

### Change the Supervisor Password

To change the supervisor password, follow the same steps as in setting a user password.

To clear the supervisor password, select the Change Supervisor Password then press Enter. The message "**Password Uninstalled**" appears.

After you have set a supervisor password, the other items appear to allow you to change other security settings.

### **User Access Level (Full Access)**

This item allows you to select the access restriction to the Setup items.  
Configuration options: [No Access] [View Only] [Limited] [Full Access]

**No Access** prevents user access to the Setup utility.

**View Only** allows access but does not allow change to any field.

**Limited** allows change to only selected fields, such as Date and Time.

**Full Access** allows viewing and changing all the fields in the Setup utility.

### **Change User Password**

Select this item to set or change the user password. The User Password item on top of the screen shows the default **Not Installed**. After you have set a password, this item shows **Installed**.

To set a User Password:

1. Select the Change User Password item and press Enter.
2. On the password box that appears, type a password composed of letters and/or numbers, then press Enter. Your password should have at least six characters.
3. Confirm the password when prompted.  
The message "Password Installed" appears after you have successfully set your password.

The User Password item now shows **Installed**.

To change the user password, follow the same steps as in setting a user password.

### **Clear User Password**

Select this item if you wish to clear the user password. In case you forgot the password, use the **Clear RTC RAM** jumper to clear the CMOS. See page 1-16 for details.



---

Take caution when clearing the CMOS to clear password, the value of the other CMOS parameters are also erased.

---

### **Password Check [Setup]**

When set to [Setup], BIOS checks for user password when accessing the Setup utility. When set to [Always], BIOS checks for user password both when accessing Setup and booting the system. Configuration options: [Setup] [Always]

### **Boot Sector Virus Protection [Disabled]**

Allows you to enable or disable the boot sector virus protection. Configuration options: [Disabled] [Enabled]

## 2.7 Exit menu

The Exit menu items allow you to load the optimal or failsafe default values for the BIOS items, and save or discard your changes to the BIOS items.

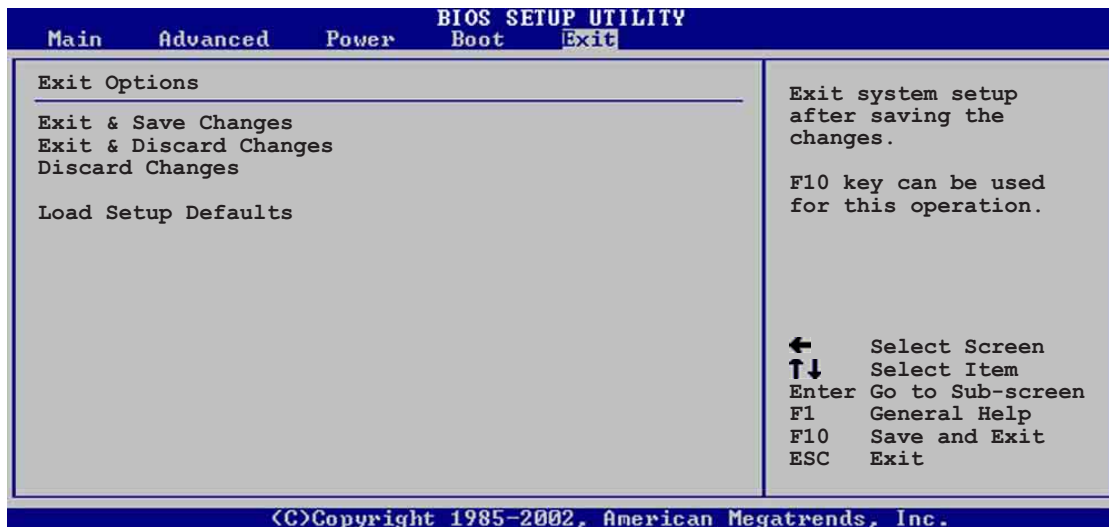

Pressing <Esc> does not immediately exit this menu. Select one of the options from this menu or <F10> from the legend bar to exit.

### Exit & Save Changes

Once you are finished making your selections, choose this option from the Exit menu to ensure the values you selected are saved to the CMOS RAM. The CMOS RAM is sustained by an onboard backup battery and stays on even when the PC is turned off. When you select this option, a confirmation window appears. Select [Yes] to save changes and exit.



If you attempt to exit the Setup program without saving your changes, the program prompts you with a message asking if you want to save your changes before exiting. Pressing <Enter> saves the changes while exiting.

### Exit & Discard Changes

Select this option only if you do not want to save the changes that you made to the Setup program. If you made changes to fields other than system date, system time, and password, the BIOS asks for a confirmation before exiting.

### Discard Changes

This option allows you to discard the selections you made and restore the previously saved values. After selecting this option, a confirmation appears. Select [Yes] to discard any changes and load the previously saved values.

### Load Setup Defaults

This option allows you to load the default values for each of the parameters on the Setup menus. When you select this option or if you press <F5>, a confirmation window appears. Select [Yes] to load default values. Select Exit Saving Changes or make other changes before saving the values to the non-volatile RAM.



# *Chapter 3*

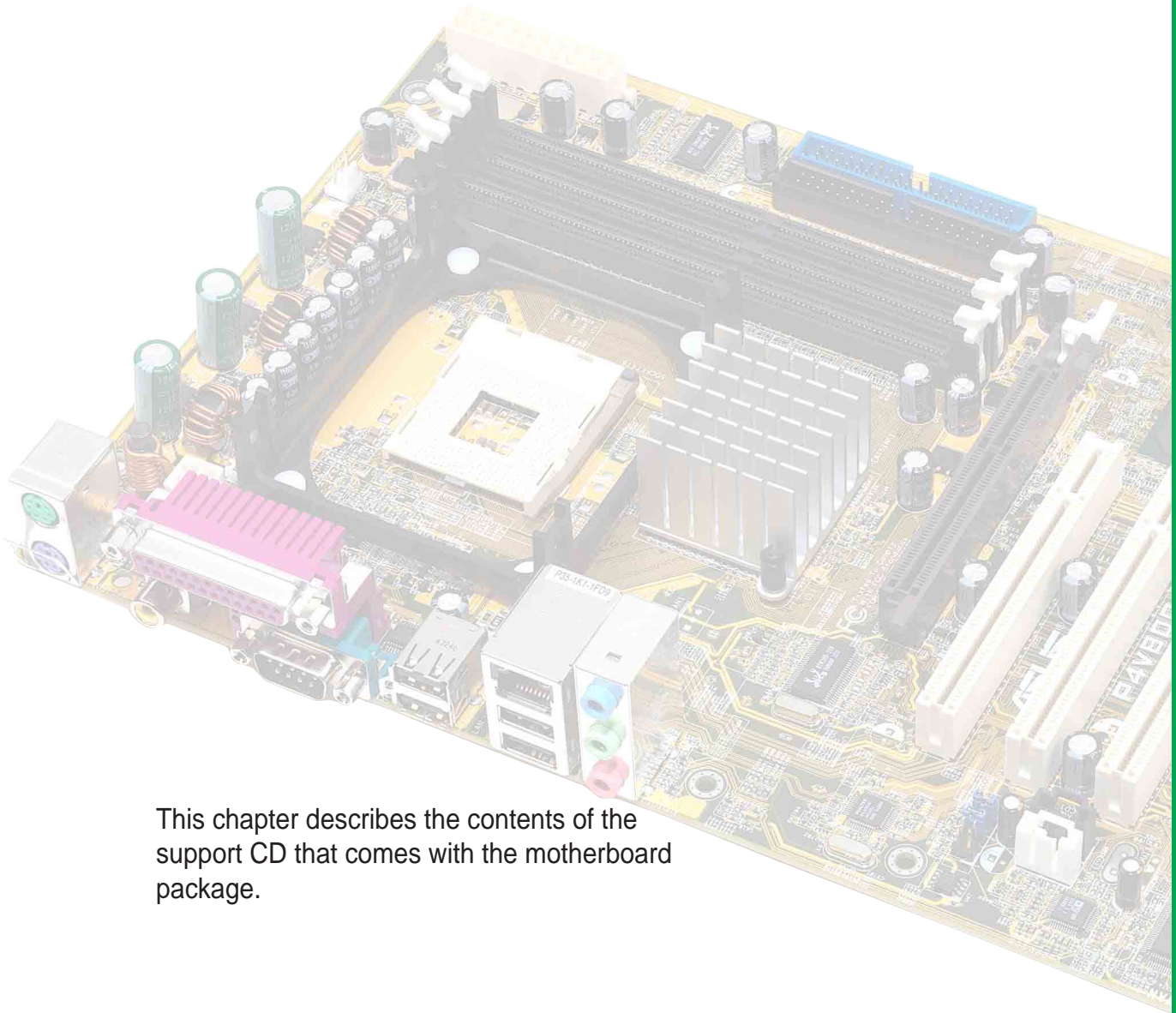

This chapter describes the contents of the support CD that comes with the motherboard package.

## **Software support**

## 3.1 Install an operating system

This motherboard supports Windows 98SE/ME/2000/XP operating system (OS). Always install the latest OS version and corresponding updates so you can maximize the features of your hardware.



Because motherboard settings and hardware options vary, use the setup procedures presented in this chapter for general reference only. Refer to your OS documentation for more information.

## 3.2 Support CD information

The support CD that came with the motherboard contains useful software and several utility drivers that enhance the motherboard features.



The contents of the support CD are subject to change at any time without notice. Visit the ASUS website for updates.

### 3.2.1 Running the support CD

To begin using the support CD, simply insert the CD into your CD-ROM drive. The CD automatically displays the **Drivers** menu if Autorun is enabled in your computer.

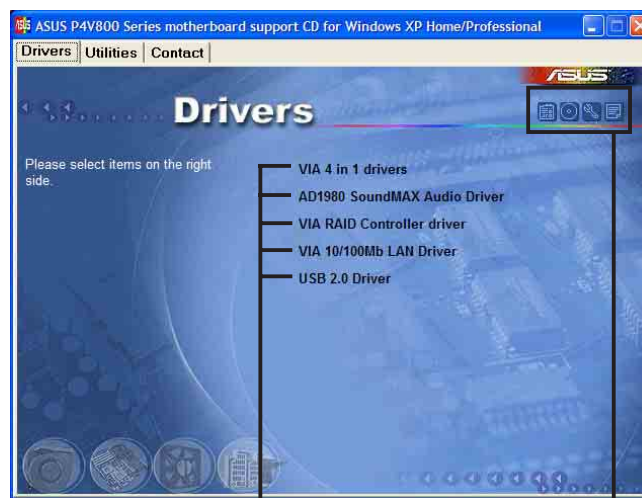

Click an item to install

Click an icon to display more information



If **Autorun** is NOT enabled in your computer, browse the contents of the support CD to locate the file **ASSETUP.EXE** from the **BIN** folder. Double-click the **ASSETUP.EXE** to run the CD.

## 3.2.2 Drivers menu

The drivers menu shows the available device drivers if the system detects installed devices. Install the necessary drivers to activate the devices.

### VIA 4 in 1 drivers

This item installs the following drivers:

- VIA Registry (INF) driver
- VIA AGP VxD driver
- VIA ATAPI vendor support driver
- VIA PCI IRQ Miniport driver

### AD1980 SoundMAX Audio Driver

This item installs the ADI 1980 AC'97 compliant audio controller and application.

### VIA RAID Controller driver

This item installs the VIA RAID controller driver and application to configure and manage disk drives.

### VIA 10/100Mb LAN Driver

This item installs the VIA 10/100Mbps Fast Ethernet driver to support 10/100 Mbps networking.

### USB 2.0 Driver

This item installs the USB 2.0 driver.



---

For Windows XP users, make sure to install WinXP Service Pack 1 to support USB 2.0.

---

## 3.2.3 Utilities menu

The Utilities menu shows the applications and other software that the motherboard supports.

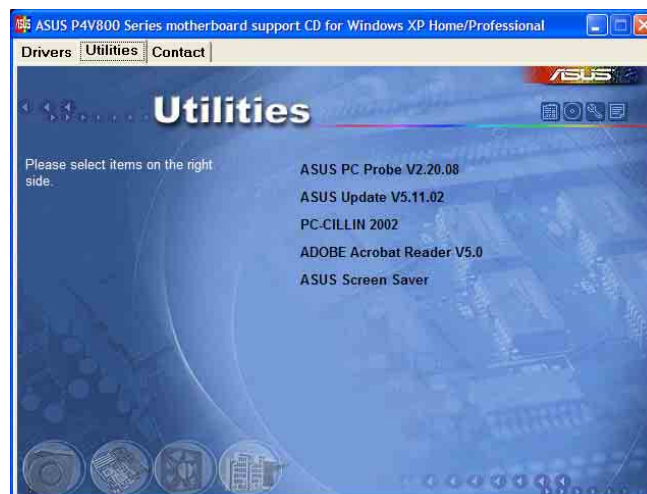

## ASUS PC Probe

This smart utility monitors the fan speed, CPU temperature, and system voltages, and alerts you on any detected problems. This utility helps you keep your computer at a healthy operating condition.

## Install ASUS Update

This program allows you to download the latest version of the BIOS from the ASUS website. Before using the ASUS Update, make sure that you have an Internet connection so you can connect to the ASUS website. Installing ASUS Update also installs ASUS Mylogo2™.

## PC-CILLIN 2002

This item installs the PC-cillin 2002 anti-virus program. View the PC-cillin online help for detailed information.

## Adobe Acrobat Reader

This item installs the Adobe Acrobat Reader V5.0. The Acrobat Reader software is for viewing files saved in Portable Document Format (PDF).

## ASUS Screen Saver

This item installs the ASUS screen saver.

## 3.2.4 ASUS Contact Information

Clicking the ASUS Contact Information tab displays as stated. You may also find this information on page viii of this user guide.



## 3.3 RAID 0 / RAID 1 configurations

The motherboard includes a high performance IDE RAID controller integrated in the VIA® VT8237 southbridge chipset. It supports RAID 0, RAID 1 and JBOD with two independent Serial ATA channels.

**RAID 0** (called *data striping*) optimizes two identical hard disk drives to read and write data in parallel, interleaved stacks. Two hard disks perform the same work as a single drive but at a sustained data transfer rate, double that of a single disk alone, thus improving data access and storage.

**RAID 1** (called *data mirroring*) copies and maintains an identical image of data from one drive to a second drive. If one drive fails, the disk array management software directs all applications to the surviving drive as it contains a complete copy of the data in the other drive. This RAID configuration provides data protection and increases fault tolerance to the entire system.

### 3.3.1 Install the Serial ATA (SATA) hard disks

The VIA® VT8237 southbridge chipset supports Serial ATA hard disk drives. For optimal performance, install identical drives of the same model and capacity when creating a RAID set.

- If you are creating a **RAID 0 (striping)** array for performance, use two new drives.
- If you are creating a **RAID 1 (mirroring)** array for protection, you can use two new drives or use an existing drive and a new drive (the new drive must be of the same size or larger than the existing drive). If you use two drives of different sizes, the smaller capacity hard disk will be the base storage size. For example, one hard disk has an 80GB storage capacity and the other hard disk has 60GB storage capacity, the maximum storage capacity for the RAID 1 set is 60GB.

Follow these steps to install the SATA hard disks for RAID configuration.



- 
- Before setting up your new RAID array, verify the status of your hard disks. Make sure the Master/Slave jumpers are configured properly.
  - Both the data and power SATA cables are new cables. You cannot use older 40-pin 80-conductor IDE or regular IDE power cables with Serial ATA drives. Installing Serial ATA (SATA) hard disks require the use of new Serial ATA cable (4-conductor) which supports the Serial ATA protocol and a Serial ATA power cable.
  - Either end of the Serial ATA data cable can be connected to the SATA hard disk or the SATA connector on the motherboard.
-

1. Install the Serial ATA hard disks into the drive bays.
2. Connect one end of the Serial ATA cable to the motherboard's primary Serial ATA connector (SATA1).
3. Connect the other end of Serial ATA cable to the master Serial ATA hard disk.
4. Connect one end of the second Serial ATA cable to the motherboard's secondary Serial ATA connector (SATA2).
5. Connect the other end of Serial ATA cable to the secondary Serial ATA hard disk.
6. Connect the Serial ATA power cable to the power connector on each drive.
7. Proceed to section 5.4.2 "Entering VIA® Tech RAID BIOS Utility" for the next procedure.

### 3.3.2 Entering VIA® Tech RAID BIOS Utility

1. Boot-up your computer.
2. During POST, press **<Tab>** to enter VIA RAID configuration utility. The following menu options will appear.



The RAID BIOS information on the setup screen shown is for reference only. What you see on your screen may not be exactly the same as shown.

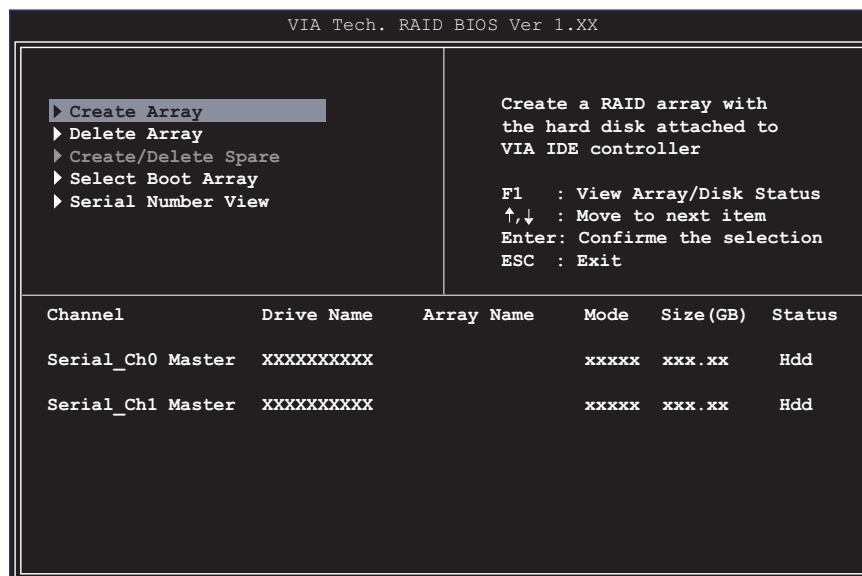

On the upper-right side of the screen is the message and legend box. The keys on the legend box allows you to navigate through the setup menu options. The message describes the function of each menu item. The following lists the keys found in the legend box with their corresponding functions.

- F1 : View Array/Disk Status
- ↑, ↓ : Move to the next item
- Enter : Confirm the selection
- ESC : Exit

### 3.3.3 Create Array

1. In the VIA RAID BIOS utility main menu, select **Create Array** then press the <Enter> key. The main menu items on the upper-left corner of the screen are replaced with create array menu options.

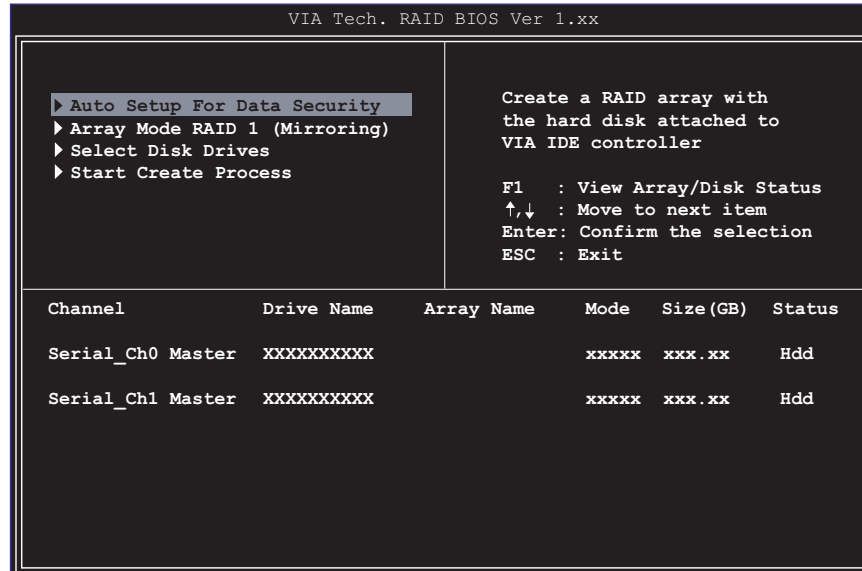

#### 3.3.3.1 RAID 0 for performance

1. Select the second option **Array Mode**, then press the <Enter> key to display the RAID system setting pop-up menu.

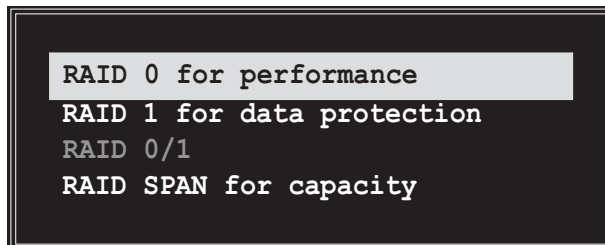

2. Select **RAID 0 for performance** from the menu and press <Enter>. From this point, you may choose to auto-configure the RAID array by selecting **Auto Setup for Performance** or manually configure the RAID array for striped sets. If you want to manually configure the RAID array continue with next step, otherwise, proceed to step #5.
3. Select **Select Disk Drives**, then press <Enter>. Use arrow keys to select disk drive/s, then press <Enter> to mark selected drive. An asterisk is placed before the selected drive.
4. Select **Block Size**, then press <Enter> to set array block size. A list of valid array block sizes are displayed on a pop-up menu.



---

**TIP:** For server systems, it is recommended to use a lower array block size. For multimedia computer systems used mainly for audio and video editing, a higher array block size is recommended for optimum performance.

---

Use arrow keys to move selection bar on items and press <Enter> to select.

5. Select **Start Create Process** and press <Enter> to setup hard disk for RAID system. The following confirmation message appears:



---

The same confirmation message appears when the **Auto Setup for Performance** option is selected.

---

```
The data on the selected disks will
be destroyed. Continue? Press Y/N
```

Press “Y” to confirm or “N” to return to the configuration options.

### 3.3.3.2 RAID 1 for data protection

1. Select the second option item **Array Mode**, then press the <Enter> key. The RAID system setting pop-up menu appears.

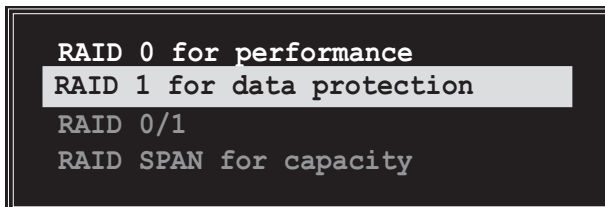

2. Select **RAID 1 for data protection** from the menu and press <Enter>. Select next task from pop-up menu. The task **Create only** creates the mirrored set without creating a backup. **Create and duplicate** creates both mirrored set and backup.



3. Select task and press <Enter>. The screen returns to Create Array menu items. From this point, you may choose to auto-configure the RAID array by selecting **Auto Setup for Data Security** or manually configure the RAID array for mirrored sets. If you want to manually configure the RAID array continue with next step, otherwise, proceed to step #5.



4. Select **Select Disk Drives**, then press <Enter>. Use arrow keys to select disk drive/s, then press <Enter> to mark selected drive. (*An asterisk is placed before a selected drive.*)
5. Select **Start Create Process** and press <Enter> to setup hard disk for RAID system. The following confirmation message appears:



---

The same confirmation message appears when the **Auto Setup for Data Security** option is selected.

---

```
The data on the selected disks will
be destroyed. Continue? Press Y/N
```

Press “Y” to confirm or “N” to return to the configuration options.

4. Select **Start Create Process** and press <Enter> to setup hard disk for RAID system. The following confirmation message appears:



---

The same confirmation message appears when the **Auto Setup for Capacity** option is selected.

---

```
The data on the selected disks will
be destroyed. Continue? Press Y/N
```

Press “Y” to confirm or “N” to return to the configuration options.

### 3.3.4 Delete Array

1. In the VIA RAID BIOS utility main menu, select **Delete Array** then press the <Enter> key. The focus is directed to the list of channel used for IDE RAID arrays.
2. Press the <Enter> key to select a RAID array to delete. The following confirmation message appears.

```
The selected array will be destroyed.
Are you sure? Continue? Press Y/N
```

Press “Y” to confirm or “N” to return to the configuration options.

### 3.3.5 Select Boot Array

1. In the VIA RAID BIOS utility main menu, select **Select Boot Array** then press the <Enter> key. The focus is directed to the list of channel used for IDE RAID arrays.
2. Press the <Enter> key to select a RAID array for boot. The **Status** of the selected array will change to Boot. Press <ESC> key to go return to menu items. Follow the same procedure to deselect the the boot array.

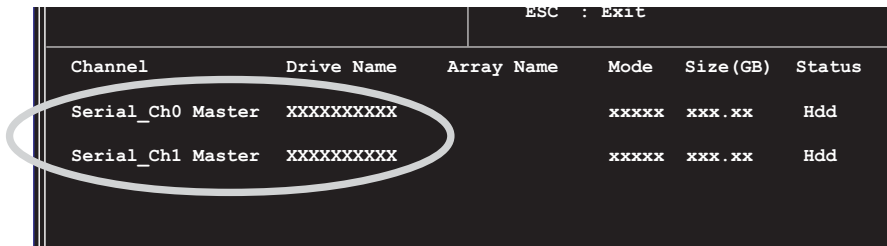

Channel	Drive Name	Array Name	Mode	Size (GB)	Status
Serial_Ch0 Master	XXXXXXXXXX		xxxxx	xxx.xx	Hdd
Serial_Ch1 Master	XXXXXXXXXX		xxxxx	xxx.xx	Hdd

### 3.3.6 Serial Number View

1. In the VIA RAID BIOS utility main menu, select **Serial Number View** then press the <Enter> key. The focus is directed to the list of channel used for IDE RAID arrays. Move the selection bar on each item and the serial number is displayed at the bottom of the screen. This option is useful for identifying same model disks.

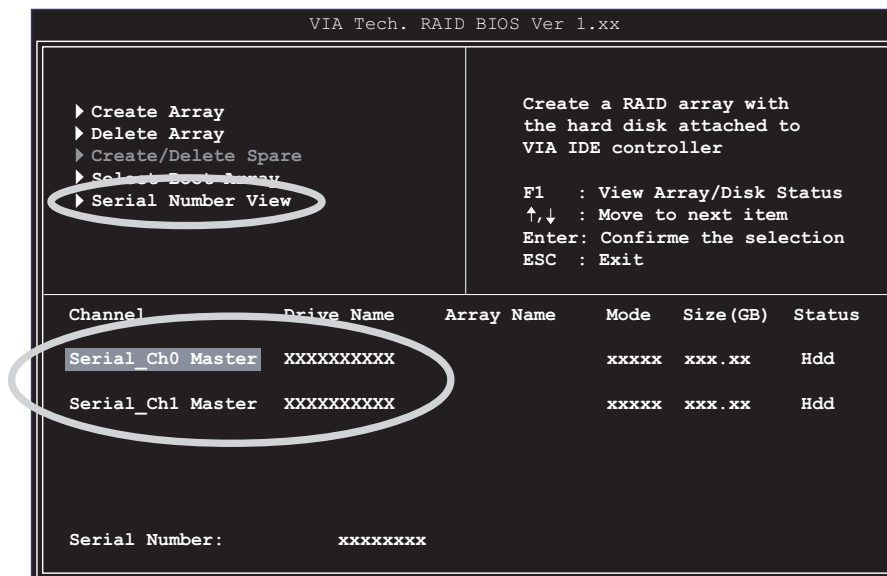

VIA Tech. RAID BIOS Ver 1.xx

▶ Create Array  
▶ Delete Array  
▶ Create/Delete Spare  
▶ Select Boot Array  
▶ Serial Number View

Create a RAID array with the hard disk attached to VIA IDE controller

F1 : View Array/Disk Status  
↑,↓ : Move to next item  
Enter: Confirme the selection  
ESC : Exit

Channel	Drive Name	Array Name	Mode	Size (GB)	Status
Serial_Ch0 Master	XXXXXXXXXX		xxxxx	xxx.xx	Hdd
Serial_Ch1 Master	XXXXXXXXXX		xxxxx	xxx.xx	Hdd

Serial Number:            xxxxxxxx