

**ASUS<sup>®</sup> TX97-XE**  
Pentium<sup>®</sup> ATX Motherboard

**USER'S MANUAL**

# USER'S NOTICE

---

No part of this manual, including the products and softwares described in it, may be reproduced, transmitted, transcribed, stored in a retrieval system, or translated into any language in any form or by any means, except documentation kept by the purchaser for backup purposes, without the express written permission of ASUSTeK COMPUTER INC. ("ASUS").

ASUS PROVIDES THIS MANUAL "AS IS" WITHOUT WARRANTY OF ANY KIND, EITHER EXPRESS OR IMPLIED, INCLUDING BUT NOT LIMITED TO THE IMPLIED WARRANTIES OR CONDITIONS OF MERCHANTABILITY OR FITNESS FOR A PARTICULAR PURPOSE. IN NO EVENT SHALL ASUS, ITS DIRECTORS, OFFICERS, EMPLOYEES OR AGENTS BE LIABLE FOR ANY INDIRECT, SPECIAL, INCIDENTAL, OR CONSEQUENTIAL DAMAGES (INCLUDING DAMAGES FOR LOSS OF PROFITS, LOSS OF BUSINESS, LOSS OF USE OR DATA, INTERRUPTION OF BUSINESS AND THE LIKE), EVEN IF ASUS HAS BEEN ADVISED OF THE POSSIBILITY OF SUCH DAMAGES ARISING FROM ANY DEFECT OR ERROR IN THIS MANUAL OR PRODUCT.

Products and corporate names appearing in this manual may or may not be registered trademarks or copyrights of their respective companies, and are used only for identification or explanation and to the owners' benefit, without intent to infringe.

- Intel, LANDesk, and Pentium are registered trademarks of Intel Corporation.
- IBM and OS/2 are registered trademarks of International Business Machines.
- Symbios is a registered trademark of Symbios Logic Corporation.
- Windows and MS-DOS are registered trademarks of Microsoft Corporation.
- Sound Blaster AWE32 and SB16 are trademarks of Creative Technology Ltd.
- Adobe and Acrobat are registered trademarks of Adobe Systems Incorporated.

The product name and revision number are both printed on the board itself. Manual revisions are released for each board design represented by the digit before and after the period of the manual revision number. Manual updates are represented by the third digit in the manual revision number.

For previous or updated manuals, BIOS, drivers, or product release information, contact ASUS at <http://www.asus.com.tw> or through any of the means indicated on the following page.

SPECIFICATIONS AND INFORMATION CONTAINED IN THIS MANUAL ARE FURNISHED FOR INFORMATIONAL USE ONLY, AND ARE SUBJECT TO CHANGE AT ANY TIME WITHOUT NOTICE, AND SHOULD NOT BE CONSTRUED AS A COMMITMENT BY ASUS. ASUS ASSUMES NO RESPONSIBILITY OR LIABILITY FOR ANY ERRORS OR INACCURACIES THAT MAY APPEAR IN THIS MANUAL, INCLUDING THE PRODUCTS AND SOFTWARES DESCRIBED IN IT.

**Copyright © 1998 ASUSTeK COMPUTER INC. All Rights Reserved.**

Product Name:	<b>ASUS TX97-XE</b>
Manual Revision:	<b>3.03</b>
Release Date:	<b>July 1998</b>

# ASUS CONTACT INFORMATION

---

## ASUSTeK COMPUTER INC.

### *Marketing*

Address: 150 Li-Te Road, Peitou, Taipei, Taiwan 112  
Telephone: +886-2-2894-3447  
Fax: +886-2-2894-3449  
Email: info@asus.com.tw

### *Technical Support*

Fax: +886-2-2895-9254  
BBS: +886-2-2896-4667  
Email: tsd@asus.com.tw  
WWW: www.asus.com.tw  
FTP: ftp.asus.com.tw/pub/ASUS

## ASUS COMPUTER INTERNATIONAL

### *Marketing*

Address: 6737 Mowry Avenue, Mowry Business Center, Building 2  
Newark, CA 94560, USA  
Fax: +1-510-608-4555  
Email: info-usa@asus.com.tw

### *Technical Support*

Fax: +1-510-608-4555  
BBS: +1-510-739-3774  
Email: tsd-usa@asus.com.tw  
WWW: www.asus.com  
FTP: ftp.asus.com.tw/pub/ASUS

## ASUS COMPUTER GmbH

### *Marketing*

Address: Harkort Str. 25, 40880 Ratingen, BRD, Germany  
Telephone: 49-2102-445011  
Fax: 49-2102-442066  
Email: info-ger@asus.com.tw

### *Technical Support*

Hotline: 49-2102-499712  
BBS: 49-2102-448690  
Email: tsd-ger@asus.com.tw  
WWW: www.asuscom.de  
FTP: ftp.asuscom.de/pub/ASUSCOM

# CONTENTS

---

<b>I. INTRODUCTION .....</b>	<b>7</b>
How this Manual is Organized .....	7
Item Checklist .....	7
<b>II. FEATURES .....</b>	<b>8</b>
Features of the ASUS TX97-XE Motherboard .....	8
ASUS TX97 Smart Series Motherboards .....	9
Parts of the ASUS TX97-XE Motherboard .....	11
<b>III. INSTALLATION .....</b>	<b>12</b>
ASUS TX97-XE Motherboard Layout .....	12
Installation Steps .....	14
1. Jumpers .....	14
Jumper Settings .....	15
Compatible Cyrix CPU Identification .....	18
2. System Memory (SIMM & DIMM) .....	18
SIMM Memory Installation .....	20
DIMM Memory Installation Procedures .....	21
3. Central Processing Unit (CPU) .....	22
4. Expansion Cards .....	23
Expansion Card Installation Procedure: .....	23
Assigning IRQs for Expansion Cards .....	23
Assigning DMA Channels for ISA Cards .....	24
ISA Cards and Hardware Monitor .....	24
5. External Connectors .....	25
Power Connection Procedures .....	33
<b>IV. BIOS SOFTWARE .....</b>	<b>34</b>
Support Software .....	34
Flash Memory Writer Utility .....	34
Main Menu .....	34
Managing and Updating Your Motherboard's BIOS .....	36
6. BIOS Setup .....	37
Load Defaults .....	38
Standard CMOS Setup .....	38
Details of Standard CMOS Setup: .....	38
BIOS Features Setup .....	41
Details of BIOS Features Setup .....	41
Chipset Features Setup .....	44
Details of Chipset Features Setup .....	44
Power Management Setup .....	47
Details of Power Management Setup .....	47

# CONTENTS

---

PNP and PCI Setup .....	50
Details of PNP and PCI Setup .....	50
Load BIOS Defaults .....	52
Load Setup Defaults .....	52
Supervisor Password and User Password .....	53
IDE HDD Auto Detection .....	54
Save & Exit Setup .....	55
Exit Without Saving .....	55
Desktop Management Interface (DMI) .....	56
Introducing the ASUS DMI Configuration Utility .....	56
System Requirements .....	56
Using the ASUS DMI Configuration Utility .....	57
<b>16-bit Audio .....</b>	<b>59</b>
ASUS Audio CD .....	61
ASUS Audio Driver CD Contents .....	61
<b>Audio Drivers Installation .....</b>	<b>61</b>
<b>Win95 Audio Drivers .....</b>	<b>62</b>
<b>Win3.x Audio Drivers .....</b>	<b>63</b>
Configuration Manager .....	63
Creative PnP Configuration Manager (CTCM) .....	63
Audio Software .....	65
Environment Variables .....	69
SOUND Environment variable .....	69
BLASTER Environment Variable .....	69
MIDI Environment Variable .....	70
Maximum Recording Rates for the Audio Hardware .....	70

# FCC & DOC COMPLIANCE

---

## ***Federal Communications Commission Statement***

This device complies with FCC Rules Part 15. Operation is subject to the following two conditions:

- This device may not cause harmful interference, and
- This device must accept any interference received, including interference that may cause undesired operation.

This equipment has been tested and found to comply with the limits for a Class B digital device, pursuant to Part 15 of the FCC Rules. These limits are designed to provide reasonable protection against harmful interference in a residential installation. This equipment generates, uses and can radiate radio frequency energy and, if not installed and used in accordance with manufacturer's instructions, may cause harmful interference to radio communications. However, there is no guarantee that interference will not occur in a particular installation. If this equipment does cause harmful interference to radio or television reception, which can be determined by turning the equipment off and on, the user is encouraged to try to correct the interference by one or more of the following measures:

- Re-orient or relocate the receiving antenna.
- Increase the separation between the equipment and receiver.
- Connect the equipment to an outlet on a circuit different from that to which the receiver is connected.
- Consult the dealer or an experienced radio/TV technician for help.

**WARNING!** The use of shielded cables for connection of the monitor to the graphics card is required to assure compliance with FCC regulations. Changes or modifications to this unit not expressly approved by the party responsible for compliance could void the user's authority to operate this equipment.

## ***Canadian Department of Communications Statement***

This digital apparatus does not exceed the Class B limits for radio noise emissions from digital apparatus set out in the Radio Interference Regulations of the Canadian Department of Communications.

# I. INTRODUCTION

---

## How this Manual is Organized

This manual is divided into the following sections:

- |                            |                                                        |
|----------------------------|--------------------------------------------------------|
| <b>I. Introduction</b>     | Manual information and checklist                       |
| <b>II. Features</b>        | Information and specifications concerning this product |
| <b>III. Installation</b>   | Instructions on setting up the motherboard.            |
| <b>IV. BIOS Software</b>   | Instructions on setting up the BIOS software           |
| <b>V. Support Software</b> | Information on the included support software           |
| <b>Audio Installation</b>  | Audio driver installation (with onboard audio only)    |

## Item Checklist

Please check that your package is complete. If you discover damaged or missing items, please contact your retailer.

- (1) ASUS Motherboard
- (1) IDE ribbon cable for master and slave drives
- (1) Floppy ribbon cable for (1) 5.25inch floppy and (2) 3.5inch floppies
- (1) Bag of spare jumpers
- (1) Support drivers and utilities
- (1) User's Manual
  
- Infrared module (optional)
- ASUS audio onboard and audio driver CD with online help (optional)

## II. FEATURES

---

### Features of the ASUS TX97-XE Motherboard

The ASUS TX97-XE is carefully designed for the demanding PC user who wants many features in a small package. This motherboard:

- **Intel Chipset:** Features Intel's 430TX PCIset with I/O subsystems.
- **Versatile Processor Support:** Intel Pentium® 75-233MHz (P55C-MMX™, P54C/P54CS), IBM®/Cyrix® 6x86-PR166+ (Rev 2.7 or later), IBM®/Cyrix® 6x86MX™ (PR166 & faster), AMD-K5™ (PR75-PR133), AMD-K6™ (PR166 & faster).
- **Versatile Memory Support:** Is equipped with two DIMM sockets to support 8-128MB 168-pin 3.3Volt SDRAM/EDO memory modules up to 256MB. Is also equipped with four SIMM sockets to support 4-64MB 72-pin Fast Page Mode (FPM) or Extended Data Out (EDO) memory modules up to 256MB. SIMMs and DIMMs cannot be used at the same time.
- **Easy Installation:** Is equipped with BIOS that supports auto detection of hard drives, PS/2 mouse, and Plug and Play devices to make setup of hard drives, expansion cards, and other devices virtually automatic.
- **ISA & PCI Expansion:** Provides four 16-bit ISA and four 32-bit PCI slots.
- **Super Multi-I/O:** Provides two high-speed UART-compatible serial ports and one parallel port with EPP and ECP capabilities.
- **Desktop Management Interface (DMI):** Supports DMI through BIOS which allows hardware to communicate within a standard protocol creating a higher level of compatibility. (Requires DMI-enabled components.) (See section V)
- **PCI Bus Master IDE Controller:** Comes with an onboard PCI Bus Master IDE controller with two connectors that supports four IDE devices in two channels, supports PIO Modes 3 and 4 and Bus Master IDE DMA Mode 2, and supports Enhanced IDE devices such as Tape Backup and CD-ROM drives. Supports two drives of either 5.25-inch (360KB or 1.2MB) or 3.5-inch (720KB, 1.44MB, or 2.88MB) disk drives. Supports Japanese "Floppy 3 mode" (3.5-inch disk drive: 1.2MB) and LS-120 floppy disk drives (3.5-inch disk drive: 120 MB, 1.44MB, 720K). BIOS supports IDE CD-ROM or SCSI device boot-up.
- **Level 2 Cache:** 512KB Pipelined Burst SRAM onboard.
- **Optional IrDA:** Supports and optional IrDA receiver/transmitter device.
- **Optional Audio:** Has optional onboard Creative Labs® Audio with 3D sound.
- **Optional IrDA Connector:** Supports an optional infrared port module for wireless interface.



## II. FEATURES

---

### ASUS TX97 Smart Series Motherboards

#### Performance

- **SDRAM Optimized Performance** - ASUS TX97 smart series motherboards support the new generation memory - Synchronous Dynamic Random Access Memory (SDRAM) which increases the data transfer rate from 264MB/s max using EDO memory to 528MB/s max using SDRAM.
- **Double the IDE Transfer Speed** - ASUS TX97 smart series motherboards with Intel 430TX PCIset improves IDE transfer rate using Bus Master UltraDMA/33 IDE which can handle data transfer up to 33MB/s. The best of all is that this new technology is compatible with existing ATA-2 IDE specs so there is no need to upgrade current hard drives or cables.
- **Concurrent PCI** - Concurrent PCI allows multiple PCI transfers from PCI master busses to memory to CPU.
- **ACPI Ready** - ACPI (Advanced Configuration and Power Interface) is also implemented on all ASUS 430TX series of motherboards. ACPI provide more Energy Saving Features for the future operating systems (OS) supporting OS Direct Power Management (OSPM) functionality. With these features implemented in the OS, PCs can be ready around the clock everyday, yet satisfy all the energy saving standards. To fully utilize the benefits of ACPI, an ACPI-supported OS such as in the next release of Windows 95 must be used.
- **PC '97 Compliant** - Both the BIOS and hardware levels of ASUS TX97 series of motherboards meet PC '97 compliancy. The new PC 97 requirements for systems and components are based on the following high-level goals: Support for Plug and Play compatibility and power management for configuring and managing all system components, and 32-bit device drivers and installation procedures for both Windows 95 and Windows NT.

#### Intelligence: (with optional LM78/75 Hardware Monitor only)

- **Fan Status Monitoring and Alarm** - To prevent system overheat and system damage, the CPU fan and system fans are monitored for RPM and failure. Each fan can be set for its normal RPM range and alarm thresholds.
- **Temperature Monitoring and Alert** - To prevent system overheat and system damage, there is a heat sensor under the CPU and on the motherboard itself to monitor CPU and system temperature to make sure the system is operating at a safe heat level to avoid any failures triggered by extremely high temperature.

## II. FEATURES

---

- **Voltage Monitoring and Alert:** System voltage levels are monitored to ensure stable current to critical motherboard components. Voltage specifications are more critical for future processors, so monitoring is necessary to ensure proper system configuration and management.
- **System Resources Alert:** Today's operating systems such as Windows 95, Windows NT, and OS/2, require much more memory and hard drive space to present enormous user interfaces and run large applications. The system resource monitor will warn the user before the system resources are used up to prevent possible application crashes. Suggestions will give the user information on managing their limited resources more efficiently.
- **Virus Write Protection** - Normally, viruses can destroy data on storage media such as hard drivers, floppy diskettes, and MO. Some new-generation viruses will not only destroy data on storage media, but also clear BIOS data which is usually unprotected. ASUS TX97 series of motherboards were designed to cooperate with BIOS, chipset, and flash EPROM to disable write permission when the system's initialization stage is completed upon boot-up.
- **CPU Slow Down** - When CPU fans or system fans are malfunctioning, the system will deactivate the CPU Clock line to decrease CPU utilization to the speed upon detection of system overheat. This will prevent CPU damage from system overheat. The CPU utilization will restore normal operations when temperature falls below a safe level.
- **Auto Fan Off** - The system fans will power off automatically **even in sleep mode**. This function reduces both energy consumption *and* **system noise**, and is a important feature to implement silent PC systems.
- **Dual Function Power Button (requires ATX power supply):** The system can be in one of two states, one is Sleep mode and the other is the Soft-Off mode. Pushing the power button for less than 4 seconds places the system into Sleep mode. When the power button is pressed for more than 4 seconds, it enters the Soft-Off mode.
- **Remote Ring On (requires external modem and ATX power supply):** This allows a computer to be turned on remotely through an external modem. With this benefit on-hand, any user can access vital information from their computer from anywhere in the world!
- **Message LED (requires ACPI OS support):** Chassis LEDs now act as information providers. Through the way a particular LED illuminates, the user can determine the stage the computer is in. A simple glimpse provides useful information to the user.

# II. FEATURES

## Parts of the ASUS TX97-XE Motherboard

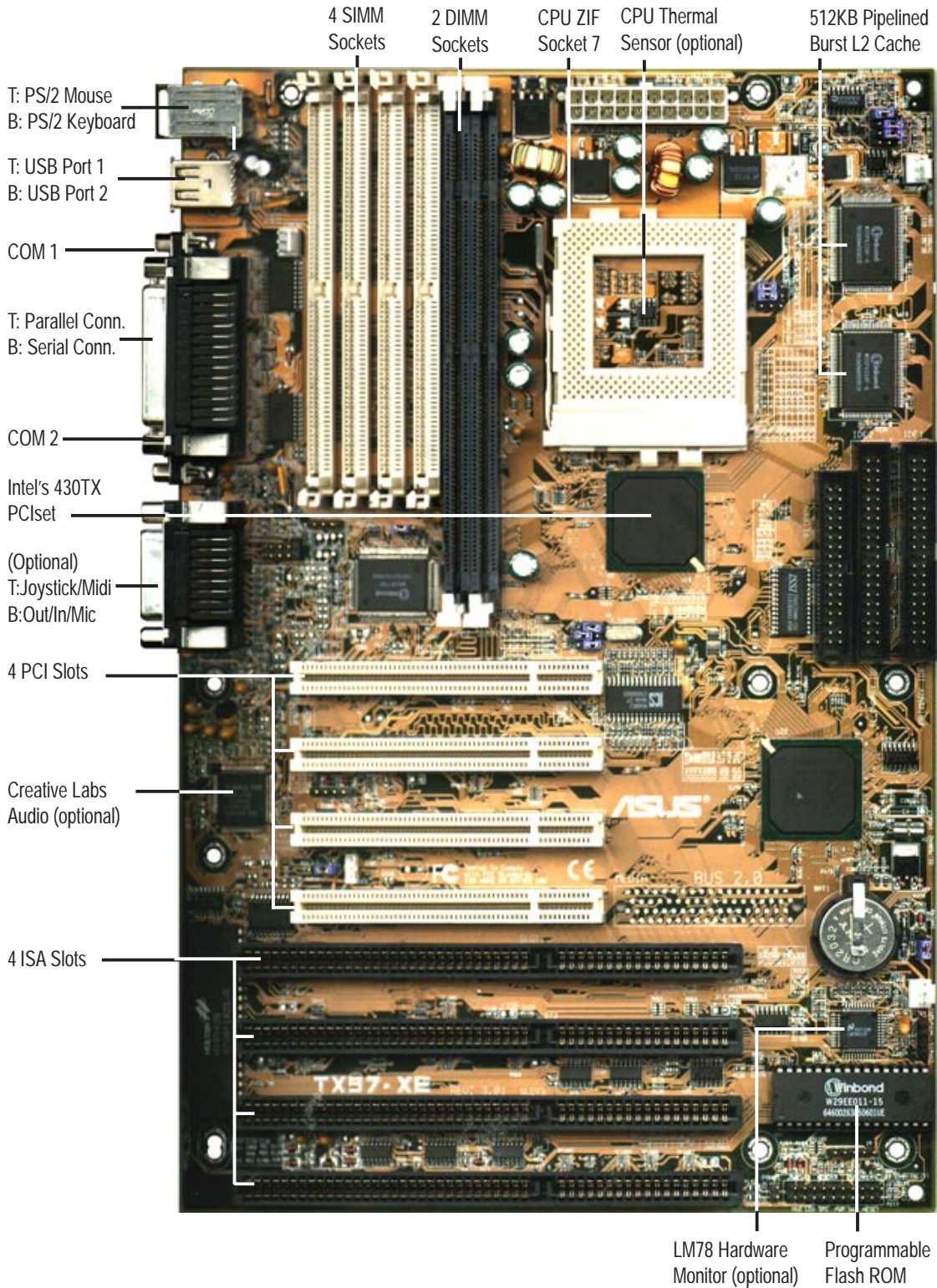

II. FEATURES  
Motherboard Parts

# III. INSTALLATION

## ASUS TX97-XE Motherboard Layout

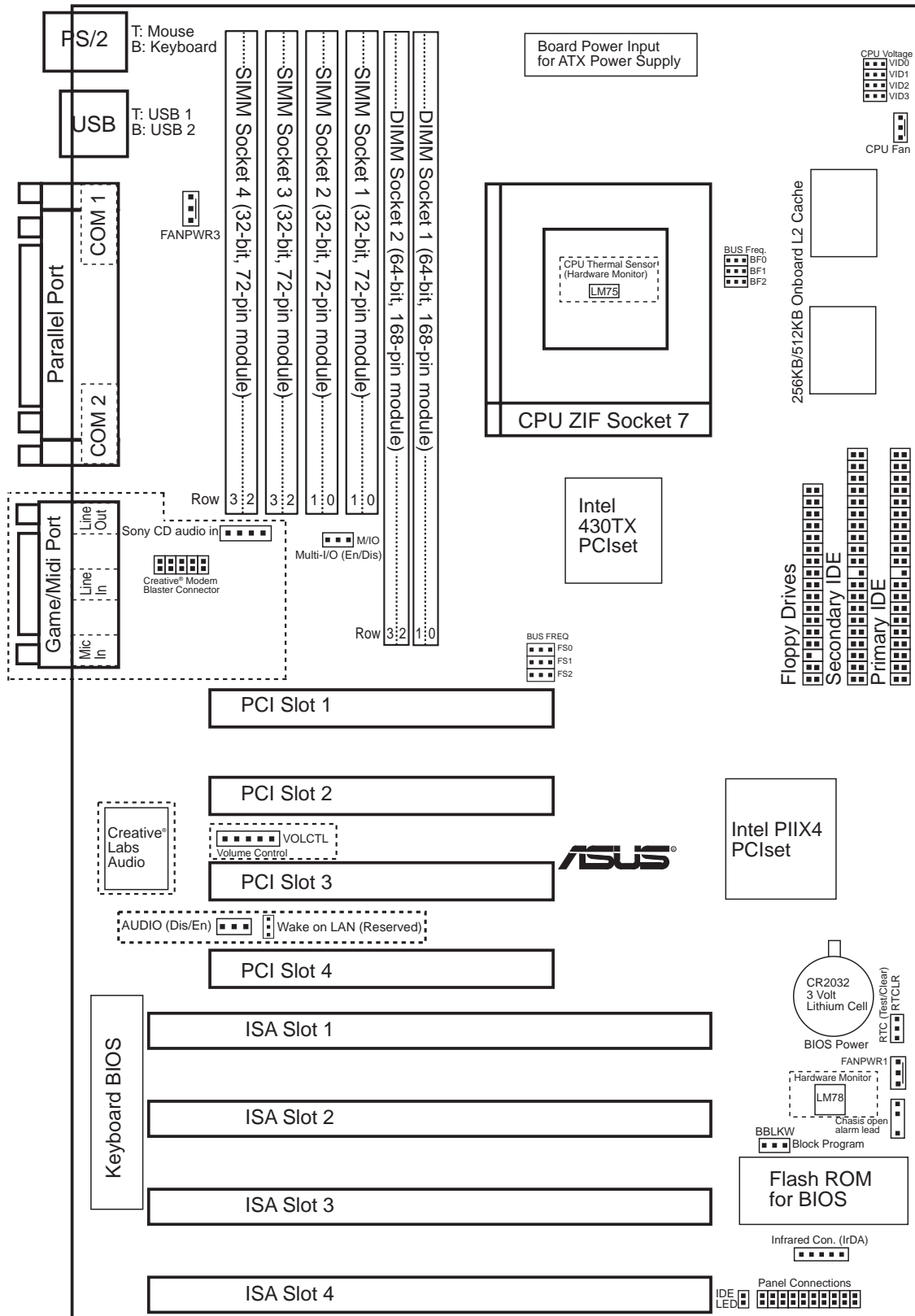

NOTE: The items in outline are optional and may not be present.

III. INSTALLATION  
Motherboard Layout

# III. INSTALLATION

---

## Jumpers

- |                     |       |                                              |
|---------------------|-------|----------------------------------------------|
| 1) RTCLR            | p. 15 | Real Time Clock RAM (Operation/Clear Data)   |
| 2) AUDIO (optional) | p. 15 | Onboard Audio (Disable/Enable)               |
| 3) M/IO             | p. 16 | Multi-I/O Selection (Enable/Disable)         |
| 4) FS0, FS1, FS2    | p. 16 | CPU External Clock (BUS) Frequency Selection |
| 5) BF0, BF1, BF2    | p. 16 | CPU:BUS Frequency Ratio                      |
| 6) VID0, 1, 2, 3    | p. 18 | CPU Voltage Regulator Output Selection       |

## Expansion Slots

- |                     |       |                                       |
|---------------------|-------|---------------------------------------|
| 1) System Memory    | p. 19 | System Memory Upgrade                 |
| 2) SIMM Sockets     | p. 20 | 72-Pin SIMM Memory Expansion Sockets  |
| 3) DIMM Sockets     | p. 21 | 168-Pin DIMM Memory Expansion Sockets |
| 4) CPU ZIF Socket 7 | p. 22 | Central Processing Unit (CPU) Socket  |
| 5) SLOT 1, 2, 3, 4  | p. 23 | 16-bit ISA Bus Expansion Slots*       |
| 6) PCI 1, 2, 3, 4   | p. 23 | 32-bit PCI Bus Expansion Slots        |

## Connectors

- |                         |       |                                                               |
|-------------------------|-------|---------------------------------------------------------------|
| 1) PS2KEYBOARD          | p. 25 | PS/2 Keyboard Connector (6-pin Female)                        |
| 2) PS2MOUSE             | p. 25 | PS/2 Mouse Connector (6-pin Female)                           |
| 3) PRINTER              | p. 26 | Parallel (Printer) Port Connector (25-pin Female)             |
| 4) COM1, COM2           | p. 26 | Serial Port COM1 & COM2 (Two 9-pin Female)                    |
| 5) FLOPPY               | p. 26 | Floppy Drive Connector (34-pin Block)                         |
| 6) AUDIO (optional)     | p. 27 | Audio Port -Line Out, Line In, Mic (Three 1/8" Female)        |
| 7) GAME (optional)      | p. 27 | Joystick/Midi Connector (15-pin Female)                       |
| 8) USB                  | p. 27 | Universal Serial BUS Ports 1 & 2 (Two 4-pin Female)           |
| 9) Primary / Second IDE | p. 28 | Primary / Secondary IDE Connector (40-pin Blocks)             |
| 10) IDELED              | p. 28 | IDE LED Activity Light                                        |
| 11) FANPWR1, 2, 3       | p. 29 | 1 Chassis, 2 CPU, 3 Power Supply Fan Power Lead (3-pin Block) |
| 12) CHASSIS             | p. 29 | Chassis Open Alarm Lead (4-1pin Block)                        |
| 13) IR                  | p. 30 | Infrared Port Module Connector                                |
| 14) ATXPWR              | p. 30 | ATX Motherboard Power Connector (20-pin Block)                |
| 15) VOLCTL (optional)   | p. 31 | Digital Volume Level Control (5-pin Block)                    |
| 16) WOL                 | p. 31 | Wake on LAN (3 pins)                                          |
| 17) MSG LED (PANEL)     | p. 32 | System Message LED (2 pins)                                   |
| 18) SMI (PANEL)         | p. 32 | SMI Switch Lead (2 pins)                                      |
| 19) PWR SW (PANEL)      | p. 32 | ATX Power & Soft-Off Switch Lead (2 pins)                     |
| 20) RESET (PANEL)       | p. 32 | Reset Switch Lead (2 pins)                                    |
| 21) PWR LED (PANEL)     | p. 32 | System Power LED Lead (3 pins)                                |
| 22) KEYLOCK (PANEL)     | p. 32 | Keyboard Lock Switch Lead (2 pins)                            |
| 23) SPEAKER (PANEL)     | p. 32 | Speaker Output Connector (4 pins)                             |

\*The onboard hardware monitor uses the address 290H-297H so legacy ISA cards must not use this address or else conflicts will occur.







# III. INSTALLATION

## Installation Steps

Before using your computer, you must complete the following steps:

1. Set Jumpers on the Motherboard
2. Install System Memory Modules
3. Install the Central Processing Unit (CPU)
4. Install Expansion Cards
5. Connect Ribbon Cables, Cabinet Wires, and Power Supply
6. Setup the BIOS Software

### 1. Jumpers

Several hardware settings are made through the use of jumper caps to connect jumper pins (JP) on the motherboard. See motherboard layout for locations of jumpers. The jumper settings will be described numerically, such as [----], [1-2], [2-3] for no connection, connect pins 1&2, and connect pins 2&3 respectively. Pin 1 for our motherboards is always on top  or on the left  when holding the motherboard with the keyboard connector away from yourself. A “1” is written besides pin 1 on jumpers with three pins. The jumpers will also be shown graphically such as  to connect pins 1&2 and  to connect pins 2&3. Jumpers with two pins will be shown as  for Short (On) and  for Open (Off). For manufacturing simplicity, the jumpers may be sharing pins from other groups. Use the diagrams in this manual instead of following the pin layout on the board. Settings with two jumper numbers require that both jumpers be moved together. To connect the pins, simply place a plastic jumper cap over the two pins as diagramed.

**WARNING!** Computer motherboards, baseboards and components, such as SCSI cards, contain very delicate Integrated Circuit (IC) chips. To protect them against damage from static electricity, you should follow some precautions whenever you work on your computer.

1. Unplug your computer when working on the inside.
2. Use a grounded wrist strap before handling computer components. If you do not have one, touch both of your hands to a safely grounded object or to a metal object, such as the power supply case.
3. Hold components by the edges and try not to touch the IC chips, leads or connectors, or other components.
4. Place components on a grounded antistatic pad or on the bag that came with the component whenever the components are separated from the system.

# III. INSTALLATION

## Jumper Settings

### 1. Real Time Clock (RTC) RAM (RTCLR)

The CMOS RAM is powered by the onboard button cell battery. To clear the RTC data: (1) Turn off your computer and remove the AC power, (2) Move this jumper to “Clear Data,” (3) Move the jumper back to “Operation,” (4) Turn on your computer, (5) Hold down <Delete> during bootup and enter BIOS setup to re-enter user preferences.

#### Battery Test Jumper (RTCLR)

You can test the battery’s current by removing this jumper and attaching a current meter to pins 1&2. **WARNING: You must unplug the power cord to your power supply to ensure that there is no power to your motherboard. The CMOS RAM containing BIOS setup information *may* be cleared by this action. You *should* enter BIOS to “Load Setup Defaults” and re-enter any user information after removing and reapplying this jumper.**

<u>RTC RAM</u>	<u>RTCLR</u>
Operation	[1-2] (Default)
Clear Data	[2-3] (momentarily)

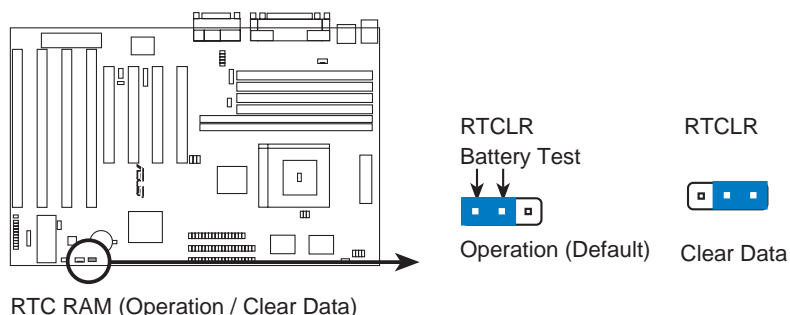

### 2. Onboard Audio Selection (AUDIO) (with optional onboard Audio)

This jumper allows you to Disable the onboard audio chipset in order to use your own audio card. Otherwise, leave on default of Enabled.

<u>Onboard Audio</u>	<u>AUDIO</u>
Enabled	[2-3] (Default)
Disabled	[1-2]

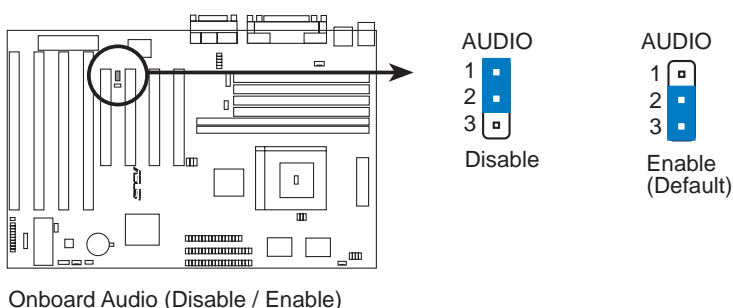

# III. INSTALLATION

## 3. Onboard Multi-I/O Selection (M/I/O)

You can selectively disable each onboard Multi-I/O item (floppy, serial, parallel, and IrDA) through **Chipset Features Setup** of BIOS SOFTWARE or disable all Multi-I/O items at once with the following jumper in order to use your own Multi-I/O card.

Multi-I/O	M/I/O
Enable	[1-2] (Default)
Disable	[2-3]

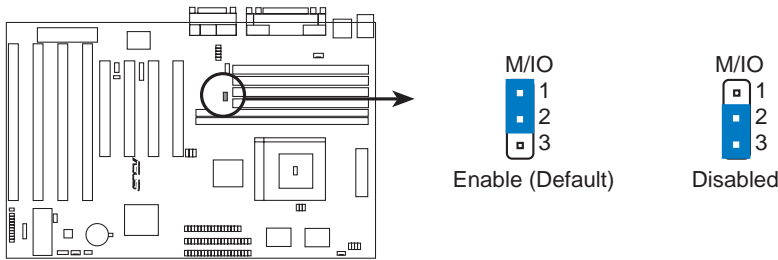

Multi I/O Setting (Enable / Disable)

## 4. CPU External (BUS) Frequency Selection (FS0, FS1, FS2)

These jumpers tell the clock generator what frequency to send to the CPU. These allow the selection of the CPU's *External* frequency (or *BUS Clock*). The BUS Clock times the BUS Ratio equals the CPU's *Internal* frequency (the advertised CPU speed).

## 5. CPU to BUS Frequency Ratio (BF0, BF1, BF2)

These jumpers set the frequency ratio between the *Internal* frequency of the CPU and the *External* frequency (called the *BUS Clock*) within the CPU. These must be set together with the above jumpers *CPU External (BUS) Frequency Selection*.

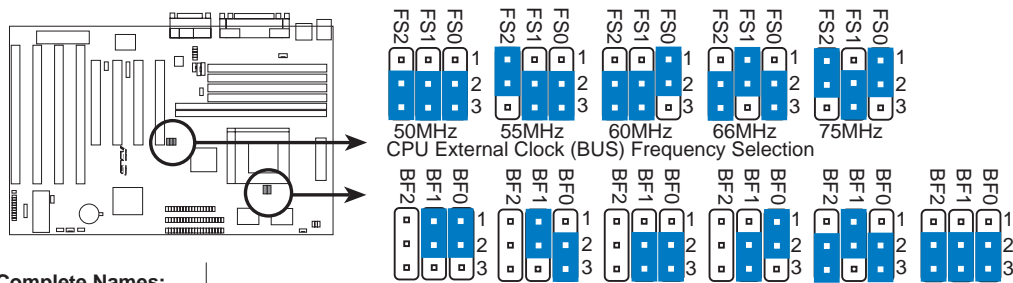

**Complete Names:**

Intel Pentium P54C	P54C/K5	→ 1.5x(3/2)	2.0x(2/1)	2.5x(5/2)	3.0x(3/1)	----	----
Pentium P55C-MMX	P55C/K6/MX	→ 3.5x(7/2)	2.0x(2/1)	2.5x(5/2)	3.0x(3/1)	----	----
AMD K5, K6	IBM/Cyrix 6x86	→ 3.0x(3/1)	2.0x(2/1)	1.0x(1/1)	----	----	----
IBM/Cyrix 6x86(L) (M1)	IBM/Cyrix 6x86L	→ 3.0x(3/1)	2.0x(2/1)	2.0x(2/1)	----	----	----
IBM/Cyrix 6x86MX(M2)	AMD-K6 (.25μ)	→ ----	----	----	----	4.0x(4/1)	4.5x(9/2)

CPU : BUS Frequency Ratio



# III. INSTALLATION

Set the jumpers by the Internal speed of the Intel, AMD, IBM, or Cyrix CPU as follows:

CPU Model	Freq.	Ratio	(BUS Freq.)			(Freq. Ratio)		
			BUS Freq.	FS2	FS1	FS0	BF1	BF0
Intel Pentium	233MHz	3.5x	66MHz	[2-3]	[1-2]	[2-3]	[1-2]	[1-2]
Intel Pentium	200MHz	3.0x	66MHz	[2-3]	[1-2]	[2-3]	[2-3]	[1-2]
Intel Pentium	166MHz	2.5x	66MHz	[2-3]	[1-2]	[2-3]	[2-3]	[2-3]
Intel Pentium	150MHz	2.5x	60MHz	[2-3]	[2-3]	[1-2]	[2-3]	[2-3]
Intel Pentium	133MHz	2.0x	66MHz	[2-3]	[1-2]	[2-3]	[1-2]	[2-3]
Intel Pentium	120MHz	2.0x	60MHz	[2-3]	[2-3]	[1-2]	[1-2]	[2-3]
Intel Pentium	100MHz	1.5x	66MHz	[2-3]	[1-2]	[2-3]	[1-2]	[1-2]
Intel Pentium	90MHz	1.5x	60MHz	[2-3]	[2-3]	[1-2]	[1-2]	[1-2]
Intel Pentium	75MHz	1.5x	50MHz	[2-3]	[2-3]	[2-3]	[1-2]	[1-2]
AMD-K6-PR233	233MHz	3.5x	66MHz	[2-3]	[1-2]	[2-3]	[1-2]	[1-2]
AMD-K6-PR200	200MHz	3.0x	66MHz	[2-3]	[1-2]	[2-3]	[2-3]	[1-2]
AMD-K6-PR166	166MHz	2.5x	66MHz	[2-3]	[1-2]	[2-3]	[2-3]	[2-3]
AMD-K5-PR133	100MHz	1.5x	66MHz	[2-3]	[1-2]	[2-3]	[1-2]	[1-2]
AMD-K5-PR120	90MHz	1.5x	60MHz	[2-3]	[2-3]	[1-2]	[1-2]	[1-2]
AMD-K5-PR100	100MHz	1.5x	66MHz	[2-3]	[1-2]	[2-3]	[1-2]	[1-2]
AMD-K5-PR90	90MHz	1.5x	60MHz	[2-3]	[2-3]	[1-2]	[1-2]	[1-2]
AMD-K5-PR75	75MHz	1.5x	50MHz	[2-3]	[2-3]	[2-3]	[1-2]	[1-2]
IBM/Cyrix 6x86MX-PR233	200MHz	3.0x	66MHz	[2-3]	[1-2]	[2-3]	[2-3]	[1-2]
IBM/Cyrix 6x86MX-PR200	166MHz	2.5x	66MHz	[2-3]	[1-2]	[2-3]	[2-3]	[2-3]
IBM/Cyrix 6x86MX-PR166	150MHz	2.5x	60MHz	[2-3]	[2-3]	[1-2]	[2-3]	[2-3]
*IBM/Cyrix -PR166+	133MHz	2.0x	66MHz	[2-3]	[1-2]	[2-3]	[1-2]	[2-3]

**\*NOTE:** Only IBM or Cyrix Rev 2.7 or later is supported on this motherboard (see next page). Bootup screen will show **6x86-P166+** with the Cyrix PR166+ installed on this motherboard.

# III. INSTALLATION

## Compatible Cyrix CPU Identification

The only Cyrix CPU that is supported on this motherboard is labeled Cyrix 6x86 PR166+ but must be Revision 2.7 or later. Look on the underside of the CPU for the serial number. The number should read G8DC6620A or later.

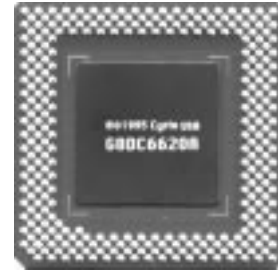

## 6. Voltage Regulator Output Selection (VID0, 1, 2, 3)

These jumpers set the voltage supplied to the CPU. VID1 for 3.4V(STD) is ignored, therefore, the jumper setting for 2.8V(Dual) may work for both 3.4V(STD) and 2.8V(Dual).

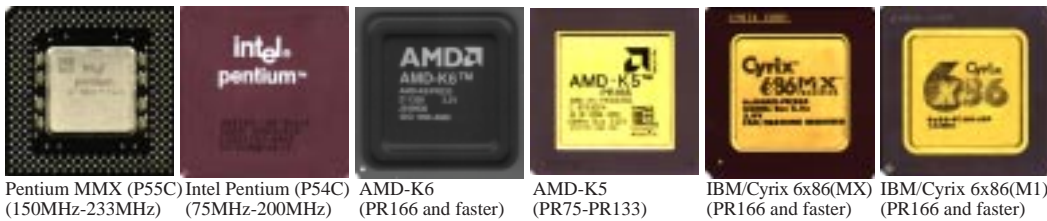

**WARNING!** Because CPU designs change rapidly, the following chart is only intended as a simple guideline and is not intended to be true for your CPU. Look for the CPU voltage included with your CPU and follow the Voltage setting diagramed below the chart.

Manufacturer	CPU Type	Single Plane	Dual Plane	VID3	VID2	VID1	VID0
Intel/AMD/IBM/Cyrix	P54C/CS/K5/M1	3.5V(VRE)	----	[----]	[2-3]	[----]	[1-2]
AMD/IBM/Cyrix	K6-166,200/MX	----	2.9V(Dual)	[----]	[2-3]	[2-3]	[1-2]
Intel/AMD	P54C/CS/K5	3.4V(STD)	----	[----]	[2-3]	[2-3]	[2-3]
Intel	P55C	----	2.8V(Dual)	[----]	[2-3]	[2-3]	[2-3]
AMD	K6-PR233	----	3.2V(Dual)	[----]	[1-2]	[2-3]	[2-3]
AMD (.25micron)	K6-233,266,300	----	2.1V(Dual)	[----]	[----]	[2-3]	[1-2]

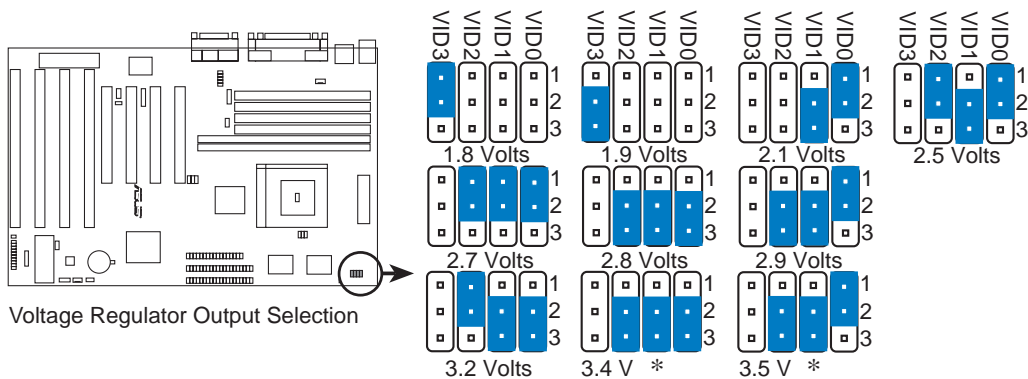

\* Setting these two jumpers' VID1 to [2-3] or [----] (removed) will result in the same voltages respectively.

# III. INSTALLATION

## 2. System Memory (SIMM & DIMM)

This motherboard supports four 72-pin, 32-bit SIMMs (Single Inline Memory Modules) of 4, 8, 16, 32, or 64MB to form a memory size between 8MB to 256MB. The SIMMs can be either 60ns or 70ns Fast Page Mode (FPM) (Asymmetric or Symmetric), or Enhanced Data Out (EDO) (BEDO & Parity are not supported). SIMMs must be installed in pairs so that each Row (see *Map of Motherboard* for Row locations) contains 64-bits of the same size and type of memory chips. One side (with memory chips) of the SIMM module takes up half a Row on the motherboard.

Dual Inline Memory Modules (DIMMs) can be used when the SIMM sockets are not used. Two sockets are available for **3.3Volt** (power level) Unbuffered Synchronous DRAMs (SDRAM) or EDO DRAM of either 8, 16, 32, 64, or 128MB to form a memory size between 8MB to 256MB. One side (with memory chips) of the DIMM module takes up one row on the motherboard.

**IMPORTANT: Memory speed setup is required through “Auto Configuration” in BIOS Chipset Setup of the BIOS SOFTWARE. If both 60ns and 70ns memory are used, set “Auto Configuration” to 70ns. Do not use memory modules with more than 24 chips per module. Modules with more than 24 chips exceed the design specifications of the memory subsystem and will be unstable.**

Memory Socket	SIMM Memory Module		Total Memory
SIMM Sockets 1&2 (Rows 0 & 1)	4MB, 8MB, 16MB, 32MB, 64MB 72-pin FPM or EDO SIMM (DIMM Sockets must be empty)	x2	
SIMM Sockets 3&4 (Rows 2 & 3)	4MB, 8MB, 16MB, 32MB, 64MB 72-pin FPM or EDO SIMM (DIMM Sockets must be empty)	x2	
Total System Memory (Max 256MB)		=	

**WARNING!** Do not install both SIMMs and DIMMs at the same time or else you will burn your memory. Mixing SIMMs and DIMMs require 5.0Volt (signal level) tolerant memory chips which are currently unavailable.

Memory Socket	DIMM Memory Module		Total Memory
DIMM Socket 1 (Rows 0 & 1)	8MB, 16MB, 32MB, 64MB, 128MB 168-pin SDRAM or EDO DIMM (SIMM Sockets must be empty)	x1	
DIMM Socket 2 (Rows 2 & 3)	8MB, 16MB, 32MB, 64MB, 128MB 168-pin SDRAM or EDO DIMM (SIMM Sockets must be empty)	x1	
Total System Memory (Max 256MB)		=	

# III. INSTALLATION

## *SIMM Memory Installation*

1. The SIMM memory modules will only fit in one orientation as shown because of a safety tab on one end of the SIMM sockets, which requires the notched end of the SIMM memory modules.

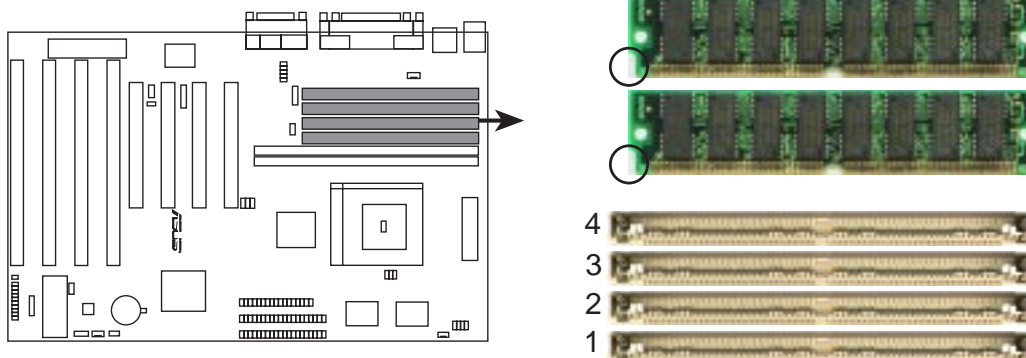

### 72 Pin SIMM Sockets

2. Press the memory module firmly into place starting from a 45 degree angle making sure that all the contacts are aligned with the socket.
3. With your finger tips, rock the memory module into a vertical position so that it clicks into place.



4. The plastic guides should go through the two mounting holes on the sides and the support clips should snap on the other side.
5. To release the memory module, push both support clips outward and rock the module out of the support clips.

# III. INSTALLATION

## *DIMM Memory Installation Procedures*

Insert the module as shown. Because the number of pins are different on either side of the breaks, the module will only fit in the orientation as shown. DRAM SIMM modules have the same pin contact on both sides. SDRAM DIMM modules have different pin contacts on each side and therefore have a higher pin density.

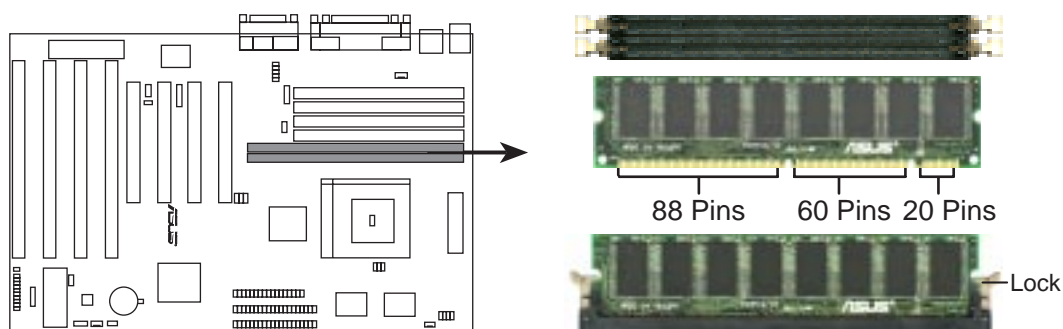

### **168 Pin DIMM Memory Sockets**

The Dual Inline Memory Module (DIMM) memory module must be a 3.3Volt Unbuffered Synchronous DRAM (SDRAM) for this motherboard. You can identify the type of DIMM module by the illustration below:

#### **168-Pin DIMM Notch Key Definitions (3.3V)**

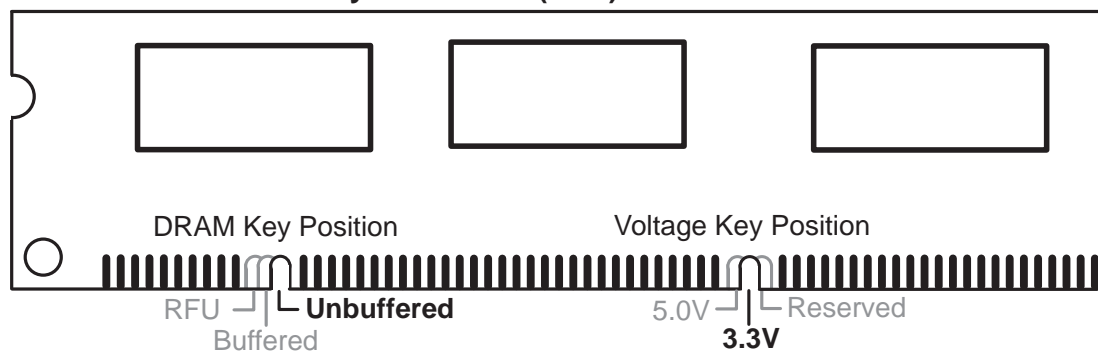

The notch on the DIMM module will shift between left, center, or right to identify the type and also to prevent the wrong type to be inserted into the DIMM slot on the motherboard. You must ask your retailer for the specifications before purchasing. Four clock signals are supported on this motherboard.

# III. INSTALLATION

## 3. Central Processing Unit (CPU)

The motherboard provides a 321-pin ZIF Socket 7 that is backwards compatible with ZIF Socket 5 processors. The CPU that came with the motherboard should have a fan attached to it to prevent overheating. If this is not the case then purchase a fan before you turn on your system. Apply thermal jelly to the CPU top and then install the fan onto the CPU.

**WARNING!** Without a fan circulating air on the CPU and heat sinks, the CPU and/or heat sinks can overheat and cause damage to both the CPU and the motherboard. (See “CPU Cooling Fan Connector” at the end of this section.)

To install a CPU, first turn off your system and remove its cover. Locate the ZIF socket and open it by first pulling the lever sideways away from the socket then upwards to a 90-degree right angle. Insert the CPU with the correct orientation as shown. Use the notched corner of the CPU as your guide. The white dot should point towards the end the of the lever. Notice that there is a blank area where one hole is missing from that corner of the square array of pin holes and a “1” printed on the motherboard next to that corner. Because the CPU has a corner pin for three of the four corners, the CPU will only fit in the one orientation as shown. The picture is for reference only; you should have a CPU fan that will cover the face of the CPU. With the added weight of the CPU fan, no force is required to insert the CPU. Once completely inserted, hold down on the fan and close the socket’s lever.

**IMPORTANT:** You must set jumpers for “CPU to BUS Frequency Ratio” and jumpers for “BUS Frequency Selection” depending on the CPU that you install.

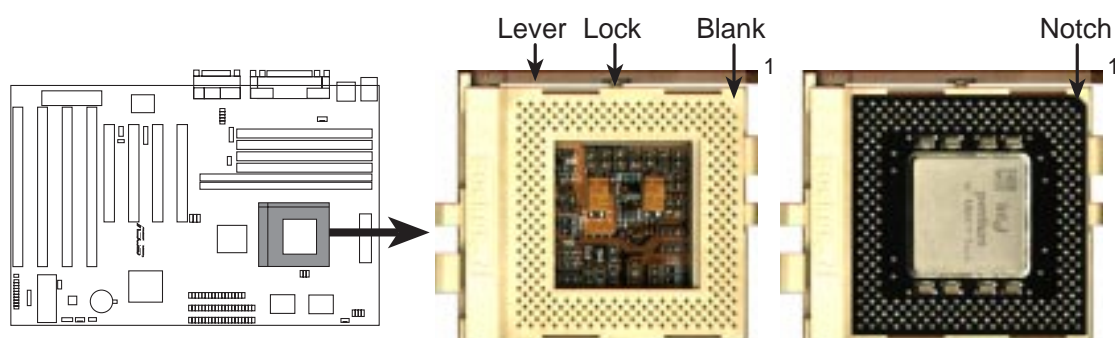

ZIF Socket 7 with Pentium MMX Processor

# III. INSTALLATION

---

## 4. Expansion Cards

**WARNING!** Make sure that you unplug your power supply when adding or removing expansion cards or other system components. Failure to do so may cause severe damage to both your motherboard and expansion cards.

### *Expansion Card Installation Procedure:*

1. Read your expansion card documentation on any hardware and software settings that may be required to setup your specific card.
2. Set any necessary jumpers on your expansion card.
3. Remove your computer system's cover.
4. Remove the bracket on the slot you intend to use.  
Keep the bracket for possible future use.
5. Carefully align the card's connectors and press firmly.
6. Secure the card on the slot with the screw you removed in step 4.
7. Replace the computer system's cover.
8. Edit the BIOS settings if necessary.  
(such as "IRQ xx Used By ISA: Yes" in PNP AND PCI SETUP)
9. Install the necessary software drivers for your expansion card.

### *Assigning IRQs for Expansion Cards*

Some expansion cards need to use an IRQ to operate. Generally an IRQ must be exclusively assigned to one use. In a standard design there are 16 IRQs available but most of them are already in use by parts of the system which leaves 6 free for expansion cards.

Both ISA and PCI expansion cards may need to use IRQs. System IRQs are available to cards installed in the ISA expansion bus first, and any remaining IRQs are then used by PCI cards. Currently, there are two types of ISA cards. The original ISA expansion card design, now referred to as "Legacy" ISA cards, requires that you configure the card's jumpers manually and then install it in any available slot on the ISA bus. You may use Microsoft's Diagnostic (MSD.EXE) utility included in the Windows directory to see a map of your used and free IRQs. For Windows 95 users, the "Control Panel" icon in "My Computer," contains a "System" icon which gives you a "Device Manager" tab. Double clicking on a specific device gives you the "Resources" tab, which shows the Interrupt number and address. Make sure that no two devices use the same IRQs or your computer will experience problems when those two devices are in use at the same time.

# III. INSTALLATION

---

To simplify this process this motherboard has complied with the Plug and Play (PNP) specification which was developed to allow automatic system configuration whenever a PNP-compliant card is added to the system. For PNP cards, IRQs are assigned automatically from those available.

If the system has both Legacy and PNP ISA cards installed, IRQs are assigned to PNP cards from those not used by Legacy cards. The PCI and PNP configuration of the BIOS setup utility can be used to indicate which IRQs are being used by Legacy cards. For older Legacy cards that does not work with the BIOS, you can contact your vendor for an ISA Configuration Utility.

An IRQ number is automatically assigned to PCI expansion cards after those used by Legacy and PNP ISA cards. In the PCI bus design, the BIOS automatically assigns an IRQ to a PCI slot that has a card in it that requires an IRQ. To install a PCI card, you need to set something called the INT (interrupt) assignment. Since all the PCI slots on this motherboard use an INTA #, be sure that the jumpers on your PCI cards are set to INT A.

## *Assigning DMA Channels for ISA Cards*

Some ISA cards, both legacy and PnP, may also need to use a DMA (Direct Memory Access) channel. DMA assignments for this motherboard are handled the same way as the IRQ assignment process described earlier. You can select a DMA channel in the PCI and PnP configuration section of the BIOS Setup utility.

**IMPORTANT:** To avoid conflicts, reserve the necessary IRQs and DMAs for legacy ISA cards (under PNP AND PCI SETUP of the BIOS SOFTWARE, choose *Yes* in *IRQ xx Used By ISA* and *DMA x Used By ISA* for those IRQs and DMAs you want to reserve).

## *ISA Cards and Hardware Monitor*

The onboard hardware monitor uses the address 290H-297H so legacy ISA cards must not use this address or else conflicts will occur.



# III. INSTALLATION

## 5. External Connectors

**WARNING!** Some pins are used for connectors or power sources. These are clearly separated from jumpers in “Map of the Motherboard.” Placing jumper caps over these will cause damage to your motherboard.

**IMPORTANT:** Ribbon cables should always be connected with the red stripe on the Pin 1 side of the connector. The four corners of the connectors are labeled on the motherboard. Pin 1 is the side closest to the power connector on hard drives and floppy drives. IDE ribbon cable must be less than 18in. (46cm), with the second drive connector no more than 6in. (15cm) from the first connector.

### 1. PS/2 Keyboard Connector (6-pin Female)

This connection is for a standard keyboard using an PS/2 plug (mini DIN). This connector will not allow standard AT size (large DIN) keyboard plugs. You may use a DIN to mini DIN adapter on standard AT keyboards.

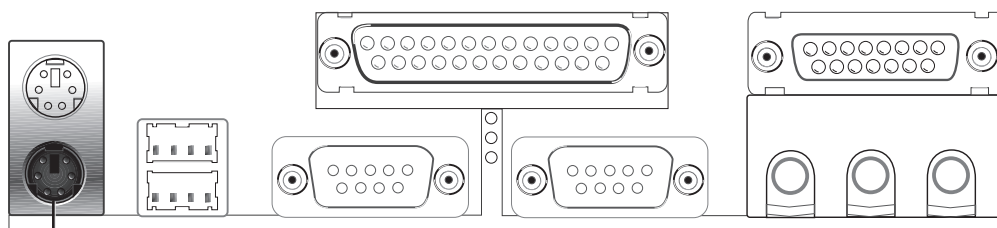

PS/2 Keyboard (6-pin Female)

### 2. PS/2 Mouse Connector (6-pin Female)

The system will direct IRQ12 to the PS/2 mouse if one is detected. If not detected, expansion cards can use IRQ12. See “PS/2 Mouse Control” in BIOS Features Setup of the BIOS SOFTWARE.

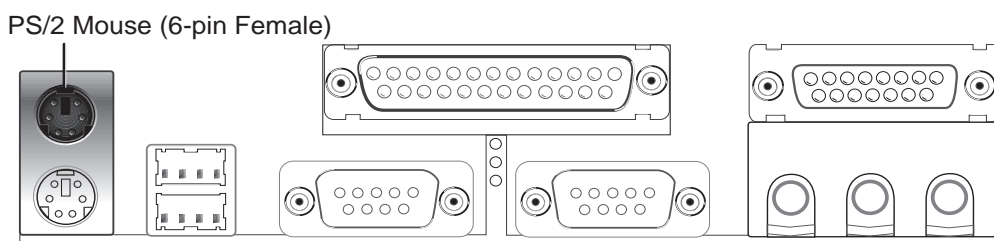

PS/2 Mouse (6-pin Female)

# III. INSTALLATION

## 3. Parallel Printer Connector (25-pin Female)

You can enable the parallel port and choose the IRQ through “Onboard Parallel Port” in Chipset Features Setup of the BIOS SOFTWARE. **NOTE:** Serial printers must be connected to the serial port.

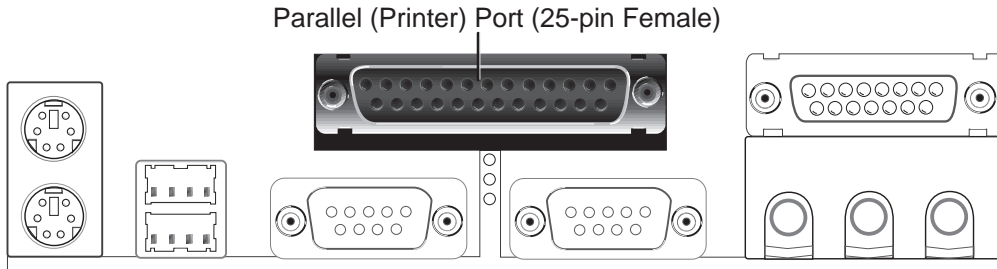

## 4. Serial Port COM1 and COM2 Connectors (Two 9-pin Male)

The two serial ports can be used for pointing devices or other serial devices. See “Onboard Serial Port” in Chipset Features Setup of the BIOS SOFTWARE.

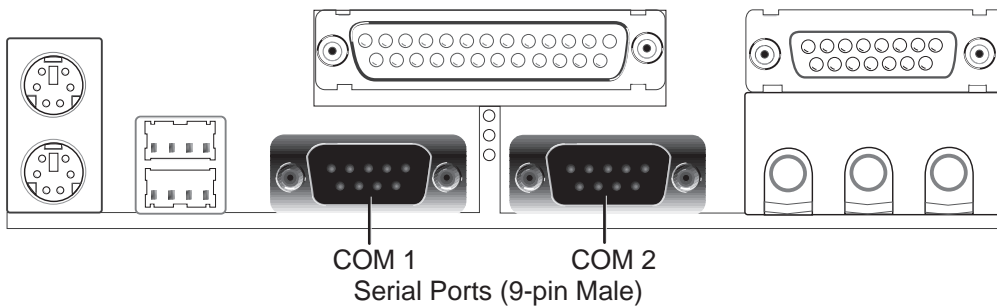

## 5. Floppy Disk Drive Connector (34-1pin FLOPPY)

This connector supports the provided floppy drive ribbon cable. After connecting the single end to the board, connect the two plugs on the other end to the floppy drives. **(Pin 5 is removed to prevent inserting in the wrong orientation when using ribbon cables with pin 5 plugged).**

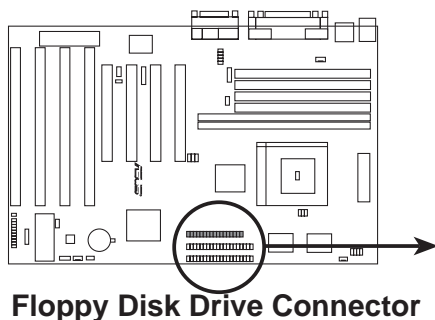

**NOTE:** Orient the red stripe to Pin 1

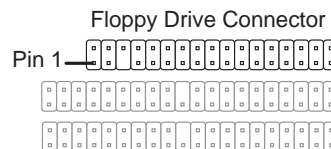

# III. INSTALLATION

- 6. Audio Port Connectors (Three 1/8" Female) (with optional onboard Audio)**  
**Line Out** can be connected to headphones or preferably powered speakers. **Line In** allows tape players or other audio sources to be recorded by your computer or played through the **Line Out**. **Mic** allows microphones to be connected for inputting voice.

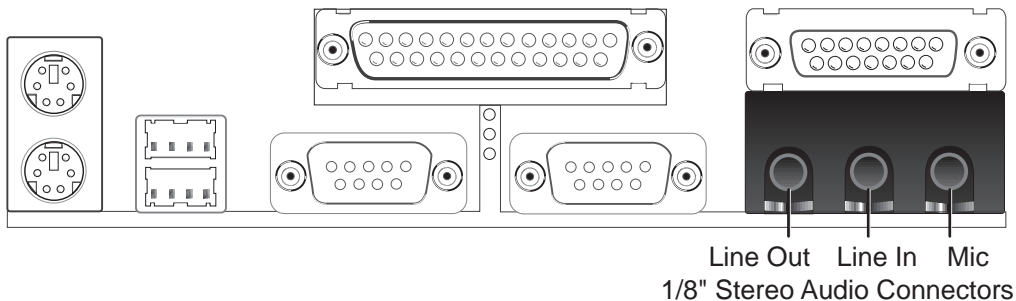

- 7. Joystick/Midi Connector (15-pin Female) (with optional onboard Audio)**  
You may connect game joysticks or game pads to this connector for playing games. Connect Midi devices for playing or editing audio.

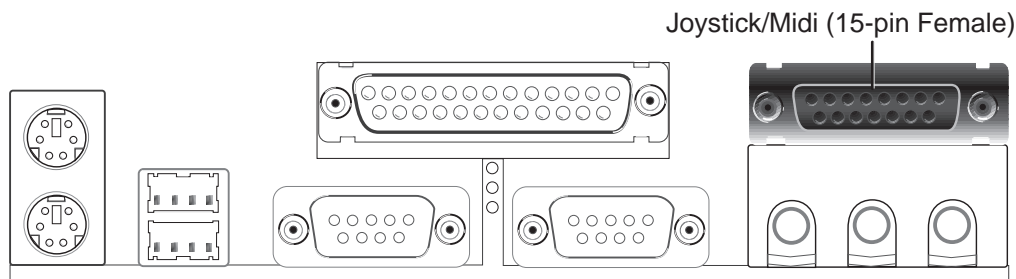

- 8. Universal Serial BUS Ports 1 & 2 (Two 4-pin Female Sockets)**  
Two USB ports are available for connecting USB devices.

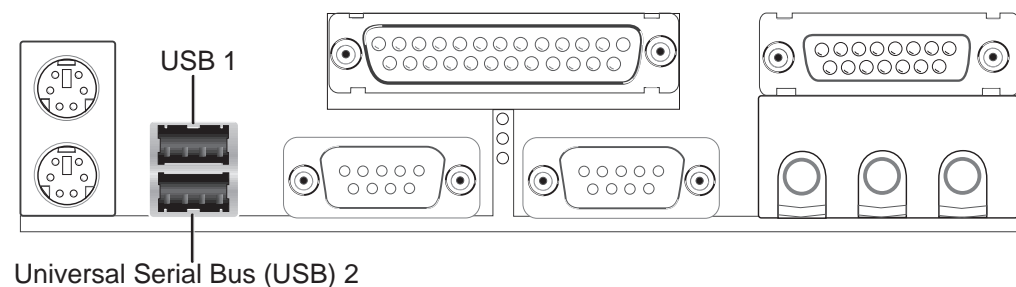

III. INSTALLATION  
Connectors

# III. INSTALLATION

## 9. Primary / Secondary IDE connectors (Two 40-1pin IDE)

These connectors support the provided IDE hard disk ribbon cable. After connecting the single end to the board, connect the two plugs at the other end to your hard disk(s). If you install two hard disks, you must configure the second drive to Slave mode by setting its jumper accordingly. Please refer to the documentation of your hard disk for the jumper settings. BIOS now supports SCSI device or IDE CD-ROM bootup (see “HDD Sequence SCSI/IDE First” & “Boot Sequence” in the **BIOS Features Setup** of the BIOS SOFTWARE) (**Pin 20 is removed to prevent inserting in the wrong orientation when using ribbon cables with pin 20 plugged**).

**TIP:** You may configure two hard disks to be both Masters using one ribbon cable on the primary IDE connector and another ribbon cable on the secondary IDE connector. You may install one operating system on an IDE drive and another on a SCSI drive and select the boot disk through BIOS Features Setup.

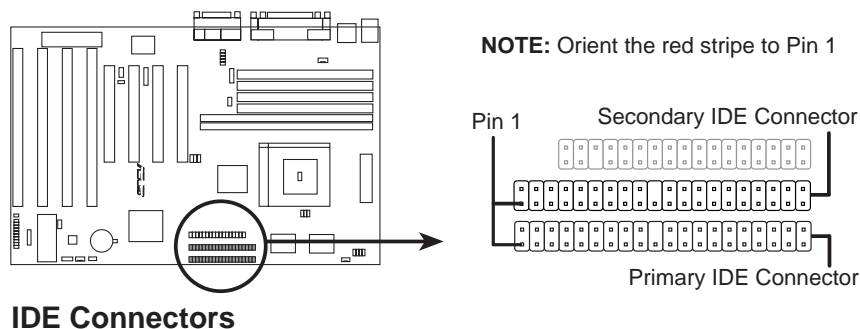

## 10. IDE activity LED (2-pin IDE\_LED)

This connector supplies power to the cabinet’s IDE activity LED. Read and write activity by devices connected to the Primary or Secondary IDE connectors will cause the LED to light up.

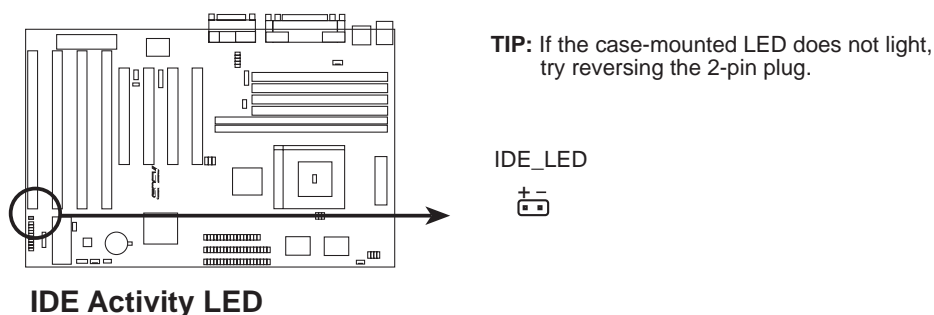

# III. INSTALLATION

## 11. Chassis , CPU , & Power Supply Fan Connectors (3-pin FANPWR)

These connectors support cooling fans of 500mAMP (6WATT) or less. Orientate the fans so that the heat sink fins allow airflow to go across the onboard heat sink(s) instead of the expansion slots. Depending on the fan manufacturer, the wiring and plug may be different. The red wire should be positive, while the black should be ground. Connect the fan's plug to the board taking into consideration the polarity of the this connector. **NOTE: The "Rotation" signal is to be used only by a specially designed fan with rotation signal.**

**WARNING!** The CPU and/or motherboard will overheat if there is no airflow across the CPU and onboard heatsinks. Damage may occur to the motherboard and/or the CPU fan if these pins are incorrectly used. **These are not jumpers, do not place jumper caps over these pins.**

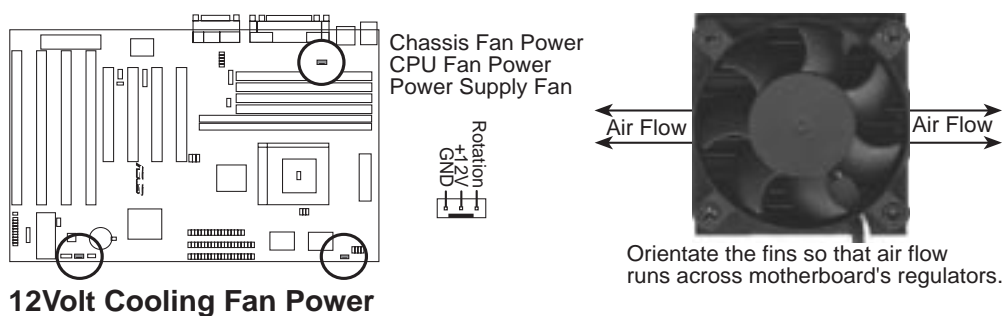

12Volt Cooling Fan Power

## 12. Chassis Open Alarm Lead (4-1pin CHASSIS)

This lead is for an open chassis monitor. A high level signal to the chassis signal lead will indicate to the system that the chassis has been opened. For the chassis open alarm feature to work, you must have the LM78 hardware monitor (optional) onboard and connect a sensor or switch to the connector. The +5V power comes from the power supply, when the A/C is connected.

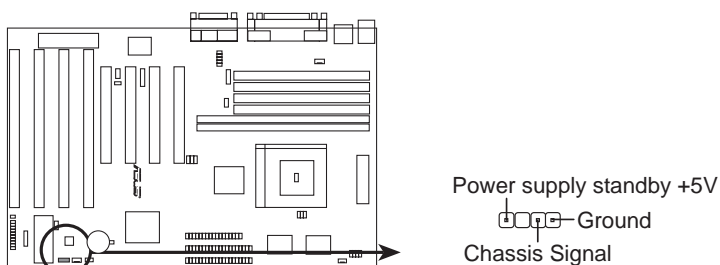

Chassis Open Alarm Lead

# III. INSTALLATION

## 13. IrDA / Fast IR-Compliant infrared module connector (5-pin IR)

This connector supports the optional wireless transmitting and receiving infrared module. This module mounts to a small opening on system cases that support this feature. You must also configure the setting through “UART2 Use Infrared” in **Chipset Features Setup** to select whether UART2 is directed for use with COM2 or IrDA. Use the five pins as shown on the Back View and connect a ribbon cable from the module to the motherboard according to the pin definitions.

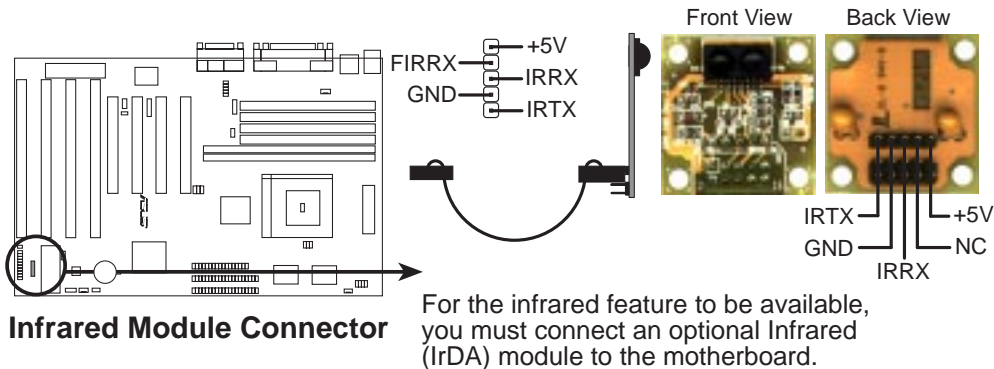

## 14. ATX Power Supply Connector (20-pin ATXPWR)

This connector connects to a ATX power supply. The plug from the power supply will only insert in one orientation because of the different hole sizes. Find the proper orientation and push down firmly making sure that the pins are aligned.

**IMPORTANT:** Be sure that the ATX power supply can take at least 10mAmp load on the 5volt standby lead (5VSB). You may experience difficulty in powering on your system without this.

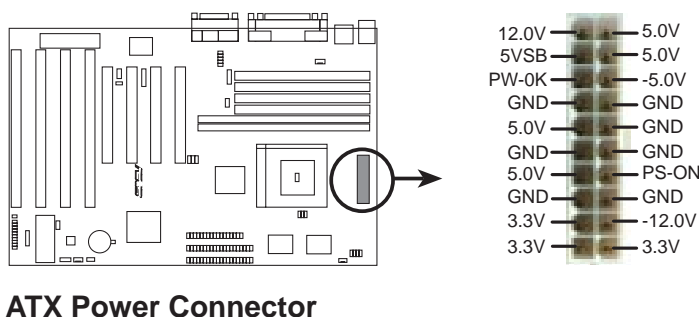

# III. INSTALLATION

## 15. Onboard Digital Audio Control (VOLCTL) (with optional onboard Audio)

This jumper allows you to adjust the audio volume digitally using case mounted momentary buttons.

### Audio Control

Volume Up

Volume Down

### VOLCTL

[1-2] (momentary)

[4-5] (momentary)

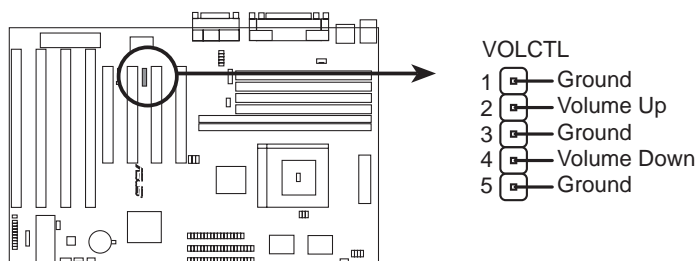

Onboard Digital Audio Control

## 16. Wake on LAN (3-pin WOL)

This connector connects to LAN cards with a Wake On LAN output. When the system is in soft-off mode, LAN activity will power on the system.

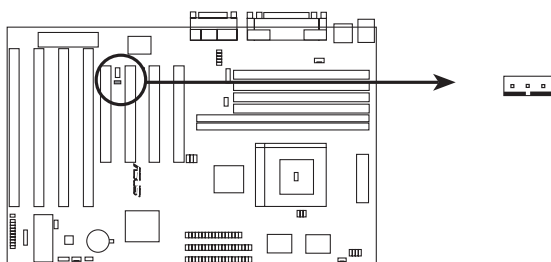

Wake On LAN Connector

# III. INSTALLATION

## 17. Message LED Lead (MSG LED)

This indicates whether a message has been received from a fax/modem. The LED will remain lit when there is no signal and blink when there is data transfer or waiting in the inbox). Requires ACPI OS support.

## 18. System Management Interrupt Lead (SMI)

This allows the user to manually place the system into a suspend mode or “Green” mode where system activity will be instantly decreased to save electricity and expand the life of certain components when the system is not in use. This 2-pin connector (see the figure below) connects to the case-mounted suspend switch. If you do not have a switch for the connector, you may use the “Turbo Switch” since it does not have a function. SMI is activated when it detects a *short to open* moment and therefore leaving it shorted will not cause any problems. May require one or two pushes depending on the position of the switch. Wake-up can be controlled by settings in the BIOS but the keyboard will always allow wake-up (the SMI lead cannot wake-up the system). If you want to use this connector, “Suspend Switch” in the **Power Management Setup** of the BIOS SOFTWARE section should be on the default setting of *Enable*.

## 19. ATX Power Switch / Soft Power Switch (PWR SW)

The system power is controlled by a momentary switch connected to this lead. Pushing the button once will switch the system between ON and SLEEP. Pushing the switch while in the ON mode for more than 4 seconds will turn the system off. The system power LED shows the status of the system’s power.

## 20. Reset Switch Lead (RESET)

This 2-pin connector connects to the case-mounted reset switch for rebooting your computer without having to turn off your power switch. This is a preferred method of rebooting in order to prolong the life of the system’s power supply.

## 21. System Power LED (PWR LED)

This 3-pin connector connects the system power LED, which lights when the system is powered on and blinks when it is in sleep mode.

## 22. Keyboard Lock Switch Lead (KEYLOCK)

This 2-pin connector connects to the case-mounted key switch to allow keyboard locking.

## 23. Speaker Connector (SPEAKER)

This 4-pin connector connects to the case-mounted speaker.

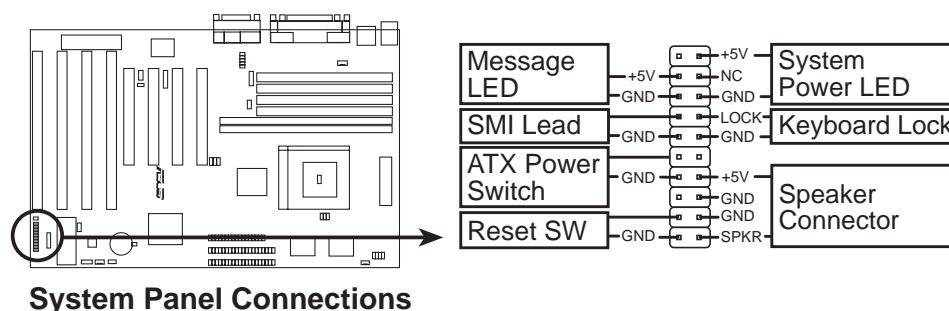



# III. INSTALLATION

---

## Power Connection Procedures

1. After all connections are made, close the system case cover.
  2. Be sure that all switches are off (in some systems, marked with ○).
  3. Connect the power supply cord into the power supply located on the back of your system case according to your system user's manual.
  4. Connect the power cord into a power outlet that is equipped with a surge protector.
  5. You may then turn on your devices in the following order:
    - a. Your monitor
    - b. External SCSI devices (starting with the last device on the chain)
    - c. Your system power. For ATX power supplies, you need to switch on the power supply as well as press the ATX power switch on the front of the case.
  6. The power LED on the front panel of the system case will light. For ATX power supplies, the system LED will light when the ATX power switch is pressed. The monitor LED may light up after the system's if it complies with "green" standards or if it has a power standby feature. The system will then run power-on tests. While the tests are running, additional messages will appear on the screen. If you do not see anything within 30 seconds from the time you turn on the power, the system may have failed a power-on test. Recheck your jumper settings and connections or call your retailer for assistance.
  7. During power-on, hold down <Delete> to enter BIOS setup. Follow the instructions in the next section, BIOS SOFTWARE.
- \* **Powering Off your computer:** You must first exit or shut down your operating system before switching off the power switch. For ATX power supplies, you can press the ATX power switch after exiting or shutting down your operating system. If you use Windows 95, click the **Start** button, click **Shut Down**, and then click **Shut down the computer?**. The system will give three quick beeps after about 30 seconds and then power off after Windows shuts down.

**NOTE:** The message "You can now safely turn off your computer" will not appear when shutting down with ATX power supplies.

# IV. BIOS SOFTWARE

## Support Software

**AFLASH.EXE:** This is the Flash Memory Writer utility that updates the BIOS by uploading a new BIOS file to the programmable flash ROM chip on the motherboard. To determine the BIOS version of your motherboard, check the last four numbers of the code displayed on the upper left-hand corner of your screen during bootup. Larger numbers represent a newer BIOS file. This file works only in DOS mode.

**NOTE:** The following screen displays are provided as examples only and may not reflect the screen contents displayed on your system.

## Flash Memory Writer Utility

```
ASUS ACPI BIOS
FLASH MEMORY WRITER V1.0
Copyright (C) 1994-98, ASUSTek COMPUTER INC.

Flash Memory: ATMEL AT29CB16A

Current BIOS Version: ASUS P2E-M ACPI BIOS Revision 1082
Chipset and Model   : I448EX-P2E-M
BIOS Built Date    : 04/21/98

Choose one of the followings:

1. Save Current BIOS To File
2. Update BIOS Including Boot Block and ESCD

Enter choice: [1]

Press ESC To Exit
```

**IMPORTANT!** If “unknown” is displayed after **Flash Memory:**, the memory chip is either not programmable or is not supported by the ACPI BIOS and therefore, cannot be programmed by the Flash Memory Writer utility.

### Main Menu

#### 1. Save Current BIOS To File

This option allows you to save a copy of the original motherboard BIOS in case you need to reinstall it. It is recommended that you save **AFLASH.EXE** and the BIOS file to a bootable floppy disk.

```
Save Current BIOS To File

Flash Memory: ATMEL AT29CB16A

Current BIOS Version: ASUS P2E-M ACPI BIOS Revision 1082
Chipset and Model   : I448EX-P2E-M
BIOS Built Date    : 04/21/98

Please Enter File Name to Save: A:\448XX-1
```

To save your current BIOS, type [1] at the **Main Menu** and then press <Enter>. The **Save Current BIOS To File** screen appears. Type a filename and the path, for example, **A:\XXXXX-1** and then press <Enter>.

# IV. BIOS SOFTWARE

## 2. Update BIOS Including Boot Block and ESCD

This option updates the boot block, the baseboard BIOS, and the ACPI extended system configuration data (ESCD) parameter block from a new BIOS file. See the next page for procedures on downloading an updated BIOS file.

To update your current BIOS, type [2] at the **Main Menu** and then press <Enter>. The **Update BIOS Including Boot Block and ESCD** screen appears. Type the filename of your new BIOS and the path, for example, **A:\XX2I1002.AWD**, and then press <Enter>.

When prompted to confirm the BIOS update, press **Y** to start the update.

The utility starts to program the new BIOS information into the flash ROM. When the programming is finished, *Flashed Successfully* will be displayed.

Follow the onscreen instructions to continue.

```
Update BIOS Including Boot Block and ESCD
Flash Memory: ATMEL AT29CB10A
Current BIOS Version: ASUS P2E-M ACPI BIOS Revision 1002
Chipset and Model : I440EX-P2E-M
BIOS Built Date : 04/21/98
Please Enter File Name for NEW BIOS: 1002EM.000
```

```
Update BIOS Including Boot Block and ESCD
Flash Memory: ATMEL AT29CB10A
BIOS Version
[ CURRENT ] ASUS P2E-M ACPI BIOS Revision 1002
[ 1002EM.000 ] ASUS P2E-M ACPI BIOS Revision 1002
Chipset and Model
[ CURRENT ] I440EX-P2E-M
[ 1002EM.000 ] I440EX-P2E-M
Date of BIOS Built
[ CURRENT ] 04/21/98
[ 1002EM.000 ] 04/27/98
Are you sure (Y/N) ? [Y]
Press ESC To Return to Main Menu
```

```
Update BIOS Including Boot Block and ESCD
Flash Memory: ATMEL AT29CB10A
BIOS Version
[ CURRENT ] ASUS P2E-M ACPI BIOS Revision 1002
[ 1002EM.000 ] ASUS P2E-M ACPI BIOS Revision 1002
Chipset and Model
[ CURRENT ] I440EX-P2E-M
[ 1002EM.000 ] I440EX-P2E-M
Date of BIOS Built
[ CURRENT ] 04/21/98
[ 1002EM.000 ] 04/27/98
Programming -- 1FFFF
Flashed Successfully
Press ESC To Continue
```

```
ASUS ACPI BIOS
FLASH MEMORY WRITER V1.0
Copyright (C) 1994-98, ASUSTek COMPUTER INC.
Flash Memory: ATMEL AT29CB10A
Current BIOS Version: ASUS P2E-M ACPI BIOS Revision 1002
Chipset and Model : I440EX-P2E-M
BIOS Built Date : 04/21/98
Choose one of the followings:
1. Save Current BIOS To File
2. Update BIOS Including Boot Block and ESCD
Enter choice: [1]
You have flashed the EPROM: It is recommended that you turn off
the power, enter SETUP and LOAD Setup Defaults to have CMOS
updated with new BIOS when exits.
Press ESC To Exit
```

# IV. BIOS SOFTWARE

---

## Managing and Updating Your Motherboard's BIOS

### Upon First Use of the Computer System

1. Create a bootable system floppy disk by typing [FORMAT A:/S] from the DOS prompt without creating "AUTOEXEC.BAT" and "CONFIG.SYS" files.
2. Copy AFLASH.EXE to the just created boot disk.
3. Run AFLASH.EXE from this new disk and select option **1. Save Current BIOS to File**. See **1. Save Current BIOS To File** on the previous page for more details and the rest of the steps.

### Updating BIOS Procedures (only when necessary)

1. Download an updated ASUS BIOS file from the Internet (WWW or FTP) or a BBS (Bulletin Board Service) (see ASUS CONTACT INFORMATION on page 3 for details) and save to the disk you created earlier.
2. Boot from the disk you created earlier.
3. At the "A:\>" prompt, type **AFLASH** and then press <Enter>.
4. At the **Main Menu**, type **2** and then press <Enter>. See **2. Update BIOS Including Boot Block and ESCD** on the previous page for more details and the rest of the steps.

**WARNING!** If you encounter problems while updating the new BIOS, DO NOT turn off your system since this might prevent your system from booting up. Just repeat the process, and if the problem still persists, update the original BIOS file you saved to disk above. If the Flash Memory Writer utility was not able to successfully update a complete BIOS file, your system may not be able to boot up. If this happens, your system will need service.

# IV. BIOS SOFTWARE

## 6. BIOS Setup

The motherboard supports two programmable Flash ROM chips: 5 Volt and 12 Volt. Either of these memory chips can be updated when BIOS upgrades are released. Use the Flash Memory Writer utility to download the new BIOS file into the ROM chip as described in detail in this section.

All computer motherboards provide a Setup utility program for specifying the system configuration and settings. If your motherboard came in a computer system, the proper configuration entries may have already been made. If so, invoke the Setup utility, as described later, and take note of the configuration settings for future reference; in particular, the hard disk specifications.

If you are installing the motherboard, reconfiguring your system or you receive a Run Setup message, you will need to enter new setup information. This section describes how to configure your system using this utility.

The BIOS ROM of the system stores the Setup utility. When you turn on the computer, the system provides you with the opportunity to run this program. This appears during the Power-On Self Test (POST). Press <Delete> to call up the Setup utility. If you are a little bit late pressing the mentioned key(s), POST will continue with its test routines, thus preventing you from calling up Setup. If you still need to call Setup, reset the system by pressing <Ctrl> + <Alt> + <Delete>, or by pressing the Reset button on the system case. You can also restart by turning the system off and then back on again. But do so only if the first two methods fail.

When you invoke Setup, the CMOS SETUP UTILITY main program screen will appear with the following options:



# IV. BIOS SOFTWARE

## Load Defaults

The **Load BIOS Defaults** option loads the minimum settings for troubleshooting. **Load Setup Defaults**, on the other hand, is for loading optimized defaults for regular use. Choosing defaults at this level will modify all applicable settings.

A section at the bottom of the preceding screen displays the control keys for this screen. Take note of these keys and their respective uses.

## Standard CMOS Setup

**Standard CMOS Setup** allows you to record some basic system hardware configuration and set the system clock and error handling. If the motherboard is already installed in a working system, you will not need to select this option anymore. However, if the configuration stored in the CMOS memory on the board gets lost or damaged, or if you change your system hardware configuration, you will need to respecify the configuration values. The configuration values usually get lost or corrupted when the power of the onboard CMOS battery weakens.



The preceding screen provides you with a list of options. At the bottom of this screen are the control keys. Take note of these keys and their respective uses.

User-configurable fields appear in a different color. If you need information on the selected field, press <F1>. The help menu will then appear to provide you with the information you need. The memory display at the lower right of the screen is read-only and automatically adjusts accordingly.

### Details of Standard CMOS Setup:

#### Date

To set the date, highlight the “Date” field and then press either <Page Up>/<Page Down> or <+>/<-> to set the current date. Follow the month, day and year format. Valid values for month, day and year are: **Month: (1 to 12), Day: (1 to 31), Year: (up to 2079)**

## IV. BIOS SOFTWARE

---

### Time

To set the time, highlight the “Time” field and then press either <Page Up>/<Page Down> or <+>/<-> to set the current time. Follow the hour, minute and second format. Valid values for hour, minute and second are: **(Hour: (00 to 23), Minute: (00 to 59), Second: (00 to 59)**. If you do not want to modify the current time, press <Enter> three times to go to **Hard Disks**.

**NOTE:** You can bypass the date and time prompts by creating an AUTOEXEC.BAT file. For information on how to create this file, refer to the MS-DOS manual.

### Hard Disk Drives

This field records the specifications for all non-SCSI hard disk drives installed in your system. The onboard PCI IDE connectors provide Primary and Secondary channels for connecting up to four IDE hard disks or other IDE devices. Each channel can support up to two hard disks; the first of which is the “master” and the second is the “slave”.

Specifications for SCSI hard disks need not to be entered here since they operate using device drivers and are not supported by any the BIOS. If you install either the optional PCI-SC200 or PCI-SC860 SCSI controller card into the motherboard, see section VI for instructions. If you install other vendor’s SCSI controller card, refer to their respective documentations on how to install the required SCSI drivers.

### For IDE hard disk drive setup, you can:

- Use the *Auto* setting for detection during bootup.
- Use the IDE HDD AUTO DETECTION in the main menu to automatically enter the drive specifications.
- Enter the specifications yourself manually by using the “User” option.

The entries for specifying the hard disk type include **CYLS** (number of cylinders), **HEAD** (number of read/write heads), **PRECOMP** (write precompensation), **LANDZ** (landing zone), **SECTOR** (number of sectors) and **MODE**. The **SIZE** field automatically adjusts according to the configuration you specify. The documentation that comes with your hard disk should provide you with the information regarding the drive specifications.

The **MODE** entry is for IDE hard disks only, and can be ignored for MFM and ESDI drives. This entry provides three options: *Normal*, *Large*, *LBA*, or *Auto* (see below). Set **MODE** to the *Normal* for IDE hard disk drives smaller than 528MB; set it to *LBA* for drives over 528MB that support Logical Block Addressing (LBA) to allow larger IDE hard disks; set it to *Large* for drives over 528MB that do not support LBA. *Large* type of drive can only be used with MS-DOS and is very uncommon. Most IDE drives over 528MB support the *LBA* mode.

## IV. BIOS SOFTWARE

---

### **Auto detection of hard disks on bootup**

For each field: Primary Master, Primary Slave, Secondary Master, and Secondary Slave, you can select *Auto* under the TYPE and MODE fields. This will enable auto detection of your IDE hard disk during bootup. This will allow you to change your hard disks (with the power off) and then power on without having to reconfigure your hard disk type. If you use older hard disks that do not support this feature, then you must configure the hard disk in the standard method as described earlier by the “User” option.

**NOTE:** After the IDE hard disk drive information has been entered into BIOS, new IDE hard disk drives must be partitioned (such as with FDISK) and then formatted before data can be read from and write on. Primary IDE hard disk drives must have its partition set to *active* (also possible with FDISK).

**NOTE:** SETUP Defaults are noted in parenthesis next to each function heading.

### **Drive A / Drive B (None)**

These fields record the types of floppy disk drives installed in your system. The available options for drives A and B are: *360KB, 5.25 in.; 1.2MB, 5.25 in.; 720KB, 3.5 in.; 1.44MB, 3.5 in.; 2.88MB, 3.5 in.; None*

To enter the configuration value for a particular drive, highlight its corresponding field and then select the drive type using the left- or right-arrow keys.

### **Floppy 3 Mode Support (Disabled)**

This is the Japanese standard floppy drive. The standard stores 1.2MB in a 3.5inch diskette. This is normally disabled but you may choose from either: *Drive A, Drive B, Both, and Disabled*

### **Video (EGA/VGA)**

Set this field to the type of video display card installed in your system. The options are *EGA/VGA, CGA 49, CGA 80, and Mono* (for Hercules or MDA).

If you are using a VGA or any higher resolution card, choose *EGA/VGA*.

### **Halt On (All Errors)**

This field determines which types of errors will cause the system to halt. Choose from *All Errors; No Errors; All,But Keyboard, All,But Diskette; and All,But Disk/Key*.



# IV. BIOS SOFTWARE

## BIOS Features Setup

**BIOS Features Setup** consists of configuration entries that allow you to improve your system performance, or let you set up some system features according to your preference. Some entries are required by the motherboard's design to remain in their default settings.



A section at the lower right of the screen displays the control keys you can use. Take note of these keys and their respective uses. If you need information on a particular entry, highlight it and then press <F1>. A pop-up help menu will appear to provide you with the information you need. <F5> loads the last set values, <F6> and <F7> loads the BIOS default values and Setup default values, respectively.

**NOTE:** SETUP Defaults are noted in parenthesis next to each function heading.

### Details of BIOS Features Setup

#### Virus Warning (Disabled)

This field protects the boot sector and partition table of your hard disk against accidental modifications. Any attempt to write to them will cause the system to halt and display a warning message. If this occurs, you can either allow the operation to continue or use a bootable virus-free floppy disk to reboot and investigate your system. This setting is recommended because of conflicts with new operating systems or some programs. Installation of these programs requires that you disable *Virus Warning* to prevent write errors.

#### CPU Internal Cache (Enabled)

Choose *Disable* to turn off the CPU's built-in level 1 cache.

#### External Cache (Enabled)

Choose *Disable* to turn off the CPU's external level 2 cache (Pentium Pro is built-in).

#### Quick Power On Self Test (Enabled)

This field speeds up the Power-On Self Test (POST) routine by skipping retesting a second, third, and fourth time. Setup default setting for this field is *Enabled*. A complete test of the system is done on each test.

# IV. BIOS SOFTWARE

---

## **HDD Sequence SCSI/IDE First (IDE)**

When using both SCSI and IDE hard disk drives, IDE is always the boot disk using drive letter C (default setting of *IDE*). This new feature allows a SCSI hard disk drive to be the boot disk when set to *SCSI*. This allows multiple operating systems to be used on both IDE and SCSI drives or the primary operating system to boot using a SCSI hard disk drive.

## **Boot Sequence (C,A)**

This field determines where the system looks first for an operating system. Options are *C,A*; *A,CDROM,C*; *CDROM,C,A*; *D,A*; *E,A*; *F,A*; *C only*; *LS/ZIP, C*; and *A,C*. The setup default setting is to check first the hard disk and then the floppy disk drive; that is, *C, A*.

## **Boot Up Floppy Seek (Disabled)**

When enabled, the BIOS will seek drive A one time.

## **Floppy Disk Access Control (R/W)**

This allows protection of files from the computer system to be copied to floppy disk drives by allowing the setting of *Read Only* to only allow reads from the floppy disk drive but not writes. The setup default *R/W* allows both reads and writes.

## **IDE HDD Block Mode Sectors (HDD MAX)**

This field enhances hard disk performance by making multi-sector transfers instead of one sector per transfer. Most IDE drives, except older versions, can utilize this feature. Selections are *HDD MAX*, *Disabled*, *2*, *4*, *8*, *16*, and *32*.

## **Security Option (System)**

This field determines when the system prompts for the password. The default setting is *System*, where the system prompts for the User Password every time you boot up. The other option is *Setup*, where the system always boots up, and prompts for the Supervisor Password only when the Setup utility is called up. You can specify a password by using the *Supervisor Password* or *User Password* option from the main screen as explained later in this section.

## **PS/2 Mouse Function Control (Auto)**

The default of *Auto* allows the system to detect a PS/2 mouse on bootup. If detected, IRQ12 will be used for the PS/2 mouse. IRQ12 will be reserved for expansion cards if a PS/2 mouse is not detected. *Enabled* will reserve IRQ12 for the PS/2 mouse, and thus other devices will not be able to use IRQ12.

## **PCI/VGA Palette Snoop (Disabled)**

Some display cards that are nonstandard VGA such as graphics accelerators or MPEG Video Cards may not show colors properly. The setting *Enabled* should correct this problem. Otherwise leave this on the setup default setting of *Disabled*.

## **OS/2 Onboard Memory > 64M (Disabled)**

When using OS/2 operating systems with installed DRAM of greater than 64MB, you need to *Enable* this option otherwise leave this on the setup default of *Disabled*.

.....

# IV. BIOS SOFTWARE

---

## **Video ROM BIOS Shadow (Enabled)**

This field allows you to change the video BIOS location from ROM to RAM. Relocating to RAM enhances system performance, as information access is faster than the ROM.

## **C8000 - CBFFF Shadow to DC000 - DFFFF Shadow (Disabled)**

These fields are used for shadowing other expansion card ROMs. If you install other expansion cards with ROMs on them, you will need to know which addresses the ROMs use to shadow them specifically. Shadowing a ROM reduces the memory available between 640KB and 1024KB by the amount used for this purpose.

## **Boot Up NumLock Status (On)**

This field enables users to activate the Number Lock function upon system boot.

## **Typematic Rate Setting (Disabled)**

When enabled, you can set the two typematic controls listed next. Setup default setting is *Disabled*.

## **Typematic Rate (Chars/Sec) (6)**

This field controls the speed at which the system registers repeated keystrokes. Options range from 6 to 30 characters per second. Setup default setting is **6**; other settings are **8, 10, 12, 15, 20, 24, and 30**.

## **Typematic Delay (Msec) (250)**

This field sets the time interval for displaying the first and second characters. Four delay rate options are available: 250, 500, 750, and 1000.

# IV. BIOS SOFTWARE

## Chipset Features Setup

The “Chipset Features Setup” option controls the configuration of the board’s chipset. Control keys for this screen are the same as in the **BIOS Features Setup** screen.



**NOTE:** SETUP Defaults are noted in parenthesis next to each function heading.

### Details of Chipset Features Setup

#### Auto Configuration (60ns DRAM)

The default setting of *60ns DRAM* sets the optimal timings for items 2 through 9 for 60ns DRAM modules. If you are using 70ns DRAM modules, you must change this item to *70ns DRAM*. See section III for DRAM installation information.

#### SDRAM CAS# Latency (3T)

If you use ASUS SDRAM DIMM modules, you can set this to *2T* for better performance, otherwise leave on default or check with your vendor for DIMM specs.

#### SDRAM Speculative Read (Disabled)

If *Enabled*, the CPU will issue predict commands to access the DRAM, if a miss occurs, the CPU will cancel this command. Some operating systems under certain situations have a problem utilizing this feature so it is normally *Disabled*.

#### Passive Release (Enabled)

This is a mechanism that allows concurrency of ISA/EISA cycles and CPU-to-PCI cycles. When this feature is enabled, the TXC will be possible to re-arbitrate PCI bus and allow the CPU to access PCI even when the PCEB has been granted the bus.

#### Delayed Transaction (Disabled)

If *Enabled*, this frees the PCI Bus during CPU accessing of 8-bit ISA cards which normally consume about 50-60 PCI Clocks without PCI delayed transaction. If PCI Bus Masters cannot use the PCI Bus, leave this on the default setting of *Disabled* for some ISA cards that are not PCI 2.1 compliant.

#### 16-bit I/O Recovery Time (1 BUSCLK)

Timing for 16-bit ISA cards.

## IV. BIOS SOFTWARE

---

### **8-bit I/O Recovery Time (1 BUSCLK)**

Timing for 8-bit ISA cards.

### **Video BIOS Cacheable (Enabled)**

Allows the Video BIOS to be cached to allow faster execution. Leave on default setting of *Enabled* for better performance, otherwise *Disabled*.

### **Memory Hole At Address (None)**

This feature reserves either *14MB-16MB* or *15MB-16MB* memory address space to ISA expansion cards that specifically require this setting. Memory from 14MB and up or 15MB and up will be unavailable to the system because expansion cards can only access memory up to 16MB.

.....

### **Onboard FDC Controller (Enabled)**

When enabled, this field allows you to connect your floppy disk drives to the on-board floppy drive connector instead of a separate controller card. If you want to use a different controller card to connect the floppy drives, set this field to *Disabled*.

### **Onboard FDC Swap A & B (No Swap)**

This field allows you to reverse the hardware drive letter assignments of your floppy disk drives. Two options are available: *Swap AB* and *No Swap* (default). If you want to switch drive letter assignments, set this field to *Swap AB*, and the swap will be controlled by the onboard chipset.

### **Onboard Serial Port 1 (3F8H/IRQ4)**

Settings are *3F8H/IRQ4*, *2F8H/IRQ3*, *3E8H/IRQ4*, *2E8H/IRQ10*, and *Disabled* for the onboard serial connector.

### **Onboard Serial Port 2 (2F8H/IRQ3)**

Settings are *3F8H/IRQ4*, *2F8H/IRQ3*, *3E8H/IRQ4*, *2E8H/IRQ10*, and *Disabled* for the onboard serial connector.

### **Onboard Parallel Port (378H/IRQ7)**

This field sets the address of the onboard parallel port connector. You can select either *3BCH/IRQ7*, *378H/IRQ7*, *278H/IRQ5*, or *Disabled*. If you install an I/O card with a parallel port, ensure that there is no conflict in the address assignments. The PC can support up to three parallel ports as long as there are no conflicts for each port.

### **Parallel Port Mode (ECP+EPP)**

This field allows you to set the operation mode of the parallel port. The setting *Normal*, allows normal-speed operation but in one direction only; *EPP* allows bidirectional parallel port operation at maximum speed; *ECP* allows the parallel port to operate in bidirectional mode and at a speed faster than the maximum unidirectional data transfer rate; *ECP+EPP* allows normal speed operation in a two-way mode.

### **ECP DMA Select (3)**

This selection is available only if you select *ECP* or *ECP+EPP* in the **Parallel Port Mode**. Select either DMA Channel *1*, *3*, or *Disabled*.

## IV. BIOS SOFTWARE

---

### **UART2 Use Infrared (Disabled)**

When enabled, this field activates the onboard infrared feature and sets the second serial UART to support the infrared module connector on the motherboard. If your system already has a second serial port connected to the onboard COM2 connector, it will no longer work if you enable the infrared feature. By default, this field is set to *Disabled*, which leaves the second serial port UART to support the COM2 serial port connector.

### **Onboard PCI IDE Enable (Both)**

You can select to enable the *Primary* IDE channel, *Secondary* IDE channel, *Both*, or *Disable* both channels (for systems with only SCSI drives).

### **IDE Ultra DMA Mode (Auto)**

This sets the IDE UltraDMA to be active when using UltraDMA-capable IDE devices. The BIOS will automatically adjust or disable this setting for slower IDE devices so that Auto or high settings will not cause problems for older IDE devices. Choose *Disable* if you do not want this feature for all devices.

### **IDE 0 Master/Slave PIO/DMA Mode, IDE 1 Master/Slave PIO/DMA Mode (Auto)**

Each channel (0 and 1) has both a master and a slave making four IDE devices possible. Because each IDE device may have a different Mode timing (0, 1, 2, 3, 4), it is necessary for these to be independent. PIO and DMA timings can be independently set. The default setting of *Auto* will allow autodetection to ensure optimal performance.

# IV. BIOS SOFTWARE

## Power Management Setup

The “Power Management Setup” option allows you to reduce power consumption. This feature turns off the video display and shuts down the hard disk after a period of inactivity.



**NOTE:** SETUP Defaults are noted in parenthesis next to each function heading.

### Details of Power Management Setup

#### Power Management (User Define)

This field acts as the master control for the power management modes. *User Define* allows you to set power saving options according to your preference; *Disable* disables the power saving features; *Min Saving* puts the system into power saving mode after 40 min of system inactivity; *Max Saving* puts the system into power saving mode after 30 sec of system inactivity.

**IMPORTANT:** Advanced Power Management (APM) should be installed to keep the system time updated when the computer enters suspend mode activated by the BIOS Power Management. For DOS environments, you need to add `DEVICE=C:\DOS\POWER.EXE` in your `CONFIG.SYS`. For Windows 3.x and Windows 95, you need to install Windows with the APM feature. A battery and power cord icon labeled “Power” will appear in the “Control Panel.” Choose “Advanced” in the Power Management Field.

#### Video Off Option (Susp,Stby -> Off )

This field determines when to activate the video off feature for monitor power management. The settings are *Susp,Stby -> Off* (default); *All Modes -> Off*; *Always On*; and *Suspend -> Off*.

# IV. BIOS SOFTWARE

---

## **Video Off Method (DPMS OFF)**

This field defines the video off features. These options are available: *DPMS OFF*, *DPMS Reduce ON*, *Blank Screen*, *V/H SYNC+Blank*, *DPMS Standby*, and *DPMS Suspend*. The DPMS (Display Power Management System) features allow the BIOS to control the video display card if it supports the DPMS feature. *Blank Screen* only blanks the screen (or monitors without power management or “green” features). If set up in your system, your screen saver will not display with *Blank Screen* selected). *V/H SYNC+Blank* blanks the screen and turns off vertical and horizontal scanning.

.....

## **PM Timers**

This section controls the time-out settings for the Power Management scheme. The fields included in this section are **HDD Power Down**, which places the hard disk into its lowest power consumption mode, and the **Doze**, **Standby** and **Suspend** system inactivation modes.

The system automatically “wakes up” from any power saving mode when there is system activity, such as when a key is pressed from the keyboard, or when there is activity detected from the enabled IRQ channels.

## **HDD Power Down (Disable)**

This field shuts down any IDE hard disk drives in the system after a period of inactivity. This time period is user-configurable to *1-15 Mins* or *Disable*. This feature does not affect SCSI hard disks.

## **Doze Mode, Standby Mode, Suspend Mode (Disable)**

These fields set the period of time after which each of these modes activate: *30 Sec*, *1 Min*, *2 Min*, *4 Min*, *8 Min*, *20 Min*, *30 Min*, *40 Min*, *1 Hour*, and *Disable*.

.....

## **Power Up Control**

This section determines the ways the system can be controlled when it is started or restarted, when modem activity is detected, or when power to the computer is interrupted and reapplied. The Soft-Off mode refers to powering off the system through a momentary button switch (ATX switch) or through the software as opposed to disconnecting the AC power by way of a rocker switch or other means.

## **PWR Button < 4 Secs (Soft Off)**

When set to *Soft Off*, the ATX switch can be used as a normal system power-off button when pressed for less than 4 seconds. *Suspend* allows the button to have a dual function where pressing less than 4 seconds will place the system in sleep mode. *No Function* disables the ATX switch function when the button is pressed under 4 seconds. Regardless of the setting, holding the ATX switch for more than 4 seconds will power off the system.



## IV. BIOS SOFTWARE

---

### **PWR Up On Modem Act (Enabled)**

This field allows either settings of *Enabled* (default) or *Disabled* for powering up the computer (turns the ATX power supply on) when the modem begins receiving or transmitting data while the computer is off.

### **AC PWR Loss Restart (Disabled)**

This field allows you to set whether you want your system to boot up after the power has been interrupted. *Disabled* leaves your system off after reapplying power and *Enabled* boots up your system after replying power.

### **Automatic Power Up (Disabled)**

This field allows you to have an unattended or automatic power up of your system. You may configure your system to power up at a certain time of the day by selecting *Everyday*, which will allow you to set the time or at a certain time and day by selecting *By Date*.

.....

### **Fan Monitor (xxxxRPM)**

The onboard hardware monitor can detect the Chassis Fan Speed, CPU Fan Speed, and the Power Supply Fan Speed in Rotations Per Minute (RPM). These values refresh upon any key entries in the BIOS setup screen. Set to *Ignore* if one of these are not used so that error messages will not be given.

### **Thermal Monitor (xxxC/xxxF)**

The onboard hardware monitor can detect the CPU and MB (motherboard) Temperatures. These values refresh upon key entries. Set to *Ignore* only if necessary.

### **Voltage Monitor (xx.xV)**

The onboard hardware monitor can detect the voltages put out by the voltage regulators. These values refresh upon key entries. Set to *Ignore* only if necessary.

**NOTE:** If any of the monitored items are out of range, you will be prompted by this message: “Hardware Monitor found an error, enter POWER MANAGEMENT SETUP for details”. The bottom of the screen will instruct you to “Press **F1** to continue, **DEL** to enter SETUP”

# IV. BIOS SOFTWARE

## PNP and PCI Setup

The “PNP and PCI Setup” option configures the PCI bus slots. All PCI bus slots on the system use INTA#, thus all installed PCI cards must be set to this value.



**NOTE:** SETUP Defaults are noted in parenthesis next to each function heading.

### Details of PNP and PCI Setup

#### PNP OS Installed (No)

This field allows you to use a Plug-and-Play (PnP) operating system to configure the PCI bus slots instead of using the BIOS. Thus interrupts may be reassigned by the OS when *Yes* is selected. When a non-PnP OS is installed or to prevent reassigning of interrupt settings, select the default setting of *No*.

#### Slot 1 (RIGHT) IRQ to Slot 4 (LEFT) IRQ (Auto)

These fields set how IRQ use is determined for each PCI slot. The default setting for each field is *Auto*, which uses auto-routing to determine IRQ use. The other options are manual settings of *NA*, *5*, *7*, *9*, *10*, *11*, *12*, *14* or *15* for each slot.

#### PCI Latency Timer (32 PCI Clock)

The default setting of *32 PCI Clock* enables maximum PCI performance for this motherboard.

#### IRQ xx Used By ISA (No/ICU)

These fields indicate whether or not the displayed IRQ for each field is being used by a legacy (non-PnP) ISA card. Two options are available: *No/ICU* and *Yes*. The first option, the default value, indicates either that the displayed IRQ is not used or an ISA Configuration Utility (ICU) is being used to determine if an ISA card is using that IRQ. If you install a legacy ISA card that requires a unique IRQ, and you are not using an ICU, you must set the field for that IRQ to *Yes*. For example: If you install a legacy ISA card that requires IRQ 10, then set **IRQ10 Used By ISA** to *Yes*.

.....

## IV. BIOS SOFTWARE

---

### **DMA x Used By ISA (No/ICU)**

These fields indicate whether or not the displayed DMA channel for each field is being used by a legacy (non-PnP) ISA card. Available options include: *No/ICU* and *Yes*. The first option, the default setting, indicates either that the displayed DMA channel is not used or an ICU is being used to determine if an ISA card is using that channel. If you install a legacy ISA card that requires a unique DMA channel, and you are not using an ICU, you must set the field for that channel to *Yes*.

### **ISA MEM Block BASE (No/ICU)**

This field allows you to set the base address and block size of a legacy ISA card that uses any memory segment within the C800H and DFFFH address range. If you have such a card, and you are not using an ICU to specify its address range, select a base address from the six available options; the **ISA MEM Block SIZE** field will then appear for selecting the block size. If you have more than one legacy ISA card in your system that requires to use this address range, you can increase the block size to either 8K, 16K, 36K, or 64K. If you are using an ICU to accomplish this task, leave **ISA MEM Block BASE** to its default setting of *No/ICU*.

### **SYMBIOS SCSI BIOS (Auto)**

The default uses *Auto* settings for the onboard SCSI BIOS. If you do not want to use the onboard SCSI BIOS, choose *Disabled*.

# IV. BIOS SOFTWARE

## Load BIOS Defaults

The “Load BIOS Defaults” option allows you to load the troubleshooting default values permanently stored in the BIOS ROM. These default settings are non-optimal and disable all high performance features. To load these default settings, highlight “Load BIOS Defaults” on the main screen and then press <Enter>. The system displays a confirmation message on the screen. Press <Y> and then <Enter> to confirm. Press <N> and then <Enter> to abort. This feature does not affect the fields on the Standard CMOS Setup screen.

## Load Setup Defaults

The “Load Setup Defaults” option allows you to load the default values to the system configuration fields. These default values are the optimized configuration settings for the system. To load these default values, highlight “Load Setup Defaults” on the main screen and then press <Enter>. The system displays a confirmation message on the screen. Press <Y> and then <Enter> to confirm. Press <N> and then <Enter> to abort. This feature does not affect the fields on the Standard CMOS Setup screen.

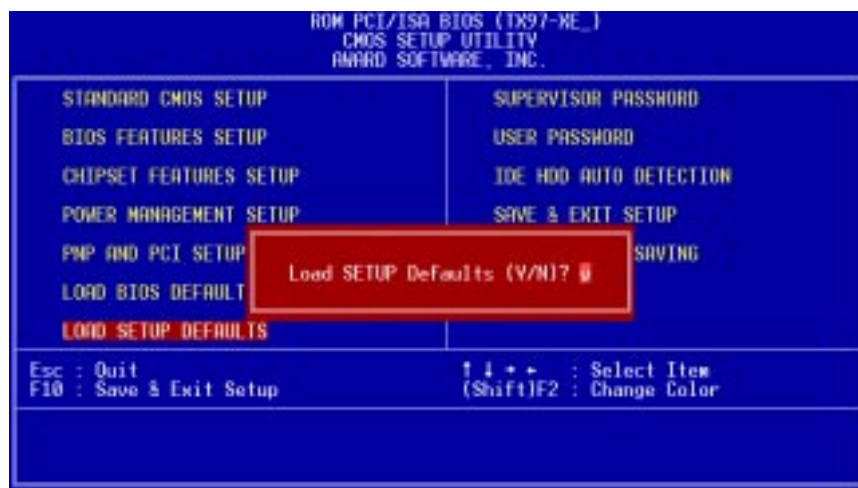

# IV. BIOS SOFTWARE

## Supervisor Password and User Password

These two options set the system passwords. “Supervisor Password” sets a password that will be used to protect the system and the Setup utility; “User Password” sets a password that will be used exclusively on the system. By default, the system comes without any passwords. To specify a password, highlight the type you want and then press <Enter>. A password prompt appears on the screen. Taking note that the password is case sensitive, and can be up to 8 alphanumeric characters long, type in your password and then press <Enter>. The system confirms your password by asking you to type it again. After setting a password, the screen automatically reverts to the main screen.



To implement password protection, specify in the “Security Option” field of the BIOS Features Setup screen when the system will prompt for the password. If you want to disable either password, press <Enter> instead of entering a new password when the “Enter Password” prompt appears. A message confirms the password has been disabled.

**NOTE:** If you forget the password, see CMOS RAM in section III for procedures on clearing the CMOS.

# IV. BIOS SOFTWARE

## IDE HDD Auto Detection

This “IDE HDD Auto Detection” option detects the parameters of an IDE hard disk drive, and automatically enters them into the Standard CMOS Setup screen.

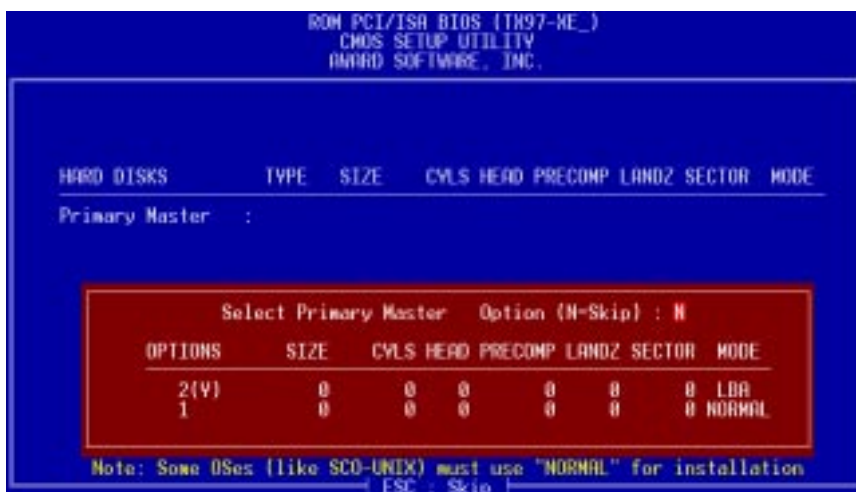

Up to four IDE drives can be detected, with parameters for each listed inside the box. To accept the optimal entries, press <Y> or else select from the numbers displayed under the OPTIONS field (2, 1, 3 in this case); to skip to the next drive, press <N>. If you accept the values, the parameters will appear listed beside the drive letter on the screen. The process then proceeds to the next drive letter. Pressing <N> to skip rather than to accept a set of parameters causes the program to enter zeros after that drive letter.

Remember that if you are using another IDE controller that does not feature Enhanced IDE support for four devices, you can only install two IDE hard disk drives. Your IDE controller must support the Enhanced IDE features in order to use Drive E and Drive F. The onboard PCI IDE controller supports Enhanced IDE, with two connectors for connecting up to four IDE devices. If you want to use another controller that supports four drives, you must disable the onboard IDE controller in the Chipset Features Setup screen.

When auto-detection is completed, the program automatically enters all entries you accepted on the field for that drive in the Standard CMOS Setup screen. Skipped entries are ignored and are not entered in the screen.

If you are auto-detecting a hard disk that supports the LBA mode, three lines will appear in the parameter box. Choose the line that lists LBA for an LBA drive. Do not select Large or Normal.

The auto-detection feature can only detect one set of parameters for a particular IDE hard drive. Some IDE drives can use more than one set. This is not a problem if the drive is new and empty.

## IV. BIOS SOFTWARE

**IMPORTANT:** If your hard disk was already formatted on an older previous system, incorrect parameters may be detected. You will need to enter the correct parameters manually or use low-level format if you do not need the data stored on the hard disk.

If the parameters listed differ from the ones used when the disk was formatted, the disk will not be readable. If the auto-detected parameters do not match the ones that should be used for your disk, do not accept them. Press <N> to reject the presented settings and enter the correct ones manually from the Standard CMOS Setup screen.

### Save & Exit Setup

Select this option to save into the CMOS memory all modifications you specified during the current session. To save the configuration changes, highlight the “Save & Exit Setup” option on the main screen, type “Y”, and then press <Enter>.

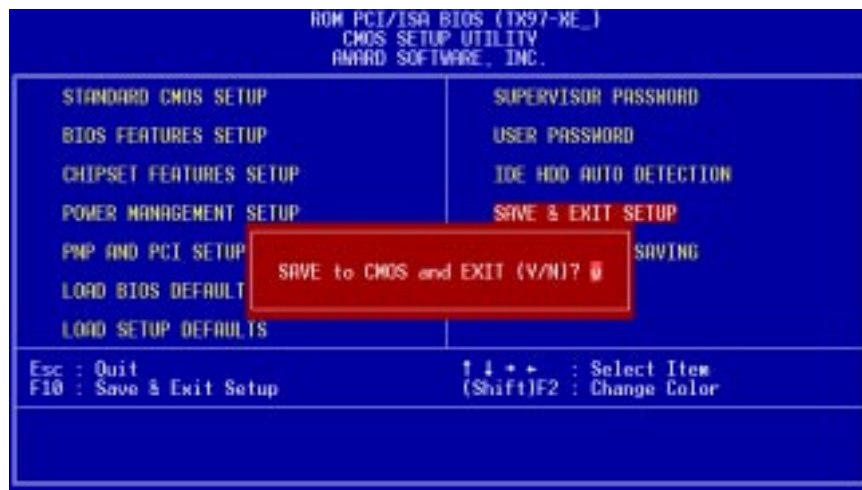

### Exit Without Saving

Select this option to exit the Setup utility without saving the modifications you specify during the current session. To exit without saving, highlight the “Exit Without Saving” option on the main screen and then press <Enter>.

# V. SUPPORT SOFTWARE

---

## Desktop Management Interface (DMI)

### *Introducing the ASUS DMI Configuration Utility*

This motherboard supports DMI within the BIOS level and provides a DMI Configuration Utility to maintain the Management Information Format Database (MIFD). DMI is able to auto-detect and record information pertinent to a computer's system such as the CPU type, CPU speed, and internal/external frequencies, and memory size. The onboard BIOS will detect as many system information as possible and store those collected information in a 4KB block in the motherboard's Flash EPROM and allow the DMI to retrieve data from this database. Unlike other BIOS software, the BIOS on this motherboard uses the same technology implemented for Plug and Play to allow dynamic real-time updating of DMI information versus creating a new BIOS image file and requiring the user to update the whole BIOS. This DMI Configuration Utility also allows the system integrator or end user to add additional information into the MIFD such as serial numbers, housing configurations, and vendor information. Those information not detected by the motherboard BIOS and has to be manually entered through the DMI Configuration Utility and updated into the MIFD. This DMI Configuration Utility provides the same reliability as PnP updating and will prevent the refreshing failures associated with updating the entire BIOS.

### *System Requirements*

The DMI Configuration Utility (DMICFG.EXE) must be used in real mode in order for the program to run, the base memory must be at least 180K. Memory managers like HIMEM.SYS (required by windows) must not be installed. You can boot up from a system diskette without AUTOEXEC.BAT and CONFIG.SYS files, "REM" HIMEM.SYS in the CONFIG.SYS, or press <F5> during bootup to bypass your AUTOEXEC.BAT and CONFIG.SYS files.



# V. SUPPORT SOFTWARE

## Using the ASUS DMI Configuration Utility

### Edit DMI (or delete)

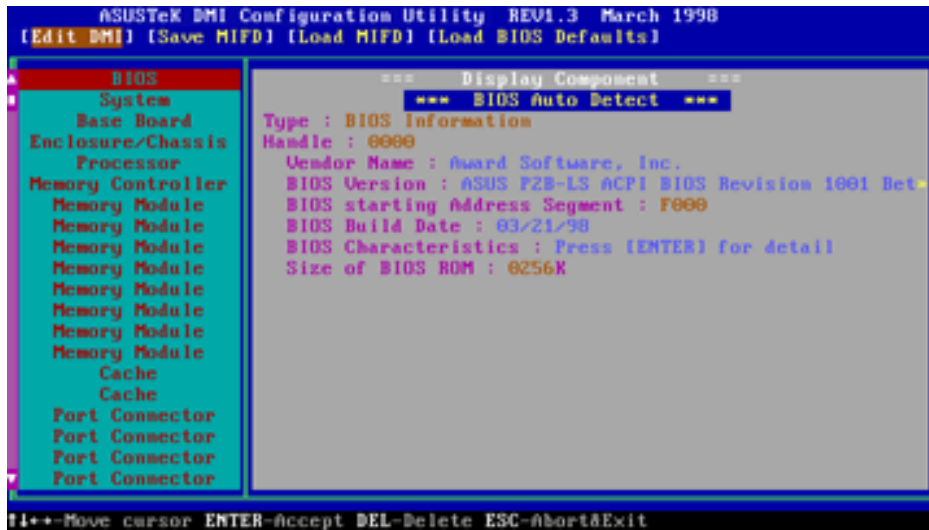

Use the ←→ (left-right) cursors to move the top menu items and the ↑↓ (up-down) cursor to move between the left hand menu items. The bottom of the screen will show the available keys for each screen. Press enter at the menu item to enter the right hand screen for editing. “Edit component” appears on top. The reversed color field is the current cursor position and the blue text are available for editing. The orange text shows auto-detected information and are not available for editing. The blue text “Press [ENTER] for detail” contains a second pop-up menu is available, use the + - (plus-minus) keys to change the settings. Enter to exit *and save*, ESC to exit *and not save*.

If the user has made changes, ESC will prompt you to answer Y or N. Enter Y to go back to the left-hand screen *and save*, enter N to go back to left-hand screen and *not save*. If editing has not been made, ESC will send you back to the left hand menu without any messages.

### Notes

A heading, \*\*\* BIOS Auto Detect \*\*\*, appears on the right for each menu item on the left side that has been auto detected by the system BIOS.

A heading, \*\*\* User Modified \*\*\*, will appear on the right for menu items that have been modified by the user.



# V. SUPPORT SOFTWARE

## Save MIFD

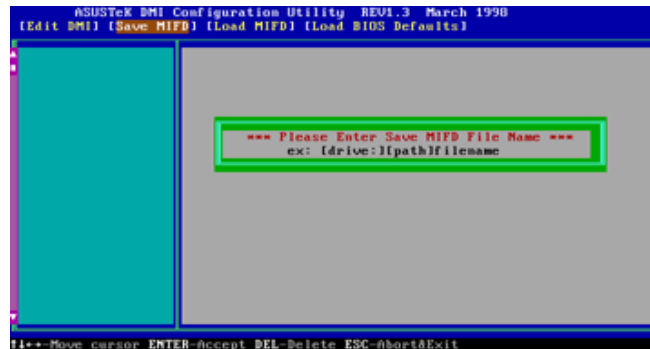

You can save the MIFD (normally only saved to flash ROM) to a file by entering the drive and path here. If you want to cancel save, you may press ESC and a message “Bad File Name” appears here to show it was not saved.

## Load MIFD

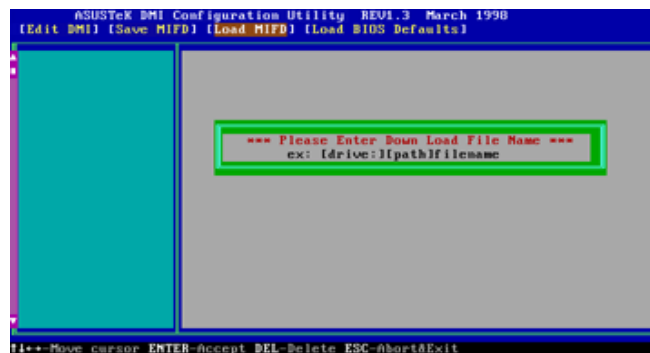

You can load the disk file to memory by entering a drive and path and file name here.

## Load BIOS Defaults

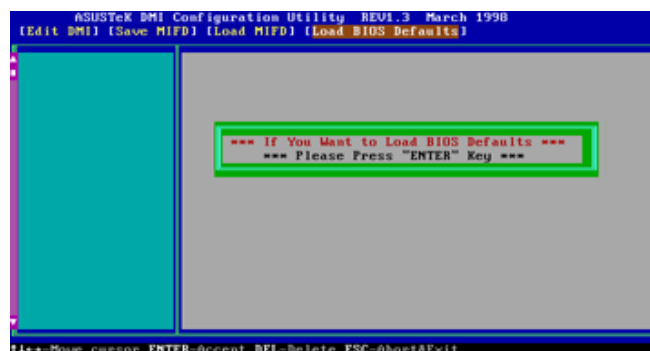

You can load the BIOS defaults from a MIFD file and can clear all user modified and added data. You must reboot your computer in order for the defaults to be saved back into the Flash BIOS.



16-bit Audio

# USER'S MANUAL

## Drivers Installation

# User's Notice

---

No part of this manual, including the products and softwares described in it, may be reproduced, transmitted, transcribed, stored in a retrieval system, or translated into any language in any form or by any means, except documentation kept by the purchaser for backup purposes, without the express written permission of ASUSTeK COMPUTER INC. ("ASUS").

ASUS PROVIDES THIS MANUAL "AS IS" WITHOUT WARRANTY OF ANY KIND, EITHER EXPRESS OR IMPLIED, INCLUDING BUT NOT LIMITED TO THE IMPLIED WARRANTIES OR CONDITIONS OF MERCHANTABILITY OR FITNESS FOR A PARTICULAR PURPOSE. IN NO EVENT SHALL ASUS, ITS DIRECTORS, OFFICERS, EMPLOYEES OR AGENTS BE LIABLE FOR ANY INDIRECT, SPECIAL, INCIDENTAL, OR CONSEQUENTIAL DAMAGES (INCLUDING DAMAGES FOR LOSS OF PROFITS, LOSS OF BUSINESS, LOSS OF USE OR DATA, INTERRUPTION OF BUSINESS AND THE LIKE), EVEN IF ASUS HAS BEEN ADVISED OF THE POSSIBILITY OF SUCH DAMAGES ARISING FROM ANY DEFECT OR ERROR IN THIS MANUAL OR PRODUCT.

Products and corporate names appearing in this manual may or may not be registered trademarks or copyrights of their respective companies, and are used only for identification or explanation and to the owners' benefit, without intent to infringe.

- Sound Blaster, SB AWE32 and SB16 are trademarks of Creative Technology Ltd.
- Windows and MS-DOS are registered trademarks of Microsoft Corporation.
- IBM and OS/2 are registered trademarks of International Business Machines.

The product name and revision number are both printed on the board itself. Manual revisions are released for each board design represented by the digit before and after the period of the manual revision number. Manual updates are represented by the third digit in the manual revision number.

For previous or updated manuals, BIOS, drivers, or product release information, contact ASUS at <http://www.asus.com.tw> or through any of the means indicated on the following page.

SPECIFICATIONS AND INFORMATION CONTAINED IN THIS MANUAL ARE FURNISHED FOR INFORMATIONAL USE ONLY, AND ARE SUBJECT TO CHANGE AT ANY TIME WITHOUT NOTICE, AND SHOULD NOT BE CONSTRUED AS A COMMITMENT BY ASUS. ASUS ASSUMES NO RESPONSIBILITY OR LIABILITY FOR ANY ERRORS OR INACCURACIES THAT MAY APPEAR IN THIS MANUAL, INCLUDING THE PRODUCTS AND SOFTWARES DESCRIBED IN IT.

**Copyright © 1994 Creative Technology Ltd. All Rights Reserved.**

**Copyright © 1997 ASUSTeK COMPUTER INC. All Rights Reserved.**

Part of this manual are reprinted in Taipei, Taiwan by ASUSTeK COMPUTER INC. under license from Creative Technology Ltd.

Product Name:	<b>ASUS 16-bit Audio</b>
Manual Revision:	<b>1.20</b>
Release Date:	<b>March 1997</b>

# Audio Drivers Installation

## ASUS Audio CD

This CD contains a collection of audio drivers and audio software applications for products with the Creative Labs ViBRA 16C Series Audio Chipset.

### NOTES:

- Some of the drivers were originally created for floppy diskettes. Please substitute your CD ROM drive letter (such as D:) and the corresponding directory names in place of any references to “A:” or “B:” floppy drives.
- Before installing the audio drivers for Windows 3.x, you must install Creative Technology’s Configuration Manager (CTCM).
- You must close all applications before installing the audio drivers.





The following is a list of the main directories used in this audio section:

### *ASUS Audio Driver CD Contents*

\AUDIO\CTCM	Creative PnP Configuration Manager for DOS/Win3.x (Run <b>INSTALL.EXE</b> from DOS, before Win3.x)
\AUDIO\DISKS	Individual installation disks for above drivers (Copy to 1.44MB 3.5” floppy disks if necessary)
\AUDIO\NT40	Audio Drivers & Applications for WinNT (Double click the <b>SETUP</b> icon from WinNT)
\AUDIO\OS2	Audio Drivers & Applications for OS2 (Run <b>INSTALL.EXE</b> from DOS Prompt)
\AUDIO\WIN31	Audio Drivers & Applications for DOS & Win3.x (Install CTCM, then run <b>INSTALL.EXE</b> from DOS)
\AUDIO\WIN95	Audio Drivers & Applications for Win95 (Double click the <b>SETUP</b> icon from Win95)

# Win95 Audio Drivers

## Audio Drivers Installation Procedures:

1. Insert the installation CD into the CD-ROM drive.
2. Double click on “My Computer” icon. 
3. Double click on your CD-ROM drive. 
4. Double click on the “Audio” folder. 
5. Double click on the “Win95” folder. 
6. Double click on the “Setup.exe” icon. 
7. Carefully follow the installation wizard displayed and click the “Next” buttons to continue through the installation process.
8. When installation is completed, you can run the audio utilities through the start menu as shown below:

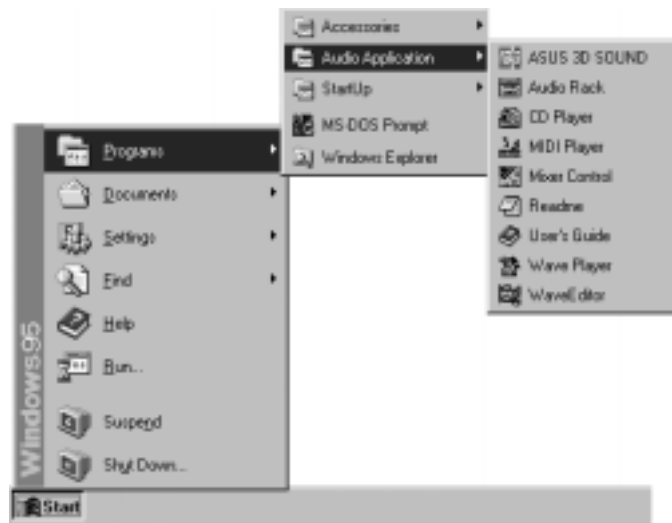

# Win3.x Audio Drivers

---

## Configuration Manager

In DOS and Windows 3.1x environments a program called the Configuration Manager must be installed in order for the Configuration Manager to do resource allocations for all ISA Plug and Play cards. The audio portion of this card uses 16-bit ISA specifications.

## Creative PnP Configuration Manager (CTCM)

If you try installing the audio drivers first, the audio install program will not be able to find the PLUGPLAY\DRIVERS\DOS\ESCD.RF database file and give you the following message: “Configuration Manager not found. Please install the Configuration Manager before installing your Audio Software.” “Press a key to continue.” Pressing a key will send you back to the DOS prompt.

Run the Configuration Manager install under DOS prompt by running **INSTALL** from the \AUDIO\CTCM\ directory.

### **The first screen shows:**

The following path will be used for installing Configuration Manager programs.

Proceed using the settings shown

```
Configuration Manager Path   : C:\CTCM
Microsoft Windows 3.1 Path   : C:\WINDOWS
System Bootup Drive         : C:\
```

Press <ENTER> to continue, <F1> for help, or <F3> to exit.

If you need to change the paths shown, you may push the down arrow key and press <ENTER> when highlighted. If your Windows directory is not detected, you need to change the path shown to your Windows directory. If you wish to change the Windows path some other time, you will have to run **INSTALL** from your Configuration Manager installation CD again.

# Win3.x Audio Drivers

---

**You will get the following message after you press <ENTER>:**

Welcome to the Configuration Manager installation program. This program installs Configuration Manager files onto your computer's hard disk. Before installing, please read the README file for the latest information. If you need more information before deciding on a certain option, you can always get help by pressing F1.

Press <ENTER> to continue, <F1> for help, <F2> for README, or <F3> to exit.

**The following lines will be added to your system files:**

C:\AUTOEXEC.BAT file:

```
SET CTCM=C:\CTCM
```

```
C:\CTCM\CTCU /S /W=C:\WINDOWS
```

C:\CONFIG.SYS file:

```
DEVICE=C:\CTCM\CTCM.EXE
```

Press <ENTER> to continue, <F1> for help, or <F3> to exit.

**A message will appear on the next screen:**

Software installation completed.

The following files were modified and its original saved with B~K extension.

```
C:\CONFIG.SYS
```

```
C:\AUTOEXEC.BAT
```

You must reboot in order for the newly edited CONFIG.SYS to be initiated. You may choose to exit to DOS by pressing <ENTER> but be sure to reboot on your own. A message "Please remember to REBOOT your system" will appear when exiting. Otherwise, press <F10> to automatically reboot your system.



# Win3.x Audio Drivers

## Audio Software

Run **INSTALL** from the \AUDIO\WIN31\ directory for the following installation screens:

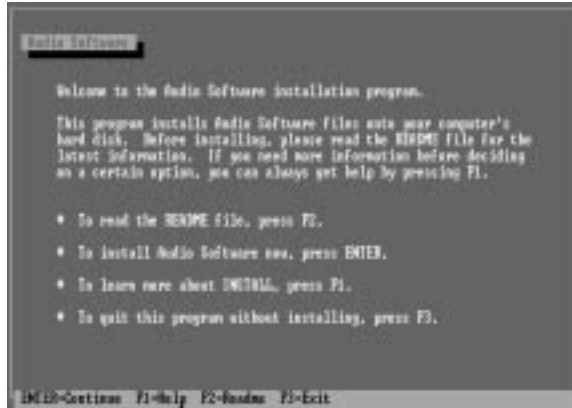

Follow the instructions and make your choice to learn more about INSTALL <F1>, view the README <F2>, quit <F3>, or install Configuration Manager <ENTER>.



You may choose “Full Installation” to install all components or “Custom Installation” to toggle DOS: (1) Audio Samples (2) Readme and Common Q&A Files and WINDOWS: (1) WaveEditor (2) QuickCD. You can select Custom Installation if you are curious about its options and then go back to the previous screen by pressing <ESC>. Pressing <ENTER> at the above screen will show the installation paths. You may change the paths or press <ENTER> again if the paths are correct. Press <ENTER> to continue so that changes can be made to your system files.

# Win3.x Audio Drivers

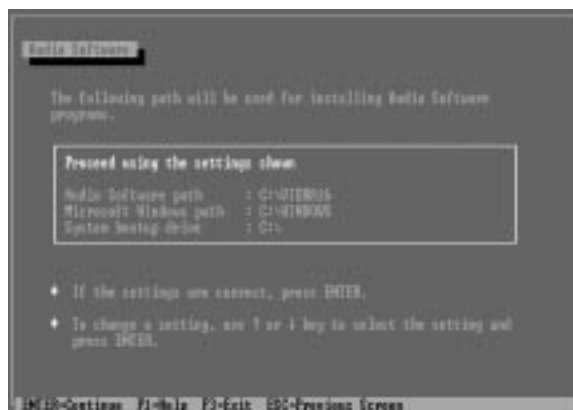

You will be prompted that an addition will be made in your C:\AUTOEXEC.BAT and C:\CONFIG.SYS files. The typical PC will have these settings added to the system files:

C:\AUTOEXEC.BAT

```
SET BLASTER=A220 I5 D1 H5 P330 T6
SET SOUND=C:\VIBRA16
SET MIDI=SYNTH:1 MAP:E
C:\VIBRA16\DIAGNOSE /S /W=C:\WINDOWS
C:\VIBRA16\MIXERSET /P /Q
```

C:\CONFIG.SYS

```
FILES=40 (if less than 40 or does not exist)
```

If you wish to use the “Play” and “Record” utility located in \VIBRA16\ directory in DOS mode, you must also add the following two lines through “Custom Installation.”

```
DEVICE=C:\VIBRA16\DRV\VIBRA16.SYS /UNIT=0 /BLASTER=A:220 I:5 D:1 H:5
DEVICE=C:\VIBRA16\DRV\CTMMSYS.SYS
```

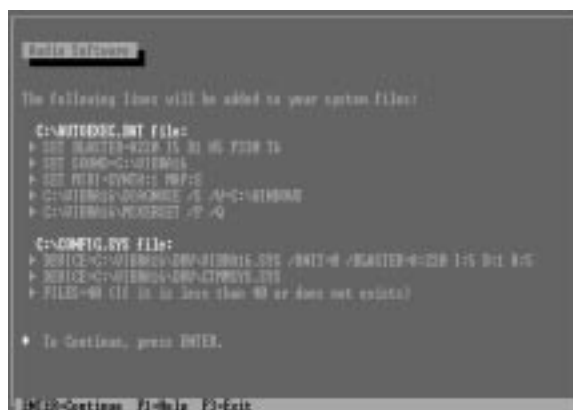

# Win3.x Audio Drivers

Certain older audio files may already exist in your Windows directory. If so, simply press <ENTER> to “Backup the original files” as shown here:

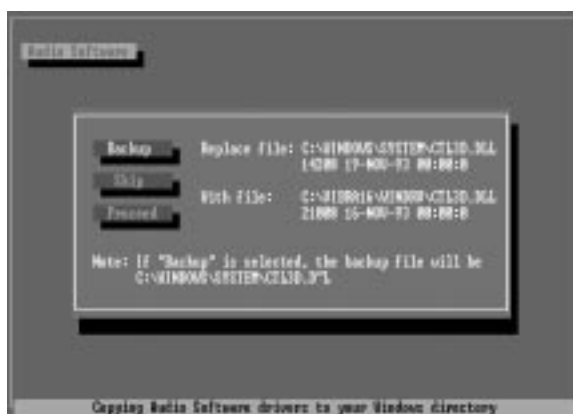
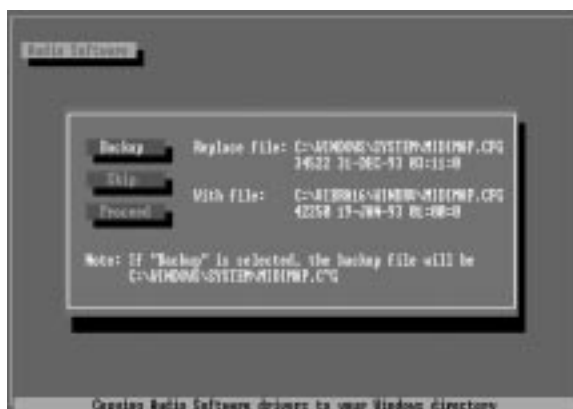

The following files will then be saved with a .B~K extension in case you need to reference your original system file settings:

- C:\CONFIG.SYS
- C:\AUTOEXEC.BAT
- C:\WINDOWS\WIN.INI
- C:\WINDOWS\SYSTEM.INI
- C:\WINDOWS\CONTROL.INI

# Win3.x Audio Drivers

You must reboot in order for the newly edited CONFIG.SYS to be initiated. You may exit to DOS by pressing <ENTER> and edit your CONFIG.SYS file and then reboot on your own. Otherwise, press <F10> to automatically reboot your system.



After your system is rebooted, enter Windows to see that the Audio Software is correctly installed. You should here a musical chime as you enter Windows 3.1x and see the following on your screen:

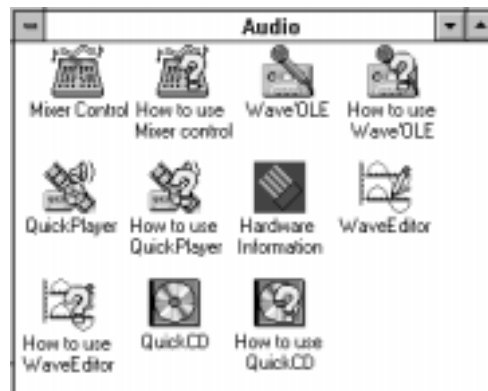

After this message above, your installation for Windows 3.1x is complete. From here on, you may refer to Section II or Section III for Audio Software usage.

# Win3.x Audio Drivers

---

## Environment Variables

There are three environment variables used to signify information of our audio hardware : SOUND, BLASTER and MIDI. These variables will be setup by SETPNP.EXE added in the AUTOEXEC.BAT during your audio software installation.

### *SOUND Environment variable*

The SOUND environment variable specifies the directory location of audio drivers and software. You can type “SET” at the DOS prompt and see the following line for the setting of the SOUND environment variable:

```
SOUND=<path>
```

### *BLASTER Environment Variable*

The BLASTER environment variable specifies the base I/O address, interrupt number and DMA channel hardware configuration of the audio hardware. You can type “SET” at the DOS prompt and see the following line for the setting of the BLASTER environment variable:

```
BLASTER=A220 I5 D1 H5 P330 T6
```

Where:

- A Specifies the audio hardware base I/O port
- I Specifies the interrupt request line
- D Specifies the Low DMA channel
- H Specifies the High DMA channel
- P Specifies the MPU-401 base I/O port
- T Specifies the card type

# Win3.x Audio Drivers

---

## *MIDI Environment Variable*

The MIDI environment variable specifies the MIDI file format used and where the MIDI data is sent to. The MIDI data can be sent to FM chips or audio hardware MIDI port. Generally, there are three MIDI file formats available in the market, General MIDI, Extended MIDI and Basic MIDI. You can type “SET” at the DOS prompt and see the following line for the setting of the BLASTER environment variable:

**MIDI=SYNTH:<1/2> MAP:<G/E/B>**

Where:

- SYNTH:    1    Specifies internal synthesizer (default)  
            2    Specifies audio hardware MIDI port
- MAP:      G    Specifies General MIDI file format  
            E    Specifies Extended MIDI file format (default)  
            B    Specifies Basic MIDI file format

## *Maximum Recording Rates for the Audio Hardware*

The sampling rate used for recording is largely influenced by your computer’s main processor. To obtain 16-bit digital audio using Windows, the following maximum recording rates are suggested.

<b>SYSTEM</b>	<b>RECORDING RATE</b>
386 and above	Stereo - 44KHz Mono - 44KHz
386 SX and below	Stereo - 22KHz Mono - 44KHz

To obtain optimal performance, try configuring the audio hardware to use a high DMA (Direct Memory Access) channel under Windows. Refer to your audio hardware Getting Started Manual for more information on setting up the sound card to use a high DMA channel.

---

(This page was intentionally left blank)

---

(This page was intentionally left blank)