



A7V266-M

User Guide

Motherboard

Product Name: **A7V266-M**
Manual Revision: **1.00 E921**
Release Date: **December 2001**

Copyright © 2001 ASUSTeK COMPUTER INC. All Rights Reserved.

No part of this manual, including the products and software described in it, may be reproduced, transmitted, transcribed, stored in a retrieval system, or translated into any language in any form or by any means, except documentation kept by the purchaser for backup purposes, without the express written permission of ASUSTeK COMPUTER INC. ("ASUS").

Product warranty or service will not be extended if: (1) the product is repaired, modified or altered, unless such repair, modification or alteration is authorized in writing by ASUS; or (2) the serial number of the product is defaced or missing.

Products and corporate names appearing in this manual may or may not be registered trademarks or copyrights of their respective companies, and are used only for identification or explanation and to the owners' benefit, without intent to infringe.

- Intel and Pentium are registered trademarks of Intel Corporation.
- VIA is a registered trademark of VIA Technologies, Inc.
- 3Com is a registered trademark of 3Com Corporation.
- C-Media is a registered trademark of C-Media Electronics Inc.
- Windows and MS-DOS are registered trademarks of Microsoft Corporation.
- Adobe and Acrobat are registered trademarks of Adobe Systems Incorporated.
- Trend and ChipAwayVirus are trademarks of Trend Micro, Inc.
- Symbios is a registered trademark of Symbios Logic Corporation.
- nVidia is a registered trademark of NVIDIA Corporation.

The product name and revision number are both printed on the product itself. Manual revisions are released for each product design represented by the digit before and after the period of the manual revision number. Manual updates are represented by the third digit in the manual revision number.

For previous or updated manuals, BIOS, drivers, or product release information, contact ASUS at: <http://www.asus.com> or through any of the means indicated on the following page.

ASUS PROVIDES THIS MANUAL "AS IS" WITHOUT WARRANTY OF ANY KIND, EITHER EXPRESS OR IMPLIED, INCLUDING BUT NOT LIMITED TO THE IMPLIED WARRANTIES OR CONDITIONS OF MERCHANTABILITY OR FITNESS FOR A PARTICULAR PURPOSE. IN NO EVENT SHALL ASUS, ITS DIRECTORS, OFFICERS, EMPLOYEES OR AGENTS BE LIABLE FOR ANY INDIRECT, SPECIAL, INCIDENTAL, OR CONSEQUENTIAL DAMAGES (INCLUDING DAMAGES FOR LOSS OF PROFITS, LOSS OF BUSINESS, LOSS OF USE OR DATA, INTERRUPTION OF BUSINESS AND THE LIKE), EVEN IF ASUS HAS BEEN ADVISED OF THE POSSIBILITY OF SUCH DAMAGES ARISING FROM ANY DEFECT OR ERROR IN THIS MANUAL OR PRODUCT.

SPECIFICATIONS AND INFORMATION CONTAINED IN THIS MANUAL ARE FURNISHED FOR INFORMATIONAL USE ONLY, AND ARE SUBJECT TO CHANGE AT ANY TIME WITHOUT NOTICE, AND SHOULD NOT BE CONSTRUED AS A COMMITMENT BY ASUS. ASUS ASSUMES NO RESPONSIBILITY OR LIABILITY FOR ANY ERRORS OR INACCURACIES THAT MAY APPEAR IN THIS MANUAL, INCLUDING THE PRODUCTS AND SOFTWARE DESCRIBED IN IT.

About this guide

This user manual contains complete information for installing the ASUS A7V266-M motherboard.

How this guide is organized

- **Chapter 1: Product introduction.** A summary of product features and special attributes of new technologies.
- **Chapter 2: Hardware information.** A list of hardware setup procedures and descriptions of all jumpers and connectors on the motherboard.
- **Chapter 3: Powering up.** Describes the power up sequence with information on BIOS beep codes.
- **Chapter 4: BIOS setup.** How to change system settings using onboard BIOS firmware. Detailed descriptions of the BIOS parameters are supplied.
- **Chapter 5: Software support.** A summary of contents on the motherboard support CD ROM.
- **Appendix and Glossary.** Optional components and technical definitions.
- **Index**

Conventions used in this guide

To make sure that you perform set-up tasks properly, take note of the following symbols used throughout this manual.



WARNING! Information to prevent injury to yourself.



CAUTION! Information to prevent damage to the components.



IMPORTANT! Information that you **MUST** follow to complete a task.



NOTE! Tips and helpful information.

Contents

About this guide	iii
Safety information	vi
FCC/CDC statements	vii
ASUS contact information	viii
Chapter 1: Product introduction	1
Welcome!	1
1.1 Package contents	1
1.2 Core Specifications	2
1.3 Special Features	3
1.4 Motherboard Components	4
1.4.1 Component Locations	5
Chapter 2: Hardware information	7
2.1 Motherboard installation	7
2.1.1 Placement direction	7
2.1.2 Screw holes	7
2.2 Motherboard layout	8
2.2.1 Layout contents	9
2.3 Before you proceed	10
2.4 Central Processing Unit (CPU)	11
2.4.1 Overview	11
2.4.2 Installing the CPU	12
2.5 System memory	13
2.5.1 Overview	13
2.5.2 Memory configurations	14
2.5.3 Installing a DIMM	14
2.6 Expansion slots	15
2.6.1 Installing an expansion card	15
2.6.2 Configuring an expansion card	16
2.6.3 PCI slots	17
2.6.4 AGP slot	18
2.7 Switches and jumpers	19
2.8 Connectors	25

Contents

Chapter 3: Powering up	39
3.1 Starting up for the first time	39
3.2 Powering off the computer	40
Chapter 4: BIOS setup	41
4.1 Managing and updating your BIOS	41
4.1.1 Using the computer system for the first time	41
4.1.2 Updating BIOS procedures	43
4.2 BIOS Setup program	45
4.2.1 BIOS menu bar	46
4.2.2 Legend bar	46
4.3 Main Menu	48
4.3.1 Primary and Secondary Master/Slave	49
4.3.2 Keyboard Features	53
4.4 Advanced Menu	55
4.4.1 Chip Configuration	58
4.4.2 I/O Device Configuration	61
4.4.3 PCI Configuration	63
4.5 Power Menu	65
4.5.1 Power Up Control	67
4.5.2 Hardware Monitor	69
4.6 Boot Menu	70
4.7 Exit Menu	72
Chapter 5: Software support	75
5.1 Install an operating system	75
5.2 Support CD information	75
5.3 A7V266-M Motherboard Support CD	76
5.4 ASUS PC Probe	79
5.5 ASUS Live Update	84
5.6 3Deep Color Tuner	85
Glossary	87
Index	91

Safety information

Electrical safety

- To prevent electrical shock hazard, disconnect the power cable from the electrical outlet before relocating the system.
- When adding or removing devices to or from the system, ensure that the power cables for the devices are unplugged before the signal cables are connected. Disconnect all power cables from the existing system before you add a device.
- Before connecting or removing signal cables from the motherboard, ensure that all power cables are unplugged.
- Seek professional assistance before using an adapter or extension cord. These devices could interrupt the grounding circuit.
- Make sure that your power supply is set to the voltage available in your area.
- If the power supply is broken, contact a qualified service technician or your retailer.

Operational safety

- Before installing the motherboard and adding new devices, carefully read all the manuals that came with the package.
- Before use ensure all cables are correctly connected and the power cables are not damaged. If you detect any damage, contact the dealer immediately.
- To avoid short circuits, keep paper clips, screws, and staples away from connectors, slots, sockets and circuitry.
- Avoid dust, humidity, and temperature extremes. Do not place the product in any area where it may become wet.
- Mount the motherboard inside a standard PC enclosure.
- If you encounter technical problems with the product, contact a qualified service technician or the dealer.

FCC/CDC statements

Federal Communications Commission Statement

This device complies with FCC Rules Part 15. Operation is subject to the following two conditions:

- This device may not cause harmful interference, and
- This device must accept any interference received including interference that may cause undesired operation.

This equipment has been tested and found to comply with the limits for a Class B digital device, pursuant to Part 15 of the FCC Rules. These limits are designed to provide reasonable protection against harmful interference in a residential installation. This equipment generates, uses and can radiate radio frequency energy and, if not installed and used in accordance with manufacturer's instructions, may cause harmful interference to radio communications. However, there is no guarantee that interference will not occur in a particular installation. If this equipment does cause harmful interference to radio or television reception, which can be determined by turning the equipment off and on, the user is encouraged to try to correct the interference by one or more of the following measures:

- Reorient or relocate the receiving antenna.
- Increase the separation between the equipment and receiver.
- Connect the equipment to an outlet on a circuit different from that to which the receiver is connected.
- Consult the dealer or an experienced radio/TV technician for help.



The use of shielded cables for connection of the monitor to the graphics card is required to assure compliance with FCC regulations. Changes or modifications to this unit not expressly approved by the party responsible for compliance could void the user's authority to operate this equipment.

Canadian Department of Communications Statement

This digital apparatus does not exceed the Class B limits for radio noise emissions from digital apparatus set out in the Radio Interference Regulations of the Canadian Department of Communications.

This class B digital apparatus complies with Canadian ICES-003.

ASUS contact information

ASUSTeK COMPUTER INC. (Asia-Pacific)

Marketing

Address: 150 Li-Te Road, Peitou, Taipei, Taiwan 112
Telephone: +886-2-2894-3447
Fax: +886-2-2894-3449
Email: info@asus.com.tw

Technical Support

Tel (English): +886-2-2890-7123
Tel (Chinese): +886-2-2890-7113
Fax: +886-2-2890-7698
Email: tsd@asus.com.tw
Newsgroup: cscnews.asus.com.tw
WWW: www.asus.com.tw
FTP: ftp.asus.com.tw/pub/ASUS

ASUS COMPUTER INTERNATIONAL (America)

Marketing

Address: 6737 Mowry Avenue, Mowry Business Center, Building 2
Newark, CA 94560, USA
Fax: +1-510-608-4555
Email: info-usa@asus.com.tw

Technical Support

Fax: +1-510-608-4555
BBS: +1-510-739-3774
Email: tsd@asus.com
WWW: www.asus.com
FTP: ftp.asus.com/pub/ASUS

ASUS COMPUTER GmbH (Europe)

Marketing

Address: Harkortstr. 25, 40880 Ratingen, BRD, Germany
Fax: +49-2102-442066
Email: sales@asuscom.de (for marketing requests only)

Technical Support

Hotline: MB/Others: +49-2102-9599-0
Notebook: +49-2102-9599-10
Fax: +49-2102-9599-11
Support (Email): www.asuscom.de/de/support (for online support)
WWW: www.asuscom.de
FTP: ftp.asuscom.de/pub/ASUSCOM

Chapter 1

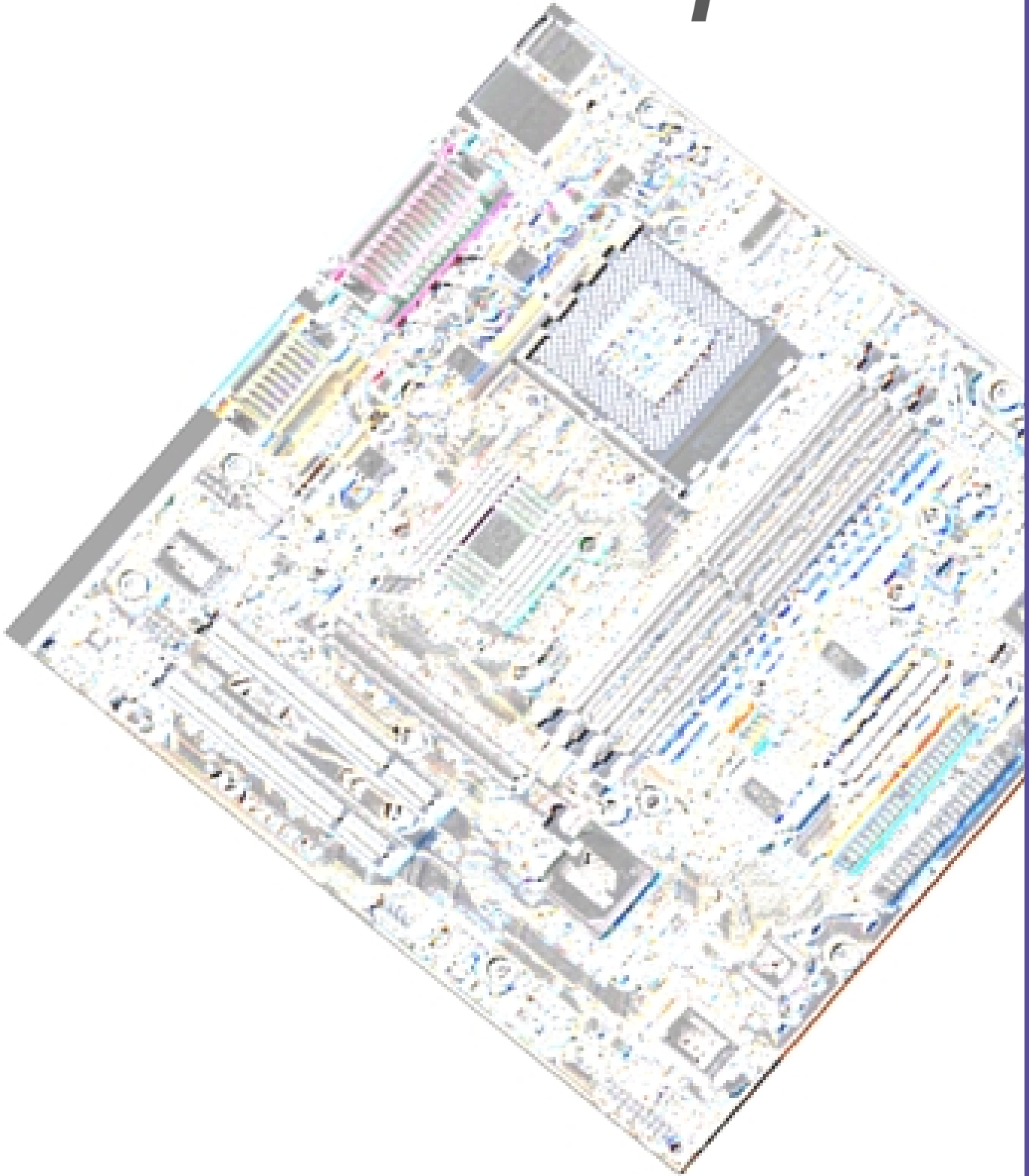

Product introduction

Welcome!

Thank you for buying the ASUS® A7V266-M motherboard!

The A7V266-M is powered by AMD® Athlon™, Athlon™ XP and Duron™ processors and supplies advanced features to ensure long-lasting, superlative performance. The ASUS® A7V266-M motherboard is the prime choice for home PCs and workstations.

- ~ *CPU Thermal Protection*
- ~ *Up to 3GB of system memory of the latest DDR RAM*
- ~ *High-resolution graphics via an AGP 4X slot*
- ~ *Digital Audio Interface for 3D sound*
- ~ *Realtek™ LAN networking*
- ~ *UltraDMA 100 data rates*

The A7V266-M is the perfect vehicle to get ahead in the world of power computing!

1.1 Package contents

Check your A7V266-M package for the following items.

- ✓ ASUS A7V266-M motherboard (MicroATX form factor: 9.6 in x 9.6 in)
- ✓ ASUS A7V266-M support CD
- ✓ ASUS 2-port USB module
- ✓ 80-conductor ribbon cable for UltraDMA/33/66/100 IDE drives
- ✓ 40-conductor IDE cable
- ✓ Ribbon cable for a 3.5-inch floppy drive
- ✓ Bag of extra jumper caps
- ✓ User Guide



If any of the above items is damaged or missing, contact your retailer.

1.2 Core Specifications

The A7V266-M motherboard is designed and assembled according to the highest standards. This ASUS motherboard represents the latest advances and offers users the finest componentry available today...

AMD® Athlon™ / Athlon™ XP and Duron™ Socket A (462) Processor

North Bridge Chipset: the **VIA® KT266A** supports AGP 4X/2X mode, 133/100MHz Front Side Bus, and the fastest 266/200MHz memory bus.

South Bridge Chipset: the **VIA® VT8233** integrated peripheral controller supports UltraDMA/100/66/33 for burst mode data transfer rates of up to 100MB/sec, and USB controller with three root hubs for six USB ports.

PC2100 / PC1600 DDR Support: Equipped with three Double Data Rate Dual Inline Memory Module (DDR DIMM) sockets to support up to 3GB of DDR DRAM, the newest memory standard with the highest bandwidth and lowest latency currently available. This new memory technology increases performance by executing two actions per clock cycle, resulting in data transfer rates of up to 2.1 GB/s for 133MHz DDR SDRAM and 1.6GB/s for 100MHz DDR SDRAM.

UltraDMA/100 Support: Comes with an onboard PCI Bus Master IDE controller with two connectors that support four IDE devices on two channels. Supports UltraDMA/100/66/33, PIO Modes 3 & 4, Bus Master IDE DMA Mode 2, and Enhanced IDE devices, such as DVD-ROM, CD-ROM, CD-R/RW, LS-120, and Tape Backup drives.

Multi-I/O Chipset: Offers complete support for a variety of I/O functions. Provides two high-speed UART compatible serial ports and one parallel port with EPP and ECP capabilities. UART2 can also be directed from COM2 to the Infrared Module for wireless connections. The Super I/O controller supports a floppy disk drive, PS/2 keyboard, and PS/2 mouse.

Smart BIOS: 2Mb firmware enables Vcore and CPU/DDR SDRAM frequency adjustments, boot block write protection, and HD/SCSI/MO/ZIP/CD/Floppy boot selection.

Expansion: One AGP 4X, four USB ports, two PCI slots, Infrared port

Connections: Parallel Port, PS/2 mouse Port, PS/2 keyboard, RJ-45, Microphone, Line In Jack, Line Out Jack, Game/MIDI Connector, Standard ATX power.

1.3 Special Features

Easy Overclocking

- Quickly adjust CPU frequency multiples with BIOS in JumperFree™ Mode
- Adjustable FSB/MEM/PCI frequency ratio
- Stepless Frequency Selection (SFS) for fine-tuning system bus frequency from at 1MHz increments
- Optimal system performance available with BIOS built-in Turbo Mode
- Adjustable Vcore Voltage and VIO
- Alternatively, *easy-to-use DIP switches* permit manual adjustment of the processor external/internal frequency settings.

Thermal Protection: With AMD® Athlon XP™ installed, the motherboard offers automatic CPU Overheating Protection to prolong the life of the entire system. If the CPU temperature exceeds the set criteria, the PC shuts down automatically.

Realtek LAN: Full networking built-in with the RTL8100 controller with driver support and onboard RJ-45 input jack. (*Optional*)

Temperature, Fan and Voltage Monitoring: CPU temperature is monitored by the ASUS ASIC through the CPU's internal thermal diode to prevent overheating and damage. The CPU and system fans can be monitored for RPM and failure. System voltage levels are monitored to ensure stable voltage to critical motherboard components.

ACPI Ready: Advanced Configuration Power Interface (ACPI) provides more Energy Saving Features for operating systems that support OS Direct Power Management (OSPM).

Concurrent PCI: Concurrent PCI allows multiple PCI transfers from PCI master busses to the memory and processor.

Auto Fan Off: The system fans powers off automatically even in sleep mode.

Dual Function Power Button: Push the power button for less than 4 seconds when the system is operating places the system into sleep or soft-off modes, depending on the BIOS or OS setting. If the power button is pressed for more than 4 seconds, the system enters the soft-off mode regardless of the BIOS setting.

1.4 Motherboard Components

Before installing the A7V266-M motherboard, take time to familiarize yourself with its physical configuration: understanding the motherboard makes upgrading easy. Sufficient knowledge of specifications will prevent accidental damage to the board.

	Location
Processor Support	Socket A for AMD® Athlon™ and Duron™ Processors 1
	Feature Setting DIP Switches 4
Chipsets	VIA® KT266A North Bridge 2
	VIA® VT8233 South Bridge 14
	Multi-I/O controller 11
	2Mbit Programmable Flash EEPROM 10
Main Memory	Maximum 3GB support
	3 DDR DIMM Sockets 3
Expansion Slots	2 PCI Slots 18
	1 Accelerated Graphics Port (AGP) 4X Slot 20
System I/O	1 Floppy Disk Drive Connector 8
	2 IDE Connectors (UltraDMA/100 Support) 9
	1 Panel Connector 12
	1 Infrared Connector 13
	USB Headers (Ports 2/3) 15
	1 Parallel Port 23
	2 Serial Ports (COM1/COM2) 28
	USB Connectors (Port 0 & Port 1) 29
	1 PS/2 Mouse Connector (green) 21
	1 PS/2 Keyboard Connector (purple) 30
Hardware Monitoring	System Voltage Monitor (Integrated in ASUS ASIC) 7
Special Feature	Onboard LED 6
Audio Features	(on audio models only)
	Audio CODEC Controller Chipset 16
	1 ASUS Front Audio Panel Connector 17
	1 Game/MIDI Port 24
	1 Line Out Connector (lime) 27
	1 Line In Connector (light blue) 26
	1 Microphone Connector (pink) 25
Power	ATX Power Supply Connector 5
Form Factor	MicroATX

1.4.1 Component Locations

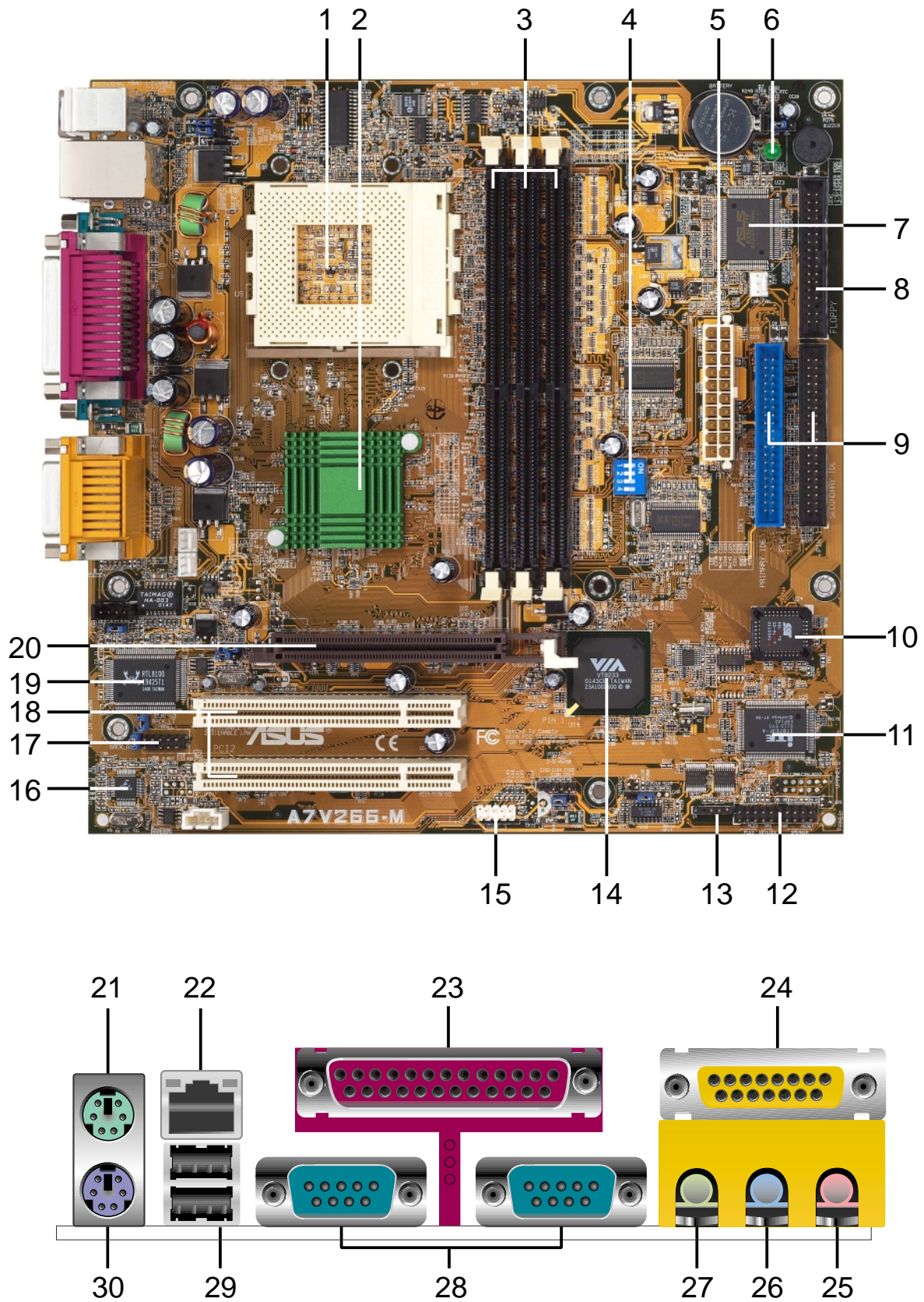



Chapter 2

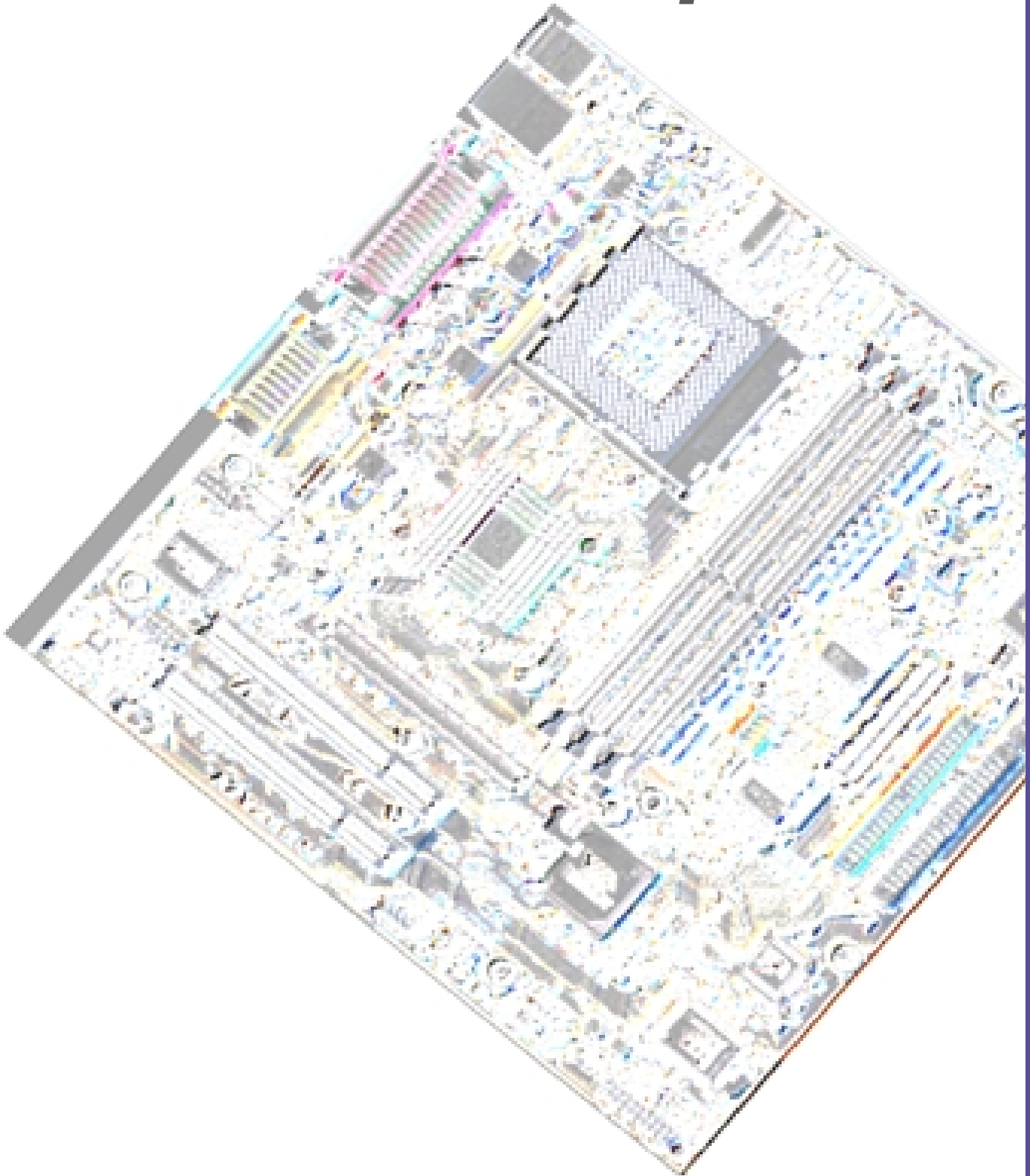

Hardware information

2.1 Motherboard installation

The A7V266-M uses the micro-ATX form factor that measures 9.6 inches x 9.6 inches, a standard fit for most chassis.



WARNING! Unplug the power cord before installing the motherboard. Failure to do so may cause you physical injury and damage motherboard components.

2.1.1 Placement direction

When installing the motherboard, take care to orient the chassis correctly: The edge with external ports goes to the rear part of the chassis. Refer to the image below. It may be more convenient to install major cables, the CPU and modular components before fixing the motherboard inside the case frame.

2.1.2 Screw holes

Place eight screws into the holes indicated by circles to secure the motherboard to the chassis.



CAUTION! Do not overtighten the screws! Doing so may damage the motherboard.

Place this side towards the rear of the chassis

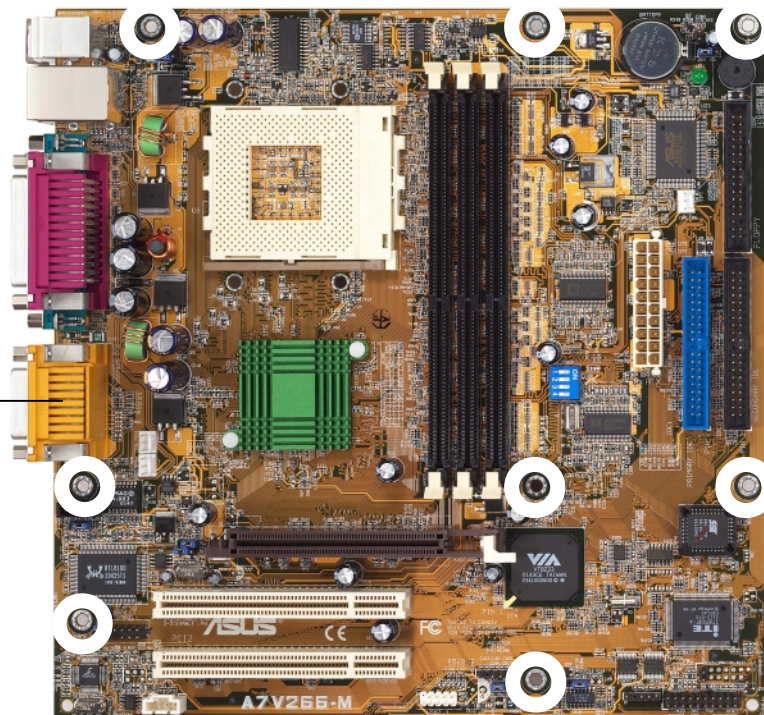

2.2 Motherboard layout

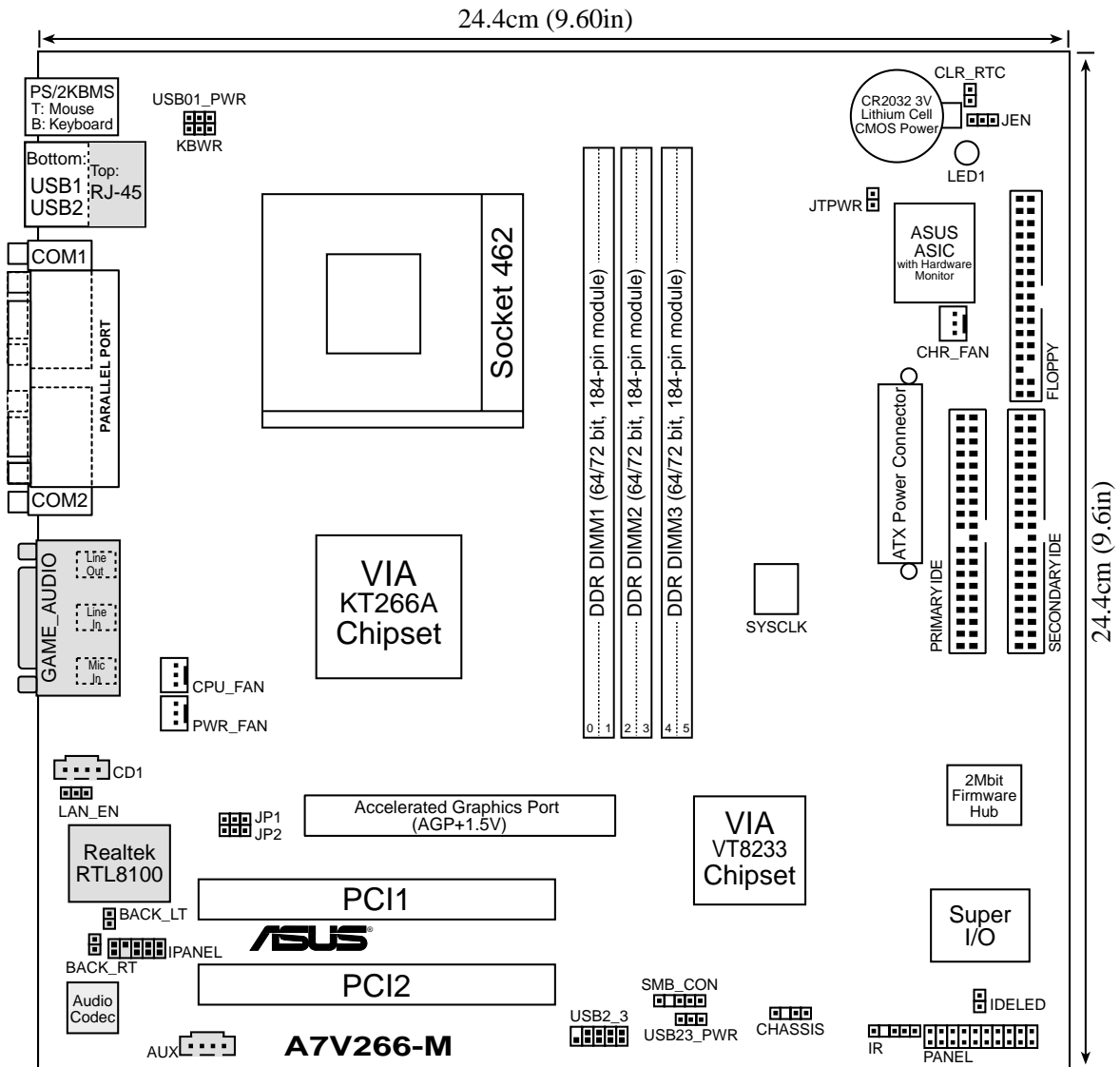

Optional components are grayed in the above motherboard layout.

2.2.1 Layout contents

CPU, Memory and Expansion Slots

- | | |
|---------------|--------------------------------------|
| 1) Socket 462 | p. 11 CPU Support |
| 2) DIMM 1/2/3 | p. 13 System Memory Support |
| 3) PCI 1/2 | p. 15 32-bit PCI Bus Expansion Slots |
| 4) AGP 4x | p. 18 Accelerated Graphics Slot |

Motherboard Settings (Switches and Jumpers)

- | | |
|----------------------|---|
| 1) JEN | p. 19 JumperFree Mode Setting (Disable / Enable) |
| 2) SYSCLK | p. 20 CPU External Frequency Selection (Switches 1–4) |
| 3) USB01_, USB23_PWR | p. 21 USB Device Wake-up (+5V / +5VSB) |
| 4) KBWK | p. 22 Keyboard Wake Up (Enable / Disable) |
| 5) LAN_EN | p. 23 LAN Enable (Enable / Disable) |
| 6) CLR_RTC | p. 24 Clear RTC RAM (2 pin) |

Connectors

- | | |
|------------------------|---|
| 1) PS2KBMS | p. 25 PS/2 Mouse Port (6 pin female) |
| 2) PS2KBMS | p. 25 PS/2 Keyboard Port (6 pin female) |
| 3) USB | p. 26 Universal Serial Bus Ports 1 & 2 (Two 4 pin female) |
| 4) PRINTER | p. 26 Parallel Port (25 pin female) |
| 5) COM1/COM2 | p. 26 Serial Ports (9 pin /10-1 pin male) |
| 6) GAME_AUDIO | p. 27 Game/MIDI Port (15 pin female) (<i>optional</i>) |
| 7) AUDIO | p. 27 Audio Connectors (Three 1/8" AUDIO) (<i>optional</i>) |
| 8) IDELED | p. 28 IDE Activity LED (2 pin) |
| 9) FLOPPY | p. 28 Floppy Disk Drive Connector (34 pin) |
| 10) PRIMARY / SEC. IDE | p. 29 IDE Connectors (Two 40-1 pin) |
| 11) CPU/PWR/CHA_FAN | p. 30 CPU, Power, and Chassis Fan Connectors (Three 3 pin) |
| 12) IR_CON | p. 31 Standard Infrared Module Connector (10-1 pin) |
| 13) ATXPWR | p. 32 ATX Power Supply Connector (20 pin) |
| 14) SMB | p. 32 SMBus Connector (5-1 pin) |
| 15) CD / AUX / MODEM | p. 33 Internal Audio Connectors (Three 4-1 pin) (<i>optional</i>) |
| 16) USB2_3 | p. 34 USB Headers (10-1 pin) |
| 17) JTPWR | p. 34 Power Supply Thermal Sensor Connector (2 pin) |
| 18) CHASSIS | p. 35 Chassis Intrusion Lead (2 pin) |
| 19) BACK_LT / BACK_RT | p. 35 Power Supply Thermal Sensor (2 pin) |
| 20) IPANEL | p. 36 ASUS Front Panel Audio Connector (10-1 pin) |
| 21) PLED (PANEL) | p. 37 System Power LED Lead (3 pin) |
| 22) KEYLOCK (PANEL) | p. 37 System Keyboard Lock Switch Lead (2 pin) |
| 23) SPEAKER (PANEL) | p. 37 System Warning Speaker Lead (4 pin) |
| 24) MLED (PANEL) | p. 37 System Message LED Lead (2 pin) |
| 25) SMI (PANEL) | p. 37 System Management Interrupt Lead (2 pin) |
| 26) PWR (PANEL) | p. 37 ATX / Soft-Off Switch Lead (2 pin) |
| 27) RESET (PANEL) | p. 37 Reset Switch Lead (2 pin) |

2.3 Before you proceed

Take note of the following precautions before you install motherboard components or change any motherboard settings.

CAUTION!



1. Unplug the power cord from the wall socket before touching any component.
 2. Use a grounded wrist strap or touch a safely grounded object or to a metal object, such as the power supply case, before handling components to avoid damaging them due to static electricity.
 3. Hold components by the edges and do not touch the ICs on them.
 4. Whenever you uninstall any component, place it on a grounded antistatic pad or in the bag that came with the component.
 5. **Before you install or remove any component, ensure that the ATX power supply is switched off or the power cord is detached from the power supply.** Failure to do so may cause severe damage to the motherboard, peripherals, and/or components.
-



NOTE! When lit, the onboard LED indicates that the system is ON, in sleep mode or in soft-off mode, not powered OFF. See the illustration below.

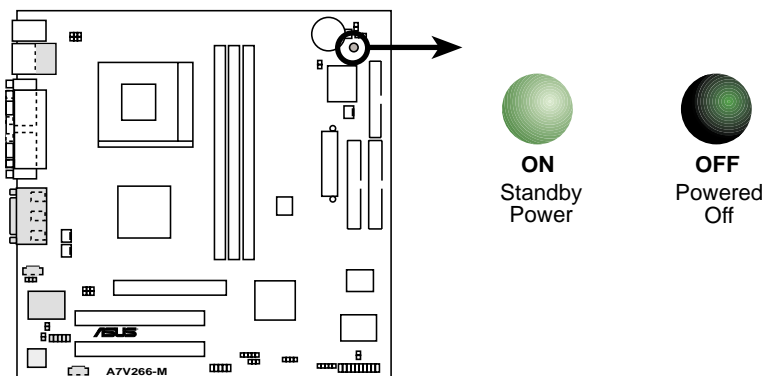

A7V266-M Onboard LED

2.4 Central Processing Unit (CPU)

2.4.1 Overview

The motherboard provides a Socket A (462) for CPU installation. A fan and heatsink should be attached to the CPU to prevent overheating.

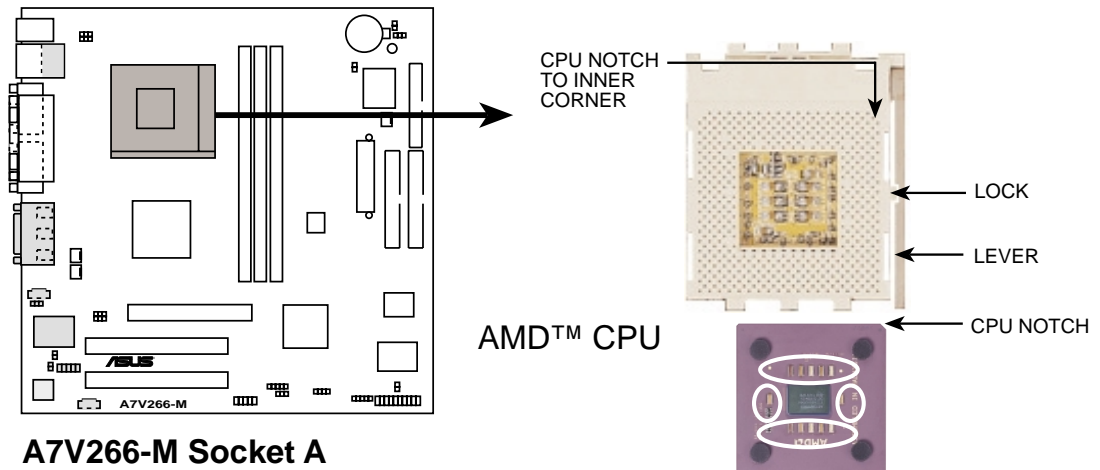

2.4.2 Installing the CPU

Follow these steps to install a CPU:

1. Locate the Socket 462 and open it by pulling the lever gently sideways away from the socket. Then lift the lever upwards. The socket lever must be fully opened (90 to 100 degrees).
2. Insert the CPU with the correct orientation. The **notched corner** of the CPU must be oriented toward the inner corner of the socket base nearest to the lever hinge.

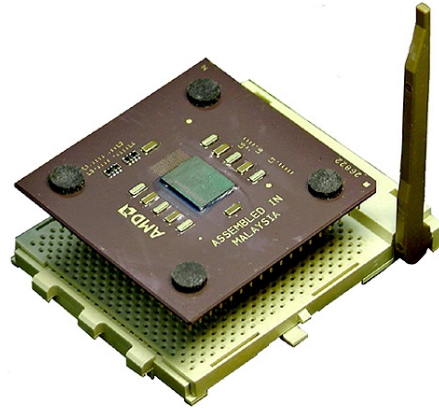

CAUTION! The CPU should drop easily into place. **Do not force the CPU** into the socket to avoid bending the pins. If the CPU does not fit, check its alignment and look for bent pins.

4. Once completely inserted, press the CPU firmly and close the socket lever until it snaps shut.
5. Place the CPU fan and heatsink on the CPU. The heatsink should entirely cover the CPU. Carefully attach the heatsink locking brace to the plastic clips on the socket base. With the added weight of the CPU fan and heatsink locking brace, no extra force is required to keep the CPU in place



CAUTION! Take care not to scrape the motherboard surface when mounting a clamp-style processor fan, or else damage may occur. When mounting a heatsink onto your CPU, make sure that exposed CPU capacitors do not touch the heatsink, or damage may occur!



NOTE! Do not neglect to set the correct Bus Frequency and leave the CPU Multiple setting at default to avoid start-up problems.

2.5 System memory

2.5.1 Overview

This motherboard uses *only* **Double Data Rate** (DDR) Synchronous Dynamic Random Access Memory (SDRAM) Dual Inline Memory Modules (DIMMs). These sockets support up to 3GB system memory using non-ECC PC200/266 DIMMs.

Each DIMM socket/module is two-sided: each side defines one “row” of memory. DIMMs come in combinations of single or double-sided types ranging through 64MB, 128MB, 256MB, 512MB and 1GB to form a total memory size of *64MB to 3GB*.

~ **Three (3)** sockets are available for both 266MHz-PC2100 or 200MHz-PC1600 DDR DIMMs to form a memory size of *64MB to 3GB*.

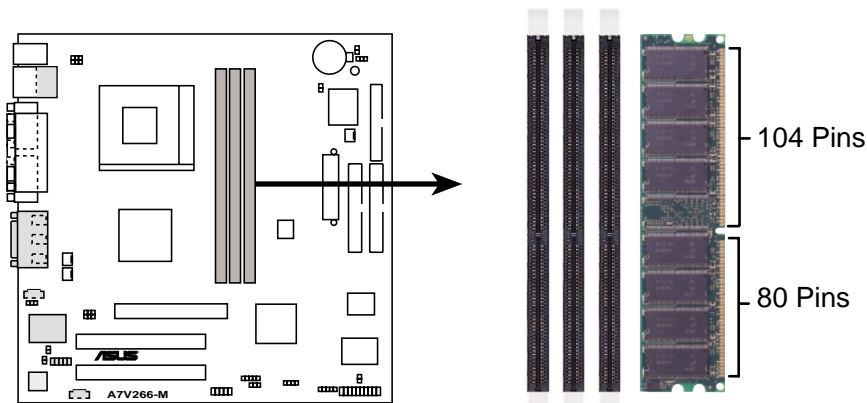

A7V266-M 184-Pin DDR DIMM Sockets



CAUTION! DIMMs are keyed to fit into notches with only one direction. DO NOT force a DIMM into a socket to avoid damaging the DIMM.



- **DIMMs with more than 18 chips are not supported.**
- ASUS motherboards support SPD (Serial Presence Detect) DIMMs. This is the memory of choice for best performance vs. stability
- BIOS shows DDR SDRAM memory on bootup screen.
- This motherboard supports three pairs of differential clock signals per DIMM.

2.5.2 Memory configurations

Install DIMMs in any of the following combinations.

DIMM Location	168-pin DIMM (SDR)	Total Memory
Socket 1 (Rows 0&1)	64MB, 128MB, 256MB, 512MB, 1GB x1	
Socket 2 (Rows 2&3)	64MB, 128MB, 256MB, 512MB, 1GB x1	
Socket 3 (Rows 4&5)	64MB, 128MB, 256MB, 512MB, 1GB x1	
Total system memory (Max. 3GB)		=

2.5.3 Installing a DIMM



CAUTION! Make sure to unplug the power supply before adding or removing DIMMs or other system components. Failure to do so may cause severe damage to both the motherboard and the components.

Installing a DIMM:

1. Unlock a DIMM socket by pressing the retaining clips outward.
2. Align a DIMM on the socket such that the notches on the DIMM exactly match the notches in the socket.
3. Firmly insert the DIMM into the socket until the retaining clips snap back in place.

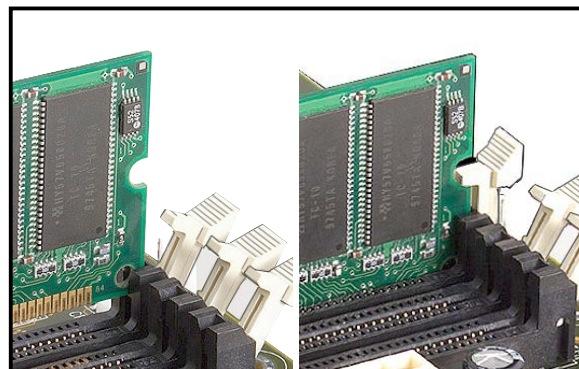
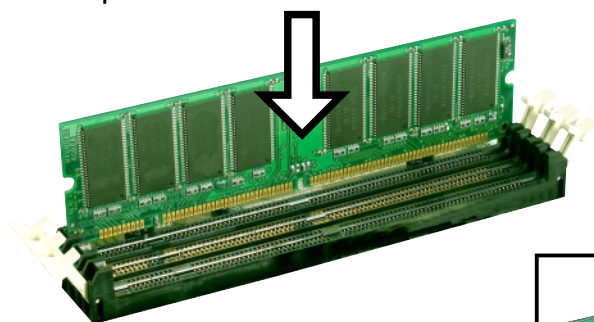

Unlocked Retaining Clip

Locked Retaining Clip

2.6 Expansion slots

The motherboard has two PCI slot and one Accelerated Graphics Port (AGP) slot.. The following sub-sections describe the slots and the expansion cards that they support.



WARNING! Unplug your power supply when adding or removing expansion cards or other system components. Failure to do so may cause you physical injury and damage motherboard components.

2.6.1 Installing an expansion card

Follow these steps to install an expansion card.

1. Before installing the expansion card, read the documentation that came with it and make the necessary hardware settings for the card.
2. Remove the system unit cover (if your motherboard is already installed in a chassis).
3. Remove the bracket opposite the slot that you intend to use. Keep the screw for later use.
4. Align the card connector with the slot and press firmly until the card is completely seated on the slot.
5. Secure the card to the chassis with the screw you removed earlier.
6. Replace the system cover.
7. Set up the BIOS if necessary.
8. Install the necessary software drivers for your expansion card.

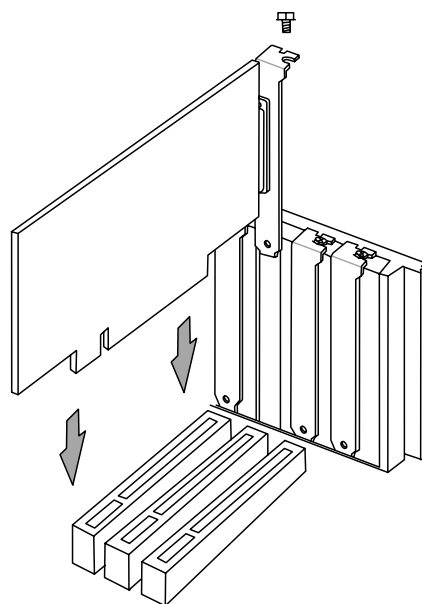

2.6.2 Configuring an expansion card

Some expansion cards need an IRQ to operate. Generally, an IRQ must be exclusively assigned to one function at a time. In a standard design configuration, 16 IRQs are available but most are already in use. Normally, 6 IRQs are free for expansion cards. If the motherboard has **PCI** audio onboard, an additional IRQ will be used. If your motherboard also has **MIDI** enabled, another IRQ will be used, leaving 4 IRQs free. Sometimes IRQs are “shared” by more than one function; in this case, IRQ assignments are swapped automatically or adjusted through the BIOS firmware.



IMPORTANT! When using PCI cards on shared slots, ensure that the drivers support “Share IRQ” or that the cards do not need IRQ assignments. Otherwise, conflicts will arise between the two PCI groups, making the system unstable and the card inoperable.

Standard Interrupt Assignments

This table lists the standard IRQ assignments for most PC devices.

IRQ	Priority	Standard Function
0	1	System Timer
1	2	Keyboard Controller
2	N/A	Programmable Interrupt
3*	11	Communications Port (COM2)
4*	12	Communications Port (COM1)
5*	13	Sound Card (sometimes LPT2)
6	14	Floppy Disk Controller
7*	15	Printer Port (LPT1)
8	3	System CMOS/Real Time Clock
9*	4	ACPI Mode when used
10*	5	IRQ Holder for PCI Steering
11*	6	IRQ Holder for PCI Steering
12*	7	PS/2 Compatible Mouse Port
13	8	Numeric Data Processor
14*	9	Primary IDE Channel
15*	10	Secondary IDE Channel

*These IRQs are usually available for ISA or PCI devices. IRQ assignments for this motherboard

Interrupt Request Table for this Motherboard

This table lists the default IRQ assignments for this motherboard. Use this table when configuring your system and for resolving IRQ conflicts.

	A	B	C	D	E	F	G	H
PCI slot 1	—	—	—	—	—	shared	—	—
PCI slot 2	—	—	—	—	—	—	used	—
Onboard USB controller HC0	—	—	—	used	—	—	—	—
Onboard USB controller HC1	—	—	—	—	—	—	—	shared
AGP	used	—	—	—	—	—	—	—
Onboard Audio	—	—	—	—	—	shared	—	—

2.6.3 PCI slots

Two 32-bit PCI slots are available on this motherboard. The slots support PCI cards such as a LAN card, SCSI card, USB card, and other cards that comply with PCI specifications.

This figure shows a typical PCI card installed into a slot:

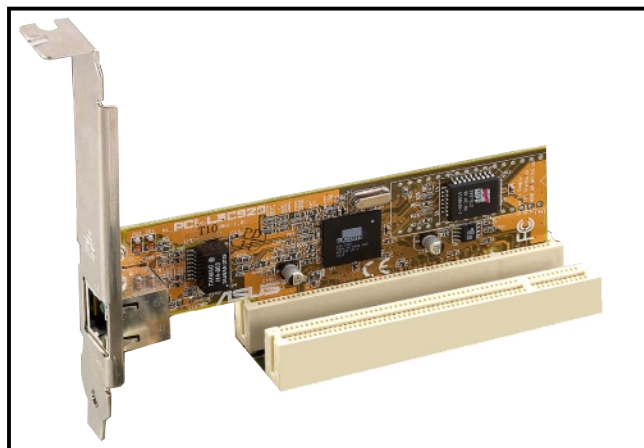

2.6.4 AGP slot

This motherboard provides an Accelerated Graphics Port (AGP 4X) slot to support AGP graphics cards. Take note of the notches on the card golden fingers to ensure that they fit the AGP slot on your motherboard. Below is an example of a +1.5V AGP card.

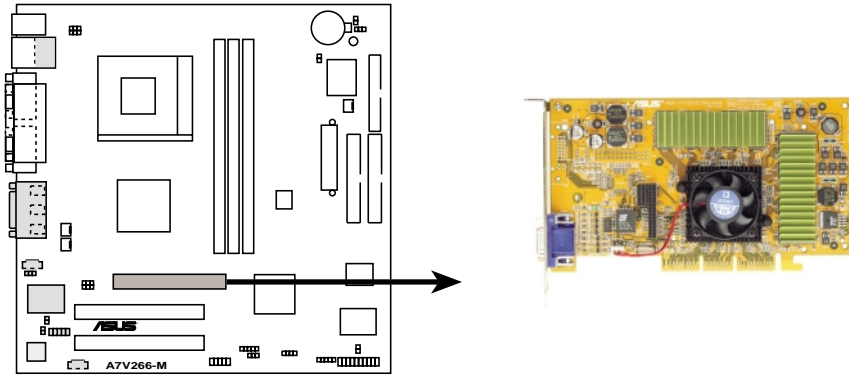

A7V266-M Accelerated Graphics Port (AGP)



CAUTION! To avoid damaging your AGP/AGP Pro graphics card, your computer's power supply should be unplugged before inserting your graphics card into the slot.

2.7 Switches and jumpers

Motherboard Frequency Settings (DIP Switches)

The motherboard frequency is adjusted through the DIP switches. The white block represents the switch's position. The illustration below shows all the switches in the OFF position.

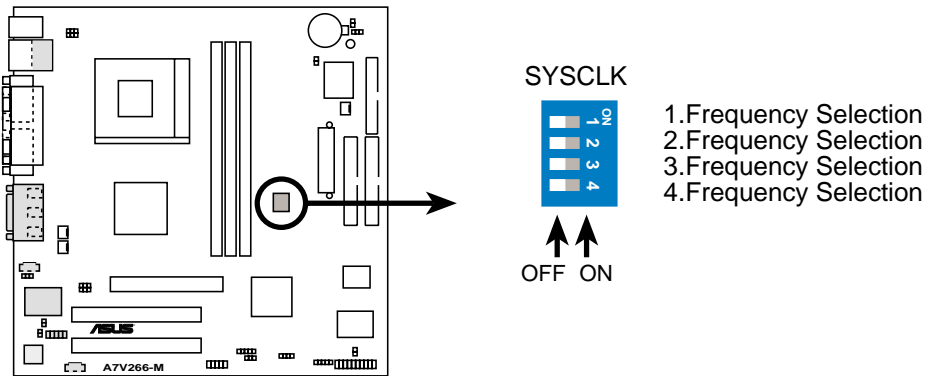

A7V266-M DIP Switch



IMPORTANT! To use the DSW switches to make changes to speed settings, the JEN jumper must be reset to pins 1-2 (jumper mode). Otherwise, setting the DSW switches does not produce any effect.

1) JumperFree™ Mode (JEN)

This jumper enables or disables the JumperFree™ mode. The JumperFree™ mode supports processor settings to be made through the BIOS setup.

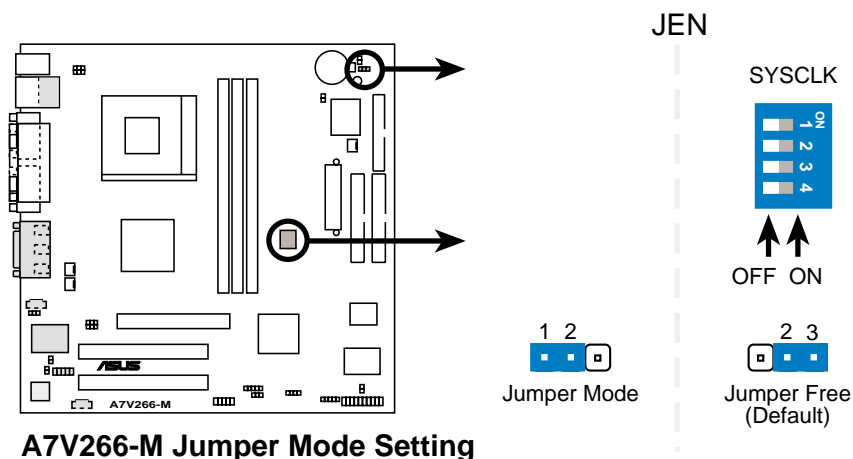

A7V266-M Jumper Mode Setting



NOTE! The JEN jumper is set in conjunction with the DIP switches. In JumperFree™ mode, set all DIP switches (DIP_SW) to OFF.

2) CPU External Frequency Selection (SYSCLK DSW Switches 1–4)

This option tells the clock generator which frequency to send to the CPU, DRAM, and the PCI bus. These switches permit selection of the CPU's *External* frequency (or *BUS Clock*). The BUS Clock multiplied by the Frequency Multiple equals the CPU's *Internal* frequency (the advertised CPU speed).

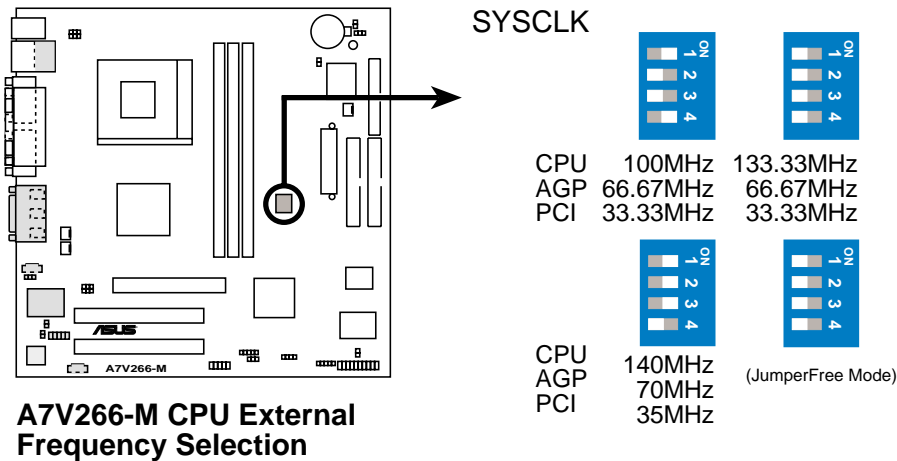

CPU	AGP	PCI	DSW1	DSW2	DSW3	DSW4
100	66.67	33.33	[ON]	[OFF]	[OFF]	[ON]
133	66.67	33.33	[OFF]	[OFF]	[OFF]	[OFF]
140	70	35	[ON]	[ON]	[ON]	[OFF]
JumperFree™ Mode			[OFF]	[OFF]	[OFF]	[OFF]



WARNING! Set the CPU frequency only to the recommended settings. Frequencies other than the recommended CPU bus frequencies are not guaranteed to be stable. Overclocking the processor is not recommended. It may result in a slower speed.



IMPORTANT! To use this feature, the JEN jumper must be set to JumperMode, [1-2].

3) USB Device Wake-up (USB01_PWR / USB23_PWR)

Set these jumpers to +5V to allow wake up from the S1 sleep state (CPU stopped; RAM refreshed; system running in low power mode) using the connected USB devices. Set to +5VSB to allow wake up from S3 sleep state (no power to CPU; RAM in slow refresh; power supply in reduced power mode). The default setting for the three jumpers is 1-2 to select +5V (because not all computers have the appropriate power supply).

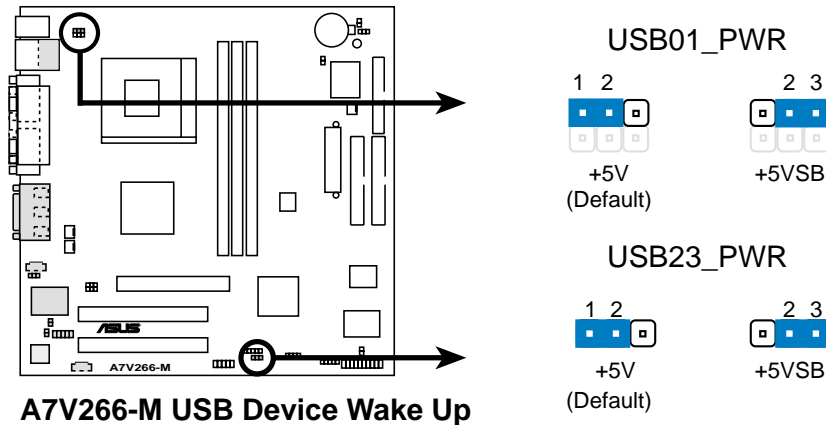

NOTE! This feature requires an ATX power supply that can supply at least 2A on the +5VSB lead when these jumpers are set to +5VSB. Otherwise, the system does not power up. The total current consumed must NOT exceed the power supply capability (+5VSB) whether under normal working conditions or in sleep mode.

4) Keyboard Wake Up (KBWK)

This jumper disables or enables the keyboard power up function. The default setting, [1-2], enables keyboard wake-up automatically. Retain the enabled setting if you wish to use your keyboard (by pressing <Spacebar>) to power up your computer. This feature requires an ATX power supply that can supply at least 300mA on the +5VSB lead; the computer will not power ON if you keep the setting *Enabled* but do not have the correct ATX power supply.

NOTE: This jumper must be set in conjunction with **Wake On PS2 KB/PS2 Mouse/CIR** in **4.5.1 Power Up Control**.

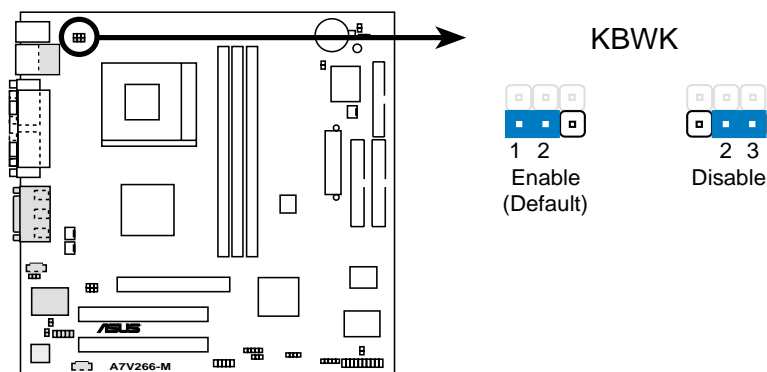

A7V266-M Keyboard Wake Up

5) LAN Enable (2 pin)

This jumper enables or disables the onboard LAN setting. The default position, [[2-3] enables the chipset. To free up resources, it may be necessary to disable [1-2] the onboard LAN circuit.

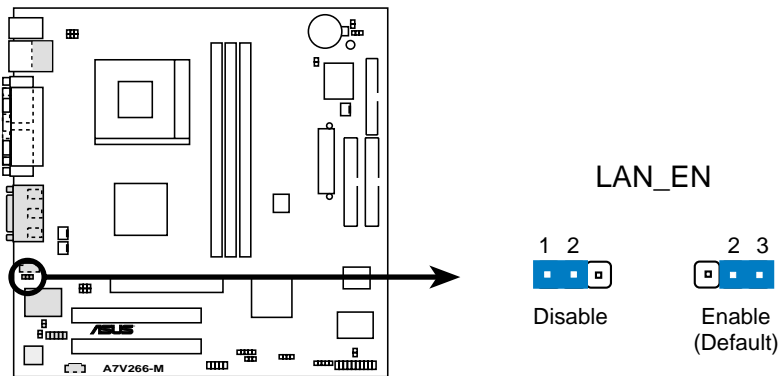

A7V266-M On Board LAN Setting

6) Clear RTC RAM (2-pin CLR_RTC)

This jumper allows you to clear the Real Time Clock (RTC) RAM in CMOS. You can clear the CMOS memory of date, time, and system setup parameters by erasing the CMOS RTC RAM data. The RAM data in CMOS, that include system setup information such as system passwords, is powered by the onboard button cell battery.

To erase the RTC RAM:

1. Turn OFF the computer and unplug the power cord.
2. Remove the battery.
3. Short the jumper by removing and replacing the jumper cap.
4. Re-install the battery.
5. Plug the power cord and turn ON the computer.
6. Hold down the key during the boot process and enter BIOS setup to re-enter data.

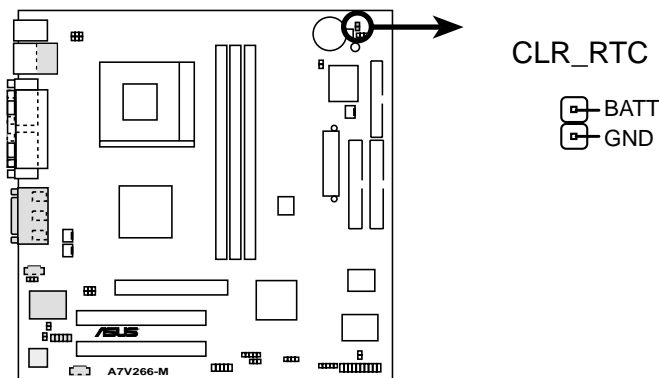

A7V266-M Clear RTC RAM

2.8 Connectors

This section describes and illustrates the internal connectors on the motherboard.



WARNING! Some pins are used for connectors or power sources. These are clearly distinguished from jumpers in the Motherboard Layout. Placing jumper caps over these connector pins will cause damage to your motherboard.



IMPORTANT! Ribbon cables should always be connected with the red stripe to Pin 1 in the connector socket.

1) PS/2 Mouse Port (Green 6-pin PS2KBMS)

The system automatically directs IRQ12 to the PS/2 mouse if one is detected. If no mouse is detected, IRQ12 become available to expansion cards. See **PS/2 Mouse Function Control** in **4.4 Advanced Menu**.

PS/2 Mouse (6-pin Female)

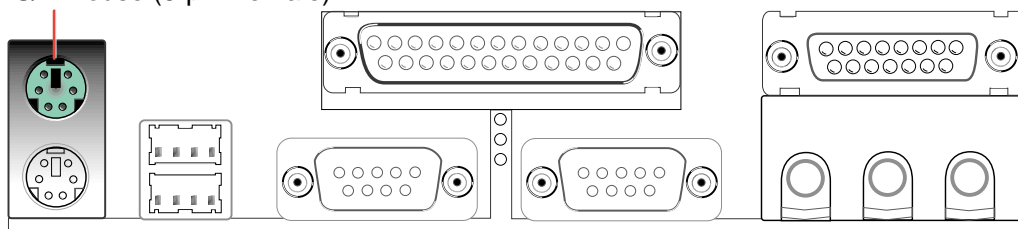

2) PS/2 Keyboard Port (Purple 6-pin PS2KBMS)

This connection is for a standard keyboard using an PS/2 plug (mini DIN). This connector does not allow standard AT size (large DIN) keyboard plugs. You may use a DIN to mini DIN adapter on standard AT keyboards.

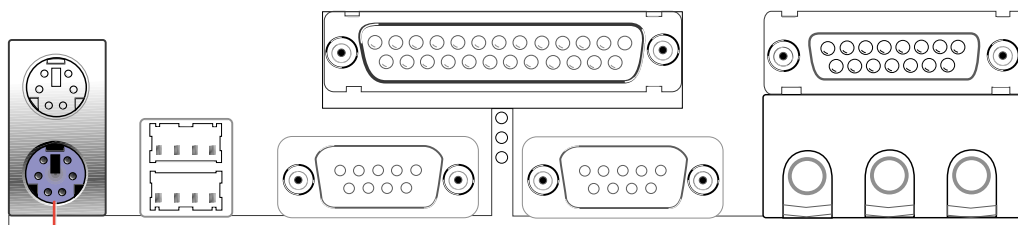

PS/2 Keyboard (6-pin Female)

3) Universal Serial Bus Ports 1 & 2 (Black two 4-pin USB)

Two USB ports are available for connecting USB devices.

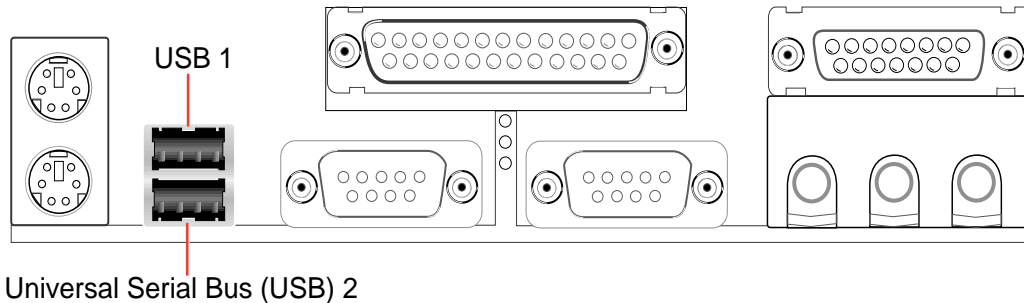

4) Parallel Port (Burgundy 25-pin PRINTER)

You can enable the parallel port and choose the IRQ through **Onboard Parallel Port** (see **4.4.2 I/O Device Configuration**).



NOTE! Serial printers must be connected to the serial port.

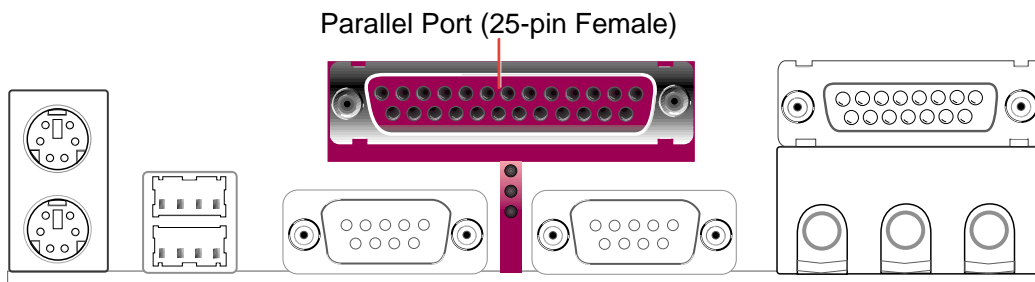

5) Serial Ports (Teal/Turquoise 9-pin COM1 / 9-pin COM2)

Two serial ports can be used for pointing devices or other serial devices. To enable these ports, see **Onboard Serial Port 1 / Onboard Serial Port 2** in **4.4.2 I/O Device Configuration** for the settings.

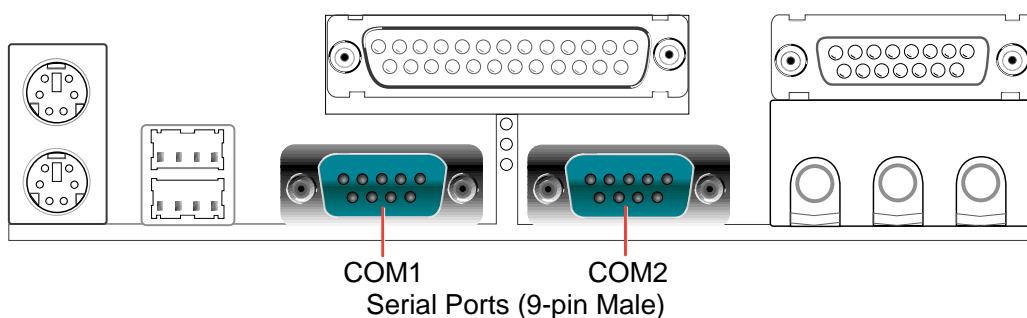

6) Game/MIDI Ports (Gold 15-pin GAME_AUDIO) (optional)

This connector supports a joystick or a game pad for playing games, and MIDI devices for playing or editing audio files.

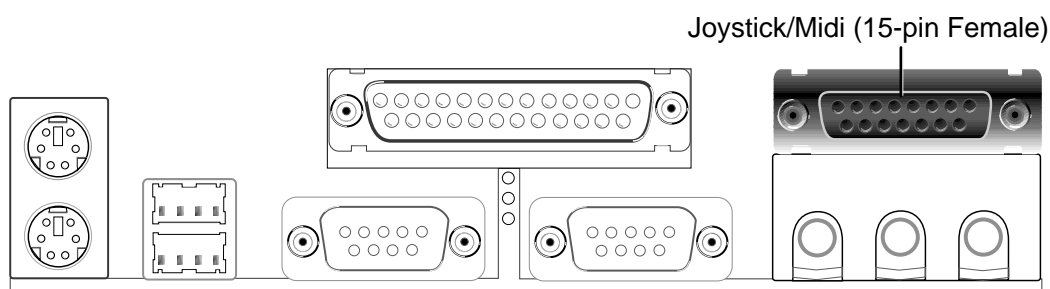

7) Audio Connectors (Three 1/8" AUDIO) (optional)

The **Line Out** (lime) connects a headphone or speakers. The **Line In** (light blue) connects a tape players or other audio sources. The **Mic** (pink) connects a microphone.



NOTE! The functions of the audio connectors Line Out, Line In, and Mic change when the 6-channel audio feature is enabled. Refer to **Chapter 5. SOFTWARE SETUP**.

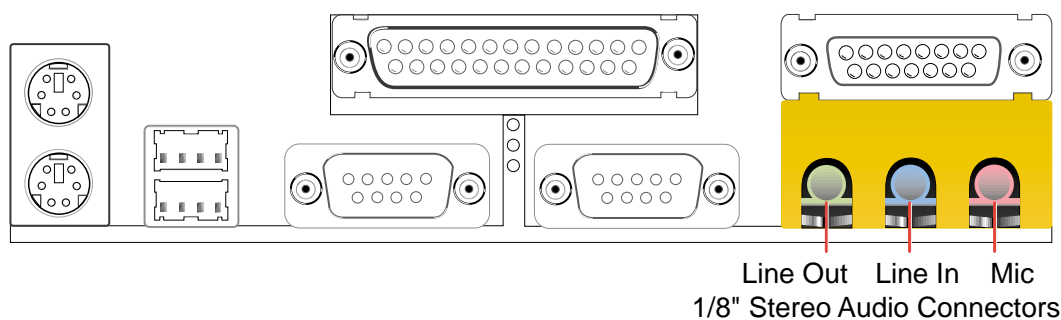

8) IDE Activity LED (2-pin IDELED)

This connector supplies power to the cabinet's IDE activity LED. Read and write activity by devices connected to the Primary or Secondary IDE connectors cause the IDE LED to light up.

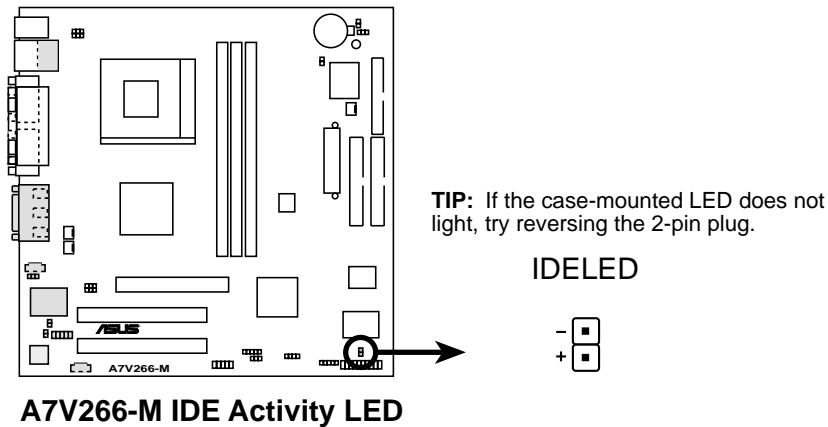

9) Floppy Disk Drive Connector (34-1 pin FLOPPY)

This connector supports the provided floppy drive ribbon cable. After connecting the single end to the board, connect the two plugs on the other end to the floppy drives. **(Pin 5 is removed to prevent inserting in the wrong orientation when using ribbon cables with pin 5 plugged).**

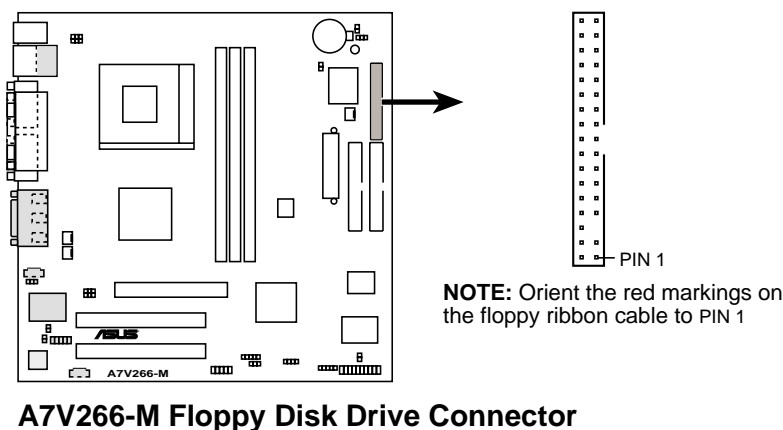

10) Primary (Blue) / Secondary (Black) IDE Connectors (40-pin PRIMARY IDE and SECONDARY IDE)

These connectors support the IDE hard disk ribbon cables supplied with the motherboard. Connect the cable's blue connector to the motherboard's *primary* IDE connector (recommended) or the secondary IDE connector. Then connect the opposite end of the cable to your hard disk. A second slave hard disk may be attached to the intermediate connector on the cable; it may be necessary to reset its jumper to *Slave* mode. Refer to your hard disk documentation for the jumper settings. It is recommended that non-ATA-100/66 devices be connected to the *secondary* IDE connector. BIOS now supports specific device bootup (**see 4.6 Boot Menu.**)



NOTE: ATA-100 is backward compatible with ATA-66 and ATA-33 as with all existing ATA devices and systems; there is no need to upgrade current EIDE/IDE drives and host systems. ATA-66 and ATA-100 IDE devices require a 40-pin 80-conductor cable and RAID arrays *only operate* with such cables.

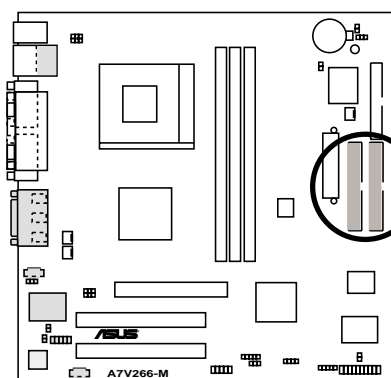

A7V266-M IDE Connectors

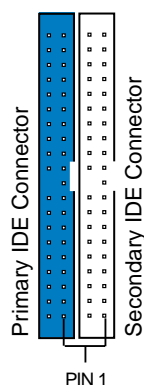

NOTE: Orient the red markings (usually zigzag) on the IDE ribbon cable to PIN 1.

11) CPU Fan, Power Fan, and Chassis Fan Connectors (CPU_, PWR_, CHA_FAN)

Three fan connectors support cooling fans of 350mA (4.2 Watts) or less. Orient the fans so that airflow flows across the onboard heat sinks instead of expansion slots. The fan wiring and plug vary depending on the type employed. Connect the fan cable to the connector, ensuring that the black wire matches the ground pin. (Use the "Rotation" signal only with a specially designed fan with a rotation signal. You can monitor the Rotations Per Minute (RPM) using ASUS PC Probe (see **6. SOFTWARE REFERENCE**).



WARNING! Make sure to connect the fan cables to the fan connectors. Lack of sufficient airflow within the system could cause damage to the motherboard. **These are not jumpers, do not place jumper caps over these connectors!**

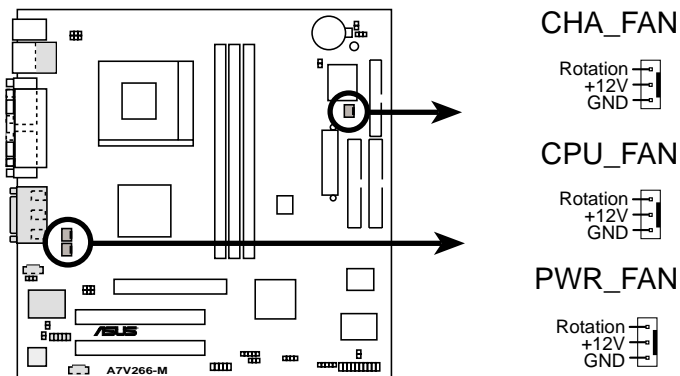

A7V266-M 12-Volt Cooling Fan Power

12) Infrared Module Connector (10-1 pin IR_CON)

This connector supports an optional wireless transmitting and receiving infrared module. This module mounts to a small opening on system cases that support it. Configure the IR setting through **UART2 Use Infrared** to select whether UART2 is directed for use with COM2 or IrDA (see **4.4.2 I/O Device Configuration**). Use the five pins as shown and connect a ribbon cable from the module to the motherboard SIR connector according to the pin definitions. (A SIR module does not come with the motherboard package. The CIR module is currently unavailable.)

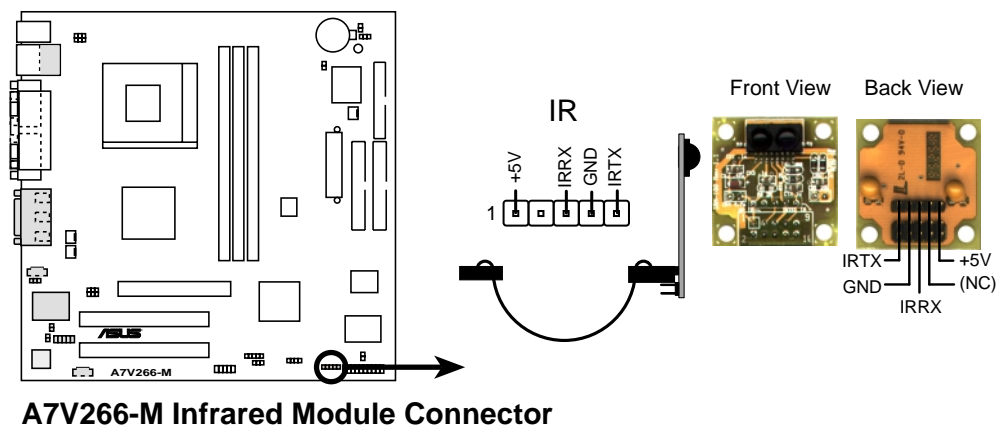

13) Power Supply Connectors (20-pin block ATXPWR)

This connector supports an ATX 12V power supply. The plug from the power supply fits in only one orientation. Push down firmly ensuring that the pins are aligned.



IMPORTANT! Make sure that the ATX 12V power supply (minimum recommended wattage: 230W) can supply at least 10mA on the +5-volt standby lead (+5VSB). The system may become unstable and may experience difficulty powering up if the power supply is inadequate. For Wake-On-LAN support, the ATX power supply must supply at least 720mA +5VSB.

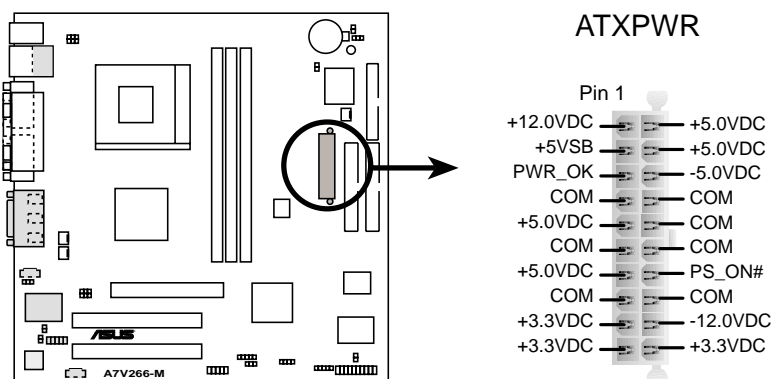

A7V266-M ATX Power Connectors

14) SMBus Connector (5-1 pin SMB)

This connector allows you to connect SMBus (System Management Bus) devices. SMBus devices communicate by means of the SMBus with an SMBus host and/or other SMBus devices. SMBus is a multi-device bus that permits multiple chips to connect to the same bus and enable each one to act as a master by initiating data transfer.

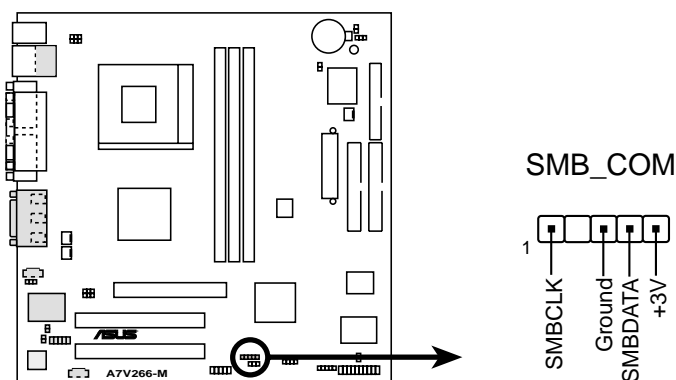

A7V266-M SMBus Connector

15) Internal Audio Connectors (4-1 pin CD, AUX, MODEM) (*optional*)

These connectors allow you to receive stereo audio input from sound sources as a CD-ROM, TV tuner, or MPEG card. The MODEM connector allows the onboard audio to interface with a voice modem card with a similar connector. It also allows the sharing of mono_in (such as a phone) and a mono_out (such as a speaker) between the audio and a voice modem card.

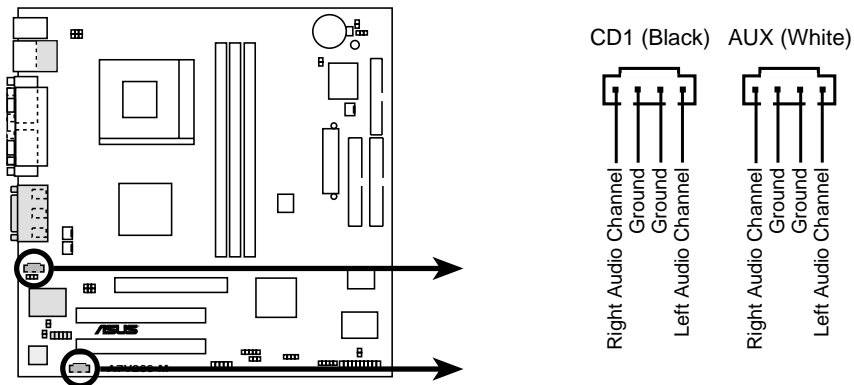

ASUS A7V266-M Internal Audio Connectors

16) USB Headers (10-1 pin USB2_3)

If the USB port connectors on the back panel are inadequate, two USB headers are available for four additional USB port connectors. Connect a 2-port USB connector set to a USB header and mount the USB bracket to an open slot in the chassis. (The USB connector set is optional and does not come with the motherboard package.)

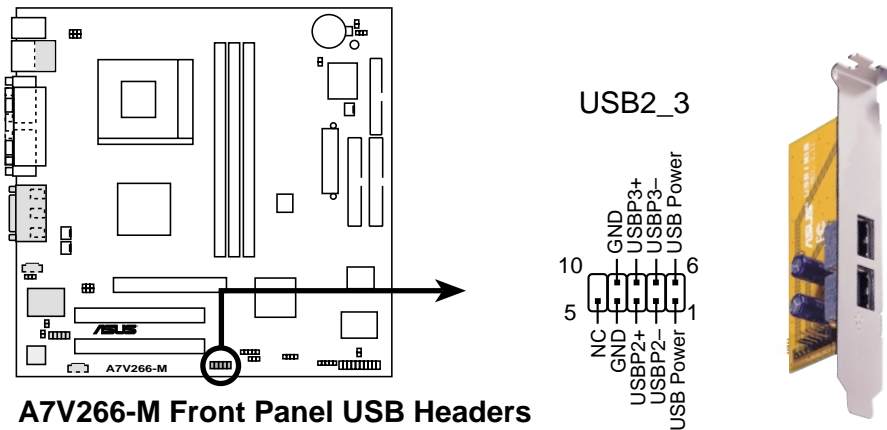

A7V266-M Front Panel USB Headers

17) Power Supply Thermal Sensor Connector (2 pin JTPWR)

If you have a power supply with thermal monitoring, connect its thermal sensor cable to this connector.

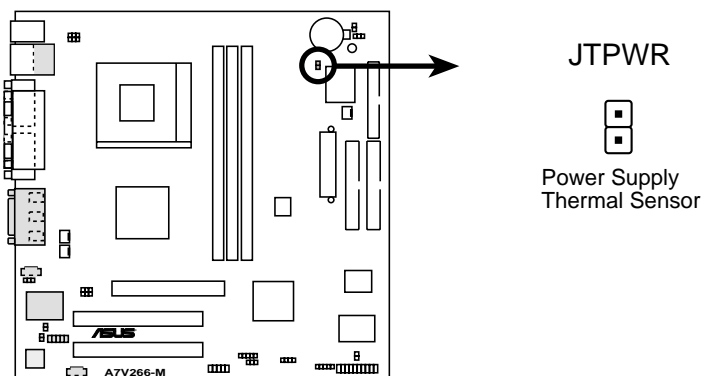

A7V266-M Thermal Sensor Connector

18) Chassis Open Alarm Lead (4 pin CHASSIS)

This lead is for a chassis designed for chassis intrusion detection. This requires an external detection mechanism such as a chassis intrusion monitor/sensor or microswitch. When any chassis component is removed, the sensor is triggered and a high-level signal is sent to this lead to record a chassis intrusion event. The event is then be processed by software such as LDCM. When not using the chassis intrusion lead, place a jumper cap over the pins to close the circuit.

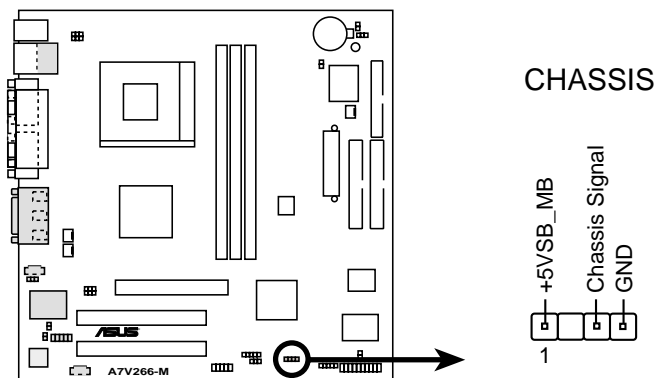

A7V266-M Chassis Open Alarm Lead

19) Line-out Selector Jumpers (24-1 pin BACK_LT / BACK_RT)

By default, these jumpers are shorted (jumpers on) to route the signal from the audio controller to the rear panel Line Out jack to make it available for audio out devices such as speakers or a headphone. If you connect the Intel Front Panel audio cable to the IAPANEL connector (see next page), then remove the caps from these two jumpers to permit automatic switching of audio signals between the rear panel Line Out jack and the Intel audio cable.

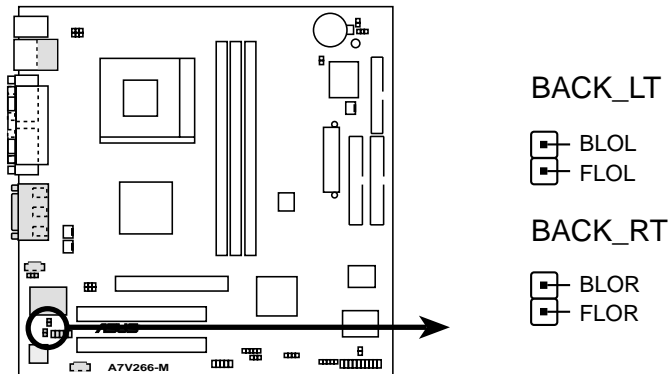

A7V266-M Internal Line Out Jumpers

20) ASUS Front Audio Connector (10-1 pin IPANEL)

Connect the audio cable to this for front panel audio control.

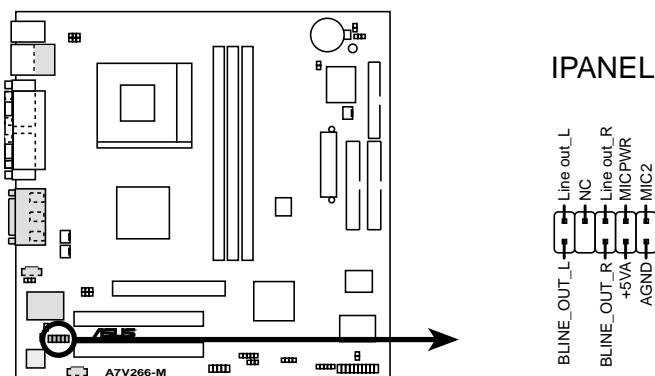

A7V266-M Front Panel Audio Connector

The following 20-pin PANEL illustration is for items 21-30.

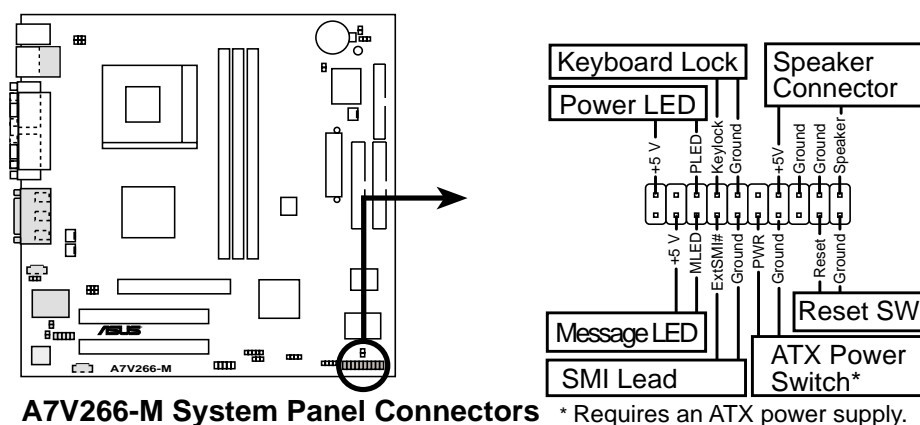

21) System Power LED Lead (3-1 pin PLED)

This 3-1 pin connector supplies the system power LED. The LED lights up when the system power is on, and the LED blinks when the system is in sleep or soft-off mode.

22) Keyboard Lock Switch Lead (2-pin KEYLOCK)

This 2-pin connector supplies the case-mounted key switch for keyboard locking.

23) System Warning Speaker Lead (4-pin SPEAKER)

This 4-pin connector supplies the case-mounted speaker to sound system beeps and warnings.

24) System Message LED Lead (2-pin MLED)

This 2-pin connector supports the system message LED to indicate receipt of messages from a fax/modem. The normal status for this LED is ON, when there is no incoming data signal. The LED blinks when data is received. The system message LED feature requires an ACPI OS and driver support.

25) System Management Interrupt Lead (2-pin SMI)

This 2-pin connector permits switching to suspend mode, or "Green" mode, in which system activity is instantly decreased to save power and to expand the life of certain system components. Attach the case-mounted suspend switch this 2-pin connector.

26) ATX Power Switch / Soft-Off Switch Lead (2-pin PWR)

The system power is controlled by a momentary switch attached to this connector. Pressing the button switches the system between ON and SLEEP, or ON and SOFT OFF, depending on the BIOS or OS settings. Pressing the button while in the ON mode for more than 4 seconds turns the system off.

27) Reset Switch Lead (2-pin RESET)

This 2-pin connector supports the case-mounted reset switch for rebooting the system without turning off the power switch.



Chapter 3

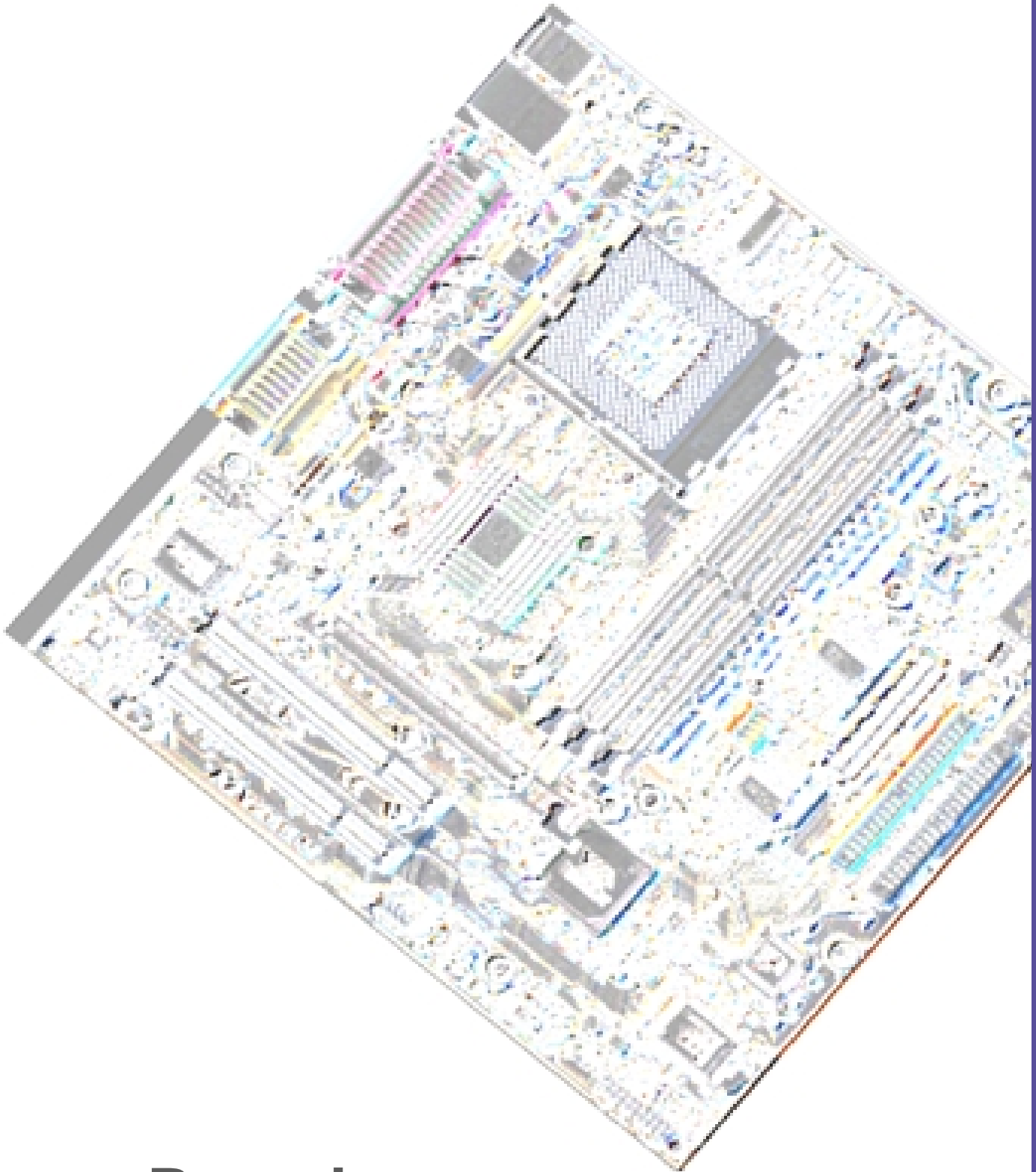

Powering up

3.1 Starting up for the first time

1. After making all the connections, replace the system case cover.
2. Be sure that all switches are off.
3. Connect the power cord to the power connector at the back of the system chassis.
4. Connect the power cord to a power outlet that is equipped with a surge protector.
5. Turn on the devices in the following order:
 - a. Monitor
 - b. External SCSI devices (starting with the last device on the chain)
 - c. System power: For ATX power supplies: switch on the power supply and press the ATX power switch.
6. After applying power, the power LED on the system front panel case lights up. For ATX power supplies, the system LED lights up when you press the ATX power switch. If your monitor complies with “green” standards or if it has a “power standby” feature, the monitor LED may light up or switch between orange and green after the system LED turns on. The system then runs the power-on tests. While the tests are running, the BIOS beeps or additional messages appear on the screen. If you do not see anything within 30 seconds from the time you turned on the power, the system may have failed a power-on test. Check the jumper settings and connections or call your retailer for assistance.
7. At power on, hold down <Delete> to enter BIOS Setup. Follow the instructions in Chapter 4.

Award BIOS Beep Codes

Beep	Meaning
One short beep when displaying logo	No error during POST
Long beeps in an endless loop	No DRAM installed or detected
One long beep followed by three short beeps	Video card not found or video card memory bad
High frequency beeps when system is working	CPU overheated; System running at a lower frequency



NOTE! You will not hear the BIOS beeps when the ASUS POST Reporter is enabled. You will hear the vocal POST messages instead.

3.3 Powering off the computer

You must first exit the operating system and shut down the system before switching off the power. For ATX power supplies, you can press the ATX power switch after exiting or shutting down the operating system. If you use Windows 95/98/2000/XP, click the Start button, click Shut Down, then click the OK button to shut down the computer. The power supply should turn off after Windows shuts down.



NOTE! The message “You can now safely turn off your computer” does not appear when shutting down with ATX power supplies.

Chapter 4

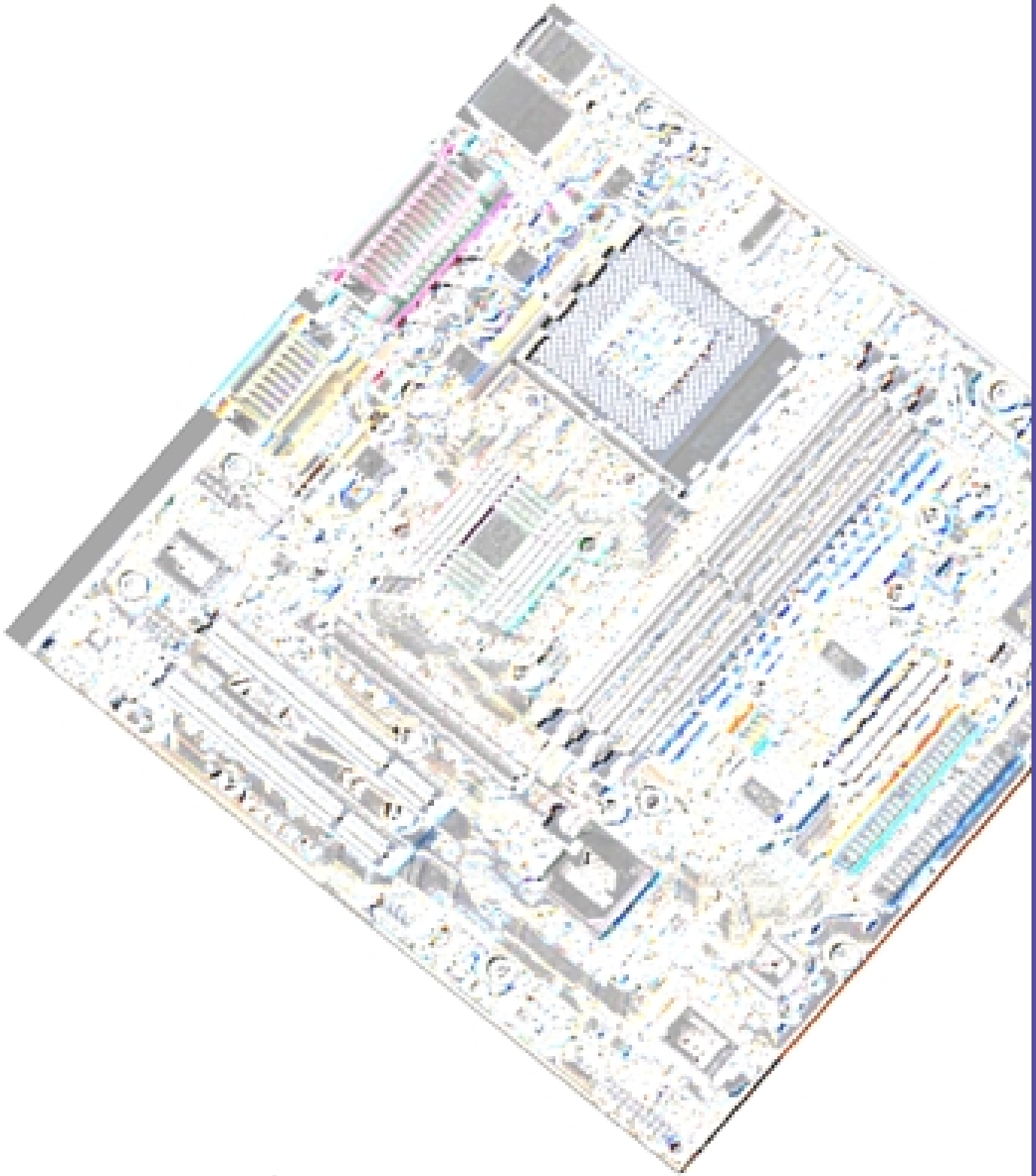

BIOS setup

4.1 Managing and updating your BIOS

4.1.1 Using the computer system for the first time

It is recommended that you save a copy of the original motherboard BIOS along with a Flash Memory Writer utility (AFLASH.EXE) to a bootable floppy disk in case you need to reinstall the BIOS later. AFLASH.EXE is a Flash Memory Writer utility that updates the BIOS by uploading a new BIOS file to the programmable flash ROM on the motherboard. This file works only in DOS mode. To determine the BIOS version of your motherboard, check the last four numbers of the code displayed on the upper left-hand corner of your screen during bootup. Larger numbers represent a newer BIOS file.

1. Type `FORMAT A:/S` at the DOS prompt to create a bootable system disk. DO NOT copy `AUTOEXEC.BAT` and `CONFIG.SYS` to the disk.
2. Type `COPY D:\AFLASH\AFLASH.EXE A:\` (assuming D is your CD-ROM drive) to copy `AFLASH.EXE` to the boot disk you created.



NOTE! AFLASH works only in DOS mode. It does not work in the DOS prompt within Windows, and does not work with certain memory drivers that may be loaded when you boot from the hard drive. It is recommended that you reboot using a floppy disk.

3. Reboot the computer from the floppy disk.



NOTE! BIOS setup must specify “Floppy” as the first item in the boot sequence.

4. In DOS mode, type `A:\AFLASH <Enter>` to run AFLASH.

```
ASUS ACPI BIOS
FLASH MEMORY WRITER U1.29
Copyright (C) 1994-99, ASUSTeK COMPUTER INC.

Flash Memory: Winbond W29C020 or SST 29EE020 or Intel B2802AB

Current BIOS Version: ASUS XXX-XX ACPI BIOS Revision 100X
BIOS Model          : XXX-XX
BIOS Built Date     : 09/25/98

Choose one of the followings:

1. Save Current BIOS To File
2. Update BIOS Including Boot Block and ESCD

Enter choice: [1]

Press ESC To Exit
```



IMPORTANT! If the word “unknown” appears after Flash Memory:, the memory chip is either not programmable or is not supported by the ACPI BIOS and therefore, cannot be programmed by the Flash Memory Writer utility.

5. Select 1. Save Current BIOS to File from the Main menu and press <Enter>. The Save Current BIOS To File screen appears.

```
Save Current BIOS To File
Flash Memory: Winbond W29C020 or SST 29EE020 or Intel 82802AB
Current BIOS Version: ASUS XXX-XX ACPI BIOS Revision 100X
BIOS Model          : XXX-XX
BIOS Built Date     : 09/25/98
Please Enter File Name to Save: XXX-XX.XXX

BIOS Saved Successfully
Press ESC To Continue
```

6. Type a filename and the path, for example, A:\XXX-XX.XXX, then press <Enter>.

4.1.2 Updating BIOS procedures



CAUTION! Update the BIOS only if you have problems with the motherboard and you are sure that the new BIOS revision will solve your problems. Careless updating may result to more problems with the motherboard!

1. FTP) (see ASUS CONTACT INFORMATION on page x for details) and save to the boot floppy disk you created earlier.
2. Boot from the floppy disk.
3. At the "A:\:" prompt, type AFLASH and then press <Enter>.
4. At the Main Menu, type 2 then press <Enter>. The Update BIOS Including Boot Block and ESCD screen appears.
5. Type the filename of your new BIOS and the path, for example, A:\XXX-XX.XXX, then press <Enter>.

To cancel this operation, press <Enter>.

```
Update BIOS Including Boot Block and ESCD
Flash Memory: Winbond W29C020 or SST 29EE020 or Intel 82802AB
Current BIOS Version: ASUS XXX-XX ACPI BIOS Revision 100X
BIOS Model          : XXX-XX
BIOS Built Date     : 09/25/98
Please Enter File Name for NEW BIOS: A:\XXX-XX.XXX
```

6. When prompted to confirm the BIOS update, press Y to start the update.

```
Update BIOS Including Boot Block and ESCD
Flash Memory: Winbond W29C020 or SST 29EE020 or Intel 82802AB
BIOS Version
[CURRENT ] ASUS XXX-XX ACPI BIOS Revision 100X
[test.awd] ASUS XXX-XX ACPI BIOS Revision 100X
BIOS Model
[CURRENT ] XXX-XX
[test.awd] XXX-XX
Date of BIOS Built
[CURRENT ] 09/25/99
[XXXX.XXX] 05/29/00
Check sum of 1001.010 is F266.
Are you sure (Y/N) ? [Y]
Press ESC To Return to Main Menu
```

7. The utility starts to program the new BIOS information into the Flash ROM. The boot block is updated automatically only when necessary. This minimizes the possibility of boot problems in case of update failures. When the programming is done, the message “*Flashed Successfully*” appears.

```
Update BIOS Including Boot Block and ESCD
Flash Memory: Winbond W29C020 or SST 29EE020 or Intel 82802AB
BIOS Version
[CURRENT] ASUS XXX-XX ACPI BIOS Revision 100X
[test.awd] ASUS XXX-XX ACPI BIOS Revision 100X
BIOS Model
[CURRENT] XXX-XX
[test.awd] XXX-XX
Date of BIOS Built
[CURRENT] 09/25/99
[XXXX.XXX] 05/29/00
Check sum of 1001.010 is F266.
Are you sure (Y/N) ? [Y]
Block Erasing -- Done
Programming -- 3FFF
Flashed Successfully
Press ESC To Continue
```

8. Follow the onscreen instructions to continue.

```
ASUS ACPI BIOS
FLASH MEMORY WRITER V1.29
Copyright (C) 1994-99, ASUSTeK COMPUTER INC.
Flash Memory: Winbond W29C020 or SST 29EE020 or Intel 82802AB
Current BIOS Version: ASUS XXX-XX ACPI BIOS Revision 100X
BIOS Model : XXX-XX
BIOS Built Date : 05/29/99
Choose one of the followings:
1. Save Current BIOS To File
2. Update BIOS Including Boot Block and ESCD
Enter choice: [1]
You have flashed the EPROM: It is recommended that you turn off
the power, enter SETUP and LOAD Setup Defaults to have CMOS
updated with new BIOS when exits.
Press ESC To Exit
```



WARNING! If you encounter problems while updating the new BIOS, DO NOT turn off the system because this may cause boot problems. Just repeat the process, and if the problem persists, load the original BIOS file you saved to the boot disk. If the Flash Memory Writer utility is not able to successfully update a complete BIOS file, the system may not boot. If this happens, call the ASUS service center for support.

4.2 BIOS Setup program

This motherboard supports a programmable EEPROM that you can update using the provided utility described in section “4.1 Managing and updating your BIOS.”

Use the BIOS Setup program when you are installing a motherboard, reconfiguring your system, or prompted to “Run Setup”. This section explains how to configure your system using this utility.

Even if you are not prompted to use the Setup program, you may want to change the configuration of your computer in the future. For example, you may want to enable the security password feature or make changes to the power management settings. This requires you to reconfigure your system using the BIOS Setup program so that the computer can recognize these changes and record them in the CMOS RAM of the EEPROM.

The EEPROM on the motherboard stores the Setup utility. When you start up the computer, the system provides you with the opportunity to run this program. Press <Delete> during the Power-On Self Test (POST) to enter the Setup utility, otherwise, POST continues with its test routines.

If you wish to enter Setup after POST, restart the system by pressing <Ctrl> + <Alt> + <Delete>, or by pressing the reset button on the system chassis. You can also restart by turning the system off and then back on. Do this last option only if the first two failed.

The Setup program is designed to make it as easy to use as possible. It is a menu-driven program, which means you can scroll through the various sub-menus and make your selections among the predetermined choices.



NOTE! Because the BIOS software is constantly being updated, the following BIOS setup screens and descriptions are for reference purposes only, and may not exactly match what you see on your screen.

4.2.1 BIOS menu bar

The top of the screen has a menu bar with the following selections:

- MAIN** Use this menu to make changes to the basic system configuration.
- ADVANCED** Use this menu to enable and make changes to the advanced features.
- POWER** Use this menu to configure and enable Power Management features.
- BOOT** Use this menu to configure the default system device used to locate and load the Operating System.
- EXIT** Use this menu to exit the current menu or to exit the Setup program.

To access the menu bar items, press the right or left arrow key on the keyboard until the desired item is highlighted.

4.2.2 Legend bar

At the bottom of the Setup screen is a legend bar. The keys in the legend bar allow you to navigate through the various setup menus. The following table lists the keys found in the legend bar with their corresponding functions.

Navigation Key(s)	Function Description
<F1> or <Alt + H>	Displays the General Help screen from anywhere in the BIOS Setup
<Esc>	Jumps to the Exit menu or returns to the main menu from a sub-menu
Left or Right arrow	Selects the menu item to the left or right
Up or Down arrow	Moves the highlight up or down between fields
- (minus key)	Scrolls backward through the values for the highlighted field
+ (plus key) or spacebar	Scrolls forward through the values for the highlighted field
<Enter>	Brings up a selection menu for the highlighted field
<Home> or <PgUp>	Moves the cursor to the first field
<End> or <PgDn>	Moves the cursor to the last field
<F5>	Resets the current screen to its Setup Defaults
<F10>	Saves changes and exits Setup

General help

In addition to the Item Specific Help window, the BIOS setup program also provides a General Help screen. You may launch this screen from any menu by simply pressing <F1> or the <Alt> + <H> combination. The General Help screen lists the legend keys and their corresponding functions.

Saving changes and exiting the Setup program

See “4.7 Exit Menu” for detailed information on saving changes and exiting the setup program.

Scroll bar

When a scroll bar appears to the right of a help window, it indicates that there is more information to be displayed that will not fit in the window. Use <PgUp> and <PgDn> or the up and down arrow keys to scroll through the entire help document. Press <Home> to display the first page, press <End> to go to the last page. To exit the help window, press <Enter> or <Esc>.

Sub-menu

Note that a right pointer symbol (as shown on the left) appears to the left of certain fields. This pointer indicates that you can display a sub-menu from this field. A sub-menu contains additional options for a field parameter. To display a sub-menu, move the highlight to the field and press <Enter>. The sub-menu appears. Use the legend keys to enter values and move from field to field within a sub-menu as you would within a menu. Use the <Esc> key to return to the main menu. Take some time to familiarize yourself with the legend keys and their corresponding functions. Practice navigating through the various menus and sub-menus. If you accidentally make unwanted changes to any of the fields, use the set default hot key <F5> to load the Setup default values. While moving around through the Setup program, note that explanations appear in the Item Specific Help window located to the right of each menu. This window displays the help text for the currently highlighted field.

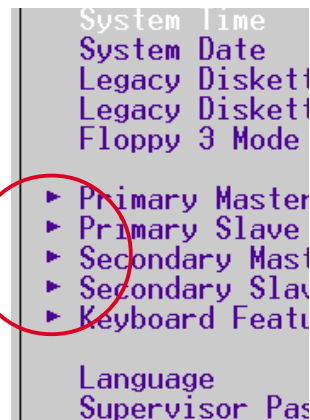

4.3 Main Menu

When you enter the Setup program, the following screen appears.

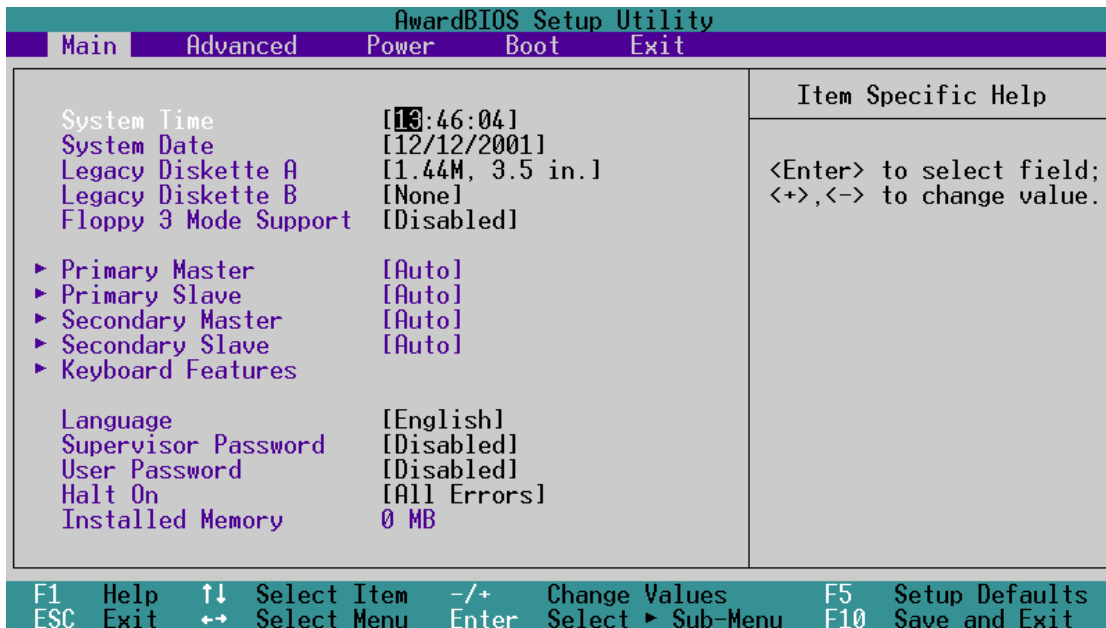

System Time [XX:XX:XX]

Sets the system to the time that you specify (usually the current time). The format is hour, minute, second. Valid values for hour, minute and second are Hour: (00 to 23), Minute: (00 to 59), Second: (00 to 59). Use the <Tab> or <Shift> + <Tab> keys to move between the hour, minute, and second fields.

System Date [XX/XX/XXXX]

Sets the system to the date that you specify (usually the current date). The format is month, day, year. Valid values for month, day, and year are Month: (1 to 12), Day: (1 to 31), Year: (up to 2084). Use the <Tab> or <Shift> + <Tab> keys to move between the month, day, and year fields.

Legacy Diskette A [1.44M, 3.5 in.]

Sets the type of floppy drive installed. Configuration options: [None] [360K, 5.25 in.] [1.2M, 5.25 in.] [720K, 3.5 in.] [1.44M, 3.5 in.] [2.88M, 3.5 in.]

Floppy 3 Mode Support [Disabled]

This is required to support older Japanese floppy drives. The Floppy 3 Mode feature allows reading and writing of 1.2MB (as opposed to 1.44MB) on a 3.5-inch diskette. Configuration options: [Disabled] [Enabled]

4.3.1 Primary and Secondary Master/Slave

AwardBIOS Setup Utility		
Main		
Primary Master [Auto]		Item Specific Help
Type	[Auto]	<Enter> to select the type of the IDE drive. [User Type HDD] allows you to set each entry on your own. WARNING: Ultra DMA mode 3/4/5 can be enabled only when BIOS detects shielded 80-pin cable.
Cylinders	[1024]	
Head	[255]	
Sector	[63]	
CHS Capacity	8422MB	
Maximum LBA Capacity	25590MB	
Multi-Sector Transfers	[Maximum]	
SMART Monitoring	[Disabled]	
PIO Mode	[4]	
ULTRA DMA Mode	[Disabled]	
F1 Help ↑↓ Select Item -/+ Change Values F5 Setup Defaults ESC Exit ←→ Select Menu Enter Select ▶ Sub-Menu F10 Save and Exit		

Type [Auto]

Select [Auto] to automatically detect an IDE hard disk drive. If automatic detection is successful, Setup automatically fills in the correct values for the remaining fields on this sub-menu. If automatic detection fails, this may be because the hard disk drive is too old or too new. If the hard disk was already formatted on an older system, Setup may detect incorrect parameters. In these cases, select [User Type HDD] to manually enter the IDE hard disk drive parameters. Refer to the next section for details.



CAUTION! Before attempting to configure a hard disk drive, make sure you have the correct configuration information supplied by the drive manufacturer. Incorrect settings may cause the system to fail to recognize the installed hard disk.

[User Type HDD]

AwardBIOS Setup Utility			
Main			
Primary Master	[User Type HDD]	Item Specific Help	
Type	[User Type HDD]	<p><Enter> to select the type of the IDE drive. [User Type HDD] allows you to set each entry on your own.</p> <p>WARNING: Ultra DMA mode 3/4/5 can be enabled only when BIOS detects shielded 80-pin cable.</p>	
Translation Method	[LBA]		
Cylinders	[1024]		
Head	[255]		
Sector	[63]		
CHS Capacity	8422MB		
Maximum LBA Capacity	25590MB		
Multi-Sector Transfers	[Maximum]		
SMART Monitoring	[Disabled]		
PID Mode	[4]		
ULTRA DMA Mode	[Disabled]		
F1 Help	↑↓ Select Item		-/+ Change Values
ESC Exit	↔ Select Menu		Enter Select ► Sub-Menu
		F5 Setup Defaults	
		F10 Save and Exit	

Manually enter the number of cylinders, heads and sectors per track for the drive. Refer to the drive documentation or on the drive label for this information.



NOTE! After entering the IDE hard disk drive information into BIOS, use a disk utility, such as FDISK, to partition and format new IDE hard disk drives. This is necessary so that you can write or read data from the hard disk. Make sure to set the partition of the Primary IDE hard disk drives to active.

If no drive is installed or if you are removing a drive and not replacing it, select [None].

Other options for the Type field are:

[CD-ROM] - for IDE CD-ROM drives

[LS-120] - for LS-120 compatible floppy disk drives

[ZIP] - for ZIP-compatible disk drives

[MO] - for IDE magneto optical disk drives

[Other ATAPI Device] - for IDE devices not listed here

After making your selections on this sub-menu, press the <Esc> key to return to the Main menu. When the Main menu appears, the hard disk drive field displays the size for the hard disk drive that you configured.

Translation Method [LBA]

Select the hard disk drive type in this field. When Logical Block Addressing (LBA) is enabled, the 28-bit addressing of the hard drive is used without regard for cylinders, heads, or sectors. Note that LBA Mode is necessary for drives with more than 504MB storage capacity. Configuration options: [LBA] [LARGE] [Normal] [Match Partition Table] [Manual]

Cylinders

This field configures the number of cylinders. Refer to the drive documentation to determine the correct value. To make changes to this field, set the Type field to [User Type HDD] and the Translation Method field to [Manual].

Head

This field configures the number of read/write heads. Refer to the drive documentation to determine the correct value. To make changes to this field, set the Type field to [User Type HDD] and the Translation Method field to [Manual].

Sector

This field configures the number of sectors per track. Refer to the drive documentation to determine the correct value. To make changes to this field, set the Type field to [User Type HDD] and the Translation Method field to [Manual].

CHS Capacity

This field shows the drive's maximum CHS capacity as calculated by the BIOS based on the drive information you entered.

Maximum LBA Capacity

This field shows the drive's maximum LBA capacity as calculated by the BIOS based on the drive information you entered.

Multi-Sector Transfers [Maximum]

This option automatically sets the number of sectors per block to the highest number that the drive supports. Note that when this field is automatically configured, the set value may not always be the fastest value for the drive. You may also manually configure this field. Refer to the documentation that came with the hard drive to determine the optimum value and set it manually. To make changes to this field, set the Type field to [User Type HDD]. Configuration options: [Disabled] [2 Sectors] [4 Sectors] [8 Sectors] [16 Sectors] [32 Sectors] [Maximum]

SMART Monitoring [Disabled]

This field allows you to enable or disable the S.M.A.R.T. (Self-Monitoring, Analysis and Reporting Technology) system that utilizes internal hard disk drive monitoring technology. This parameter is normally disabled because the resources used in the SMART monitoring feature may decrease system performance. Configuration options: [Disabled] [Enabled]

PIO Mode [4]

This option lets you set a PIO (Programmed Input/Output) mode for the IDE device. Modes 0 through 4 provide successive increase in performance. Configuration options: [0] [1] [2] [3] [4]

Ultra DMA Mode [Disabled]

Ultra DMA capability allows improved transfer speeds and data integrity for compatible IDE devices. Set to [Disabled] to suppress Ultra DMA capability. To make changes to this field, set the Type field to [User Type HDD]. Configuration options: [0] [1] [2] [3] [4] [5] [Disabled]

4.3.2 Keyboard Features

AwardBIOS Setup Utility	
Main	
Keyboard Features	Item Specific Help
Boot Up NumLock Status [On] Keyboard Auto-Repeat Rate [12/Sec] Keyboard Auto-Repeat Delay [1/4 Sec]	Select Power-on state for Numlock
F1 Help ↑↓ Select Item -/+ Change Values F5 Setup Defaults ESC Exit ↔ Select Menu Enter Select ► Sub-Menu F10 Save and Exit	

Boot Up NumLock Status [On]

This field enables users to activate the Number Lock function upon system boot. Configuration options: [Off] [On]

Keyboard Auto-Repeat Rate [6/Sec]

This controls the speed at which the system registers repeated keystrokes. Options range from 6 to 30 characters per second. Configuration options: [6/Sec] [8/Sec] [10/Sec] [12/Sec] [15/Sec] [20/Sec] [24/Sec] [30/Sec]

Keyboard Auto-Repeat Delay [1/4 Sec]

This field sets the time interval for displaying the first and second characters. Configuration options: [1/4 Sec] [1/2 Sec] [3/4 Sec] [1 Sec]

Language [English]

This field displays the BIOS language version.

Supervisor Password [Disabled] / User Password [Disabled]

These fields allow you to set passwords. To set a password, highlight the appropriate field and press <Enter>. Type in a password then press <Enter>. You can type up to eight alphanumeric characters. Symbols and other characters are ignored. To confirm the password, type the password again and press <Enter>. The password is now set to [Enabled]. This password allows full access to the BIOS Setup menus. To clear the password, highlight this field and press <Enter>. The same dialog box as above appears. Press <Enter>. The password is set to [Disabled].

A note about passwords

The BIOS Setup program allows you to specify passwords in the Main menu. The passwords control access to the BIOS during system startup. Passwords are not case sensitive, meaning, passwords typed in either uppercase or lowercase letters are accepted. The BIOS Setup program allows you to specify two different passwords: a Supervisor password and a User password. If you did not set a Supervisor password, anyone can access the BIOS Setup program. If you did, the Supervisor password is required to enter the BIOS Setup program and to gain full access to the configuration fields.

Forgot the password?

If you forget your password, you can clear it by erasing the CMOS Real Time Clock (RTC) RAM. The RAM data containing the password information is powered by the onboard button cell battery. See section “2.7 Switches and jumpers” for information on how to erase the RTC RAM.

Halt On [All Errors]

This field specifies the types of errors that will cause the system to halt. Configuration options: [All Errors] [No Error] [All but Keyboard] [All but Disk] [All but Disk/Keyboard]

Installed Memory [XXX MB]

This field automatically displays the amount of conventional memory detected by the system during the boot process.

4.4 Advanced Menu

AwardBIOS Setup Utility			
Main	Advanced	Power	Boot Exit
CPU Speed	[Manual]		Item Specific Help
CPU: System Frequency Multiple	[5.0x/14.0x]		To make changes to the first 4 fields, the motherboard must be set to jumperfree mode.
System/PCI Frequency (MHz)	[100/33]		
System/SDRAM Frequency Ratio	[Auto]		
Load Performance Setting	[Normal]		
CPU Level 1 Cache	[Enabled]		To set the following 2 fields, the CPU speed must be set to [Manual]. If the frequency multiple or bus frequency are adjusted too high, the system may hang. Please turn off the system and then restart to set the CPU settings.
CPU Level 2 Cache	[Enabled]		
CPU Level 2 Cache ECC Check	[Disabled]		
BIOS Update	[Enabled]		
PS/2 Mouse Function Control	[Auto]		
USB Legacy Support	[Auto]		
OS/2 Onboard Memory > 64M	[Disabled]		
▶ Chip Configuration			
▶ I/O Device Configuration			
▶ PCI Configuration			
F1 Help	↑↓ Select Item	-/+ Change Values	F5 Setup Defaults
ESC Exit	↔ Select Menu	Enter Select ▶ Sub-Menu	F10 Save and Exit

CPU Speed [Manual]

When the motherboard is set to JumperFree™ mode, this field allows you to select the internal frequency of the CPU. Select [Manual] if you want to make changes to the two subsequent fields. Note that selecting a frequency higher than the CPU manufacturer recommends may cause the system to hang or crash.

CPU: System Frequency Multiple (when CPU Speed is set to [Manual])

This field applies to unlocked processors only. If your processor frequency multiple is locked, you cannot access this field. This field sets the frequency multiple between the CPU's internal frequency (CPU speed) and external frequency. Set this field in conjunction with CPU Frequency (MHz) to match the speed of the CPU. Configuration options: [5.0X]...[14.0X]

System / PCI Frequency (MHz) (when CPU Speed is set to [Manual])

This feature tells the clock generator what frequency to send to the system bus and PCI bus. The bus frequency (external frequency) multiplied by the bus multiple equals the CPU speed.

System / SDRAM Frequency Ratio [Auto]

This field determines whether the memory clock frequency is set to be in synchronous or asynchronous mode with respect to the system frequency. The options that appear in the popup menu vary according to the CPU Frequency (MHz). Configuration options: [Auto] [100:100] [100:133]

Load Performance Setting [Normal]

The [Manual] setting is the system default. Selecting [Optimal] boosts the speed performance of the entire system. However, it should be noted that the optimal performance setting may make the system less stable. Configuration options: [Normal] [Optimal]

CPU VCore [1.750V]

When the CPU VCore Setting parameter is set to [Manual], this item allows you to select a specific CPU core voltage. This field is not accessible when the CPU VCore Setting parameter is set to [Auto]. Configuration options: [1.750V] [1.775V] [1.800V] [1.825V] [[1.850V]



CAUTION! Refer to the CPU documentation before setting this field. A very high core voltage may severely damage the CPU.

CPU Level 1 Cache, CPU Level 2 Cache [Enabled]

These fields allow you to choose from the default of [Enabled] or choose [Disabled] to turn on or off the CPU Level 1 and Level 2 built-in cache. Configuration options: [Disabled] [Enabled]

CPU Level 2 Cache ECC Check [Disabled]

These fields offers the default of [Disabled] or [Enabled] to turn on or off the CPU Cache ECC Check function. Configuration options: [Disabled] [Enabled]

BIOS Update [Enabled]

This field functions as an update loader integrated into the BIOS to supply the processor with the required data. When set to [Enabled], the BIOS loads the update on all processors during system bootup. Configuration options: [Disabled] [Enabled]

PS/2 Mouse Function Control [Auto]

The default setting [Auto] allows the system to detect a PS/2 mouse at startup. If a mouse is detected, the BIOS assigns IRQ12 to the PS/2 mouse. Otherwise, IRQ12 can be used for expansion cards. When you set this field to [Enabled], BIOS reserves IRQ12, whether or not a PS/2 mouse is detected at startup. Configuration options: [Enabled] [Auto]

USB Legacy Support [Auto]

This motherboard supports Universal Serial Bus (USB) devices. The default of [Auto] allows the system to detect a USB device at startup. If detected, the USB controller legacy mode is enabled. If not detected, the USB controller legacy mode is disabled. When you set this field to [Disabled], the USB controller legacy mode is disabled whether or not you are using a USB device. Configuration options: [Disabled] [Enabled] [Auto]

OS/2 Onboard Memory > 64M [Disabled]

When using OS/2 operating systems with installed DRAM of greater than 64MB, you need to set this option to [Enabled]. Otherwise, leave to the default setting [Disabled]. Configuration options: [Disabled] [Enabled]

4.4.1 Chip Configuration

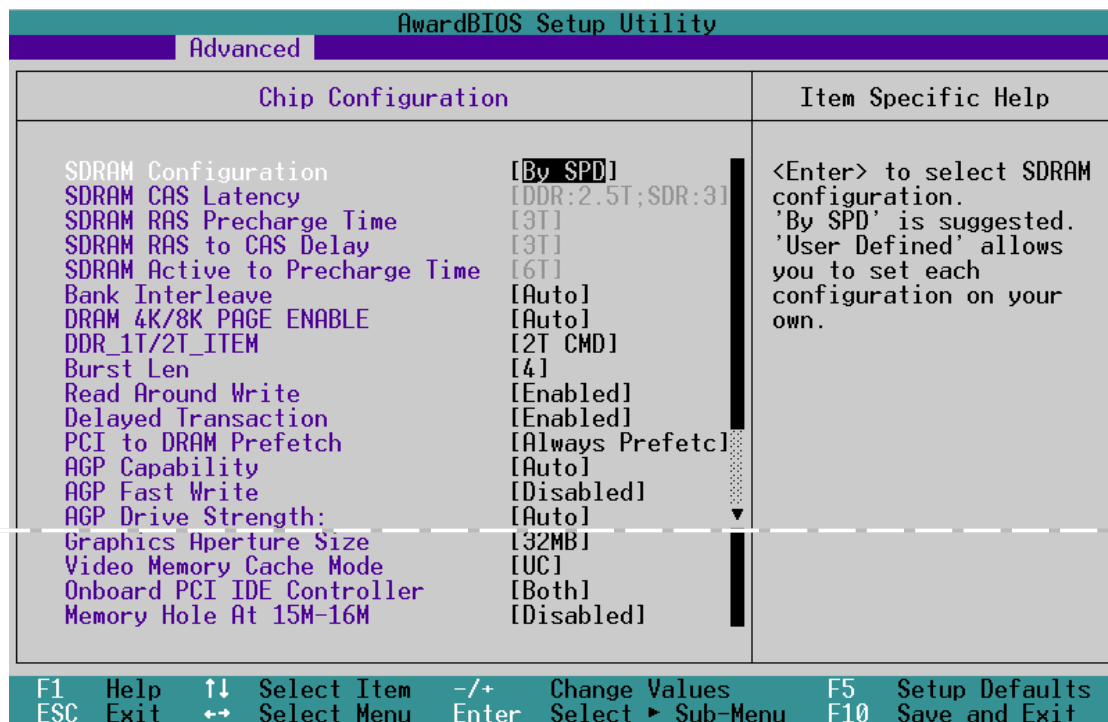

(Scroll down to view all items on the menu.)

SDRAM Configuration [By SPD]

This parameter allows you to set the optimal timings for items 2–5, depending on the memory modules that you are using. The default setting is [By SPD], which configures items 2–5 by reading the contents in the SPD (Serial Presence Detect) device. The EEPROM on the memory module stores critical information about the module, such as memory type, size, speed, voltage interface, and module banks. Configuration options: [User Defined] [By SPD]



NOTE! The following 4 SDRAM parameters appear only when you set the SDRAM Configuration to [User Defined].

SDRAM CAS Latency [3T]

This item controls the latency between the SDRAM read command and the time the data actually becomes available.

SDRAM RAS Precharge Time [3T]

This item controls the idle clocks after issuing a precharge command to the SDRAM.

SDRAM RAS to CAS Delay [3T]

This item controls the latency between the SDRAM active command and the read/write command.

SDRAM Active to Precharge Delay [6T]

This item controls the number of SDRAM clocks used for SDRAM parameters.

Bank Interleave [Auto]

Configuration options: [None] [2 banks] [4 banks] [Auto]

DRAM 4K/8K PAGE ENABLE [Auto]

Configuration options: [Auto] [4K page enable] [8 page enable]

DDR_1T/2T_ITEM [2T CMD]

Configuration options: [1T CMD] [2T CMD] [Auto Mode]

Burst Len [4]

Configuration options: [4] [Auto]

Read Around Write [Enabled]

Configuration options: [Enabled] [Disabled]

Delayed Transaction [Disabled]

When set to [Enabled], this feature frees the PCI bus when the CPU is accessing 8-bit ISA cards. This process normally consumes about 50-60 PCI clocks without PCI delayed transaction. Set this field to [Disabled] when using ISA cards that are not PCI 2.1 compliant. Configuration options: [Enabled] [Disabled]

PCI to DRAM Prefetch [Always Prefetch]

Configuration options: [Always Prefetch] [Prefetch disabled] [Prefetch only enhance command]

AGP Capability [4X Mode]

This motherboard supports the AGP 4X interface that transfers video data at 1066MB/s. AGP 4X is backward-compatible, so you may keep the default [4X Mode] even if you are using an AGP 1X video card. When set to [1X Mode], the AGP interface only provides a peak data throughput of 266MB/s even if you are using an AGP 4x card.

Configuration options: [1X Mode] [4X Mode]

AGP Fast Write [Disabled]

Configuration options: [Enabled] [Disabled]

AGP Drive Strength [Auto]

Configuration options: [Auto] [Manual]

Graphics Aperture Size [32MB]

This feature allows you to select the size of mapped memory for AGP graphic data. Configuration options: [4MB] [8MB] [16MB] [32MB] [64MB] [128MB] [256MB]

Video Memory Cache Mode [UC]

USWC (uncacheable, speculative write combining) is a new cache technology for the video memory of the processor. It can greatly improve the display speed by caching the display data. You must set this to UC (uncacheable) if your display card does not support this feature, otherwise the system may not boot. Configuration options: [UC] [USWC]

Onboard PCI IDE Controller [Both]

This field allows you to enable either the primary IDE channel or secondary IDE channel, or both. You can also set both channels to [Disabled]. Configuration options: [Both] [Primary] [Secondary] [Disabled]

Memory Hole At 15M-16M [Disabled]

This field allows you to reserve an address space for ISA expansion cards. Setting the address space to a particular setting makes that memory space unavailable to other system components. Expansion cards can only access memory up to 16MB. Configuration options: [Disabled] [Enabled]

4.4.2 I/O Device Configuration

AwardBIOS Setup Utility		
Advanced		
I/O Device Configuration		Item Specific Help
Onboard FDC Swap A & B	[No Swap]	<Enter> to select if switch drive letter assignments or not.
Onboard Serial Port 1	[3F8H/IRQ4]	
Onboard Serial Port 2	[2F8H/IRQ3]	
UART2 Use Infrared	[Disabled]	
Onboard Parallel Port	[378H/IRQ7]	
Parallel Port Mode	[ECP+EPP]	
ECP DMA Select	[3]	
▶ Onboard Peripheral Resource Control		
Onboard CIR I/O	[Disabled]	
F1 Help ↑↓ Select Item -/+ Change Values F5 Setup Defaults ESC Exit ↔ Select Menu Enter Select ▶ Sub-Menu F10 Save and Exit		

Onboard FDC Swap A & B [No Swap]

This field reverses the hardware drive letter assignments of floppy disk drivers. Configuration options: [No Swap] [Swap AB]

Onboard Serial Port 1 [3F8H/IRQ4]

Onboard Serial Port 2 [2F8H/IRQ3]

These fields set the addresses for the onboard serial connectors. Serial Port 1 and Serial Port 2 must have different addresses. Configuration options: [3F8H/IRQ4] [2F8H/IRQ3] [3E8H/IRQ4] [2E8H/IRQ10] [Disabled]

UART2 Use As [COM Port]

This field selects the device on which to assign UART2. Configuration options: [COM Port] [IR] [Smart Card Reader]

Onboard Parallel Port [378H/IRQ7]

This field sets the address of the onboard parallel port connector. If you disable this field, the Parallel Port Mode and ECP DMA Select configurations are not available. Configuration options: [Disabled] [378H/IRQ7] [278H/IRQ5]

Parallel Port Mode [ECP+EPP]

This field sets the operation mode of the parallel port. [Normal] allows normal-speed operation but in one direction only; [EPP] allows bidirectional parallel port operation; [ECP] allows the parallel port to operate in bidirectional DMA mode; [ECP+EPP] allows normal speed operation in a two-way mode. Configuration options: [Normal] [EPP] [ECP] [ECP+EPP]

ECP DMA Select [3]

This field configures the parallel port DMA channel for the selected ECP mode. This selection is available only if you select [ECP] or [ECP+EPP] in Parallel Port Mode above. Configuration options: [1] [3]

Onboard CIR I/O [Disabled]

This field selects the CIR I/O channel address. Configuration options: [2E0-2E8H] [3E0-3E8H].

4.4.2.1 Onboard Peripheral Resource Control

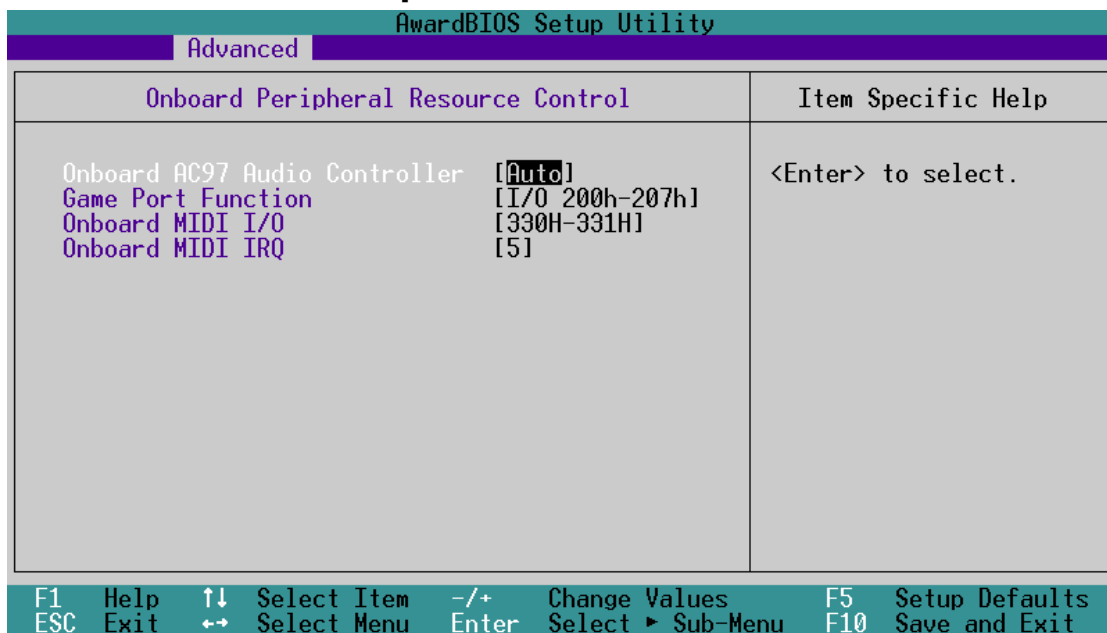

Onboard AC97 Audio Controller [Auto]

[Auto] allows the BIOS to detect whether you are using any modem/audio device. If a modem/audio device is detected, the onboard modem/audio controller is enabled; if no modem/audio device is detected, the controller is disabled. If there are conflicts with the onboard modem/audio controller, set the appropriate field to [Disabled]. Configuration options: [Disabled] [Auto]

Game Port Function [200H-207H]

This field sets the I/O address to the game port. Configuration options: [200H-207H] [208H-20FH] [Disabled]

Onboard MIDI I/O [330H-331H]

This field sets the I/O address for MIDI. Configuration options: [330H-331H] [300H-301H] [Disabled]

Onboard MIDI IRQ [5]

This field assigns the IRQ address for MIDI. Configuration options: [3] [4] [5] [7] [9] [10] [11] [12] [14] [15]

4.4.3 PCI Configuration

AwardBIOS Setup Utility		
Advanced		
PCI Configuration		Item Specific Help
Slot 1 IRQ	[Auto]	<Enter> to select an IRQ.
Slot 2 IRQ	[Auto]	
PCI/VGA Palette Snoop	[Disabled]	
PCI Latency Timer	[32]	
SYMBIOS SCSI BIOS	[Auto]	
USB Function	[Enabled]	
Primary VGA BIOS	[PCI Card]	
Onboard LAN Boot ROM	[Disabled]	
▶ PCI IRQ Resource Exclusion		
F1 Help ↑↓ Select Item -/+ Change Values F5 Setup Defaults ESC Exit ↔ Select Menu Enter Select ▶ Sub-Menu F10 Save and Exit		

Slot 1, Slot 2 IRQ [Auto]

These fields automatically assign the IRQ for each PCI slot. The default setting for each field is [Auto], which utilizes auto-routing to determine IRQ assignments. Configuration options: [Auto] [NA] [3] [4] [5] [7] [9] [10] [11] [12] [14] [15]

PCI/VGA Palette Snoop [Disabled]

Some non-standard VGA cards, like graphics accelerators or MPEG video cards, may not show colors properly. Setting this field to [Enabled] corrects this problem. If you are using standard VGA cards, leave this field to the default setting [Disabled]. Configuration options: [Disabled] [Enabled]

PCI Latency Timer [32]

Leave this field to the default setting [32] for best performance and stability.

SYMBIOS SCSI BIOS [Auto]

[Auto] allows the motherboard's BIOS to detect whether you have a Symbios SCSI card. If the Symbios SCSI card is detected, the motherboard's Symbios BIOS will be enabled; if no Symbios SCSI card is detected, the onboard Symbios SCSI BIOS will be disabled.

[Disabled] will disable the motherboard's Symbios SCSI BIOS so that the BIOS on an add-on Symbios SCSI card can be used. If your Symbios SCSI card does not have a BIOS, the Symbios SCSI card will not function. Configuration options: [Auto] [Disabled]

USB Function [Enabled]

This motherboard supports Universal Serial Bus (USB) devices. Set this field to [Enabled] to connect USB devices. Configuration options: [Disabled] [Enabled]

Primary VGA BIOS [PCI VGA Card]

This field selects the primary graphics card. Configuration options: [PCI VGA Card] [AGP VGA Card]

Onboard LAN Boot ROM [Disabled]

When set to [Enabled], this field instructs the computer to boot from the network using the onboard LAN controller boot ROM. Configuration options: [Disabled] [Enabled]

4.4.3.1 PCI IRQ Resource Exclusion

AwardBIOS Setup Utility					
Advanced					
PCI IRQ Resource Exclusion				Item Specific Help	
IRQ	3	Used	By	ISA	[No/ICU]
IRQ	4	Used	By	ISA	[No/ICU]
IRQ	5	Used	By	ISA	[No/ICU]
IRQ	7	Used	By	ISA	[No/ICU]
IRQ	9	Used	By	ISA	[No/ICU]
IRQ	10	Used	By	ISA	[No/ICU]
IRQ	11	Used	By	ISA	[No/ICU]
IRQ	12	Used	By	ISA	[No/ICU]
IRQ	14	Used	By	ISA	[No/ICU]
IRQ	15	Used	By	ISA	[No/ICU]

F1 Help ↑↓ Select Item -/+ Change Values F5 Setup Defaults
ESC Exit ↔ Select Menu Enter Select ► Sub-Menu F10 Save and Exit

IRQ XX Reserved [No/ICU]

These fields indicate whether or not the displayed IRQ for each field is being used by a legacy (non-PnP) ISA card. The setting [No/ICU] for an IRQ field indicates that you are using the ISA Configuration Utility (ICU), and that this particular IRQ is NOT required by a legacy ISA card. Set the IRQ field to [Yes] if you install a legacy ISA card that requires a unique IRQ and you are NOT using ICU. Configuration options: [No/ICU] [Yes]

4.5 Power Menu

The Power menu allows you to reduce power consumption. This feature turns off the video display and shuts down the hard disk after a period of inactivity.

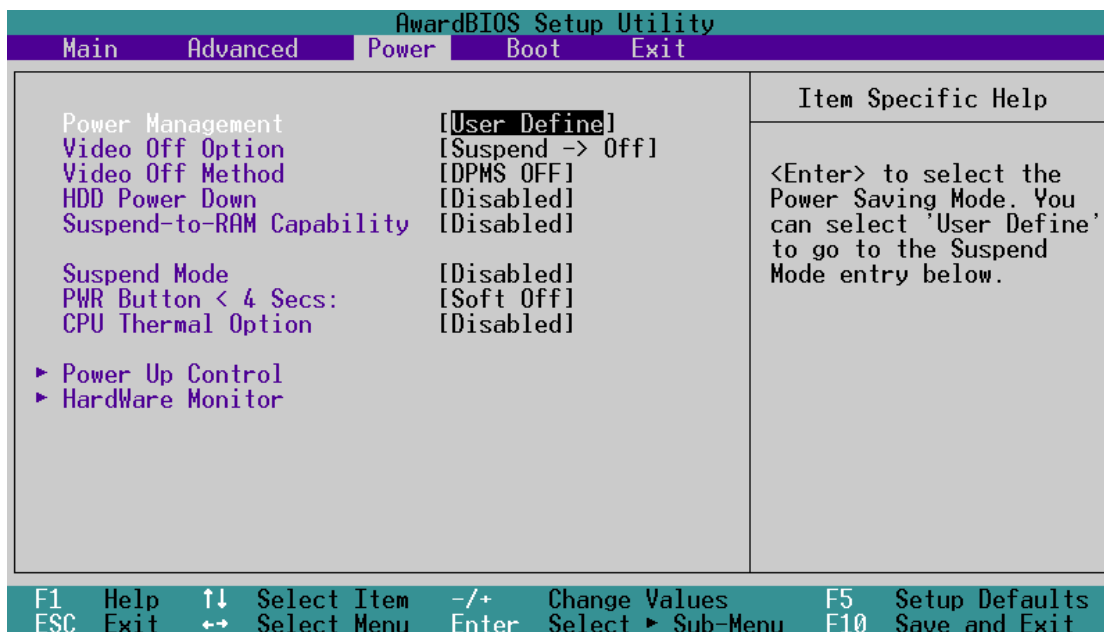

Power Management [User Defined]

This field allows you to activate or deactivate the automatic power saving features. When set to [Disabled], the power management features do not function regardless of the other settings on this menu. The [User Defined] option allows you to set the period of inactivity before the system enters suspend mode. Refer to “Suspend Mode” later in this section.

When set to [Max Saving], system power is conserved to its greatest amount. This setting automatically puts the system into suspend mode after a brief period of system inactivity. [Min Saving] allows the least power saving as the system enters suspend mode only after a long period of inactivity. Configuration options: [User Defined] [Disabled] [Min Saving] [Max Saving]



IMPORTANT! You should install the Advanced Power Management (APM) utility to keep the system time updated even when the computer enters suspend mode. In Windows 3.x and Windows 95, you need to install Windows with the APM feature. In Windows 98 or later, APM is automatically installed as indicated by a battery and power cord icon labeled “Power Management” in the Control Panel. Select the item “Advanced” in the Power Management Properties dialog box.

Video Off Option [Suspend -> Off]

This field determines when to activate the video off feature for monitor power management. Configuration options: [Always On] [Suspend -> Off]

Video Off Method [DPMS OFF]

This field defines the video off features. The Display Power Management System (DPMS) feature allows the BIOS to control the video display card if it supports the DPMS feature. [Blank Screen] only blanks the screen. Use this for monitors without power management or “green” features.



NOTE! Even if installed, your screen saver does not display when you select [Blank Screen] for the above field.

[V/H SYNC+Blank] blanks the screen and turns off vertical and horizontal scanning. Configuration options: [Blank Screen] [V/H SYNC+Blank] [DPMS Standby] [DPMS Suspend] [DPMS OFF] [DPMS Reduce ON]

HDD Power Down [Disabled]

Shuts down any IDE hard disk drives in the system after a period of inactivity as set in this user-configurable field. This feature does not affect SCSI hard drives. Configuration options: [Disabled] [1 Min] [2 Min] [3 Min]...[15 Min]

Suspend-to-RAM Capability [Disabled]

This field allows you to enable or disable the ACPI Suspend-to-RAM feature. To support this feature, the +5VSB of the power supply should have the capacity to provide more than 720mA current. Configuration options: [Disabled] [Enabled]

Suspend Mode [Disabled]

Sets the time period before the system goes into suspend mode. Configuration options: [Disabled] [1~2 Min] [2~3 Min] [4~5 min] [8~9 Min] [20 Min] [30 Min]

PWR Button < 4 Secs [Soft Off]

When set to [Soft off], the ATX switch can be used as a normal system power-off button when pressed for less than 4 seconds. [Suspend] allows the button to have a dual function where pressing less than 4 seconds puts the system in sleep mode. Regardless of the setting, holding the ATX switch for more than 4 seconds powers off the system. Configuration options: [Soft off] [Suspend]

CPU Thermal Option [Disabled]

This feature prolongs the life of the CPU and motherboard by monitoring the temperature of the CPU; if overheating occurs, the CPU throttles down or shuts down completely. Configuration options: [Disabled] [Enabled]

4.5.1 Power Up Control

AwardBIOS Setup Utility	
Power	
Power Up Control	Item Specific Help
AC PWR Loss Restart [Disabled]	Restart the system or not after AC power loss.
PWR Up On External Modem Act [Disabled]	
Wake On LAN or PCI Modem [Disabled]	
Wake Up by USB device [Disabled]	
Wake Up By Keyboard [Space Bar]	
Pwr Up On PS2 KB/Mouse [Disabled]	
Automatic Power Up [Disabled]	

F1 Help ↑↓ Select Item -/+ Change Values F5 Setup Defaults
ESC Exit ↔ Select Menu Enter Select ► Sub-Menu F10 Save and Exit

AC PWR Loss Restart [Disabled]

This allows you to set whether or not to reboot the system after power interruptions. [Disabled] leaves your system off while [Enabled] reboots the system. [Previous State] sets the system back to the state it was before the power interruption. Configuration options: [Disabled] [Enabled] [Previous State]

PWR Up On External Modem Act [Disabled]

The computer may be powered up the computer if the external modem receives a call while the system is in Soft-off mode. Configuration options: [Disabled] [Enabled]



NOTE! The computer cannot receive or transmit data until the computer and applications are fully running. Thus, connection cannot be made on the first try. Turning an external modem off and then back on while the computer is off sends an initialization string that turns system power on.

Wake On LAN or PCI Modem [Disabled]

When set to [Enabled], the system through a network or a PCI modem. This feature requires an ATX power supply that provides at least 1A on the +5VSB lead. Configuration options: [Disabled] [Enabled]

Power Up by USB [Disabled]

When set to [Enabled], the system powers up through a USB device. This feature requires an ATX power supply that provides at least 1A on the +5VSB lead. Configuration options: [Disabled] [Enabled]

Power On by Keyboard [Space Bar]

This parameter allows you to use specific keys on the keyboard to turn on the system. This feature requires an ATX power supply that provides at least 1A on the +5VSB lead. Configuration options: [Disabled] [Space Bar] [Ctrl-Esc] [Power Key]

Power On By PS/2 Mouse [Disabled]

When set to [Enabled], this parameter allows you to use the PS/2 mouse to turn on the system. This feature requires an ATX power supply that provides at least 1A on the +5VSB lead. Configuration options: [Disabled] [Enabled]

Automatic Power Up [Disabled]

This allows an unattended or automatic system power up. You may configure your system to power up at a certain time of the day by selecting [Everyday] or at a certain time and day by selecting [By Date]. Configuration options: [Disabled] [Everyday] [By Date]

4.5.2 Hardware Monitor

AwardBIOS Setup Utility	
Power	
HardWare Monitor	Item Specific Help
MB Temperature 33°C/91°F CPU Temperature 60°C/140°F JTPWR Temperature [Ignore]	<Enter> to switch between Monitoring or Ignore.
CPU Fan Speed 13500RPM Power Fan Speed N/A Chassis Fan Speed N/A	
VCORE Voltage 1.85V +3.3V Voltage 3.36V +5V Voltage 4.89V +12V Voltage 12.46V	
F1 Help ↑↓ Select Item -/+ Change Values F5 Setup Defaults ESC Exit ←→ Select Menu Enter Select ▶ Sub-Menu F10 Save and Exit	

MB Temperature [xxxC/xxxF]

CPU Temperature [xxxC/xxxF]

JTPWR Temperature [Ignore]

The onboard hardware monitor automatically detects the MB (motherboard) and CPU temperatures.

CPU Fan Speed [xxxxRPM]

Power Fan Speed [xxxxRPM]

Chassis Fan Speed [xxxxRPM]

The onboard hardware monitor automatically detects the CPU and chassis fan speeds in rotations per minute (RPM).

VCORE Voltage, +3.3V Voltage, +5V Voltage, +12V Voltage

The onboard hardware monitor automatically detects the voltage output through the onboard voltage regulators.



NOTE! If any of the monitored items is out of range, the following error message appears: “Hardware Monitor found an error. Enter Power setup menu for details”. You will then be prompted to “Press F1 to continue or DEL to enter SETUP”.

4.6 Boot Menu

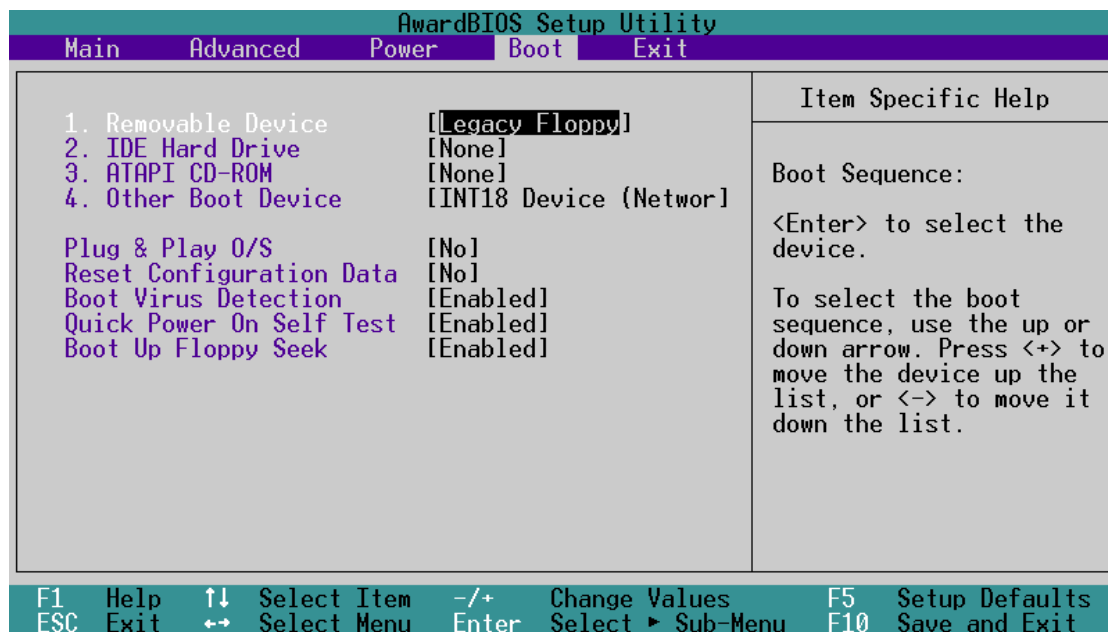

Boot Sequence

The Boot menu allows you to select among the four possible types of boot devices listed using the up and down arrow keys. By using the <+> or <Space> key, you can promote devices and by using the <-> key, you can demote devices. Promotion or demotion of devices alters the priority which the system uses to search for a boot device on system power up. Configuration fields include Removable Devices, IDE Hard Drive, ATAPI CD-ROM, and Other Boot Device.

Removable Device [Legacy Floppy]

Configuration options: [Disabled] [Legacy Floppy] [LS-120] [ZIP] [ATAPIMO]

IDE Hard Drive

This field allows you to select which IDE hard disk drive to use in the boot sequence. Pressing [Enter] will show the product IDs of all connected IDE hard disk drives.

ATAPI CD-ROM

This field allows you to select which ATAPI CD-ROM drive to use in the boot sequence. Pressing [Enter] will show the product IDs of all your connected ATAPI CD-ROM drives.

Other Boot Device Select [INT18 Device (Network)]

Configuration options: [Disabled] [SCSI Boot Device] [INT18 Device (Network)]

Plug & Play O/S [No]

This field allows you to use a Plug-and-Play (PnP) operating system to configure the PCI bus slots instead of using the BIOS. When [Yes] is selected, interrupts may be reassigned by the OS. If you installed a non-PnP OS or if you want to prevent reassigning of interrupt settings, keep the default setting [No]. Configuration options: [No] [Yes]

Reset Configuration Data [No]

The Extended System Configuration Data (ESCD) contain information about non-PnP devices. It also holds the complete record of how the system was configured the last time it was booted. Select [Yes] if you want to clear these data during the Power-On-Self-Test (POST). Configuration options: [Disabled] [Enabled]

Boot Virus Detection [Enabled]

This field allows you to set boot virus detection, ensuring a virus-free boot sector. The system halts and displays a warning message when it detects a virus. If this occurs, you can either allow the operation to continue or use a virus-free bootable floppy disk to restart and investigate your system. Configuration options: [Disabled] [Enabled]

Quick Power On Self Test [Enabled]

This field speeds up the Power-On-Self Test (POST) routine by skipping retesting a second, third, and fourth time. Configuration options: [Disabled] [Enabled]

Boot Up Floppy Seek [Enabled]

When enabled, the BIOS will seek the floppy disk drive to determine whether the drive has 40 or 80 tracks. Configuration options: [Disabled] [Enabled]

4.7 Exit Menu

When you have made all of your selections from the various menus in the Setup program, save your changes and exit Setup. Select Exit from the menu bar to display the following menu.

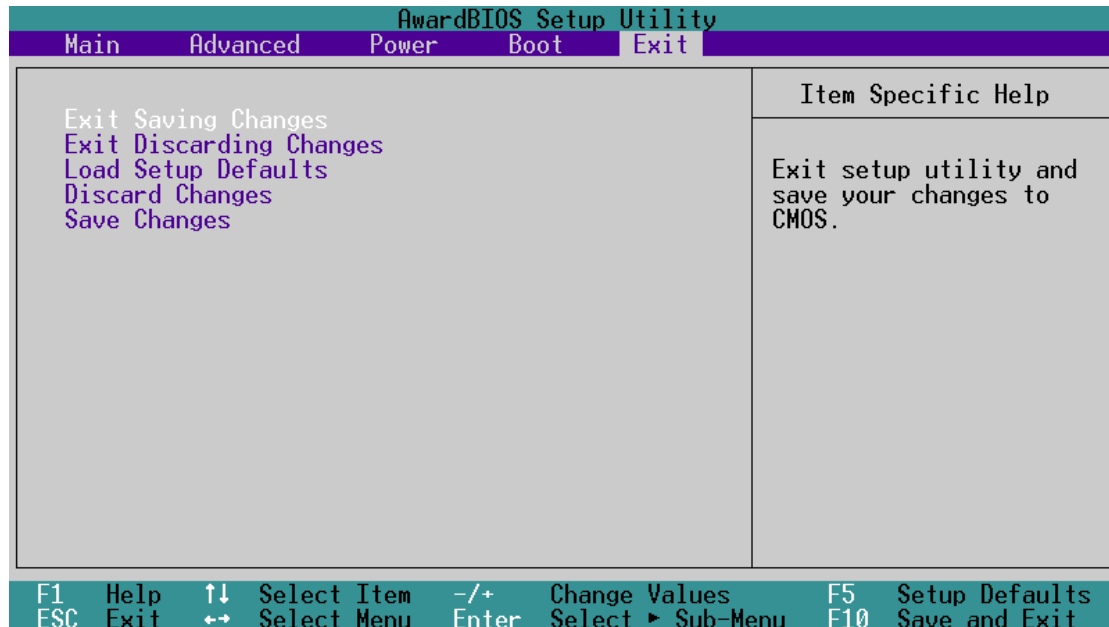

NOTE! Pressing <Esc> does not immediately exit this menu. Select one of the options from this menu or <F10> from the legend bar to exit.

Exit Saving Changes

Once you are finished making your selections, choose this option from the Exit menu to ensure the values you selected are saved to the CMOS RAM. The CMOS RAM is sustained by an onboard backup battery and stays on even when the PC is turned off. When you select this option, a confirmation window appears. Select [Yes] to save changes and exit.



NOTE! If you attempt to exit the Setup program without saving your changes, the program prompts you with a message asking if you want to save your changes before exiting. Pressing <Enter> saves the changes while exiting.

Exit Discarding Changes

Select this option only if you do not want to save the changes that you made to the Setup program. If you made changes to fields other than system date, system time, and password, the BIOS asks for a confirmation before exiting.

Load Setup Defaults

This option allows you to load the default values for each of the parameters on the Setup menus. When you select this option or if you press <F5>, a confirmation window appears. Select [Yes] to load default values. Select Exit Saving Changes or make other changes before saving the values to the non-volatile RAM.

Discard Changes

This option allows you to discard the selections you made and restore the previously saved values. After selecting this option, a confirmation appears. Select [Yes] to discard any changes and load the previously saved values.

Save Changes

This option saves your selections without exiting the Setup program. You can then return to other menus and make further changes. After you select this option, a confirmation window appears. Select [Yes] to save any changes to the non-volatile RAM.

Chapter 5

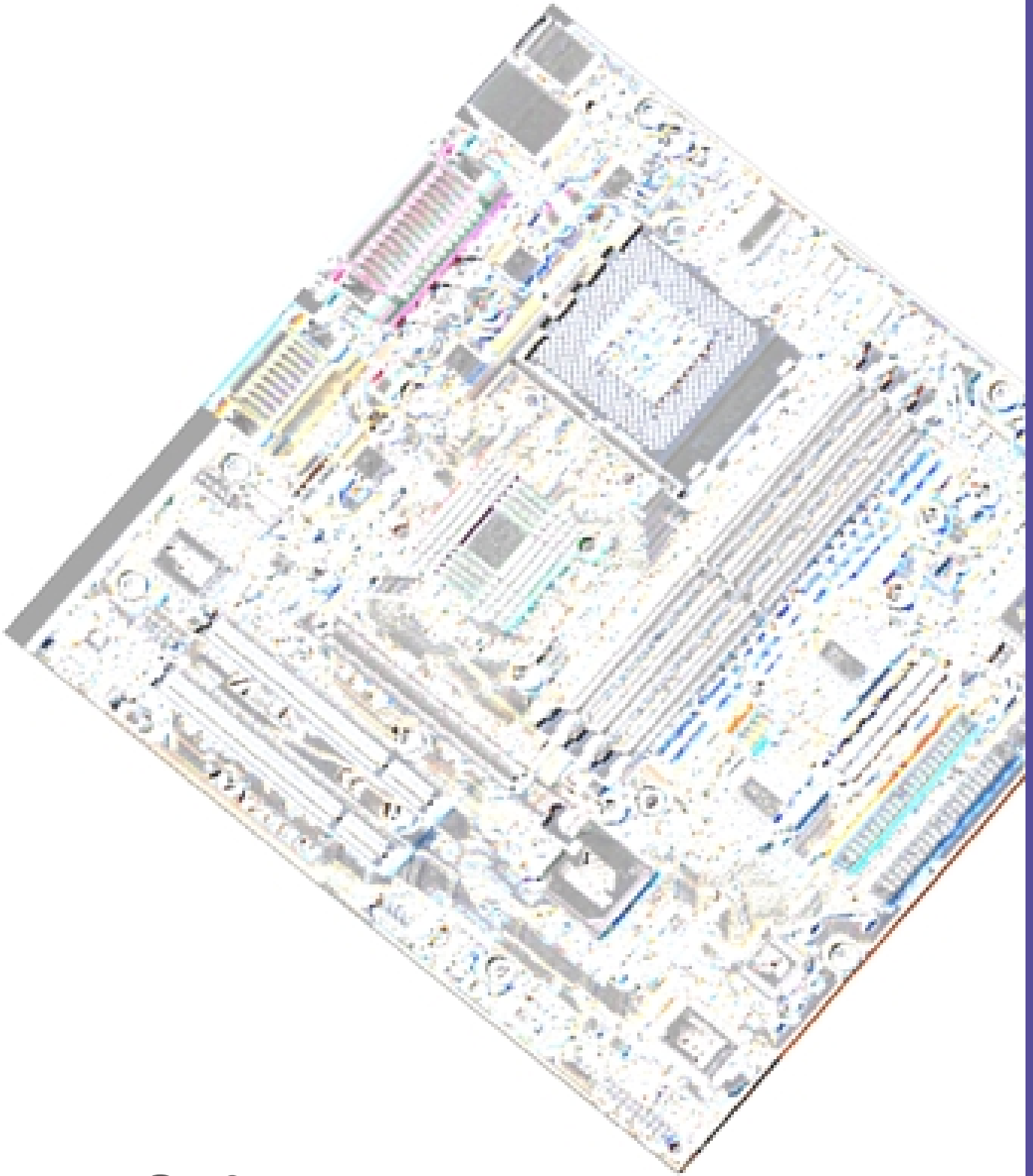

Software support

5.1 Install an operating system

This motherboard supports Windows 98/ME/NT/2000/XP and OS/2 operating system (OS). Always install the latest OS version and corresponding updates so you can maximize the features of your hardware.

5.1.1 Windows 98 first time installation

When you start Windows for the first time after installing the motherboard, Windows 98 detects all Plug-n-Play devices. Follow the **Add New Hardware** wizard to install the necessary device drivers. When prompted to restart, select **No**. Refer to the following sections in this chapter to install the software and drivers contained in the support CD.



NOTE! Because motherboard settings and hardware options vary, use the setup procedures presented in this chapter for general reference only. Refer to your OS documentation for more information.

5.2 Support CD information

The support CD that came with the motherboard contains useful software and several utility drivers that enhance the motherboard features.



NOTE! The contents of the support CD are subject to change at any time without notice. Visit the ASUS website for updates.

5.2.1 Running the support CD

To begin using the support CD, simply insert the CD into your CD-ROM drive. The CD automatically displays the welcome screen and the installation menus if Autorun is enabled in your computer.

5.3 A7V266-M Motherboard Support CD

To begin using the support CD disc, insert it into the CD-ROM drive and the CD installation menu should appear. If the menu does not appear, use the explorer to locate the contents of the CD ROM and then double-click ASSETUP.EXE.

5.3.1 Installation Menu

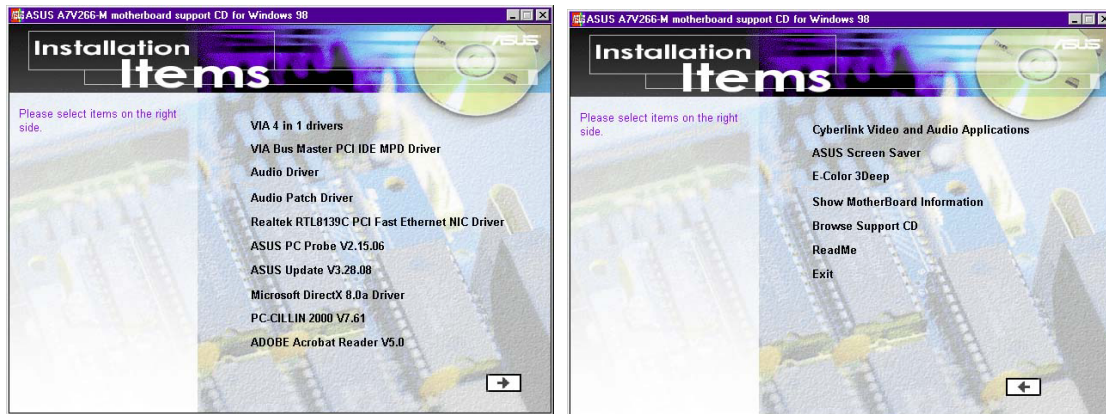

- **VIA 4 in 1 drivers:** Installs PCI Bus Master IDE Driver, VIA AGP Driver, VIA INF Driver, and IRQ Routing Driver.
- **VIA Bus Master PCI IDE MPD Driver:** Installs PCI Bus Master IDE Driver
- **Audio Driver:** Installs the latest audio driver.
- **Audio Patch Driver:** Installs a patch to resolve audio-muting problems after returning from S1 sleep state.
- **Realtek RTL8139C PCI Fast Ethernet NIC Driver:** Installs the network driver to support the onboard NIC.
- **ASUS PC Probe:** Installs a smart utility to monitor your computer's fan, temperature, and voltages.
- **ASUS Update:** Installs a program that can help you update BIOS or download a BIOS image file.
- **Microsoft DirectX Driver:** Installs basic drivers to enable compatibility with audio, video and other system operations.
- **PC-Cillin 2000 Vx.xx:** Installs the PC-cillin virus protection software. View online help for more information.
- **ADOBE Acrobat Reader Vx.xx:** Installs the Adobe Acrobat Reader software necessary to view user's manuals saved in PDF format. Updated or other language versions of this motherboard's manual is available in PDF format at any of our web sites.

(CLICK RIGHT ARROW ON THE LOWER-RIGHT CORNER)

- **Cyberlink Video and Audio Applications:** Installs Cyberlink PowerPlayer SE and Cyberlink VideoLive Mail.
- **ASUS Screen Saver:** Installs a nifty ASUS screen saver.
- **E-Color 3Deep:** Installs graphical driver and an application for tuning the quality of color output from CRT and LCD monitors.
- **Show Motherboard Information:** Allows you to view information about your motherboard, such as product name, BIOS version, and CPU.
- **Browse Support CD:** Allows you to view the contents of the CD.
- **ReadMe:** Allows you to view the support CD file list and contact information.
- **Exit:** Exits the CD installation menu.

(CLICK LEFT ARROW ON THE LOWER-RIGHT CORNER)

5.3.2 Installation Procedure

Click on the name of the driver or program group on the **Installation Items Menu** to begin installation. Follow the instructions that appear on the setup screens. All drivers and programs install automatically. Refer to 6. *Software Reference* for operating instructions.

5.4 ASUS PC Probe

ASUS PC Probe is a convenient utility to continuously monitor your computer system's vital components, such as fan rotations, Voltages, and temperatures. It also has a utility that lets you review useful information about your computer, such as hard disk space, memory usage, and CPU type, CPU speed, and internal/external frequencies through the DMI Explorer.

5.4.1 Starting ASUS PC Probe

When ASUS PC Probe starts, a splash screen appears allowing you to select whether or not to show the screen the next time you open PC Probe. To bypass this startup screen, clear the **Show up in next execution** check box.

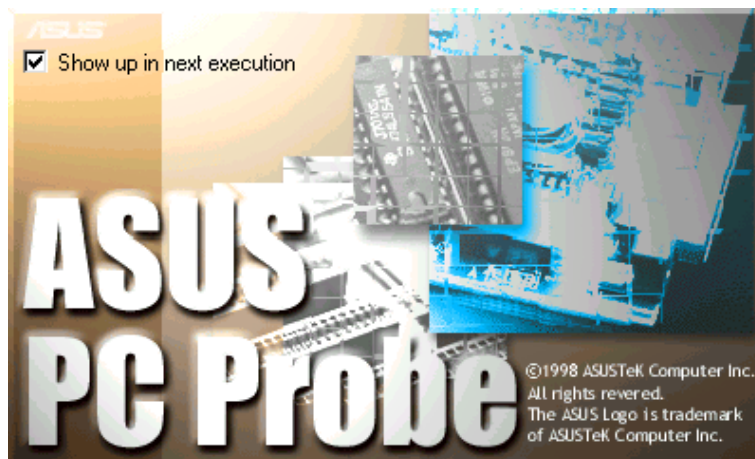

To start **ASUS PC Probe**, click the Windows **Start** button, point to **Programs**, and then **ASUS Utility**, and then click **Probe Vx.xx**.

The PC Probe icon  will appear on the taskbar's system tray indicating that ASUS PC Probe is running. Clicking the icon will allow you to see the status of your PC.

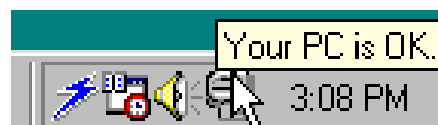

5.4.2 Using ASUS PC Probe

Monitoring

Monitor Summary

Shows a summary of the items being monitored.

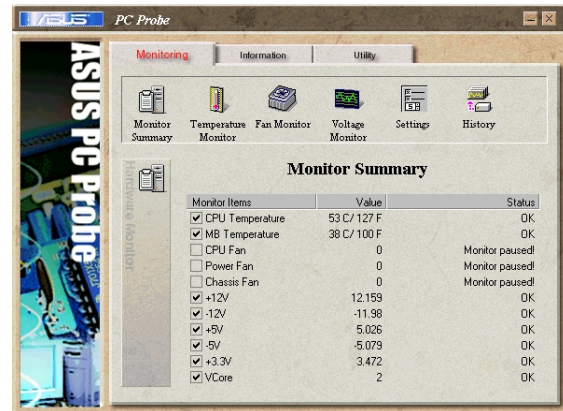

Temperature Monitor

Shows the PC's temperature.

Temperature Warning threshold adjustment
(Move the slider up to increase the threshold level or down to decrease the threshold level)

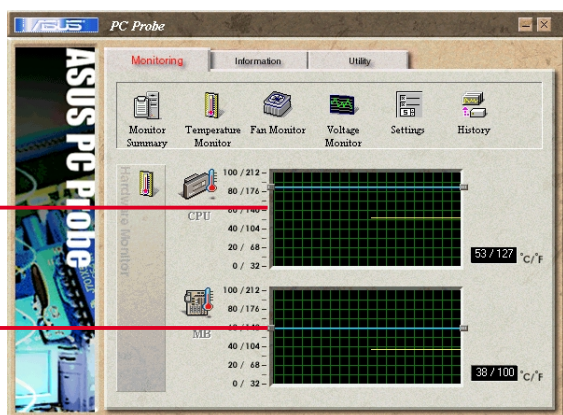

Fan Monitor

Shows the PC's fan rotation.

Fan Warning threshold adjustment
(Move the slider up to increase the threshold level or down to decrease the threshold level)

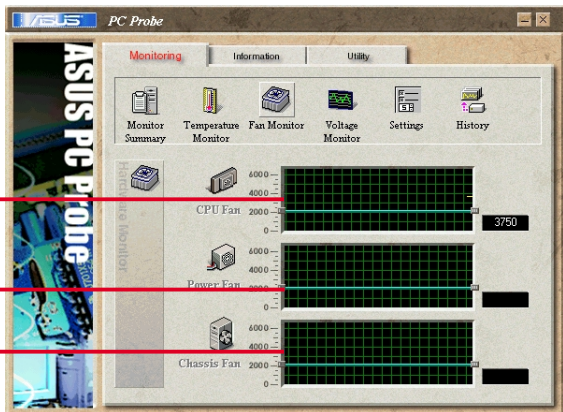

Voltage Monitor

Shows the PC's voltages.

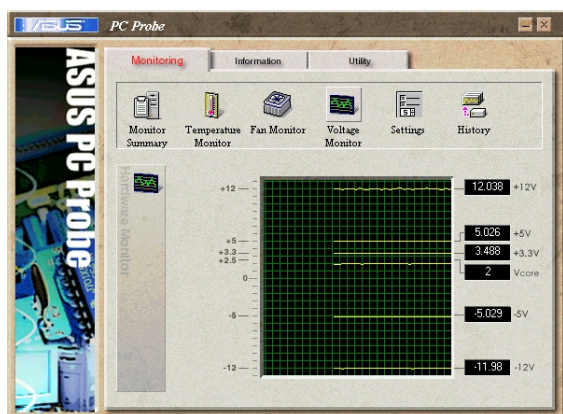

Settings

Lets you set threshold levels and polling intervals or refresh times of the PC's temperature, fan rotation, and voltages.



CPU Cooling System Setup

Lets you select when to enable software CPU cooling. When **When CPU Overheated** is selected, the CPU cooling system is enabled whenever the CPU temperature reaches the threshold value.



History

Lets you record the current monitoring activity of a certain component of your PC for future reference.

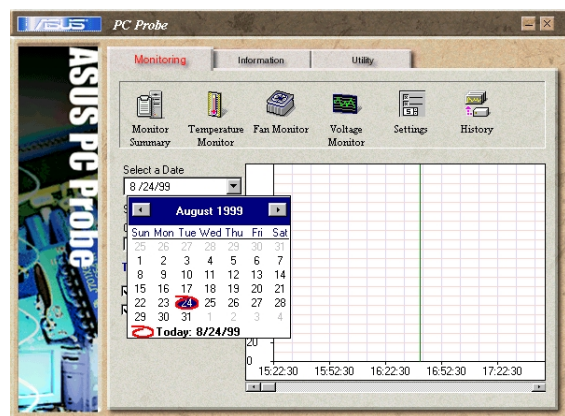

Information

Hard Drives

Shows the used and free space of the PC's hard disk drives and the file allocation table or file system used.

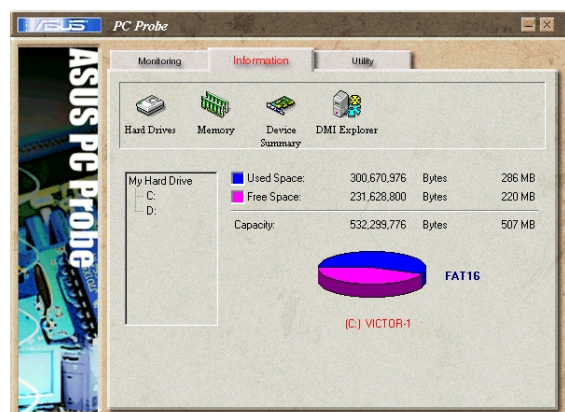

Memory

Shows the PC's memory load, memory usage, and paging file usage.

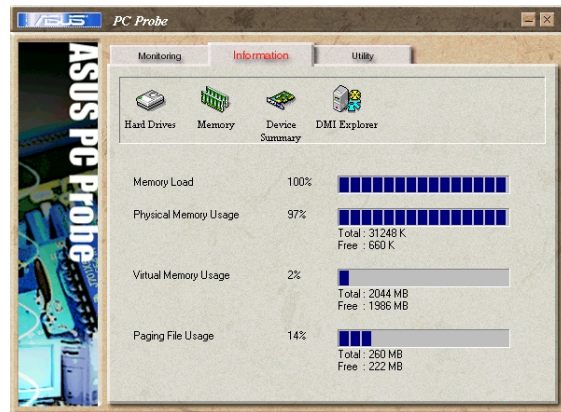

Device Summary

Shows a summary of devices in your PC.



DMI Explorer

Shows information pertinent to the PC, such as CPU type, CPU speed, and internal/external frequencies, and memory size.



Utility

Lets you run programs outside of the ASUS Probe modules. To run a program, click **Execute Program**.

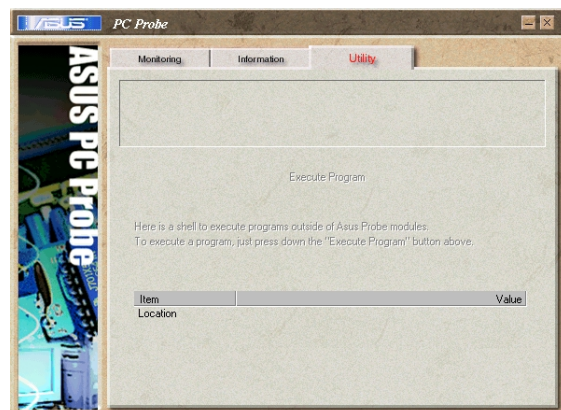

5.4.3 ASUS PC Probe Task Bar Icon

Right-clicking the PC Probe icon will bring up a menu to open or exit ASUS PC Probe and pause or resume all system monitoring.



When the ASUS PC Probe senses a problem with your PC, portions of the ASUS PC Probe icon changes to red, the PC speaker beeps, and the ASUS PC Probe monitor is displayed.

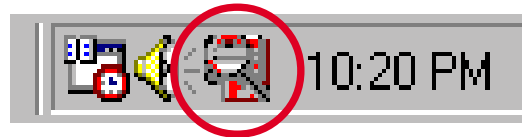

5.5 ASUS Live Update

ASUS LiveUpdate is a utility that allows you to update your motherboard's BIOS and drivers. The use of this utility requires that you are properly connected to the Internet through an Internet Service Provider (ISP).

1. Start ASUS Update. Launch the utility from your Windows Start menu: Programs/AsusUpdate.
2. Select an update method.

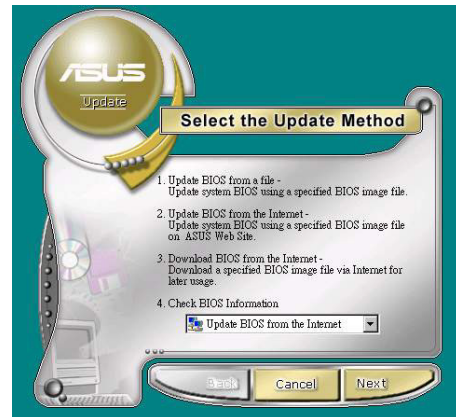

3. If you selected "downloading from the Internet," you will need to select an Internet site. Choose the site that is closest to you or click Auto Select.

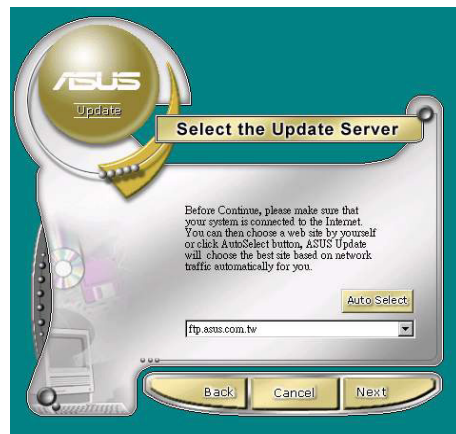

4. From the FTP site, select the BIOS version that you wish to download. Click Next.

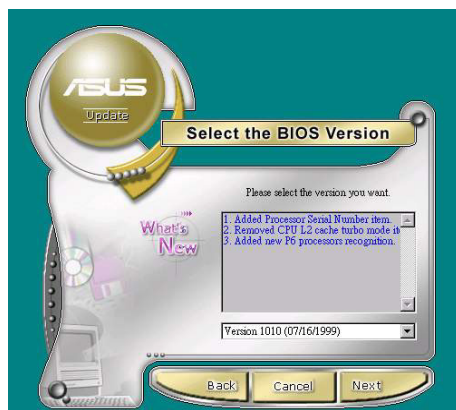

5. Follow the instructions on the succeeding screens to complete the update process. If you selected the option to update the BIOS from a file, a window pops up prompting you to locate the file. Select the file, click Save, then follow the screen instructions to complete the update process.

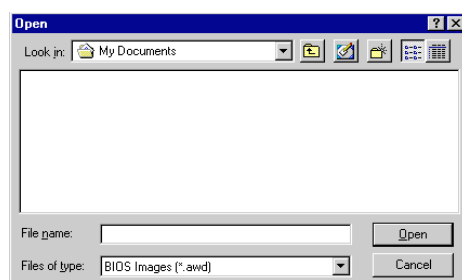

5.6 3Deep Color Tuner

The 3-Deep color tuner is designed to match your CRT or LCD color monitor to maximize the color quality of all graphical applications. Users may also tune their internet applications to match “true” internet source colors with the color displayed on the monitor.

Simply run the setup program from the start menu and follow the instructions on the various setup/test screens.

6.5.1 3Deep Color Tuning

1. Select the type of monitor connected to the computer, either **CRT** or **LCD**.

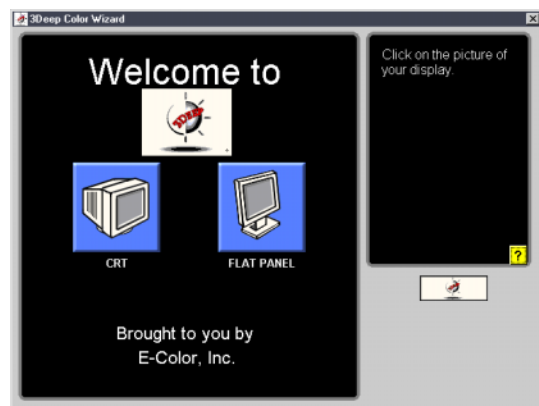

2. Follow the instructions to manually adjust the **brightness** level of the monitor.

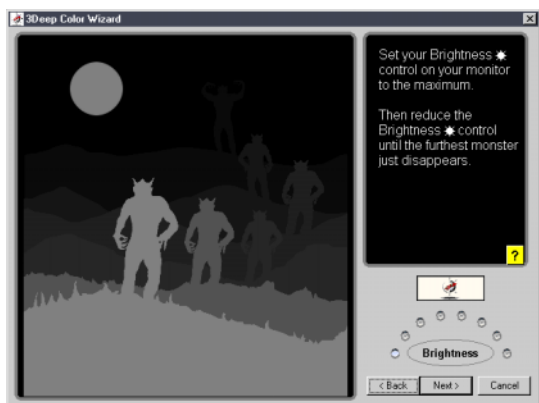

3. Select the faintest of the three colors: **blue**, **red** and **green**.

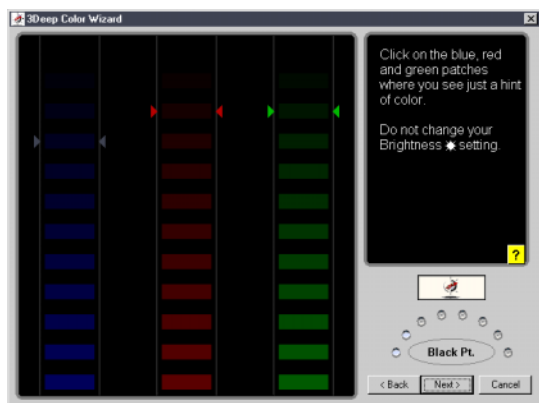

4. Select the color squares which most closely blend and match with the background.
5. The next step repeats the color matching process to achieve full color quality.

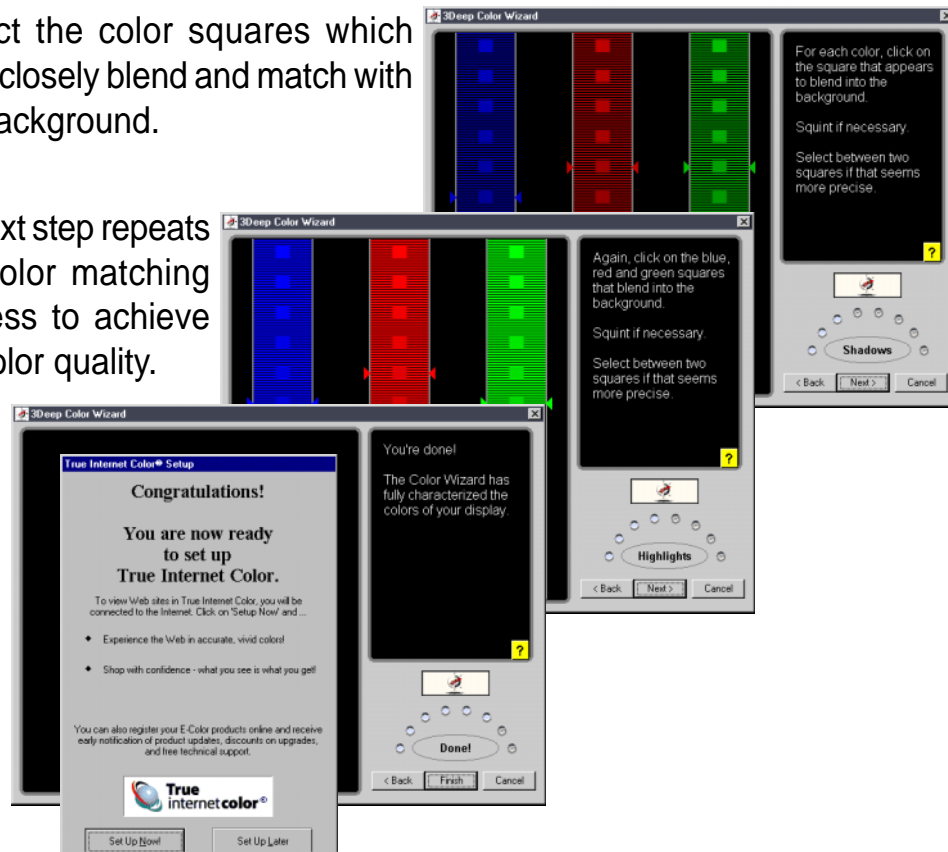

6. The tuning process is complete. Click on the bottom left button to connect to the internet and follow the instructions.

6.5.2 The 3Deep Control Panel

Using the Windows **Start** button, activate the **3Deep Control Panel** program from the **3Deep Applications** group on the **Main Program** menu. The control panel offers access to the **Color Wizard** tuning program, a **Game Gamma** setting and a **Tweak** slider for brightness adjustment.

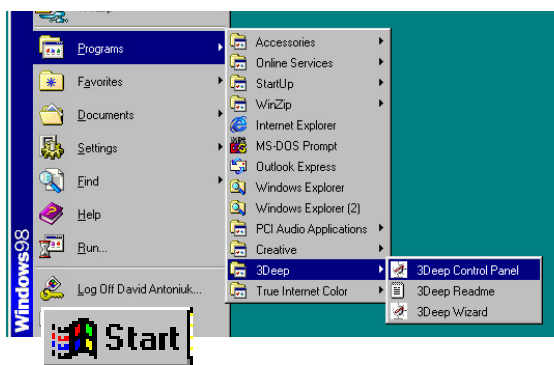

Glossary

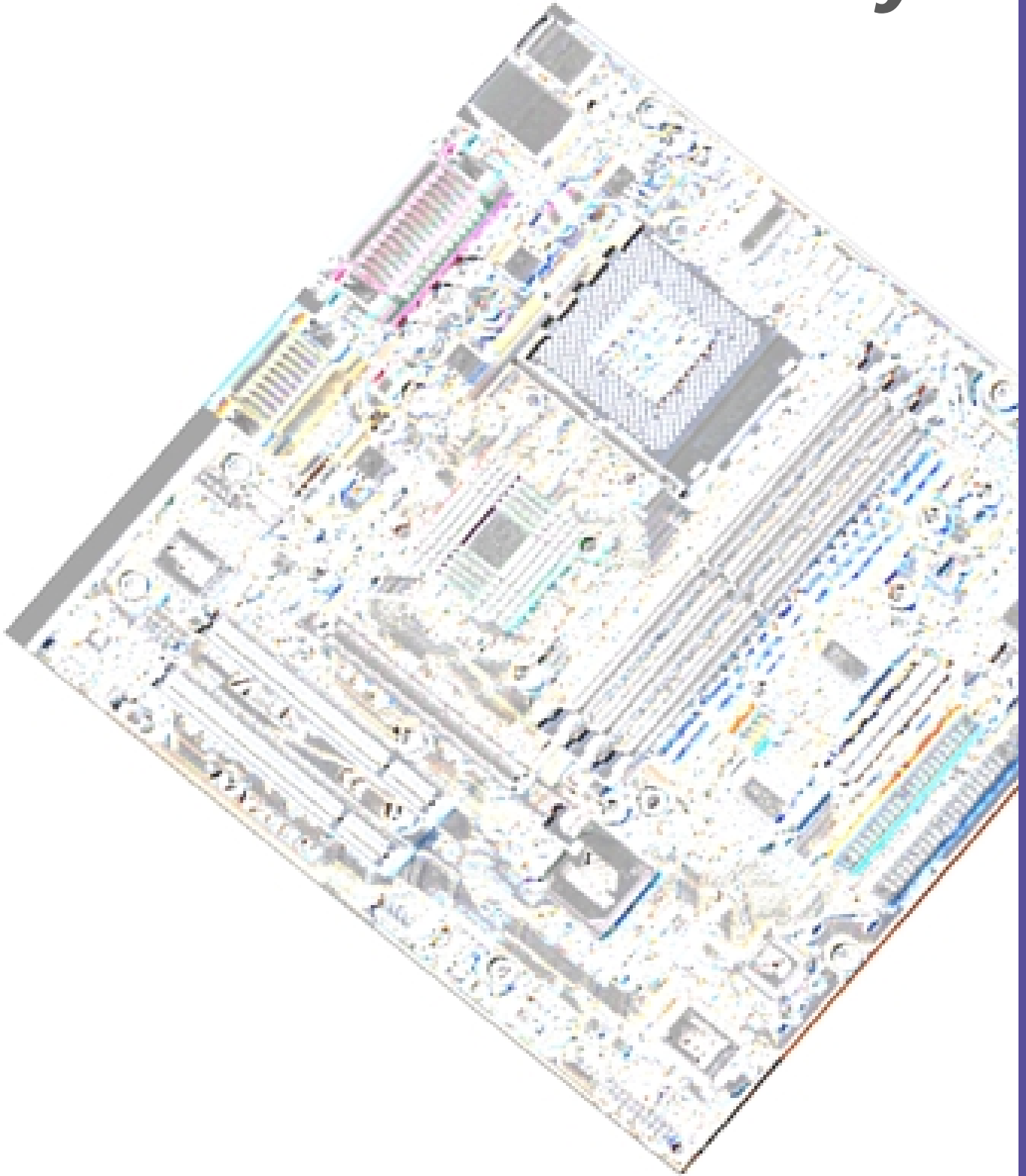

1394

1394 is the IEEE designation for a high performance serial bus that offers data transfers at 100/200/400 Mbps. This serial bus defines both a back plane physical layer and a point-to-point cable-connected virtual bus. The primary application of the cable version is the integration of I/O connectivity at the back panel of personal computers using a low-cost, scalable, high-speed serial interface. The 1394 standard also provides new services such as live connect/disconnect capability for external devices including disk drives, printers and hand-held peripherals such as scanners and cameras. This is a new standard to complement the slower USB interface and to compete with the more expensive SCSI interface.

AC97 (Audio Codec '97)

AC '97 is the next step in enabling PCs with audio quality comparable to consumer electronics devices. The specification defines new cost-effective options to help integrate the components necessary to support next-generation audio-intensive PC applications such as DVD, 3-D multiplayer gaming and interactive music. The specification also defines new extensions supporting modem and docking to help both desktop and mobile manufacturers adopt these new technologies more quickly and cost-effectively. This specification uses software emulation to compete with the PCI SoundBlaster specification.

ACPI (Advanced Configuration and Power Interface)

The ACPI specification defines a cross-platform interface designed to support many operating systems. ACPI defines a flexible and abstract hardware interface that provides a standard way to integrate power management features throughout a PC system, including hardware, operating system and application software. This enables the system to automatically turn ON and OFF peripherals such as CD-ROMs, network cards, hard disk drives, and printers, as well as consumer devices connected to the PC such as VCRs, TVs, phones, and stereos. With this technology, peripherals will also be able to activate the PC. For example, inserting a tape into a VCR can turn on the PC, which could then activate a large-screen TV and high-fidelity sound system.

AGP (Accelerated Graphics Port)

An interface specification that enables high-performance 3D graphics on mainstream PCs. AGP was designed to offer the necessary bandwidth and latency to perform texture mapping directly from system memory.

Bus	Bus Frequency	Bandwidth	Data Transfer Rate
PCI	33MHz	33MHz	133MByte/sec
AGP 1X	66MHz	66MHz	266MByte/sec
AGP 2X	66MHz	133MHz	512MByte/sec
AGP 4X	66MHz	266MHz	1024MByte/sec

Backup. A copy of a file, directory, or volume on a separate storage device from the original. This copy is for the purpose of data retrieval in case the original is accidentally erased, damaged, or destroyed.

BIOS (Basic Input/Output System)

BIOS is a set of routines that affect how the computer transfers data between computer components, such as memory, disks, and the display adapter. The BIOS instructions are built into the computer's read-only memory. BIOS parameters can be configured by the user through the BIOS Setup program. The BIOS can be updated using the provided utility to copy a new BIOS file into the EEPROM.

Bit (Binary Digit)

A bit is the basic unit of digital data used by the computer. A bit equals either: 0 or 1.

Boot

Boot means to start the computer operating system by loading it into system memory. When the manual instructs you to "boot" your system (or computer), it means to turn ON your computer. "Reboot" means to restart your computer. When using Windows 95 or later, selecting "Restart" from "Start | Shut Down..." will reboot your computer.

Bus Master IDE

PIO (Programmable I/O) IDE requires that the CPU be involved in IDE access and waiting for mechanical events. Bus master IDE transfers data to/from the memory without interrupting the CPU. Bus master IDE driver and bus master IDE hard disk drives are required to support bus master IDE mode.

Byte (Binary Term)

One byte is a group of eight contiguous bits. A byte is used to represent a single alphanumeric character, punctuation mark, or other symbol.

Cache Memory. A type of RAM that allows a faster from the CPU than a regular RAM. The cache memory eliminates the CPU wait state. When the CPU reads data from the main memory, a copy of this data is stored in the cache memory. The next time the same address, the data is transferred from the cache memory instead of from the main memory.

CODEC (Compressor/Decompressor). A software component that translates video or audio between its uncompressed form and the compressed form in which it is stored.

COM Port

COM is a logical device name used by to designate the computer serial ports. Pointing devices, modems, and infrared modules can be connected to COM ports. Each COM port is configured to use a different IRQ and address assignment.

Concurrent PCI

Concurrent PCI maximizes system performance with simultaneous CPU, PCI and ISA bus activities. It includes multi-transaction timing, enhanced write performance, a passive release mechanism and support for PCI 2.1 compliant delayed transactions. Concurrent PCI provides increased bandwidth, reduced system latencies, improves video and audio performance, and improves processing of host based applications.

CPU (Central Processing Unit)

The CPU, sometimes called "Processor," actually functions as the "brain" of the computer. It interprets and executes program commands and processes data stored in memory. Currently, there are socket 370 (for Pentium III FC-PGA and Celeron-PPGA), socket 7 (for Pentium, AMD, Cyrix, IBM), slot 1 (for Pentium II and III), slot 2 (for Xeon), and slot A (for AMD) processors.

Device Driver

A device driver is a special set of instructions that allows the computer's operating system to communicate with devices such as VGA, audio, printer, or modem.

DOS (Disk Operating System)

DOS is the foundation on which all other programs and software applications operate, including Windows. DOS is responsible for allocating system resources such as memory, CPU time, disk space, and access to peripheral devices. For this reason, DOS constitutes the basic interface between you and your computer.

DRAM (Dynamic Random Access Memory)

A type of RAM that requires refresh cycles to prevent the loss of the data stored in it. There are several different types of DRAM such as, EDO DRAM (Extended Data Output DRAM), SDRAM (Synchronous DRAM), and RDRAM (Rambus DRAM) and DDR DRAM, (Double-Data Rate DRAM).

Flash ROM

non-volatile memory device that retains its data even when power is removed. This device is similar to EPROM, but unlike EPROM which can be erased only using an ultra-violet light, flash ROM can be electrically erased. Flash ROM is normally used for system BIOS, which initiates hardware devices and sets up necessary parameters for the OS. Since the flash ROM contents can be modified, users can easily update the BIOS..

IDE (Integrated Drive Electronics)

IDE devices integrate the drive control circuitry directly on the drive itself, eliminating the need for a separate adapter card (in the case for SCSI devices). UltraDMA/33 IDE devices can achieve up to 33MB/Sec transfer.

I/O (Input/Output)

The data transfers from the input devices like a keyboard, mouse, or scanner, to the output devices like a printer or the monitor screen.

I/O Address

The specific memory location for a particular device. Two devices cannot share the same I/O address space.

IrDA (Infrared Data Association)

An international organization that creates and promotes inter-operable, low cost, infrared data interconnection standards that support a walk-up, point-to-point model. The IrDA protocol is designed to support transmission of data between two devices over short-range point-to-point infrared at speeds between 9.6Kbps and 4Mbps.

ISP (Internet Service Provider)

A company that provides customer access to the Internet and the World Wide Web for a fee. The ISP also provides Internet utilities and services like e-mail, newsgroup, weather reports, and a host of others. The user can connect to the ISP using a modem installed in the computer and connected to a phone line.

LPT Port (Line Printer Port)

Logical device name reserved by DOS for the computer parallel ports. Each LPT port is configured to use a different IRQ and address assignment.

MMX

A set of 57 new instructions designed to accelerate multimedia and communications applications, such as 3D video, 3D sound, video conference.

Modem

A device that allows a computer to talk to another computer through the phone system.

Network

An interconnected computer system linked by telephone wires, or other means.

OnNow

The OnNow design initiative is a comprehensive, system-wide approach to system and device power control. OnNow is a term for PC that is always ON but appears OFF and responds immediately to user or other requests. The OnNow design initiative involves changes that will occur in the Microsoft Windows operating system, device drivers, hardware, and applications, and also relies on the changes defined in the Advanced Configuration and Power Interface (ACPI) specification.

PC100/133

This is an industry-standard designation for memory capacity as a measure of the speed of the memory bus. New platform requirements ensure that memory does not become a bottleneck to system performance.

PCI Bus (Peripheral Component Interconnect Local Bus)

PCI bus is a standard specification that defines a 32-bit data bus interface.

PCI Bus Master

The PCI Bus Master can perform data transfer without local CPU help and the CPU can be treated as one of the Bus Masters. PCI 2.1 supports concurrent PCI operation to allow the local CPU and bus master to work simultaneously.

POST (Power On Self Test)

Powering on the computer initiates the POST, a series of software-controlled diagnostic tests. The POST checks system memory, the motherboard circuitry, the display, the keyboard, the diskette drive, and other I/O devices.

PS/2 Port

PS/2 ports are based on IBM Micro Channel Architecture. This type of architecture transfers data through a 16-bit or 32-bit bus. A PS/2 mouse and/or keyboard may be used on ATX motherboards.

RDRAM (Rambus DRAM)

Developed by Rambus, Inc., this type of memory can deliver up to 1.6GB of data per second. RDRAM is the first interface standard that can be directly implemented on high performance VLSI components such as, CMOS DRAMs, memory controllers, and graphics/video ICs.

RAM (Random Access Memory). The computer's primary storage area used to write, store, and retrieve information and program instructions which are passed to the CPU for processing. The information in RAM can be repeatedly re-written with new data. Compared to other storage media like magnetic tape, floppy disk, and hard disk, RAM has an extraordinarily fast access rate. RAM, however, is volatile, which means that the data stored in it are lost when the system power is turned off, or if power glitches occur. See also DRAM and SDRAM.

ROM (Read Only Memory)

ROM is nonvolatile memory used to store permanent programs (called firmware) used in certain computer components. Flash ROM (or EEPROM) can be reprogrammed with new programs (or BIOS).

SCSI (Small Computer System Interface)

High speed multi-threaded I/O interface defined by the X3T9.2 committee of the American National Standards Institute (ANSI) for connecting many peripheral devices. The standard started from 10MBytes/sec to 160MBytes/sec available today.

SDRAM (Synchronous DRAM)

A type of DRAM with access signals that are synchronized with the CPU clock, eliminating the delay associated with data transfers between the CPU and memory. SDRAM takes memory access away from the CPU control; internal registers in the memory accept the request, and lets the CPU do something else while the data requested is assembled for the next time the CPU talks to the memory.

SPD for SDRAM module

Serial Presence Detect (SPD) is most like an ID detect for SDRAM module, it using a EEPROM component on DIMM module for storing module configuration information inside. The Serial Presence Detect function is implemented using a 2048 bit EEPROM component. This nonvolatile storage device contains data programmed by the DIMM manufacturer that identifies the module type and various SDRAM organization and timing parameters.

System Disk

A system disk contains the core file of an operating system that boots up the operating system.

TCP/IP (Transmission Control Protocol/Internet Protocol). The communications protocol used by the UNIX system and the Internet. TCP checks for lost packets, puts the data from multiple packets into the correct order, and requests that missing or damaged packets be resent.

USB (Universal Serial Bus)

A 4-pin serial cable bus that allows up to 127 plug and play computer peripherals such as keyboard, mouse, joystick, scanner, printer, modem, and monitor to share a bandwidth through a host scheduled token based protocol. This allows attaching or detaching while the host and other peripherals are in operation. Supports synchronous and asynchronous transfer types over the same set of wires up to 12Mbit/sec. USB 2.0 provides twice the transfer rate compared to USB 1.0 and competes with the 1394 standard.

Wake-On-LAN

Computer will automatically wake-up upon receiving a wake-up packet through a Network interface when it is under power soft-off, suspend or sleep mode.

Index

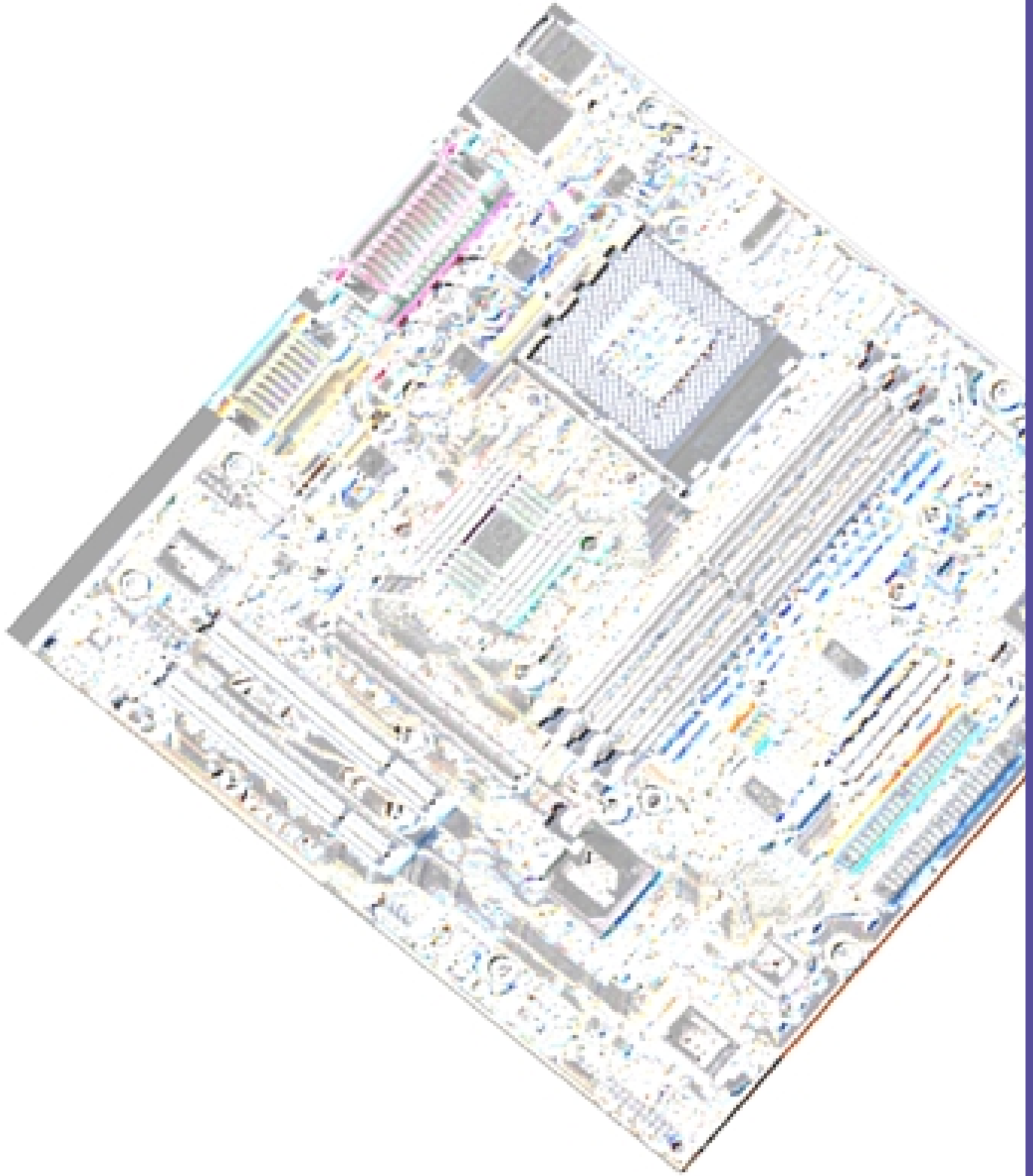

Index

Symbols

3Deep Color Tuner
Using 85

A

ASUS PC Probe
Using 79
ASUS Update
Using 84
ATAPI CD-ROM 70
Automatic Power Up 69

B

BIOS
Advanced Menu 55
Beep Codes 39
Boot Menu 70
Boot Sequence 70
Exit Menu 72
Legend Bar 46
Main Menu 48
Menu Bar 46
Power Menu 65
Setup Defaults, loading 73
Setup Program 45
Smart BIOS 2
Sub-menu launching 47
Updating 41
BIOS Beep Codes 39
Boot Device
Selection 70
Boot Up NumLock Status 53
Boot Virus Detection 71

C

Central Processing Unit (CPU) 11
External Frequency 20
installation 12
Level 1/Level 2 Cache 56
Speed 55
Chip Configuration 58
Clear RTC RAM jumper 24
Connectors
Audio 27
Chassis Fan 30
CPU Fan 30
Floppy Disk Drive 28, 33
Game/MIDI 2, 27
HDD LED 25
IDE 29
Infrared Module 31
Internal Audio 33
Panel 37
Parallel Port 26
PS/2 Keyboard 25
PS/2 Mouse 25
Serial Port 26
SMBus 32
USB 26

D

DIMM
installing 14
DIP Switches 19
DSW switches 19

E

expansion card
installation 15
Expansion slots 15

External frequency jumper 20

F

Floppy 3 Mode 48

Floppy Disk Drive Connector 28, 33

H

Hard Disk Drives (HDDs)

CHS Capacity 51

Cylinders 51

Heads 51

LBA Capacity 51

Primary/Secondary Master 49

Primary/Secondary Slave 49

Sectors 51

Types 49

Hardware Monitor 69

I

IDE Activity LED 28

IDE Connectors 29

Infrared Module Connector 31

Interrupt Assignments 16

IRQ assignments 16

J

JumperFree Mode 19

JumperFree™ Mode 19

Jumpers 19

Clear RTC RAM 24

External frequency 20

JumperFree Mode 19

Keyboard wake-up 22

USB device wake-up 21

K

Keyboard

Auto-Repeat Delay 53

Auto-Repeat Rate 53

Connector 25

Features 53

Keyboard Lock Switch Lead 9

Keyboard wake jumper 22

L

LAN

Jumper Setting 21

Legacy Diskette 48

LiveUpdate 85

Using 85

M

Motherboard

IRQ Table 16

layout 8, 9

placement 7

screws 7

Mouse

Connector 25

Multi-Sector Transfers 51

O

Onboard LED 10

Operating system

installation 75

P

Parallel Port 61

Modes 61

Parallel Port Connector 26

Password

Supervisor 54

User 54

PC Probe

Using 79

PCI Configuration 63

PCI Latency Timer 63

PCI/VGA Palette Snoop 63

PIO Mode 52

Plug & Play O/S 71

Power Management 65

Power On Self Test 71
PS/2 Keyboard 25
PS/2 Keyboard Port 2
PS/2 Mouse 25
 Function Control 56
PS/2 Mouse Port 2

R

RTC RAM
 Clearing 9, 24

S

SDRAM
 Active to Precharge Time 59
 CAS Latency 58
 Configuration 58
 RAS to CAS Delay 58
Serial Ports 61
 Connectors 26
slots
 AGP 17
 PCI 17
SMART Monitoring 52
SMBus Connector 32
Support CD 75
 Welcome screen 75
System Date 48
System memory
 configurations 13
System Time 48

U

UART2 63
Ultra DMA Mode 52
Universal Serial Bus (USB) 26
 Ports 26
USB device jumper 21
USB Legacy Support 58
Using
 3Deep Color Tuner 85

ASUS Update 84
 LiveUpdate 85
 PC Probe 79
USWC 60

V

Video Memory 59

