

M2NPV-VM

ASUS[®]

Motherboard

E2527

First Edition V1

May 2006

Copyright © 2006 ASUSTeK COMPUTER INC. All Rights Reserved.

No part of this manual, including the products and software described in it, may be reproduced, transmitted, transcribed, stored in a retrieval system, or translated into any language in any form or by any means, except documentation kept by the purchaser for backup purposes, without the express written permission of ASUSTeK COMPUTER INC. ("ASUS").

Product warranty or service will not be extended if: (1) the product is repaired, modified or altered, unless such repair, modification or alteration is authorized in writing by ASUS; or (2) the serial number of the product is defaced or missing.

ASUS PROVIDES THIS MANUAL "AS IS" WITHOUT WARRANTY OF ANY KIND, EITHER EXPRESS OR IMPLIED, INCLUDING BUT NOT LIMITED TO THE IMPLIED WARRANTIES OR CONDITIONS OF MERCHANTABILITY OR FITNESS FOR A PARTICULAR PURPOSE. IN NO EVENT SHALL ASUS, ITS DIRECTORS, OFFICERS, EMPLOYEES OR AGENTS BE LIABLE FOR ANY INDIRECT, SPECIAL, INCIDENTAL, OR CONSEQUENTIAL DAMAGES (INCLUDING DAMAGES FOR LOSS OF PROFITS, LOSS OF BUSINESS, LOSS OF USE OR DATA, INTERRUPTION OF BUSINESS AND THE LIKE), EVEN IF ASUS HAS BEEN ADVISED OF THE POSSIBILITY OF SUCH DAMAGES ARISING FROM ANY DEFECT OR ERROR IN THIS MANUAL OR PRODUCT.

SPECIFICATIONS AND INFORMATION CONTAINED IN THIS MANUAL ARE FURNISHED FOR INFORMATIONAL USE ONLY, AND ARE SUBJECT TO CHANGE AT ANY TIME WITHOUT NOTICE, AND SHOULD NOT BE CONSTRUED AS A COMMITMENT BY ASUS. ASUS ASSUMES NO RESPONSIBILITY OR LIABILITY FOR ANY ERRORS OR INACCURACIES THAT MAY APPEAR IN THIS MANUAL, INCLUDING THE PRODUCTS AND SOFTWARE DESCRIBED IN IT.

Products and corporate names appearing in this manual may or may not be registered trademarks or copyrights of their respective companies, and are used only for identification or explanation and to the owners' benefit, without intent to infringe.

Contents

Notices	vi
Safety information	vii
M2NPV-VM specifications summary	viii

Chapter 1: Product introduction

1.1	Welcome!	1-2
1.2	Package contents	1-2
1.3	Special features	1-2
	1.3.1 Product highlights	1-2
	1.3.2 Innovative ASUS features	1-5
1.4	Before you proceed	1-7
1.5	Motherboard overview	1-8
	1.5.1 Motherboard layout	1-8
	1.5.2 Placement direction	1-9
	1.5.3 Screw holes	1-9
1.6	Central Processing Unit (CPU)	1-10
	1.6.1 Installing the CPU	1-10
	1.6.2 Installing the heatsink and fan	1-12
1.7	System memory	1-12
	1.7.1 Overview	1-12
	1.7.2 Memory configurations	1-12
	1.7.3 Installing a DIMM	1-16
	1.7.4 Removing a DIMM	1-16
1.8	Expansion slots	1-15
	1.8.1 Installing an expansion card	1-17
	1.8.2 Configuring an expansion card	1-17
	1.8.3 PCI slots	1-19
	1.8.4 PCI Express x1 slot	1-19
	1.8.5 PCI Express x16 slot	1-19
1.9	Jumpers	1-20
1.10	Connectors	1-23
	1.10.1 Rear panel connectors	1-23
	1.10.2 Internal connectors	1-25

Contents

Chapter 2: BIOS setup

2.1	Managing and updating your BIOS	2-2
2.1.1	ASUS Update utility	2-2
2.1.2	Creating a bootable floppy disk	2-5
2.1.3	ASUS EZ Flash 2 utility	2-6
2.1.4	Updating the BIOS	2-7
2.1.5	Saving the current BIOS file	2-9
2.1.6	ASUS CrashFree BIOS 2 utility	2-10
2.2	BIOS setup program	2-11
2.2.1	BIOS menu screen	2-12
2.2.2	Menu bar	2-13
2.2.3	Legend bar	2-13
2.2.4	Menu items	2-13
2.2.5	Sub-menu items	2-13
2.2.6	Configuration fields	2-13
2.2.7	Pop-up window	2-14
2.2.8	General help	2-14
2.3	Main menu	2-15
2.3.1	System Time	2-15
2.3.2	System Date	2-15
2.3.3	Legacy Diskette A	2-15
2.3.4	Primary and Secondary IDE Master/Slave	2-15
2.3.5	First, Second, Third, Fourth SATA Master	2-18
2.3.6	HDD SMART Monitoring	2-19
2.3.7	Installed Memory	2-19
2.3.8	Usable Memory	2-19
2.4	Advanced menu	2-20
2.4.1	JumperFree Configuration	2-20
2.4.2	AI NET2	2-22
2.4.3	CPU Configuration	2-22
2.4.4	Chipset	2-24
2.4.5	PCIPnP	2-25
2.4.6	Onboard Devices Configuration	2-26

Contents

2.5	Power menu	2-30
2.5.1	ACPI Suspend Type	2-30
2.5.2	ACPI APIC Support	2-30
2.5.3	APM Configuration	2-30
2.5.4	Hardware Monitor	2-33
2.6	Boot menu	2-34
2.6.1	Boot Device Priority	2-34
2.6.2	Removable Drives	2-34
2.6.3	Hard Disk Drives	2-35
2.6.4	CDROM Drives	2-35
2.6.5	Boot Settings Configuration	2-35
2.6.6	Security	2-38
2.7	Tools menu	2-40
2.7.1	ASUS O.C. Profile	2-40
2.7.2	ASUS EZ Flash 2	2-42
2.8	Exit menu	2-43

Chapter 3: Software support

3.1	Installing an operating system	3-2
3.2	Support CD information	3-2
3.2.1	Running the support CD	3-2
3.2.2	Drivers menu	3-3
3.2.3	Utilities menu	3-4
3.2.4	Make Disk menu	3-5
3.2.5	Manual menu	3-6
3.2.6	ASUS Contact information	3-7
3.2.7	Other information	3-7

Notices

Federal Communications Commission Statement

This device complies with Part 15 of the FCC Rules. Operation is subject to the following two conditions:

- This device may not cause harmful interference, and
- This device must accept any interference received including interference that may cause undesired operation.

This equipment has been tested and found to comply with the limits for a Class B digital device, pursuant to Part 15 of the FCC Rules. These limits are designed to provide reasonable protection against harmful interference in a residential installation. This equipment generates, uses and can radiate radio frequency energy and, if not installed and used in accordance with manufacturer's instructions, may cause harmful interference to radio communications. However, there is no guarantee that interference will not occur in a particular installation. If this equipment does cause harmful interference to radio or television reception, which can be determined by turning the equipment off and on, the user is encouraged to try to correct the interference by one or more of the following measures:

- Reorient or relocate the receiving antenna.
- Increase the separation between the equipment and receiver.
- Connect the equipment to an outlet on a circuit different from that to which the receiver is connected.
- Consult the dealer or an experienced radio/TV technician for help.



The use of shielded cables for connection of the monitor to the graphics card is required to assure compliance with FCC regulations. Changes or modifications to this unit not expressly approved by the party responsible for compliance could void the user's authority to operate this equipment.

Canadian Department of Communications Statement

This digital apparatus does not exceed the Class B limits for radio noise emissions from digital apparatus set out in the Radio Interference Regulations of the Canadian Department of Communications.

This class B digital apparatus complies with Canadian ICES-003.

Safety information

Electrical safety

- To prevent electrical shock hazard, disconnect the power cable from the electrical outlet before relocating the system.
- When adding or removing devices to or from the system, ensure that the power cables for the devices are unplugged before the signal cables are connected. If possible, disconnect all power cables from the existing system before you add a device.
- Before connecting or removing signal cables from the motherboard, ensure that all power cables are unplugged.
- Seek professional assistance before using an adapter or extension cord. These devices could interrupt the grounding circuit.
- Make sure that your power supply is set to the correct voltage in your area. If you are not sure about the voltage of the electrical outlet you are using, contact your local power company.
- If the power supply is broken, do not try to fix it by yourself. Contact a qualified service technician or your retailer.

Operation safety

- Before installing the motherboard and adding devices on it, carefully read all the manuals that came with the package.
- Before using the product, make sure all cables are correctly connected and the power cables are not damaged. If you detect any damage, contact your dealer immediately.
- To avoid short circuits, keep paper clips, screws, and staples away from connectors, slots, sockets and circuitry.
- Avoid dust, humidity, and temperature extremes. Do not place the product in any area where it may become wet.
- Place the product on a stable surface.
- If you encounter technical problems with the product, contact a qualified service technician or your retailer.



The symbol of the crossed out wheeled bin indicates that the product (electrical and electronic equipment) should not be placed in municipal waste. Please check local regulations for disposal of electronic products.

M2NPV-VM specifications summary

CPU	Support AMD socket AM2 for AMD Athlon™ 64FX/ Athlon™ 64 X2/Athlon™ 64/Sempron processors AMD64 architecture enables simultaneous 32-bit and 64-bit computing Supports AMD Cool 'n' Quiet™ Technology AMD Live!™ Ready
Chipset	Northbridge: NVIDIA® GeForce™ 6150 GPU Southbridge: NVIDIA® nForce™430 MCP
Front Side Bus	2000/1600 MT/s
Memory	Dual-channel memory architecture 4 x 240-pin DIMM sockets support up to 8 GB of unbuffered ECC/non-ECC 800/667/533 MHz DDR2 memory modules
Expansion slots	1 x PCI Express™ x16 slot 1 x PCI Express™ x1 slot 2 x PCI slots
Graphics	Integrated in the NVIDIA® GeForce™ 6 Graphics Processing Unit (GPU) Dual VGA output: DVI-D and RGB High definition video processing with maximum resolution of 1920 x 1440 pixels (@75Hz) for RGB display Note: <i>DVI-D only supports digital display. You cannot convert DVI-D to output RGB signal to CRT display.</i> TV-out: SDTV& HDTV (with TV-Out module) Note: <i>RGB and TV-Out cannot be used simultaneously.</i>
Storage	NVIDIA® nForce™430 media and communications processor (MCP) supports: - 2 x Ultra DMA 133/100/66/33 interfaces for four (4) hard disk drives - 4 x Serial ATA 3 Gb/s hard disk drives supporting RAID 0, RAID 1, RAID 0+1, RAID 5, and JBOD configuration
High Definition Audio	SoundMAX® ADI AD1986A 5.1-channel CODEC Supports Jack Sensing technology S/PDIF out interface
LAN	NVIDIA® nForce™430 built-in Gigabit MAC with external Marvell® PHY
USB	Supports up to 8 USB 2.0 ports

(continued on the next page)

M2NPV-VM specifications summary

IEEE 1394	TI IEEE 1394a controller supports: - 2 x IEEE 1394a ports
Manageability	WfM2.0, DMI2.0, WOL by PME, WOR, PXE, Chassis Intrusion
Special features	ASUS Q-Fan 2 ASUS C.P.R. (CPU Parameter Recall) ASUS CrashFree BIOS 2 ASUS EZ Flash 2 ASUS O.C. Profile ASUS MyLogo™ Stepless Frequency Selection (SFS) allows FSB tuning from 200 MHz to 400 MHz at 1 MHz increment Note: <i>ASUS CrashFree BIOS 2 and ASUS EZ Flash 2 only support VGA/RGB output.</i>
BIOS features	4 Mb Flash ROM, Award BIOS, PnP, DMI2.0, WfM2.0, ACPI 2.0, SM BIOS 2.3
Rear panel	1 x Parallel port 1 x IEEE 1394a port 1 x LAN (RJ-45) port 4 x USB 2.0 ports 1 x VGA/RGB Out port 1 x VGA/DVI-D port 1 x PS/2 keyboard port 1 x PS/2 mouse port 5.1-channel audio ports
Internal connectors	1 x IEEE 1394a connector 1 x Front panel audio connector 1 x CD audio in connector 1 x Chassis intrusion connector 1 x Game/MIDI connector 1 x CPU fan connector 2 x Chassis fan connectors 1 x Floppy disk drive connector 2 x COM connectors 1 x Primary IDE connector 1 x Secondary IDE connector 1 x S/PDIF Out connector 1 x TV Out connector 4 x Serial ATA connectors 2 x USB 2.0 connectors for 4 additional USB 2.0 ports 1 x 24-pin ATX power connector 1 x 4-pin x ATX 12V power connector 1 x System panel connector

(continued on the next page)

M2NPV-VM specifications summary

Power Requirement	ATX power supply (with 24-pin and 4-pin 12 V plugs) ATX 12 V 2.0 compliant
Form Factor	uATX: 9.6 in. x 9.6 in. (24.5cm x 24.5cm)
Support CD contents	Device drivers ASUS PC Probe II AMD Cool 'n'Quiet™ utility ASUS Live Update utility Anti-virus software (OEM version)

*Specifications are subject to change without notice.

This chapter describes the motherboard features and the new technologies it supports.

Product introduction



1.1 Welcome!

Thank you for buying an ASUS® M2NPV-VM motherboard!

The motherboard delivers a host of new features and latest technologies, making it another standout in the long line of ASUS quality motherboards!

Before you start installing the motherboard, and hardware devices on it, check the items in your package with the list below.

1.2 Package contents

Check your motherboard package for the following items.

Motherboard	ASUS M2NPV-VM motherboard
Cables	2 x Serial ATA signal cables 1 x Serial ATA power cable for two Serial ATA devices 1 x IEEE 1394a module 1 x Ultra DMA 133/100/66 cable 1 x IDE cable 1 x Floppy disk drive cable
Accessories	I/O shield 1 x HDTV/AV/S output module
Application CD	ASUS motherboard support CD
Documentation	User guide



If any of the above items is damaged or missing, contact your retailer.

1.3 Special features

1.3.1 Product highlights

Latest processor technology



The motherboard supports AMD socket AM2 single-core Athlon 64/Sempron and dual-core Athlon 64 X2/Athlon 64 FX processors with 2MB/1MB/512KB L2 cache, which is based on 64-bit architecture. It features 2000/1600 MT/s HyperTransport Bus, dual-channel un-buffered DDR2 800 memory support and AMD Cool 'n' Quiet Technology. See page 1-10 for details.

AMD Cool 'n' Quiet Technology

The motherboard supports the AMD Cool 'n' Quiet Technology, which monitors system operation and automatically adjusts CPU voltage and frequency for a cool and quiet operating environment. See page 2-23 for details.

NVIDIA® GeForce™ 6150 GPU



and NVIDIA® nForce™ 430 MCP chipsets

The NVIDIA® GeForce™ 6150 graphics processing unit (GPU) Northbridge supports Microsoft® DirectX 9.0 Shader Model 3.0, dual VGA out (RGB and DVI-D), NVIDIA® PureVideo Technology with unprecedented integrated video quality, TV-out, and PCI Express interface.

The NVIDIA® nForce™ 430 media and communications processor (MCP) Southbridge delivers NVIDIA® Gigabit and NVIDIA® MediaShield storage management technology allowing easy RAID configuration (RAID 0, RAID 1, RAID 0+1, RAID 5, and JBOD) for Serial ATA 3Gb/s.

DDR2 memory support



The motherboard supports DDR2 memory which features data transfer rates of 800MHz/667 MHz/533 MHz to meet the higher bandwidth requirements of the latest 3D graphics, multimedia, and Internet applications. The dual-channel DDR2 architecture doubles the bandwidth of your system memory to boost system performance, eliminating bottlenecks with peak bandwidths of up to 12.8 GB/s. See pages 1-14 to 1-15 for details.

PCI Express™ interface

The motherboard fully supports PCI Express, the latest I/O interconnect technology that speeds up the PCI bus. PCI Express features point-to-point serial interconnections between devices and allows higher clockspeeds by carrying data in packets. This high speed interface is software compatible with existing PCI specifications. See page 1-19 for details.

Serial ATA 3Gb/s technology

The motherboard supports next-generation SATA hard drives based on the new SATA 3Gb/s storage specification. The onboard NVIDIA® nForce 430 MCP southbridge allows RAID 0, RAID 1, RAID 0+1, RAID 5, and JBOD configurations for four SATA connectors.

IEEE 1394a support

The IEEE 1394a interface provides high-speed and flexible PC connectivity to a wide range of peripherals and devices compliant to IEEE 1394a standards. The IEEE 1394a interface allows up to 400 Mbps transfer rates through simple, low-cost, high-bandwidth asynchronous (real-time) data interfacing between computers, peripherals, and consumer electronic devices such as camcorders, VCRs, printers, TVs, and digital cameras. See page 1-30 for details.

HDTV output

The motherboard features the NVIDIA® GeForce6150 chipset that supports superior HDTV-out functionality with a higher resolution to 1080i and 720p format, which are clearer than traditional formats allow. ASUS M2NPV-VM motherboard bundles a HDTV-out module that helps you enjoy the high-quality scaling and filtering technology.

Gigabit LAN solution

NVIDIA® Gb LAN controller delivers transfer speeds up to ten times faster than conventional 10/100 Ethernet connections. Gigabit LAN is the networking standard for the early future and is ideal for handling large amounts of data such as video, audio, and voice.

USB 2.0 technology

The motherboard implements the Universal Serial Bus (USB) 2.0 specification, dramatically increasing the connection speed from the 12 Mbps bandwidth on USB 1.1 to a fast 480 Mbps on USB 2.0. USB 2.0 is backward compatible with USB 1.1. See pages 1-24 and 1-29 for details.

High Definition Audio



SoundMAX is the highest performing, most reliable and user-friendly PC audio solution for business professionals, audiophiles, musicians, and gamers. Hear crystal-clear quality from all your audio - MP3 playback, home theatre, advanced gaming, VOIP and more, and never worry - SoundMAX high-definition audio is there to enhance your experience!

1.3.2 Innovative ASUS features

ASUS CrashFree BIOS 2

This feature allows you to restore the original BIOS data from the support CD in case when the BIOS codes and data are corrupted. This protection eliminates the need to buy a replacement BIOS chip. See page 2-10 for details.

ASUS EZ Flash 2

With the ASUS EZ Flash, you can easily update the system BIOS even before loading the operating system. No need to use a DOS-based utility or boot from a floppy disk. See page 2-6 for details.

ASUS O.C. Profile

The motherboard features the ASUS O.C. Profile that allows users to conveniently store or load multiple BIOS settings. The BIOS settings can be stored in the CMOS or a separate file, giving users freedom to share distribute their favorite overclocking settings.

ASUS Q-Fan 2 technology

The ASUS Q-Fan 2 technology smartly adjusts the fan speeds according to the system loading to ensure quiet, cool, and efficient operation. See page 2-33 for details.

C.P.R. (CPU Parameter Recall)

The C.P.R. feature of the motherboard BIOS allows automatic re-setting to the BIOS default settings in case the system hangs due to overclocking. When the system hangs due to overclocking, C.P.R. eliminates the need to open the system chassis and clear the RTC data. Simply shut down and reboot the system, and the BIOS automatically restores the CPU default setting for each parameter.

ASUS MyLogo™

This feature allows you to personalize and add style to your system with customizable boot logos. See page 2-37 for details.

1.4 Before you proceed

Take note of the following precautions before you install motherboard components or change any motherboard settings.



- Unplug the power cord from the wall socket before touching any component.
- Use a grounded wrist strap or touch a safely grounded object or a metal object, such as the power supply case, before handling components to avoid damaging them due to static electricity
- Hold components by the edges to avoid touching the ICs on them.
- Whenever you uninstall any component, place it on a grounded antistatic pad or in the bag that came with the component.
- **Before you install or remove any component, ensure that the ATX power supply is switched off or the power cord is detached from the power supply.** Failure to do so may cause severe damage to the motherboard, peripherals, and/or components.

Onboard LED

The motherboard comes with a standby power LED that lights up to indicate that the system is ON, in sleep mode, or in soft-off mode. This is a reminder that you should shut down the system and unplug the power cable before removing or plugging in any motherboard component. The illustration below shows the location of the onboard LED.

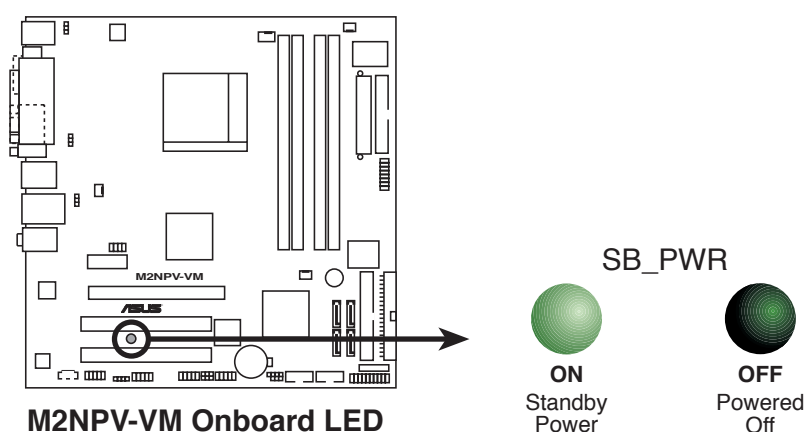

1.5 Motherboard overview

1.5.1 Motherboard layout

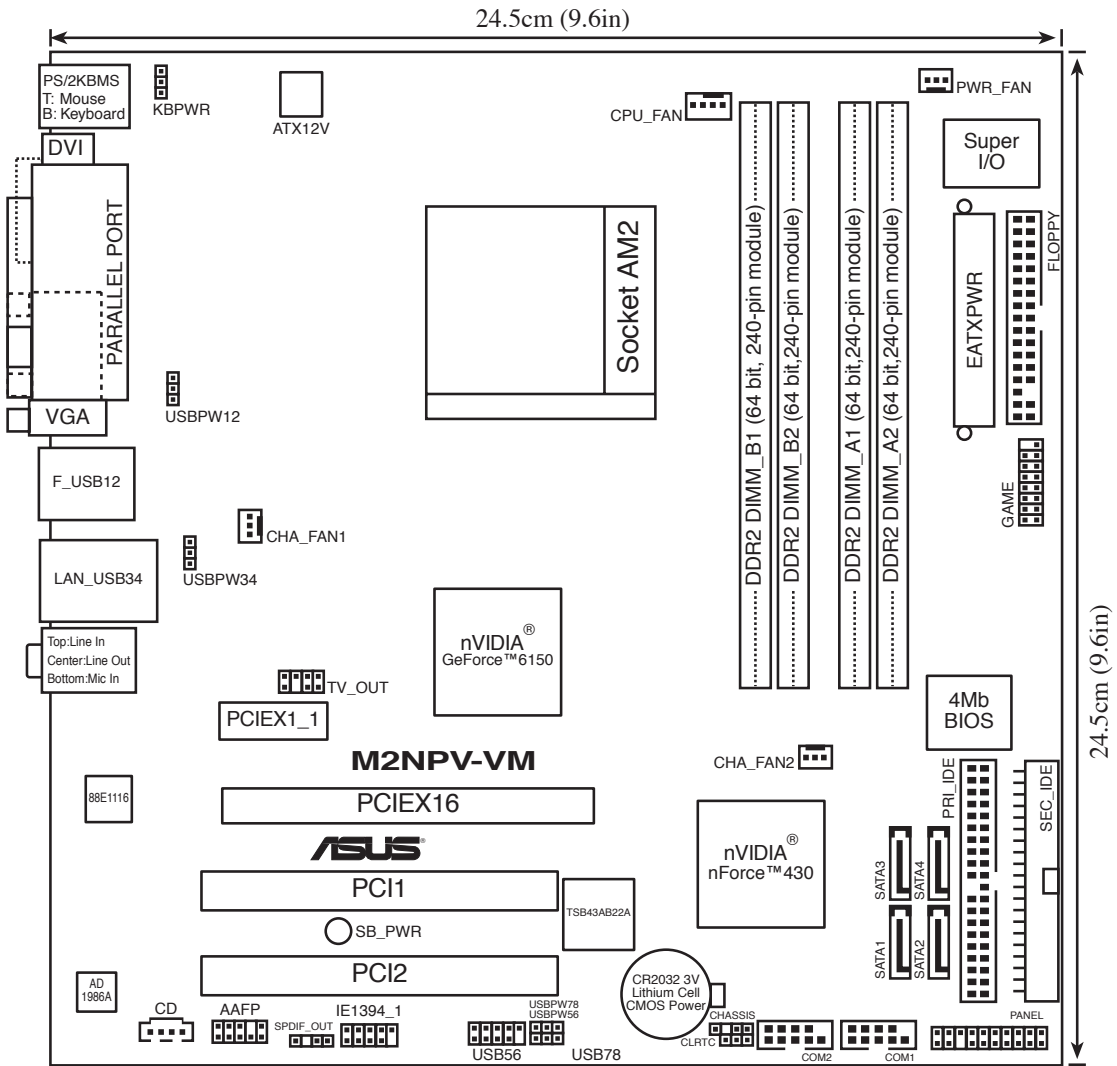

1.5.2 Placement direction

When installing the motherboard, make sure that you place it into the chassis in the correct orientation. The edge with external ports goes to the rear part of the chassis as indicated in the image below.

1.5.3 Screw holes

Place eight (8) screws into the holes indicated by circles to secure the motherboard to the chassis.



Do not overtighten the screws! Doing so can damage the motherboard.

Place this side towards
the rear of the chassis

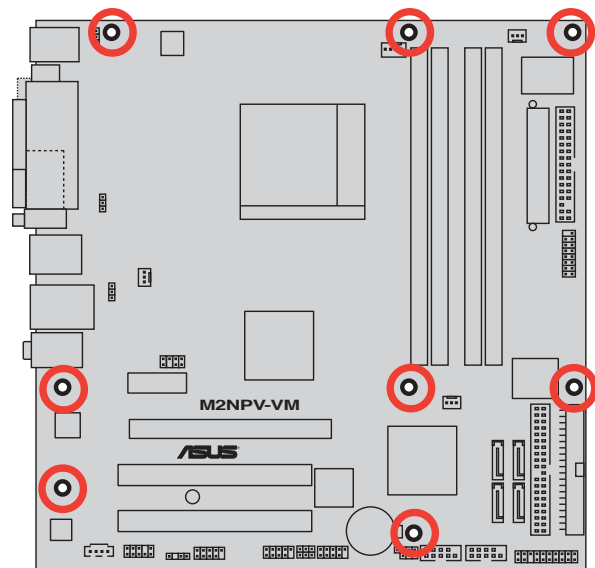

1.6 Central Processing Unit (CPU)

The motherboard comes with a 940-pin AM2 socket designed for the AMD Athlon™ 64 X2/Athlon™ 64/Athlon™ FX/Sempron™ processor.



The AM2 socket has a different pinout from the 940-pin socket designed for the AMD Opteron™ processor. Make sure you use a CPU is designed for the AM2 socket. The CPU fits in only one correct orientation. DO NOT force the CPU into the socket to prevent bending the connectors on the socket and damaging the CPU!

1.6.1 Installing the CPU

To install a CPU.

1. Locate the CPU socket on the motherboard.

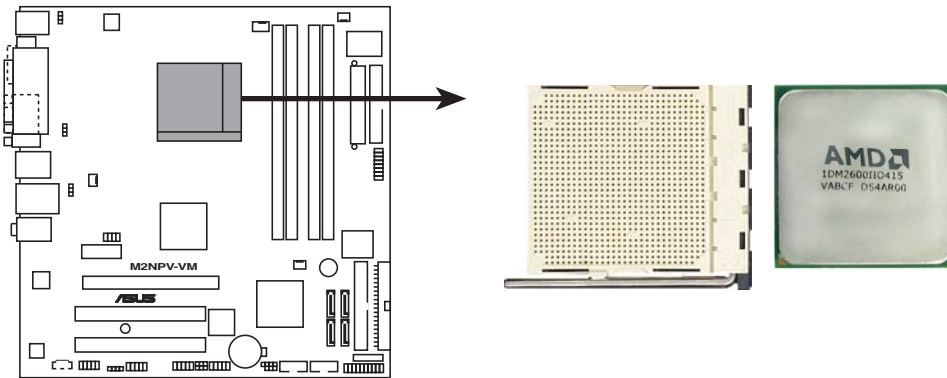

M2NPV-VM CPU Socket AM2

2. Unlock the socket by pressing the lever sideways, then lift it up to a 90°-100° angle.

Socket lever

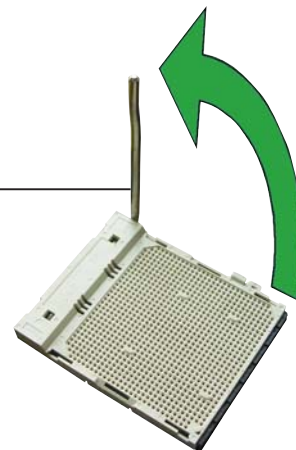

Make sure that the socket lever is lifted up to 90°-100° angle, otherwise the CPU does not fit in completely.

3. Position the CPU above the socket such that the CPU corner with the gold triangle matches the socket corner with a small triangle.
4. Carefully insert the CPU into the socket until it fits in place.

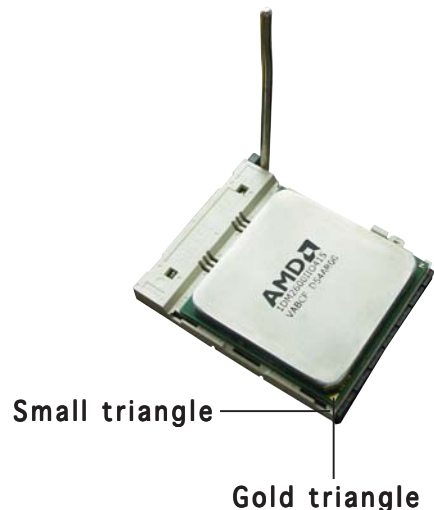

The CPU fits only in one correct orientation. DO NOT force the CPU into the socket to prevent bending the pins and damaging the CPU!

5. When the CPU is in place, push down the socket lever to secure the CPU. The lever clicks on the side tab to indicate that it is locked.
6. Install a CPU heatsink and fan following the instructions that came with the heatsink package.
7. Connect the CPU fan cable to the CPU_FAN connector on the motherboard.

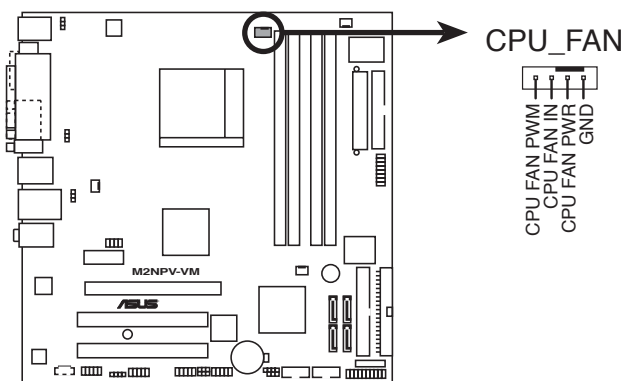

M2NPV-VM CPU fan connector

CPU_FAN
 CPU_FAN_PWM
 CPU_FAN_IN
 CPU_FAN_PWR
 GND



Do not forget to connect the CPU fan connector! Hardware monitoring errors can occur if you fail to plug this connector.

1.6.2 Installing the heatsink and fan

The AMD Athlon™ 64/Sempron™ processor require a specially designed heatsink and fan assembly to ensure optimum thermal condition and performance.



Make sure that you use only qualified heatsink and fan assembly.

Follow these steps to install the CPU heatsink and fan.

1. Place the heatsink on top of the installed CPU, making sure that the heatsink fits properly on the retention module base.



- The retention module base is already installed on the motherboard upon purchase.
 - You do not have to remove the retention module base when installing the CPU or installing other motherboard components.
 - If you purchased a separate CPU heatsink and fan assembly, make sure that a Thermal Interface Material is properly applied to the CPU heatsink or CPU before you install the heatsink and fan assembly.
-

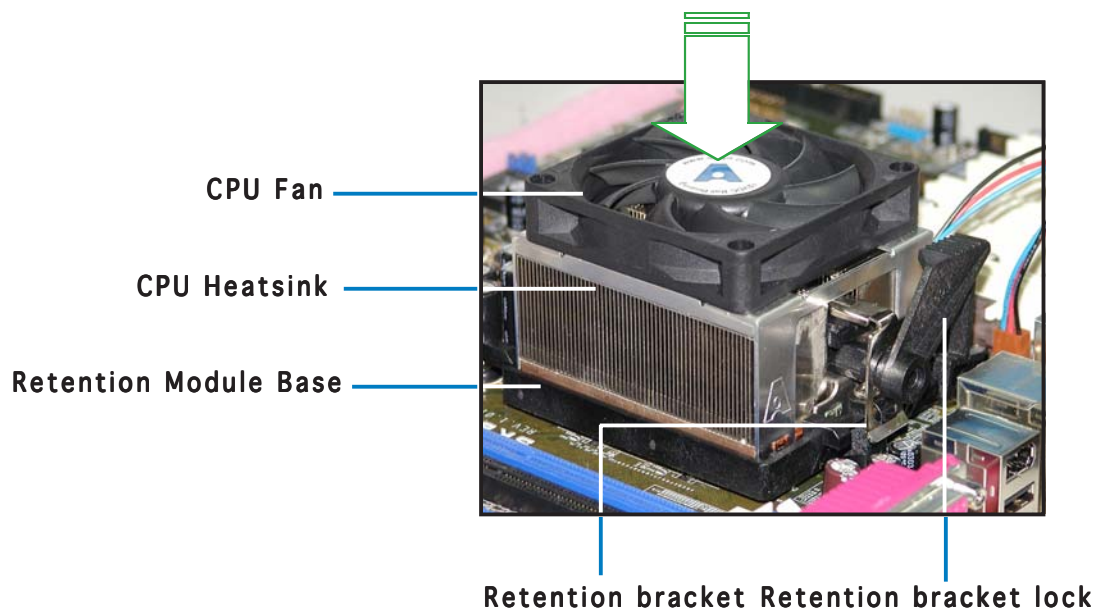

Your boxed CPU heatsink and fan assembly should come with installation instructions for the CPU, heatsink, and the retention mechanism. If the instructions in this section do not match the CPU documentation, follow the latter.

2. Attach one end of the retention bracket to the retention module base.

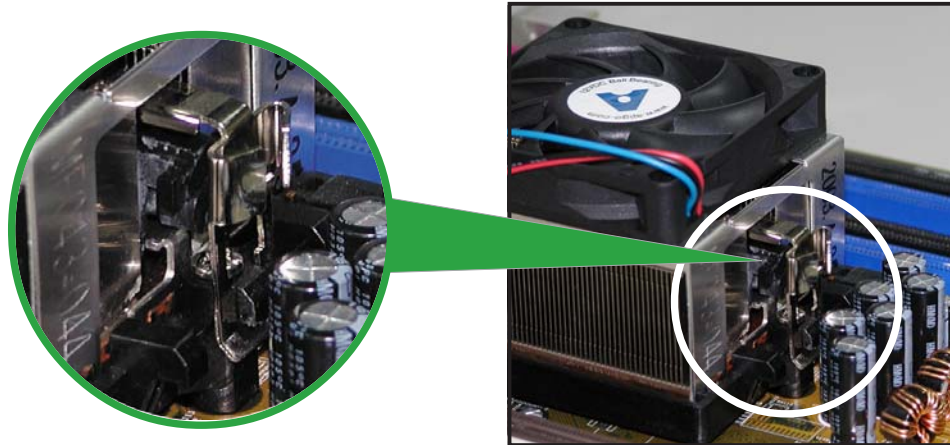

3. Align the other end of the retention bracket (near the retention bracket lock) to the retention module base. A clicking sound denotes that the retention bracket is in place.



Make sure that the fan and heatsink assembly perfectly fits the retention mechanism module base; otherwise, you cannot snap the retention bracket in place.



4. Push down the retention bracket lock on the retention mechanism to secure the heatsink and fan to the module base.

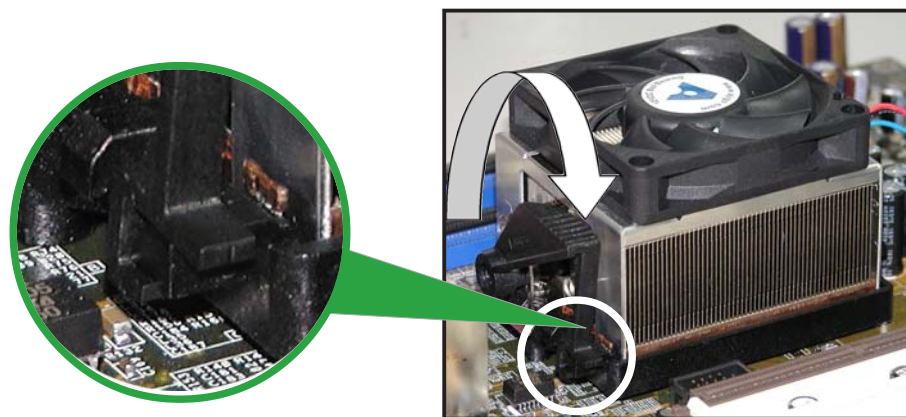

1.7 System memory

1.7.1 Overview

The motherboard comes with four Double Data Rate 2 (DDR2) Dual Inline Memory Modules (DIMM) sockets.

A DDR2 module has the same physical dimensions as a DDR DIMM but has a 240-pin footprint compared to the 184-pin DDR DIMM. DDR2 DIMMs are notched differently to prevent installation on a DDR DIMM socket.

The figure illustrates the location of the DDR2 DIMM sockets:

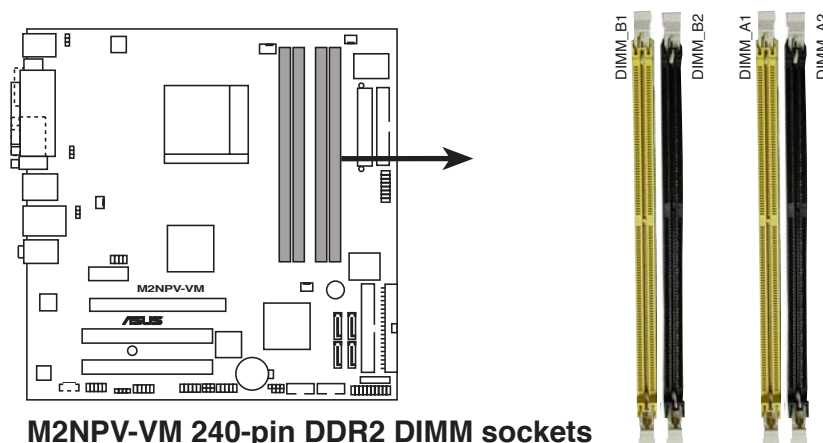

Channel	Sockets
Channel 1	DIMM_A1 and DIMM_B1
Channel 2	DIMM_A2 and DIMM_B2

1.7.2 Memory configurations

You may install 256 MB, 512 MB, 1 GB, and 2 GB unbuffered ECC/non-ECC DDR2 DIMMs into the DIMM sockets.



- For dual-channel configuration, the total size of memory module(s) installed per channel must be the same ($\text{DIMM_A1} + \text{DIMM_A2} = \text{DIMM_B1} + \text{DIMM_B2}$)
- Always install DIMMs with the same CAS latency. For optimum compatibility, we recommend that you obtain memory modules from the same vendor. Refer to the DDR2 Qualified Vendors List below for details.
- Due to chipset resource allocation, the system may detect less than 8 GB system memory when you installed four 2 GB DDR2 memory modules.
- This motherboard does not support memory modules made up of 128 Mb chips or double sided x16 memory modules.

Qualified Vendors Lists (QVL)

DDR2-800 MHz capability

Size	Vendor	Model	Brand	Side(s)	Component	DIMM support		
						A	B	C
256 MB	SAMSUNG	K4T56083QF-ZCE7	-	SS	M378T3253FZ3-CE7	•		
256 MB	SAMSUNG	K4T56083QF-ZCE7(ECC)	-	SS	M391T3253FZ3-CE7	•	•	
512 MB	SAMSUNG	EDD339XX	-	SS	M378T6553CZ3-CE7	•	•	
512 MB	Hynix	HY5PS12821AFP-S6	-	SS	HYMP564U64AP8-S6	•		
1024 MB	Hynix	HY5PS12821AFP-S6	-	DS	HYMP512U64AP8-S6	•	•	
512 MB	MICRON	5JAIIZ9DQQ	-	SS	MT8HTF6464AY-80EA3	•	•	•
1024 MB	MICRON	5JAIIZ9DQQ	-	DS	MT16HTF12864AY-80EA3	•	•	
1024 MB	CORSAIR	Heat-Sink Package	-	DS	CM2X1024-6400PRO	•	•	
256 MB	A-DATA	E2508AB-GE-E	-	SS	M20EL6F3G3160A1D0Z			•
256 MB	A-DATA	E2508AB-GE-E	-	SS	M20EL6F3G3160A1D0Z	•		
512 MB	Apacer	E2508AB-GE-E	-	DS	78.91091.420			•

DDR2-667 MHz capability

Size	Vendor	Model	Brand	Side(s)	Component	DIMM support		
						A	B	C
1024 MB	KINGSTON	E5108AE-6E-E	-	DS	KVR667D2N5/1G	•	•	
256 MB	SAMSUNG	K4T56083QF-ZCE6	-	SS	M378T3253FZ0-CE6			•
512 MB	SAMSUNG	K4T56083QF-ZCE6	-	DS	M378T6453FZ0-CE6	•	•	
256 MB	SAMSUNG	K4T51163QC-ZCE6	-	SS	M378T3354CZ0-CE6			•
512 MB	SAMSUNG	ZCE6K4T51083QC	-	SS	M378T6553CZ0-CE6	•	•	
256 MB	Infineon	HYB18T512160AF-3S	-	SS	HYS64T32000HU-3S-A			•
512 MB	Infineon	HYB18T512800AF3S	-	SS	HYS64T64000HU-3S-A	•		
512 MB	Infineon	HYB18T512800AF3S(ECC)-	-	SS	HYS72T64000HU-3S-A	•	•	•
1024 MB	Infineon	HYB18T512800AF3S(ECC)-	-	DS	HYS72T128020HU-3S-A	•	•	
512 MB	Hynix	HY5PS12821AFP-Y5	-	SS	HYMP564U64AP8-Y5	•	•	•
512 MB	Hynix	HY5PS12821AFP-Y4	-	SS	HYMP564U64AP8-Y4	•	•	
256 MB	ELPIDA	E2508AB-6E-E	-	SS	EBE25UC8ABFA-6E-E	•	•	•
512 MB	ELPIDA	E5108AB-6E-E	-	SS	EBE51UD8AEFA-6E-E	•	•	•
512 MB	crucial	Heat-Sink Package	-	DS	BL6464AA664.16FB	•	•	•
1024 MB	crucial	Heat-Sink Package	-	DS	BL12864AA664.16FA	•	•	
1024 MB	crucial	Heat-Sink Package	-	DS	BL12864AL664.16FA	•	•	•
1024 MB	crucial	Heat-Sink Package	-	DS	BL12864AL663.16FA	•		

Side(s): **SS** - Single-sided **DS** - Double-sided

DIMM support:

- A** - Supports one module inserted in any slot as Single-channel memory configuration.
- B** - Supports one pair of modules inserted into either the blue slots or the black slots as one pair of Dual-channel memory configuration.
- C** - Supports 3 modules inserted into both the blue and black slots as two pairs of Dual-channel memory configuration.



Visit the [ASUS website](#) for the latest DDR2-800/667 MHz QVL.

1.7.3 Installing a DIMM



Make sure to unplug the power supply before adding or removing DIMMs or other system components. Failure to do so may cause severe damage to both the motherboard and the components.

1. Unlock a DIMM socket by pressing the retaining clips outward.
2. Align a DIMM on the socket such that the notch on the DIMM matches the break on the socket.
3. Firmly insert the DIMM into the socket until the retaining clips snap back in place and the DIMM is properly seated.

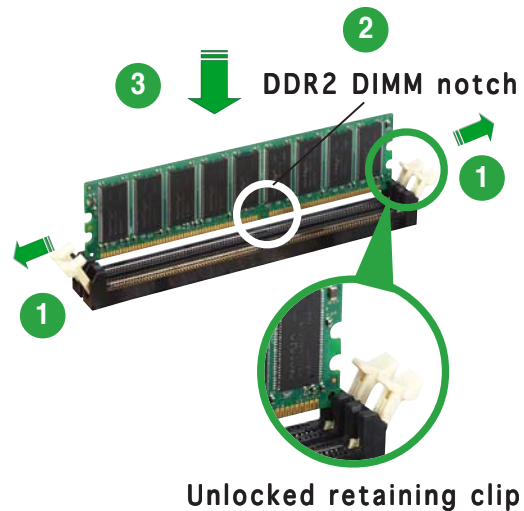

- A DDR2 DIMM is keyed with a notch so that it fits in only one direction. DO NOT force a DIMM into a socket to avoid damaging the DIMM.
- The DDR2 DIMM sockets do not support DDR DIMMs. Do not install DDR DIMMs to the DDR2 DIMM sockets.

1.7.4 Removing a DIMM

To remove a DIMM:

1. Simultaneously press the retaining clips outward to unlock the DIMM.

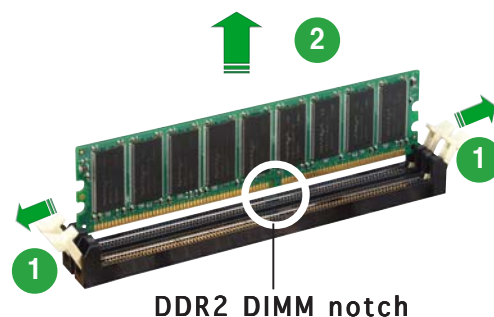

Support the DIMM lightly with your fingers when pressing the retaining clips. The DIMM might get damaged when it flips out with extra force.

2. Remove the DIMM from the socket.

1.8 Expansion slots

In the future, you may need to install expansion cards. The following sub-sections describe the slots and the expansion cards that they support.



Make sure to unplug the power cord before adding or removing expansion cards. Failure to do so may cause you physical injury and damage motherboard components.

1.8.1 Installing an expansion card

To install an expansion card:

1. Before installing the expansion card, read the documentation that came with it and make the necessary hardware settings for the card.
2. Remove the system unit cover (if your motherboard is already installed in a chassis).
3. Remove the bracket opposite the slot that you intend to use. Keep the screw for later use.
4. Align the card connector with the slot and press firmly until the card is completely seated on the slot.
5. Secure the card to the chassis with the screw you removed earlier.
6. Replace the system cover.

1.8.2 Configuring an expansion card

After installing the expansion card, configure it by adjusting the software settings.

1. Turn on the system and change the necessary BIOS settings, if any. See Chapter 2 for information on BIOS setup.
2. Assign an IRQ to the card. Refer to the tables on the next page.
3. Install the software drivers for the expansion card.

Standard interrupt assignments

IRQ	Priority	Standard Function
0	1	System Timer
1	2	Keyboard Controller
2	-	Re-direct to IRQ#9
3	11	IRQ holder for PCI steering*
4	12	Communications Port (COM1)*
5	13	IRQ holder for PCI steering*
6	14	Floppy Disk Controller
7	15	Printer Port (LPT1)*
8	3	System CMOS/Real Time Clock
9	4	IRQ holder for PCI steering*
10	5	IRQ holder for PCI steering*
11	6	IRQ holder for PCI steering*
12	7	PS/2 Compatible Mouse Port*
13	8	Numeric Data Processor
14	9	Primary IDE Channel
15	10	Secondary IDE Channel

* These IRQs are usually available for ISA or PCI devices.

IRQ assignments for this motherboard

	A	B	C	D
PCI slot 1	used	—	—	—
PCI slot 2	—	used	—	—
IEEE 1394	—	—	—	shared



When using PCI cards on shared slots, ensure that the drivers support “Share IRQ” or that the cards do not need IRQ assignments; otherwise, conflicts will arise between the two PCI groups, making the system unstable and the card inoperable.

1.8.3 PCI slots

The PCI slots support cards such as a LAN card, SCSI card, USB card, and other cards that comply with PCI specifications. The figure shows a LAN card installed on a PCI slot.

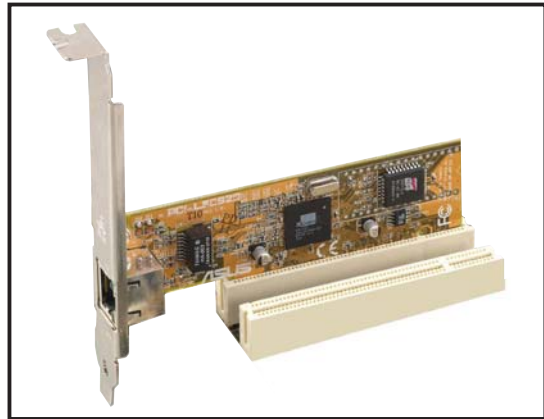

1.8.4 PCI Express x1 slot

This motherboard supports PCI Express x1 network cards, SCSI cards and other cards that comply with the PCI Express specifications. The following figure shows a network card installed on the PCI Express x1 slot.



1.8.5 PCI Express x16 slot

This motherboard has supports PCI Express x16 graphic cards that comply with PCI Express specifications. The figure shows a graphics card installed on the PCI Express x16 slot.

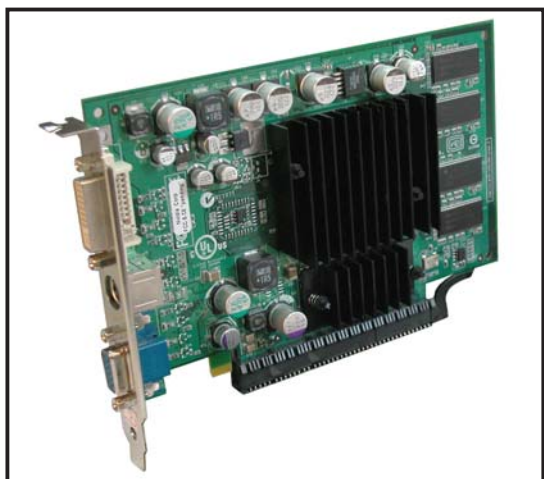

1.9 Jumpers

1. Clear RTC RAM (CLRTC)

This jumper allows you to clear the Real Time Clock (RTC) RAM in CMOS. You can clear the CMOS memory of date, time, and system setup parameters by erasing the CMOS RTC RAM data. The onboard button cell battery powers the RAM data in CMOS, which include system setup information such as system passwords.

To erase the RTC RAM:

1. Turn OFF the computer and unplug the power cord.
2. Remove the onboard battery.
3. Move the jumper cap from pins 1-2 (default) to pins 2-3. Keep the cap on pins 2-3 for about 5~10 seconds, then move the cap back to pins 1-2.
4. Reinstall the battery.
5. Plug the power cord and turn ON the computer.
6. Hold down the key during the boot process and enter BIOS setup to re-enter data.



Except when clearing the RTC RAM, never remove the cap on CLRTC jumper default position. Removing the cap will cause system boot failure!

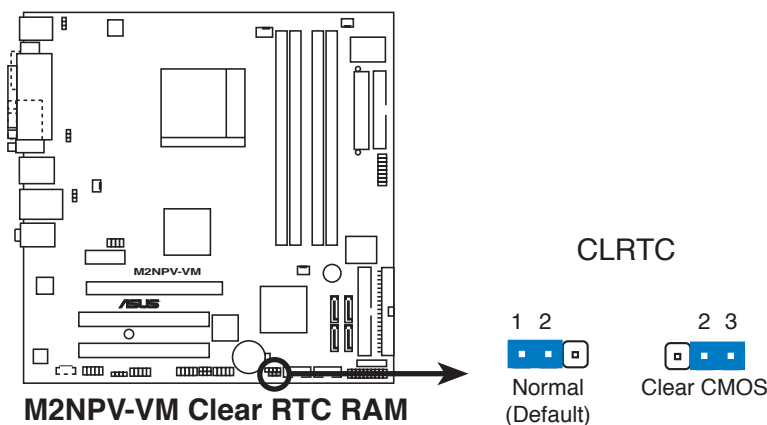

You do not need to clear the RTC when the system hangs due to overclocking. For system failure due to overclocking, use the C.P.R. (CPU Parameter Recall) feature. Shut down and reboot the system so the BIOS can automatically reset parameter settings to default values.

2. USB device wake-up (3-pin USBPW12, USBPW34, USBPW56, USBPW78)

Set these jumpers to +5V to wake up the computer from S1 sleep mode (CPU stopped, DRAM refreshed, system running in low power mode) using the connected USB devices. Set to +5VSB to wake up from S3 and S4 sleep modes.

The USBPW12 and USBPW34 jumpers are for the rear USB ports. The USBPW56 and USBPW78 jumper is for the internal USB connectors that you can connect to additional USB ports.

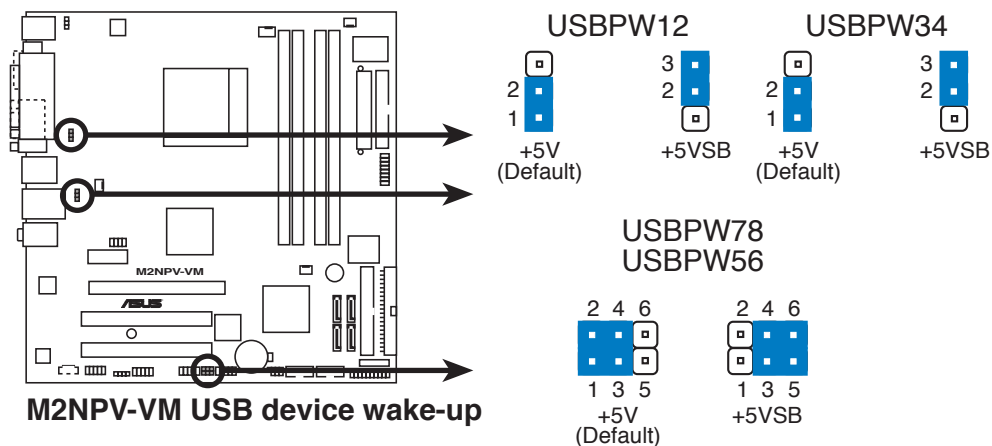

- The USB device wake-up feature requires a power supply that can provide 500mA on the +5VSB lead for each USB port; otherwise, the system will not power up.
- The total current consumed must NOT exceed the power supply capability (+5VSB) whether under normal condition or in sleep mode.

3. Keyboard power (3-pin KBPWR)

This jumper allows you to enable or disable the keyboard wake-up feature. Set this jumper to pins 2-3 (+5VSB) to wake up the computer when you press a key on the keyboard (the default is the Space Bar). This feature requires an ATX power supply that can supply at least 500 mA on the +5VSB lead, and a corresponding setting in the BIOS.

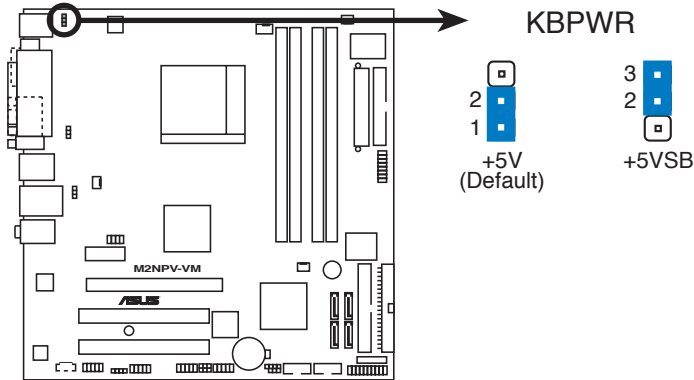

M2NPV-VM Keyboard power setting

1.10 Connectors

1.10.1 Rear panel connectors

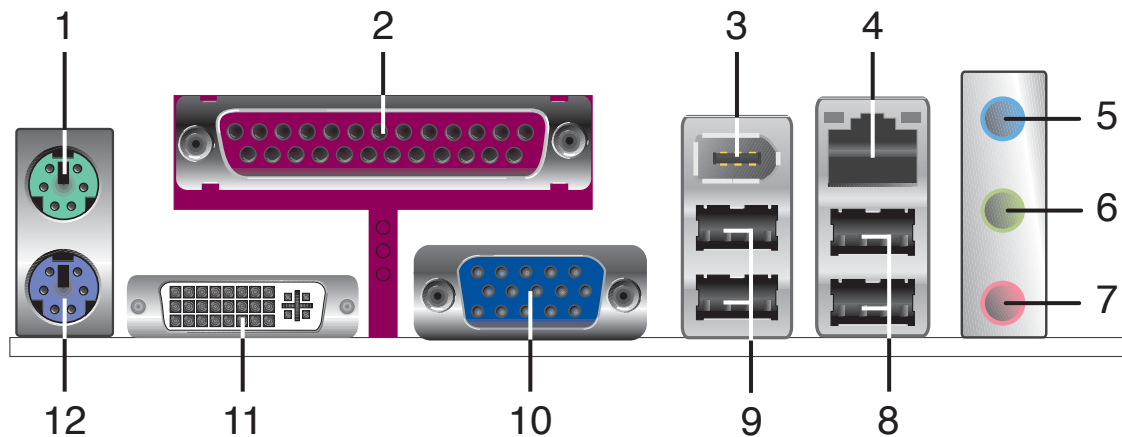

1. **PS/2 mouse port (green).** This port is for a PS/2 mouse.
2. **Parallel port.** This 25-pin port connects a parallel printer, a scanner, or other devices.
3. **IEEE 1394a port.** This 6-pin IEEE 1394a port provides high-speed connectivity for audio/video devices, storage peripherals, PCs, or portable devices.
4. **LAN (RJ-45) port.** This port allows Gigabit connection to a Local Area Network (LAN) through a network hub.

LAN port LED indications

ACT/LINK LED		SPEED LED	
Status	Description	Status	Description
OFF	No link	OFF	10 Mbps connection
Orange	Linked	ORANGE	100 Mbps connection
BLINKING	Data activity	GREEN	1 Gbps connection

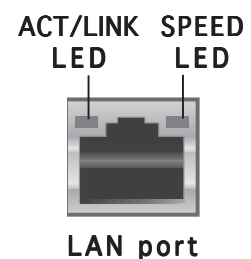

5. **Line In port (light blue).** This port connects a tape, CD, DVD player, or other audio sources.
6. **Line Out port (lime).** This port connects a headphone or a speaker. In 4-channel/ 6-channel configuration, the function of this port becomes Front Speaker Out.
7. **Microphone port (pink).** This port connects a microphone.



Refer to the audio configuration table for the function of the audio ports in 2, 4, or 6,-channel configuration.

Audio 2, 4, or 6-channel configuration

Port	Headset 2-speaker	4-speaker	6-speaker
Light Blue	Line In	Surround Out	Surround Out
Lime	Line Out	Front Speaker Out	Front Speaker Out
Pink	Mic In	Mic	Center/Bass

- 8. USB 2.0 ports 3 and 4.** These two 4-pin Universal Serial Bus (USB) ports are available for connecting USB 2.0 devices.
- 9. USB 2.0 ports 1 and 2.** These two 4-pin Universal Serial Bus (USB) ports are available for connecting USB 2.0 devices.
- 10. Video Graphics Adapter (VGA) port.** This 15-pin port is for a VGA monitor or other VGA-compatible devices.
- 11. DVI-D Out port.** This port connects a Digital Visual Interface (DVI-D) card.
- 12. PS/2 keyboard port (purple).** This port is for a PS/2 keyboard.

1.10.2 Internal connectors

1. Floppy disk drive connector (34-1 pin FLOPPY)

This connector is for the provided floppy disk drive (FDD) signal cable. Insert one end of the cable to this connector, then connect the other end to the signal connector at the back of the floppy disk drive.



Pin 5 on the connector is removed to prevent incorrect cable connection when using an FDD cable with a covered Pin 5.

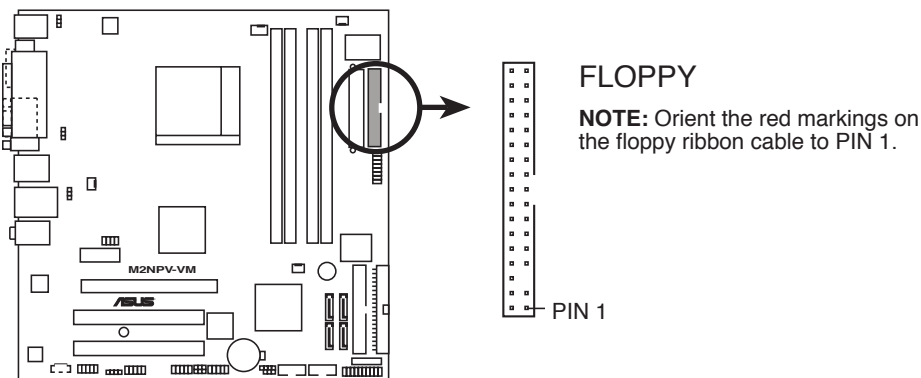

M2NPV-VM Floppy disk drive connector

2. Chassis intrusion connector (4-1 pin CHASSIS)

This connector is for a chassis-mounted intrusion detection sensor or switch. Connect one end of the chassis intrusion sensor or switch cable to this connector. The chassis intrusion sensor or switch sends a high-level signal to this connector when a chassis component is removed or replaced. The signal is then generated as a chassis intrusion event.

By default, the pins labeled “Chassis Signal” and “Ground” are shorted with a jumper cap. Remove the jumper caps only when you intend to use the chassis intrusion detection feature.

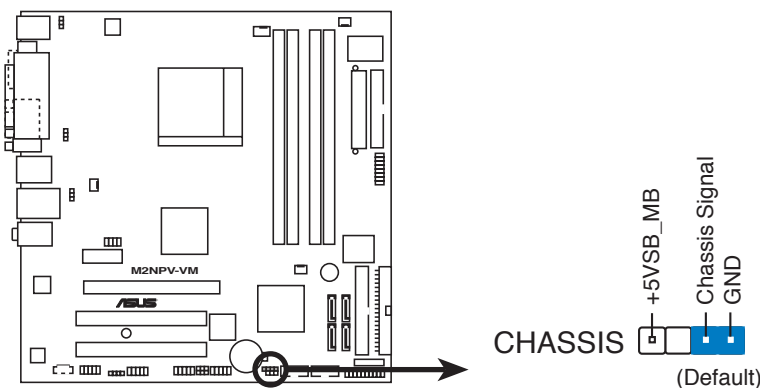

M2NPV-VM Chassis intrusion connector

3. IDE connectors (40-1 pin PRI_IDE; 40-1 pin SEC_IDE)

The onboard IDE connectors are for Ultra DMA 133/100/66 signal cable(s). There are three connectors on each Ultra DMA 133/100/66 signal cable: blue, black, and gray. Connect the blue connector to the motherboard's IDE connector, then select one of the following modes to configure your device(s).

	Drive jumper setting	Mode of device(s)	Cable connector
Single device	Cable-Select or Master	-	Black
Two devices	Cable-Select	Master Slave	Black Gray
	Master Slave	Master Slave	Black or gray



- Pin 20 on the IDE connector is removed to match the covered hole on the Ultra DMA cable connector. This prevents incorrect insertion when you connect the IDE cable.
- Use the 80-conductor IDE cable for Ultra DMA 133/100/66 IDE devices.



If any device jumper is set as "Cable-Select," make sure all other device jumpers have the same setting.

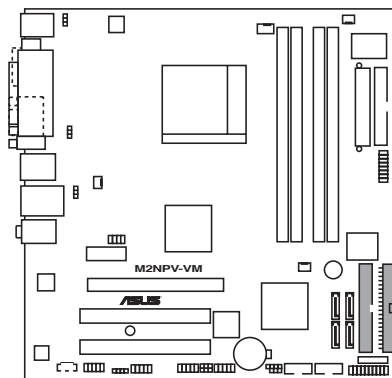

M2NPV-VM IDE connectors

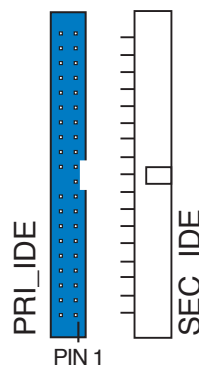

NOTE: Orient the red markings (usually zigzag) on the IDE ribbon cable to PIN 1.

4. Serial ATA connectors (7-pin SATA1, SATA2, SATA3, SATA4)

These connectors are for the Serial ATA signal cables for Serial ATA 3.0 Gb/s hard disk and optical disk drives. The Serial ATA 3 Gb/s is backward compatible with Serial ATA 1.5Gb/s specification.

The current Serial ATA I interface allows up to 150 MB/s data transfer rate while Serial ATA II allows up to 300 MB/s data transfer rate, faster than the standard parallel ATA with 133 MB/s (Ultra DMA133).

If you install Serial ATA hard disk drives, you can create a RAID 0, RAID 1, RAID 0+1, RAID 5, and JBOD configuration through the onboard NVIDIA® MediaShield™ controller.

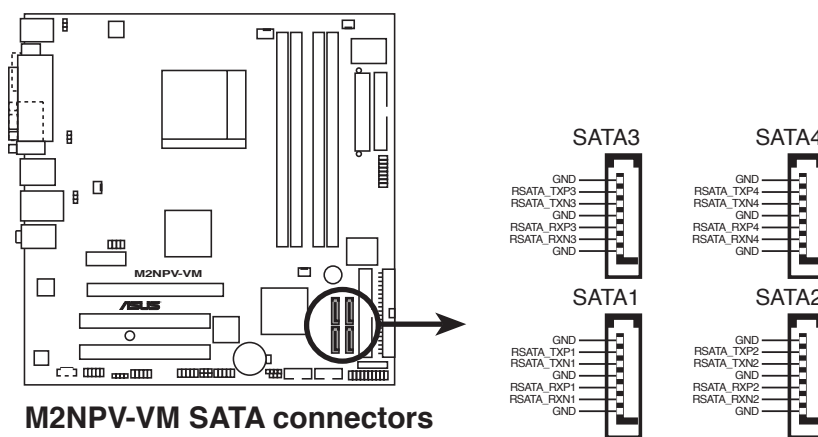

M2NPV-VM SATA connectors



Important note on Serial ATA

Install the Windows® 2000 Service Pack 4 or the Windows® XP Service Pack1 before using Serial ATA.



- For detailed instructions on how to configure RAID 0, 1, 0+1, 5, and JBOD, refer to the RAID manual in the support CD.
- The RAID function of these connectors is set to [Disabled] by default. If you intend to create a Serial ATA RAID set using these connectors, enable the **RAID Enabled** item in the NVRAID Configuration sub-menu in the BIOS. See section “2.4.6 Onboard Device Configuration” for details.

5. CPU, Chassis, and Power Fan connectors (4-pin CPU_FAN, 3-pin PWR_FAN, 3-pin CHA_FAN1, 3-pin CHA_FAN2)

The fan connectors support cooling fans of 350mA~740mA (8.88W max.) or a total of 1A~2.22A (26.64W max.) at +12V. Connect the fan cables to the fan connectors on the motherboard, making sure that the black wire of each cable matches the ground pin of the connector.



Do not forget to connect the fan cables to the fan connectors. Insufficient air flow inside the system may damage the motherboard components. These are not jumpers! DO NOT place jumper caps on the fan connectors.



Only CPU Fan and Chassis Fan1, Fan2 support Q-Fan 2.

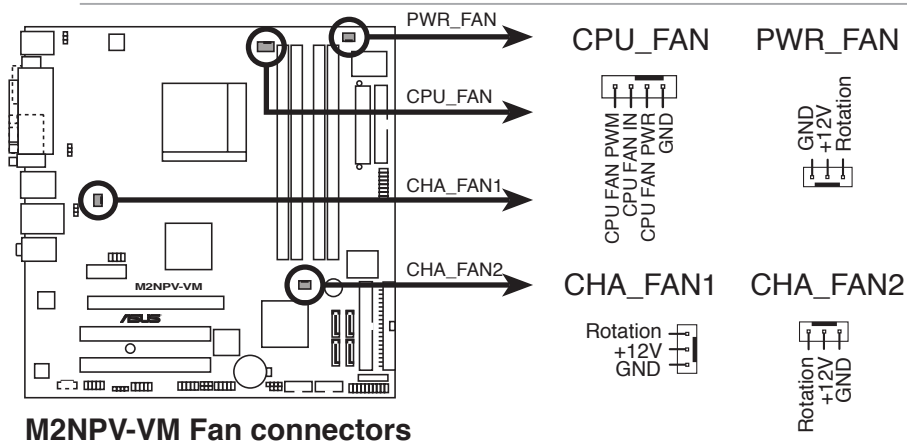

6. Digital audio connector (4-1 pin SPDIF_OUT)

This connector is for an additional Sony/Philips Digital Interface (S/PDIF) port(s). Connect the S/PDIF module cable to this connector, then install the module to a slot opening at the back of the system chassis.



The S/PDIF module is purchased separately.

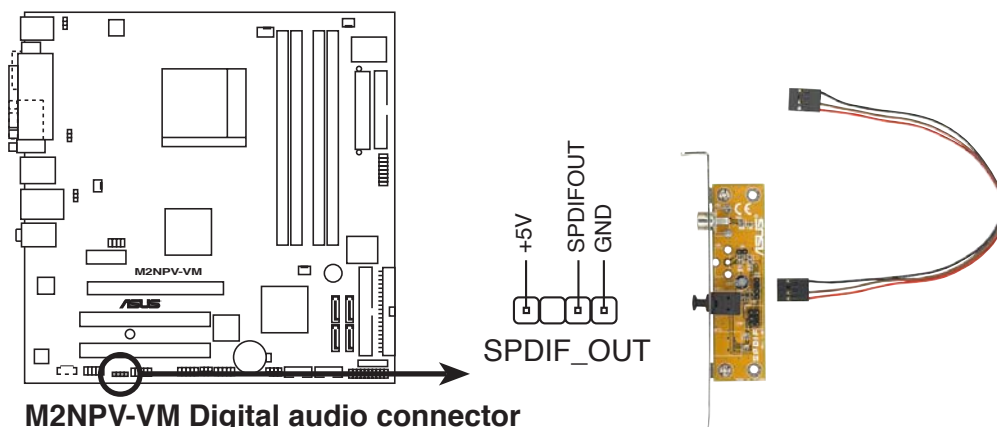

7. USB connectors (10-1 pin USB56, USB78)

These connectors are for USB 2.0 ports. Connect the USB module cable to any of these connectors, then install the module to a slot opening at the back of the system chassis. These USB connectors comply with USB 2.0 specification that supports up to 480 Mbps connection speed.

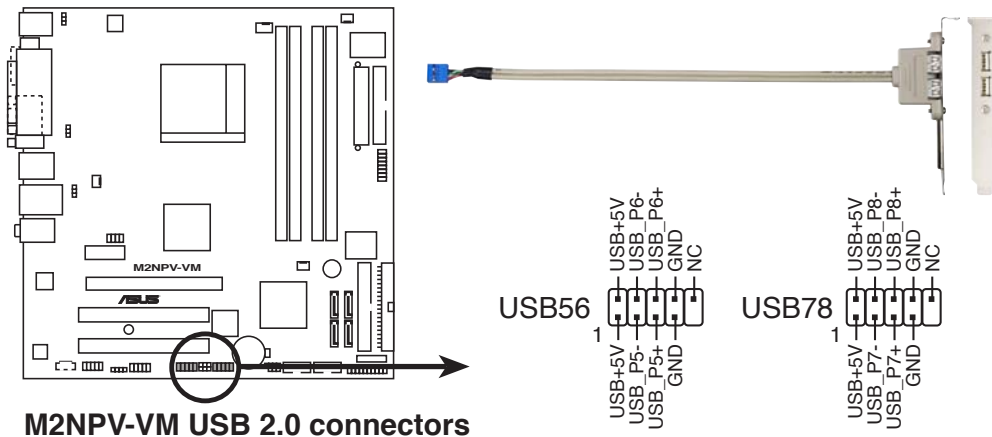

M2NPV-VM USB 2.0 connectors



Never connect a **1394 cable** to the USB connectors. Doing so will damage the motherboard!



The USB 2.0 module is purchased separately.

8. Optical drive audio in connector (4-pin CD)

These connectors allow you to receive stereo audio input from sound sources such as a CD-ROM, TV tuner, or MPEG card.

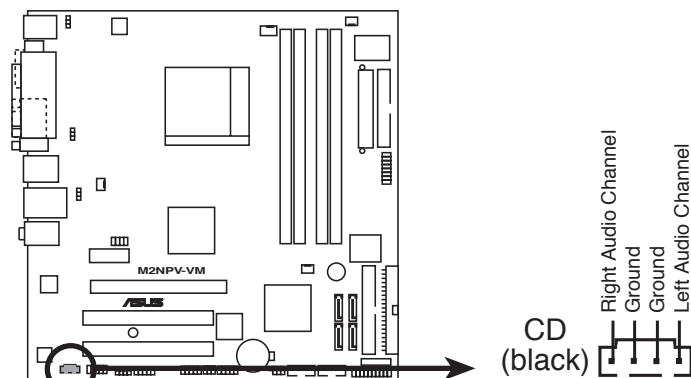

M2NPV-VM Internal audio connector

9. GAME/MIDI port connector (16-1 pin GAME)

This connector is for a GAME/MIDI port. Connect the USB/GAME module cable to this connector, then install the module to a slot opening at the back of the system chassis. The GAME/MIDI port connects a joystick or game pad for playing games, and MIDI devices for playing or editing audio files.

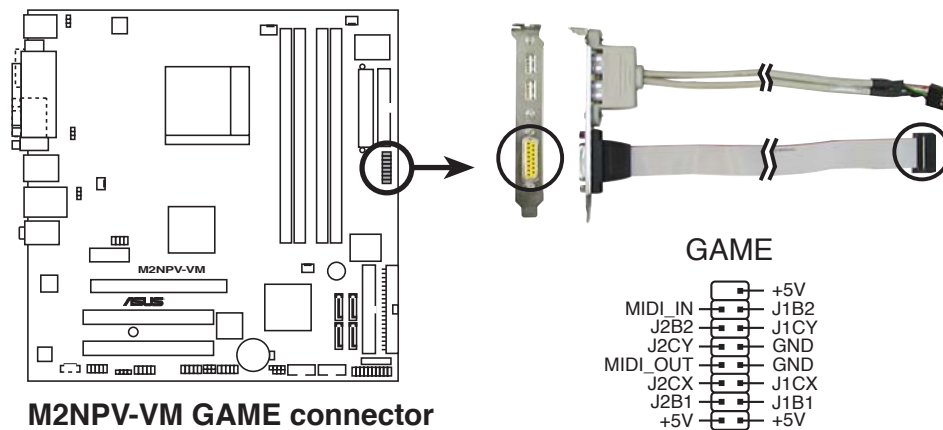

M2NPV-VM GAME connector



The GAME/MIDI port module is purchased separately.

10. IEEE 1394a connector (10-1 pin IE1394_1 [red])

This connector is for an additional IEEE 1394a port. Connect the IEEE 1394a module cable (orange) to this connector, then install the module to a slot opening at the back of the system chassis.

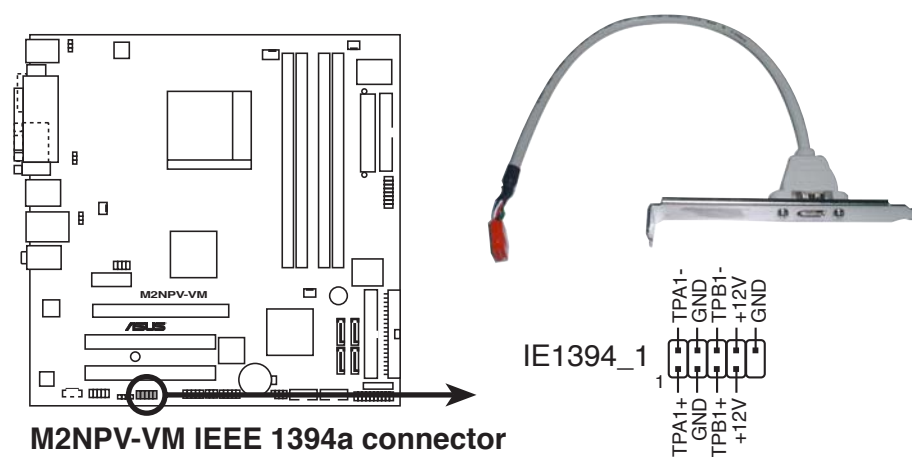

M2NPV-VM IEEE 1394a connector



Never connect a **USB port module cable** to the IEEE 1394a connector. Doing so will damage the motherboard!

11. Serial port connectors (10-1 pin COM1; 10-1 pin COM2)

These connectors are for serial (COM) ports. Connect the serial port module cable to any of these connectors, then install the module to a slot opening at the back of the system chassis.



The serial port bracket (COM1) is purchased separately.

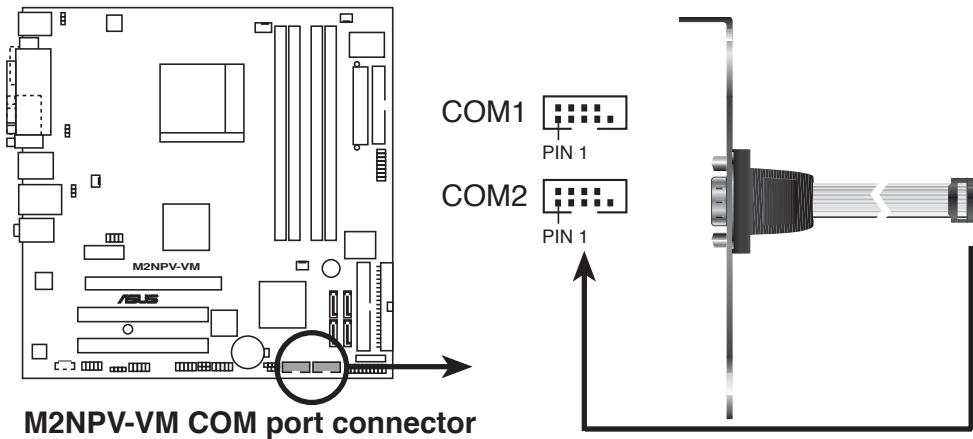

12. Front panel audio connector (10-1 pin AAFP)

This connector is for a chassis-mounted front panel audio I/O module that supports either High Definition Audio or AC`97 audio standard. Connect one end of the front panel audio I/O module cable to this connector.

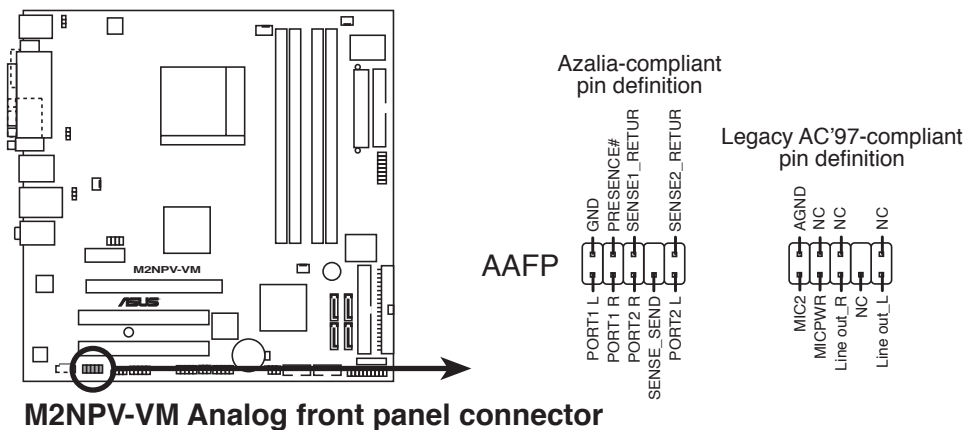

- We recommend that you connect a high-definition front panel audio module to this connector to avail of the motherboard high-definition audio capability.
- If you want to connect a high-definition front panel audio module to this connector, make sure that the **HD Audio** item in the BIOS is set to [Enabled]. See page 2-28 for details.

13. TV-out connector (8-1 pin TV_OUT)

This 8-1 pin connector is for the TV-out port module that allows you to connect a television to your system. Connect one end of the HDTV-out cable to this connector and the other end to the TV-out module.

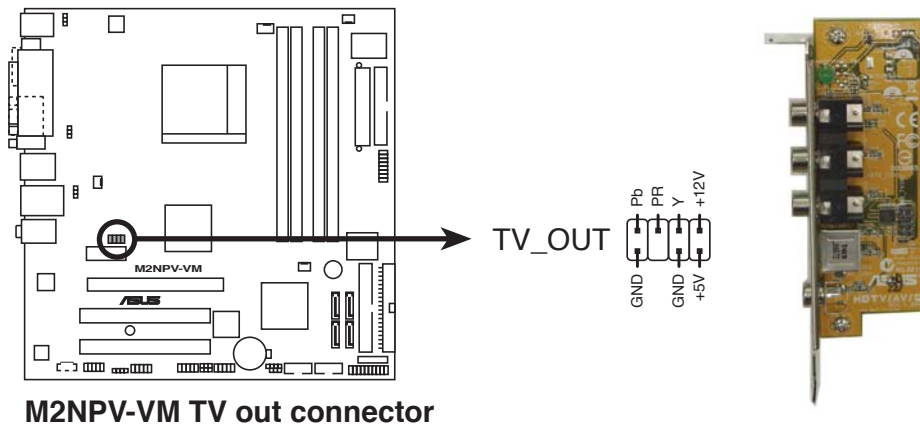

M2NPV-VM TV out connector



-
- RGB and TV-out can not be used simultaneously.
-

14. ATX power connectors (24-pin EATXPWR, 4-pin ATX12V)

These connectors are for an ATX power supply. The plugs from the power supply are designed to fit these connectors in only one orientation. Find the proper orientation and push down firmly until the connectors completely fit.



- We recommend that you use an ATX 12 V Specification 2.0-compliant power supply unit (PSU) with a minimum of 300 W power rating. This PSU type has 24-pin and 4-pin power plugs.
- If you intend to use a PSU with 20-pin and 4-pin power plugs, make sure that the 20-pin power plug can provide at least 15 A on +12 V and that the PSU has a minimum power rating of 300 W. The system may become unstable or may not boot up if the power is inadequate.
- Do not forget to connect the 4-pin ATX +12 V power plug; otherwise, the system will not boot up.
- We recommend that you use a PSU with higher power output when configuring a system with more power-consuming devices. The system may become unstable or may not boot up if the power is inadequate.
- You must install a PSU with a higher power rating if you intend to install additional devices.

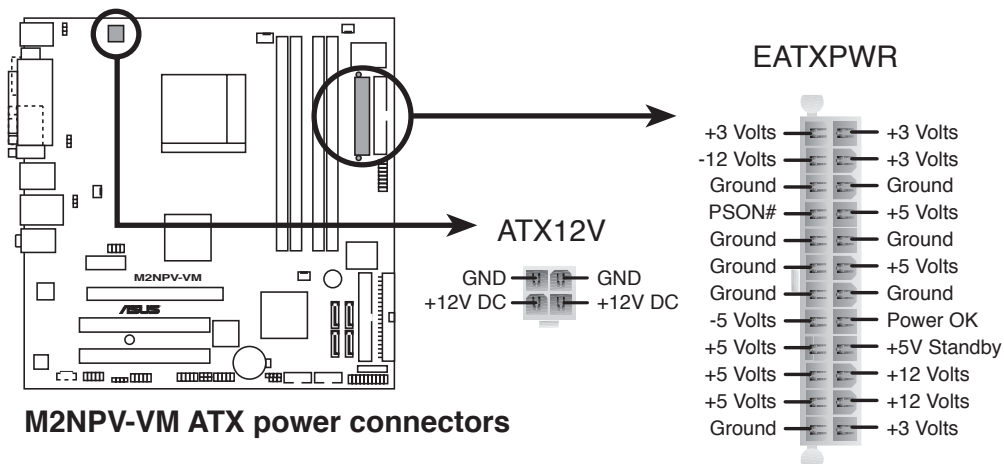

15. System panel connector (20-1 pin PANEL)

This connector supports several chassis-mounted functions.

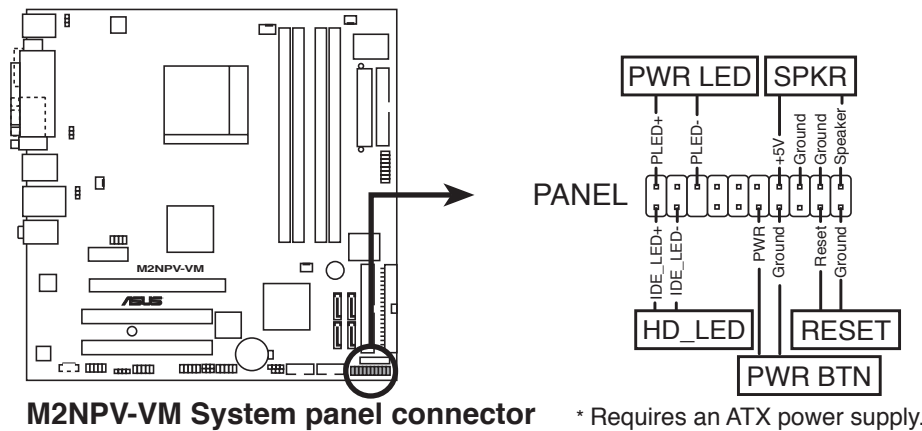

- **System power LED**
This 3-pin connector is for the system power LED. Connect the chassis power LED cable to this connector. The system power LED lights up when you turn on the system power, and blinks when the system is in sleep mode.
- **Hard disk drive activity LED**
This 2-pin connector is for the HDD Activity LED. Connect the HDD Activity LED cable to this connector. The IDE LED lights up or flashes when data is read from or written to the HDD.
- **System warning speaker**
This 4-pin connector is for the chassis-mounted system warning speaker. The speaker allows you to hear system beeps and warnings.
- **Power/Soft-off button**
This connector is for the system power button. Pressing the power button turns the system ON or puts the system in SLEEP or SOFT-OFF mode depending on the BIOS settings. Pressing the power switch for more than four seconds while the system is ON turns the system OFF.
- **Reset button**
This 2-pin connector is for the chassis-mounted reset button for system reboot without turning off the system power.

This chapter tells how to change the system settings through the BIOS Setup menus. Detailed descriptions of the BIOS parameters are also provided.

BIOS setup

2.1 Managing and updating your BIOS

The following utilities allow you to manage and update the motherboard Basic Input/Output System (BIOS) setup.

1. **ASUS Update** (Updates the BIOS in Windows® environment.)
2. **ASUS EZ Flash 2** (Updates the BIOS using a floppy disk/ USB flash disk or the motherboard support CD.)
3. **Award BIOS Flash Utility** (Updates the BIOS in DOS mode using a bootable floppy disk.)
4. **ASUS CrashFree BIOS 2** (Updates the BIOS using a bootable floppy disk/ USB flash disk or the motherboard support CD when the BIOS file fails or gets corrupted.)

Refer to the corresponding sections for details on these utilities.



Save a copy of the original motherboard BIOS file to a bootable floppy disk in case you need to restore the BIOS in the future. Copy the original motherboard BIOS using the ASUS Update or AFUDOS utilities.

2.1.1 ASUS Update utility

The ASUS Update is a utility that allows you to manage, save, and update the motherboard BIOS in Windows® environment. The ASUS Update utility allows you to:

- Save the current BIOS file
- Download the latest BIOS file from the Internet
- Update the BIOS from an updated BIOS file
- Update the BIOS directly from the Internet, and
- View the BIOS version information.

This utility is available in the support CD that comes with the motherboard package.



ASUS Update requires an Internet connection either through a network or an Internet Service Provider (ISP).

Installing ASUS Update

To install ASUS Update:

1. Place the support CD in the optical drive. The **Drivers** menu appears.
2. Click the **Utilities** tab, then click **Install ASUS Update VX.XX.XX**. See page 3-4 for the **Utilities** screen menu.
3. The ASUS Update utility is copied to your system.



Quit all Windows® applications before you update the BIOS using this utility.

Updating the BIOS through the Internet

To update the BIOS through the Internet:

1. Launch the ASUS Update utility from the Windows® desktop by clicking **Start > Programs > ASUS > ASUSUpdate > ASUSUpdate**. The ASUS Update main window appears.

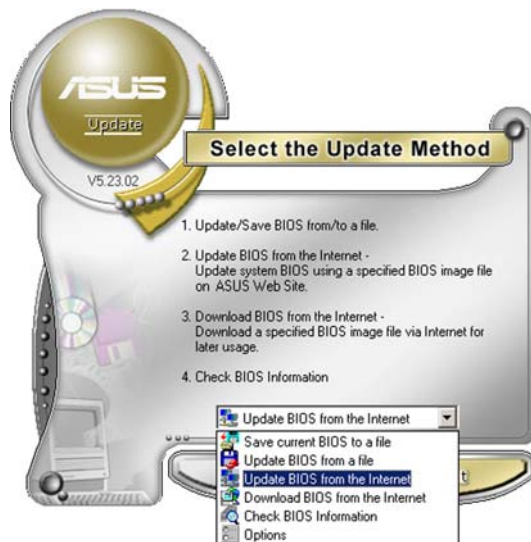
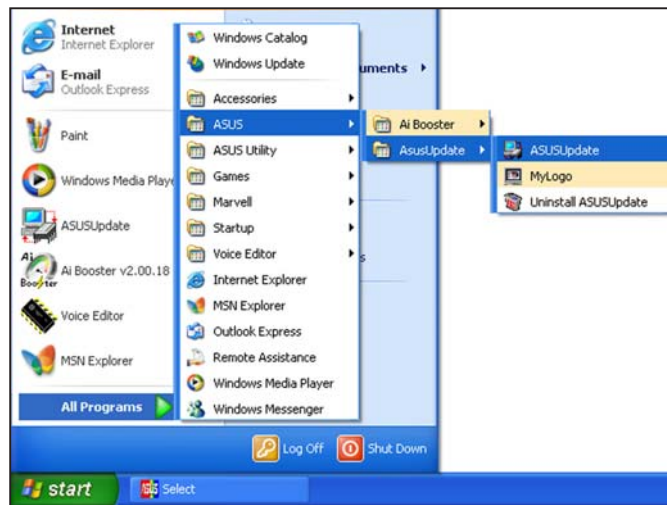

2. Select **Update BIOS from the Internet** option from the drop-down menu, then click **Next**.



3. Select the ASUS FTP site nearest you to avoid network traffic, or click **Auto Select**. Click **Next**.

4. From the FTP site, select the BIOS version that you wish to download. Click Next.
5. Follow the screen instructions to complete the update process.



The ASUS Update utility is capable of updating itself through the Internet. Always update the utility to avail all its features.



Updating the BIOS through a BIOS file

To update the BIOS through a BIOS file:

1. Launch the ASUS Update utility from the Windows® desktop by clicking **Start > Programs > ASUS > ASUSUpdate > ASUSUpdate**. The ASUS Update main window appears.
2. Select **Update BIOS from a file** option from the drop-down menu, then click **Next**.

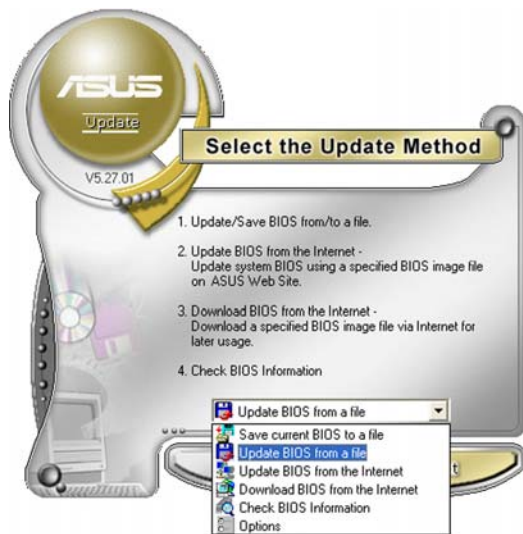

3. Locate the BIOS file from the **Open** window, then click **Open**.
4. Follow the screen instructions to complete the update process.

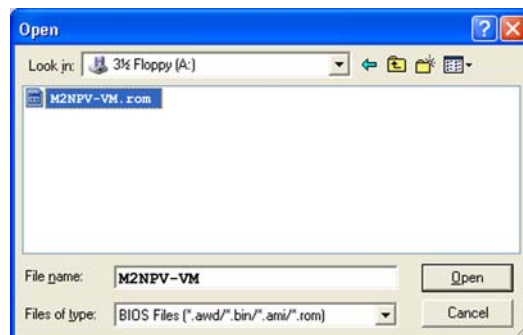

2.1.2 Creating a bootable floppy disk

1. Do either one of the following to create a bootable floppy disk.

DOS environment

- a. Insert a 1.44MB floppy disk into the drive.
- b. At the DOS prompt, type `format a:/s` then press <Enter>.

Windows® XP environment

- a. Insert a 1.44 MB floppy disk to the floppy disk drive.
- b. Click **Start** from the Windows® desktop, then select **My Computer**.
- c. Select the 3 1/2 Floppy Drive icon.
- d. Click **File** from the menu, then select **Format. A Format 3 1/2 Floppy Disk** window appears.
- e. Select **Create an MS-DOS startup disk** from the format options field, then click **Start**.

Windows® 2000 environment

To create a set of boot disks for Windows® 2000:

- a. Insert a formatted, high density 1.44 MB floppy disk into the drive.
 - b. Insert the Windows® 2000 CD to the optical drive.
 - c. Click **Start**, then select **Run**.
 - d. From the Open field, type
`D:\bootdisk\makeboot a:`
assuming that D: is your optical drive.
 - e. Press <Enter>, then follow screen instructions to continue.
2. Copy the original or the latest motherboard BIOS file to the bootable floppy disk.

2.1.3 ASUS EZ Flash 2 utility

The ASUS EZ Flash 2 feature allows you to update the BIOS without having to go through the long process of booting from a floppy disk and using a DOS-based utility. The EZ Flash utility is built-in the BIOS chip so it is accessible by pressing <Alt> + <F2> during the Power-On Self Tests (POST).

To update the BIOS using EZ Flash 2:

1. Visit the ASUS website (www.asus.com) to download the latest BIOS file for the motherboard.
2. Save the BIOS file to a floppy disk, then restart the system.
3. You can launch the EZ Flash 2 by two methods.
 - (1) Insert the floppy disk/USB flash disk that contains the BIOS file to the floppy disk drive or the USB port.

Press <Alt> + <F2> during POST to display the following.

```
ASUSTek EZ Flash 2 BIOS ROM Utility B312
FLASH TYPE: Winbond W39V080A 8Mb LPC

Current ROM          Update ROM
BOARD: M2NPVVM      BOARD: Unknown
VER: 0122           VER: Unknown
DATE: 04/24/2006   DATE: Unknown

PATH: C:\M2NPVOC
A:
C:
WIN98E <DIR>
NETTERM <DIR>
DRIVERS <DIR>
RECYCLED <DIR>
WUTEMP <DIR>
NEWFOL~1 <DIR>
INSTALL <DIR>
TEST-REB <DIR>
MSDOWNLD.TMP <DIR>

Note
[Enter] Select      [S] Save          [ESC]Exit
[Tab]Switch        [Up/Down/Home/End] Move
```

- (2) Enter BIOS setup program. Go to the **Tools** menu to select **EZ Flash 2** and press <Enter> to enable it.

You can switch between drives by pressing <Tab> before the correct file is found. Then press <Enter>.

4. When the correct BIOS file is found, EZ Flash 2 performs the BIOS update process and automatically reboots the system when down.



- This function can support devices such as USB flash disk, hard disk, or floppy disk with **FAT32/16/12** format only.
- Do not shut down or reset the system while updating the BIOS to prevent system boot failure!

2.1.4 Updating the BIOS

The Basic Input/Output System (BIOS) can be updated using the AwardBIOS Flash Utility. Follow these instructions to update the BIOS using this utility.

1. Download the latest BIOS file from the ASUS web site. Rename the file to **M2NPV-VM.BIN** and save it to a floppy disk, CD ROM or a USB flash disk in **FAT 16/12 format**.



Save only the updated BIOS file in the floppy disk to avoid loading the wrong BIOS file.

2. Copy the AwardBIOS Flash Utility (awdfash.exe) from the Software folder of the support CD to the floppy disk, CD ROM or a USB flash disk with the latest BIOS file.
3. Boot the system in DOS mode using the bootable floppy disk, CD ROM or a USB flash disk you created earlier.
4. Under the DOS mode, use <X:> (X stands for the name of the disk assignment) to switch to the folder of the floppy disk, CD ROM or USB flash disk you saved the BIOS file and the Award BIOS Flash Utility.
5. At the prompt, type **awdfash** then press <Enter>. The Award BIOS Flash Utility screen appears.

```
AwardBIOS Flash Utility for ASUS V1.17
(C) Phoenix Technologies Ltd. All Rights Reserved

For C51PV-MCP51-M2NPV-VM-00    DATE: 04/13/2006
Flash Type - PMC Pm49FL004T LPC/FWH

File Name to Program: 

Message: Please input File Name!
```

6. Type the BIOS file name in the **File Name to Program** field, then press <Enter>.

```
AwardBIOS Flash Utility for ASUS V1.17
(C) Phoenix Technologies Ltd. All Rights Reserved

For C51PV-MCP51-M2NPV-VM-00    DATE: 04/13/2006
Flash Type - PMC Pm49FL004T LPC/FWH

File Name to Program: 0107.bin

Message: Do You Want To Save Bios (Y/N)
```

- Press <N> when the utility prompts you to save the current BIOS file. The following screen appears.
- The utility verifies the BIOS file in the floppy disk, CD ROM or a USB flash disk and starts flashing the BIOS file.

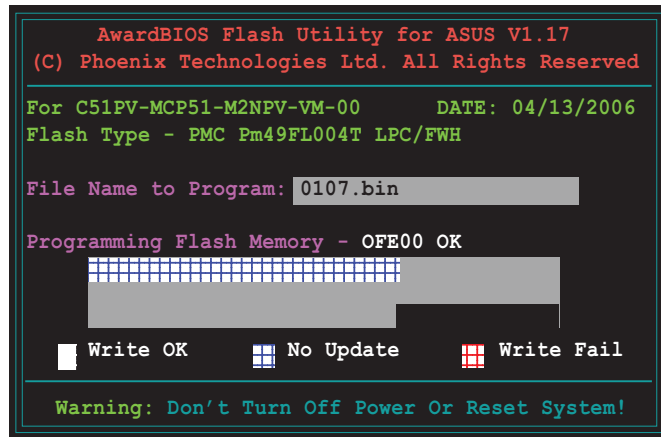

```
AwardBIOS Flash Utility for ASUS V1.17
(C) Phoenix Technologies Ltd. All Rights Reserved

For C51PV-MCP51-M2NPV-VM-00    DATE: 04/13/2006
Flash Type - PMC Pm49FL004T LPC/FWH

File Name to Program: 0107.bin

Programming Flash Memory - OFE00 OK
[Progress bar]

[ ] Write OK    [ ] No Update    [ ] Write Fail

Warning: Don't Turn Off Power Or Reset System!
```



Do not turn off or reset the system during the flashing process!

- The utility displays a **Flashing Complete** message indicating that you have successfully flashed the BIOS file. Remove the floppy disk then press <F1> to restart the system.

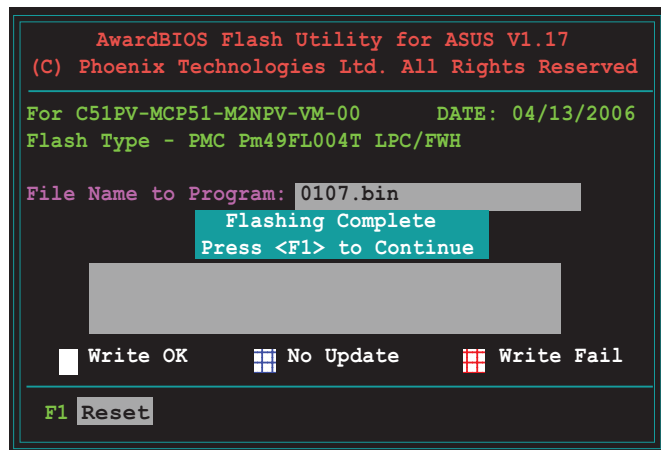

```
AwardBIOS Flash Utility for ASUS V1.17
(C) Phoenix Technologies Ltd. All Rights Reserved

For C51PV-MCP51-M2NPV-VM-00    DATE: 04/13/2006
Flash Type - PMC Pm49FL004T LPC/FWH

File Name to Program: 0107.bin
Flashing Complete
Press <F1> to Continue

[Progress bar]

[ ] Write OK    [ ] No Update    [ ] Write Fail

F1 Reset
```

2.1.5 Saving the current BIOS file

You can use the AwardBIOS Flash Utility to save the current BIOS file. You can load the current BIOS file when the BIOS file gets corrupted during the flashing process.



Make sure that the floppy disk, CD ROM or a USB flash disk has enough disk space to save the file.

To save the current BIOS file using the AwardBIOS Flash Utility:

1. Follow steps 1 to 6 of the previous section.
2. Press <Y> when the utility prompts you to save the current BIOS file. The following screen appears.

```
AwardBIOS Flash Utility for ASUS V1.17
(C) Phoenix Technologies Ltd. All Rights Reserved

For C51PV-MCP51-M2NPV-VM-00      DATE: 04/13/2006
Flash Type - PMC Pm49FL004T LPC/FWH

File Name to Program: 0107.bin
Save current BIOS as:

Message: Please wait...
```

3. Type a filename for the current BIOS file in the Save current BIOS as field, then press <Enter>.

```
AwardBIOS Flash Utility for ASUS V1.17
(C) Phoenix Technologies Ltd. All Rights Reserved

For C51PV-MCP51-M2NPV-VM-00      DATE: 04/13/2006
Flash Type - PMC Pm49FL004T LPC/FWH

File Name to Program: 0107.bin
Checksum: 810DH
Save current BIOS as:

Message: Please wait...
```

4. The utility saves the current BIOS file to the floppy disk, then returns to the BIOS flashing process.

```
AwardBIOS Flash Utility for ASUS V1.17
(C) Phoenix Technologies Ltd. All Rights Reserved

For C51PV-MCP51-M2NPV-VM-00      DATE: 04/13/2006
Flash Type - PMC Pm49FL004T LPC/FWH

File Name to Program: 0107 .bin
Now Backup Syetem BIOS to
File!

Message: Please wait...
```

2.1.6 ASUS CrashFree BIOS 2 utility

The ASUS CrashFree BIOS 2 is an auto recovery tool that allows you to restore the BIOS file when it fails or gets corrupted during the updating process. You can update a corrupted BIOS file using the motherboard support CD or the floppy disk that contains the updated BIOS file.



- Prepare the motherboard support CD or the floppy disk containing the updated motherboard BIOS before using this utility.
- Make sure that you rename the original or updated BIOS file in the floppy disk to **M2NPV-VM.ROM**.

Recovering the BIOS from the support CD

To recover the BIOS from the support CD:

1. Turn on the system.
2. Insert the motherboard support CD to the optical drive.
3. The utility displays the following message and automatically checks the CD for the BIOS file.

```
Award BootBlock BIOS v1.0
Copyright (C) 2000, Award Software, Inc.

BIOS ROM checksum error,
Detecting IDE ATAPI device...
```

When found, the utility reads the BIOS file and starts flashing the corrupted BIOS file.

```
Award BootBlock BIOS v1.0
Copyright (C) 2000, Award Software, Inc.

BIOS ROM checksum error,
Detecting IDE ATAPI device...
Found CDROM, try to Boot from it...Pass
```



- DO NOT shut down or reset the system while updating the BIOS! Doing so can cause system boot failure!

4. Restart the system after the utility completes the updating process.

2.2 BIOS setup program

This motherboard supports a programmable Low-Pin Count (LPC) chip that you can update using the provided utility described in section “2.1 Managing and updating your BIOS.”

Use the BIOS Setup program when you are installing a motherboard, reconfiguring your system, or prompted to “Run Setup.” This section explains how to configure your system using this utility.

Even if you are not prompted to use the Setup program, you can change the configuration of your computer in the future. For example, you can enable the security password feature or change the power management settings. This requires you to reconfigure your system using the BIOS Setup program so that the computer can recognize these changes and record them in the CMOS RAM of the LPC chip.

The LPC chip on the motherboard stores the Setup utility. When you start up the computer, the system provides you with the opportunity to run this program. Press during the Power-On Self-Test (POST) to enter the Setup utility; otherwise, POST continues with its test routines.

If you wish to enter Setup after POST, restart the system by pressing <Ctrl+Alt+Delete>, or by pressing the reset button on the system chassis. You can also restart by turning the system off and then back on. Do this last option only if the first two failed.

The Setup program is designed to make it as easy to use as possible. Being a menu-driven program, it lets you scroll through the various sub-menus and make your selections from the available options using the navigation keys.



-
- The default BIOS settings for this motherboard apply for most conditions to ensure optimum performance. If the system becomes unstable after changing any BIOS settings, load the default settings to ensure system compatibility and stability. Select the **Load Default Settings** item under the Exit Menu. See section “2.8 Exit Menu.”
 - The BIOS setup screens shown in this section are for reference purposes only, and may not exactly match what you see on your screen.
 - Visit the ASUS website (www.asus.com) to download the latest BIOS file for this motherboard and .
-

2.2.1 BIOS menu screen

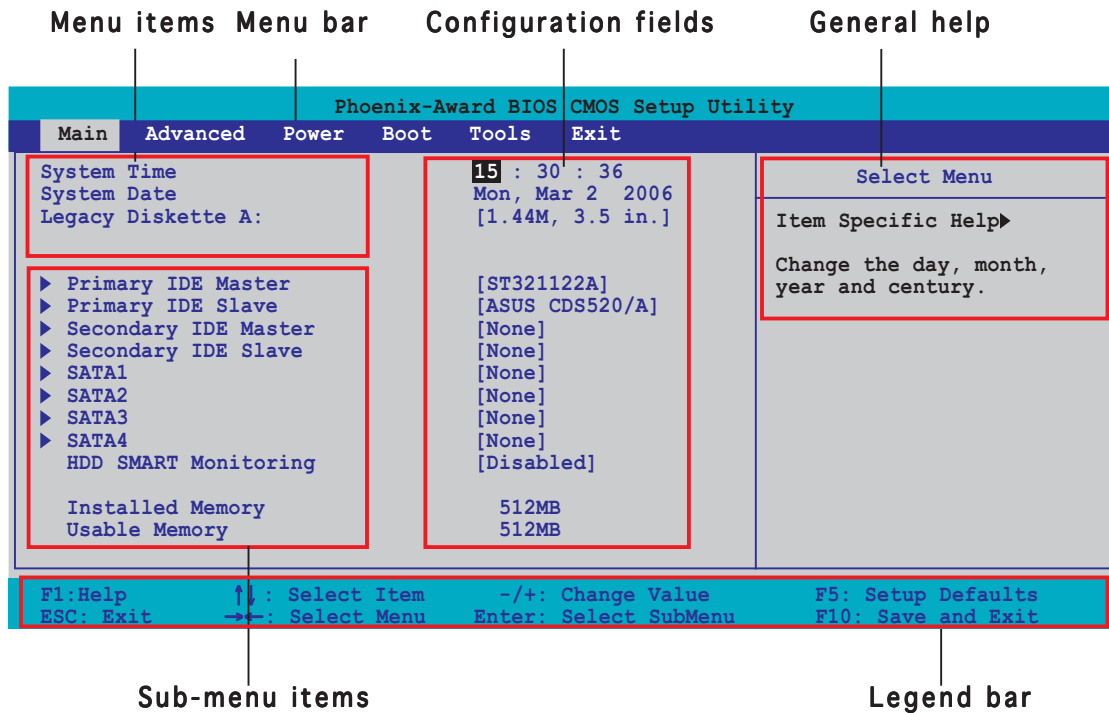

2.2.2 Menu bar

The menu bar on top of the screen has the following main items:

Main	For changing the basic system configuration
Advanced	For changing the advanced system settings
Power	For changing the advanced power management (APM) configuration
Boot	For changing the system boot configuration
Tools	For changing the system tools configuration
Exit	For selecting the exit options and loading default settings

To select an item on the menu bar, press the right or left arrow key on the keyboard until the desired item is highlighted.



- The BIOS setup screens shown in this chapter are for reference purposes only, and may not exactly match what you see on your screen.
- Visit the ASUS website (www.asus.com) to download the latest BIOS information.

2.2.3 Legend bar

At the bottom of the Setup screen is a legend bar. The keys in the legend bar allow you to navigate through the various setup menus. The following table lists the keys found in the legend bar with their corresponding functions.

Navigation Key	Function
<F1>	Displays the General Help screen
<F5>	Loads setup default values
<Esc>	Exits the BIOS setup or returns to the main menu from a sub-menu
Left or Right arrow	Selects the menu item to the left or right
Up or Down arrow	Moves the highlight up or down between fields
Page Down or - (minus)	Scrolls backward through the values for the highlighted field
Page Up or + (plus)	Scrolls forward through the values for the highlighted field
<Enter>	Brings up a selection menu for the highlighted field
<F10>	Saves changes and exit

2.2.4 Menu items

The highlighted item on the menu bar displays the specific items for that menu. For example, selecting **Main** shows the Main menu items.

The other items (Advanced, Power, Boot, and Exit) on the menu bar have their respective menu items.

2.2.5 Sub-menu items

A solid triangle before each item on any menu screen means that the item has a sub-menu. To display the sub-menu, select the item and press <Enter>.

2.2.6 Configuration fields

These fields show the values for the menu items. If an item is user-configurable, you can change the value of the field opposite the item. You cannot select an item that is not user-configurable.

A configurable field is enclosed in brackets, and is highlighted when selected. To change the value of a field, select it then press <Enter> to display a list of options. Refer to “2.2.7 Pop-up window.”

2.2.7 Pop-up window

Select a menu item then press <Enter> to display a pop-up window with the configuration options for that item.

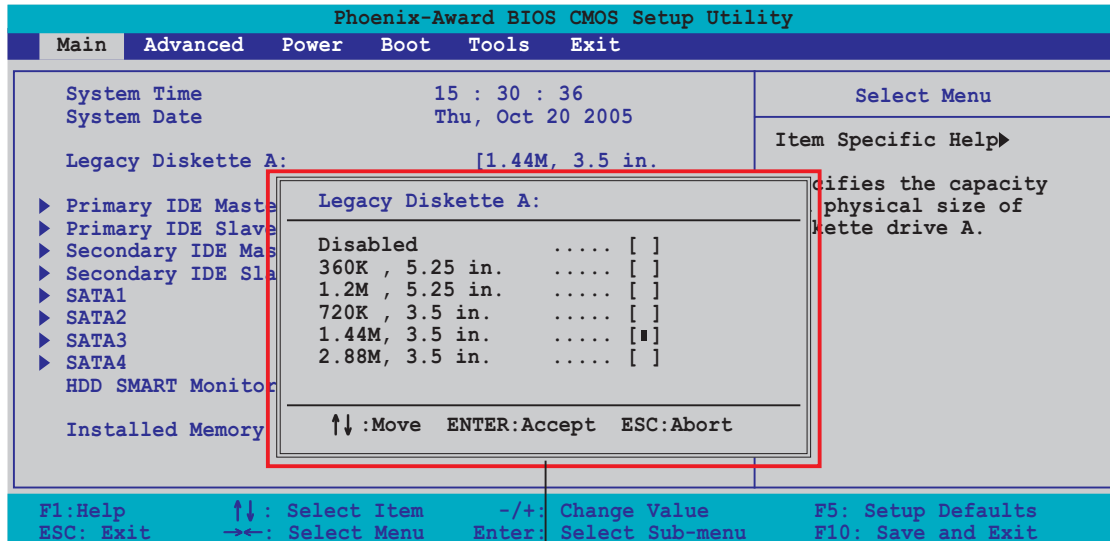

Pop-up menu

2.2.8 General help

At the top right corner of the menu screen is a brief description of the selected item.

2.3 Main menu

When you enter the BIOS Setup program, the Main menu screen appears, giving you an overview of the basic system information.



Refer to section “2.2.1 BIOS menu screen” for information on the menu screen items and how to navigate through them.

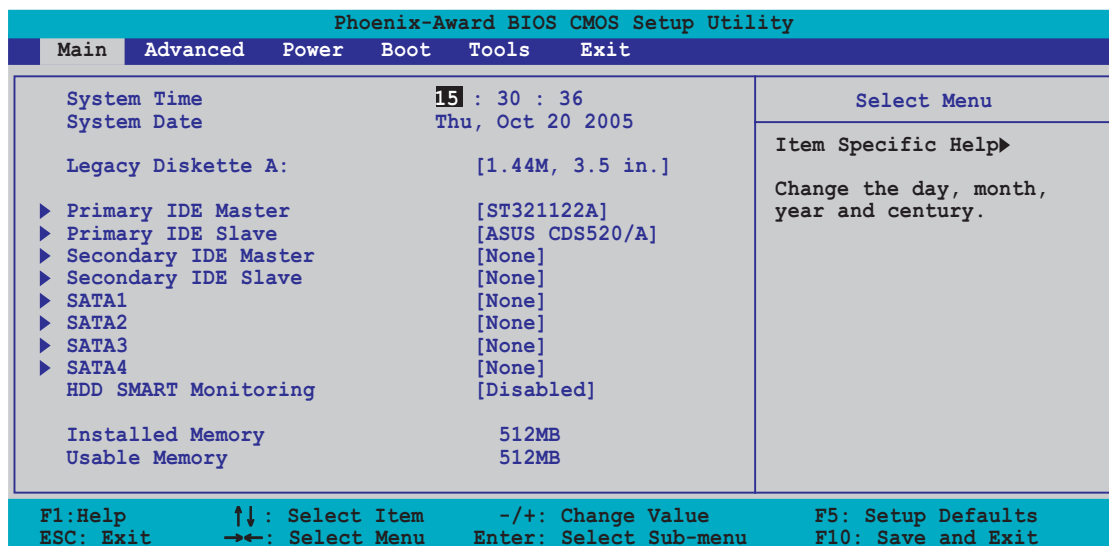

2.3.1 System Time [xx:xx:xx]

Allows you to set the system time.

2.3.2 System Date [Day xx/xx/xxxx]

Allows you to set the system date.

2.3.3 Legacy Diskette A [1.44M, 3.5 in.]

Sets the type of floppy drive installed. Configuration options: [Disabled] [360K, 5.25 in.] [1.2M, 5.25 in.] [720K, 3.5 in.] [1.44M, 3.5 in.]

2.3.4 Primary and Secondary IDE Master/Slave

While entering Setup, the BIOS automatically detects the presence of IDE devices. There is a separate sub-menu for each IDE device. Select a device item then press <Enter> to display the IDE device information.

Phoenix-Award BIOS CMOS Setup Utility	
Main	
Primary IDE Master	Select Menu
Primary IDE Master [Auto]	Item Specific Help▶▶
Access Mode [Auto]	Press [Enter] to select
Capacity 82 GB	
Cylinder 39420	
Head 16	
Sector 255	
PIO Mode [Auto]	
UDMA Mode [Auto]	
Transfer Mode UDMA 6	

F1: Help ↑↓: Select Item -/+ : Change Value F5: Setup Defaults
ESC: Exit →←: Select Menu Enter: Select Sub-menu F10: Save and Exit

The BIOS automatically detects the values opposite the dimmed items (Capacity, Cylinder, Head, Sector and Transfer Mode). These values are not user-configurable. These items show N/A if no IDE device is installed in the system.

Primary IDE Master/Slave [Auto] Secondary IDE Master/Slave [Auto]

Select [Auto] to automatically detect an IDE hard disk drive. If automatic detection is successful, the BIOS automatically fills in the correct values for the remaining fields on this sub-menu. If the hard disk was already formatted on a previous system, the setup BIOS may detect incorrect parameters. Select [Manual] to manually enter the IDE hard disk drive parameters. If no drive is installed select [None].

Configuration options: [None] [Auto] [Manual]

Access Mode [Auto]

The default [Auto] allows automatic detection of an IDE hard disk drive. Select [CHS] for this item if you set the IDE Primary Master/Slave to [Manual]. Configuration options: [CHS] [LBA] [Large] [Auto]



Before attempting to configure a hard disk drive, make sure you have the correct configuration information supplied by the drive manufacturer. Incorrect settings may cause the system to fail to recognize the installed hard disk.

Capacity

Displays the auto-detected hard disk capacity. This item is not configurable.

Cylinder

Shows the number of the hard disk cylinders. This item is not configurable.

Head

Shows the number of the hard disk read/write heads. This item is not configurable.

Sector

Shows the number of sectors per track. This item is not configurable.

PIO Mode [Auto]

Sets the PIO mode for the IDE device.

Configuration options: [Auto] [Mode 0] [Mode 1] [Mode 2] [Mode 3] [Mode 4]

UDMA Mode [Auto]

Disables or sets the UDMA mode. Configuration options: [Disabled] [Auto]

Transfer Mode

Shows the Transfer mode. This item is not configurable.



After entering the IDE hard disk drive information into BIOS, use a disk utility, such as FDISK, to partition and format new IDE hard disk drives. This is necessary so that you can write or read data from the hard disk. Make sure to set the partition of the Primary IDE hard disk drives to active.

2.3.5 First, Second, Third, Fourth SATA Master

While entering Setup, the BIOS automatically detects the presence of Serial ATA devices. There is a separate sub-menu for each SATA device. Select a device item then press <Enter> to display the SATA device information.

Phoenix-Award BIOS CMOS Setup Utility	
Main	
Primary SATA Master	Select Menu
Extended IDE Drive [Auto]	Item Specific Help▶▶
Access Mode [Auto]	Selects the type of fixed disk connected to the system.
Capacity 0 MB	
Cylinder 0	
Head 0	
Landing Zone 0	
Sector 0	

F1: Help ↑↓: Select Item -/+ : Change Value F5: Setup Defaults
ESC: Exit →←: Select Menu Enter: Select Sub-menu F10: Save and Exit

The BIOS automatically detects the values opposite the dimmed items (Capacity, Cylinder, Head, Precomp, Landing Zone and Sector). These values are not user-configurable. These items show 0 if no SATA device is installed in the system.

Extended Drive [Auto]

Selects the type of fixed disk connected to the system.

Configuration options: [None] [Auto]

Access Mode [Auto]

Sets the sector addressing mode. Configuration options: [Large] [Auto]



Before attempting to configure a hard disk drive, make sure you have the correct configuration information supplied by the drive manufacturer. Incorrect settings may cause the system to fail to recognize the installed hard disk.

Capacity

Displays the auto-detected hard disk capacity. This item is not configurable.

Cylinder

Shows the number of the hard disk cylinders. This item is not configurable.

Head

Shows the number of the hard disk read/write heads. This item is not configurable.

Landing Zone

Shows the number of landing zone per track. This item is not configurable.

Sector

Shows the number of sectors per track. This item is not configurable.



After entering the IDE hard disk drive information into BIOS, use a disk utility, such as FDISK, to partition and format new IDE hard disk drives. This is necessary so that you can write or read data from the hard disk. Make sure to set the partition of the Primary IDE hard disk drives to active.

2.3.6 HDD SMART Monitoring [Disabled]

Allows you to enable or disable the HDD Self-Monitoring Analysis and Reporting Technology (SMART) feature.

Configuration options: [Disabled] [Enabled]

2.3.7 Installed Memory [xxx MB]

Shows the size of installed memory.

2.3.8 Usable Memory [XXX MB]

Shows the size of usable memory.

2.4 Advanced menu

The Advanced menu items allow you to change the settings for the CPU and other system devices.



Take caution when changing the settings of the Advanced menu items. Incorrect field values can cause the system to malfunction.

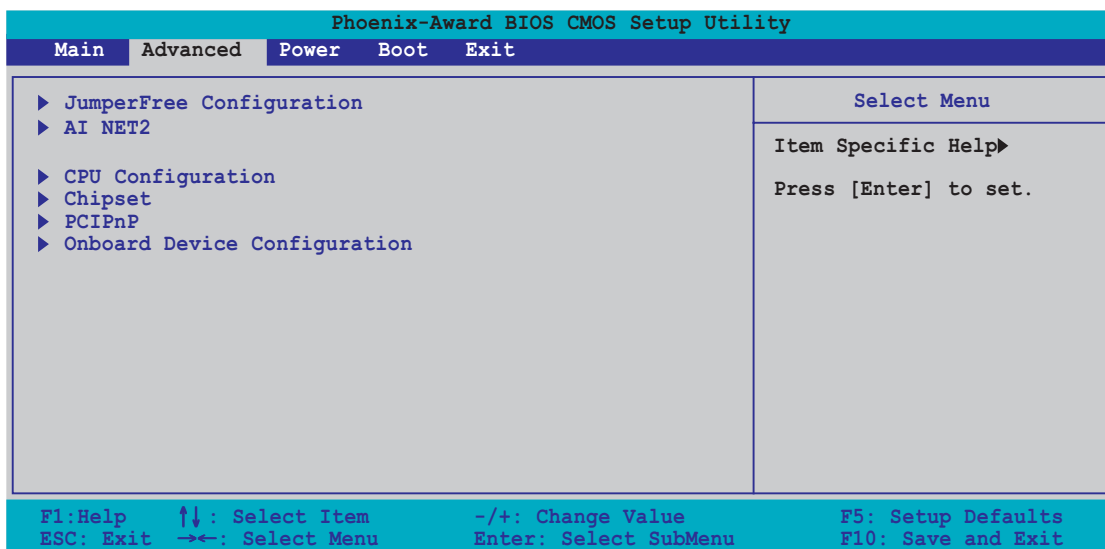

2.4.1 JumperFree Configuration

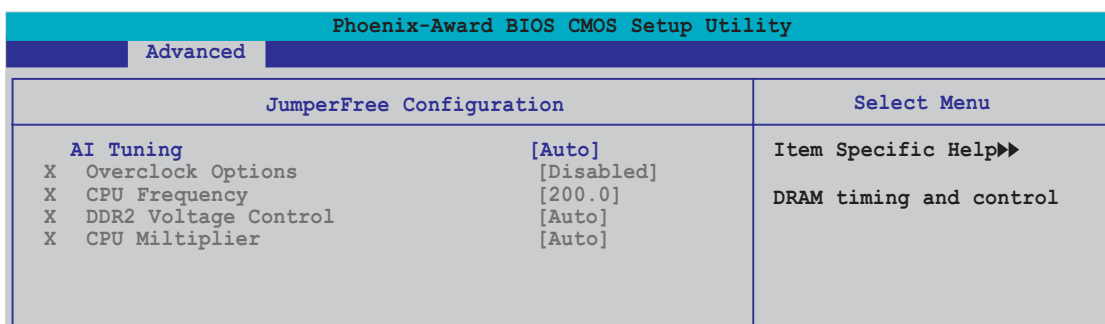

AI Tuning [Auto]

Allows selection of CPU overclocking options to achieve desired CPU internal frequency. Select either one of the preset overclocking configuration options:

Manual Allows you to individually set overclocking parameters.

Auto Loads the optimal settings for the system.

Standard Loads the standard settings for the system.

AI Overclock Loads overclocking profiles with optimal parameters for stability when overclocking.



The following item becomes user-configurable when you set **AI Tuning** to [AI Overclocking].

Overclock Options [Disabled]

Allows you to set the overclocking options.

Configuration options: [Disabled] [Overclock 3%] [Overclock 5%]
[Overclock 8%] [Overclock 10%]



The following items become user-configurable when you set **AI Tuning** to [Manual].

CPU Frequency [XXX] (value is auto-detected)

Indicates the frequency sent by the clock generator to the system bus and PCI bus. The bus frequency (external frequency) multiplied by the bus multiple equals the CPU speed. The BIOS auto-detects the value of this item. The values range from 200.0 to 400.0.



Setting a very high CPU frequency may cause the system to become unstable. If this happens, revert to the default setting.

DDR2 Voltage Control [Auto]

Allows you to set the operating DDR2 voltage.

Configuration options: [Auto] [1.9V]

CPU Multiplier [Auto]

Allows you to set the operating CPU multiplier. The configuration options may vary depending on the type of CPU installed. Configuration options: [Auto] [5x] [5.5x] [6x] ~ [12x]

2.4.2 AI Net2

Phoenix-Award BIOS CMOS Setup Utility			
Advanced			
AI NET2			Select Menu
POST Check LAN Cable [Disabled]			Item Specific Help▶▶▶
Pair	Status	Length	DRAM timing and control
LAN1 (1-2)	Open	N/A	
LAN1 (3-6)	Open	N/A	
LAN1 (4-5)	Open	N/A	
LAN1 (7-8)	Open	N/A	

POST Check LAN Cable [Disabled]

Enables or disables checking of the LAN/LAN2 cable during the Power-On Self-Test (POST). Configuration options: [Disabled] [Enabled]

2.4.3 CPU Configuration

Phoenix-Award BIOS CMOS Setup Utility			
Advanced			
CPU Configuration			Select Menu
CPU Type AMD Engineering Sample			Item Specific Help▶▶▶
CPU Speed	2600MHz		DRAM timing and control
Cache RAM	1024K		
▶ DRAM Configuration			
AMD Cool'n'Quiet Function	[Auto]		

DRAM Configuration

The items in the sub-menu show the DRAM-related information auto-detected by the BIOS.

Phoenix-Award BIOS CMOS Setup Utility			
Advanced			
DRAM Configuration			Select Menu
Memory Clock Frequency	[Auto]		Item Specific Help▶▶▶
Tcl	[Auto]		Auto, no user limit
Trocd	[Auto]		MaxMemclk, limit by
Trp	[Auto]		Memory Clock value
Tras	[Auto]		Manual, use Memory
Trc	[Auto]		Clock value
Trwt	[Auto]		
1T/2T Memory Timing	[Auto]		
Memory Hole Remapping	[Enabled]		
Bottom of 32-bit[31:24] IO space	[E0]		
Bottom of UMA DRAM [31:24]	[FC]		

Memory Clock Frequency [Auto]

Sets the memory clock frequency.

Configuration options: [Auto] [DDR2 400] [DDR2 533] [DDR2 667]
[DDR2 800]

Tcl [Auto]

Configuration options: [Auto][3] [4] [5] [6]

Trcd [Auto]

Configuration options: [Auto] [3] [4] [5] [6]

Trp [Auto]

Configuration options: [Auto] [3] [4] [5] [6]

Tras [Auto]

Configuration options: [Auto] [5] [6] [7] ~ [18]

Trc [Auto]

Configuration options: [Auto] [11] [12] [13] ~ [26]

Trwt [Auto]

Configuration options: [Auto] [2] [3] [4] ~ [9]

1T/2T Memory Timing [Auto]

Configuration options: [Auto] [1T] [2T]

Memory Hole Remapping [Enabled]

Configuration options: [Disabled] [Enabled]

Bottom of 32/bit[31:24] IO space [E0]

Min=0000, Max=00E0

Bottom of UMA DRAM [31:24] [FC]

Min=0000, Max=00FC

AMD Cool 'n' Quiet Function [Disabled]

Enables or disables the AMD Cool 'n' Quiet technology.

Configuration options: [Auto] [Disabled]

2.4.4 Chipset

Phoenix-Award BIOS CMOS Setup Utility		
Advanced		
Chipset		Select Menu
Frame Buffer Size	32M	Item Specific Help▶▶
ECC	[Auto]	
Spread Spectrum	[Down]	Select Frame Buffer Size for Onboard Graphic
PCIe Spread Spectrum	[Enabled]	
SATA Spread Spectrum	[Enabled]	
HT Spread Spectrum	[Down]	
RGB/TV Display	[Auto]	
TV Mode Support	[Disabled]	

Frame Buffer Size [32M]

Selects the frame buffer size for Onboard Graphic.

Configuration options: [16M] [32M] [64M] [128M] [Disabled]

ECC [Auto]

Configuration options: [Auto] [Disabled]

Spread Spectrum [Down]

Enables or disables Spread Spectrum for CPU.

Configuration options: [Disabled] [Center] [Down]

PCIe Spread Spectrum [Enabled]

Enables or disables Spread Spectrum for PCI Express.

Configuration options: [Disabled] [Enabled]

SATA Spread Spectrum [Enabled]

Enables or disables Spread Spectrum for SATA.

Configuration options: [Disabled] [Enabled]

HT Spread Spectrum [Down]

Enables or disables Spread Spectrum for Hyper Transport.

Configuration options: [Disabled] [Center] [Down]

RGB/TV Display [Auto]

Selects the display mode.

Configuration options: [Auto] [RGB] [TV]



RGB and TV can not be used simultaneously.

TV Mode Support [Disabled]

Configuration options: [NTSC-M] [NTSC-J] [PAL-M] [PAL-BDGH] [PAL-N] [PAL-NC] [Disabled]

2.4.5 PCIPnP

Phoenix-Award BIOS CMOS Setup Utility		
Advanced		
PCIPnP		Select Menu
Plug & Play O/S	No	Item Specific Help▶▶
Primary Display Adapter	[PCI-E]	Select Yes if you are using a Plug and Play capable operating system
Resources Controlled By	[Auto]	Select No if you need the BIOS to configure non-boot devices
x IRQ Resources		
** PCI Express relative itmes **		
Maximum Payload Size	[4096]	

Plug & Play O/S [No]

When set to [No], the BIOS configures all the devices in the system. When set to [Yes] and if you install a Plug and Play operating system, the operating system configures the Plug and Play devices not required for boot. Configuration options: [No] [Yes]

Primary Display Adapter [PCI-E]

Sets which graphics controller to use as primary boot device. Configuration options: [PCI] [Onboard] [PCI-E]

Resources Controlled By [Auto]

When set to [Auto], the BIOS automatically configures all the boot and Plug and Play compatible devices. Set to [Manual] if you want to assign the IRQ DMA and memory base address fields.

Configuration options: [Auto] [Manual]



When the item Resources Controlled By is set to [Auto], the item IRQ Resources is grayed out and not user-configurable. Refer to the section "IRQ Resources" for information on how to enable this item.

IRQ Resources

This sub-menu is activated only when the **Resources Controlled By** item is set to Manual.

Phoenix-Award BIOS CMOS Setup Utility		
Advanced		
IRQ Resources		Select Menu
IRQ-5 assigned to	PCI Device	Item Specific Help▶▶▶
IRQ-7 assigned to	[PCI Device]	Legacy ISA for devices compliant with the original PC AT bus specification, PCI/ISA
IRQ-9 assigned to	[PCI Device]	PnP for devices compliant with the
IRQ-10 assigned to	[PCI Device]	
IRQ-11 assigned to	[PCI Device]	
IRQ-14 assigned to	[PCI Device]	
IRQ-15 assigned to	[PCI Device]	

IRQ-xx assigned to

When set to [PCI Device], the specific IRQ is free for use of PCI/PnP devices. When set to [Reserved], the IRQ is reserved for legacy ISA devices. Configuration options: [PCI Device] [Reserved]

Maximum Payload Size [4096]

Sets maximum TLP payload size for the PCI Express devices. The unit is byte. Configuration options: [128] [256] [512] [1024] [2048] [4096]

2.4.6 Onboard Devices Configuration

The screenshot shows the 'Phoenix-Award BIOS CMOS Setup Utility' with the 'Advanced' tab selected. The 'Onboard Device Configuration' menu is open, listing various hardware settings. The 'Select Menu' column on the right indicates that 'Item Specific Help' is available for the selected item and that the user should 'Press [Enter] to set'. The bottom of the screen displays keyboard shortcuts: F1: Help, ESC: Exit, ↑↓: Select Item, →←: Select Menu, -/+ : Change Value, Enter: Select Sub-menu, F5: Setup Defaults, and F10: Save and Exit.

Onboard Device Configuration		Select Menu
▶ IDE Function Setup		Item Specific Help▶▶
▶ NVRAID Configuration		
▶ USB Configuration		Press [Enter] to set
Onboard NV LAN	[Enabled]	
Onboard LAN Boot ROM	[Disabled]	
Onboard IEEE 1394	[Enabled]	
HD Audio	[Enabled]	
Serial Port1 Address	[3F8/IRQ4]	
Serial Port2 Address	[2F8/IRQ3]	
Parallel Port Address	[378/IRQ7]	
Parallel Port Mode	[Normal]	
x ECP Mode Use DMA	3	
Game Port Address	[201]	
Midi Port Address	[330]	
Midi Port IRQ	[10]	

IDE Function Setup

This sub-menu contains IDE function-related items. Select an item then press <Enter> to edit.

The screenshot shows the 'Phoenix-Award BIOS CMOS Setup Utility' with the 'Advanced' tab selected. The 'IDE Function Setup' menu is open, listing IDE-related settings. The 'Select Menu' column on the right indicates that 'Item Specific Help' is available and that the user can 'Disable/Enable OnChip IDE Channel0'. The bottom of the screen displays keyboard shortcuts: F1: Help, ESC: Exit, ↑↓: Select Item, →←: Select Menu, -/+ : Change Value, Enter: Select Sub-menu, F5: Setup Defaults, and F10: Save and Exit.

IDE Function Setup		Select Menu
OnChip IDE Channel0	[Enabled]	Item Specific Help▶▶
OnChip IDE Channel1	[Enabled]	
IDE DMA transfer access	[Enabled]	Disable/Enable OnChip IDE Channel0
SATA Port 1, 2	[Enabled]	
SATA DMA transfer	[Enabled]	
SATA Port 3, 4	[Enabled]	
SATA2 DMA transfer	[Enabled]	
IDE Prefetch Mode	[Enabled]	

OnChip IDE Channel0 [Enabled]

Allows you to enable or disable the onchip IDE channel 0 controller .
Configuration options: [Disabled] [Enabled]

OnChip IDE Channel1 [Enabled]

Allows you to enable or disable the onchip IDE channel 1 controller .
Configuration options: [Disabled] [Enabled]

IDE DMA transfer access [Enabled]

Allows you to enable or disable the IDE DMA transfer access.
Configuration options: [Disabled] [Enabled]

SATA Port 1, 2 [Enabled]

Allows you to enable or disable the SATA 1 and 2 ports.
Configuration options: [Enabled] [Disabled]

SATA DMA transfer [Enabled]

Allows you to enable or disable the SATA DMA transfer access.
Configuration options: [Enabled] [Disabled]

SATA Port 3, 4 [Enabled]

Allows you to enable or disable the SATA 3 and 4 ports.
Configuration options: [Enabled] [Disabled]

SATA2 DMA transfer [Enabled]

Allows you to enable or disable the SATA2 DMA transfer access.
Configuration options: [Enabled] [Disabled]

IDE Prefetch Mode [Enabled]

Allows you to enable or disable the IDE PIO read prefetch mode.
Configuration options: [Disabled] [Enabled]

NVRAID Configuration

This sub-menu contains NVRAID function-related items. Select an item then press <Enter> to edit.

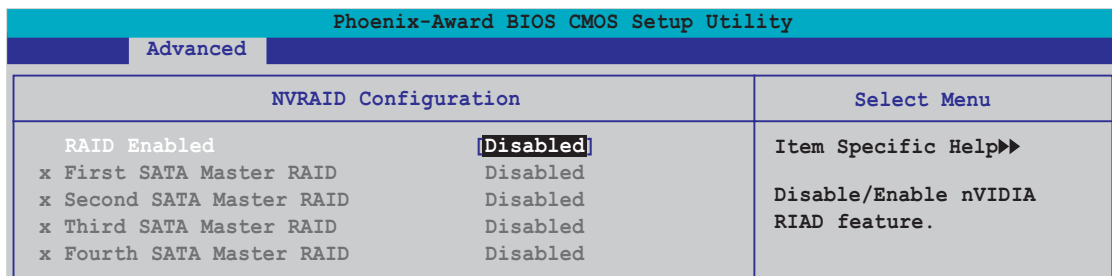

The screenshot shows the Phoenix-Award BIOS CMOS Setup Utility interface. The 'Advanced' menu is selected. The 'NVRAID Configuration' sub-menu is displayed, showing the following options:

NVRAID Configuration		Select Menu
RAID Enabled	Disabled	Item Specific Help▶▶
x First SATA Master RAID	Disabled	Disable/Enable nVIDIA
x Second SATA Master RAID	Disabled	RIAD feature.
x Third SATA Master RAID	Disabled	
x Fourth SATA Master RAID	Disabled	

RAID Enabled [Disabled]

Enables or disables the onboard RAID controller. When set to [Enabled], the succeeding items become user-configurable.
Configuration options: [Disabled] [Enabled]

First, Second, Third, Fourth SATA Master RAID [Disabled]

Enables or disables the RAID function of the first, second, third or fourth SATA master drive. Configuration options: [Disabled] [Enabled]

USB Configuration

The items in this menu allows you to change the USB-related features. Select an item then press <Enter> to display the configuration options.

Phoenix-Award BIOS CMOS Setup Utility	
Advanced	
USB Configuration	Select Menu
USB Controller [Enabled]	Item Specific Help▶▶
USB2.0 Controller [Enabled]	Enable or Disable USB 1.1 and 2.0 Controller
USB Legacy support [Enabled]	

USB Controller [Enabled]

Allows you to enable or disable the onchip USB controller. Configuration options: [Disabled] [Enabled]

USB 2.0 Controller [Enabled]

Allows you to enable or disable the USB 2.0 controller. Configuration options: [Disabled] [Enabled]

USB Legacy Support [Enabled]

Allows you to enable or disable support for USB devices on legacy operating systems (OS). Configuration options: [Disabled] [Enabled]

Onboard NV LAN [Enabled]

Enables or disables the onboard NVIDIA® LAN controller. Configuration options: [Disabled] [Enabled]

OnBoard LAN Boot ROM [Disabled]

Allows you to enable or disable the onboard LAN boot ROM. Configuration options: [Enabled] [Disabled]

Onboard IEEE 1394 [Enabled]

Allows you to disable or enable the onboard 1394 device support. Configuration options: [Disabled] [Enabled]

HD Audio [Enabled]

Allows you to disable or enable the High-Definition audio function. Configuration options: [Disabled] [Enabled]

Serial Port1 Address [3F8/IRQ4]

Allows you to select the Serial Port1 base address.

Configuration options: [Disabled] [3F8/IRQ4] [2F8/IRQ3] [3E8/IRQ4] [2E8/IRQ3] [Auto]

Serial Port2 Address [2F8/IRQ3]

Allows you to select the Serial Port2 base address.

Configuration options: [Disabled] [3F8/IRQ4] [2F8/IRQ3] [3E8/IRQ4] [2E8/IRQ3] [Auto]

Parallel Port Address [378/IRQ7]

Allows you to select the Parallel Port address.

Configuration options: [Disabled] [378/IRQ7] [278/IRQ5] [3BC/IRQ7]

Parallel Port Mode [EPP]

Allows you to select the Parallel Port mode.

Configuration options: [Normal] [EPP] [ECP] [Bi-Directional]



The “ECP Mode Use DMA” item becomes user-configurable when the “Parallel Port Mode” item is set to [ECP] or [Bi-Directional]

ECP Mode Use DMA [3]

Allows selection of ECP Mode. Configuration options: [1] [3]

Game Port Address [201]

Allows you to select the Game Port address or to disable the port.

Configuration options: [Disabled] [201] [209]

Midi Port Address [201]

Allows you to select the Midi Port address or to disable the port.

Configuration options: [Disabled] [330] [300]

Midi Port IRQ [10]

Allows you to select the Midi Port IRQ.

Configuration options: [5] [10]

2.5 Power menu

The Power menu items allow you to change the settings for the Advanced Configuration and Power Interface (ACPI) and the Advanced Power Management (APM). Select an item then press <Enter> to display the configuration options.

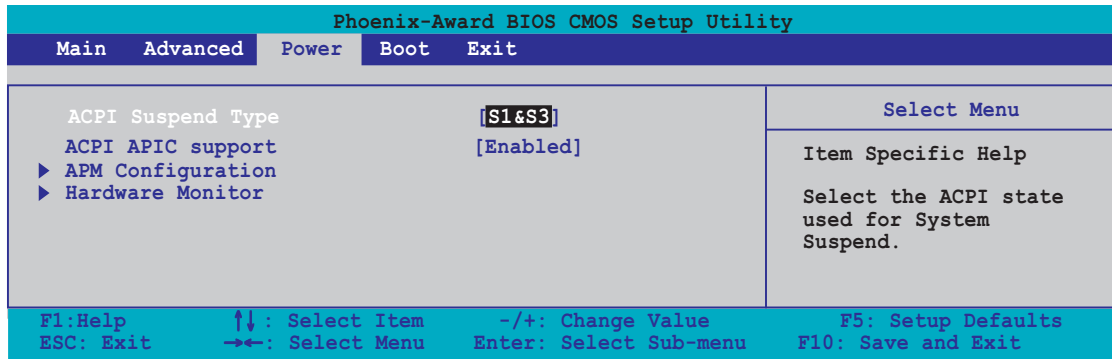

2.5.1 ACPI Suspend Type [S1&S3]

Allows you to select the Advanced Configuration and Power Interface (ACPI) state to be used for system suspend.

Configuration options: [S1 (POS)] [S3(STR)] [S1&S3]

2.5.2 ACPI APIC Support [Enabled]

Allows you to enable or disable the Advanced Configuration and Power Interface (ACPI) support in the Application-Specific Integrated Circuit (ASIC). When set to Enabled, the ACPI APIC table pointer is included in the RSDT pointer list. Configuration options: [Disabled] [Enabled]

2.5.3 APM Configuration

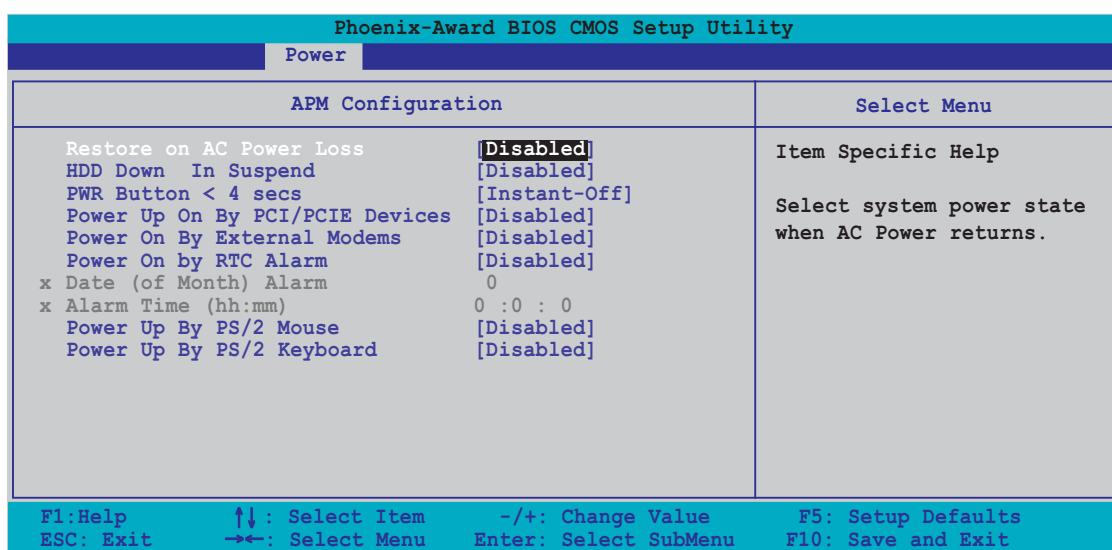

Restore on AC Power Loss [Disabled]

Allows you to enable or disable the Restore on AC Power Loss function.
Configuration options: [Disabled] [Enabled]

HDD Down In Suspend [Disabled]

Configuration options: [Disabled] [Enabled]

PWR Button < 4 secs [Instant-Off]

Allows you to set the event after the power button is pressed for more than 4 seconds. Configuration options: [Suspend] [Instant-Off]

Power Up On By PCI/PCIE Devices [Disabled]

Allows you to enable or disable the PME to wake up from S5 by PCI/PCIE devices & NV Onboard LAN. Configuration options: [Disabled] [Enabled]

Power On By External Modems [Disabled]

This allows either settings of [Enabled] or [Disabled] for powering up the computer when the external modem receives a call while the computer is in Soft-off mode. Configuration options: [Disabled] [Enabled]



The computer cannot receive or transmit data until the computer and applications are fully running. Thus, connection cannot be made on the first try. Turning an external modem off and then back on while the computer is off causes an initialization string that turns the system power on.

Power On By RTC Alarm [Disabled]

Allows you to enable or disable RTC to generate a wake event. When this item is set to Enabled, the items Date of Month Alarm and Time (hh:mm:ss) Alarm items become user-configurable with set values.

Configuration options: [Disabled] [Enabled]

Date of Month Alarm [Disabled]

To set the date of alarm, highlight this item and press <Enter> to display the Date of Month Alarm pop-up menu. Key-in a value within the specified range then press <Enter>. Configuration options: [Min=0] [Max=31]

Alarm Time (hh:mm) [Disabled]

To set the time of alarm:

1. Highlight this item and press <Enter> to display a pop-up menu for the hour field.
2. Key-in a value (Min=0, Max=23), then press <Enter>.
3. Press <TAB> to move to the minutes field then press <Enter>.
4. Key-in a minute value (Min=0, Max=59), then press <Enter>.
5. Press <TAB> to move to the seconds field then press <Enter>.
6. Key-in a value (Min=0, Max=59), then press <Enter>.

Power On By PS/2 Mouse [Disabled]

When set to [Enabled], this parameter allows you to use the PS/2 mouse to turn on the system. This feature requires an ATX power supply that provides at least 1A on the +5VSB lead.

Configuration options: [Disabled] [Enabled]

Power On By PS/2 Keyboard [Disabled]

Allows you to disable the Power On by PS/2 keyboard function or set specific keys on the PS/2 keyboard to turn on the system. This feature requires an ATX power supply that provides at least 1A on the +5VSB lead.

Configuration options: [Disabled] [Space Bar] [Ctrl-ESC] [Power Key]

2.5.4 Hardware Monitor

The items in this sub-menu displays the hardware monitor values automatically detected by the BIOS. It also allows you to change CPU Q-Fan feature-related parameters. Select an item then press <Enter> to display the configuration options.

Phoenix-Award BIOS CMOS Setup Utility		
Power		
Hardware Monitor	Select Menu	
Q-Fan Controller	[Disabled]	Item Specific Help▶▶
Vcore Voltage	[1.56V]	
3.3V Voltage	[3.18V]	
5V Voltage	[5.05V]	
12V Voltage	[11.58V]	Press [Enter] to enable or disable
CPU Temperature	48°C	
M/B Temperature	41°C	
CPU Fan Speed	3068 RPM	
Chassis Fan1 Speed	0 RPM	
Chassis Fan2 Speed	0 RPM	
Power Fan Speed	0 RPM	
CPU Fan Speed warning	[800 RPM]	

Q-Fan Controller [Disabled]

Allows you to enable or disable the Q-Fan controller.
Configuration options: [Disabled] [Enabled]

Vcore Voltage, 3.3V Voltage, 5V Voltage, 12V Voltage

The onboard hardware monitor automatically detects the voltage output through the onboard voltage regulators.
Configuration options: [xxx] [Ignored]

CPU Temperature, M/B Temperature

The onboard hardware monitor automatically detects and displays the motherboard and CPU temperatures. These items are not user-configurable.

CPU Fan Speed [xxxxRPM]

Chassis Fan1/Fan2 Speed [xxxxRPM]

Power Fan Speed [xxxxRPM]

The onboard hardware monitor automatically detects and displays the CPU, Chassis, and chip fan speeds in rotations per minute (RPM). If any of the fans is not connected to the motherboard, the field shows 0. These items are not user-configurable.

CPU Fan Speed warning [800 RPM]

Sets the CPU fan speed warning feature.
Configuration options: [Disabled] [800RPM] [1200RPM] [1600RPM]

2.6 Boot menu

The Boot menu items allow you to change the system boot options. Select an item then press <Enter> to display the sub-menu.

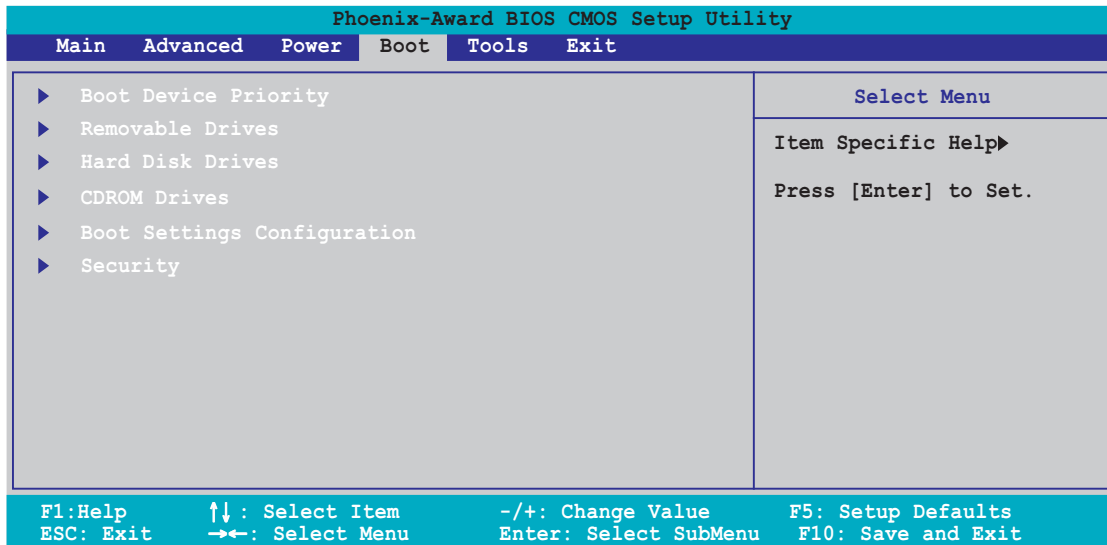

2.6.1 Boot Device Priority

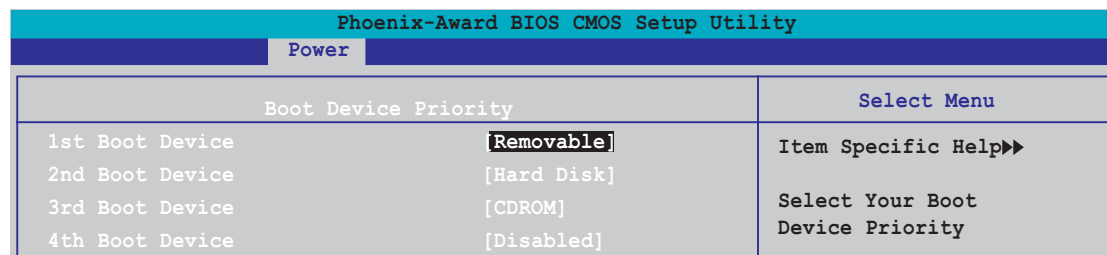

1st ~ 4th Boot Device [Removable]

These items specify the boot device priority sequence from the available devices. The number of device items that appears on the screen depends on the number of devices installed in the system.

Configuration options: [Removable] [Hard Disk] [CDROM]
[Legacy LAN] [Disabled]

2.6.2 Removable Drives

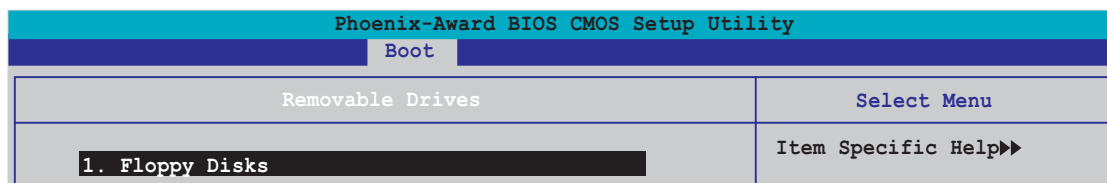

1. Floppy Disks

Allows you to assign a removable drive attached to the system.

2.6.3 Hard Disk Drives

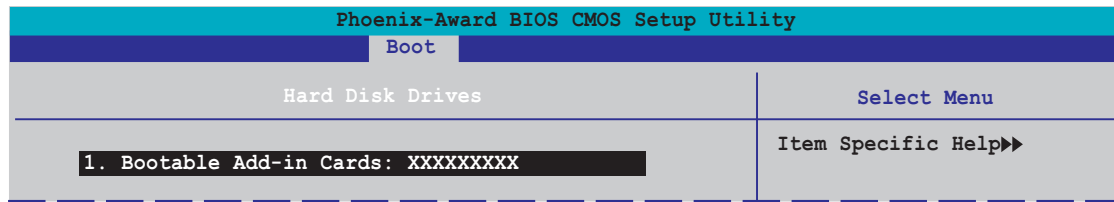

1. Bootable Add-in Cards

Allows you to assign bootable add-in cards attached to the system.

2.6.4 CDROM Drives

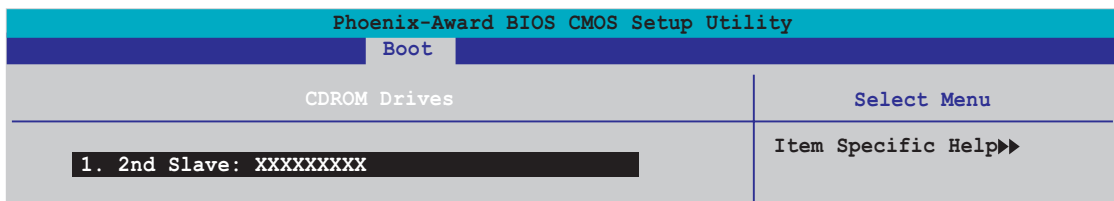

1. 2nd Slave: XXXXXXXXX

Allows you to assign CDROM drives attached to the system.

2.6.5 Boot Settings Configuration

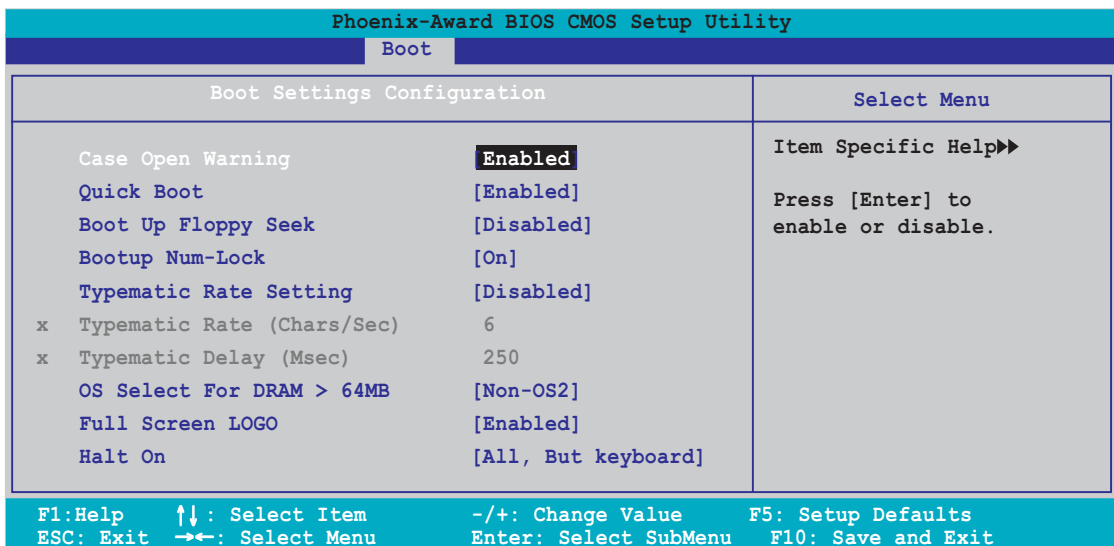

Case Open Warning [Enabled]

Enables or disables the chassis open status feature. Setting to Enabled, clears the chassis open status. Refer to section “1.10.2 Internal connectors” for setting details. Configuration options: [Disabled] [Enabled]

Quick Boot [Enabled]

Allows you to enable or disable the system quick boot feature. When Enabled, the system skips certain tests while booting. Configuration options: [Disabled] [Enabled]

Boot Up Floppy Seek [Disabled]

Enables or disables the chassis open status feature. Setting to Enabled, clears the chassis open status. Configuration options: [Disabled] [Enabled]

Bootup Num-Lock [On]

Allows you to select the power-on state for the NumLock. Configuration options: [Off] [On]

Typematic Rate Setting [Disabled]

Allows you to set the keystroke rate. Enable this item to configure the **Typematic Rate (Chars/Sec)** and the **Typematic Delay (Msec)**. Configuration options: [Disabled] [Enabled]



The items **Typematic Rate (Chars/Sec)** and **Typematic Delay (Msec)** become user-configurable only when the item Typematic Rate Setting is enabled.

Typematic Rate (Chars/Sec) [6]

Allows you to select the rate at which a character repeats when you hold a key. Configuration options: [6] [8] [10] [12] [15] [20] [24] [30]

Typematic Delay (Msec) [250]

Allows you to set the delay before keystrokes begin to repeat. Configuration options: [250] [500] [750] [1000]

OS Select for DRAM > 64MB [Non-OS2]

Set this item to OS2 only when you are running on an OS/2 operating system with an installed RAM of greater than 64 KB. Configuration options: [Non-OS2] [OS2]

Full Screen LOGO [Enabled]

Allows you to enable or disable the full screen logo display feature.
Configuration options: [Disabled] [Enabled]



Make sure that the above item is set to [Enabled] if you want to use the ASUS MyLogo™ feature.

Halt On [All, But Keyboard]

Allows you to error report type.
Configuration options: [All Errors] [No Errors] [All, But Keyboard]
[All, But Diskette] [All, But Disk/Key]

2.6.6 Security

Phoenix-Award BIOS CMOS Setup Utility		
Boot		
Boot Settings Configuration		Select Menu
Supervisor Password	Clear	Item Specific Help▶▶
User Password	Clear	
Password Check	[Setup]	

Supervisor Password User Password

These fields allow you to set passwords:

To set a password:

1. Select an item then press <Enter>.
2. Type in a password using a combination of a maximum of eight (8) alpha-numeric characters, then press <Enter>.
3. When prompted, confirm the password by typing the exact characters again, then press <Enter>. The password field setting is changed to Set.

To clear the password:

1. Select the password field and press <Enter> twice. The following message appears:



2. Press any key to continue. The password field setting is changed to Clear.

A note about passwords

The Supervisor password is required to enter the BIOS Setup program preventing unauthorized access. The User password is required to boot the system preventing unauthorized use.

Forgot your password?

If you forget your password, you can clear it by erasing the CMOS Real Time Clock (RTC) RAM. The RAM data containing the password information is powered by the onboard button cell battery. If you need to erase the CMOS RAM, refer to section “1.9 Jumpers” for instructions.

Password Check

This field requires you to enter the password before entering the BIOS setup or the system. Select [Setup] to require the password before entering the BIOS Setup. Select [System] to require the password before entering the system. Configuration options: [Setup] [System]

2.7 Tools menu

The Tools menu items allow you to configure options for special functions. Select an item then press <Enter> to display the sub-menu.

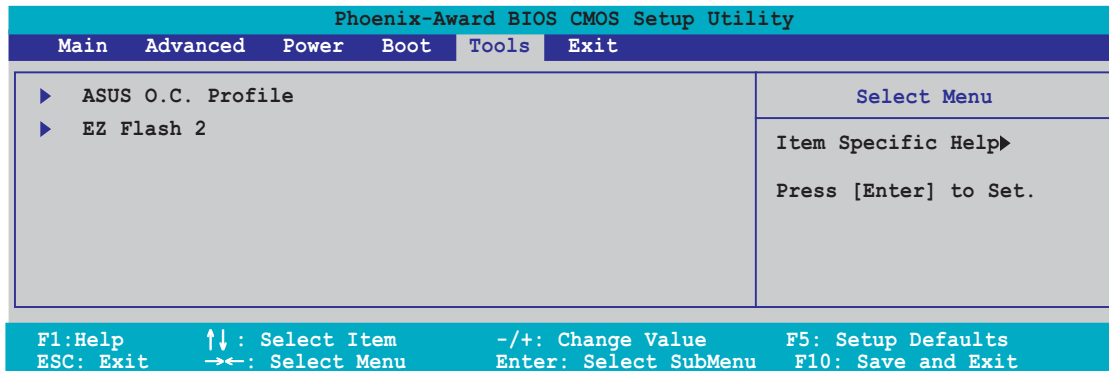

2.7.1 ASUS O.C. Profile

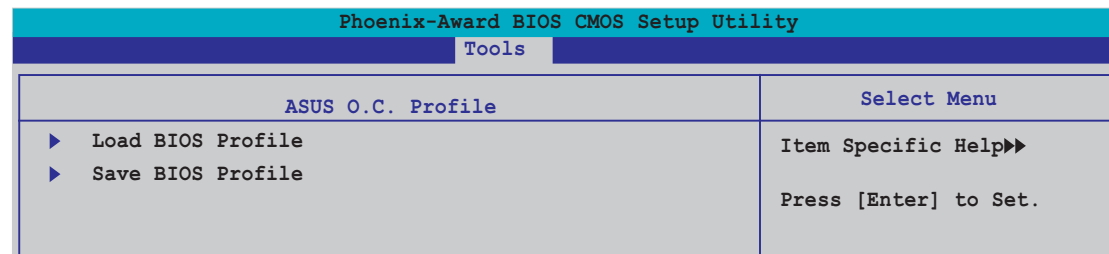

Load BIOS Profile

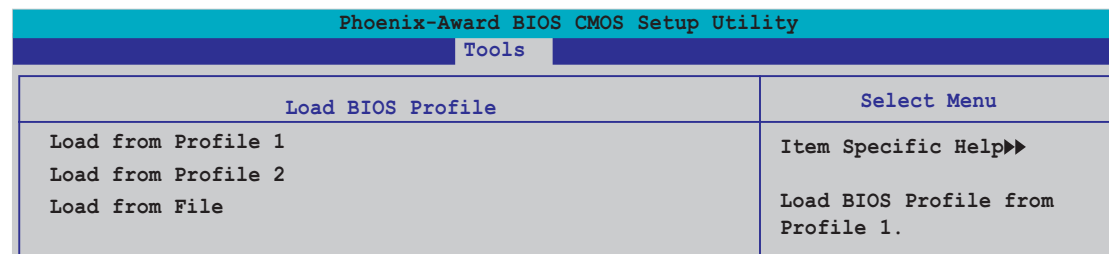

Load from Profile 1/2

Allows you to load the previous BIOS settings saved in the BIOS Flash. Press <Enter> to load the file.

Load from File

Allows you to load the previous BIOS files saved in the hard disk/floppy disk/USB flash disk with the FAT32/16/12 format. Follow the instructions below to load the BIOS file.

1. Insert the storage devices that contain the “xxx.CMO” file.
2. Turn on the system.

3. Enter BIOS setup program. Go to the “Tools” menu to select “Load from File”. Press <Enter> then the setup screen will appear.
4. Press <Tab> to switch between drives before the correct “xxx.CMO” file is found. Then press <Enter> to load the file.
5. A pop-up message will inform you when the loading process finishes.



- Suggest only to update the BIOS file coming from the same memory/CPU configuration and BIOS version.
- Only the “xxx.CMO” file can be loaded.

Save BIOS Profile

Phoenix-Award BIOS CMOS Setup Utility	
Tools	
Save BIOS Profile	Select Menu
Save to Profile 1	Item Specific Help▶▶
Save to Profile 2	Save current BIOS Profile to Profile 1.
Save to File	

Save to Profile 1/2

Allows you to save the current BIOS file to the BIOS Flash. Press <Enter> to save the file.

Save to File

Allows you to save the current BIOS file to the hard disk/floppy disk/USB flash disk with the FAT32/16/12 format. Follow the instructions below to save the BIOS file.

1. Insert the storage devices with enough space.
2. Turn on the system.
3. Enter BIOS setup program. Go to the “Tools” menu to select “Save to File”. Press <Enter> then the setup screen will appear.
4. Press <Tab> to switch between drives. Press hot-key <S> to save the file.
5. Key in the file name. Then press <Enter>.
6. A pop-up message will inform you when the loading process finishes.

```

ASUSTek O.C. Profile Utility B311

Current CMOS          Update CMOS
BOARD: M2NPVVM       BOARD: Unknown
VER: 04241.bin       VER: Unknown
DATE: 04/24/2006    DATE: Unknown

PATH: C:\M2NPVOC
A: CMOS backup is done! Press any key to Exit.
C:
  DOCUME~1           <DIR>
  PROGRA~1           <DIR>
  SYSTEM~1           <DIR>
  M2NPVVM            <DIR>
  RECYCLED           <DIR>
  TEST-REB          <DIR>
  BOOTFONT.BIN      213830 2001-09-05 20:00:00

Note
[Enter] Select [Y] Yes [N/Esc] No [Left/Right]: Switch

```



The BIOS file will be saved as “xxx.CMO”.

2.7.2 ASUS EZ Flash 2

Allows you to run ASUS EZ Flash 2. When you press <Enter>, a confirmation message appears. Use the left/right arrow key to select between [Yes] or [No], then press <Enter> to confirm your choice. Please see page 2-6, section 2.1.3 for details.

```

ASUSTek EZ Flash 2 BIOS RROM Utility B311
FLASH TYPE: Winbond W39V080A 8Mb LPC

Current ROM          Update ROM
BOARD: M2NPV VM     BOARD: Unknown
VER: 0122           VER: Unknown
DATE: 04/24/2006   DATE: Unknown

PATH: C:\M2NPVOC
A: WIN9BE           <DIR>
C: NETTERM          <DIR>
  DRIVERS           <DIR>
  RECYCLED          <DIR>
  WUTEMP            <DIR>
  NEWFOL~1         <DIR>
  INSTALL           <DIR>
  TEST-REB         <DIR>
  MSDOWNLD.TMP     <DIR>

Note
[Enter] Select          [S] Save          [ESC]Exit
[Tab] Switch           [Up/Down/Home/End] Move

```

2.8 Exit menu

The Exit menu items allow you to load the optimal or failsafe default values for the BIOS items, and save or discard your changes to the BIOS items.

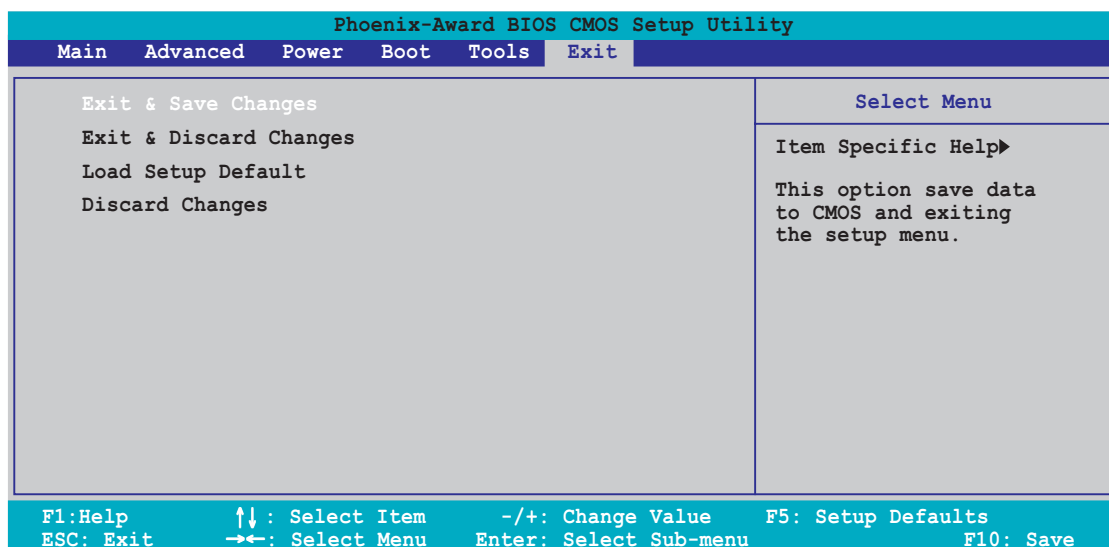

Pressing <Esc> does not immediately exit this menu. Select one of the options from this menu or <F10> from the legend bar to exit.

Exit & Save Changes

Once you are finished making your selections, choose this option from the Exit menu to ensure the values you selected are saved to the CMOS RAM. An onboard backup battery sustains the CMOS RAM so it stays on even when the PC is turned off. When you select this option, a confirmation window appears. Select **YES** to save changes and exit.



If you attempt to exit the Setup program without saving your changes, the program prompts you with a message asking if you want to save your changes before exiting. Press <Enter> to save the changes while exiting.

Exit & Discard Changes

Select this option only if you do not want to save the changes that you made to the Setup program. If you made changes to fields other than System Date, System Time, and Password, the BIOS asks for a confirmation before exiting.

Load Setup Defaults

This option allows you to load the default values for each of the parameters on the Setup menus. When you select this option or if you press <F5>, a confirmation window appears. Select **YES** to load default values. Select **Exit & Save Changes** or make other changes before saving the values to the non-volatile RAM.

Discard Changes

This option allows you to discard the selections you made and restore the previously saved values. After selecting this option, a confirmation appears. Select **YES** to discard any changes and load the previously saved values.

This chapter describes the contents of the support CD that comes with the motherboard package.

Software support



3.1 Installing an operating system

This motherboard supports Windows® 2000/XP operating systems (OS). Always install the latest OS version and corresponding updates to maximize the features of your hardware.



- Motherboard settings and hardware options vary. Use the setup procedures presented in this chapter for reference only. Refer to your OS documentation for detailed information.
- Make sure that you install Windows® 2000 Service Pack 4 or the Windows® XP Service Pack 1 or later versions before installing the drivers for better compatibility and system stability.

3.2 Support CD information

The support CD that came with the motherboard package contains the drivers, software applications, and utilities that you can install to avail all motherboard features.



The contents of the support CD are subject to change at any time without notice. Visit the ASUS website(www.asus.com) for updates.

3.2.1 Running the support CD

Place the support CD to the optical drive. The CD automatically displays the **Drivers** menu if Autorun is enabled in your computer.

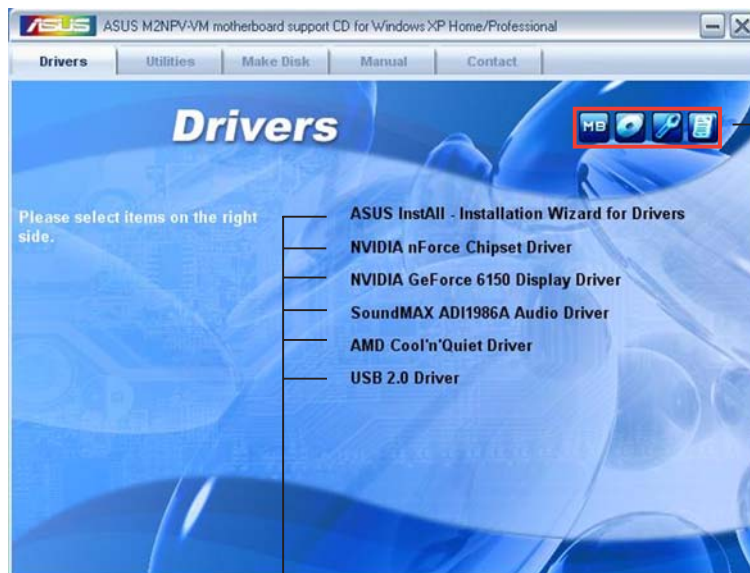

Click an icon to display support CD/motherboard information

Click an item to install



If **Autorun** is NOT enabled in your computer, browse the contents of the support CD to locate the file **ASSETUP.EXE** from the BIN folder. Double-click the **ASSETUP.EXE** to run the CD.

3.2.2 Drivers menu

The drivers menu shows the available device drivers if the system detects installed devices. Install the necessary drivers to activate the devices.



ASUS InstAll - Installation Wizard for Drivers

Launches the ASUS InstallAll driver installation wizard.

NVIDIA nForce Chipset Driver

Installs the NVIDIA® nForce™ Chipset Driver program.

NVIDIA GeForce 6150 GPU Driver

Installs the NVIDIA® GeForce 6150 graphics processing unit (GPU) driver.

SoundMAX® ADI1986A Audio Driver

Executes the wizard to install the SoundMAX™ AD1986A audio driver and application.

AMD Cool 'n' Quiet Driver

Installs the AMD Cool 'n' Quiet driver.

USB 2.0 Driver

Installs the USB 2.0 driver.



The screen display and drivers option may not be the same for different operating system versions.

3.2.3 Utilities menu

The Utilities menu shows the applications and other software that the motherboard supports.



ASUS InstAll - Installation Wizard for Utilities

Launches the ASUS InstallAll utilities installation wizard.

ASUS PC Probe II

This smart utility monitors the fan speed, CPU temperature, and system voltages, and alerts you of any detected problems. This utility helps you keep your computer in healthy operating condition.

ASUS Update

The ASUS Update utility allows you to update the motherboard BIOS in a Windows® environment. This utility requires an Internet connection either through a network or an Internet Service Provider (ISP).

ASUS Screen Saver

Installs the ASUS screen saver.

ADOBE Acrobat Reader V7.0

The Adobe® Acrobat® Reader V7.0 is for opening, viewing, and printing documents in Portable Document Format (PDF).

ASUS Cool 'n' Quiet Utility

This item installs the ASUS Cool 'n' Quiet utility.

Microsoft DirectX 9.0c

The Microsoft® DirectX® 9.0c is a multimedia technology that enhances computer graphics and sounds. DirectX® improves the multimedia features of your computer so you can enjoy watching TV and movies, capturing videos, or playing games on your computer.



Microsoft® Windows® XP Service Pack 2 already includes Microsoft® DirectX® 9.0c. If your system is Microsoft® Windows® XP Service Pack 2-embedded, skip Microsoft® DirectX® 9.0c installation.

Anti-Virus utility

The anti-virus utility scans, identifies, and removes computer viruses. View the online help for detailed information.



The screen display and utilities option may not be the same for different operating system versions.

3.2.4 Make Disk menu

The Make Disk menu allows you to make a RAID driver disk.



NVIDIA® 32bit Win2K SATA RAID Driver

Allows you to create an NVIDIA® Windows® 2000 Serial ATA (SATA) RAID driver disk for a 32-bit system.

NVIDIA® 32bit WinXP SATA RAID Driver

Allows you to create an NVIDIA® Windows® XP Serial ATA (SATA) RAID driver disk for a 32-bit system.

NVIDIA® 64bit SATA RAID Driver

Allows you to create an NVIDIA® Serial ATA (SATA) RAID driver disk for a 64-bit system.

3.2.5 Manual menu

The Manual menu contains a list of supplementary user manuals. Click an item to open the folder of the user manual.



Most user manual files are in Portable Document Format (PDF). Install the Adobe® Acrobat® Reader from the **Utilities menu** before opening a user manual file.



NVIDIA® RAID User's Manual

Allows you to open the NVIDIA® RAID user's manual.

3.2.6 ASUS Contact information

Click the **Contact** tab to display the ASUS contact information. You can also find this information on the inside front cover of this user guide.



3.2.7 Other information

The icons on the top right corner of the screen give additional information on the motherboard and the contents of the support CD. Click an icon to display the specified information.

Motherboard Info

Displays the general specifications of the motherboard.

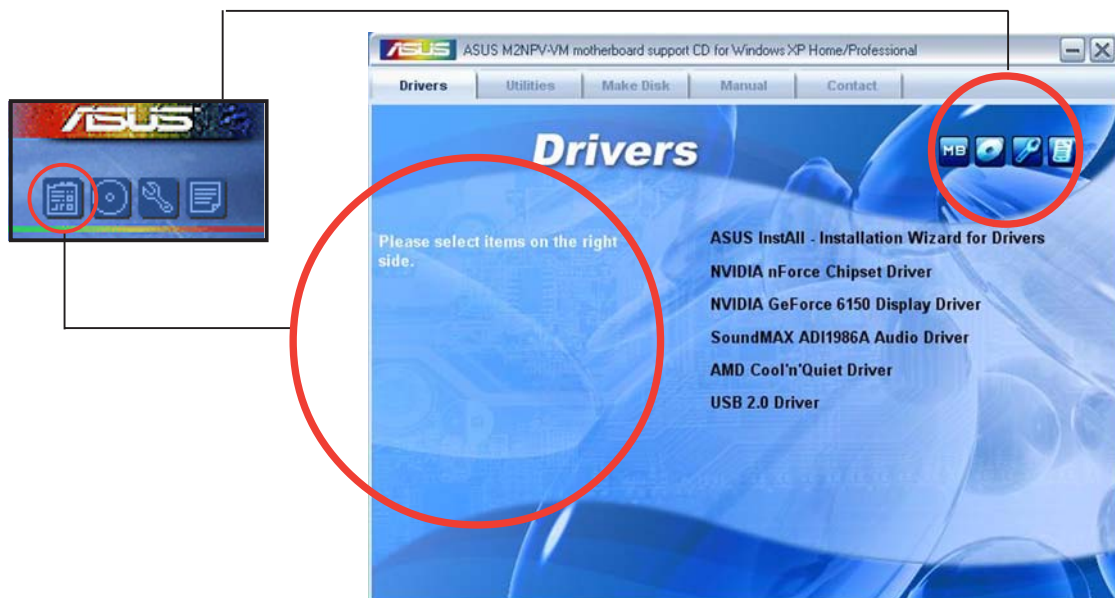

Browse this CD

Displays the support CD contents in graphical format.

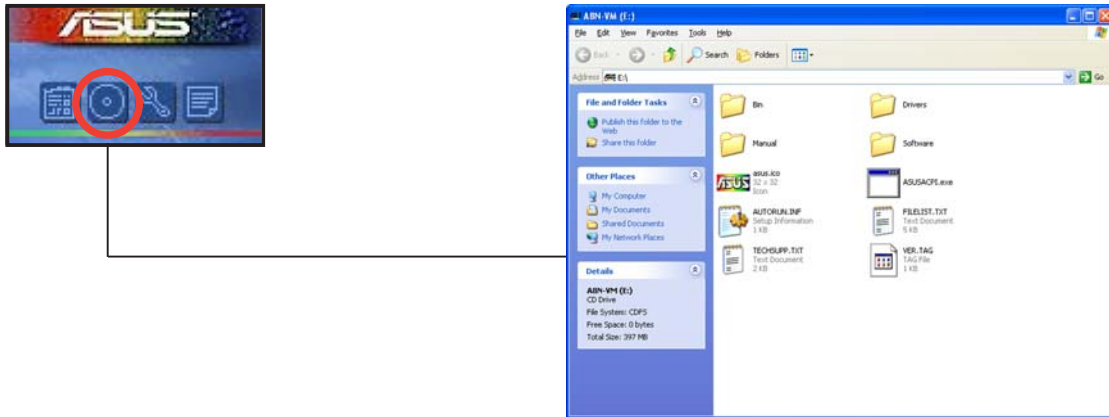

Technical support Form

Displays the ASUS Technical Support Request Form that you have to fill out when requesting technical support.

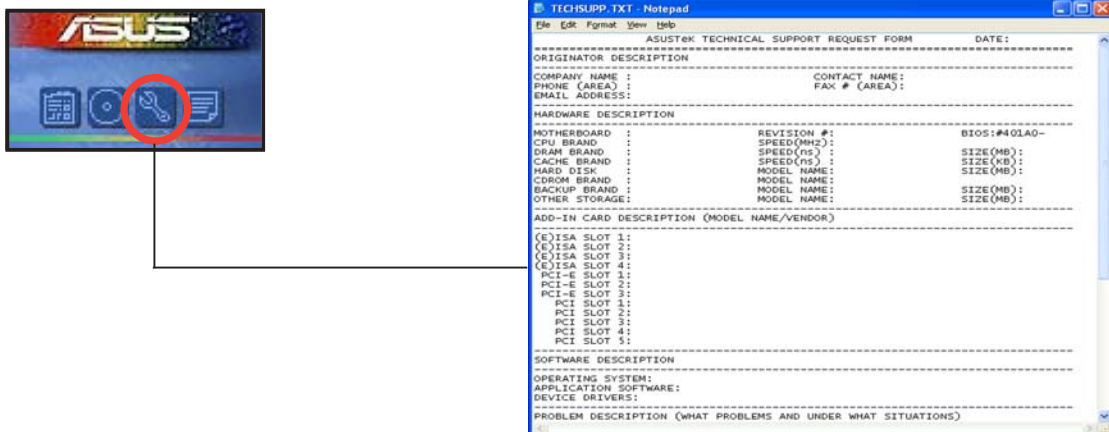

Filelist

Displays the contents of the support CD and a brief description of each in text format.

