



# Notebook PC

*E-Manual*



## E7483 August 2012

### **COPYRIGHT INFORMATION**

No part of this manual, including the products and software described in it, may be reproduced, transmitted, transcribed, stored in a retrieval system, or translated into any language in any form or by any means, except documentation kept by the purchaser for backup purposes, without the express written permission of ASUSTeK COMPUTER INC. ("ASUS").

ASUS PROVIDES THIS MANUAL "AS IS" WITHOUT WARRANTY OF ANY KIND, EITHER EXPRESS OR IMPLIED, INCLUDING BUT NOT LIMITED TO THE IMPLIED WARRANTIES OR CONDITIONS OF MERCHANTABILITY OR FITNESS FOR A PARTICULAR PURPOSE. IN NO EVENT SHALL ASUS, ITS DIRECTORS, OFFICERS, EMPLOYEES OR AGENTS BE LIABLE FOR ANY INDIRECT, SPECIAL, INCIDENTAL, OR CONSEQUENTIAL DAMAGES (INCLUDING DAMAGES FOR LOSS OF PROFITS, LOSS OF BUSINESS, LOSS OF USE OR DATA, INTERRUPTION OF BUSINESS AND THE LIKE), EVEN IF ASUS HAS BEEN ADVISED OF THE POSSIBILITY OF SUCH DAMAGES ARISING FROM ANY DEFECT OR ERROR IN THIS MANUAL OR PRODUCT.

Products and corporate names appearing in this manual may or may not be registered trademarks or copyrights of their respective companies, and are used only for identification or explanation and to the owners' benefit, without intent to infringe.

SPECIFICATIONS AND INFORMATION CONTAINED IN THIS MANUAL ARE FURNISHED FOR INFORMATIONAL USE ONLY, AND ARE SUBJECT TO CHANGE AT ANY TIME WITHOUT NOTICE, AND SHOULD NOT BE CONSTRUED AS A COMMITMENT BY ASUS. ASUS ASSUMES NO RESPONSIBILITY OR LIABILITY FOR ANY ERRORS OR INACCURACIES THAT MAY APPEAR IN THIS MANUAL, INCLUDING THE PRODUCTS AND SOFTWARE DESCRIBED IN IT.

Copyright © 2012 ASUSTeK COMPUTER INC. All Rights Reserved.

### **LIMITATION OF LIABILITY**

Circumstances may arise where because of a default on ASUS' part or other liability, you are entitled to recover damages from ASUS. In each such instance, regardless of the basis on which you are entitled to claim damages from ASUS, ASUS is liable for no more than damages for bodily injury (including death) and damage to real property and tangible personal property; or any other actual and direct damages resulted from omission or failure of performing legal duties under this Warranty Statement, up to the listed contract price of each product.

ASUS will only be responsible for or indemnify you for loss, damages or claims based in contract, tort or infringement under this Warranty Statement.

This limit also applies to ASUS' suppliers and its reseller. It is the maximum for which ASUS, its suppliers, and your reseller are collectively responsible.

UNDER NO CIRCUMSTANCES IS ASUS LIABLE FOR ANY OF THE FOLLOWING: (1) THIRD-PARTY CLAIMS AGAINST YOU FOR DAMAGES; (2) LOSS OF, OR DAMAGE TO, YOUR RECORDS OR DATA; OR (3) SPECIAL, INCIDENTAL, OR INDIRECT DAMAGES OR FOR ANY ECONOMIC CONSEQUENTIAL DAMAGES (INCLUDING LOST PROFITS OR SAVINGS), EVEN IF ASUS, ITS SUPPLIERS OR YOUR RESELLER IS INFORMED OF THEIR POSSIBILITY.

### **SERVICE AND SUPPORT**

Visit our multi-language web site at <http://support.asus.com>

# Table of Contents

About this manual .....	6
Conventions used in this manual .....	7
Icons .....	7
Typography.....	7
Safety precautions .....	8
Using your Notebook PC.....	8
Caring for your Notebook PC .....	9
Airplane mode.....	10
Proper disposal.....	10

## Chapter 1: Hardware Setup

Getting to know your Notebook PC.....	12
Top View.....	12
Bottom .....	16
Right Side .....	18
Left Side .....	20
Front View.....	22

## Chapter 2: Using your Notebook PC

Getting started.....	24
Install the battery pack.....	24
Charge your Notebook PC.....	25
Lift to open the display panel. ....	26
Press the power button.....	26
The Power-on Self Test (POST) .....	27
BIOS .....	27
Accessing BIOS .....	27
BIOS Settings.....	28
Gestures for the touchpad.....	35
Moving the pointer.....	35
One-finger gestures.....	36
Two-finger gestures.....	38
Three-finger gestures.....	39
Using the keyboard .....	40
Function keys .....	40

Function keys for ASUS Apps .....	41
Windows®8 keys.....	41
Multimedia control keys .....	42
Numeric keypad (on selected models).....	42
Using the optical drive (on selected models) .....	43

### **Chapter 3: Working with Windows® 8**

Starting for the first time .....	46
Windows® 8 lock screen.....	46
Metro style UI.....	47
Metro Start screen.....	47
Metro Style App .....	47
Hotspots.....	48
Working with Metro Style apps.....	50
Launching apps.....	50
Customizing apps.....	50
Closing apps.....	51
Accessing the Apps screen.....	52
Charm bar.....	54
Snap feature .....	56
Other keyboard shortcuts.....	58
Wi-Fi connection .....	59
Enabling Wi-Fi .....	59
Bluetooth connection.....	61
Pairing with other Bluetooth-enabled devices.....	61
Airplane mode.....	63
Turning Airplane mode on.....	63
Turning Airplane mode off.....	63
Remove everything and reinstall Windows.....	64
Turning your Notebook PC off.....	65
Putting your Notebook PC to sleep .....	65

### **Chapter 4: ASUS apps**

Featured ASUS Apps .....	68
LifeFrame .....	68
Power4Gear Hybrid.....	70

USB Charger+.....	71
Instant On.....	73

## **Chapter 5: Upgrading your Notebook PC**

Installing a Random Access Memory (RAM) module.....	76
Replacing the Hard Disk Drive (HDD) .....	78
Replacing the battery pack.....	80

## **Chapter 6: Troubleshooting your Notebook PC**

## **Appendices**

# About this manual

This manual provides information about the hardware and software features of your Notebook PC, organized through the following chapters:

## **Chapter 1: Hardware Setup**

This chapter details the hardware components of your Notebook PC.

## **Chapter 2: Using your Notebook PC**

This chapter shows you how to use the different parts of your Notebook PC, including the BIOS.

## **Chapter 3: Working with Windows® 8**

This chapter provides an overview of using Windows® 8 in your Notebook PC.

## **Chapter 4: ASUS Apps**

This chapter features the ASUS apps included with your Notebook PC.

## **Chapter 5: Upgrading your Notebook PC**

This chapter guides you through the process of replacing and upgrading parts of your Notebook PC.

## **Chapter 6: Troubleshooting your Notebook PC**

This chapter includes common problems and solutions for your Notebook PC.

## **Appendices**

This section includes notices and safety statements for your Notebook PC.

## Conventions used in this manual

To highlight key information in this manual, some text are presented as follows:

---

**IMPORTANT!** This message contains vital information that must be followed to complete a task.

---

---

**NOTE:** This message contains additional information and tips that can help complete tasks.

---

---

**WARNING!** This message contains important information that must be followed to keep you safe while performing tasks and prevent damage to your Notebook PC's data and components.

---

## Icons

The icons below indicate the devices yo u can use for completing a series of tasks or procedures on your Notebook PC.

 = Use the touchpad.

 = Use the keyboard.

## Typography

**Bold** = This indicates a menu or an item that must be selected.

*Italic* = This indicates sections that you can refer to in this manual.

# Safety precautions

## Using your Notebook PC



This Notebook PC should only be used in environments with ambient temperatures between 5°C (41°F) and 35°C (95°F).



Refer to the rating label on the bottom of your Notebook PC and ensure that your power adapter complies with this rating.



Do not leave your Notebook PC connected to the power source once it is fully charged. Some electronic devices are not designed to be left connected to the power source for extended periods of time.



Incorrect installation of battery may cause explosion and damage your Notebook PC.



Do not leave your Notebook PC on your lap or near any part of your body to prevent discomfort or injury from heat exposure.



Do not use damaged power cords, accessories, and other peripherals with your Notebook PC.



While powered on, ensure that you do not carry or cover your Notebook PC with any materials that can reduce air circulation.



Do not place your Notebook PC on uneven or unstable work surfaces.



## Caring for your Notebook PC



Disconnect the AC power and remove the battery pack (if applicable) before cleaning your Notebook PC. Use a clean cellulose sponge or chamois cloth dampened with a solution of nonabrasive detergent and a few drops of warm water. Remove any extra moisture from your Notebook PC using a dry cloth.



Do not use strong solvents such as thinners, benzene, or other chemicals on or near your Notebook PC.



Do not place objects on top of your Notebook PC.



Do not expose your Notebook PC to strong magnetic or electrical fields.



Do not use or expose your Notebook PC near liquids, rain, or moisture.



Do not expose your Notebook PC to dusty environments.



Do not use your Notebook PC near gas leaks.

## Airplane mode



You can send your Notebook PC through airport x-ray machines (used on items placed on conveyor belts), but do not expose them to magnetic detectors and wands.



Contact your airline provider to learn about related inflight services that can be used and restrictions that must be followed when using your Notebook PC in-flight.

## Proper disposal



Do not throw the battery into fire to avoid explosion.



Do not throw your Notebook PC in municipal waste. This product has been designed to enable proper reuse of parts and recycling. The symbol of the crossed out wheeled bin indicates that the product (electrical, electronic equipment and mercury-containing button cell battery) should not be placed in municipal waste. Check local regulations for disposal of electronic products.



Do not throw the battery in municipal waste. The symbol of the crossed out wheeled bin indicates that the battery should not be placed in municipal waste.

# ***Chapter 1:*** ***Hardware Setup***

# Getting to know your Notebook PC

## Top View

**NOTE:** The keyboard's layout may vary per region or country. The top view may also vary in appearance depending on the Notebook PC model.

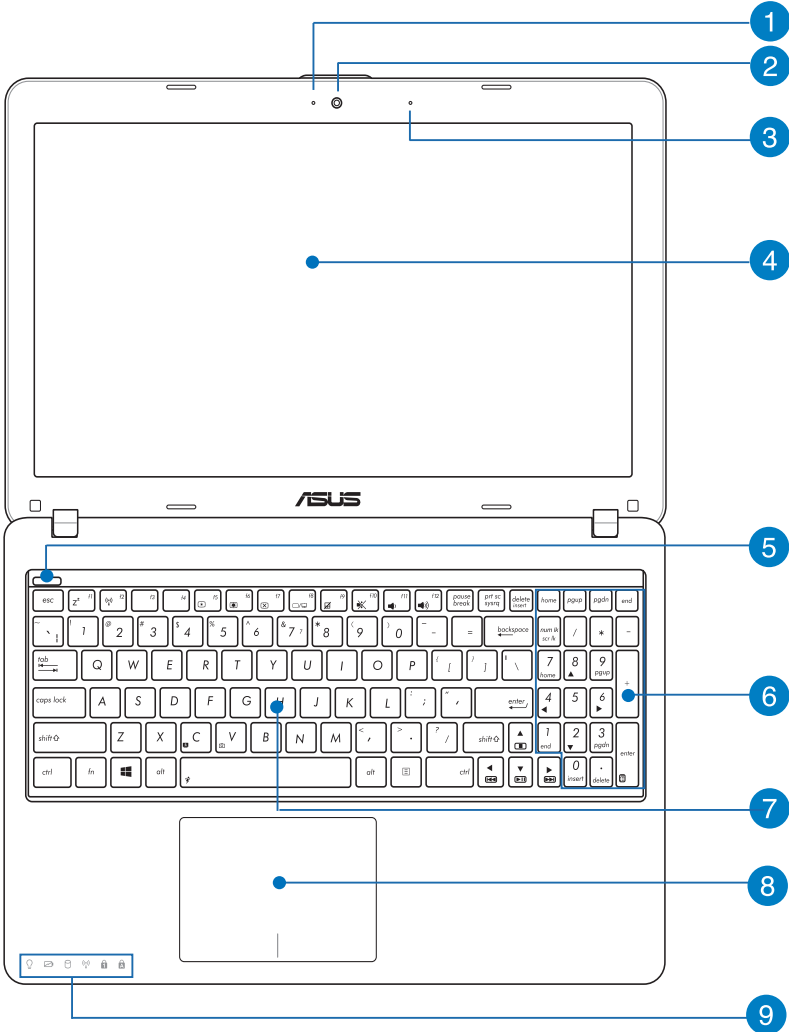

### 1 Microphone

The built-in microphone can be used for video conferencing, voice narrations, or simple audio recording.

### 2 Camera

The built-in camera allows you take pictures or record videos using your Notebook PC.

### 3 Camera indicator

The camera indicator lights up when the built-in camera is in use.

### 4 Display panel

This high-definition display panel provides excellent viewing features for photos, videos, and other multimedia files on your Notebook PC.

### 5 Power button

Press the power button to turn your Notebook PC on or off. You can also use the power button to put your Notebook PC to sleep or hibernate mode and wake it up from sleep or hibernate mode.

In the event that your Notebook PC becomes unresponsive, press and hold the power button for about four (4) seconds until your Notebook PC shuts down.

### 6 Numeric keypad (on selected models)

A numeric keypad is available on selected Notebook PC models.

---

**NOTE:** For more details, refer to the *Numeric Keypad* section in this manual.

---

## 7 Keyboard

The keyboard provides full-sized QWERTY keys with a comfortable travel depth for typing. It also enables you to use the function keys, allows quick access to Windows®, and controls other multimedia functions.

---

### NOTE:

- The keyboard layout differs by model or territory.
  - Some selected models come with a backlit keyboard.
- 

## 8 Touchpad

The touchpad allows the use of multi-gestures to navigate onscreen, providing an intuitive user experience. It also simulates the functions of a regular mouse.

---

**NOTE:** For more details, refer to the *Gestures for the touchpad* section in this manual.

---

## 9 Status indicators

The status indicators help identify the current hardware status of your Notebook PC.



### Power Indicator

The power indicator lights up when the Notebook PC is turned on and blinks slowly when the Notebook PC is in sleep mode.

### **Two-color battery charge indicator**

The two-color LED provides a visual indication of the battery's charge status. Refer to the table below for details:

Color	Status
<b>Solid Green</b>	Battery power is between 95% and 100%
<b>Solid Orange</b>	Battery power is less than 95%
<b>Blinking Orange</b>	Battery power is less than 10%
<b>Lights off</b>	Battery power is more than 10% and below 100%

### **Drive activity indicator**

This indicator lights up when your Notebook PC is accessing the internal storage drives.

### **Bluetooth / Wireless indicator (on selected models)**

This indicator lights up when your Notebook PC's wireless function (Bluetooth or Wi-Fi) is enabled.

### **Number lock indicator**

This indicator lights up when the number lock function is activated. This allows you to use some of the keys on your keyboard for numeric input.

### **Capital lock indicator**

This indicator lights up when the capital lock function is activated. Using capital lock allows you to type capitalized letters (such as A, B, C) using your Notebook PC's keyboard.

# Bottom

---

**NOTE:** The bottom side may vary in appearance depending on model.

---

**WARNING!** The bottom of the Notebook PC can get very hot while in use or while charging the battery pack. When working on your Notebook PC, do not place it on surfaces that can block the vents.

---

**IMPORTANT!** Battery time varies by usage and by the specifications for this Notebook PC. The battery pack cannot be disassembled.

---

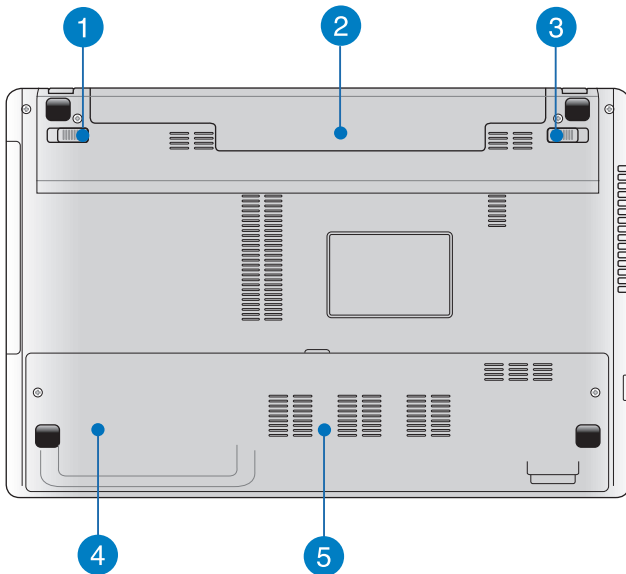



### 1 Spring battery lock

The spring battery lock automatically locks the battery pack in place once it is inserted into the battery slot.

---

**IMPORTANT!** This lock should be held in an unlocked position when removing the battery pack.

---

### 2 Battery pack

The battery pack is automatically charged when your Notebook PC is connected to a power source. When charged, the battery pack supplies power to your Notebook PC.

### 3 Manual battery lock

The manual battery lock is used to keep the battery pack secured. This lock should be manually moved to a locked or unlocked position to insert or remove the battery pack.

### 4 Hard disk drive compartment

This compartment is a reserved space for the hard disk drive of your Notebook PC.

### 5 Random-access memory module (RAM) compartment

The RAM compartment allows you to add RAM memory modules to increase the memory capacity of your Notebook PC.

## Right Side

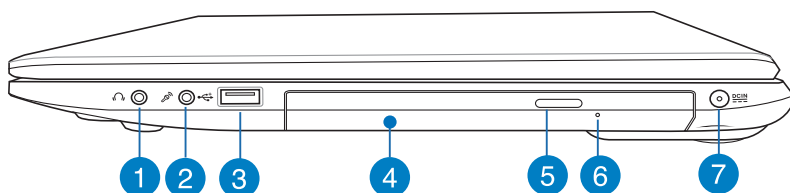

### 1 Headphone output jack port

The headphone output jack port allows you to connect your Notebook PC to amplified speakers or headphones.

### 2 Microphone input jack port

The microphone input jack port is used to connect your Notebook PC to an external microphone.

### 3 USB 2.0 port

The USB (Universal Serial Bus) port is compatible with USB 2.0 or USB 1.1 devices such as keyboards, pointing devices, flash disk drives, external HDDs, speakers, cameras and printers.

### 4 Optical drive (on selected models)

Your Notebook PC's optical drive may support several disc formats such as CDs, DVDs, recordable discs, or rewritable discs.

### 5 Optical disc drive eject button

Press this button to eject the optical drive tray.

### 6 Manual eject hole

The manual eject hole is used to eject the drive tray in case the electronic eject button does not work.

---

**WARNING!** Use the manual eject hole only when the electronic eject button does not work.

---

---

**NOTE:** For more details, refer to the *Using the optical drive* section in this manual.

---

### 7 Power (DC) input port

Insert the bundled power adapter into this port to charge the battery pack and supply power to your Notebook PC.

---

**WARNING!** The adapter may become warm to hot while in use. Do not cover the adapter and keep it away from your body while it is connected to an power source.

---

---

**IMPORTANT!** Use only the bundled power adapter to charge the battery pack and supply power to your Notebook PC.

---

## Left Side

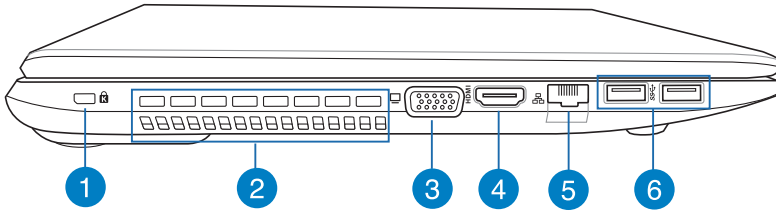

### 1 Kensington® lock port

The Kensington® lock port allows you to secure your Notebook PC using Kensington® compatible Notebook PC security products.

### 2 Air vents

The air vents allow cool air to enter and warm air to exit the Notebook PC.

---

**WARNING!** Ensure that paper, books, clothing, cables, or other objects do not block any of the air vents or else overheating may occur.

---

### 3 VGA port

This port allows you to connect your Notebook PC to an external display.

### 4 HDMI port

This port is for a High-Definition Multimedia Interface (HDMI) connector and is HDCP compliant for HD DVD, Blu-ray, and other protected content playback.

### **5 LAN port**

Insert the network cable into this port to connect to a local area network (LAN).

### **6 USB 3.0 ports**

These Universal Serial Bus 3.0 (USB 3.0) ports are backward compatible to USB 2.0 and USB 1.0 devices such as keyboards, pointing devices, flash disk drives, external HDDs, speakers, cameras and printers. These ports have a transfer speed of up to 5 Gbit/s.

## Front View



### 1 Memory card reader

This Notebook PC has a single built-in memory card reader slot that supports MMC, SD, and SDHC card formats.

### 2 Status indicators

The status indicators help identify the current hardware status of your Notebook PC.

---

**NOTE:** For more details, refer to the *Top View* section in this manual.

---

# ***Chapter 2:*** ***Using your Notebook PC***

# Getting started

---

**NOTE:** If your Notebook PC does not have its battery pack installed, use the following procedures for installation.

---

## Install the battery pack.

- A** Move the manual battery lock to the unlocked position.
- B** Align and insert the battery pack into the Notebook PC's battery slot.
- C** Move the manual battery lock back to the locked position after inserting the battery pack.

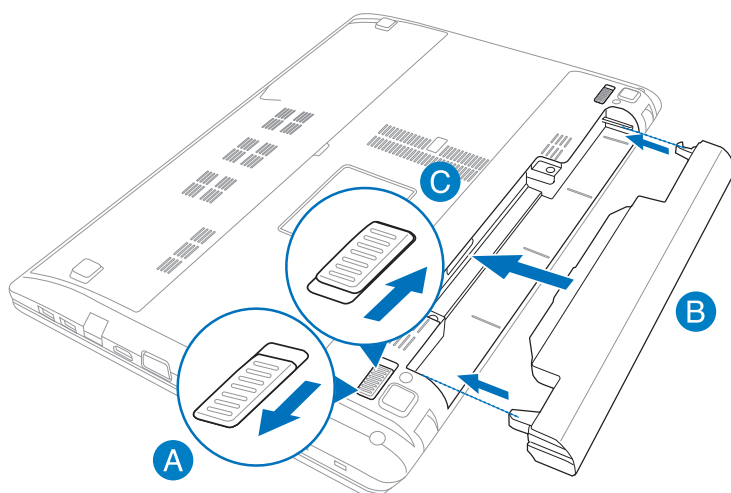



## Charge your Notebook PC.

- A** Connect the AC power cord to the AC/DC adapter.
- B** Plug the AC power cord into a 100V~240V power source.
- C** Connect the DC power connector into your Notebook PC's power (DC) input port.



Charge the Notebook PC for **3 hours** before using it in battery mode for the first time.

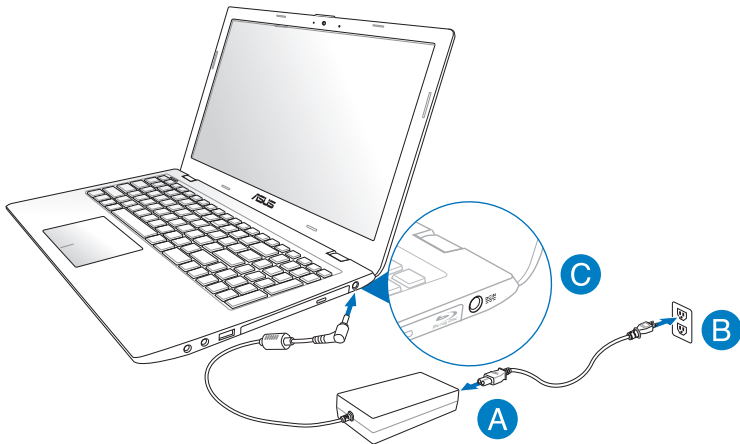

---

### IMPORTANT!

- Ensure that your Notebook PC is connected to the power adapter before turning it on for the first time.
  - Use only the power adapter bundled with your Notebook PC.
  - Power adapter information:
    - Input voltage: 100-240Vac
    - Input frequency: 50-60Hz
    - Rating output current: 3.42A (65W)
    - Rating output voltage: 19Vdc
-

**Lift to open the display panel.**

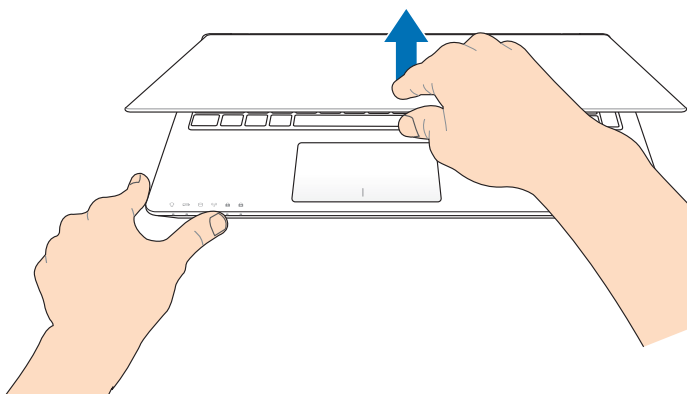

**Press the power button.**

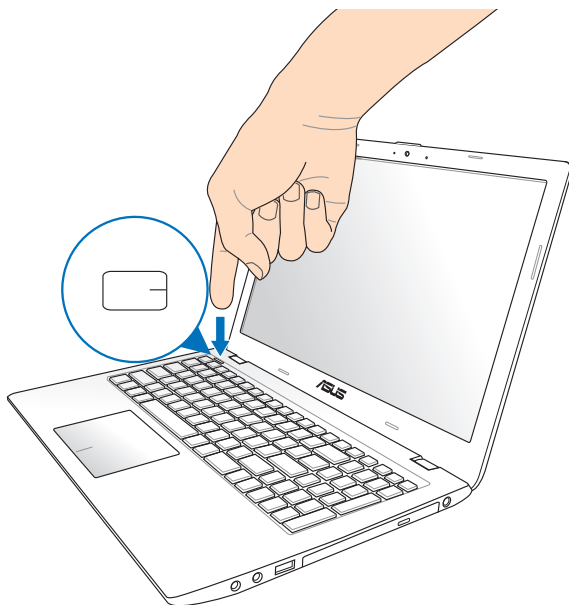

# The Power-on Self Test (POST)

When you turn on the Notebook PC, it runs through a series of software-controlled diagnostic tests called the Power-on Self Test (POST).

The software that controls the POST is installed as a permanent part of the Notebook PC's architecture. If the POST discovers a difference between the record and the existing hardware, it will display a message on the screen prompting you to correct the conflict by running BIOS Setup.

## BIOS

The BIOS (Basic Input and Output System) stores system hardware settings that are needed for system startup in the Notebook PC.

The default BIOS settings apply to most conditions of your Notebook PC. Do not change the default BIOS settings except in the following circumstances:

- An error message appears onscreen during system bootup and requests you to run the BIOS Setup.
- You have installed a new system component that requires further BIOS settings or updates.

---

**WARNING:** Using inappropriate BIOS settings may result to system instability or boot failure. We strongly recommend that you change the BIOS settings only with the help of a trained service personnel.

---

## Accessing BIOS



Restart your Notebook PC then press  during POST.

# BIOS Settings

**NOTE:** The BIOS screens in this section are for reference only. The actual screens may differ by model and territory.

## Boot

This menu allows you to set your boot option priorities. You may refer to the following procedures when setting your boot priority.

1. On the **Boot** screen, select **Boot Option #1**.

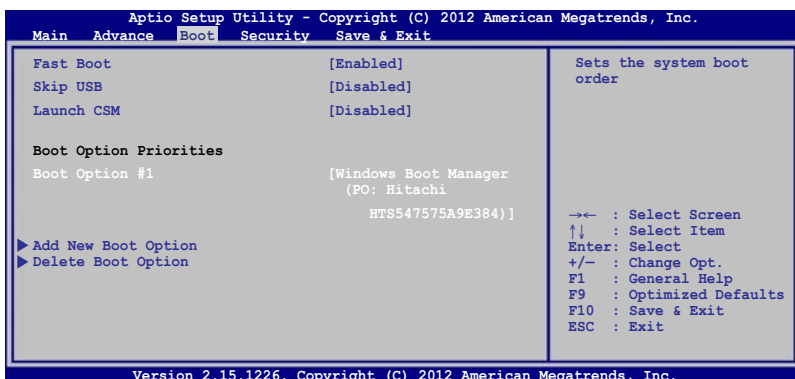

2. Press  and select a device as the **Boot Option #1**.

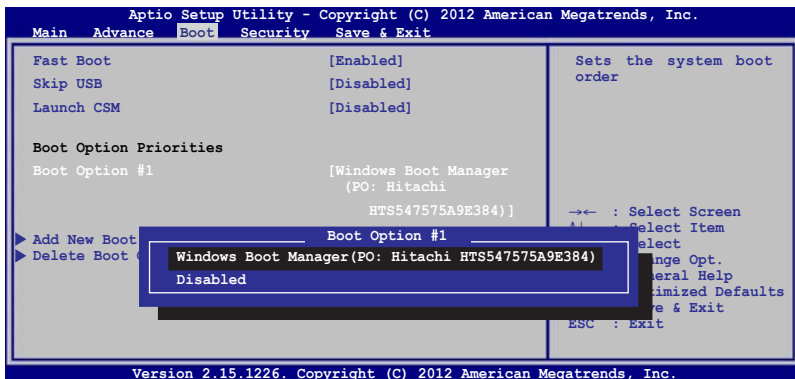

## Security

This menu allows you to set up the administrator and user password of your Notebook PC. It also allows you to control access to your Notebook PC's hard disk drive, input/output (I/O) interface, and USB interface.



---

### NOTE:

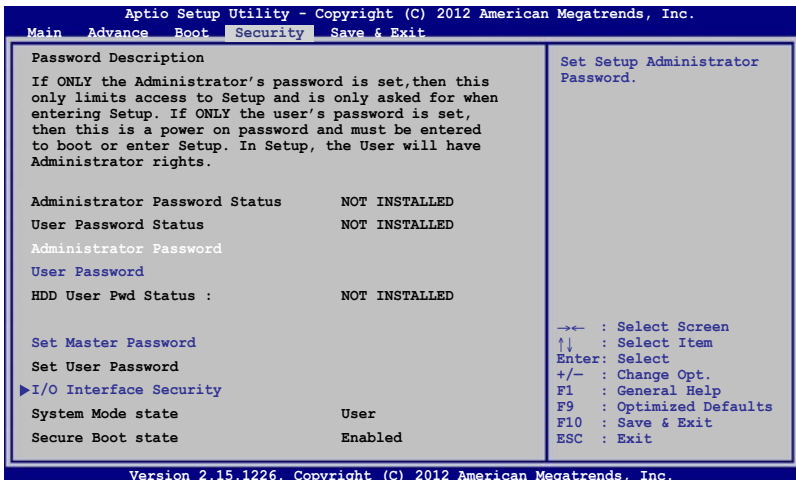

- If you install a **User Password**, you will be prompted to input this before entering your Notebook PC's operating system.
  - If you install an **Administrator Password**, you will be prompted to input this before entering BIOS.
- 



To set the password:

1. On the **Security** screen, select **Administrator Password** or **User Password**.
2. Type in a password then press .
3. Re-type to confirm the password then press .

To clear the password:

1. On the **Security** screen, select **Administrator Password** or **User Password**.
2. Type in the current password then press .
3. Leave the **Create New Password** field blank then press .
4. Select **Yes** in the confirmation box then press .

### I/O Interface Security

In the Security menu, you can access I/O Interface Security to lock or unlock some interface functions of your Notebook PC.

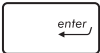

To lock an interface:

1. On the **Security** screen, select **I/O Interface Security**.
2. Select an interface you would like to lock then press .
3. Select **LOCKED**.

## USB Interface Security

Through the I/O Interface Security menu, you can also access USB Interface Security to lock or unlock ports and devices.

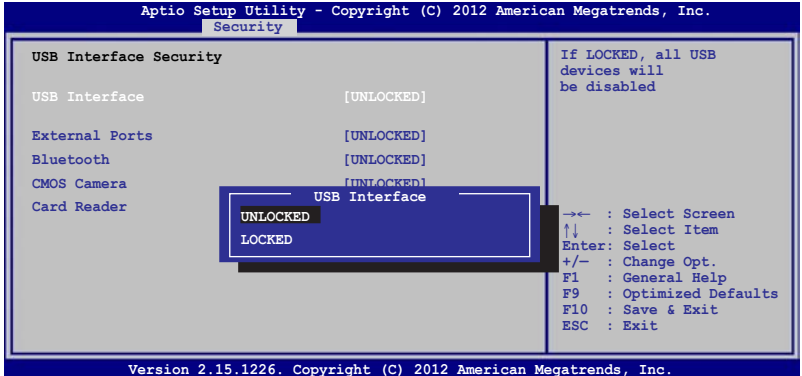

To lock the USB interface:

1. On the **Security** screen, select **I/O Interface Security > USB Interface Security**.
2. Select an interface that you would like to lock then select **LOCKED**.

---

**NOTE:** Setting the **USB Interface** to **LOCKED** also locks and hides the **External Ports** and other devices included under **USB Interface Security**.



---

## Set Master Password

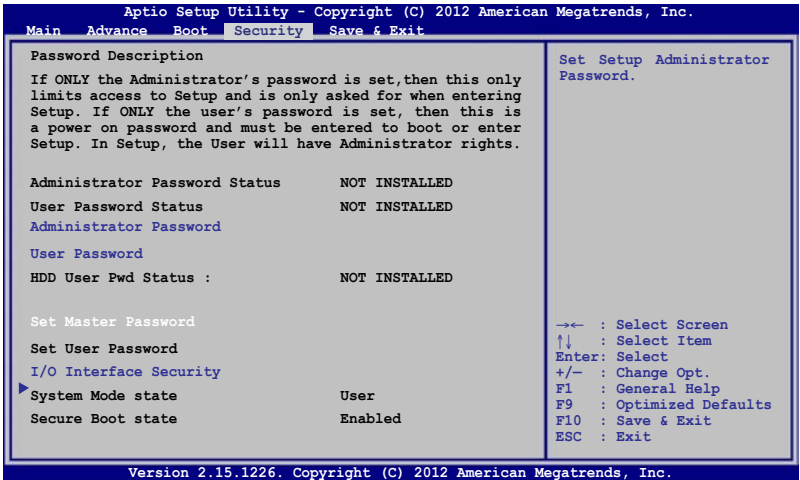
In the Security menu, you can use **Set Master Password** to set up a password-enabled access to your hard disk drive.



To set the HDD password:

1. On the **Security** screen, select **Set Master Password**.
2. Type in a password then press .
3. Re-type to confirm the password then press .
4. Select **Set User Password** then repeat the previous steps to set up the user password.



## Save & Exit

To keep your configuration settings, select **Save Changes and Exit** before exiting the BIOS.

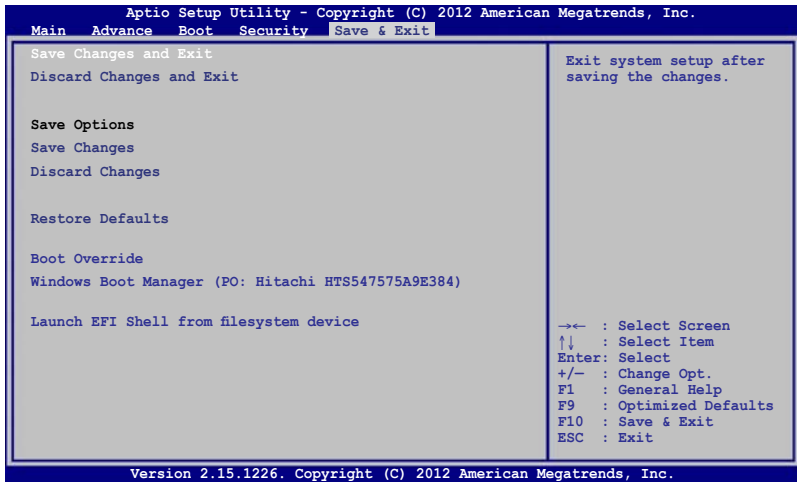

## To update the BIOS:

1. Verify the Notebook PC's exact model then download the latest BIOS file for your model from the ASUS website.
2. Connect your flash disk drive to the Notebook PC and turn on your Notebook PC.

- From the BIOS menu, Select **Advanced > Start Easy Flash**, then press .

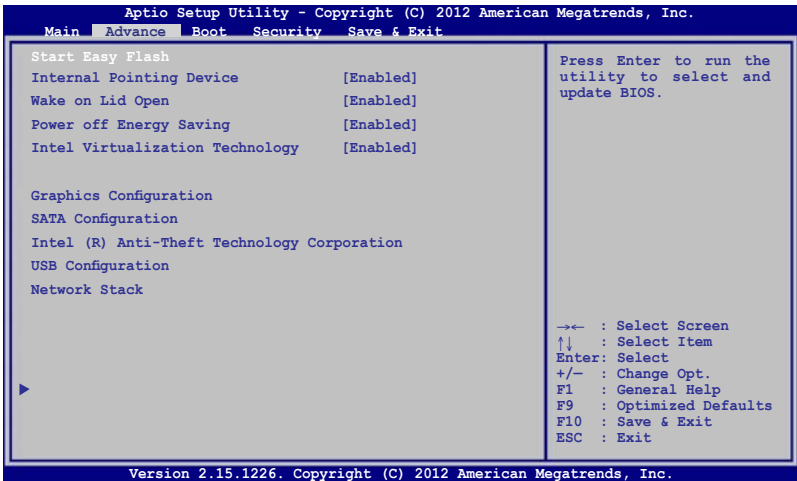

- Locate the latest BIOS file then start updating the BIOS.

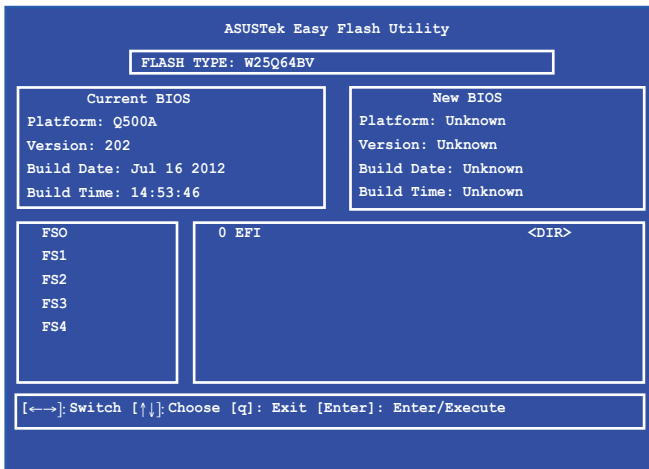

- After the BIOS update process, select **Exit > Restore Defaults** to restore the system to its default settings.

## Gestures for the touchpad

Gestures allow you to launch programs and access the settings of your Notebook PC. Refer to the following illustrations when using hand gestures on your touchpad.

### Moving the pointer

You can tap or click anywhere on the touchpad to activate its pointer, then slide your finger on the touchpad to move the pointer onscreen.

#### Slide horizontally

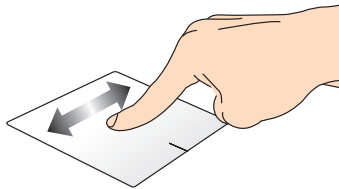

#### Slide vertically

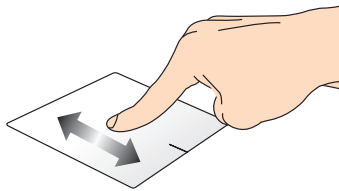

#### Slide diagonally

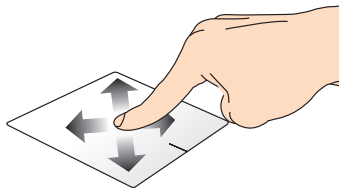

# One-finger gestures

## Tap/Double tap

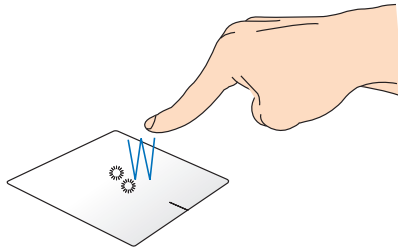

- In the Metro Start screen, tap an app to launch it.
- In Desktop mode, double-tap an item to launch it.

## Left-click

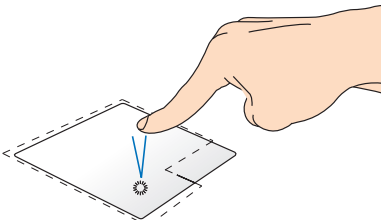

- In the Metro Start screen, click an app to launch it.
- In Desktop mode, double-click an item to launch it.

## Right-click

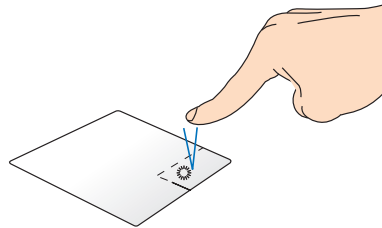

- In the Metro Start screen, click an app to select it and launch the settings bar. You can also press this button to launch the **All Apps** bar.
- In Desktop mode, use this button to open the right-click menu.

---

**NOTE:** The areas inside the dotted line represent the locations of the left mouse button and the right mouse button on the touchpad.

---

## Drag and drop

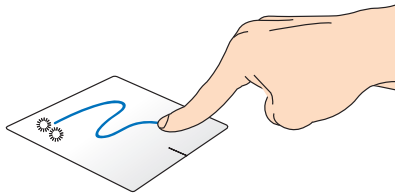

Double-tap an item, then slide the same finger without lifting it off the touchpad. To drop the item to its new location, lift your finger from the touchpad.

## Top edge swipe

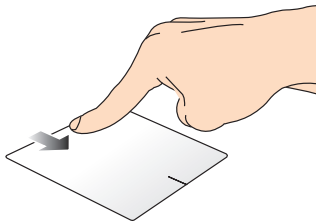

- In the Metro Start screen, swipe from the top edge to launch the **All Apps** bar.
- In a running app, swipe from the top edge to view its menu.

## Left edge swipe

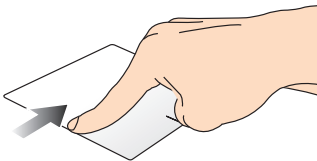

Swipe from the left edge to launch the running apps.

## Right edge swipe

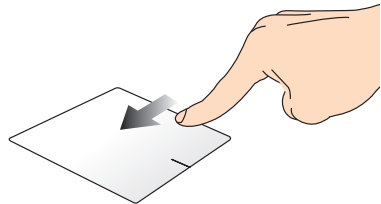

Swipe the right edge to launch the Charm bar.

# Two-finger gestures

## Tap

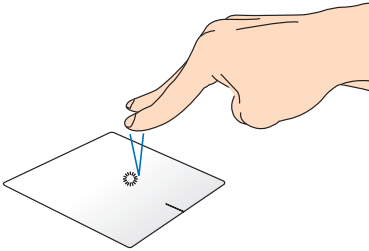

Tap two fingers on the touchpad to simulate the right-click function.

## Rotate

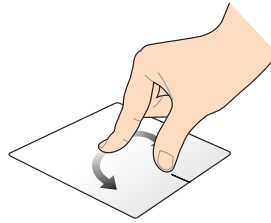

To rotate an image, place two fingers on the touchpad then turn one finger clockwise or counterclockwise while the other stays still.

## Two-finger scroll (up/down)

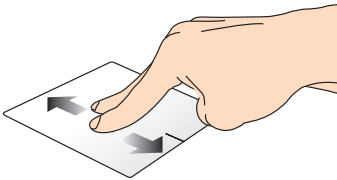

Slide two fingers to scroll up or down.

## Two-finger scroll (left/right)

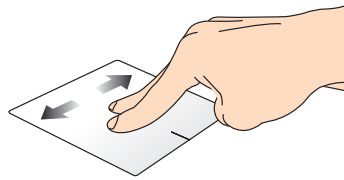

Slide two fingers to scroll left or right.

## Zoom out

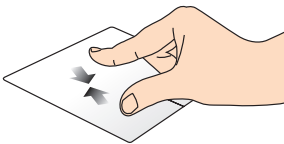

Bring together your two fingers on the touchpad.

## Zoom in

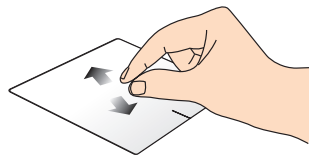

Spread apart your two fingers on the touchpad.

## Drag and drop

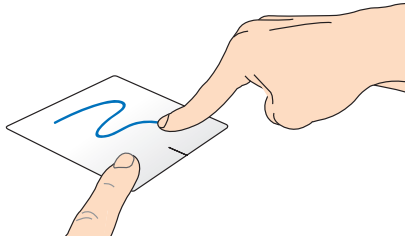

Select an item then press and hold the left mouse button. Using your other finger, slide down the touchpad to drag and drop the item to a new location.

## Three-finger gestures

### Swipe up

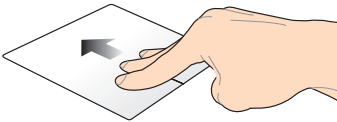

Swipe three fingers upward to show all running applications.

### Swipe down

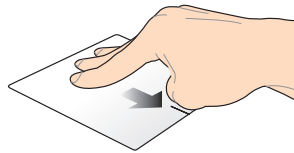

Swipe three fingers downward to show the Desktop mode.

# Using the keyboard

## Function keys

The function keys on your Notebook PC's keyboard can trigger actions inside the Metro Start screen and desktop mode of Windows®.



 +  Puts the Notebook PC into **Sleep mode**



 +  Turns **Airplane mode** on or off

---

**NOTE:** When enabled, the **Airplane mode** disables all wireless connectivity.



---

 +  **(on selected models)** Decreases keyboard brightness for Notebook PC models with a backlit keyboard

 +  **(on selected models)** Increases keyboard brightness for Notebook PC models with a backlit keyboard

 +  Decreases display brightness

 +  Increases display brightness



 +  Turns the display panel off

 +  Activates the second screen

---

**NOTE:** Ensure that the second screen is connected to your Notebook PC.

---

 +  Enables or disables the touchpad





Turns the speaker on or off



Turns the speaker volume down



Turns the speaker volume up

## Function keys for ASUS Apps

Your Notebook PC also comes with a special set of function keys that can be used to launch ASUS apps.



**Toggles the ASUS Splendid Video Enhancement Technology app** to switch between these display color enhancement modes: Gamma Correction, Vivid Mode, Theater Mode, Soft Mode, My Profile, and Normal.



**Launches the ASUS LifeFrame app**



**Launches the ASUS Power4Gear Hybrid app**

## Windows® 8 keys

There are two special Windows® keys on your Notebook PC's keyboard used as below:



Press this key to go back to the Metro Start screen. If you are already in the Metro Start screen, press this key to go back to the last app you opened.



Press this key to simulate the right-click functions.

## Multimedia control keys

The multimedia control keys allow you to control multimedia files, such as audios and videos, when played in your Notebook PC.

Press  in combination with the arrow keys on your Notebook PC, illustrated as below.

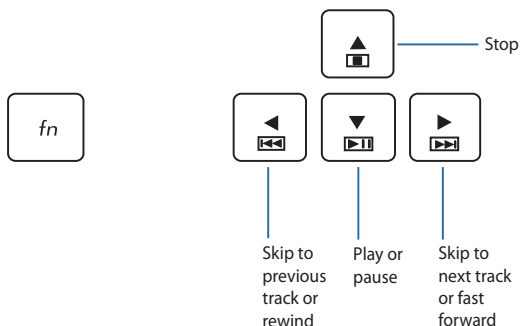

## Numeric keypad (on selected models)

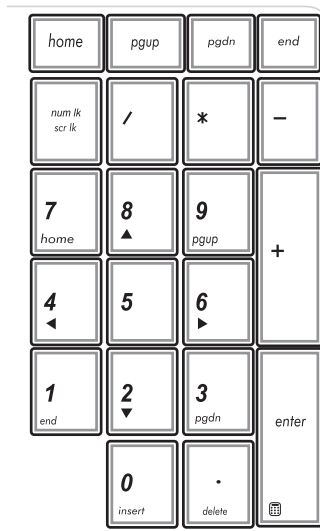

A numeric keypad is available on selected Notebook PC models. You can use this keypad for numeric input or as pointer direction keys.



Press  +  to

toggle between using the keypad as number keys or as pointer direction keys.

# Using the optical drive (on selected models)

**NOTE:** The actual location of the electronic eject button may vary depending on your Notebook PC model.

## Inserting an optical disc

1. While the Notebook PC is on, press the drive's eject button to partially eject the drive's tray.

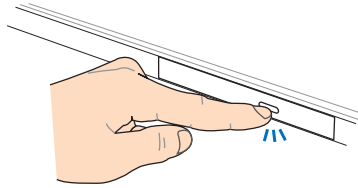

2. Gently pull out the drive tray.

**IMPORTANT!** Be careful not to touch the optical drive lens. Ensure that there are no objects that may get jammed under the drive tray.

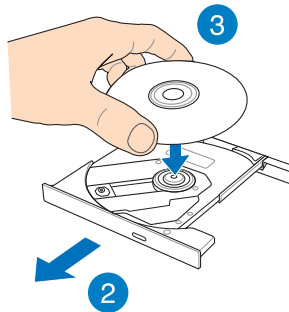

3. Hold the disc by the edge, with its printed side up, then gently place it inside the hub.

4. Push down the disc's plastic hub until it snaps onto the optical drive hub.

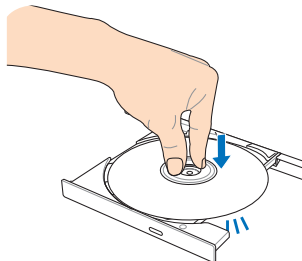

5. Push the drive tray gently to close the optical drive.

---

**NOTE:** While data is being read, it is normal to hear some spinning and vibrating in the optical drive.

---

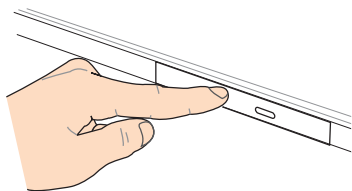

## Manual eject hole

The manual eject hole is located on the optical drive door and is used to eject the optical drive tray in case the electronic eject button does not work.

To manually eject the optical drive tray, insert a straightened paper clip into the manual eject hole until the drive tray opens.

---

**WARNING!** Use the manual eject hole only when the electronic eject button does not work.

---

# ***Chapter 3:*** ***Working with Windows® 8***

## Starting for the first time

When you start your computer for the first time, a series of screens appear to guide you in configuring the basic settings of your Windows® 8 operating system.

To start your Notebook PC for the first time:

1. Press the power button on your Notebook PC. Wait for a few minutes until the setup screen appears.
2. Pick a language to use on your Notebook PC.
3. Carefully read the License Terms. Tick **I accept the terms for using Windows** then click **Accept**.
4. Follow the onscreen instructions to configure the following basic items:
  - Keep your PC secure
  - Personalize
  - Wireless
  - Settings
  - Sign in to your PC
5. Once you are done configuring the basic items, a Windows® 8 tutorial appears. Watch this to learn more about Windows®8 functionalities.
6. The Metro Start screen appears after successfully signing in to your user account.

## Windows® 8 lock screen

The Windows®8 lock screen may appear when your Notebook PC enters the Windows®8 operating system. To proceed, tap on the lock screen or press any key on your Notebook PC's keyboard.

# Metro style UI

The Metro style user interface (UI) is the tile-based display used in Windows® 8. It includes the following features you can use while working on your Notebook PC.

## Metro Start screen

The Metro Start screen appears after successfully signing in to your user account. It helps organize all the applications you need in just one place.

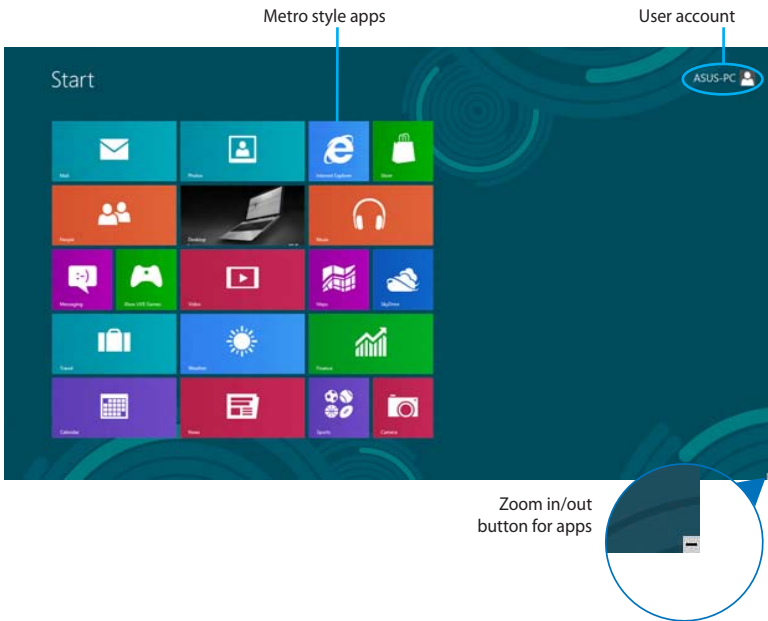

## Metro Style App

These are apps pinned on the Metro Start screen and displayed on tiled-format for easy access.

---

**NOTE:** Some apps require signing in to your Microsoft account before they are fully launched.

---

## Hotspots

Onscreen hotspots allow you to launch programs and access the settings of your Notebook PC. The functions in these hotspots can be activated using the touchpad.

### Hotspots on a running app

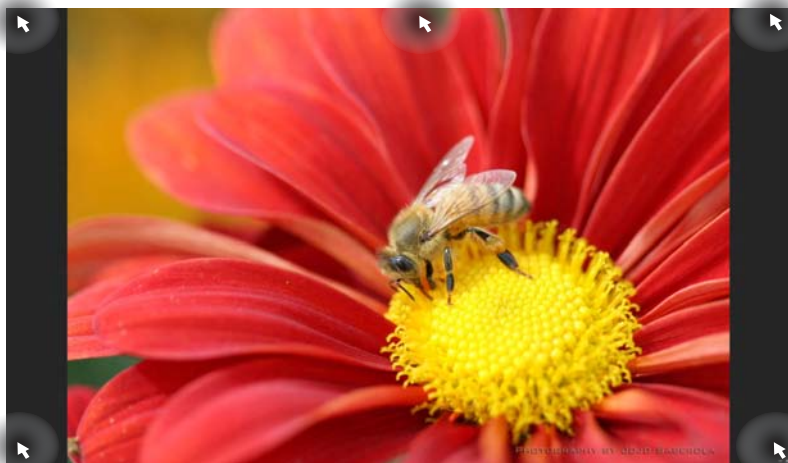

### Hotspots on the Metro Start screen

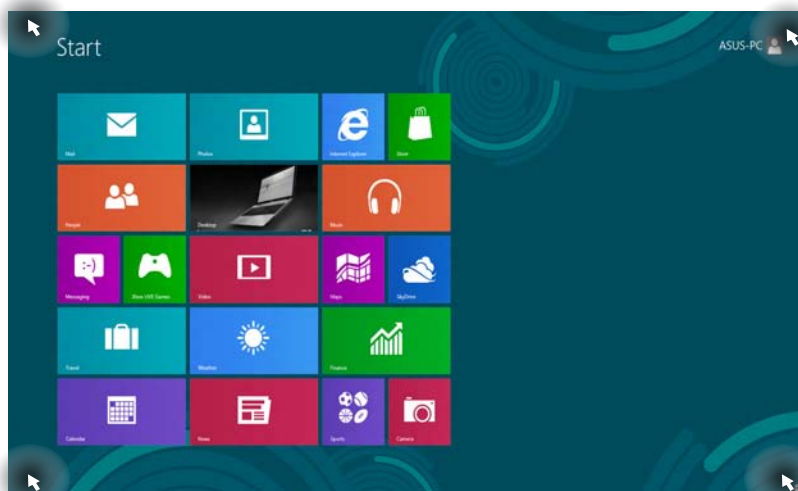



Hotspot	Action
<b>upper left corner</b>	<p>Hover your mouse pointer then tap on the recent app's thumbnail to revert back to that running app.</p> <hr/> <p>If you launched more than one app, slide down to show all running apps.</p> <hr/>
<b>lower left corner</b>	<p>From a running app screen:</p> <p>Hover your mouse pointer then tap on the Metro Start screen's thumbnail to go back to the Metro Start screen.</p> <hr/> <p><b>NOTE:</b> You can also press the Windows key  on your keyboard to go back to the Metro Start screen.</p> <hr/> <p>From the Metro Start screen:</p> <p>Hover your mouse pointer then tap on the running app's thumbnail to go back to that app.</p> <hr/>
<b>top side</b>	<p>Hover your mouse pointer until it changes to a hand icon. Drag then drop the app to a new location.</p> <hr/> <p><b>NOTE:</b> This hotspot function only works on a running app or when you want to use the Snap feature. For more details, refer to the Snap feature under the <i>Working with Metro Apps</i> section in this manual.</p> <hr/>
<b>upper and lower right corner</b>	<p>Hover your mouse pointer to launch the Charm bar.</p> <hr/>

# Working with Metro Style apps



Use your Notebook PC's touchpad or keyboard to launch and customize your apps.

## Launching apps



Position your mouse pointer over the app then left-click or tap once to launch it.



Press  twice then use the arrow keys to browse through the apps. Press  to launch the app you chose.

## Customizing apps

You can move, resize, or unpin apps from the Metro Start screen using the following steps.

### Moving apps



To move an app, double-tap on the app then drag and drop to a new location.

### Resizing apps



Right-click on the app to activate its settings bar then tap



### Unpinning apps



To unpin an app from the Metro Start screen, right-click on the app to activate its settings then tap





## Closing apps



1. Move your mouse pointer on the top side of the launched app then wait for the pointer to change to a hand icon.
2. Drag then drop the app to the bottom of the screen to close it.



From the running app's screen, press  + .



## Pinning more apps on the Metro Start screen

You can pin more apps on the Metro Start screen using your touchpad.



1. Position the mouse pointer over the app you want to pin on the Metro Start screen.
2. Right-click on the app to activate its settings.
3. Click on the  icon.



# Charm bar

The Charm bar is a toolbar that can be triggered on the right side of your screen. It consists of several tools that allow you to share applications and provide quick access for customizing the settings of your Notebook PC.



Charm Bar

## Launching the Charm bar

**NOTE:** When called out, the Charm bar initially appears as a set of white icons. The image above shows how the Charm bar looks like once activated.

Use your Notebook PC's touchpad or keyboard to launch the Charm bar.



Move your mouse pointer on the upper or lower right corner of the screen.



Press  + 

## Inside the Charm bar



### Search

This tool allows you to look for files, applications, or programs in your Notebook PC.



### Share

This tool allows you to share applications via social networking sites or email.



### Start

This tool reverts the display back to the Metro Start screen. From the Metro Start screen, you can also use this to revert back to a recently opened app.



### Devices

This tool allows you to access and share files with the devices attached to your Notebook PC such as an external display or printer.



### Settings

This tool allows you to access the PC settings of your Notebook PC.

## Snap feature

The Snap feature displays two apps side-by-side, allowing you to work or switch between apps.

---

**IMPORTANT!** Ensure that your Notebook PC's screen resolution is set to 1366 x 768 pixels or higher before using the Snap feature.

---



Snap bar





### Using Snap

Perform the following steps to activate Snap using your Notebook PC's touchpad or keyboard.

1. Launch the app you wish to snap.
2. Hover the mouse point on the top side of your screen.
3. Once the pointer changes to a hand icon, drag then drop the app to the left or right side of the display panel.
4. Launch another app.



















1. Launch an app then
2. Press  + .
3. To switch between apps, press  + .

## Other keyboard shortcuts

Using the keyboard, you can also use the following shortcuts to help you launch applications and navigate Windows®8.

-  Switches between the Metro Start screen and the last running app
-  Launches the desktop
-  Launches the **Computer** window on Desktop mode
-  Opens the **File** search pane
-  Opens the **Share** pane
-  Opens the **Settings** pane
-  Opens the **Devices** pane
-  Activates the Lock screen
-  Minimizes the **Internet Explorer** window
-  Opens the **Second screen** pane
-  Opens the **Apps** search pane
-  Opens the **Run** window
-  Opens **Ease of Access Center**
-  Opens the **Settings** search pane
-  Opens a menu box of Windows tools

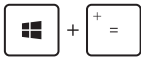

Launches the magnifier icon and zooms in your screen



Zooms out your screen



Opens the **Narrator Settings**



Enables the **print screen** function

## Wi-Fi connection

Access emails, surf the Internet, and share applications via social networking sites using your Notebook PC's Wi-Fi connection.

---

**IMPORTANT!** Ensure the **Airplane mode** is turned off to enable the Wi-Fi function of your Notebook PC. For more details, refer to the *Airplane mode* section in this manual.



---

### Enabling Wi-Fi

Activate Wi-Fi in your Notebook PC using the following steps:



1. Launch the Charm bar.

2. Tap  and tap .

3. Select an access point from the list of available Wi-Fi connections.



4. Tap **Connect** to start the network connection.

---

**NOTE:** You may be prompted to enter a security key to activate the Wi-Fi connection.

---

5. If you want to enable sharing between your Notebook PC and other wireless-enabled systems, tap **Yes, turn on sharing and connect to devices**. Tap **No, don't turn on sharing or connect to devices** if you do not want to enable the sharing function.

# Bluetooth connection

Use Bluetooth to facilitate wireless data transfers with other Bluetooth-enabled devices.

---

**IMPORTANT!** Ensure the **Airplane mode** is turned off to enable the Bluetooth function of your Notebook PC. For more details, refer to the *Airplane mode* section in this manual.

---

## Pairing with other Bluetooth-enabled devices

You need to pair your Notebook PC with other Bluetooth-enabled devices to enable data transfers. To do this, use your or touchpad as follows:

1. Launch the Charm bar.
2. Tap  then tap **Change PC Settings**.
3. Under **PC Settings**, select **Devices** then tap **Add a Device** to search for Bluetooth-enabled devices.

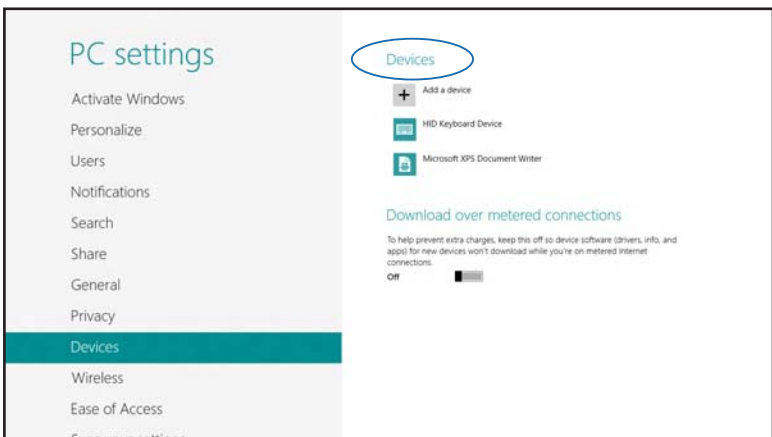

4. Select a device from the list. Compare the passcode on your Notebook PC with the passcode sent to your chosen device. If they are the same, tap **Yes** to successfully pair your Notebook PC with the device.

---

**NOTE:** For some bluetooth-enabled devices, you may be prompted to key in the passcode of your Notebook PC.

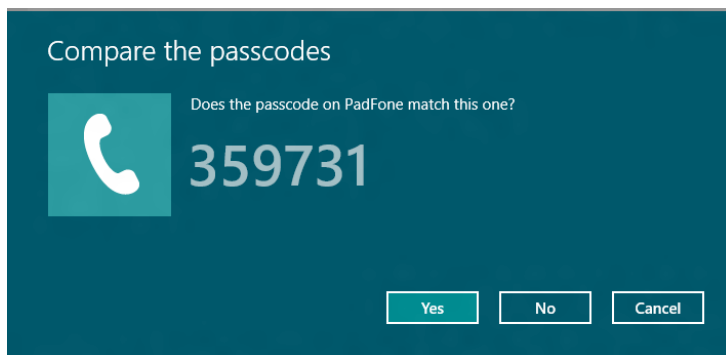

---



# Airplane mode



The **Airplane mode** disables wireless communication, allowing you to use your Notebook PC safely while in-flight.

## Turning Airplane mode on

1. Launch the Charm bar.
2. Tap  and tap .
3. Move the slider to the right to turn the Airplane mode on.

 Press  + .

## Turning Airplane mode off

1. Launch the Charm bar.
2. Tap  and tap .
3. Move the slider to the left to turn the Airplane mode off.

 Press  + .

---

**NOTE:** Contact your airline provider to learn about related inflight services that can be used and restrictions that must be followed when using your Notebook PC in-flight.

---

# Remove everything and reinstall Windows

Restoring your Notebook PC to its original factory settings is done using the **Remove everything and reinstall** option in PC Settings. Refer to the steps below to enable this option:

---

**IMPORTANT!** Back up all your data before performing this option.

---

**NOTE:** This process may take a while to complete.

---

1. Launch the Charm bar.
2. Tap  > **Change PC Settings >General.**
3. Scroll down to view the **Remove everything and reinstall Windows** option. Under this option, click **Get Started.**

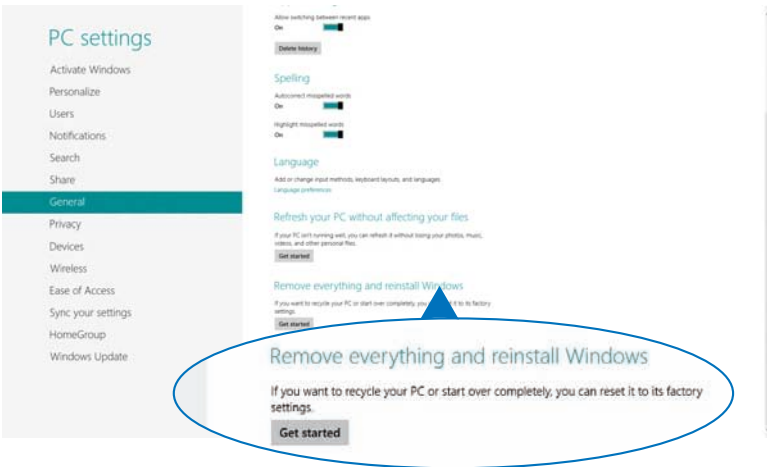

4. Follow the onscreen instructions to complete the reinstallation and reset process.



## Turning your Notebook PC off

You can shut down your Notebook PC by doing either of the following:



- Tap  from the Charm bar then tap  >

**Shut down** to do a normal shutdown.

- From the log-in screen, tap  > **Shut down.**
- If your Notebook PC is unresponsive, press and hold the power button for at least four (4) seconds until your Notebook PC turns off.

## Putting your Notebook PC to sleep

To put your Notebook PC on Sleep mode, press the power button once.



## ***Chapter 4:*** ***ASUS apps***

# Featured ASUS Apps

## LifeFrame

Enhance your webcam functions through the LifeFrame app. Create snapshots, edit photos, record videos, record audio files, use your webcam as a security monitoring device, and play games using this app.

### To launch LifeFrame

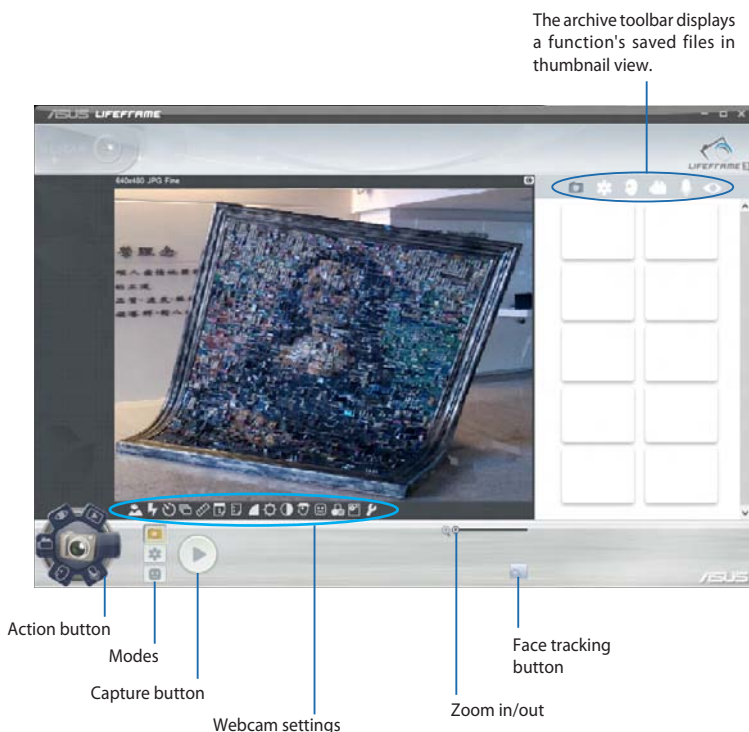

## LifeFrame functions



### Camera

Use this function to take pictures using your webcam.



### Camcorder

Use this function to take videos through your webcam.



### Monitor

This function lets you use your webcam as a security video monitor as it automatically detects movement then captures it on photo.



### Voice Recorder

Use this function to record audio files in your Notebook PC.



### Game

This function lets you play games using the webcam.

## Power4Gear Hybrid

Optimize the performance of your Notebook PC using the power saving modes in Power4Gear.

---

**NOTE:** Unplugging the Notebook PC from its power adapter automatically switches Power4Gear Hybrid to Battery Saving mode.

---

### To launch Power4Gear Hybrid



Press **fn** + **[F4]** .

Select from these power saving modes.



Use these options to customize your power saving mode.

Allows you to hide the desktop icons onscreen and turns the presentation mode on or off.

### Performance mode

Use this mode when doing high-performance activities like playing games or conducting business presentations using your Notebook PC.

### Battery Saving mode

This mode extends your Notebook PC's battery life while plugged in to the power adapter or while running on battery power only.

## USB Charger+

USB Charger+ allows you to quick charge mobile devices via your ASUS Notebook PC's USB charge port.

This feature can also be used even while your Notebook PC is on sleep, hibernate, or shutdown mode (available on selected models only).

---

**NOTE:** USB Charger+ is available in your USB 3.0 charge port with the  icon.

---

---

**WARNING:** If your connected device overheats, remove it immediately.

---

## Using the USB Charger+ Settings

The USB Charger+ Settings lets you set the charge limit when your ASUS Notebook PC is running on battery power and allows you to charge devices while your Notebook PC is on sleep, hibernate, or shutdown mode.

1. Right-click on the USB Charger+ icon  on the desktop tray, then click **Settings**.
2. Tick **Enable USB Charger+ in battery mode**.



3. Select one or both of these charging options:  
**Enable quick charge when the system is running** or **Enable quick charge when the system is in sleep/hibernate/shutdown mode.**
4. Move the percentage slider to the left or to the right to set the limit for charging devices.
5. Tap **OK** to save the settings made. Otherwise, tap **Cancel**.

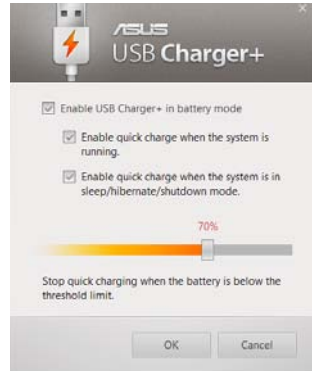

---

**NOTE:** On some models, the USB Charger+ automatically selects both options. You can deselect these two options, if necessary.

---



## Instant On

Save battery power while your Notebook PC is on deep sleep mode (Deep S3) using Instant On.

---

**NOTE:** Deep S3 is a technology that lets you save more battery power while your ASUS Notebook PC is on sleep mode.

---

**IMPORTANT!** The standby time varies according to your Notebook PC's remaining battery capacity, computer model, configuration, and operating conditions.

---

## Performance mode

This mode is default-enabled in your Notebook PC. It allows the system to return to its last working state in two seconds, even after your Notebook PC has entered into deep sleep mode.



## Battery saving mode

This mode enables longer standby times allowing the battery to last for up to thirty (30) days or more. When enabled, the Notebook PC returns to its last working state in as fast as seven seconds, four hours after entering into deep sleep mode.

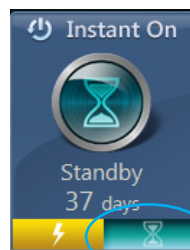

 Click this to activate the battery saving mode.



# ***Chapter 5:*** ***Upgrading your Notebook PC***

## Installing a Random Access Memory (RAM) module

**NOTE:** Visit an authorized service center or retailer for information on memory upgrades for your Notebook PC. Only purchase expansion modules from authorized retailers of this Notebook PC to ensure maximum compatibility and reliability.

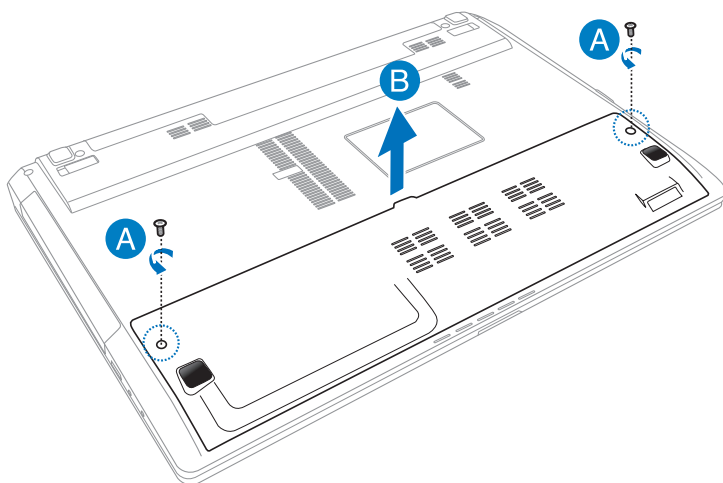

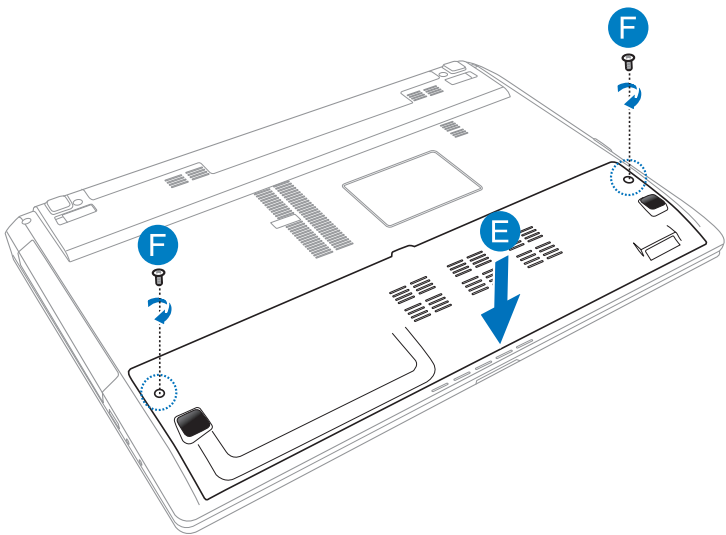
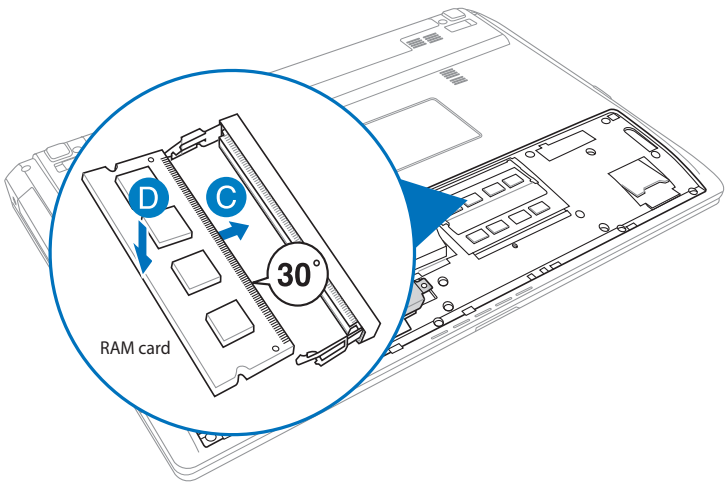

## Replacing the Hard Disk Drive (HDD)

**WARNING!** Disconnect all the connected peripherals, any telephone or telecommunication lines and power connector (such as external power supply, battery pack, etc.) before removing the hard disk cover.

**IMPORTANT!** When replacing or upgrading the hard drive, always visit an authorized service center or retailer for this Notebook PC.

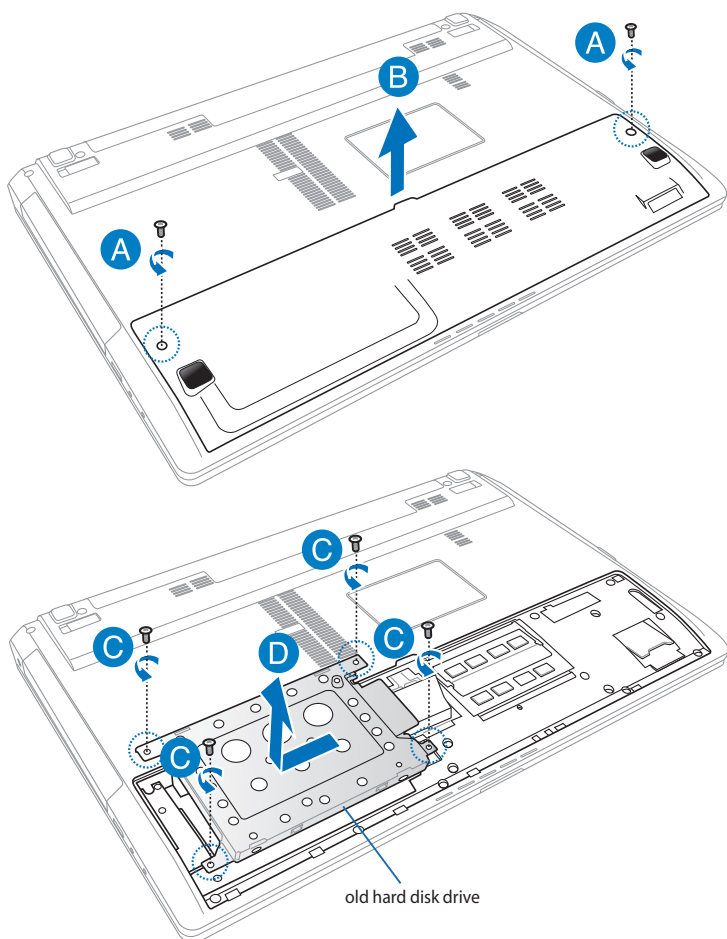

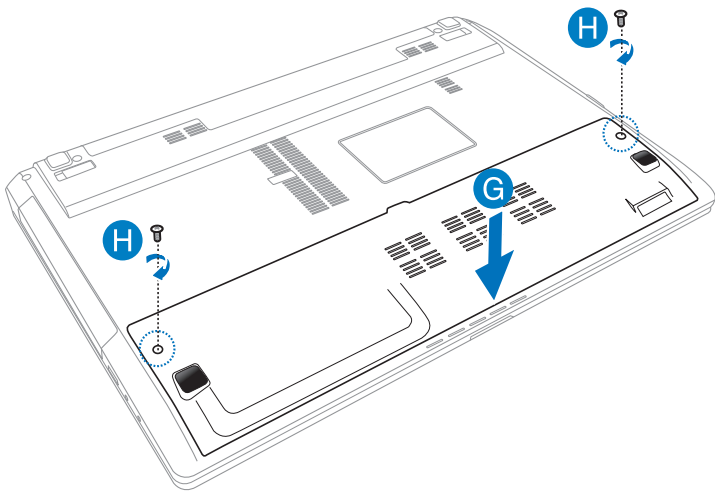
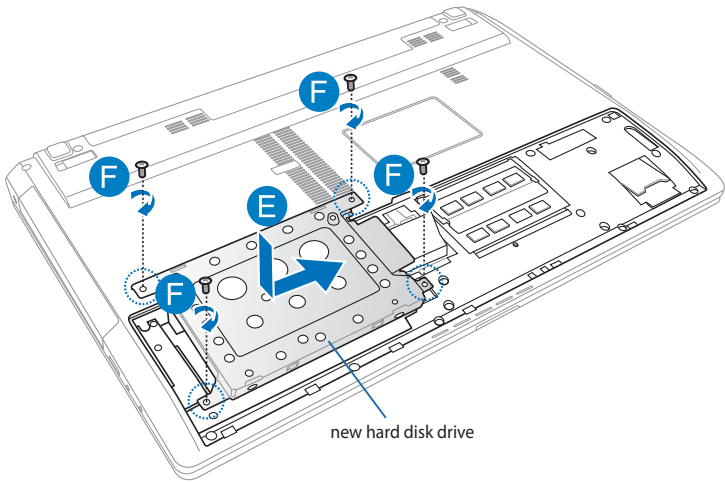

## Replacing the battery pack

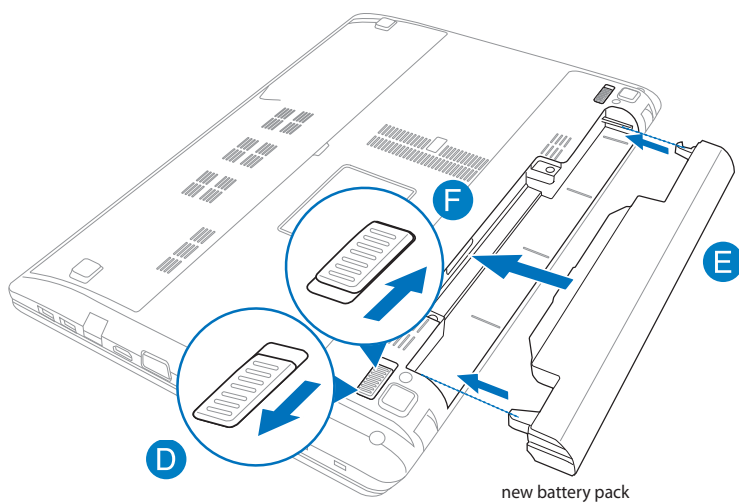
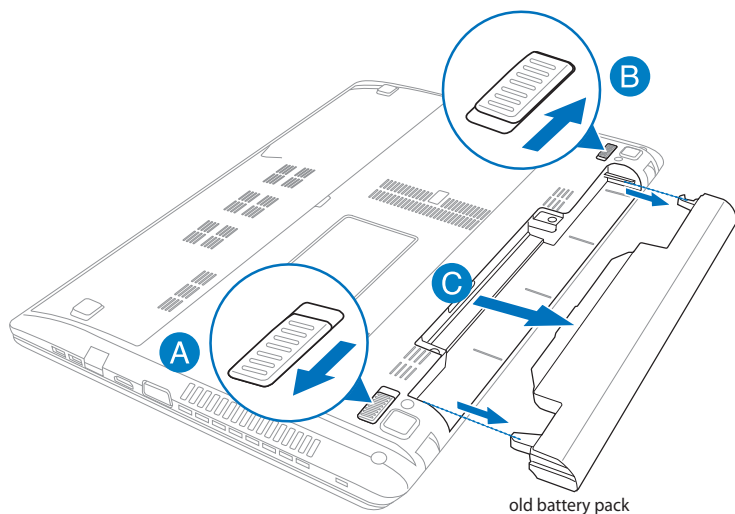



# ***Chapter 6:*** ***Troubleshooting your*** ***Notebook PC***

Issue	Solutions
<p><b>My optical disc drive cannot read from or write to discs.</b></p>	<p>Update the BIOS to the latest version then try again. If the problem still exists, contact your local service center for assistance.</p>
<p><b>My Notebook PC does not wake up from sleep or hibernate mode.</b></p>	<ul style="list-style-type: none"> <li>• Remove upgraded parts such as RAM cards, the hard disk drive (HDD), or WLAN/Bluetooth modules if they were purchased separately from your Notebook PC.</li> <li>• Run <b>Remove everything and reinstall Windows</b> to restore the system to its factory default settings.</li> </ul> <hr/> <p><b>IMPORTANT!</b> Back up all your data to another location before restoring your Notebook PC to its factory settings.</p> <hr/> <ul style="list-style-type: none"> <li>• If the problem still exists, contact your local ASUS Service Center for assistance.</li> </ul>
<p><b>The function keys do not work.</b></p>	<p>Reinstall the “ATK0100” driver from the driver CD or download it from the ASUS website.</p>
<p><b>My built-in camera is not working properly.</b></p>	<p>Try reinstalling the webcam driver. You can also try updating the BIOS to the latest version. If the problem still exists, contact your local ASUS service center for assistance.</p>

Issue	Solutions
<p><b>My Notebook PC does not turn on.</b></p>	<ul style="list-style-type: none"> <li>• Check the power cord connections.</li> <li>• Check if the battery pack is properly aligned at the notches and fitted completely into the battery slot.</li> <li>• If your Notebook PC is connected to the power adapter but does not load the BIOS or the operating system, the problem might be in the Notebook PC's hard disk drive. Contact your local ASUS Service Center for assistance.</li> </ul>
<p><b>My Notebook PC displays an "Open policy file error" message when I turn it on.</b></p>	<p>Download the latest Power4Gear utility from the ASUS website and reinstall it in your Notebook PC.</p>
<p><b>My Notebook PC gets too hot even when the cooling fan is working. How do I solve this?</b></p>	<ul style="list-style-type: none"> <li>• Ensure that nothing blocks any of the air vents while using your Notebook PC.</li> <li>• Close some running applications to decrease the system's load.</li> <li>• Check your system for viruses.</li> <li>• Try restoring your system to its original factory settings.</li> </ul> <hr/> <p><b>IMPORTANT!</b> Back up all your data to another location before restoring your Notebook PC to its factory settings.</p> <hr/>



# *Appendices*

## DVD-ROM Drive Information (on selected models)

The DVD-ROM drive allows you to view and create your own CDs and DVDs. You can purchase an optional DVD viewer software to view DVD titles.

### Regional Playback Information

Playback of DVD movie titles involves decoding MPEG2 video, digital AC3 audio and decryption of CSS protected content. CSS (sometimes called copy guard) is the name given to the content protection scheme adopted by the motion picture industry to satisfy a need to protect against unlawful content duplication.

Although the design rules imposed on CSS licensors are many, one rule that is most relevant is playback restrictions on regionalized content. In order to facilitate geographically staggered movie releases, DVD video titles are released for specific geographic regions as defined in "Region Definitions" below. Copyright laws require that all DVD movies be limited to a particular region (usually coded to the region at which it is sold). While DVD movie content may be released for multiple regions, CSS design rules require that any system capable of playing CSS encrypted content must only be capable of playing one region.

---

**IMPORTANT!** The region setting may be changed up to five times using the viewer software, then it can only play DVD movies for the last region setting. Changing the region code after that will require factory resetting which is not covered by warranty. If resetting is desired, shipping and resetting costs will be at the expense of the user.

---

## Region Definitions

### Region 1

Canada, US, US Territories

### Region 2

Czech, Egypt, Finland, France, Germany, Gulf States, Hungary, Iceland, Iran, Iraq, Ireland, Italy, Japan, Netherlands, Norway, Poland, Portugal, Saudi Arabia, Scotland, South Africa, Spain, Sweden, Switzerland, Syria, Turkey, UK, Greece, Former Yugoslav Republics, Slovakia

### Region 3

Burma, Indonesia, South Korea, Malaysia, Philippines, Singapore, Taiwan, Thailand, Vietnam

### Region 4

Australia, Caribbean (Except US Territories), Central America, New Zealand, Pacific Islands, South America

### Region 5

CIS, India, Pakistan, Rest of Africa, Russia, North Korea

### Region 6

China

## Blu-ray ROM Drive Information (on selected models)

The Blu-ray ROM Drive allows you to view high definition (HD) videos and other disc file formats such as DVDs and CDs.

### Region Definitions

#### Region A

North, Central and South American countries, and their territories; Taiwan, Hong Kong, Macao, Japan, Korea (South and North), South East Asian countries and their territories.

#### Region B

European, African, and South West Asian countries and their territories; Australia and New Zealand.

#### Region C

Central, South Asian, Eastern European countries and their territories; China and Mongolia.

---

**NOTE:** Refer to Blu-ray Disc website at [www.blu-raydisc.com/en/Technical/FAQs/Blu-rayDiscforVideo.html](http://www.blu-raydisc.com/en/Technical/FAQs/Blu-rayDiscforVideo.html) for more details.

---



## Internal Modem Compliancy

The Notebook PC with internal modem model complies with JATE (Japan), FCC (US, Canada, Korea, Taiwan), and CTR21. The internal modem has been approved in accordance with Council Decision 98/482/EC for pan-European single terminal connection to the public switched telephone network (PSTN). However due to differences between the individual PSTNs provided in different countries, the approval does not, of itself, give an unconditional assurance of successful operation on every PSTN network termination point. In the event of problems you should contact your equipment supplier in the first instance.

### Overview

on 4th August 1998 the European Council Decision regarding the CTR 21 has been published in the Official Journal of the EC. The CTR 21 applies to all non voice terminal equipment with DTMF-dialling which is intended to be connected to the analogue PSTN (Public Switched Telephone Network).

CTR 21 (Common Technical Regulation) for the attachment requirements for connection to the analogue public switched telephone networks of terminal equipment (excluding terminal equipment supporting the voice telephony justified case service) in which network addressing, if provided, is by means of dual tone multifrequency signalling.

### Network Compatibility Declaration

Statement to be made by the manufacturer to the Notified Body and the vendor: "This declaration will indicate the networks with which the equipment is designed to work and any notified networks with which the equipment may have inter-working difficulties"

## Network Compatibility Declaration

Statement to be made by the manufacturer to the user: "This declaration will indicate the networks with which the equipment is designed to work and any notified networks with which the equipment may have inter-working difficulties. The manufacturer shall also associate a statement to make it clear where network compatibility is dependent on physical and software switch settings. It will also advise the user to contact the vendor if it is desired to use the equipment on another network."

Up to now the Notified Body of CETECOM issued several pan-European approvals using CTR 21. The results are Europe's first modems which do not require regulatory approvals in each individual European country.

## Non-Voice Equipment

Answering machines and loud-speaking telephones can be eligible as well as modems, fax machines, auto-dialers and alarm systems. Equipment in which the end-to-end quality of speech is controlled by regulations (e.g. handset telephones and in some countries also cordless telephones) is excluded.

**This table shows the countries currently under the CTR21 standard.**

<b>Country</b>	<b>Applied</b>	<b>More Testing</b>
Austria <sup>1</sup>	Yes	No
Belgium	Yes	No
Czech Republic	No	Not Applicable
Denmark <sup>1</sup>	Yes	Yes
Finland	Yes	No
France	Yes	No
Germany	Yes	No
Greece	Yes	No
Hungary	No	Not Applicable
Iceland	Yes	No
Ireland	Yes	No
Italy	Still Pending	Still Pending
Israel	No	No
Lichtenstein	Yes	No
Luxemburg	Yes	No
The Netherlands <sup>1</sup>	Yes	Yes
Norway	Yes	No
Poland	No	Not Applicable
Portugal	No	Not Applicable
Spain	No	Not Applicable
Sweden	Yes	No
Switzerland	Yes	No
United Kingdom	Yes	No

This information was copied from CETECOM and is supplied without liability. For updates to this table, you may visit [http://www.cetecom.de/technologies/ctr\\_21.html](http://www.cetecom.de/technologies/ctr_21.html)

1 National requirements will apply only if the equipment may use pulse dialling (manufacturers may state in the user guide that the equipment is only intended to support DTMF signalling, which would make any additional testing superfluous).

In The Netherlands additional testing is required for series connection and caller ID facilities.

## **Federal Communications Commission Statement**

This device complies with FCC Rules Part 15. Operation is subject to the following two conditions:

- This device may not cause harmful interference.
- This device must accept any interference received, including interference that may cause undesired operation.

This equipment has been tested and found to comply with the limits for a class B digital device, pursuant to Part 15 of the Federal Communications Commission (FCC) rules. These limits are designed to provide reasonable protection against harmful interference in a residential installation. This equipment generates, uses, and can radiate radio frequency energy and, if not installed and used in accordance with the instructions, may cause harmful interference to radio communications. However, there is no guarantee that interference will not occur in a particular installation. If this equipment does cause harmful interference to radio or television reception, which can be determined by turning the equipment off and on, the user is encouraged to try to correct the interference by one or more of the following measures:

- Reorient or relocate the receiving antenna.
- Increase the separation between the equipment and receiver.
- Connect the equipment into an outlet on a circuit different from that to which the receiver is connected.
- Consult the dealer or an experienced radio/TV technician for help.

---

**WARNING!** The use of a shielded-type power cord is required in order to meet FCC emission limits and to prevent interference to the nearby radio and television reception. It is essential that only the supplied power cord be used. Use only shielded cables to connect I/O devices to this equipment. You are cautioned that changes or modifications not expressly approved by the party responsible for compliance could void your authority to operate the equipment.

---

(Reprinted from the Code of Federal Regulations #47, part 15.193, 1993. Washington DC: Office of the Federal Register, National Archives and Records Administration, U.S. Government Printing Office.)

## FCC Radio Frequency (RF) Exposure Caution Statement

---

**WARNING!** Any changes or modifications not expressly approved by the party responsible for compliance could void the user's authority to operate this equipment. "The manufacture declares that this device is limited to Channels 1 through 11 in the 2.4GHz frequency by specified firmware controlled in the USA."

---

This equipment complies with FCC radiation exposure limits set forth for an uncontrolled environment. To maintain compliance with FCC RF exposure compliance requirements, please avoid direct contact to the transmitting antenna during transmitting. End users must follow the specific operating instructions for satisfying RF exposure compliance.

### Declaration of Conformity

#### (R&TTE directive 1999/5/EC)

The following items were completed and are considered relevant and sufficient:

- Essential requirements as in [Article 3]
- Protection requirements for health and safety as in [Article 3.1a]
- Testing for electric safety according to [EN 60950]
- Protection requirements for electromagnetic compatibility in [Article 3.1b]
- Testing for electromagnetic compatibility in [EN 301 489-1] & [EN 301 489-17]
- Effective use of the radio spectrum as in [Article 3.2]
- Radio test suites according to [EN 300 328-2]

## CE Marking



### **CE marking for devices without wireless LAN/Bluetooth**

The shipped version of this device complies with the requirements of the EEC directives 2004/108/EC “Electromagnetic compatibility” and 2006/95/EC “Low voltage directive”.



### **CE marking for devices with wireless LAN/ Bluetooth**

This equipment complies with the requirements of Directive 1999/5/EC of the European Parliament and Commission from 9 March, 1999 governing Radio and Telecommunications Equipment and mutual recognition of conformity.

## IC Radiation Exposure Statement for Canada

This equipment complies with IC radiation exposure limits set forth for an uncontrolled environment. To maintain compliance with IC RF exposure compliance requirements, please avoid direct contact to the transmitting antenna during transmitting. End users must follow the specific operating instructions for satisfying RF exposure compliance.

Operation is subject to the following two conditions:

- This device may not cause interference and
- This device must accept any interference, including interference that may cause undesired operation of the device.

To prevent radio interference to the licensed service (i.e. co-channel Mobile Satellite systems) this device is intended to be operated indoors and away from windows to provide maximum shielding. Equipment (or its transmit antenna) that is installed outdoors is subject to licensing.

## Wireless Operation Channel for Different Domains

N. America	2.412-2.462 GHz	Ch01 through CH11
Japan	2.412-2.484 GHz	Ch01 through Ch14
Europe ETSI	2.412-2.472 GHz	Ch01 through Ch13

## France Restricted Wireless Frequency Bands

Some areas of France have a restricted frequency band. The worst case maximum authorized power indoors are:

- 10mW for the entire 2.4 GHz band (2400 MHz–2483.5 MHz)
- 100mW for frequencies between 2446.5 MHz and 2483.5 MHz

---

**NOTE:** Channels 10 through 13 inclusive operate in the band 2446.6 MHz to 2483.5 MHz.

---

There are few possibilities for outdoor use: on private property or on the private property of public persons, use is subject to a preliminary authorization procedure by the Ministry of Defense, with maximum authorized power of 100mW in the 2446.5–2483.5 MHz band. Use outdoors on public property is not permitted.

In the departments listed below, for the entire 2.4 GHz band:

- Maximum authorized power indoors is 100mW
- Maximum authorized power outdoors is 10mW



Departments in which the use of the 2400–2483.5 MHz band is permitted with an EIRP of less than 100mW indoors and less than 10mW outdoors:

01 Ain	02 Aisne	03 Allier
05 Hautes Alpes	08 Ardennes	09 Ariège
11 Aude	12 Aveyron	16 Charente
24 Dordogne	25 Doubs	26 Drôme
32 Gers	36 Indre	37 Indre et Loire
41 Loir et Cher	45 Loiret	50 Manche
55 Meuse	58 Nièvre	59 Nord
60 Oise	61 Orne	63 Puy du Dôme
64 Pyrénées Atlantique	66 Pyrénées Orientales	67 Bas Rhin
68 Haut Rhin	70 Haute Saône	71 Saône et Loire
75 Paris	82 Tarn et Garonne	84 Vaucluse
88 Vosges	89 Yonne	90 Territoire de Belfort
94 Val de Marne		

This requirement is likely to change over time, allowing you to use your wireless LAN card in more areas within France. Please check with ART for the latest information ([www.arcep.fr](http://www.arcep.fr))

---

**NOTE:** Your WLAN Card transmits less than 100mW, but more than 10mW.

---

## UL Safety Notices

Required for UL 1459 covering telecommunications (telephone) equipment intended to be electrically connected to a telecommunication network that has an operating voltage to ground that does not exceed 200V peak, 300V peak-to-peak, and 105V rms, and installed or used in accordance with the National Electrical Code (NFPA 70).

When using the Notebook PC modem, basic safety precautions should always be followed to reduce the risk of fire, electric shock, and injury to persons, including the following:

- DO NOT use the Notebook PC near water, for example, near a bath tub, wash bowl, kitchen sink or laundry tub, in a wet basement or near a swimming pool.
- DO NOT use the Notebook PC during an electrical storm. There may be a remote risk of electric shock from lightning.
- DO NOT use the Notebook PC in the vicinity of a gas leak.

Required for UL 1642 covering primary (nonrechargeable) and secondary (rechargeable) lithium batteries for use as power sources in products. These batteries contain metallic lithium, or a lithium alloy, or a lithium ion, and may consist of a single electrochemical cell or two or more cells connected in series, parallel, or both, that convert chemical energy into electrical energy by an irreversible or reversible chemical reaction.

- Do not dispose the Notebook PC battery pack in a fire, as they may explode. Check with local codes for possible special disposal instructions to reduce the risk of injury to persons due to fire or explosion.
- Do not use power adapters or batteries from other devices to reduce the risk of injury to persons due to fire or explosion. Use only UL certified power adapters or batteries supplied by the manufacturer or authorized retailers.

## Power Safety Requirement

Products with electrical current ratings up to 6A and weighing more than 3Kg must use approved power cords greater than or equal to: H05VV-F, 3G, 0.75mm<sup>2</sup> or H05VV-F, 2G, 0.75mm<sup>2</sup>.

## TV Tuner Notices

Note to CATV System Installer—Cable distribution system should be grounded (earthed) in accordance with ANSI/NFPA 70, the National Electrical Code (NEC), in particular Section 820.93, Grounding of Outer Conductive Shield of a Coaxial Cable – installation should include bonding the screen of the coaxial cable to the earth at the building entrance.

## REACH

Complying with the REACH (Registration, Evaluation, Authorization, and Restriction of Chemicals) regulatory framework, we publish the chemical substances in our products at ASUS REACH website at <http://csr.asus.com/english/REACH.htm>.

## Nordic Lithium Cautions (for lithium-ion batteries)

CAUTION! Danger of explosion if battery is incorrectly replaced. Replace only with the same or equivalent type recommended by the manufacturer. Dispose of used batteries according to the manufacturer's instructions. (English)

ATTENZIONE! Rischio di esplosione della batteria se sostituita in modo errato. Sostituire la batteria con un una di tipo uguale o equivalente consigliata dalla fabbrica. Non disperdere le batterie nell'ambiente. (Italian)

**VORSICHT!** Explosionsgefahr bei unsachgemäßen Austausch der Batterie. Ersatz nur durch denselben oder einem vom Hersteller empfohlenem ähnlichen Typ. Entsorgung gebrauchter Batterien nach Angaben des Herstellers. (German)

**ADVARSEL!** Lithiumbatteri - Eksplosionsfare ved fejlagtig håndtering. Udskiftning må kun ske med batteri af samme fabrikat og type. Levér det brugte batteri tilbage til leverandøren. (Danish)

**WARNING!** Explosionsfara vid felaktigt batteribyte. Använd samma batterityp eller en ekvivalent typ som rekommenderas av apparattillverkaren. Kassera använt batteri enligt fabrikantens instruktion. (Swedish)

**VAROITUS!** Paristo voi räjähtää, jos se on virheellisesti asennettu. Vaihda paristo ainoastaan laitevalmistajan suositteluun tyypin. Hävitä käytetty paristo valmistajan ohjeiden mukaisesti. (Finnish)

**ATTENTION!** Il y a danger d'explosion s'il y a remplacement incorrect de la batterie. Remplacer uniquement avec une batterie du même type ou d'un type équivalent recommandé par le constructeur. Mettre au rebut les batteries usagées conformément aux instructions du fabricant. (French)

**ADVARSEL!** Eksplosjonsfare ved feilaktig skifte av batteri. Benytt samme batteritype eller en tilsvarende type anbefalt av apparatfabrikanten. Brukte batterier kasseres i henhold til fabrikantens instruksjoner. (Norwegian)

標準品以外の使用は、危険の元になります。交換品を使用する場合、製造者に指定されるものを使って下さい。製造者の指示に従って処理して下さい。(Japanese)

**ВНИМАНИЕ!** При замене аккумулятора на аккумулятор иного типа возможно его возгорание. Утилизируйте аккумулятор в соответствии с инструкциями производителя. (Russian)

# Optical Drive Safety Information

## Laser Safety Information

Internal or external optical drives sold with this Notebook PC contains a CLASS 1 LASER PRODUCT.

---

**WARNING!** Making adjustments or performing procedures other than those specified in the user's manual may result in hazardous laser exposure. Do not attempt to disassemble the optical drive. For your safety, have the optical drive serviced only by an authorized service provider.

---

## Service warning label

---

**WARNING!** INVISIBLE LASER RADIATION WHEN OPEN. DO NOT STARE INTO BEAM OR VIEW DIRECTLY WITH OPTICAL INSTRUMENTS.

---

## CDRH Regulations

The Center for Devices and Radiological Health (CDRH) of the U.S. Food and Drug Administration implemented regulations for laser products on August 2, 1976. These regulations apply to laser products manufactured from August 1, 1976. Compliance is mandatory for products marketed in the United States.

---

**WARNING!** Use of controls or adjustments or performance of procedures other than those specified herein or in the laser product installation guide may result in hazardous radiation exposure.

---

## Macrovision Corporation Product Notice

This product incorporates copyright protection technology that is protected by method claims of certain U.S.A. patents and other intellectual property rights owned by Macrovision Corporation and other rights owners. Use of this copyright protection technology must be authorized by Macrovision Corporation, and is intended for home and other limited viewing uses only *unless otherwise authorized by Macrovision Corporation*. Reverse engineering or disassembly is prohibited.

# CTR 21 Approval

## (for Notebook PC with built-in Modem)

### Danish

„Udstyret er i henhold til Rådets beslutning 98/482/EF EU-godkendt til at blive opkoblet på de offentlige telefonnet som enkeltforbundet terminal. På grund af forskelle mellem de offentlige telefonnet i de forskellige lande giver godkendelsen dog ikke i sig selv ubetinget garanti for, at udstyret kan fungere korrekt på samtlige nettermineringspunkter på de offentlige telefonnet.

I tilfælde af problemer bør De i første omgang henvende Dem til leverandøren af udstyret.»

### Dutch

„Dit apparaat is goedgekeurd volgens Beschikking 98/482/EG van de Raad voor de pan-Europese aansluiting van enkelvoudige eindapparatuur op het openbare geschakelde telefoonnetwerk (PSTN). Gezien de verschillen tussen de individuele PSTN's in de verschillende landen, biedt deze goedkeuring op zichzelf geen onvoorwaardelijke garantie voor een succesvolle werking op elk PSTN-netwerkaansluitpunt.

Neem bij problemen in eerste instantie contact op met de leverancier van het apparaat.»

### English

“The equipment has been approved in accordance with Council Decision 98/482/EC for pan-European single terminal connection to the public switched telephone network (PSTN). However, due to differences between the individual PSTNs provided in different countries, the approval does not, of itself, give an unconditional assurance of successful operation on every PSTN network termination point.

In the event of problems, you should contact your equipment supplier in the first instance.”

### Finnish

”Tämä laite on hyväksytty neuvoston päätöksen 98/482/EY mukaisesti liitettäväksi yksittäisenä laitteena yleiseen kytkentäiseen puhelinverkkoon (PSTN) EU:n jäsenvaltioissa. Eri maiden yleisten kytkentäisten puhelinverkkojen välillä on kuitenkin eroja, joten hyväksyntä ei sellaisenaan takaa häiriötöntä toimintaa kaikkien yleisten kytkentäisten puhelinverkkojen liittytapistäissä.

Ongelmien ilmetessä ottakaa viipymättä yhteyttä laitteen toimittajaan.”

### French

«Cet équipement a reçu l'agrément, conformément à la décision 98/482/CE du Conseil, concernant la connexion paneuropéenne de terminal unique aux réseaux téléphoniques publics commutés (RTPC). Toutefois, comme il existe des différences d'un pays à l'autre entre les RTPC, l'agrément en soi ne constitue pas une garantie absolue de fonctionnement optimal à chaque point de terminaison du réseau RTPC.

En cas de problème, vous devez contacter en premier lieu votre fournisseur.»

### German

„Dieses Gerät wurde gemäß der Entscheidung 98/482/EG des Rates europaweit zur Anschaltung als einzelne Endeinrichtung an das öffentliche Fernsprechnet zugelassen. Aufgrund der zwischen den öffentlichen Fernsprechnetzen verschiedener Staaten bestehenden Unterschiede stellt diese Zulassung an sich jedoch keine unbedingte Gewähr für einen erfolgreichen Betrieb des Geräts an jedem Netzabschlußpunkt dar.

Falls beim Betrieb Probleme auftreten, sollten Sie sich zunächst an ihren Fachhändler wenden.”

### Greek

«Ο εξοπλισμός έχει εγκριθεί για πανευρωπαϊκή σύνδεση μεμονωμένου τερματικού με το δημόσιο τηλεφωνικό δίκτυο μεταγωγής (PSTN), σύμφωνα με την απόφαση 98/482/ΕΚ του Συμβουλίου. Ωστόσο, επειδή υπάρχουν διαφορές μεταξύ των επιμέρους PSTN που παρέχονται σε διάφορες χώρες, η έγκριση δεν παρέχει απ' αυτής ανεπιφύλακτη εξασφάλιση επιτυχούς λειτουργίας σε κάθε σημείο απόληξης του δικτύου PSTN.

Εάν ανακύψουν προβλήματα, θα πρέπει κατ' αρχάς να απευθύνεστε στον προμηθευτή του εξοπλισμού σας.»

### Italian

«La presente apparecchiatura terminale è stata approvata in conformità della decisione 98/482/CE del Consiglio per la connessione paneuropea come terminale singolo ad una rete analogica PSTN. A causa delle differenze tra le reti dei differenti paesi, l'approvazione non garantisce però di per sé il funzionamento corretto in tutti i punti di terminazione di rete PSTN.

In caso di problemi contattare in primo luogo il fornitore del prodotto.»

### Portuguese

«Este equipamento foi aprovado para ligação pan-europeia de um único terminal à rede telefónica pública comutada (RTPC) nos termos da Decisão 98/482/CE. No entanto, devido às diferenças existentes entre as RTPC dos diversos países, a aprovação não garante incondicionalmente, por si só, um funcionamento correcto em todos os pontos terminais da rede da RTPC.

Em caso de problemas, deve entrar-se em contacto, em primeiro lugar, com o fornecedor do equipamento.»

## Spanish

•Este equipo ha sido homologado de conformidad con la Decisión 98/482/CE del Consejo para la conexión paneuropea de un terminal simple a la red telefónica pública conmutada (RTPC). No obstante, a la vista de las diferencias que existen entre las RTPC que se ofrecen en diferentes países, la homologación no constituye por sí sola una garantía incondicional de funcionamiento satisfactorio en todos los puntos de terminación de la red de una RTPC.

En caso de surgir algún problema, procede ponerse en contacto en primer lugar con el proveedor del equipo.

## Swedish

"Utrustningen har godkänts i enlighet med rådets beslut 98/482/EG för alleuropeisk anslutning som enskild terminal till det allmänt tillgängliga kopplade telenätet (PSTN). På grund av de skillnader som finns mellan telenätet i olika länder utgör godkännandet emellertid inte i sig självt en absolut garanti för att utrustningen kommer att fungera tillfredsställande vid varje telenätsanslutningspunkt.

Om problem uppstår bör ni i första hand kontakta leverantören av utrustningen."

## ENERGY STAR complied product



ENERGY STAR is a joint program of the U.S. Environmental Protection Agency and the U.S. Department of Energy helping us all save money and protect the environment through energy efficient products and practices.

All ASUS products with the ENERGY STAR logo comply with the ENERGY STAR standard, and the power management feature is enabled by default. The monitor and computer are automatically set to sleep after 15 and 30 minutes of user inactivity. To wake your computer, click the mouse or press any key on the keyboard. Please visit <http://www.energy.gov/powermanagement> for detail information on power management and its benefits to the environment. In addition, please visit <http://www.energystar.gov> for detail information on the ENERGY STAR joint program.

---

**NOTE:** Energy Star is NOT supported on FreeDOS and Linux-based operating systems.

---

## European Union Eco-label

This Notebook PC has been awarded the EU Flower label, which means that this product has the following characteristics:

1. Decreased energy consumption during use and stand-by modes.
2. Limited use of toxic heavy metals.
3. Limited use of substances harmful to the environment and health.
4. Reduction of the use of natural resources by encouraging recycling.
5. Designed for easy upgrades and longer lifetime through providing compatible spare parts such as batteries, power supplies, the keyboard, the memory, and if available the CD drive or DVD drive.
6. Reduced solid waste through takeback policy.

For more information on the EU Flower label, please visit the European Union Eco-label website at <http://www.ecolabel.eu>.



## Global Environmental Regulation Compliance and Declaration

ASUS follows the green design concept to design and manufacture our products, and makes sure that each stage of the product life cycle of ASUS product is in line with global environmental regulations. In addition, ASUS disclose the relevant information based on regulation requirements.

Please refer to <http://csr.asus.com/english/Compliance.htm> for information disclosure based on regulation requirements ASUS is complied with:

### **Japan JIS-C-0950 Material Declarations**

### **EU REACH SVHC**

### **Korea RoHS**

### **Swiss Energy Laws**

## ASUS Recycling/Takeback Services

ASUS recycling and takeback programs come from our commitment to the highest standards for protecting our environment. We believe in providing solutions for you to be able to responsibly recycle our products, batteries, other components as well as the packaging materials. Please go to <http://csr.asus.com/english/Takeback.htm> for detailed recycling information in different regions.

## Coating Notice

**IMPORTANT!** To provide electrical insulation and maintain electrical safety, a coating is applied to insulate the device except on the areas where the IO ports are located.

