

# ASUS® R10-A2P4

## 1U Rackmount Chassis Kit

### User Guide



**E1655**

**First edition V1**

**July 2004**

**Copyright © 2004 ASUSTeK COMPUTER INC. All Rights Reserved.**

No part of this manual, including the products and software described in it, may be reproduced, transmitted, transcribed, stored in a retrieval system, or translated into any language in any form or by any means, except documentation kept by the purchaser for backup purposes, without the express written permission of ASUSTeK COMPUTER INC. ("ASUS").

ASUS provides this manual "as is" without warranty of any kind, either express or implied, including but not limited to the implied warranties or conditions of merchantability or fitness for a particular purpose. In no event shall ASUS, its directors, officers, employees, or agents be liable for any indirect, special, incidental, or consequential damages (including damages for loss of profits, loss of business, loss of use or data, interruption of business and the like), even if ASUS has been advised of the possibility of such damages arising from any defect or error in this manual or product.

Specifications and information contained in this manual are furnished for informational use only, and are subject to change at any time without notice, and should not be construed as a commitment by ASUS. ASUS assumes no responsibility or liability for any errors or inaccuracies that may appear in this manual, including the products and software described in it.

Product warranty or service will not be extended if: (1) the product is repaired, modified or altered, unless such repair, modification or alteration is authorized in writing by ASUS; or (2) the serial number of the product is defaced or missing.

Products and corporate names appearing in this manual may or may not be registered trademarks or copyrights of their respective companies, and are used only for identification or explanation and to the owners' benefit, without intent to infringe.

# Contents

Notices .....	iv
Safety information .....	v
About this guide .....	vi
<b>Chapter 1: Product introduction</b>	
1.1 System package contents .....	2
1.2 Front panel features .....	3
1.3 Rear panel features .....	3
1.4 Internal features .....	4
1.5 LED information .....	5
1.5.1 Front panel LEDs .....	5
1.5.2 Rear panel LEDs .....	5
<b>Chapter 2: Hardware setup</b>	
2.1 Preparation .....	2
2.1.1 Tools to use .....	2
2.1.2 System components and devices to install .....	2
2.2 Removing and installing the chassis cover .....	3
2.2.1 Removing the cover .....	3
2.2.2 Installing the cover .....	4
2.3 Motherboard installation .....	5
2.3.1 Motherboard dimensions .....	5
2.3.2 Placement direction and screw holes .....	6
2.3.3 Installing the motherboard .....	7
2.4 Hard disk drives .....	9
2.5 Expansion slot .....	11
2.6 Removable components .....	13
2.6.1 System fans .....	13
2.6.2 Device fan .....	13
2.6.3 Power supply module .....	14
2.6.4 Optical drive .....	15
2.6.5 Motherboard .....	17
2.7 SATA backplane cabling .....	18
<b>Chapter 3: Rackmounting</b>	
3.1 Rackmount rail kit items .....	2
3.2 Rack rails assembly .....	2
3.3 Attaching the rails to the rack .....	3
3.4 Rackmounting the server .....	4

# Notices

## Federal Communications Commission Statement

This device complies with Part 15 of the FCC Rules. Operation is subject to the following two conditions:

- This device may not cause harmful interference, and
- This device must accept any interference received including interference that may cause undesired operation.

This equipment has been tested and found to comply with the limits for a Class B digital device, pursuant to Part 15 of the FCC Rules. These limits are designed to provide reasonable protection against harmful interference in a residential installation. This equipment generates, uses and can radiate radio frequency energy and, if not installed and used in accordance with manufacturer's instructions, may cause harmful interference to radio communications. However, there is no guarantee that interference will not occur in a particular installation. If this equipment does cause harmful interference to radio or television reception, which can be determined by turning the equipment off and on, the user is encouraged to try to correct the interference by one or more of the following measures:

- Reorient or relocate the receiving antenna.
- Increase the separation between the equipment and receiver.
- Connect the equipment to an outlet on a circuit different from that to which the receiver is connected.
- Consult the dealer or an experienced radio/TV technician for help.



---

**WARNING!** The use of shielded cables for connection of the monitor to the graphics card is required to assure compliance with FCC regulations. Changes or modifications to this unit not expressly approved by the party responsible for compliance could void the user's authority to operate this equipment.

---

## Canadian Department of Communications Statement

This digital apparatus does not exceed the Class B limits for radio noise emissions from digital apparatus set out in the Radio Interference Regulations of the Canadian Department of Communications.

**This class B digital apparatus complies with Canadian ICES-003.**

# Safety information

## Electrical Safety

- Before installing or removing signal cables, ensure that the power cables for the system unit and all attached devices are unplugged.
- To prevent electrical shock hazard, disconnect the power cable from the electrical outlet before relocating the system.
- When adding or removing any additional devices to or from the system, ensure that the power cables for the devices are unplugged before the signal cables are connected. If possible, disconnect all power cables from the existing system before you add a device.
- If the power supply is broken, do not try to fix it by yourself. Contact a qualified service technician or your dealer.

## Operation Safety

- Any mechanical operation on this server must be conducted by certified or experienced engineers.
- Before operating the server, carefully read all the manuals included with the server package.
- Before using the server, make sure all cables are correctly connected and the power cables are not damaged. If any damage is detected, contact your dealer as soon as possible.
- To avoid short circuits, keep paper clips, screws, and staples away from connectors, slots, sockets and circuitry.
- Avoid dust, humidity, and temperature extremes. Place the server on a stable surface.



---

This product is equipped with a three-wire power cable and plug for the user's safety. Use the power cable with a properly grounded electrical outlet to avoid electrical shock.

---

### Lithium-Ion Battery Warning

**CAUTION!** Danger of explosion if battery is incorrectly replaced. Replace only with the same or equivalent type recommended by the manufacturer. Dispose of used batteries according to the manufacturer's instructions.

### CD-ROM Drive Safety Warning

**CLASS 1 LASER PRODUCT**

# About this guide

## Audience

This user guide is intended for system integrators, and experienced users with at least basic knowledge of configuring a server.

## Contents

This guide contains the following parts:

### 1. Chapter 1: Product Introduction

This chapter describes the general features of the chassis kit. It includes sections on front panel and rear panel specifications.

### 2. Chapter 2: Hardware setup

This chapter lists the hardware setup procedures that you have to perform when installing or removing system components.

### 3. Chapter 3: Rackmounting

This chapter tells how to install the system to a rack.

## Conventions

To make sure that you perform certain tasks properly, take note of the following symbols used throughout this manual.



**WARNING:** Information to prevent injury to yourself when trying to complete a task.



**CAUTION:** Information to prevent damage to the components when trying to complete a task.



**IMPORTANT:** Information that you **MUST** follow to complete a task.



**NOTE:** Tips and information to aid in completing a task.

# Chapter 1

This chapter describes the general features of the chassis kit. It includes sections on front panel and rear panel specifications.











ASUS R10-A2P4 1U rackmount chassis kit

# 1.1 System package contents

Check your ASUS R10-A2P4 package for the following items.



Contact your dealer immediately if any of the items is damaged or missing.

Package items		
<b>ASUS R10-A2P4 1U rackmount chassis</b> with: <ul style="list-style-type: none"><li>• 300W/400W/500W power supply</li><li>• Optical drive</li><li>• System/device/rear fans</li><li>• 2 x HDD trays</li><li>• Riser card bracket</li><li>• SATA backplane</li></ul>		
<b>CPU heatsink</b> 	<b>SMBus cable</b> 	<b>AC power cord</b> 
<b>SATA cable-1</b> 	<b>SATA cable-2</b> 	<b>SATA cable-3</b> 
<b>Rackmount rail kit</b> 		



## 1.2 Front panel features

The chassis kit displays a simple yet stylish front panel with easily accessible features. The power and reset buttons, LED indicators, location switch, optical drive, and two USB ports are located on the front panel.

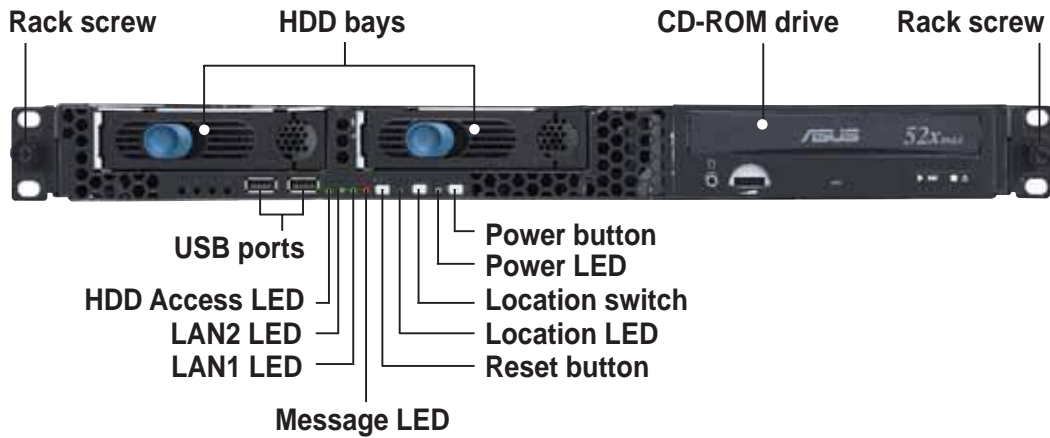

Refer to section “1.5.1 Front panel LEDs” for the LED descriptions.

## 1.3 Rear panel features

The rear panel includes the expansion slot, system power socket, and rear fans. The middle part includes the I/O shield with openings for the rear panel connectors on the motherboard.



The ports for the PS/2 keyboard, PS/2 mouse, USB, VGA, and Gigabit LAN do not appear on the rear panel if motherboard is not present.

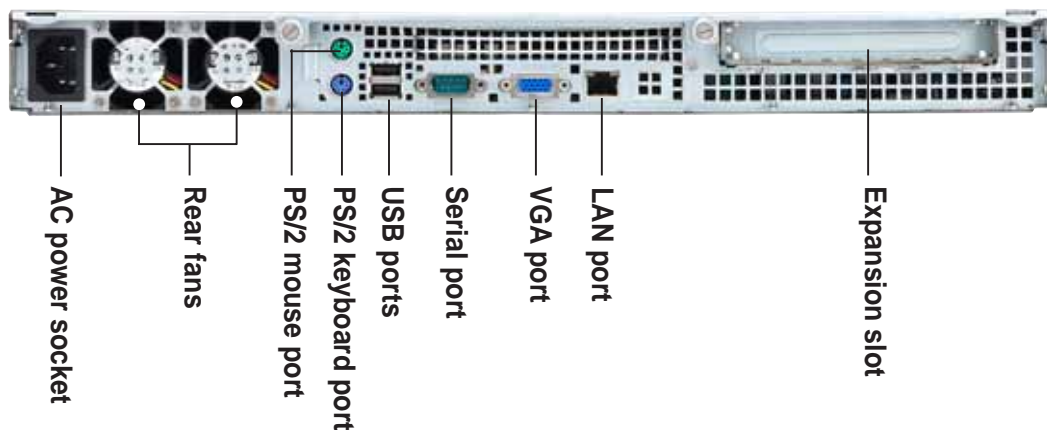

## 1.4 Internal features

The chassis includes the basic components as shown.

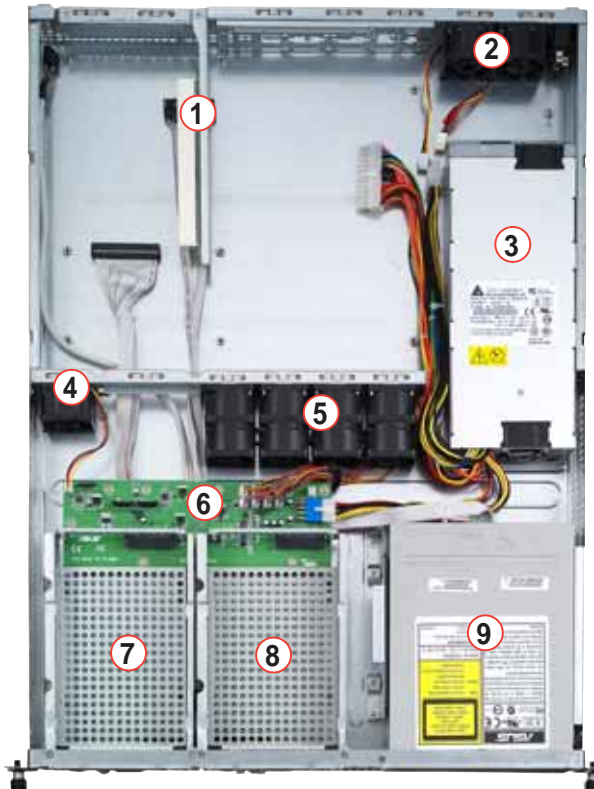

- |                             |                   |
|-----------------------------|-------------------|
| 1. PCI-X riser card bracket | 6. SATA backplane |
| 2. Rear fans                | 7. HDD tray 1     |
| 3. Power supply             | 8. HDD tray 2     |
| 4. Device fan               | 9. Optical drive  |
| 5. System fans              |                   |



---

The chassis kit does not include a floppy disk drive. Connect an external floppy disk drive (USB interface) to any of the USB ports on the front or rear panel if you need to use a floppy disk.

---

# 1.5 LED information

## 1.5.1 Front panel LEDs



LED	Display status	Description
Power LED	ON	System power ON
HDD Access LED	OFF Blinking	No activity Read/write data into the HDD
Message LED	OFF Blinking	System is normal; no incoming event ASWM indicates a HW monitor event
Location LED	OFF ON	Normal status Location switch is pressed (Press the location switch again to turn off)
LAN LED	OFF Blinking ON	No LAN connection LAN is transmitting or receiving data LAN connection is present

## 1.5.2 Rear panel LEDs

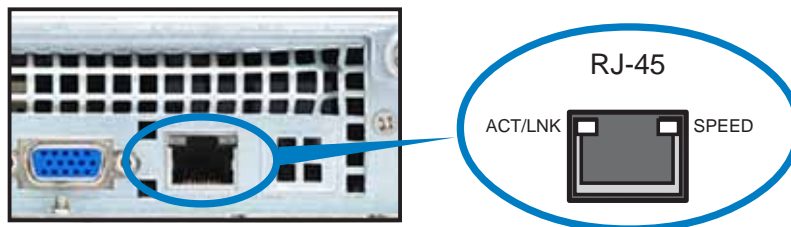

ACT/LINK LED		SPEED LED	
Status	Description	Status	Description
OFF	No link	OFF	10Mbps connection
Green	Linked	Orange	100Mbps connection
Blinking	Linking	Green	1000Mbps connection



# Chapter 2

This chapter lists the hardware setup procedures that you have to perform when installing or removing system components.



ASUS R10-A2P4 1U rackmount chassis kit

# Hardware setup

## **2.1 Preparation**

Before proceeding, prepare everything that you might need to facilitate installation.

### **2.1.1 Tools to use**

1. Phillips head screw driver
2. Flat head screw driver

### **2.1.2 System components and devices to install**

The following items are the basics that you need to install into the chassis kit. You may need to install other devices depending on your configuration.

1. Motherboard
2. Hard disk drives
3. Drive cables
4. PCI-X add-on card

## 2.2 Removing and installing the chassis cover

### 2.2.1 Removing the cover

1. Use a Phillips screwdriver to remove the screw on each front end of the top cover.



2. Loosen the two thumbscrews on the rear panel to release the top cover from the chassis.

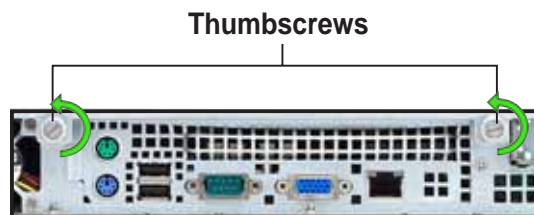

3. Firmly hold the cover and slide it toward the rear panel for about half an inch until it is disengaged from the chassis.



1/2 inch distance

4. Lift the cover from the chassis.

## 2.2.2 Installing the cover

1. Position the cover on top of the chassis with the thumbscrews on the rear, and leaving a gap of about half an inch from the front panel.



2. Make sure that the side markings on the cover (two on each side) are aligned to the grooves on the chassis.

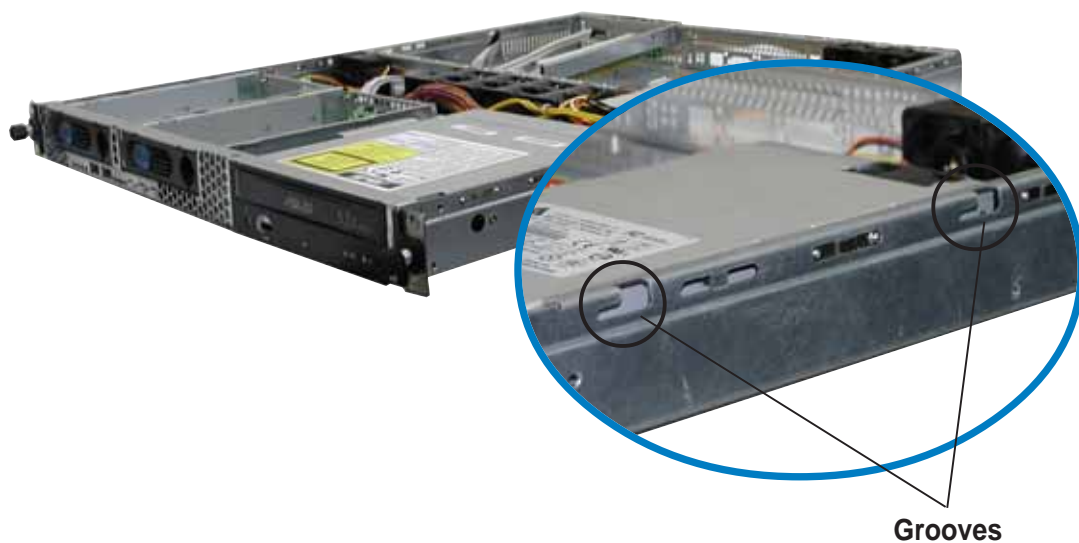

3. Slide the cover toward the front until it snaps in place.
4. Tighten the thumbscrews on the rear to secure the cover.





## 2.3 Motherboard installation



---

This section only describes how to install a supported motherboard into the R10-A2P4 chassis kit. Refer to the motherboard user guide for instructions on installing specific motherboard components.

---

### 2.3.1 Motherboard dimensions

This chassis kit supports an ASUS motherboard that measures 12 x 10.5 inches (30.48 x 26.67 cm). Motherboards of smaller sizes will fit into the chassis. Refer to the motherboard user guide for more information on the motherboard dimension and other system requirements.



---

Make sure that the motherboard you intend to install to the chassis does not exceed the maximum specified dimensions. Otherwise, it will not fit into the chassis.

---

## 2.3.2 Placement direction and screw holes

Align the holes on the motherboard (indicated by white circles in the picture below) to the corresponding standoffs on the motherboard metal plate inside the chassis.

Place screws through the designated holes to secure the motherboard to the chassis. Refer to the motherboard user guide for the specific number of screws that you need to use.

Place this side (with I/O ports)  
to the rear side of the chassis



The following figure shows the specific locations of the standoffs (indicated by black circles) inside the chassis. These standoffs should match with the holes on the motherboard as pointed out above.



## 2.3.3 Installing the motherboard

To install the motherboard:

1. Firmly hold the riser card bracket, then pull it up to detach it from the chassis.



2. Clear the motherboard area by re-routing the pre-connected cables to facilitate the motherboard installation.



3. Firmly hold the motherboard as shown, and place the side with the CPU sockets near the system fans.

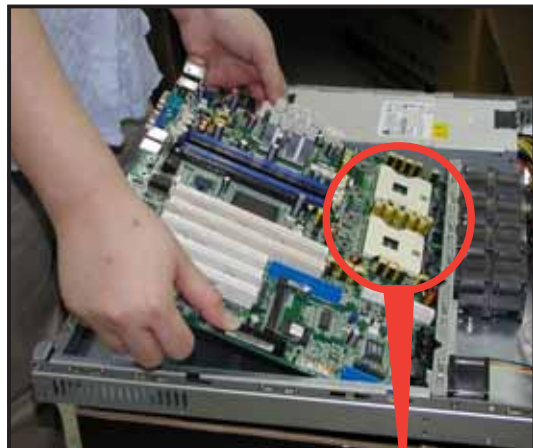

CPU sockets

4. Fit the rear panel connectors to the I/O shield openings on the chassis rear.



5. Match the motherboard holes with the chassis standoffs.
6. Secure the motherboard with screws. Refer to the motherboard user guide for the specific number of screws that you need to use.



The chassis appears as shown with the motherboard installed.



Refer to the motherboard user guide for instructions on installing CPU, heatsink, and system memory.

## 2.4 Hard disk drives

To install a SATA HDD:

1. Release a drive tray by pushing the spring lock to the right, then pulling the tray lever outward. The drive tray ejects slightly after you pull out the lever.



2. Firmly hold the tray lever and pull the drive tray out of the bay.



3. Take note of the drive tray holes. Each side has three holes to fit different types of hard disk drives. Use two screws on each side to secure the hard disk drive.



4. Place a SATA hard disk drive on the tray, then secure it with four screws.



5. Carefully insert the drive tray and push it all the way to the depth of the bay until just a small fraction of the tray edge protrudes.

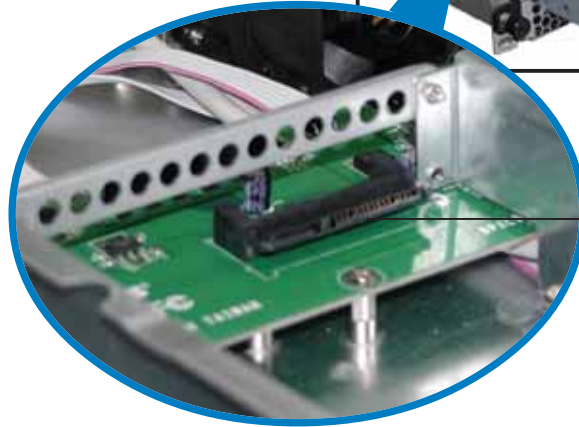

SATA interface  
on the backplane



---

When installed, the SATA connector on the drive connects to the SATA interface on the backplane.

---

6. Push the tray lever until it clicks, and secures the drive tray in place. The drive tray is correctly placed when its front edge aligns with the bay edge.
7. Repeat steps 1 to 6 if you wish to install a second SATA drive.



8. Connect the bundled SATA cables to the connectors on the SATA backplane. Refer to section “2.7 SATA backplane cabling” for information on the SATA backplane cable connections.

## 2.5 Expansion slot

The chassis comes with a riser card bracket. You need to remove the bracket if you wish to install a PCI-X expansion card.

To install a PCI-X card:

1. Firmly hold a riser card bracket, then pull it up to detach it from the PCI-X slot on the motherboard.



Install a motherboard following the steps in section "2.3.3 Installing a motherboard."



2. Use a Phillips (cross) screwdriver to remove the screw that secures the slot metal cover.

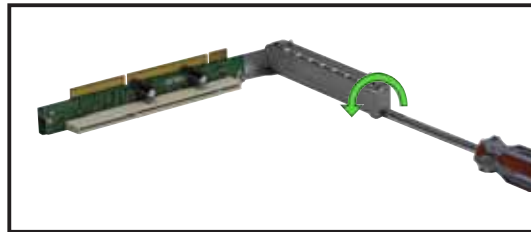

3. Install a PCI-X card to the bracket as shown, then secure the card with a screw.

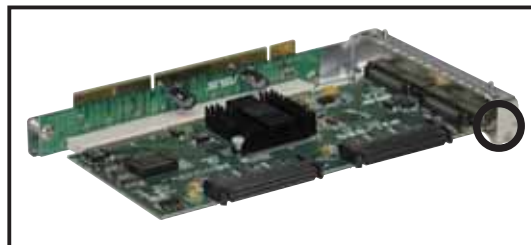

4. Take note of the holes on the riser card bay. The two pegs on the riser card bracket should match these holes to ensure that the bracket is properly in place.

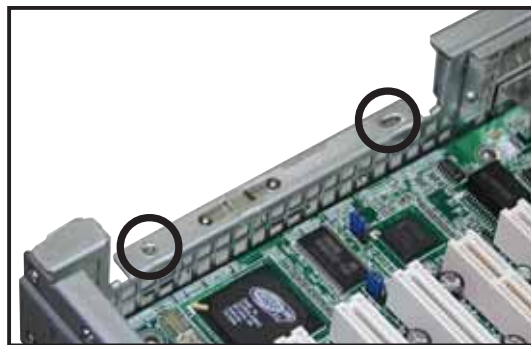

Peg on the riser card bracket

4. Install the riser card bracket with the card into the PCI-X slot on the motherboard.



5. Make sure that the golden connectors completely fit the slot and the bracket aligns with the rear panel.
6. Connect the cable(s) to the card, if applicable.





## 2.6 Removable components

You may need to remove previously installed system components when installing or removing system devices, or when you need to replace defective components. This section tells how to remove the following components:

1. System fans
2. Device fan
3. Power supply module
4. Optical drive
5. Motherboard

### 2.6.1 System fans

To uninstall the system fans:

1. Disconnect all the system fan cables from the connectors on the backplane board.
2. Remove the four screws that secure a fan.
3. Repeat step 2 to uninstall the other fans.



Fan screw

### 2.6.2 Device fan

To uninstall the device fan:

1. Disconnect the system fan cable from the connector on the motherboard.
2. Remove the four screws that secure the device fan.

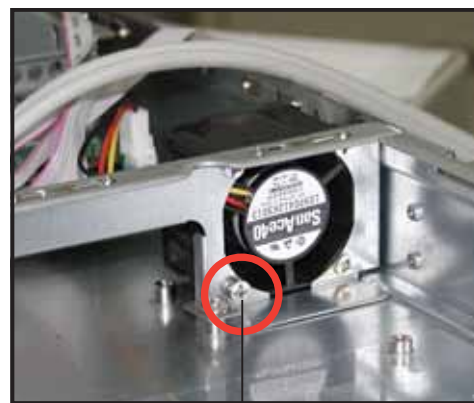

Fan screw

## 2.6.3 Power supply module

To uninstall the power supply module:

1. Disconnect all the power cables connected to the motherboard and other system devices.

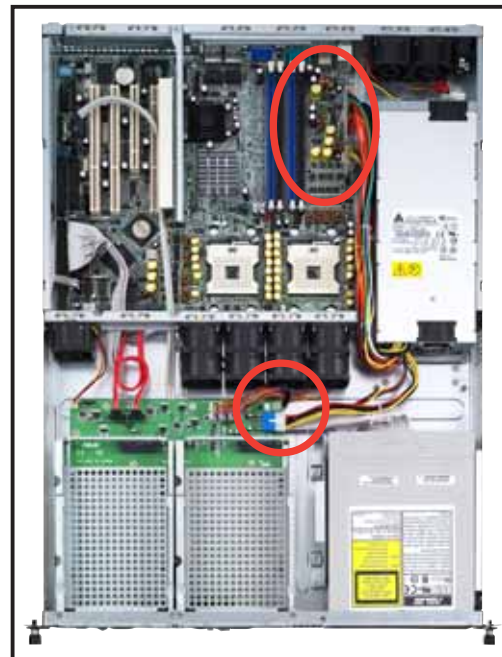

2. Use a Phillips (cross) screwdriver to remove the screw that secures the front end of the power supply.



3. Slide the power supply backward for about half an inch, then carefully lift it out from the chassis.

## 2.6.4 Optical drive

To uninstall the optical drive:

1. Disconnect the power and signal cables connected to the rear of the optical drive.



2. Use a Phillips (cross) screwdriver to remove the two screws that secure the metal bracket on the side of the optical drive. Remove the bracket to release the drive.



3. Slide the optical drive toward the front panel, then carefully pull it out of the drive bay.



To install an optical drive:

1. From the front panel, insert the rear end of the optical drive into the 5.25-inch drive bay.



2. Place the metal bracket parallel to the side of the optical drive, matching its two pegs with the lower holes, and the bracket holes with the standoffs on the base of the chassis.



The metal bracket should fit completely to ensure that the optical drive is securely in place.

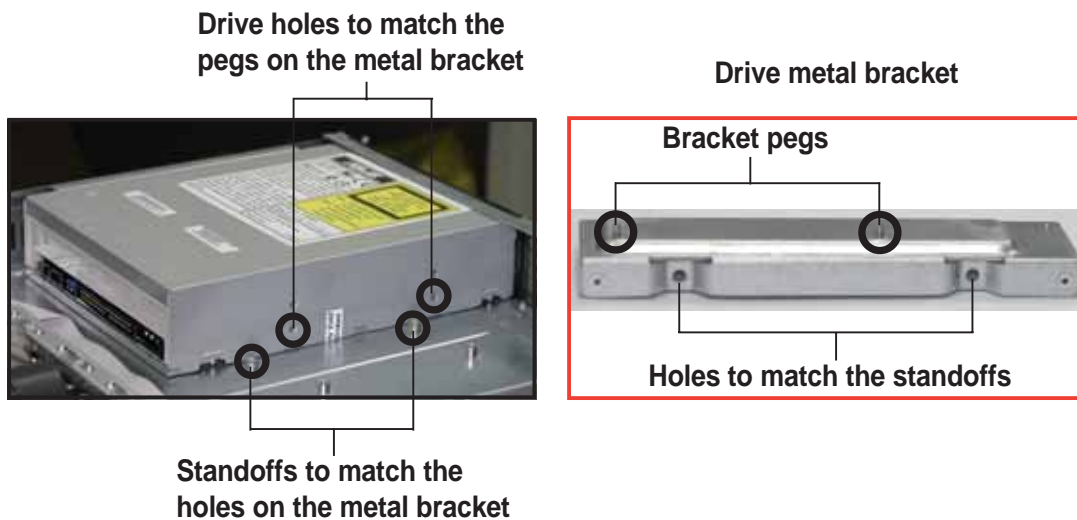

3. Secure the bracket with two screws.



## 2.6.5 Motherboard

To uninstall the motherboard:

1. Disconnect all the power and signal cables connected to the motherboard.
2. Uninstall all the devices from the motherboard including the CPU and heatsink, riser card brackets, and DDR DIMMs. Refer to the corresponding sections for instructions on removing these components.
3. Use a Phillips (cross) screwdriver to remove the screws that secure the motherboard to the base of the chassis. Refer to the section “2.3.2 Placement direction and screw holes” for information.
4. Carefully lift the motherboard out of the chassis.



## 2.7 SATA backplane cabling

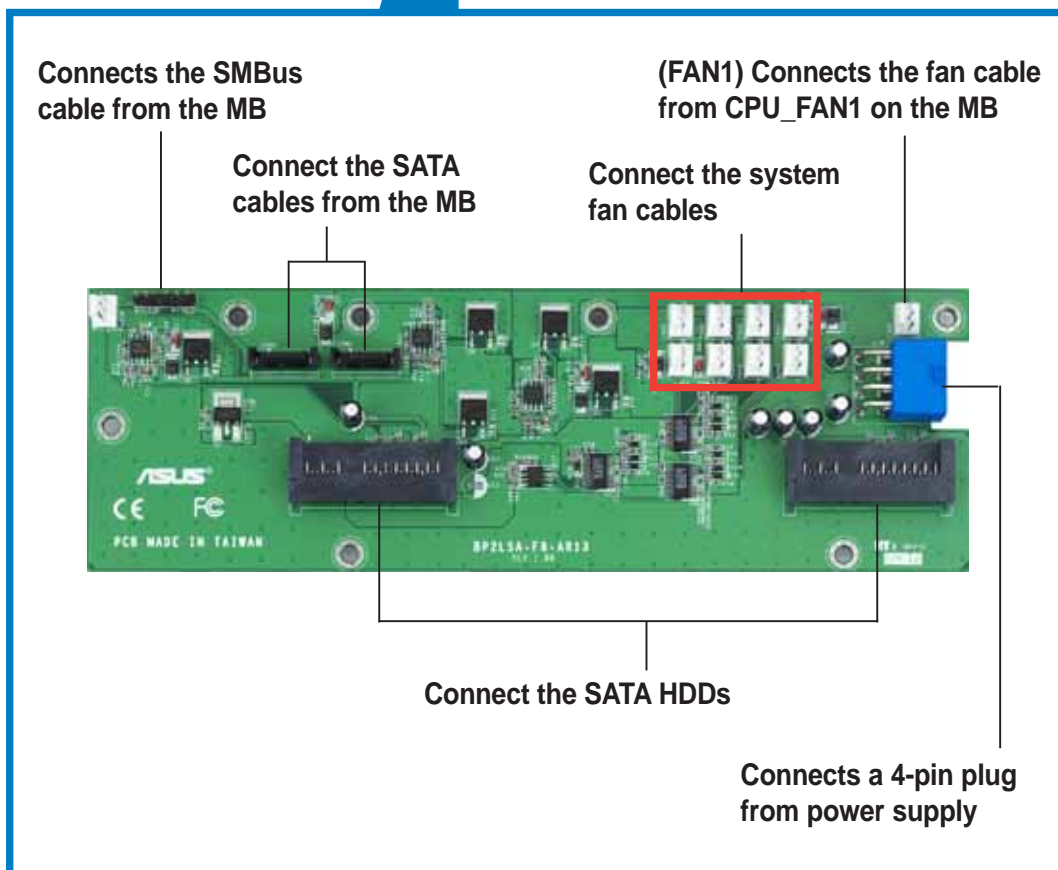

Ensure that the **FAN1** connector on the SATA backplane and the **CPU\_FAN2** on the motherboard are connected via the 3-pin fan cable. The fan RPM (rotations per minute) are monitored and automatically adjusted through this feature.

# Chapter 3

This chapter tells how to install the system to a rack.



ASUS R10-A2P4 1U rackmount chassis kit

# Rackmounting

## 3.1 Rackmount rail kit items

If you have the rackmount rail kit, it contains two pairs of rails (one pair for each side of the barebone system), and eight (8) pairs of nut-and-bolt type screws.

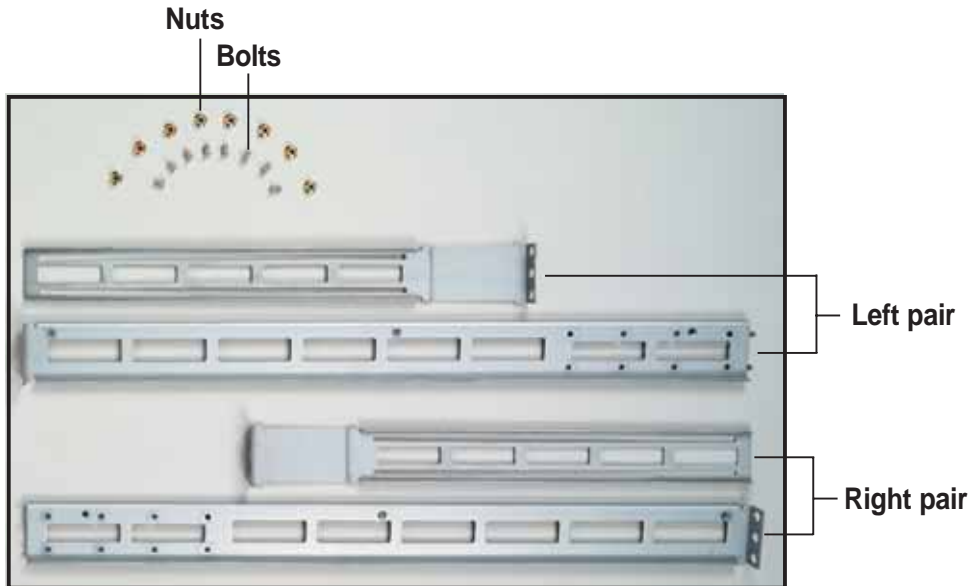

## 3.2 Rack rails assembly

To assemble the rack rails:

1. Determine the depth of the rack where you wish to install the system.
2. Match one long and one short rail to your desired length, and fix them together using four (4) pairs of nuts and bolts.
3. Repeat step 2 to assemble the other rail pair.

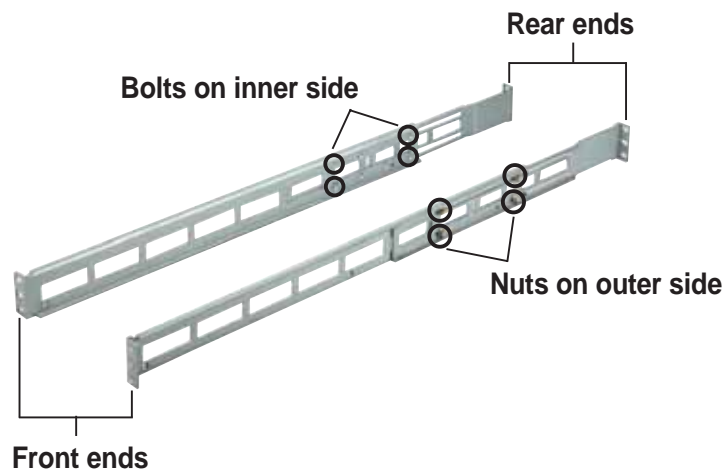



### 3.3 Attaching the rails to the rack

To attach the rails to the rack:

1. Select one unit of space (1U) on the rack where you wish to install the barebone server.
2. Remove the screws from the 1U space on the rack front.



1U space

3. Align the front end holes of a rack rail pair to the 1U space.
4. Drive in two screws on the outer holes to secure the front end.



5. Find the **rear 1U space** that corresponds to the **front 1U space** where you attached the rail.
6. Remove the screws from the rear 1U space, and align the rear end holes.
7. Drive in two screws on the outer holes to secure the rear end.
8. From the rack front, find the corresponding 1U space for the second rail pair.
9. Repeat steps 2 to 7 to attach the second rail pair. When properly installed, the rack rails appear as shown.



## 3.4 Rackmounting the server

To mount the server to the rack:

1. Firmly hold the server on both sides and insert the rear panel side to the front end of the rack rail, then carefully push the server all the way to the back until the front panel fits the front end of the rack, and the rack screws on the server match the middle hole on the rack..



2. Tighten the two rack screws to secure the server to the rack.



Rack screw