



REPUBLIC OF
GAMERS

Q15942

QUICK START GUIDE

ROG Rapture GT-AX11000 Tri-band Gaming Router

ASUS





Table of contents

English.....	3
繁體中文	8
简体中文	13
Français	18
Bahasa Indonesia.....	23
日本語	28
한국어	33
Bahasa Malaysia	38
Español.....	43
ไทย	48
Tiếng Việt.....	53





Package contents

- ROG GT-AX11000 Wireless Router
- AC adapter
- Quick Start Guide
- 8 * wireless antennas
- Network cable (RJ-45)



NOTE: If any of the items is damaged or missing, contact your retailer.

A quick look at your ROG router

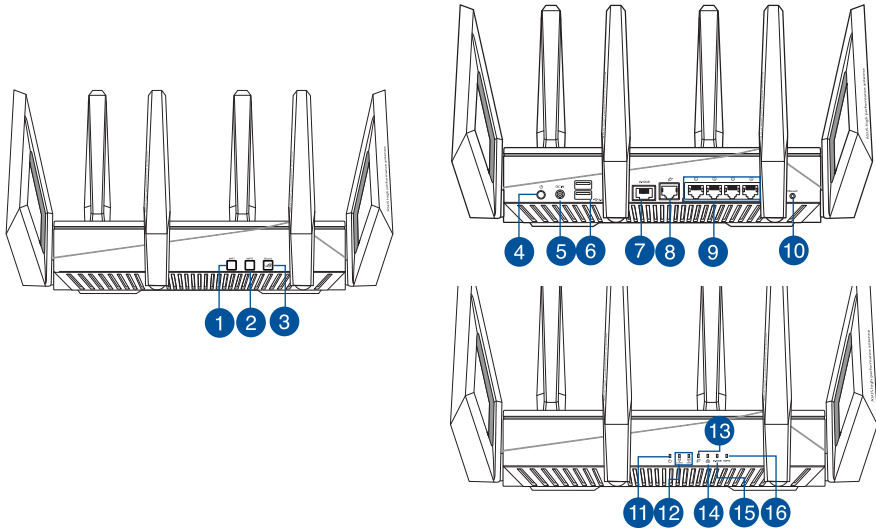

1. Wi-Fi On/Off button	9. LAN ports
2. WPS button	10. Reset Button
3. Boost Key	11. Power LED
4. Power button	12. 2.4GHz / 5GHz Wi-Fi LED
5. Power (DC-IN) port	13. WAN (Internet) LED
6. USB 3.0 ports	14. LAN LED
7. 2.5G Gaming port	15. 2.5G Gaming port LED
8. WAN (Internet) port	16. WPS LED



Specifications:

DC Power adapter	DC Output: +19V with max 3.42A current		
Operating Temperature	0~40°C	Storage	0~70°C
Operating Humidity	50~90%	Storage	20~90%

Preparing your modem

1. **Unplug the power cable/DSL modem. If it has a battery backup, remove the battery.**

NOTE: If you are using DSL for Internet, you will need your username/password from your Internet Service Provider (ISP) to properly configure the router.

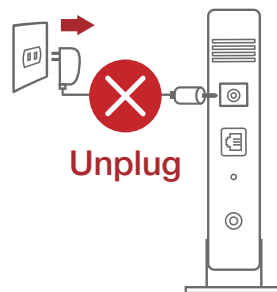

2. **Connect your modem to the router with the bundled network cable.**

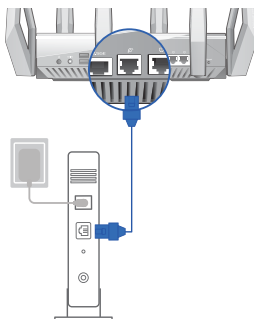

3. **Power on your cable/DSL modem.**
4. **Check your cable/DSL modem LED lights to ensure the connection is active.**

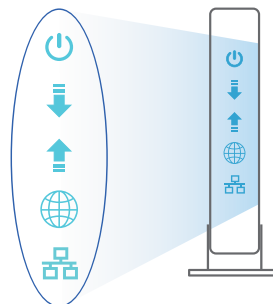

Setting up your ROG router

You can set up your ROG router via wired or wireless connection.

A. Wired connection

1. Plug your router into a power outlet and power it on. Connect the network cable from your computer to a LAN port on your router.

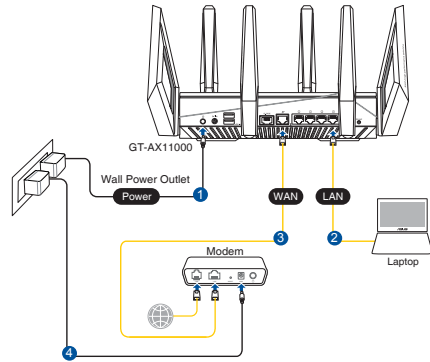

2. The web GUI launches automatically when you open a web browser. If it does not auto-launch, enter <http://router.asus.com>
3. Set up a password for your router to prevent unauthorized access.

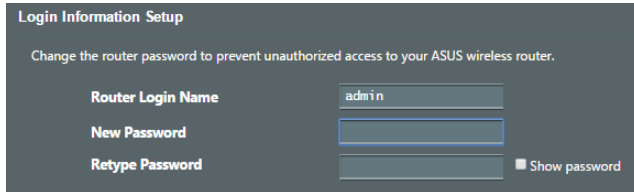

B. Wireless connection

1. Plug your router into a power outlet and power it on.

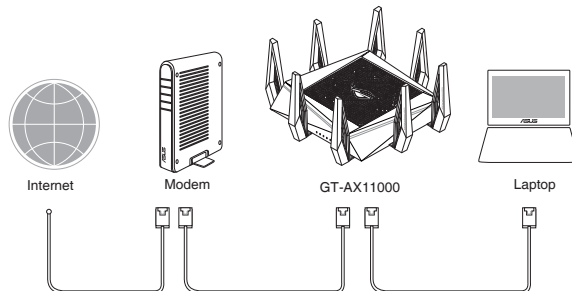

2. **Connect to the network name (SSID) shown on the product label on the back side of the router. For better network security, change to a unique SSID and assign a password.**



2.4G Wi-Fi Name (SSID): ASUS_XX_2G

5G-1 Wi-Fi Name (SSID): ASUS_XX_5G

5G-2 Wi-Fi Name (SSID): ASUS_XX_5G_Gaming

- * **XX** refers to the last two digits of 2.4GHz MAC address. You can find it on the label on the back of your ROG router.

3. **Once connected, the web GUI launches automatically when you open a web browser. If it does not auto-launch, enter <http://router.asus.com>.**
4. **Set up a password for your router to prevent unauthorized access.**

Login Information Setup

Change the router password to prevent unauthorized access to your ASUS wireless router.

Router Login Name:

New Password:

Retype Password: Show password



Remembering your wireless router settings

- Remember your wireless settings as you complete the router setup.

Router Name:	Password:
2.4 GHz network SSID:	Password:
5GHz-1 network SSID:	Password:
5GHz-2 network SSID:	Password:

FAQ

1. Where can I find more information about the wireless router?
 - Online FAQ site: <http://support.asus.com/faq>
 - Technical support site: <https://www.asus.com/support>
 - Customer hotline: refer to the Support Hotline section in this Quick Start Guide



包裝內容物

- ROG GT-AX11000 無線分享器
- 8 × 無線輸出天線
- 電源變壓器
- RJ45 網路線
- 快速使用指南



注意：若以上列出的任何一項配件有毀損或是短缺的情形，請儘速聯絡您的經銷商。

認識您的 ROG 無線分享器

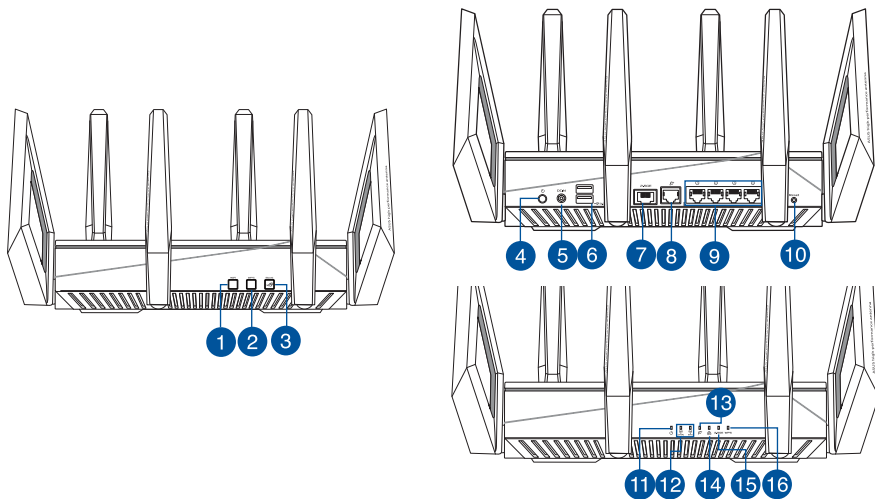

1. Wi-Fi 開關按鈕	9. LAN 連接埠
2. WPS 按鈕	10. 重置按鈕
3. Boost Key	11. 電源指示燈
4. 電源按鈕	12. 2.4GHz / 5GHz Wi-Fi指示燈
5. 電源輸入埠 (DC-IN)	13. WAN (網際網路) 指示燈
6. USB 3.0連接埠	14. LAN 指示燈
7. 2.5G Gaming 連接埠	15. 2.5G Gaming 連接埠指示燈
8. WAN (網際網路) 連接埠	16. WPS 指示燈

規格

DC 電源變壓器	DC 輸出：+19V 電壓，支援最大 3.42A 電流		
運作溫度	0~40°C	儲存溫度	0~70°C
運作濕度	50~90%	儲存濕度	20~90%

準備您的數據機

1. 拔除您的纜線/DSL數據機電源，若數據機內含備用電池，請移除電池。

注意： 若您使用 DSL 連接網際網路，將會需要向您的網際網路服務供應商 (ISP) 取得登入名稱/密碼，以正確安裝您的無線分享器。

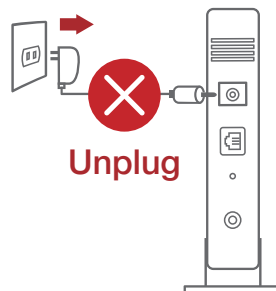

2. 使用附贈的網路線連接您的數據機與無線分享器。

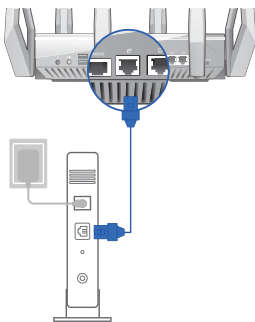

3. 開啟您的纜線/DSL數據機。
4. 檢查您纜線/DSL數據機上的指示燈，確認已經連線。

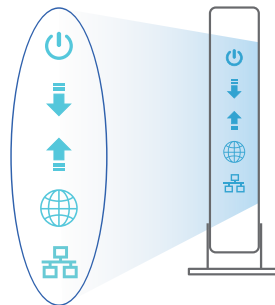

設定您的 ROG 無線分享器

您可以透過有線或無線兩種方式設定您的無線分享器

A. 有線連接

- 將無線分享器連接到電源插座並開啟電源。用網路線 (2) 將您的電腦連接到無線分享器上的 LAN 連接埠。
-
- 當您開啟網頁瀏覽器時，網頁設定介面會自動出現。若沒有出現，請在網址欄中輸入 <http://router.asus.com>。
 - 為無線分享器設定密碼以防止未經授權的存取。

Login Information Setup

Change the router password to prevent unauthorized access to your ASUS wireless router.

Router Login Name

New Password

Retype Password Show password

B. 無線連接

- 將無線分享器連接到電源插座並開啟電源。

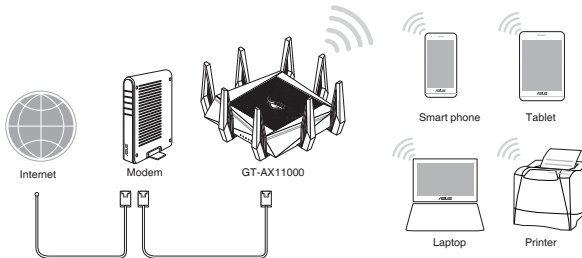

2. 連接到無線分享器後方標籤上註明的網路名稱（SSID）。為確保最佳的網路安全性，請更改預設的 SSID 和密碼。



2.4G Wi-Fi 名稱 (SSID):	ASUS_XX_2G
5G-1 Wi-Fi 名稱 (SSID):	ASUS_XX_5G
5G-2 Wi-Fi 名稱 (SSID):	ASUS_XX_5G_Gaming

* XX 是 2.4GHz MAC 位址的後兩位數字。您可在機器底部的貼紙上找到。

3. 連接網絡後，當您打開網頁瀏覽器時，網頁設置界面會自動出現。若沒有出現，請在網址欄中輸入 <http://router.asus.com>。
4. 為無線分享器設置密碼以防止未經授權的訪問。

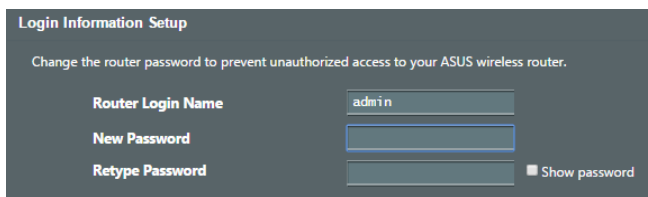

記住無線分享器的設定

- 完成無線分享器的設定後，請記住您的無線設定。

Router Name:	Password:
2.4 GHz network SSID:	Password:
5GHz-1 network SSID:	Password:
5GHz-2 network SSID:	Password:

FAQ

1. 哪裡可以找到更多的無線分享器資訊？

- 線上 FAQ 網址：<http://support.asus.com/faq>
- 華碩支援網站：<https://www.asus.com/tw/support>
- 客戶服務熱線：請參閱此快速使用指南的支援熱線

華碩連絡資訊

華碩電腦公司 ASUSTeK COMPUTER INC. (台灣)

市場訊息

地址：台灣臺北市北投區立德路15號
電話：+886-2-2894-3447
傳真：+886-2-2890-7798
電子郵件：info@asus.com.tw
全球資訊網：<http://tw.asus.com>

技術支援

電話：+886-2-2894-3447 (0800-093-456)
線上支援：<http://www.asus.com/tw/support/>

包装内容物

- ☑ ROG GT-AX11000 无线路由器
- ☑ 8 × 无线传输天线
- ☑ 电源适配器
- ☑ 网线 (RJ-45)
- ☑ 快速开始指南



注意：若以上列出的任何一项配件有损坏或是短缺的情形，请尽快联系您的经销商。

认识您的无线路由器

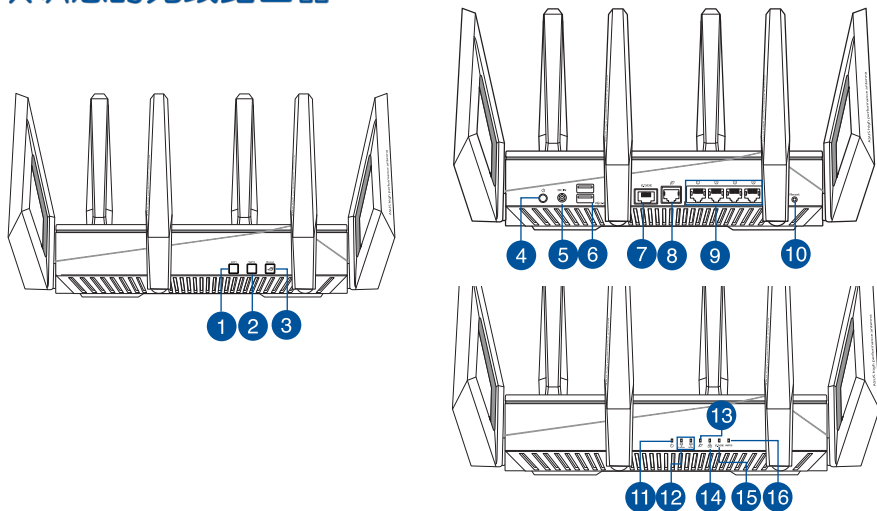

1. Wi-Fi 开启/关闭按钮	9. LAN 网络接口
2. WPS 按钮	10. 重置按钮
3. Boost Key	11. 电源指示灯
4. 电源开关	12. 2.4GHz / 5GHz Wi-Fi 指示灯
5. 电源输出口 (DC-IN)	13. WAN (互联网) 指示灯
6. USB 3.0 接口	14. LAN 指示灯
7. 2.5G 游戏接口	15. 2.5G 游戏接口指示灯
8. WAN (互联网) 接口	16. WPS 指示灯

规格

DC 电源适配器	DC 输出：+19V 电压，支持最大 3.42A 电流		
运行温度	0~40°C	保存温度	0~70°C
运行湿度	50~90%	保存湿度	20~90%

准备您的调制解调器

1. 拔出您的缆线/DSL 调制解调器的电源，若您的调制解调器内含备用电池，请移除电池。

注意： 若您使用 DSL 连接互联网，您需要向您的互联网服务供应商（ISP）取得登录名称/密码，以正确安装您的路由器。

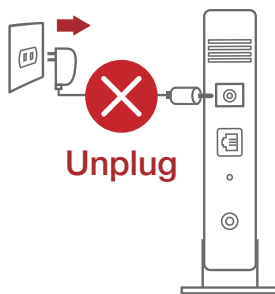

2. 使用附赠的网线连接您的调制解调器与路由器。

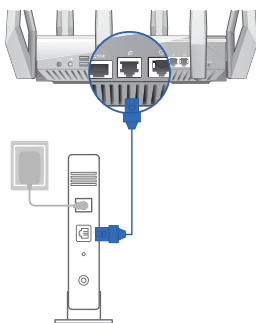

3. 开启您的缆线/DSL 调制解调器。
4. 检查您缆线/DSL 调制解调器上的指示灯，确认已经连接。

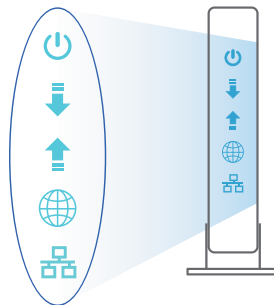

设置您的 ROG 路由器

您可以通过有线和无线两种方式来设置您的 ROG 路由器。

A. 有线连接

1. 将路由器连接到电源插座并开启电源。用网线 (2) 将您的电脑连接到路由器上的 LAN 接口。

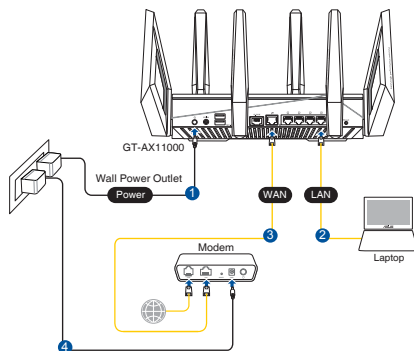

2. 当您打开网页浏览器时，网页设置界面会自动出现。若没有出现，请在网址栏中输入 <http://router.asus.com>。

3. 为路由器设置密码以防止未经授权的访问。

更改路由器密码，以防止未经授权客户端访问您的华硕无线路由器。

路由器登录名称

admin

新密码

重新输入密码

显示密码

B. 无线连接

1. 将路由器连接到电源插座并开启电源。

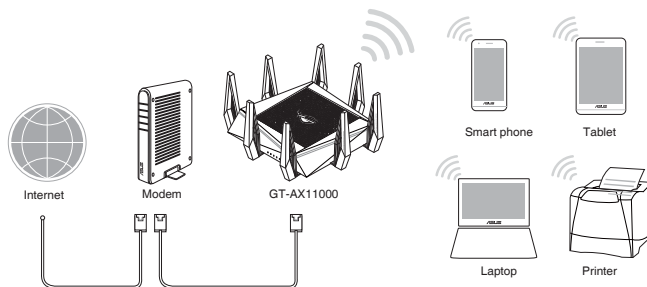

2. 连接到路由器后方标签上注明的网路名称 (SSID)。为确保最佳的网路安全性，请更改预设的 SSID 和密码。



2.4G Wi-Fi 名称 (SSID):	ASUS_XX_2G
5G-1 Wi-Fi 名称 (SSID):	ASUS_XX_5G
5G-2 Wi-Fi 名称 (SSID):	ASUS_XX_5G_Gaming

* XX 是 2.4GHz MAC 地址的最后两位数字。您可以在路由器底部的贴纸上找到。

3. 当您打开网页浏览器时，网页设置界面会自动出现。若没有出现，请在网址栏中输入 <http://router.asus.com>。
4. 为路由器设置密码以防止未经授权的访问。





记住无线路由器的设定

- 完成路由器的设置后，请记住您的无线设置。

路由器名称:	密码:
2.4 GHz 网络 SSID:	密码:
5GHz-1 网络 SSID:	密码:
5GHz-2 网络 SSID:	密码:

FAQ

1. 哪里可以找到更多的无线路由器信息？

- 线上支持及常见问题网址：<http://www.asus.com.cn/support/>
- 华硕支持网站：<http://www.asus.com.cn/support/>
- 客户服务热线：请参阅此快速使用指南中的支持热线



Contenu de la boîte

- Routeur Wi-Fi ROG GT-AX11000
- Adaptateur secteur
- Guide de démarrage rapide
- 8 * Antennes Wi-Fi
- Câble réseau (RJ-45)



REMARQUE : Si l'un des éléments est endommagé ou manquant, veuillez contacter votre revendeur.

Aperçu rapide de votre routeur ROG

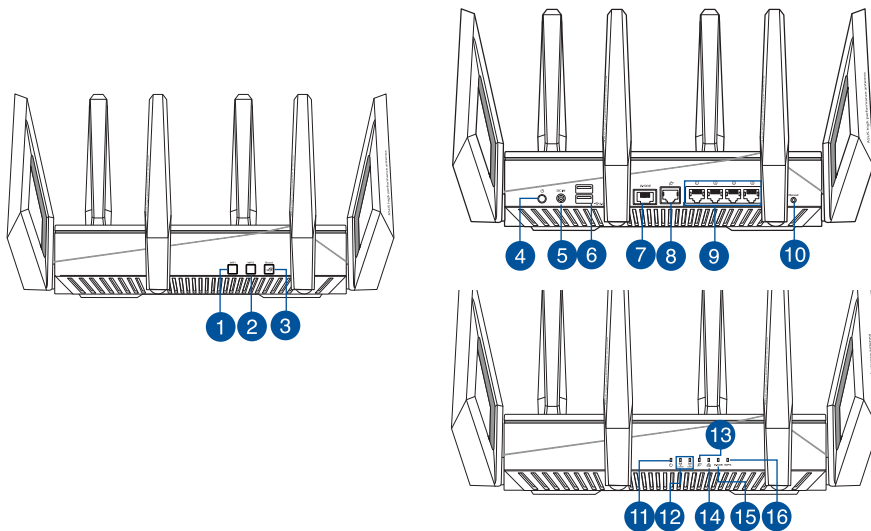

1. Bouton Wi-Fi	9. Ports réseau local (LAN)
2. Bouton WPS	10. Bouton de réinitialisation
3. Clé Boost	11. Voyant d'alimentation
4. Bouton d'alimentation	12. Voyant Wi-Fi de bande 2,4 GHz / 5 GHz
5. Port d'alimentation (CC)	13. Voyant réseau étendu (WAN) (Internet)
6. Ports USB 3.0	14. Voyant réseau local (LAN)
7. Port gaming 2.5G	15. Voyant de port gaming 2.5G
8. Port réseau étendu (WAN) (Internet)	16. Voyant WPS

Caractéristiques :

Adaptateur secteur CC	Sortie CC : +19V (max 3,42A)		
Température de fonctionnement	0-40°C	Stockage	0-70°C
Humidité de fonctionnement	50-90 %	Stockage	20-90 %

Préparer votre modem

1. **Débranchez le câble d'alimentation / le modem DSL. Si votre modem possède une batterie de secours, retirez-la.**

REMARQUE : Si vous utilisez le DSL pour accéder à Internet, vous aurez besoin du nom d'utilisateur et du mot de passe fournis par votre fournisseur d'accès internet (FAI) pour configurer votre routeur.

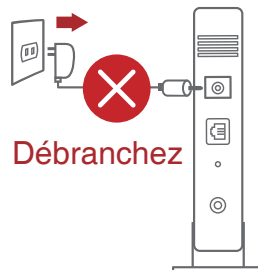

2. **Raccordez votre modem au routeur à l'aide du câble réseau fourni.**

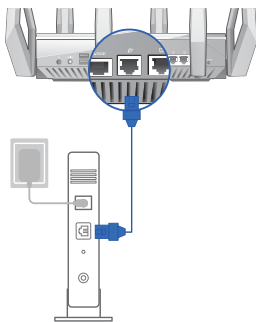

3. **Allumez votre modem câble/DSL.**
4. **Vérifiez les voyants lumineux de votre modem câble/DSL pour vous assurer que la connexion est établie.**

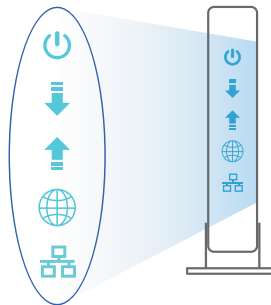

Configurer votre routeur ROG

Vous pouvez configurer votre routeur ROG via une connexion filaire ou Wi-Fi.

A. Connexion filaire

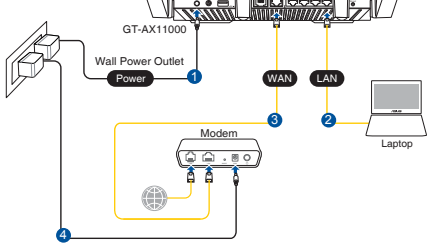
1. Branchez le routeur sur une prise électrique, puis allumez-le. Utilisez le câble réseau pour relier votre ordinateur au port de réseau local (LAN) du routeur.
- 
2. L'interface de gestion du routeur s'affiche automatiquement lors de l'ouverture de votre navigateur internet. Si ce n'est pas le cas, entrez <http://router.asus.com> dans la barre d'adresse.
 3. Définissez un mot de passe afin d'éviter les accès non autorisés au routeur.

Login Information Setup

Change the router password to prevent unauthorized access to your ASUS wireless router.

Router Login Name

New Password

Retype Password Show password

B. Connexion Wi-Fi

1. Branchez le routeur sur une prise électrique, puis allumez-le.

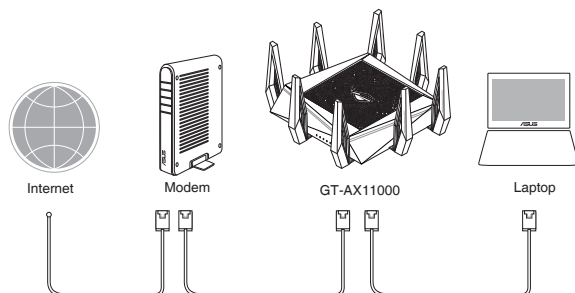

2. **Connectez-vous au réseau dont le nom (SSID) est affiché sur l'étiquette du produit située à l'arrière du routeur. Pour garantir une plus grande sécurité, modifiez le nom du réseau et le mot de passe.**



Nom du réseau Wi-Fi de 2,4 G (SSID) :	ASUS_XX_2G
Nom du réseau Wi-Fi de 5 G-1 (SSID) :	ASUS_XX_5G
Nom du réseau Wi-Fi de 5 G-2 (SSID) :	ASUS_XX_5G_Gaming

* **XX** correspond aux deux derniers chiffres de l'adresse MAC 2,4 GHz. Vous pouvez les trouver sur l'étiquette située à l'arrière de votre routeur ROG.

3. **Une fois connecté, l'interface de gestion du routeur s'affiche automatiquement lors de l'ouverture de votre navigateur internet. Si ce n'est pas le cas, entrez <http://router.asus.com> dans la barre d'adresse.**
4. **Définissez un mot de passe afin d'éviter les accès non autorisés au routeur.**

Login Information Setup

Change the router password to prevent unauthorized access to your ASUS wireless router.

Router Login Name

New Password

Retype Password Show password

Se rappeler des paramètres de votre routeur Wi-Fi

- Notez les paramètres Wi-Fi choisis lors de la configuration de votre routeur.

Nom du routeur :	Mot de passe :
Nom du réseau de 2,4 GHz (SSID) :	Mot de passe :
Nom du réseau de 5 GHz-1 (SSID) :	Mot de passe :
Nom du réseau de 5 GHz-2 (SSID) :	Mot de passe :

FAQ

1. Où puis-je obtenir plus d'informations sur le routeur Wi-Fi ?
 - FAQ en ligne : <http://support.asus.com/faq>
 - Site de support technique : <https://www.asus.com/support>
 - Service clientèle : Consultez la liste des centres d'appel ASUS en fin de guide



Isi kemasan

- ☑ ROG GT-AX11000
- ☑ 8* antenna wireless
- ☑ Adaptor AC
- ☑ Kabel jaringan (RJ-45)
- ☑ Panduan Ringkas



CATATAN: Jika salah satu item tersebut rusak atau tidak ada, hubungi peritel.

Panduan ringkas ROG

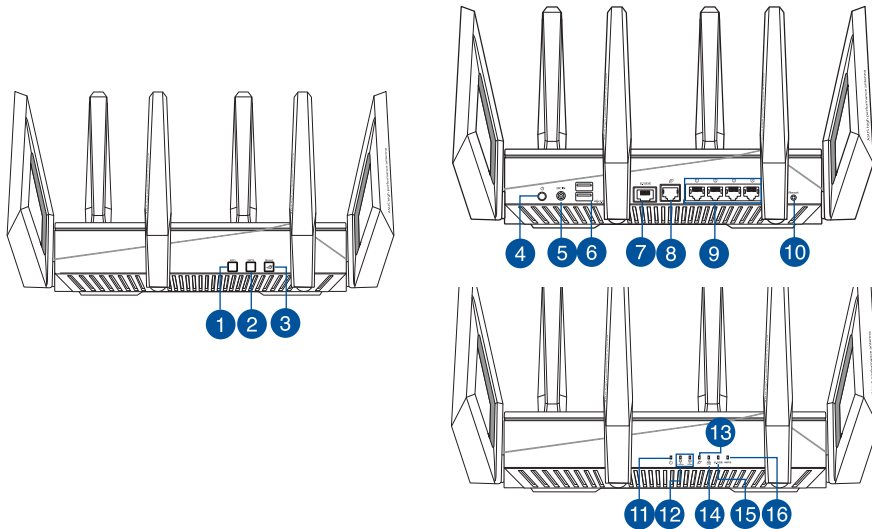

1. Tombol Wi-Fi hidup/mati	9. Port LAN
2. Tombol WPS	10. Tombol atur ulang
3. Tombol Boost	11. LED Daya
4. Tombol daya hidup/mati	12. LED Wi-Fi 2,4 GHz/5 GHz
5. Port daya (DC-IN)	13. LED WAN (Internet)
6. Port USB 3.0	14. LED LAN
7. Port Gaming 2,5 G	15. LED port Gaming 2,5 G
8. Port WAN (Internet)	16. LED WPS



Spesifikasi:

Adaptor daya DC	Output DC: +19 V dengan arus maks. 3,42 A		
Suhu Pengoperasian	0~40°C	Penyimpanan	0~70°C
Kelembaban Pengoperasian	50~90%	Penyimpanan	20~90%

Menyiapkan modem

1. Lepaskan modem DSL/kabel dari catu daya. Jika ada cadangan baterai, keluarkan baterai.

CATATAN: Jika menggunakan DSL untuk Internet, Anda memerlukan nama pengguna/ sandi dari Penyedia Layanan Internet (ISP) untuk mengkonfigurasi router dengan benar.

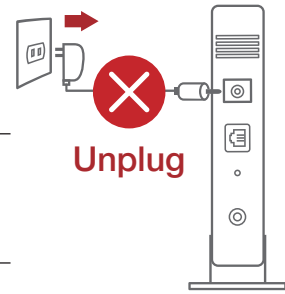

2. Sambungkan modem ke router dengan kabel jaringan yang tersedia.

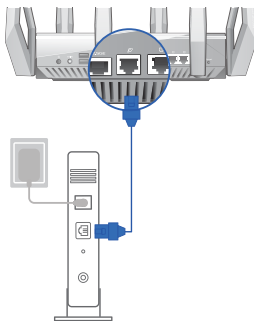

3. Hidupkan modem kabel/DSL.
4. Periksa lampu LED modem kabel/DSL untuk memastikan sambungan sudah aktif.

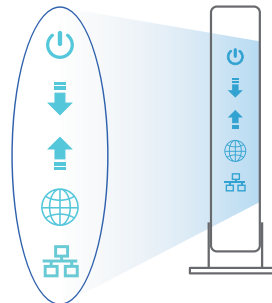

Mengkonfigurasi ROG

Anda dapat mengkonfigurasi router melalui sambungan berkabel atau nirkabel.

A. Sambungan berkabel:

1. Sambungkan router ke stopkontak dan hidupkan. Sambungkan kabel jaringan dari komputer ke port LAN pada router.

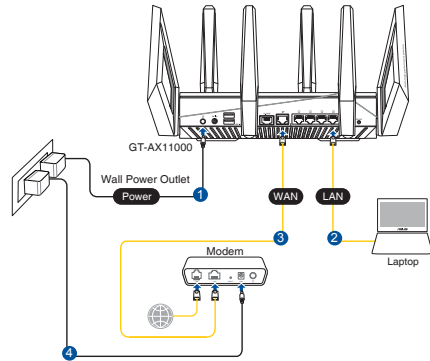

2. GUI web akan secara otomatis dijalankan saat Anda membuka browser web. Jika tidak secara otomatis dijalankan, buka <http://router.asus.com>.
3. Konfigurasikan sandi router untuk mencegah akses yang tidak sah.

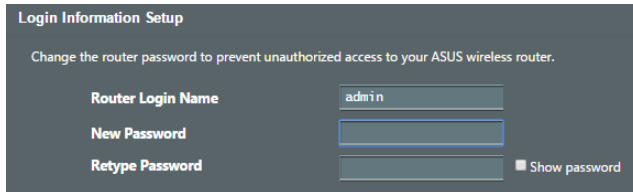

B. Sambungan Nirkabel

1. Sambungkan router ke stopkontak dan hidupkan.

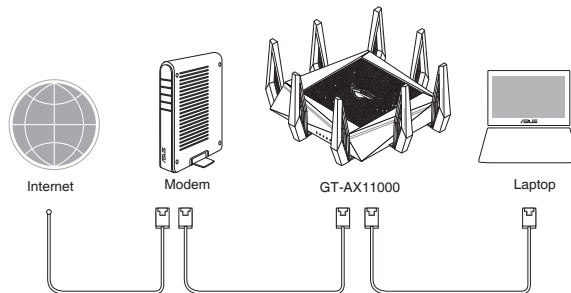

2. **Sambungkan ke nama jaringan (SSID) yang tertera pada label produk, di bagian belakang router. Untuk keamanan jaringan yang lebih baik, ubah menjadi SSID unik, lalu tetapkan sandi.**



Nama Wi-Fi 2,4 G (SSID):	ASUS_XX_2G
Nama Wi-Fi 5 G -1 (SSID):	ASUS_XX_5G
Nama Wi-Fi 5 G -2 (SSID):	ASUS_XX_5G_Gaming

* **XX** mengacu ke 2 angka terakhir pada alamat MAC 2,4 GHz. Anda dapat menemukannya pada label di bagian belakang ROG GT-AX11000.

3. **GUI web akan secara otomatis dijalankan saat Anda membuka browser web. Jika tidak secara otomatis dijalankan, buka <http://router.asus.com>.**
4. **Konfigurasi sandi router untuk mencegah akses yang tidak sah.**

Login Information Setup

Change the router password to prevent unauthorized access to your ASUS wireless router.

Router Login Name:

New Password:

Retype Password: Show password



Menyimpan pengaturan router nirkabel

- **Ingat pengaturan nirkabel setelah Anda menyelesaikan konfigurasi router.**

Nama Router:	Sandi:
SSID jaringan 2,4 GHz:	Sandi:
SSID jaringan 5 GHz-1:	Sandi:
SSID jaringan 5 GHz-2:	Sandi:

Tanya Jawab

1. Di mana saya dapat memperoleh informasi lengkap tentang router nirkabel?
 - Situs tanya jawab online: <http://support.asus.com/faq>
 - Situs Dukungan Teknis: <https://www.asus.com/support>
 - Hotline Pelanggan: Lihat Hotline Dukungan dalam Panduan Tambahan



パッケージの内容

- ROG GT-AX11000 無線ルーター
- アンテナ×8
- ACアダプター
- LANケーブル (RJ-45)
- クイックスタートガイド



注意: 万一、付属品が足りない場合や破損していた場合は、すぐにご購入元にお申し出ください。

各部の名称

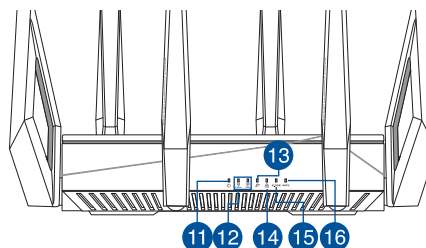
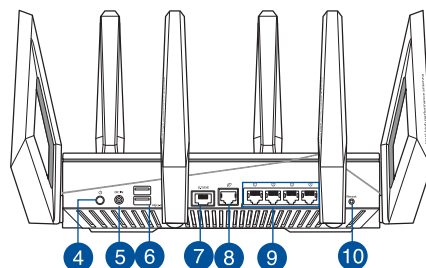
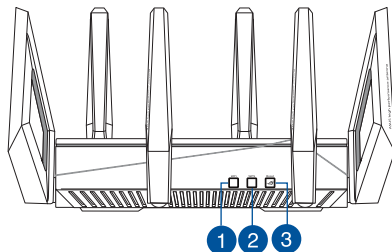

1. Wi-Fi オン/オフボタン	9. LAN ポート
2. WPS ボタン	10. リセットボタン
3. ブーストボタン	11. 電源LED
4. 電源ボタン	12. 2.4GHz / 5GHz Wi-Fi LED
5. 電源 (DC-IN) ポート	13. WAN (インターネット) LED
6. USB 3.0 ポート	14. LAN LED
7. 2.5G ゲーミングポート	15. 2.5G ゲーミングポートLED
8. WAN (インターネット) ポート	16. WPS LED

仕様:

電源 (DC) アダプター	DC出力: +19V (最大 3.42A)		
動作温度	0~40°C	保管	0~70°C
動作湿度	50~90%	保管	20~90%

セットアップを行う前に

1. モデム/回線終端装置のプラグを抜きます。バッテリーバックアップがある場合は、バッテリーを取り外します。

注意: インターネットの接続タイプや接続ユーザー名、接続パスワードなどについては、ご契約のISP (インターネットサービスプロバイダー) へお問い合わせください。

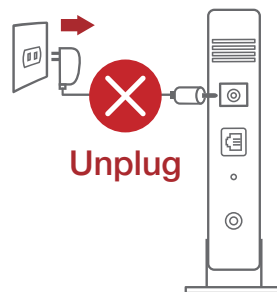

2. 付属のLANケーブルでモデム/回線終端装置とルーターのWANポートを接続します。

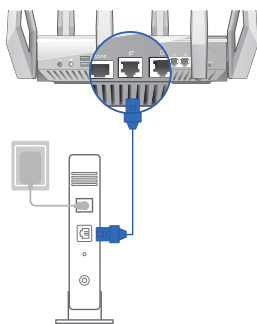

3. モデム/回線終端装置の電源を入れます。
4. モデム/回線終端装置のLEDが点灯していることを確認し、接続が有効であることを確認します。

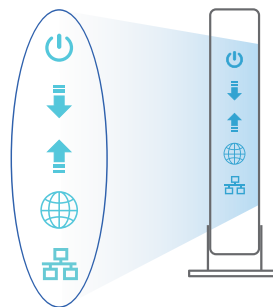

ルーターのセットアップ

ルーターは有線/無線環境のいずれでも設定可能です。

A. 有線接続

1. ルーターに電源ケーブルを接続し、電源を入れます。ルーターのLANポートとコンピューターをLANケーブルで接続します。
2. 接続された後にWebブラウザを開くと、クイックインターネットセットアップ (QIS) のページが自動的に起動します。自動的に起動しない場合は、Webブラウザのアドレス欄に「<http://router.asus.com>」または「192.168.50.1」を入力してください。
3. 不正なアクセスを防ぐため、パスワードを設定してください。

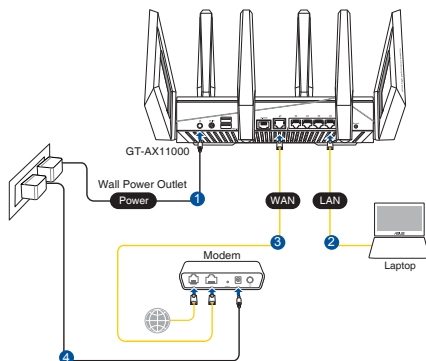

Login Information Setup

Change the router password to prevent unauthorized access to your ASUS wireless router.

Router Login Name

New Password

Retype Password Show password

B. 無線接続

1. ルーターに電源ケーブルを接続し、電源を入れます。

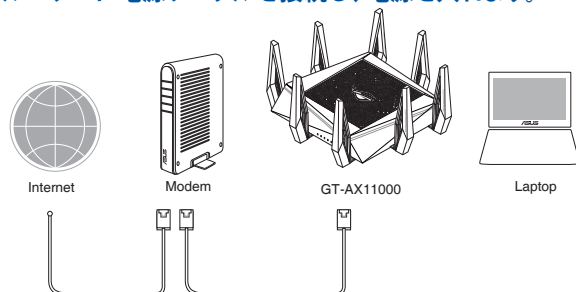

2. ルーター背面の製品ラベルに記載されているネットワーク名 (SSID) のネットワークに接続します。



2.4G Wi-Fi 名 (SSID):	ASUS_XX_2G
5G-1 Wi-Fi 名 (SSID):	ASUS_XX_5G
5G-2 Wi-Fi 名 (SSID):	ASUS_XX_5G_Gaming

* 「XX」は2.4GHz MACアドレスの最後の2桁を意味します。ルーター背面のラベルに記載があります。

3. 接続された後にWebブラウザを開くと、クイックインターネットセットアップ (QIS) のページが自動的に起動します。自動的に起動しない場合は、Webブラウザのアドレス欄に「<http://router.asus.com>」または「192.168.50.1」を入力してください。
4. 不正なアクセスを防ぐため、パスワードを設定してください。

Login Information Setup

Change the router password to prevent unauthorized access to your ASUS wireless router.

Router Login Name

New Password

Retype Password Show password

無線設定を下記に書き留めてください。

ルーター名:	パスワード:
2.4 GHz ネットワーク SSID:	パスワード:
5GHz-1 ネットワーク SSID:	パスワード:
5GHz-2 ネットワーク SSID:	パスワード:

FAQ

1. 製品情報について教えてください。
 - オンラインFAQサイト: <https://www.asus.com/support>
 - サポートサイト: <https://www.asus.com/support>
 - サポート・ホットライン: 本書の一覧表をご参照ください。
 - ユーザーマニュアルは次のURLからダウンロード可能です。
<https://www.asus.com/support>



패키지 내용

- ☑️ ROG GT-AC11000 무선 라우터
 - ☑️ AC 어댑터
 - ☑️ 빠른 시작 가이드
- ☑️ 8* 개의 무선 안테나
 - ☑️ 네트워크 케이블 (RJ-45)



참고: 항목 중 하나가 손상되거나 누락된 경우, 판매점에 문의하십시오.

라우터 개요

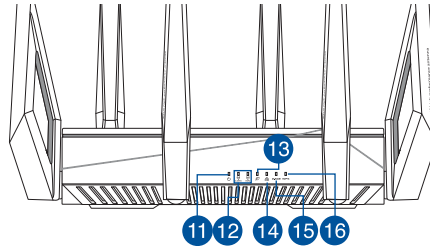
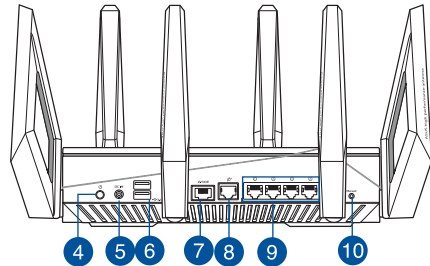
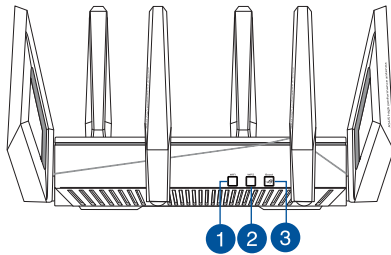

1. Wi-Fi On/Off 버튼	9. LAN 포트
2. WPS 버튼	10. 리셋 버튼
3. 부스트 키	11. 전원 LED
4. 전원 버튼	12. 2.4GHz/5GHz Wi-Fi LED
5. 전원 (DC-IN) 포트	13. WAN (인터넷) LED
6. USB 3.0 포트	14. LAN LED
7. 2.5G 게이밍 포트	15. 2.5G 게이밍 포트 LED
8. WAN (인터넷) 포트	16. WPS LED



사양:

DC 전원 어댑터	DC 출력: 최대 3.42A 전류에서 +19V		
작동 온도	0~40°C	보관	0~70°C
작동 습도	50~90%	보관	20~90%

모뎀 준비하기

1. 전원 케이블/DSL 모뎀을 분리합니다. 배터리 백업이 있는 경우 배터리를 제거합니다.

참고: 인터넷용 DSL를 사용하는 경우 라우터를 올바르게 구성하려면 인터넷 서비스 제공자 (ISP)에서 제공한 사용자 이름/비밀번호가 필요합니다.

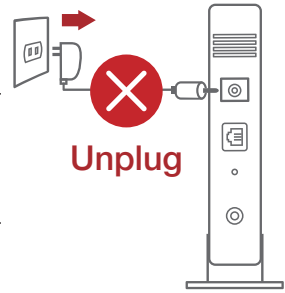

2. 번들로 제공된 네트워크 케이블을 사용하여 모뎀을 라우터에 연결합니다.

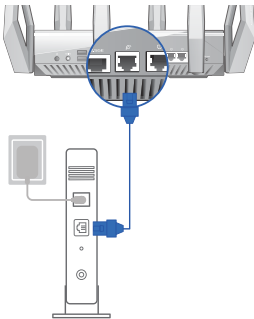

3. 케이블/DSL 모뎀의 전원을 켭니다.
4. 케이블/DSL 모뎀 LED 표시등을 보고 연결이 활성화되었는지 확인합니다.

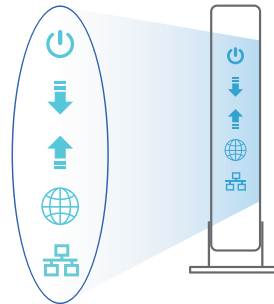

라우터 설정하기

유선 또는 무선 연결을 통해 라우터를
설정할 수 있습니다.

A. 유선 연결

1. 라우터를 전원 콘센트에 연결하고 전원을 켭니다. 네트워크 케이블을 사용하여 컴퓨터와 라우터의 LAN 포트를 연결합니다.
2. 웹 브라우저를 열면 웹 GUI가 자동으로 시작됩니다. 자동으로 시작되지 않으면 <http://router.asus.com>으로 들어갑니다.
3. 무단 액세스를 방지하기 위해 라우터의 비밀번호를 설정합니다.

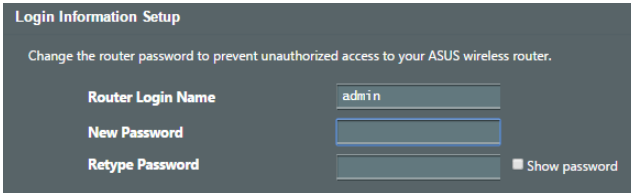
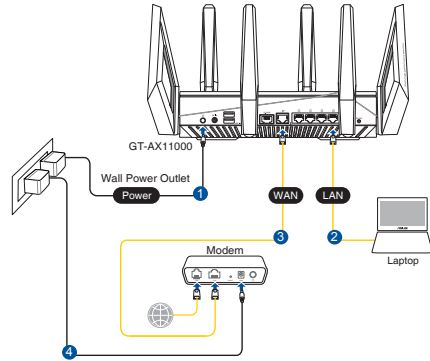

B. 무선 모드

1. 라우터를 전원 콘센트에 연결하고 전원을 켭니다.

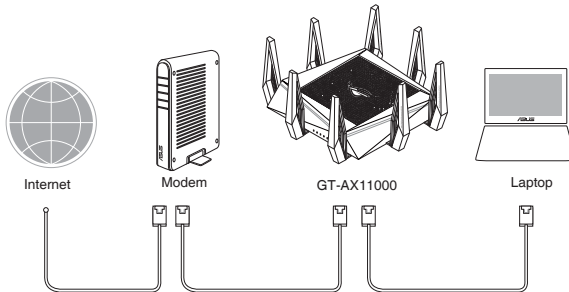

2. 라우터 뒷면의 제품 라벨에 표시된 네트워크 이름(SSID)에 연결합니다. 네트워크 보안을 강화하기 위해 고유한 SSID로 변경하고 비밀번호를 지정합니다.



2.4G Wi-Fi 이름(SSID):	ASUS_XX_2G
5G-1 Wi-Fi 이름 (SSID):	ASUS_XX_5G
5G-2 Wi-Fi 이름 (SSID):	ASUS_XX_5G_Gaming

* **XX**은(는) 2.4GHz MAC 주소의 마지막 두 자릿수를 참조합니다. 이는 라우터 뒷면의 라벨에서 확인할 수 있습니다.

3. 연결된 경우 웹 브라우저를 열면 웹 GUI가 자동으로 시작됩니다. 자동으로 시작되지 않으면 <http://router.asus.com>으로 들어갑니다.
4. 무단 액세스를 방지하기 위해 라우터의 비밀번호를 설정합니다.

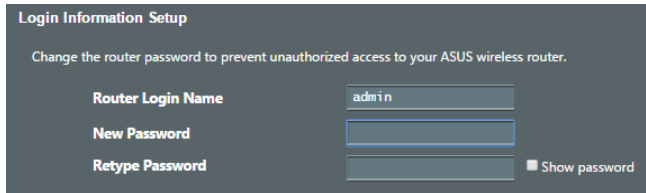



무선 라우터 설정 기억하기

- 라우터 설정을 완료할 때 무선 설정을 기억해두십시오.

라우터 이름:	비밀번호:
2.4 GHz 네트워크 SSID:	비밀번호:
5GHz-1 네트워크 SSID:	비밀번호:
5GHz-2 네트워크 SSID:	비밀번호:

자주 묻는 질문 (FAQs)

1. 무선 라우터에 관한 더 자세한 정보는 어디에서 찾을 수 있습니까?

- 온라인 FAQ 사이트: <http://support.asus.com/faq>
- 기술 지원 사이트: <https://www.asus.com/support>
- 고객 핫라인: 빠른 시작 안내서 내의 지원 핫라인을 참조하십시오.



Kandungan pembungkusan

- ✓ ROG GT-AX11000
- ✓ Penyesuai AU
- ✓ Panduan Mula Ringkas
- ✓ 8 * antena wayarles
- ✓ Kabel rangkaian (RJ-45)



NOTA: Jika mana-mana daripada item ini rosak atau hilang, hubungi penjual anda.

Melihat sepintas Lalu ROG anda

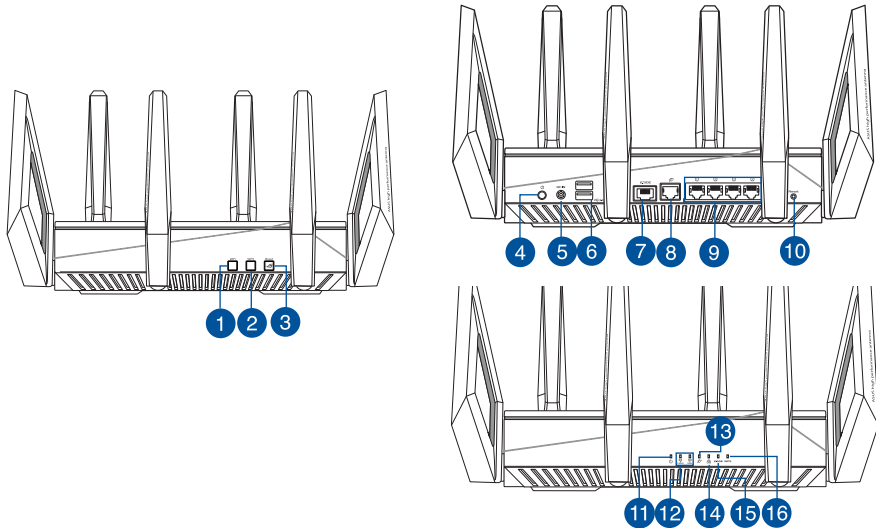

1. Butang Hidup/Mati Wi-Fi	9. Port LAN
2. Butang WPS	10. Butang tetapkan semula
3. Kekunci Galakan	11. LED Kuasa
4. Suis kuasa	12. LED Wi-Fi 2.4GHz / 5GHz
5. Port kuasa (DC-In) (AT-Masuk)	13. WAN (Internet) LED
6. Port USB 3.0	14. LAN LED
7. Port Permainan 2.5G	15. LED port Permainan 2.5G
8. Port WAN (Internet)	16. WPS LED

Spesifikasi::

Adapter Kuasa DC	Output DC: +19V dengan arus maksimum 3.42A		
Suhu Pengendalian	0~40°C	Penyimpanan	0~70°C
Kelembapan Operasi	50~90%	Penyimpanan	20~90%

Menyediakan modem anda

1. Cabut palam kabel kuasa/modem DSL. Jika ia mempunyai sandaran bateri, keluarkan bateri.

NOTA: Jika anda menggunakan DSL untuk Internet, anda akan memerlukan nama pengguna/kata laluan anda daripada Pembekal Perkhidmatan Internet (ISP) anda untuk mengkonfigurasi penghalang dengan betul.

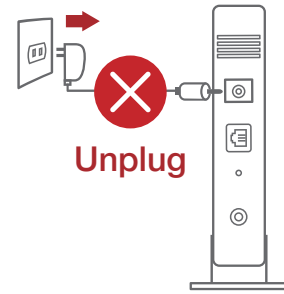

2. Sambung modem anda ke penghalang dengan kabel rangkaian yang digabungkan.

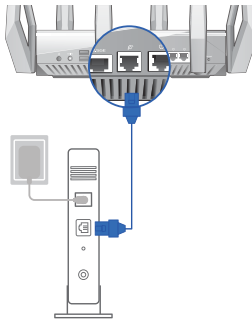

3. Hidupkan kuasa kabel/modem DSL anda.
4. Semak kabel/lampu LED modem DSL anda untuk memastikan sambungan adalah aktif.

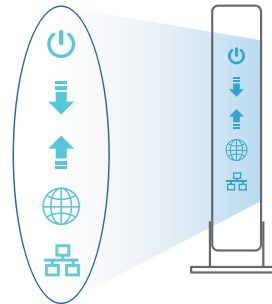

Menyediakan ROG anda

Anda boleh menyediakan penghala anda melalui sambungan berwayar atau wayarles.

A. Sambungan berwayar

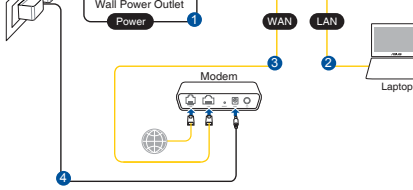
1. Pasang masuk penghala anda ke sumber kuasa dan hidupkan kuasanya. Sambungkan kabel rangkaian dari komputer anda ke port LAN pada penghala anda.
- 
2. GUI web dilancarkan secara automatik apabila anda membuka pelayar web. Jika ia tidak melakukan pelancaran auto, masuki <http://router.asus.com>.
 3. Sediakan kata laluan untuk penghala anda bagi menghalang akses yang tidak dibenarkan.

Login Information Setup

Change the router password to prevent unauthorized access to your ASUS wireless router.

Router Login Name

New Password

Retype Password Show password

B. Sambungan wayarles

1. Pasang masuk penghala anda ke sumber kuasa dan hidupkan kuasanya.

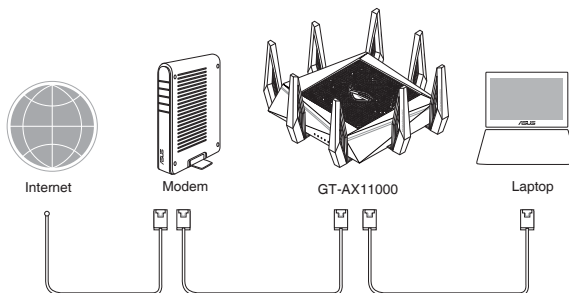

2. **Sambung ke nama rangkaian (SSID) yang ditunjukkan pada label produk di bahagian belakang penghala. Untuk keselamatan rangkaian yang lebih baik, ubah ke SSID unik dan berikan kata laluan.**



Nama Wi-Fi 2.4G (SSID): ASUS_XX_2G

Nama Wi-Fi 5G-1 (SSID): ASUS_XX_5G

Nama Wi-Fi 5G-2 (SSID): ASUS_XX_5G_Gaming

- * **XX** merujuk pada dua digit terakhir alamat MAC 2.4GHz. Anda boleh menemuinya pada label di belakang penghala anda.

3. **GUI web dilancarkan secara automatik apabila anda membuka pelayar web. Jika ia tidak melakukan pelancaran auto, masuki <http://router.asus.com>.**
4. **Sediakan kata laluan untuk penghala anda bagi menghalang akses yang tidak dibenarkan.**

Login Information Setup

Change the router password to prevent unauthorized access to your ASUS wireless router.

Router Login Name	<input type="text" value="admin"/>
New Password	<input type="password"/>
Retype Password	<input type="password"/> <input type="checkbox"/> Show password

Mengingati tetapan penghala wayarles anda

- Ingat tetapan wayarles anda apabila anda melengkapkan penyediaan penghala.

Nama Penghala:	Kata Laluan:
SSID rangkaian 2.4GHz:	Kata Laluan:
SSID rangkaian 5GHz-1:	Kata Laluan:
SSID rangkaian 5GHz-2:	Kata Laluan:

FAQ

1. Di manakah saya boleh mendapatkan maklumat lanjut mengenai penghala tanpa wayar?
 - Tapak FAQ dalam talian: <http://support.asus.com/faq>
 - Tapak Sokongan Teknikal: <https://www.asus.com/support>
 - Hotline Pelanggan: Rujuk Hotline Sokongan dalam Panduan Mula Pantas ini

Contenido del paquete

- ✓ ROG GT-AX11000
- ✓ AC adapter
- ✓ Guía de inicio rápido
- ✓ 8*antenas inalámbricas
- ✓ Cable de red (RJ-45)



NOTA: Si alguno de los artículos falta o se encuentra dañado, póngase en contacto con su distribuidor.

Un vistazo rápido a su ROG GT-AX11000

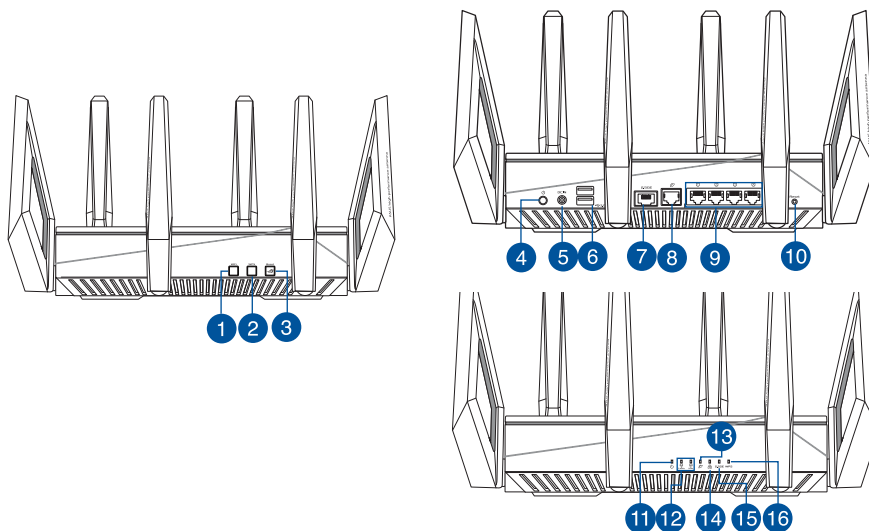

1. Botón Activar/Desactivar Wi-Fi	9. LAN puertos
2. Botón WPS	10. Botón Restablecer
3. Botón de aumento	11. LED de alimentación
4. Vypínaè	12. LED de 2.4 GHz / 5GHz
5. Puerto de alimentación (DC-IN)	13. WAN LED (Internet)
6. USB 3.0 Puertos	14. LED LAN
7. Puerto de juegos 2.5G	15. LED del puerto de juegos 2.5G
8. WAN (Internet) port	16. LED WPS

Especificaciones:

Adaptador de alimentación de CC	Salida de CC: +19 V con una corriente máxima de 3.42 A		
Temperatura de funcionamiento	0~40°C	Almacenamiento	0~70°C
Humedad de funcionamiento	50~90%	Almacenamiento	20~90%

Preparar el módem

- Desenchufe la alimentación del módem de cable o DSL. Si tiene una batería de reserva, quítela.**

NOTA: Si utiliza DSL para Internet, necesitará el nombre de usuario y la contraseña de su proveedor de servicio de Internet (ISP) para configurar adecuadamente el router.

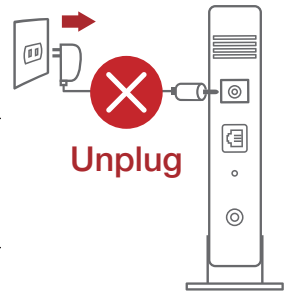

- Conecte el módem al router con el cable de red proporcionado.**

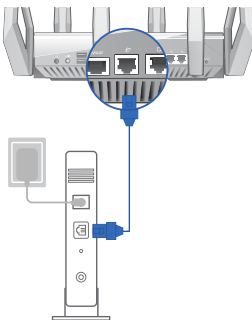

- Encienda su módem de cable o DSL.**
- Compruebe las luces de los LED del módem de cable o DLS para asegurarse de que la conexión está activa.**

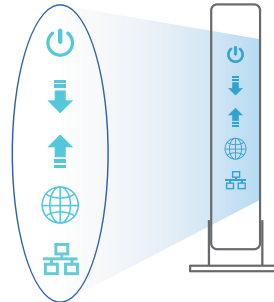

Configurar el router ROG

Puede configurar el router ROG a través de la conexión cableada o inalámbrica.

A. Conexión cableada

1. Enchufe el router a una toma de corriente eléctrica y enciéndalo. Conecte el cable de red desde el equipo a un puerto LAN del router.

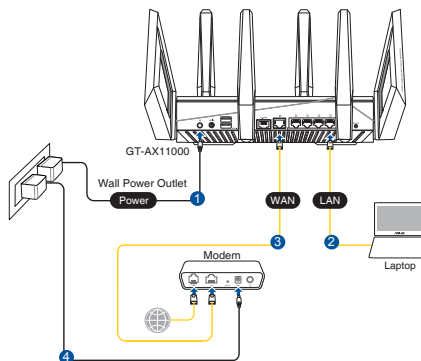

2. La GUI Web se inicia automáticamente cuando abre un explorador Web. Si no se inicia automáticamente, escriba <http://router.asus.com>.
3. Configure una contraseña para el router para evitar el acceso no autorizado.

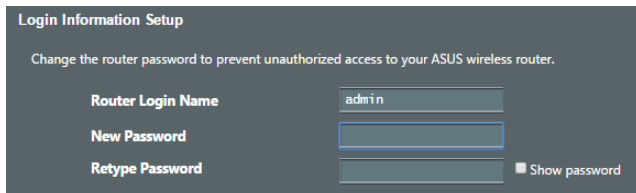

B. Conexión inalámbrica

1. Enchufe el router a una toma de corriente eléctrica y enciéndalo.

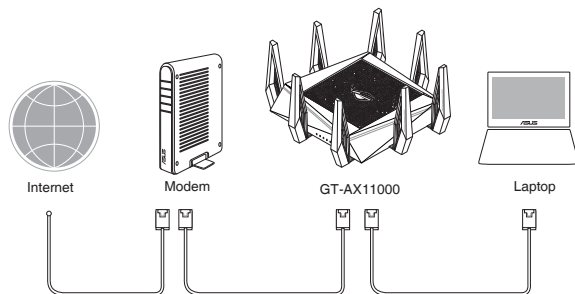

Español

2. **Conéctese al nombre de red (SSID) mostrado en la etiqueta del producto que se encuentra en la parte posterior del router. Para mejorar la seguridad de la red, cambie a un SSID único y asigne una contraseña.**



Nombre Wi-Fi 2.4 GHz ASUS_XX_2G
(SSID):

Nombre Wi-Fi 5GHz-1 ASUS_XX_5G
(SSID):

Nombre Wi-Fi 5GHz-2 ASUS_XX_5G_Gaming
(SSID):

- * **XX** y hace referencia a los dos últimos dígitos de la dirección MAC de 2.4 GHz. Puede encontrarlo en la etiqueta situada en la parte posterior del router ROG.

3. **La GUI Web se inicia automáticamente cuando abre un explorador Web. Si no se inicia automáticamente, escriba <http://router.asus.com>.**
4. **Configure una contraseña para el router para evitar el acceso no autorizado.**

Login Information Setup

Change the router password to prevent unauthorized access to your ASUS wireless router.

Router Login Name

New Password

Retype Password Show password



Recordar la configuración del router inalámbrico

- **Recuerde la configuración inalámbrica cuando complete la configuración del router.**

Nombre del router:	Contraseña:
SSID de red de 2,4 GHz:	Contraseña:
SSID de red de 5 GHz - 1:	Contraseña:
SSID de red de 5 GHz - 2:	Contraseña:

FAQ

1. ¿De qué otros recursos dispongo para obtener más información acerca del router inalámbrico?
 - El sitio web de preguntas más frecuentes: <http://support.asus.com/faq>
 - El sitio web de soporte técnico: <https://www.asus.com/support>
 - Línea Directa: Consulte el número de la línea telefónica de soporte técnico en esta Guía de inicio rápido.



สิ่งต่างๆ ในกล่องบรรจุ

- ☑ เราเตอร์แบบไร้สาย ROG GT-AX11000
- ☑ 8 * เส้าอากาศไร้สาย
- ☑ อะแดปเตอร์ AC
- ☑ สายเคเบิลเครือข่าย (RJ-45)
- ☑ คู่มือเริ่มต้นอย่างรวดเร็ว



หมายเหตุ: ถ้ามีรายการใดๆ เสียหายหรือหายไป ให้ติดต่อร้านค้าของคุณ

ส่วนประกอบของ ROG

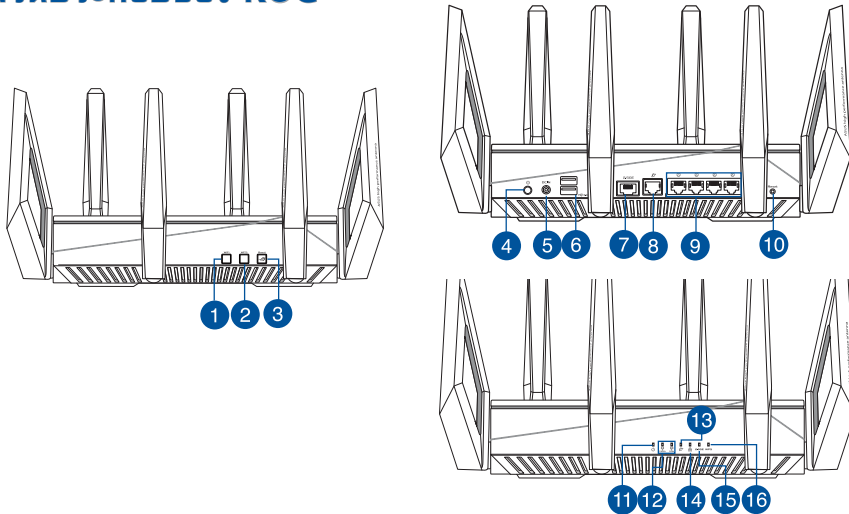

1. ปุ่มเปิด/ปิด Wi-Fi	9. พอร์ต LAN
2. ปุ่ม WPS	10. ปุ่มรีเซ็ต
3. คีย์การเพิ่ม	11. LED เพาเวอร์
4. ปุ่มเปิด / ปิด	12. LED Wi-Fi 2.4GHz / 5GHz
5. พอร์ตเพาเวอร์ (DC-เข้า)	13. LED WAN (อินเทอร์เน็ต)
6. พอร์ต USB 3.0	14. LAN LED
7. พอร์ตเกมมิ่ง 2.5G	15. LED พอร์ตเกมมิ่ง 2.5G
8. พอร์ต WAN (อินเทอร์เน็ต)	16. WPS LED

ข้อมูลจำเพาะ:

อะแดปเตอร์เพาเวอร์ DC	เอาต์พุต DC: +19V โดยมีกระแสสูงสุด 3.42A		
อุณหภูมิขณะทำงาน	0~40°C	ขณะเก็บรักษา	0~70°C
ความชื้นขณะทำงาน	50~90%	ขณะเก็บรักษา	20~90%

การเตรียมโมเด็มของคุณ

1. ถอดสายไฟ/โมเด็ม DSL หากมีแบตเตอรี่สำรอง ให้ถอดแบตเตอรี่ออก

หมายเหตุ: หากคุณใช้ DSL สำหรับอินเทอร์เน็ต คุณต้องมีชื่อผู้ใช้/รหัสผ่านจากผู้ให้บริการอินเทอร์เน็ต (ISP) เพื่อกำหนดค่าเราเตอร์ อย่างถูกต้อง

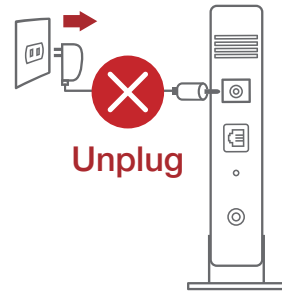

2. เชื่อมต่อโมเด็มของคุณเข้ากับเราเตอร์ด้วยสายเคเบิลเครือข่ายที่ใหม่

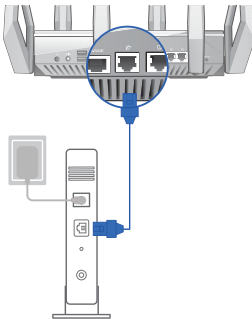

3. เปิดเดมเบล/โมเด็ม DSL
4. ตรวจสอบไฟ LED ของเดมเบล/โมเด็ม DSL เพื่อให้ความสนใจจากการเชื่อมต่อทำงานอยู่

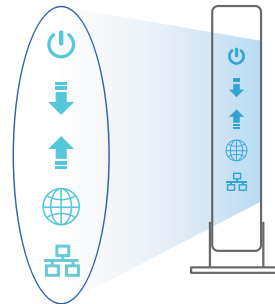

การตั้งค่า ROG

คุณสามารถตั้งค่าเราเตอร์ ผ่านการเชื่อมต่อแบบมีสายหรือไร้สาย:

A. การเชื่อมต่อแบบมีสาย:

- เสียบเราเตอร์เข้ากับเต้าเสียบและ เปิดเครื่อง เชื่อมต่อสายเคเบิลเครือข่ายจากคอมพิวเตอร์ไปยัง พอร์ต LAN บนเราเตอร์ของคุณ

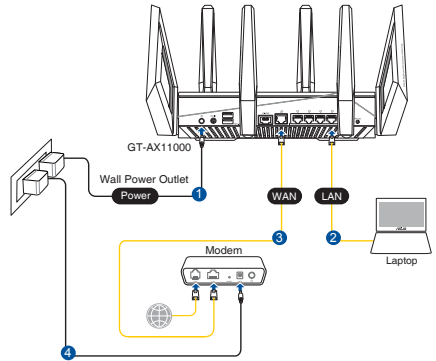

- เว็บ GUI จะเปิดใช้งานโดยอัตโนมัติเมื่อคุณเปิดเว็บเบราว์เซอร์ หากไม่เปิดใช้งานโดยอัตโนมัติ เข้าไปที่ <http://router.asus.com>
- ตั้งค่ารหัสผ่านสำหรับเราเตอร์ของคุณเพื่อความปลอดภัยจากการเข้าถึงที่ไม่ได้รับอนุญาต

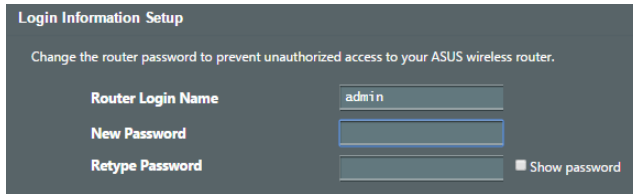

B. การเชื่อมต่อไร้สาย

- เสียบเราเตอร์เข้ากับเต้าเสียบและ เปิดเครื่อง

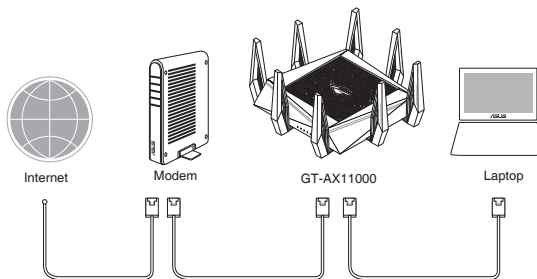

2. เชื่อมต่อกับชื่อเครือข่าย (SSID) ที่แสดงบนฉลากผลิตภัณฑ์ที่ด้านหลังของเราเตอร์ เพื่อการรักษาความปลอดภัยของเครือข่ายที่ดีกว่า เปลี่ยนเป็น SSID ที่มีลักษณะเฉพาะและกำหนดรหัสผ่าน



ชื่อ Wi-Fi 2.4G (SSID):	ASUS_XX_2G
ชื่อ Wi-Fi 5G-1 (SSID):	ASUS_XX_5G
ชื่อ Wi-Fi 5G-2 (SSID):	ASUS_XX_5G_Gaming

* **XX** หมายถึงตัวเลขสองหลักสุดท้ายของ MAC แอดเดรส 2.4GHz คุณสามารถค้นหาได้บนฉลากด้านหลังของ ROG GT-AX11000

3. เมื่อเชื่อมต่อแล้ว เว็บ GUI จะเปิดใช้งานโดยอัตโนมัติเมื่อคุณเปิดเว็บเบราว์เซอร์ หากไม่เปิดใช้งานโดยอัตโนมัติ เข้าไปที่ <http://router.asus.com>
4. ตั้งค่ารหัสผ่านสำหรับเราเตอร์ของคุณเพื่อความปลอดภัยจากการเข้าถึงที่ไม่ได้รับอนุญาต

Login Information Setup

Change the router password to prevent unauthorized access to your ASUS wireless router.

Router Login Name

New Password

Retype Password Show password

การจดจำการตั้งค่าเราเตอร์ไร้สาย

- จดจำการตั้งค่าไร้สายของคุณเมื่อคุณเสร็จสิ้นการตั้งค่าเราเตอร์

ชื่อเราเตอร์:	รหัสผ่าน:
SSID ของเครือข่าย 2.4 GHz:	รหัสผ่าน:
SSID ของเครือข่าย 5G Hz-1:	รหัสผ่าน:
SSID ของเครือข่าย 5G Hz-2:	รหัสผ่าน:

คำถามที่ถามบ่อย

1. สามารถหาข้อมูลเพิ่มเติมเกี่ยวกับเราเตอร์แบบไร้สายได้จากที่ไหน?
 - ไซต์ FAQ ออนไลน์: <http://support.asus.com/faq>
 - ไซต์สนับสนุนด้านเทคนิค: <https://www.asus.com/support>
 - สายด่วนบริการลูกค้า: ดูที่หัวข้อสายด่วนบริการในคู่มือเริ่มต้นอย่างรวดเร็วนี้

Các phụ kiện kèm theo hộp

- Router không dây ROG GT-AX11000
- 8 ăng ten không dây
- Adapter AC (điện xoay chiều)
- Cáp mạng (RJ-45)
- Tờ hướng dẫn khởi động nhanh



LƯU Ý: Nếu có bất kỳ phụ kiện nào bị hỏng hoặc thiếu, hãy liên hệ với đại lý bán hàng.

Nhìn sơ lược ROG

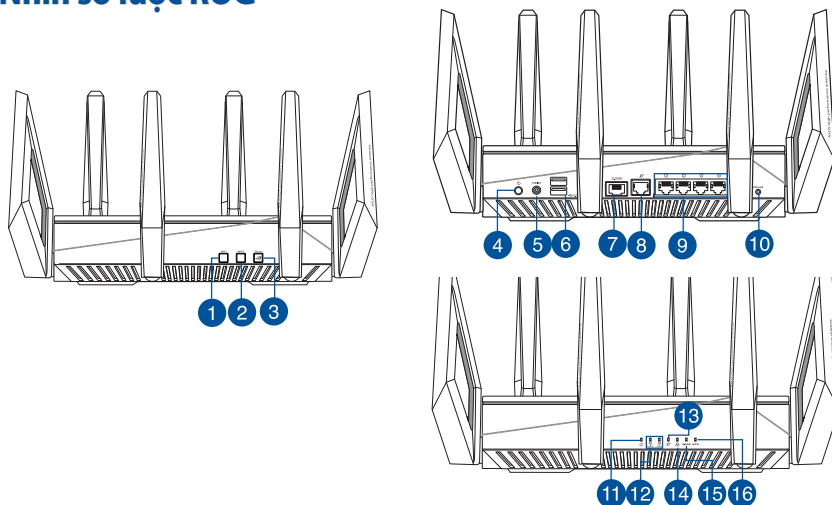

1. Nút bật/tắt Wi-Fi	9. Cổng LAN
2. Nút WPS	10. Nút khởi động lại
3. Phím tăng tốc	11. Đèn LED nguồn
4. Nút bật/tắt nguồn	12. Đèn LED Wi-Fi 2.4GHz/5GHz
5. Cổng nguồn (DC-IN)	13. Đèn LED WAN (Internet)
6. Cổng USB 3.0	14. Đèn LED LAN
7. Cổng chơi game 2.5G	15. Đèn LED cổng chơi game 2.5G
8. Cổng WAN (Internet)	16. Đèn LED WPS

Thông số kỹ thuật:

Adapter nguồn DC	Đầu ra DC: +19V với dòng điện tối đa 3.42A		
Nhiệt độ hoạt động	0~40°C	Bảo quản	0~70°C
Độ ẩm hoạt động	50~90%	Bảo quản	20~90%

Chuẩn bị modem

- Ngắt cáp nguồn/modem DSL. Nếu có dùng pin dự phòng, hãy tháo pin ra.**

LƯU Ý: Nếu đang sử dụng DSL cho internet, bạn cần có tên người dùng/mật khẩu từ Nhà cung cấp Dịch vụ Internet (ISP) để thiết lập router đúng cách.

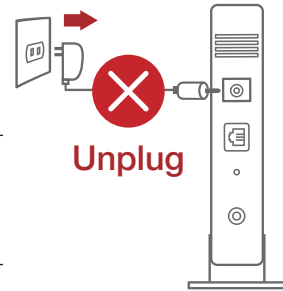

- Kết nối modem của bạn với router bằng cáp mạng kèm theo.**
- Bật nguồn modem cáp/DSL.**
- Kiểm tra ánh sáng đèn LED trên modem cáp/DSL để đảm bảo kết nối đang hoạt động.**

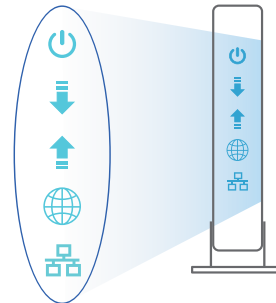
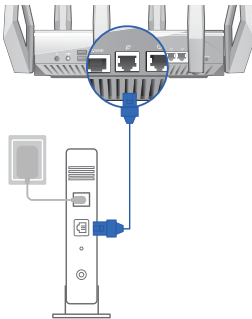

Thiết lập router ROG

Để thiết lập router LTE qua kết nối có dây hoặc không dây.

A. Kết nối có dây:

1. Cắm router vào ổ cắm điện và bật nguồn router. Cắm cáp mạng từ máy tính vào cổng LAN trên router.

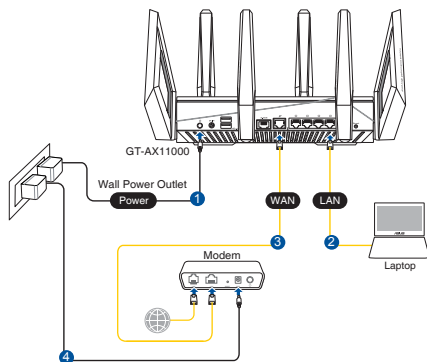

2. GUI (giao diện người dùng đồ họa) web sẽ tự động bật lên khi bạn mở trình duyệt web. Nếu nó không tự động bật lên, hãy nhập <http://router.asus.com>.
3. Thiết lập mật khẩu cho router để ngăn chặn truy cập trái phép.

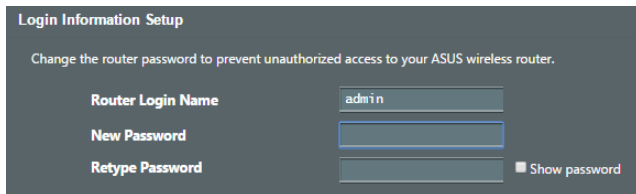

B. Kết nối mạng không dây

1. Cắm router vào ổ cắm điện và bật nguồn router.

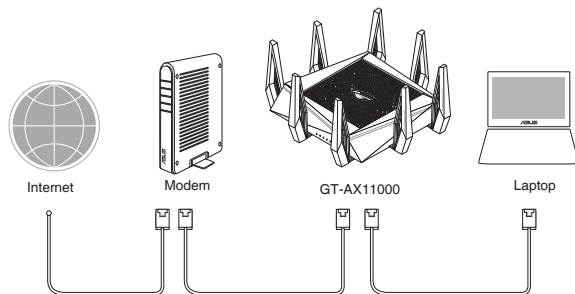

Tiếng Việt

2. **Kết nối với tên mạng (SSID) in trên nhãn sản phẩm ở phía sau router. Để bảo mật mạng tốt hơn, hãy đổi sang SSID duy nhất và gán một mật khẩu.**



Tên Wi-Fi 2.4G (SSID):	ASUS_XX_2G
Tên Wi-Fi 5G-1 (SSID):	ASUS_XX_5G
Tên Wi-Fi 5G-2 (SSID):	ASUS_XX_5G_Gaming

* **XX** để cập đến hai số cuối của địa chỉ MAC 2.4GHz. Bạn có thể tìm thấy nó trên nhãn ở mặt sau router ROG GT-AX11000.

3. **Một khi đã kết nối, GUI web sẽ tự động bật lên khi bạn mở trình duyệt web. Nếu nó không tự động bật lên, hãy nhập <http://router.asus.com>.**
4. **Thiết lập mật khẩu cho router để ngăn chặn truy cập trái phép.**

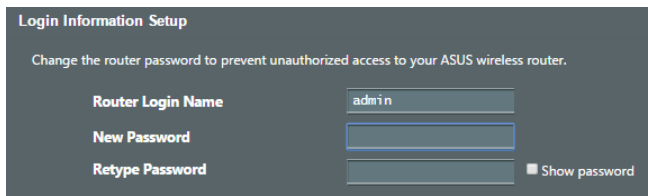



Ghi nhớ các cài đặt router không dây của bạn

- Ghi nhớ các cài đặt không dây khi bạn hoàn tất thiết lập router.

Tên router:	Mật khẩu:
SSID mạng 2.4 GHz:	Mật khẩu:
SSID mạng 5G Hz-1:	Mật khẩu:
SSID mạng 5G Hz-2:	Mật khẩu:

Hỏi Đáp

1. Tôi có thể tìm thêm thông tin về router không dây ở đâu?
 - Trang Hỏi Đáp trực tuyến: <http://support.asus.com/faq>
 - Trang hỗ trợ kỹ thuật: <https://www.asus.com/support>
 - Đường dây nóng khách hàng: Tham khảo phần Đường dây nóng hỗ trợ trong Tài hướng dẫn khởi động nhanh này





ASUS Recycling/Takeback Services

ASUS recycling and takeback programs come from our commitment to the highest standards for protecting our environment. We believe in providing solutions for you to be able to responsibly recycle our products, batteries, other components, as well as the packaging materials. Please go to <http://csr.asus.com/english/Takeback.htm> for the detailed recycling information in different regions.

REACH

Complying with the REACH (Registration, Evaluation, Authorisation, and Restriction of Chemicals) regulatory framework, we published the chemical substances in our products at ASUS REACH website at <http://csr.asus.com/english/REACH.htm>

Federal Communications Commission Statement

This device complies with Part 15 of the FCC Rules. Operation is subject to the following two conditions:

- This device may not cause harmful interference.
- This device must accept any interference received, including interference that may cause undesired operation.

This equipment has been tested and found to comply with the limits for a class B digital device, pursuant to part 15 of the FCC Rules. These limits are designed to provide reasonable protection against harmful interference in a residential installation.

This equipment generates, uses and can radiate radio frequency energy and, if not installed and used in accordance with the instructions, may cause harmful interference to radio communications. However, there is no guarantee that interference will not occur in a particular installation. If this equipment does cause harmful interference to radio or television reception, which can be determined by turning the equipment off and on, the user is encouraged to try to correct the interference by one or more of the following measures:

- Reorient or relocate the receiving antenna.
- Increase the separation between the equipment and receiver.
- Connect the equipment into an outlet on a circuit different from that to which the receiver is connected.
- Consult the dealer or an experienced radio/TV technician for help.



WARNING! Any changes or modifications not expressly approved by the party responsible for compliance could void the user's authority to operate the equipment.

Prohibition of Co-location

This device and its antenna(s) must not be co-located or operating in conjunction with any other antenna or transmitter.

IMPORTANT NOTE:

Radiation Exposure Statement: This equipment complies with FCC radiation exposure limits set forth for an uncontrolled environment. End users must follow the specific operating instructions for satisfying RF exposure compliance. To maintain compliance with FCC exposure compliance requirement, please follow operation instruction as documented in this manual.





Declaration of Conformity for R&TTE directive 1999/5/EC

Essential requirements – Article 3

Protection requirements for health and safety – Article 3.1a

Testing for electric safety according to EN 60950-1 has been conducted. These are considered relevant and sufficient.

Protection requirements for electromagnetic compatibility – Article 3.1b

Testing for electromagnetic compatibility according to EN 301 489-1 and EN 301 489-17 has been conducted. These are considered relevant and sufficient.

Effective use of the radio spectrum – Article 3.2

Testing for radio test suites according to EN 300 328- 2 has been conducted. These are considered relevant and sufficient.

Declaration of Conformity for Ecodesign directive 2009/125/EC

Testing for eco-design requirements according to (EC) No 1275/2008 and (EU) No 801/2013 has been conducted. When the device is in Networked Standby Mode, its I/O and network interface are in sleep mode and may not work properly. To wake up the device, press the Wi-Fi on/off, LED on/off, reset, or WPS button.

CE Mark Warning

This is a Class B product, in a domestic environment, this product may cause radio interference, in which case the user may be required to take adequate measures. Operation Channels: CH1~11 for N. America; CH1~13 for Japan; CH1~13 for Europe (ETSI)

This equipment may be operated in AT, BE, CE, CY, CZ, DK, EE, FI, FR, DE, GR, HU, IE, IT, LU, MT, NL, PL, PT, SK, SL, ES, SE, GB, IS, LI, NO, CH, BG, RO, RT.

Canada, Industry Canada (IC) Notices

This Class B digital apparatus complies with Canadian ICES-003 and RSS-210.

Operation is subject to the following two conditions: (1) this device may not cause interference, and (2) this device must accept any interference, including interference that may cause undesired operation of the device.

Radio Frequency (RF) Exposure Information

The radiated output power of the ASUS Wireless Device is below the Industry Canada (IC) radio frequency exposure limits. The ASUS Wireless Device should be used in such a manner such that the potential for human contact during normal operation is minimized.

This device has been evaluated for and shown compliant with the IC Specific Absorption Rate (“SAR”) limits when installed in specific host products operated in portable exposure conditions (antennas are less than 20 centimeters of a person’s body).

This device has been certified for use in Canada. Status of the listing in the Industry Canada’s REL (Radio Equipment List) can be found at the following web address:

<http://www.ic.gc.ca/app/sitt/re/tel/srch/nwRdSrch.do?lang=eng>

Additional Canadian information on RF exposure also can be found at the following web:

<http://www.ic.gc.ca/eic/site/smt-gst.nsf/eng/sf08792.html>





Canada, avis d'Industry Canada (IC)

Cet appareil numérique de classe B est conforme aux normes canadiennes ICES-003 et RSS-210.

Son fonctionnement est soumis aux deux conditions suivantes : (1) cet appareil ne doit pas causer d'interférence et (2) cet appareil doit accepter toute interférence, notamment les interférences qui peuvent affecter son fonctionnement.

Informations concernant l'exposition aux fréquences radio (RF)

La puissance de sortie émise par l'appareil de sans fil ASUS est inférieure à la limite d'exposition aux fréquences radio d'Industry Canada (IC). Utilisez l'appareil de sans fil ASUS de façon à minimiser les contacts humains lors du fonctionnement normal.

Ce périphérique a été évalué et démontré conforme aux limites SAR (Spécific Absorption Rate – Taux d'absorption spécifique) d'IC lorsqu'il est installé dans des produits hôtes particuliers qui fonctionnent dans des conditions d'exposition à des appareils portables (les antennes se situent à moins de 20 centimètres du corps d'une personne).

Ce périphérique est homologué pour l'utilisation au Canada. Pour consulter l'entrée correspondant à l'appareil dans la liste d'équipement radio (REL - Radio Equipment List) d'Industry Canada rendez-vous sur:

<http://www.ic.gc.ca/app/sitt/reltel/srch/nwRdSrch.do?lang=eng>

Pour des informations supplémentaires concernant l'exposition aux RF au Canada rendez-vous sur:

<http://www.ic.gc.ca/eic/site/smt-gst.nsf/eng/sf08792.html>

Safety Notices

- Use this product in environments with ambient temperatures between 0°C(32°F) and 40°C(104°F).
- Refer to the rating label on the bottom of your product and ensure your power adapter complies with this rating.
- DO NOT place on uneven or unstable work surfaces. Seek servicing if the casing has been damaged.
- DO NOT place or drop objects on top and do not shove any foreign objects into the product.
- DO NOT expose to or use near liquids, rain, or moisture. DO NOT use the modem during electrical storms.
- DO NOT cover the vents on the product to prevent the system from getting overheated.
- DO NOT use damaged power cords, accessories, or other peripherals.
- If the Adapter is broken, do not try to fix it by yourself. Contact a qualified service technician or your retailer.
- To prevent electrical shock hazard, disconnect the power cable from the electrical outlet before relocating the system.



NCC 警語

經型式認證合格之低功率射頻電機，非經許可，公司、商號或使用者均不得擅自變更頻率、加大功率或變更原設計之特性及功能。

低功率射頻電機之使用不得影響飛航安全及干擾合法通信；經發現有干擾現象時，應立即停用，並改善至無干擾時方得繼續使用。

前項合法通信，指依電信法規定作業之無線電通信。

低功率射頻電機須忍受合法通信或工業、科學及醫療用電波輻射性電機設備之干擾。

「產品之限用物質含有情況」之相關資訊，請參考下表：

單元	限用物質及其化學符號					
	鉛 (Pb)	汞 (Hg)	鎘 (Cd)	六價鉻 (Cr ⁶⁺)	多溴聯苯 (PBB)	多溴二苯醚 (PBDE)
印刷電路板及電子組件	-	○	○	○	○	○
結構組件（金屬 / 塑膠）	○	○	○	○	○	○
其他組件（如天線 / 指示燈 / 連接線）	○	○	○	○	○	○
其他及其配件（如電源供應器）	-	○	○	○	○	○

備考1. “○” 係指該項限用物質之百分比含量未超出百分比含量基準值。
備考2. “-” 係指該項限用物質為排除項目。

DFS 警語

操作在 5.15-5.35/5.47-5.85GHz 之無線資訊傳輸設備 (802.11a/ac 產品)，應避免影響附近雷達系統之操作。

MPE

本產品電磁波曝露量 (MPE) 標準值 $1\text{mW}/\text{cm}^2$ ，送測產品實測值為 $0.32982\text{mW}/\text{cm}^2$ ，建議使用時至少距離人體 20cm。

安全說明：

- 請在溫度為 0°C (32°F) 至 40°C (104°F) 之間的環境中使用本產品。
- 請依照產品上的電源功率貼紙說明使用正確的電源變壓器，如果使用錯誤規格的電源變壓器有可能會造成內部零件的損毀。
- 請勿將產品放置於不平坦或不穩定的表面，若產品的機殼毀損，請聯絡維修服務人員。
- 請勿在產品上放置其他物品，請勿將任何物品塞入產品內，以避免引起元件短路或電路損毀。
- 請保持機器在乾燥的環境下使用，雨水、溼氣、液體等含有礦物質將會腐蝕電子線路，請勿在雷電天氣下使用數據機。
- 請勿堵塞產品的通風孔，以避免因散熱不良而導致系統過熱。
- 請勿使用破損的電源線、附件或其他周邊產品。
- 如果電源已毀損，請不要嘗試自行修復，請將其交給專業技術服務人員或經銷商來處理。
- 為了防止電擊風險，在搬動主機之前，請先將電源線插頭暫時從電源插座上拔除。



电子电气产品有害物质限制使用标识要求：图中之数字为产品之环保使用期限。仅指电子电气产品中含有的有害物质不致发生外泄或突变从而对环境造成污染或对人体、财产造成严重损害的期限。

产品中有害物质的名称及含量

部件名称	有害物质					
	铅(Pb)	汞(Hg)	镉(Cd)	六价铬(Cr(VI))	多溴联苯(PBB)	多溴二苯醚(PBDE)
印刷电路板及其电子组件	×	○	○	○	○	○
外壳	○	○	○	○	○	○
电源适配器	×	○	○	○	○	○
外部信号连接头及线材	×	○	○	○	○	○
中央处理器与内存	×	○	○	○	○	○
本表格依据 SJ/T 11364 的规定编制。 ○：表示该有害物质在该部件所有均质材料中的含量均在 GB/T 26572 规定的限量要求以下。 ×：表示该有害物质至少在该部件的某一均质材料中的含量超出 GB/T 26572 规定的限量要求，然该部件仍符合欧盟指令 2011/65/EU 的规范。 备注：此产品所标示之环保使用期限，系指在一般正常使用状况下。						

安全说明：

- 请在温度为 0° C (32° F) 至 40° C (104° F) 之间的环境中使用本产品。
- 请依照产品上的电源功率贴纸说明使用正确的电源适配器，如果试用错误规格的电源适配器可能会造成内部零件的损坏。
- 请勿将产品放置于不平坦或不稳定的表面，若产品的外壳损坏，请联系维修服务人员。
- 请勿在产品上放置其他物品，请勿将任何物品塞入产品内，以避免引起组件短路或电路损坏。
- 请保持机器在干燥的环境下使用，雨水、湿气、液体等含有矿物质会腐蚀电子线路，请勿在雷电天气下使用调制解调器。
- 请勿堵塞产品的通风孔，以避免因散热不良而导致系统过热。
- 请勿使用破损的电源线、附件或其他周边产品。
- 如果电源已损坏，请不要尝试自行修复，请将其交给专业技术服务人员或经销商来处理。
- 为了防止电击风险，在搬动主机前，请先将电源线插头暂时从电源插座上拔除。

屋外での使用について

本製品は、5GHz 帯域での通信に対応しています。電波法の定めにより5.2GHz、5.3GHz 帯域の電波は屋外で使用が禁じられています。

法律および規制遵守

本製品は電波法及びこれに基づく命令の定めるところに従い使用してください。日本国外では、その国の法律または規制により、本製品を使用ができないことがあります。このような国では、本製品を運用した結果、罰せられることがあります。当社は一切責任を負いかねますのでご了承ください。

VCCI: Japan Compliance Statement

この装置は、情報処理装置等電波障害自主規制協議会（VCCI）の基準に基づくクラスB情報技術装置です。この装置は、家庭環境で使用することを目的としていますが、この装置がラジオやテレビジョン受信機に近接して使用されると、受信障害を引き起こすことがあります。取り扱い説明書に従って正しい取り扱いをして下さい。

KC: Korea Warning Statement

B급 기기 (가정용 방송통신기자재)	이 기기는 가정용(B급)으로 전자파적합등록을 한 기기로서 주로 가정에서 사용하는 것을 목적으로 하며, 모든 지역에서 사용할 수 있습니다.
Class B equipment (For Home Use Broadcasting & Communication Equipment)	This equipment is home use (Class B) electromagnetic wave suitability and to be used mainly at home and it can be used in all areas.

Networks Global Hotline Information

Area	Country/ Region	Hotline Number	Service Hours
Europe	Cyprus	800-92491	09:00-13:00; 14:00-18:00 Mon-Fri
	France	0033-170949400	09:00-18:00 Mon-Fri
	Germany	0049-1805010920	09:00-18:00 Mon-Fri 10:00-17:00 Mon-Fri
		0049-1805010923 (component support)	
		0049-2102959911 (Fax)	
	Hungary	0036-15054561	09:00-17:30 Mon-Fri
	Italy	199-400089	09:00-13:00 ; 14:00-18:00 Mon-Fri
	Greece	00800-44142044	09:00-13:00 ; 14:00-18:00 Mon-Fri
	Austria	0043-820240513	09:00-18:00 Mon-Fri
	Netherlands/ Luxembourg	0031-591570290	09:00-17:00 Mon-Fri
	Belgium	0032-78150231	09:00-17:00 Mon-Fri
	Norway	0047-2316-2682	09:00-18:00 Mon-Fri
	Sweden	+46-858769407	09:00-18:00 Mon-Fri
	Finland	00358-969379690	10:00-19:00 Mon-Fri
	Denmark	0045-38322943	09:00-18:00 Mon-Fri
	Poland	0048-225718040	08:30-17:30 Mon-Fri
	Spain	0034-902889688	09:00-18:00 Mon-Fri
	Portugal	00351-707500310	09:00-18:00 Mon-Fri
	Slovak Republic	00421-232162621	08:00-17:00 Mon-Fri
	Czech Republic	00420-596766888	08:00-17:00 Mon-Fri
	Switzerland-German	0041-848111010	09:00-18:00 Mon-Fri
	Switzerland-French	0041-848111014	09:00-18:00 Mon-Fri
	Switzerland-Italian	0041-848111012	09:00-18:00 Mon-Fri
United Kingdom	0044-1442265548	09:00-17:00 Mon-Fri	
Ireland	0035-31890719918	09:00-17:00 Mon-Fri	
Russia and CIS	008-800-100-ASUS	09:00-18:00 Mon-Fri	
Ukraine	0038-0445457727	09:00-18:00 Mon-Fri	

Networks Global Hotline Information

Area	Country/ Region	Hotline Numbers	Service Hours
Asia-Pacific	Australia	1300-278788	09:00-18:00 Mon-Fri
	New Zealand	0800-278788	09:00-18:00 Mon-Fri
	Japan	0800-1232787	09:00-19:00 Mon-Sun
		0081-570783886 (Non-Toll Free)	09:00-19:00 Mon-Sun
	Korea	0082-215666868	09:30-17:00 Mon-Fri
	Thailand	0066-24011717	09:00-18:00 Mon-Fri
		1800-8525201	
	Singapore	0065-64157917	11:00-19:00 Mon-Fri
		0065-67203835	11:00-19:00 Mon-Fri
		(Repair Status Only)	11:00-13:00 Sat
	Malaysia	1300-88-3495	9:00-18:00 Mon-Fri
	Philippine	1800-18550163	09:00-18:00 Mon-Fri
	India	1800-2090365	09:00-18:00 Mon-Sat
	India(WL/NW)		09:00-21:00 Mon-Sun
Indonesia	0062-2129495000	09:30-17:00 Mon-Fri	
	500128 (Local Only)	9:30 – 12:00 Sat	
Vietnam	1900-555581	08:00-12:00	
		13:30-17:30 Mon-Sat	
Hong Kong	00852-35824770	10:00-19:00 Mon-Sat	
Americas	USA	1-812-282-2787	8:30-12:00 EST Mon-Fri
	Canada		9:00-18:00 EST Sat-Sun
	Mexico	001-8008367847	08:00-20:00 CST Mon-Fri
08:00-15:00 CST Sat			

Networks Global Hotline Information

Area	Country/ Region	Hotline Numbers	Service Hours
Middle East + Africa	Egypt	800-2787349	09:00-18:00 Sun-Thu
	Saudi Arabia	800-1212787	09:00-18:00 Sat-Wed
	UAE	00971-42958941	09:00-18:00 Sun-Thu
	Turkey	0090-2165243000	09:00-18:00 Mon-Fri
	South Africa	0861-278772	08:00-17:00 Mon-Fri
	Israel	*6557/00972-39142800 *9770/00972-35598555	08:00-17:00 Sun-Thu 08:30-17:30 Sun-Thu
Balkan Countries	Romania	0040-213301786	09:00-18:30 Mon-Fri
	Bosnia Herzegovina	00387-33773163	09:00-17:00 Mon-Fri
	Bulgaria	00359-70014411	09:30-18:30 Mon-Fri
		00359-29889170	09:30-18:00 Mon-Fri
	Croatia	00385-16401111	09:00-17:00 Mon-Fri
	Montenegro	00382-20608251	09:00-17:00 Mon-Fri
	Serbia	00381-112070677	09:00-17:00 Mon-Fri
	Slovenia	00368-59045400	08:00-16:00 Mon-Fri
00368-59045401			
Baltic Countries	Estonia	00372-6671796	09:00-18:00 Mon-Fri
	Latvia	00371-67408838	09:00-18:00 Mon-Fri
	Lithuania-Kaunas	00370-37329000	09:00-18:00 Mon-Fri
	Lithuania-Vilnius	00370-522101160	09:00-18:00 Mon-Fri

NOTES:

- UK support e-mail: network_support_uk@asus.com
- For more information, visit the ASUS support site at: <https://www.asus.com/support>









ASUS Account 登録

グローバルサイト: <http://www.asus.com> 会員登録サイト: <https://account.asus.com>

お客様各位

この度はASUS製品をお買い上げいただき誠にありがとうございます。

お買い上げ後は、ぜひオンライン製品登録を行い、ASUS ユーザーとして総合的保証サービスをご利用ください。登録後、自動的にVIP サービスがご利用いただけます。ASUSメンバーは次のような特典を受けることができます。

- (1) 総合保証サービス
- (2) ASUSメンバー特典
 - ・ セール、イベント、キャンペーンのお知らせ
 - ・ サポート情報

*詳しい内容は下記リンクをご覧ください。

<https://account.asus.com>





ASUS

