

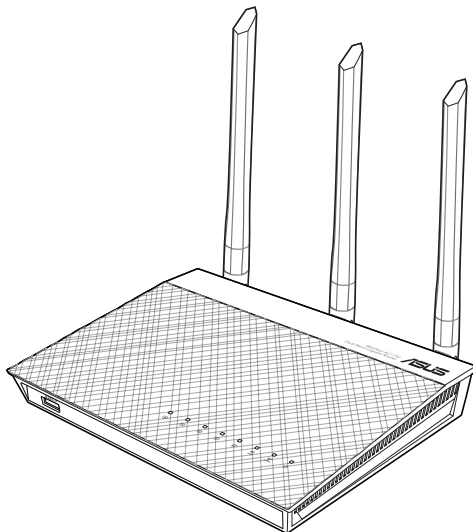

# RT-AC66U B1

## Wireless-AC1750 Dual Band Gigabit Router



### Quick Start Guide

APAC15861 / Revised Edition V7 / August 2019

## Table of contents

English.....	3
简体中文 .....	16
繁體中文 .....	29
Bahasa Indonesia.....	42
Bahasa Malaysia .....	55
ไทย.....	68
Tiếng Việt.....	81

## Package contents

- ☑ RT-AC66U B1
- ☑ RJ-45 cable
- ☑ Warranty card
- ☑ AC adapter
- ☑ Quick Start Guide



**NOTE:** If any of the items is damaged or missing, contact your retailer.

## A quick look

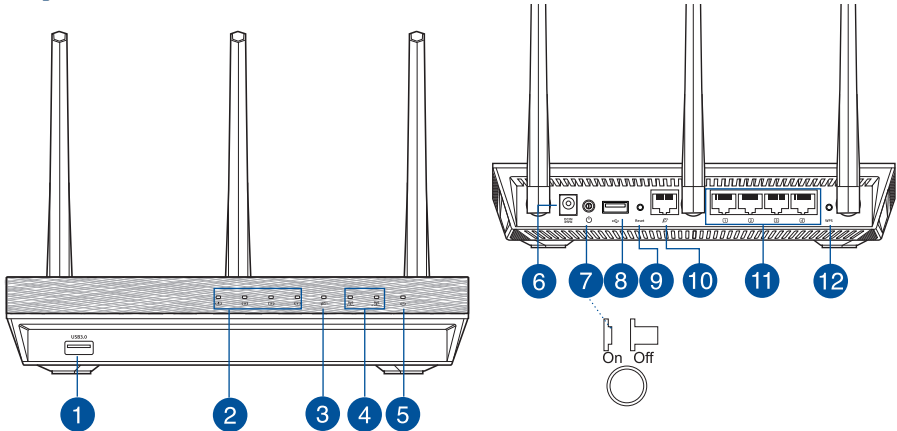

1) USB 3.0 port	5) Power LED	9) Reset button
2) LAN LED	6) Power (DC-IN) port	10) WAN port
3) WAN LED	7) Power switch	11) LAN ports
4) 2.4GHz/5GHz LED	8) USB 2.0 port	12) WPS button



---

## NOTES:

- **USB External HDD/Flash disk:**

- The wireless router works with most USB HDDs/Flash disks up to 2TB and supports read-write access for FAT16, FAT32, EXT2, EXT3, and NTFS.
  - To safely remove the USB disk, launch the web GUI (<http://router.asus.com>), then in the **Network Map** page's upper right corner, click the USB icon and click **Eject USB 1**.
  - Incorrect removal of the USB disk may cause data corruption.
  - For the list of file system and hard disk partitions that the wireless router supports, visit <http://event.asus.com/networks/disksupport>
  - For the list of printers that the wireless router supports, visit <http://event.asus.com/networks/printersupport>
-

## Positioning your wireless router

For the best wireless signal transmission between the wireless router and the network devices connected to it, ensure that you:

- Place the wireless router in a centralized area for a maximum wireless coverage for the network devices.
- Keep the device away from metal obstructions and away from direct sunlight.
- Keep the device away from 802.11g or 20MHz only Wi-Fi devices, 2.4GHz computer peripherals, Bluetooth devices, cordless phones, transformers, heavy-duty motors, fluorescent lights, microwave ovens, refrigerators, and other industrial equipment to prevent signal interference or loss.
- To ensure the best wireless signal, orient the three detachable antennas as shown in the drawing below.
- For optimum performance, adjust the internal cooling system. Refer to the user manual for details.
- Always update to the latest firmware. Visit the ASUS website at <http://www.asus.com> to get the latest firmware updates.

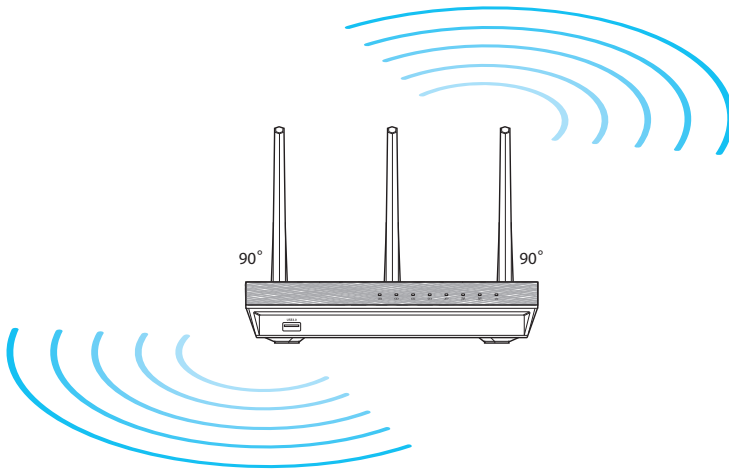

## Before you proceed

1. Unplug and disconnect the wires/cables from your existing modem setup and release your computer's outmoded IP address.

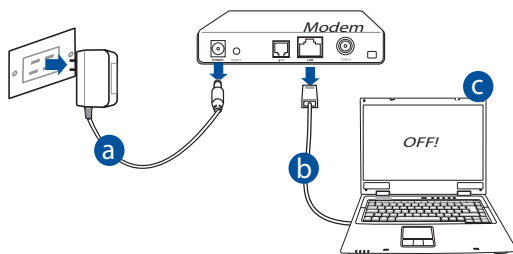

- a: Unplug the AC adapter from the power outlet and disconnect it from your cable/ADSL modem.
- b: Disconnect the network cable from your cable/ADSL modem.
- c: Reboot your computer (recommended).



**WARNING!** Before disconnecting the wires/cables, ensure that your cable/ADSL modem has been turned off for at least two minutes. If your modem has a backup battery, remove it as well.

## 2. Set up your wireless environment.

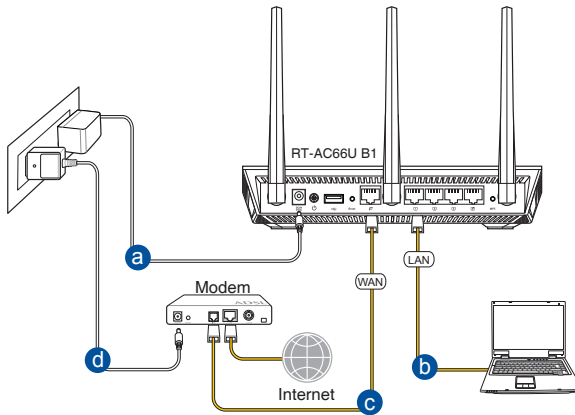

- a:** Insert your wireless router's AC adapter to the DC-IN port and plug it to a power outlet.
- b:** Using the bundled network cable, connect your computer to your wireless router's LAN port.



**IMPORTANT!** Ensure that the WAN and LAN LEDs are blinking.

- c:** Using another network cable, connect your modem to your wireless router's WAN port.
- d:** Insert your modem's AC adapter to the DC-IN port and plug it to a power outlet.

## 3. Disable some settings on your computer.

- A. Disable the proxy server, if enabled.**
- B. Set the TCP/IP settings to automatically obtain an IP address.**
- C. Disable the dial-up connection, if enabled.**



**NOTE:** For more details on disabling your computer settings, refer to *Frequently Asked Questions (FAQs)*.

## Getting started

1. Configure your wireless settings via the wireless router's web graphics user interface (web GUI).

- a: Launch your web browser such as Internet Explorer, Firefox, Google Chrome, or Safari.



a

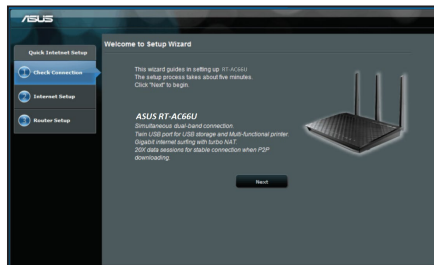

b



**NOTE:** If QIS does not launch automatically, follow these steps to manually launch QIS:

- On your web browser, key in **<http://router.asus.com>** and run the Quick Internet Setup (QIS) Wizard again.
- Disable the proxy settings, dial-up connection, and set your TCP/IP settings to automatically obtain an IP address. For more details, refer to the **FAQs** section for auto-diagnosis.



- b:** The wireless router's Quick Internet Setup (QIS) feature automatically detects if your ISP connection type is **Dynamic IP, PPPoE, PPTP, L2TP,** and **Static IP.** Key in the necessary information for your connection type.



---

**NOTE:** The auto-detection of your ISP connection type takes place when you configure the wireless router for the first time or when your wireless router is reset to its default settings.

---



---

**IMPORTANT!** Obtain the necessary information about your Internet connection type from your Internet Service Provider (ISP).

---

- c:** Assign the network name (SSID) and security key for your 2.4GHz and 5GHz wireless connection. Click **Apply** when done.
- d:** Your Internet and wireless settings are displayed. Click **Next** to continue.
- e:** Read the wireless network connection tutorial. When done, click **Finish**.

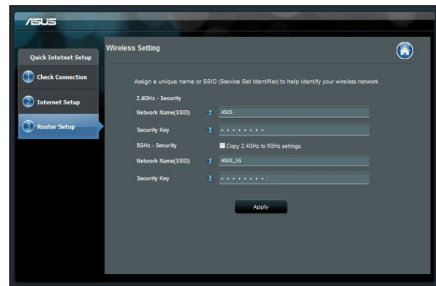

---

**NOTE:** You can assign a network name with up to 32 characters.

---

## Frequently Asked Questions (FAQs)

After following the steps, I still cannot access the wireless router's web graphics user interface (web GUI) to configure the wireless router settings.

### A. Disable the proxy server, if enabled.

#### Windows® 7

1. Click **Start** > **Internet Explorer** to launch the web browser.
2. Click **Tools** > **Internet options** > **Connections** tab > **LAN settings**.

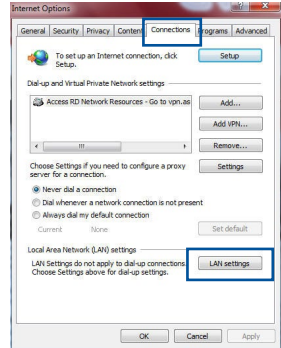

3. From the Local Area Network (LAN) Settings screen, untick **Use a proxy server for your LAN**.
4. Click **OK** when done.

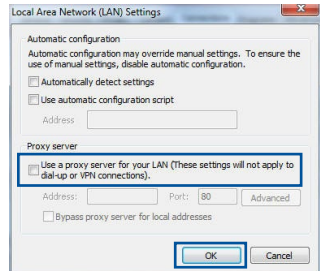

## MAC OS

1. From your Safari browser, click **Safari > Preferences > Advanced > Change Settings...**
2. From the Network screen, deselect **FTP Proxy** and **Web Proxy (HTTP)**.
3. Click **Apply Now** when done.

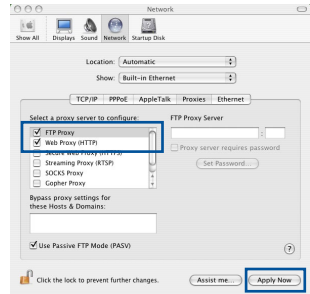

**NOTE:** Refer to your browser's help feature for details on disabling the proxy server.

## B. Set the TCP/IP settings to automatically obtain an IP address.

### Windows® 7

1. Click **Start > Control Panel > Network and Internet > Network and Sharing Center > Manage network connections.**
2. Select **Internet Protocol Version 4 (TCP/IPv4)**, then click **Properties**.

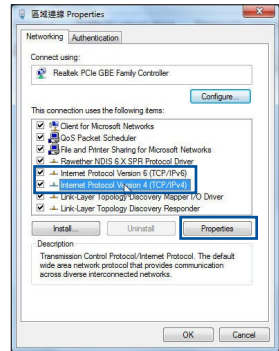

- To obtain the IPv4 IP settings automatically, tick **Obtain an IP address automatically**.
- Click **OK** when done.

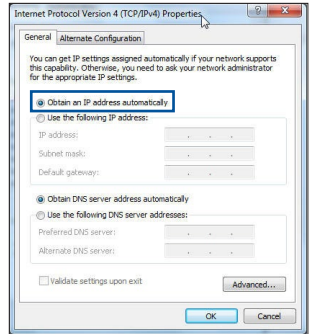

## MAC OS

- Click the Apple icon  located on the top left of your screen.
- Click **System Preferences > Network > Configure...**
- From the **TCP/IP** tab, select **Using DHCP** in the **Configure IPv4** dropdown list.
- Click **Apply Now** when done.

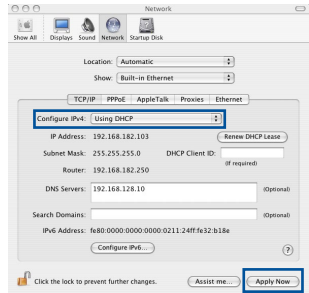

**NOTE:** Refer to your operating system's help and support feature for details on configuring your computer's TCP/IP settings.

## C. Disable the dial-up connection, if enabled.

### Windows® 7

1. Click **Start** > **Internet Explorer** to launch the browser.
2. Click **Tools** > **Internet options** > **Connections** tab.
3. Tick **Never dial a connection**.
4. Click **OK** when done.

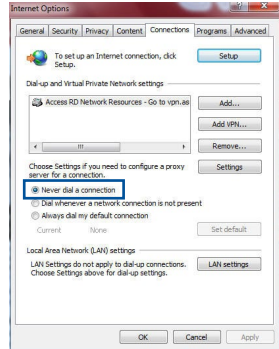

**NOTE:** Refer to your browser's help feature for details on disabling the dial-up connection settings.

## D. Close all running web browsers.

### The client cannot establish a wireless connection with the router.

#### Out of Range:

- Put the router closer to the wireless client.
- Try to change the channel settings.

#### Authentication:

- Use wired connection to connect to the router.
- Check the wireless security settings.
- Press the Reset button at the rear panel for more than five seconds.

**Cannot find the router:**

- Press the Reset button at the rear panel for more than five seconds.
- Check the setting in the wireless adapter such as SSID and encryption settings.

**Cannot access the Internet via wireless LAN adapter.**

- Move the router closer to the wireless client.
- Check whether the wireless adapter is connected to the correct wireless router.
- Check whether the wireless channel in use conforms to the channels available in your country/area.
- Check the encryption settings.
- Check if the ADSL or Cable connection is correct.
- Retry using another Ethernet cable.

**If the ADSL “LINK” light blinks continuously or stays off, Internet access is not possible - the Router is unable to establish a connection with the ADSL network.**

- Ensure that all your cables are all properly connected .
- Disconnect the power cord from the ADSL or cable modem, wait a few minutes, then reconnect the cord.
- If the ADSL light continues to blink or stays OFF, contact your ADSL service provider.

**Network name or encryption keys are forgotten.**

- Try setting up the wired connection and configuring the wireless encryption again.
- Press the Reset button of the wireless router for more than five seconds.
- Factory default settings:

<b>User name / Password:</b> admin / admin	<b>IP address:</b> <a href="http://router.asus.com">http://router.asus.com</a>	<b>SSID:</b> Check the rating label on the back side of your router
-----------------------------------------------	-----------------------------------------------------------------------------------	------------------------------------------------------------------------

## Where can I find more information about the wireless router?

- Online FAQ site: <http://support.asus.com/faq>
- Technical Support site: <https://www.asus.com/support/>
- Customer Hotline: Refer to the Support Hotline in this Quick Start Guide

## 包裝內容物

- ☑ RT-AC66U B1
- ☑ RJ-45 网线
- ☑ 保修卡
- ☑ 电源适配器
- ☑ 快速使用指南



注意：若以上列出的任何一项配件有损坏或是短缺的情形，请尽快联系您的经销商。

## 认识您的无线路由器

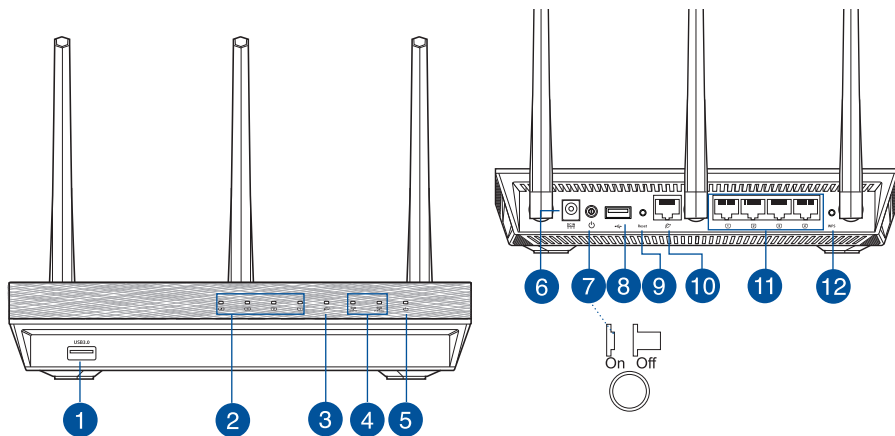

1) USB 3.0 接口	5) 电源指示灯	9) 复位按钮
2) LAN 指示灯	6) 电源 (DC-IN) 插孔	10) WAN 接口
3) WAN 指示灯	7) 电源按钮	11) LAN 接口
4) 2.4GHz / 5GHz 指示灯	8) USB 2.0 接口	12) WPS 按钮





---

注意：

- USB 外接硬盘 / 闪存盘：
    - 此无线路由器兼容大多数容量高达 2TB 的 USB 硬盘 / 闪存盘，并支持 FAT16、FAT32、EXT2、EXT3 与 NTFS 的读写。
    - 欲安全移除 USB 磁盘，登入网页图形用户界面 (<http://router.asus.com>)，然后在“网络地图”页面的右上角点击 USB 图标并选择【退出 USB 1】。
    - 错误移除 USB 磁盘将会导致数据丢失。
    - 请访问 <http://event.asus.com/networks/disksupport> 获得此无线路由器所支持的文件系统与硬盘磁区列表。
    - 请访问 <http://event.asus.com/networks/printersupport> 获得此无线路由器所支持的打印机列表。
-

## 放置您的路由器

为获取无线路由器与所连接的网络设备之间的最佳无线传输信号，请确认以下几点：

- 建议将路由器放置在中心区域，以获得最佳无线信号覆盖。
- 请勿将设备放在靠近金属物品与阳光直射的地方。
- 请远离其它 802.11g 或 20MHz 的 Wi-Fi 设备、2.4GHz 电脑外围设备、蓝牙设备、无绳室内电话、传输器、重型发动机、日光灯、微波炉、电冰箱与其他工业设备，以防止信号干扰或丢失。
- 请按照下图所示摆放路由器上的三根可拆式天线以获得最佳无线信号覆盖。
- 为获得最佳性能，请调整内部散热系统。请参考设备的用户手册了解具体规格。
- 请经常更新至最新版本固件，您可以登录华硕官网 <https://www.asus.com.cn> 获得最新固件。

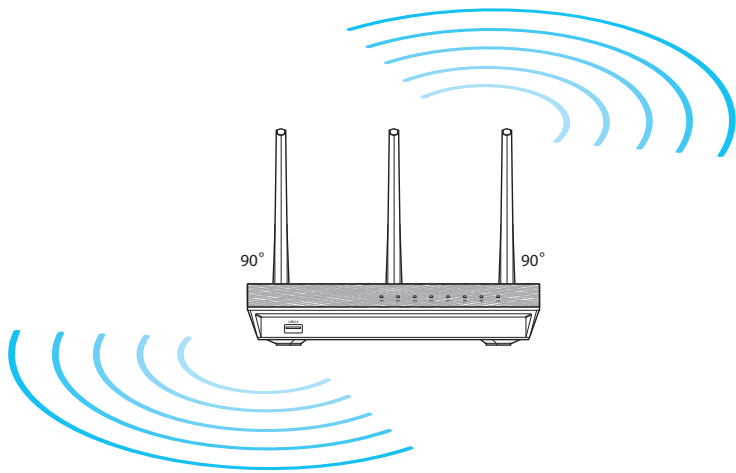

## 开始设置前

1. 请先移除调制解调器的电源线和网线，并移除电脑上的无效 IP 地址。

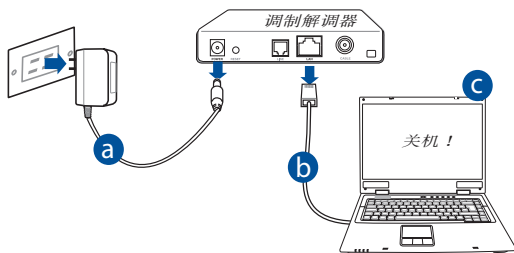

- a: 拔掉交流电源适配器的电源并断开与有线 / ADSL 调制解调器的连接。
- b: 拔掉您有线 / ADSL 调制解调器的网线。
- c: 重启您的电脑（推荐）。



**警告！** 请在断开电源线或数据线之前，确认您的有线 / ADSL 已关闭超过两分钟。若您的调制解调器有备用电池，请一并移除。

## 2. 设置无线环境。

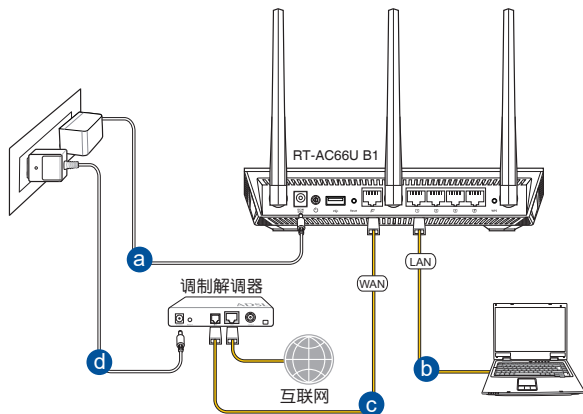

- a: 将无线路由器的交流电源适配器插入电源（DC-IN）插孔并插上电源。
- b: 使用附赠的网线将您的电脑连接至您的无线路由器的 LAN 接口。



**重要！** 请确认 WAN 和 LAN 指示灯正在闪烁。

- c: 用另一根网线将您的调制解调器连接至无线路由器的 WAN 接口。
- d: 将调制解调器的交流电源适配器插入电源（DC-IN）插孔并插上电源。

## 3. 关闭电脑中的某些设置。

- A. 若开启代理服务器，请关闭。
- B. 设置 TCP/IP 自动取得 IP 地址。
- C. 关闭拨号连接。



**注意：** 关于关闭电脑设置的更多信息请参阅“常见问题解答（FAQ）”。

# 系统导览

## 1. 通过网页图形用户界面（web GUI）为路由器进行无线设置。

a: 开启网络浏览器，如 Internet Explorer、Firefox、Safari 或 Google Chrome。



a

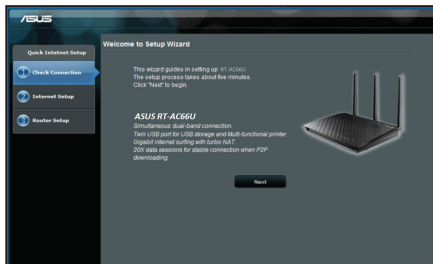

b



注意：若网络设置向导（QIS）页面没有自动开启，请按照下列步骤手动开启网络设置向导（QIS）：

- 开启您的浏览器，输入 <http://router.asus.com> 并再次运行网络设置向导（QIS）。
- 关闭代理服务器设置、取消拨号连接，并将 TCP/IP 设为自动取得 IP 地址。更多信息，请参考【常见问题解答（FAQ）】部分的内容。

- b: 无线路由器的网络设置向导 (QIS) 功能可自动侦测您的 ISP 连接类型：动态IP、PPPoE、PPTP、L2TP 和 固定 IP。为您的 ISP 连接类型输入所需信息。



注意：自动侦测 ISP 连接类型会在您第一次设置无线路由器时或路由器复位为默认设置后出现。



重要！请从您的网络服务供应商 (ISP) 处获取网络连接类型的相关信息。

- c: 为您的 2.4GHz 与 5 GHz 无线连接分配网络名称 (SSID) 与密钥。完成后点击【应用本页面设置】。

- d: 屏幕上显示网络与无线设置信息。点击【下一步】继续。

- e: 阅读无线网络连接向导。然后，点击【完成】。



注意：您可以指定一个网络名称，最多可包含 32 个字符。

## 常见问题解答 (FAQ)

按照以上步骤执行后，我依然无法获得无线路由器的网页图形用户界面 (web GUI) 以设置无线路由器。

A. 若开启代理服务器，请关闭。

Windows® 7

1. 点击【开始】>【Internet Explorer】开启浏览器。
2. 点击【工具】>【Internet 选项】>【连接】标签页 >【局域网设置】。

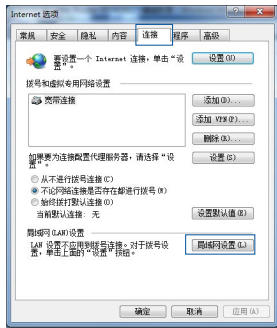

3. 在局域网 (LAN) 设置画面中取消勾选“为 LAN 使用代理服务器”。
4. 完成后点击【确定】。

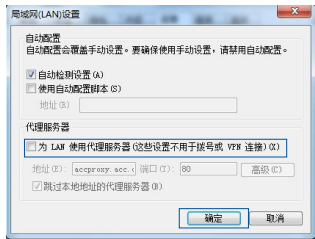

## MAC OS

1. 在您的 Safari 浏览器中点击【Safari】>【Preferences】>【高级】>【更改设置...】。
2. 在网络画面中取消勾选“FTP 代理”与“Web 代理 (HTTP)”。
3. 完成后点击【好】。

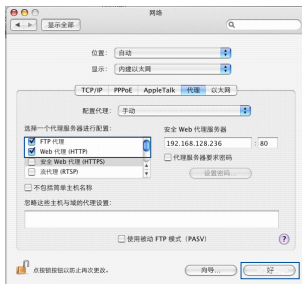

注意：请参考浏览器中的帮助菜单进行代理服务器的关闭设置。

## B. 设置 TCP/IP 自动取得 IP 地址。

## Windows® 7

1. 点击【开始】>【控制面板】>【网络与 Internet】>【网络和共享中心】>【管理网络连接】。
2. 选择“Internet 协议版本 4 (TCP/IPv4)”，然后点击【属性】。

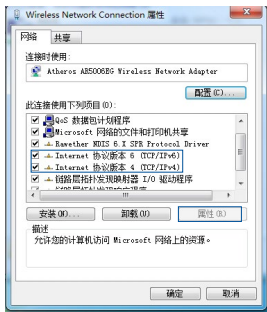



3. 欲自动获取 IPv4 IP 设置，选择“自动获得 IP 地址”。
4. 完成后点击【确定】。

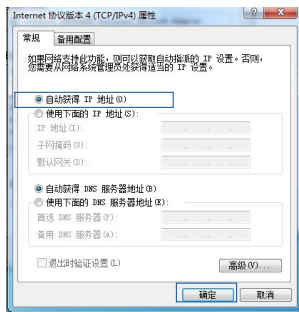

## MAC OS

1. 点击左上角的苹果图标 。
2. 点击【System Preferences】>【网络】>【设置...】。
3. 点击【TCP/IP】标签，在“配置 IPv4”下拉列表中选择【使用 DHCP】。
4. 完成后点击【好】。

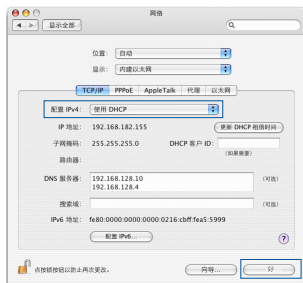

注意：请参考您的操作系统中的“帮助和支持”功能获得更多设置 TCP/IP 相关信息。

### C. 关闭拨号连接。

Windows® 7

1. 单击【开始】>【Internet Explorer】开启浏览器。
2. 单击【工具】>【Internet 选项】>【连接】标签。
3. 选择“从不进行拨号连接”。
4. 完成后单击【确定】。

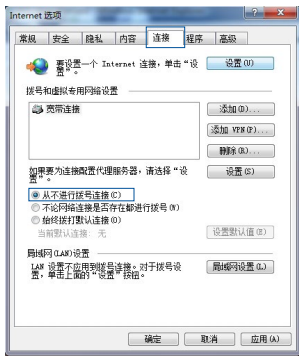

注意：请参考浏览器的帮助菜单进行关闭拨号连接。

### D. 关闭所有正在运行的浏览器。

#### 无法建立无线网络连接。

超出有效范围：

- 请将路由器放置于较靠近客户端设备之处。
- 尝试更改频道设置。

认证问题：

- 请使用采用有线连接的电脑来连接路由器。
- 检查网络安全设置。
- 您可以尝试按住路由器后侧的复位（Reset）按钮超过 5 秒钟后，进行硬件复位的动作。

无法搜索到路由器：

- 您可以尝试按住路由器后侧的复位（Reset）按钮超过 5 秒钟后，进行硬件复位的动作。
- 检查无线网卡上的 SSID 与加密等设置。

无法通过无线网卡来连接至互联网。

- 请将路由器移至用户端可以连接到的范围内。
- 检查您所使用的无线网卡是否连接到正确的路由器。
- 检查所使用的无线网络频道是符合您的所在地区 / 国家所规范的频道。
- 检查加密设置。
- 检查您所使用的 ADSL 或有线调制解调器是否连接至正确的网络接口。
- 重新更换另一根以太网线来连接

当 ADSL 调制解调器“Link”（连接）指示灯持续闪烁或熄灭，这表示无法连接至互联网 - 路由器无法与 ADSL 网络建立连接。

- 请确认网线已正确连接。
- 请将 ADSL 或有线调制解调器的电源线拔除，并等待几分钟后，再重新接上电源。
- 若 ADSL 调制解调器指示灯持续闪烁或为熄灭（显示 OFF）的状态，请与您的网络服务供应商联系。

忘记网络名称或密钥密码。

- 尝试再次通过有线连接来设置无线的加密动作。
- 按住位于路由器后侧的复位（Reset）按钮超过 5 秒钟后，进行硬件复位的动作。
- 出厂默认值设置：

帐号 / 密码： admin / admin	IP 地址： http://router.asus.com	SSID： 检查路由器后侧的功率标签。
---------------------------	----------------------------------	------------------------

## 哪里可以找到更多的无线路由器信息？

- 线上支持及常见问题解答网址：<https://www.asus.com.cn/support>
- 技术支持网址：<https://www.asus.com.cn/support>
- 客户服务热线：请参阅此快速使用指南的支持热线 400-620-6655

## 產品包裝內容

- ☑ RT-AC66U B1
- ☑ RJ-45 網路線
- ☑ 保固卡
- ☑ 電源變壓器
- ☑ 快速使用指南



**注意：** 若以上列出的任何一項配件有毀損或是短缺的情形，請儘速聯絡您的經銷商。

## 認識您的無線路由器

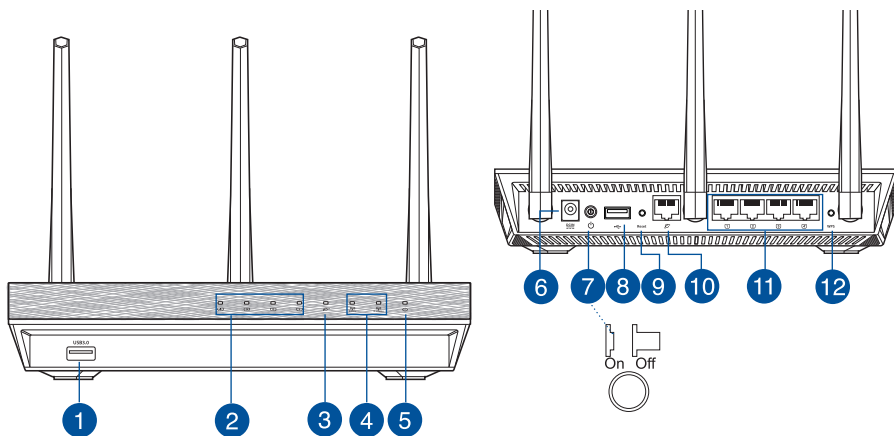

1) USB 3.0 連接埠	5) 電源指示燈	9) 重置按鈕
2) LAN 指示燈	6) 電源 (DC-IN) 插孔	10) WAN 連接埠
3) WAN 指示燈	7) 電源按鈕	11) LAN 連接埠
4) 2.4GHz/5GHz 指示燈	8) USB 2.0 連接埠	12) WPS 按鈕



---

注意：

- USB 外部硬碟 / 隨身碟
    - 此無線路由器相容大多數容量高達 2TB 的 USB 硬碟 / 隨身碟，並支援 FAT16、FAT32、EXT2、EXT3 與 NTFS 的存取。
    - 欲安全移除 USB 硬碟，登入網頁圖形使用者介面（<http://router.asus.com>），然後在 **網路地圖** 頁面的右上角點選 USB 圖示並選擇 **移除 USB 1**。
    - 不正確地移除 USB 裝置可能導致資料毀損。
    - 請造訪 <http://event.asus.com/networks/disksupport> 獲得此無線路由器所支援的檔案系統與硬碟磁區清單。
  - 請造訪 <http://event.asus.com/networks/printersupport> 獲得此無線路由器所支援的印表機清單。
-

## 放置您的路由器

為獲得無線路由器與所連線的網路裝置之間傳送最佳無線訊號，請確認以下幾點：

- 建議將路由器放置在中心區域，以獲得最佳無線訊號覆蓋範圍。
- 請勿將裝置放在靠近金屬物品與陽光直射的地方。
- 請遠離其它 802.11g 或 20MHz 的 Wi-Fi 裝置、2.4GHz 電腦周邊裝置、藍牙裝置、無線室內電話、傳送器、重型發動機、日光燈、微波爐、電冰箱與其他工業裝置，以防止訊號干擾或減損。
- 請依據下圖所示擺放路由器上的三根可拆式天線以獲得最佳無線訊號覆蓋範圍。
- 請調節內建散熱系統以獲取最佳效能，更多資訊請參閱使用手冊。
- 請經常更新至最新版本韌體，您可以登入華碩官網 <https://www.asus.com/tw/> 獲得最新韌體。

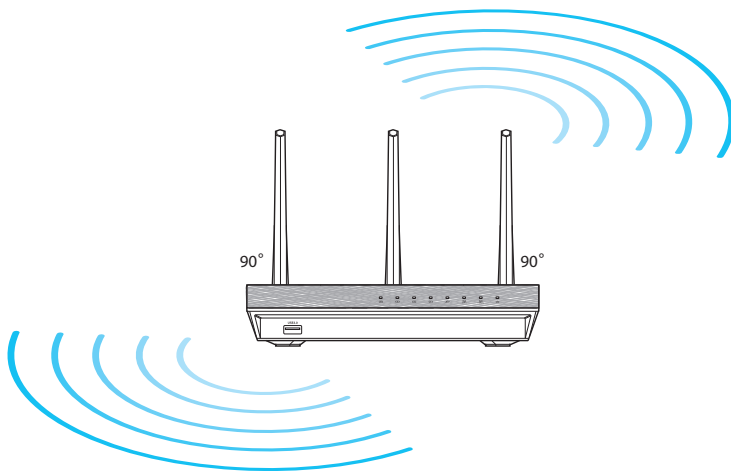

## 開始設定之前

1. 請先移除數據機的電源線和網路線，並移除電腦上的無效 IP 位址。

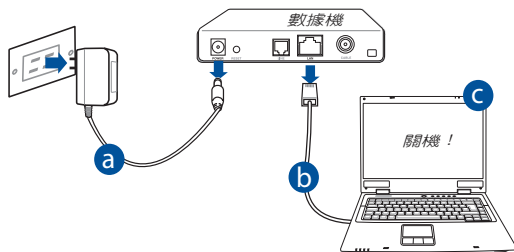

- a: 拔掉 AC 變壓器的電源並斷開與有線 / ADSL 數據機的連接。
- b: 拔掉您有線 / ADSL 數據機的網路線。
- c: 重新啟動您的電腦（建議）。



**警示！** 請在斷開電源線與網路線之前，確認您的有線 / ADSL 已關閉超過二分鐘。若數據機有備用電池，也請移除。



## 2. 設定無線環境。

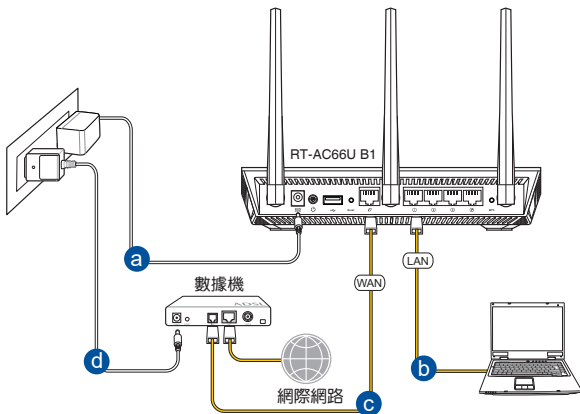

- a: 將無線路由器 AC 變壓器的一端插入電源輸入 (DC-IN) 連接埠，另一端連接至電源插座。
- b: 使用附贈的網路線將您的電腦連接至您的無線路由器的 LAN 連接埠。



**重要！** 請確認 WAN 和 LAN 指示燈正在閃爍。

- c: 用另一條網路線將您的數據機連接至無線路由器的 WAN 連接埠。
- d: 將數據機 AC 變壓器的一端插入電源輸入 (DC-IN) 連接埠，另一端連接至電源插座。

## 3. 請關閉電腦上的某些設定。

- A. 請關閉代理伺服器。
- B. 設定 TCP/IP 自動獲得 IP 位址。
- C. 關閉撥號連接。



**注意：** 更多資訊請參閱「常見問題與解答 (FAQ)」。

## 開始設定前

### 1. 透過路由器的網頁圖形使用者介面（web GUI）進行無線設定。

- a: 開啟您的網路瀏覽器，如 Internet Explorer、Firefox、Safari 或 Google Chrome。



a

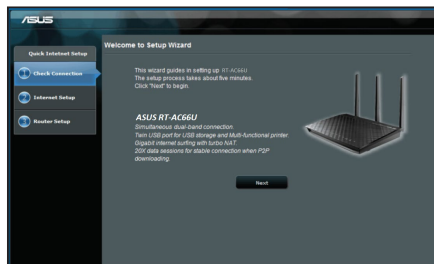

b



**注意：** 若網路設定精靈（QIS）並未自動開啟，請按照下列步驟手動開啟網路設定精靈（QIS）：

- 在您的網路瀏覽器中輸入 <http://router.asus.com> 並再次開啟網路設定精靈（QIS）。
- 關閉代理伺服器設定、取消撥號連線，並將 TCP/IP 設為自動取得 IP 位址。更多資訊請查閱 **常見問題解答（FAQ）** 部分的說明。

- b: 此路由器的網路設定精靈 (QIS) 可自動偵測 ISP 連線類型：自動取得 IP、PPPoE、PPTP、L2TP 與固定 IP。為您的連線類型輸入所需資訊。



**注意：** 自動偵測 ISP 連線類型會在您第一次設定無線路由器時或重置路由器為預設設定後出現。



**重要！** 請從您的 ISP 獲取網路連接類型的相關資訊。

- c: 為您的 2.4GHz 與 5 GHz 無線連線指定網路名稱 (SSID) 與金鑰。完成後點選 **套用本頁面設定**。
- d: 螢幕上將顯示網路與無線設定資訊。點選 **下一步** 繼續。
- e: 閱讀無線網路連線嚮導。然後，點選 **完成**。



**注意：** 您可以指定一個多達 32 字元的網路名稱。

## 常見問題與解答 (FAQ)

按照以上步驟執行後，我依然無法開啟無線路由器的網頁圖形使用者介面 (Web GUI) 以設定無線路由器

### A. 請關閉代理伺服器。

Windows® 7

1. 點選 開始 > Internet Explorer 開啟網頁瀏覽器。
2. 點選 工具 > 網際網路選項 > 連線 標籤頁 > 區域網路設定。

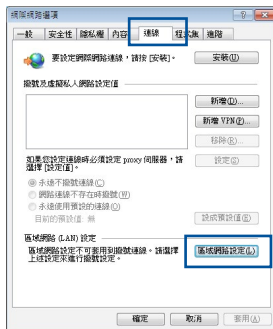

3. 在區域網路 (LAN) 設定畫面中取消勾選 您的區域網路使用 Proxy 伺服器。
4. 完成後點選 確定。

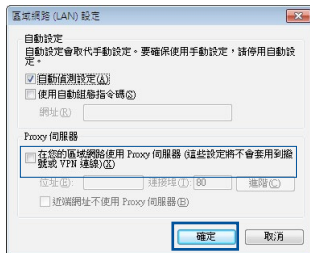

## MAC OS

1. 在您的 Safari 瀏覽器中點選 **Safari > Preferences > 進階 > 更改設定...**
2. 在網路畫面中取消勾選 **FTP 代理伺服器** 與 **網頁代理伺服器 (HTTP)**。
3. 完成後點選 **好**。

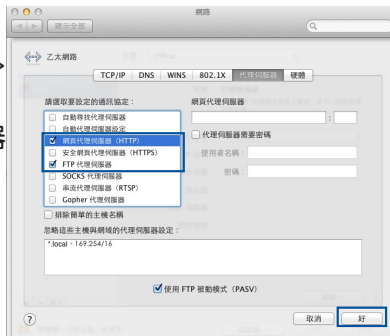

注意：請參考瀏覽器中的幫助選單進行代理伺服器的關閉設定。

## B. 設定 TCP/IP 自動取得 IP 位址

### Windows® 7

1. 點選 **開始 > 控制台 > 網路與網際網路 > 網路和共用中心 > 管理網路連線**。
2. 點選 **網際網路通訊協定第 4 版 (TCP/IPv4)**，然後點選 **內容**。

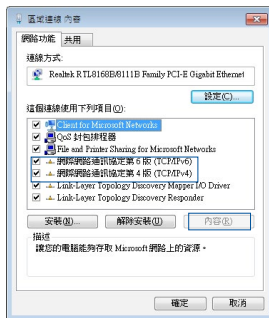

- 欲自動獲取 IPv4 IP 設定，勾選 **自動取得 IP 位址**。
- 完成後點選 **確定**。

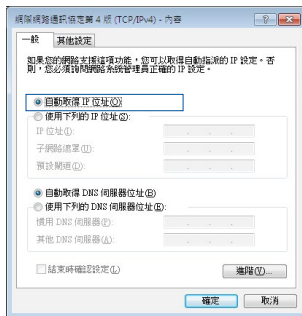

## MAC OS

- 點選左上角的蘋果圖示 。
- 點選 **System Preferences > 網路 > 設定...**
- 點選 **TCP/IP** 標籤，在 **設定 IPv4** 下拉清單中選擇 **使用 DHCP**。
- 完成後點選 **好**。

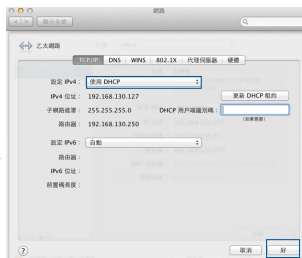

**注意：** 請參考您的作業系統中 **幫助與支援功能**，獲取更多設定 TCP/IP 相關資訊。

## C. 關閉撥號連線

### Windows® 7

1. 點選 開始 > Internet Explorer 開啟瀏覽器。
2. 點選 工具 > 網際網路選項 > 連線 標籤。
3. 勾選 永遠不撥號連線。
4. 完成後點選 確定。

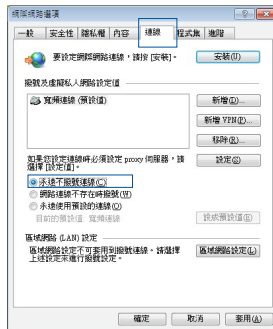

**注意：** 請參考瀏覽器的說明選單進行關閉撥號連線。

## D. 關閉所有正在運作的網路瀏覽器。

### 用戶端無法與路由器建立無線網路連線。

超出有效範圍：

- 請將路由器放置於較靠近用戶端裝置之處。
- 嘗試進行頻道設定的變更。

認證：

- 請使用有線連線方式來連接路由器。
- 檢查網路安全設定。
- 您可以嘗試按路由器後側的重置（Reset）按鈕超過 5 秒鐘，以進行重置設定。

## 無法搜尋到路由器：

- 您可以嘗試按路由器後側的重置（Reset）按鈕超過 5 秒鐘，以進行重置設定。
- 檢查無線網路卡上的 SSID 與加密等設定。

## 無法透過無線網路卡來連線至網際網路。

- 請將路由器放置於較靠近用戶端裝置之處。
- 檢查您所使用的無線網路卡是否有連線到正確的路由器。
- 檢查所使用的無線網路頻道是否符合您的所在地區 / 國家所規範的頻道。
- 檢查加密設定。
- 檢查您所使用的 ADSL 或有線數據機是否有正確連線。
- 重新更換另一條乙太網路線來連接

## 當 ADSL 數據機「Link」（連線）的指示燈持續閃爍或熄滅，這表示無法存取至網際網路 - 路由器無法與 ADSL 網路建立連線。

- 請確認網路線已有正確連接。
- 請將 ADSL 或有線數據機的電源線拔除，並等待幾分鐘後，再重新接上電源。
- 若 ADSL 數據機指示燈持續閃爍或熄滅（顯示 OFF），請與您的網路電信業者聯絡。

## 忘記網路名稱或金鑰密碼。

- 試著再次透過有線連接來設定無線的加密動作。
- 您可以嘗試按路由器的重置（Reset）按鈕超過 5 秒鐘，以進行重置設定。
- 原廠預設值設定：

登入名稱 / 密碼： admin / admin	IP 位址： http://router.asus.com/	SSID： 檢查路由器後側的功率貼紙。
-----------------------------	-----------------------------------	------------------------



## 哪裡可以找到更多的無線路由器資訊？

- 線上 FAQ 網址：<https://www.asus.com/tw/support>
- 技術支援網址：<https://www.asus.com/tw/support>
- 客戶服務熱線：請參閱此快速使用指南的支援熱線（Hotline）

## Isi kemasan

- ☑ RT-AC66U B1
- ☑ Kabel RJ-45
- ☑ Kartu jaminan
- ☑ Adaptor AC
- ☑ Panduan Ringkas



**CATATAN:** Jika salah satu item tersebut rusak atau tidak ada, hubungi peritel.

## Info singkat

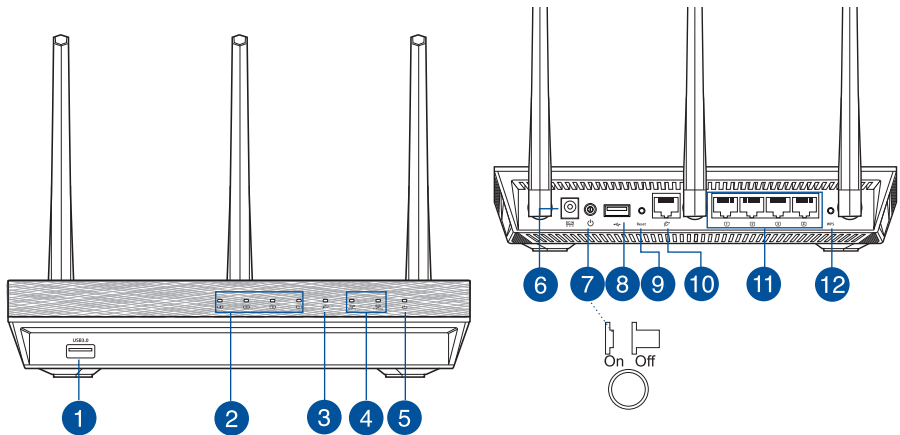

1) Port USB 3.0	5) LED Daya	9) Tombol atur ulang
2) LED LAN	6) Port daya (DC-IN)	10) Port WAN
3) LED WAN	7) Saklar daya	11) Port LAN
4) LED 2.4GHz/5GHZ	8) Port USB 2.0	12) Tombol WPS



---

**CATATAN:**

- **HDD Eksternal USB/Flash disk:**
    - Router nirkabel berfungsi dengan sebagian besar HDD USB//Flash disk yang berkapasitas hingga 2 TB serta mendukung akses baca-tulis untuk FAT16, FAT32, EXT2, EXT3, dan NTFS.
    - Untuk melepas disk USB dengan aman, aktifkan GUI Web (<http://router.asus.com>), kemudian di sudut kanan atas halaman **Network Map (Peta Jaringan)**, klik ikon USB, lalu **klik Eject USB 1 (Lepas USB 1)**.
    - Pelepasan disk USB yang tidak benar dapat menyebabkan kerusakan data.
    - Untuk mengetahui daftar partisi hard disk dan sistem file yang didukung router nirkabel, kunjungi <http://event.asus.com/networks/disksupport>
    - Untuk mengetahui daftar printer yang didukung router nirkabel, kunjungi <http://event.asus.com/networks/printersupport>
-

## Mengatur posisi router nirkabel Anda

Untuk transmisi sinyal nirkabel terbaik antara router nirkabel dan perangkat jaringan yang tersambung, pastikan Anda:

- Menempatkan router nirkabel di area tengah agar jangkauan nirkabel maksimum untuk perangkat jaringan.
- Tidak menghalangi perangkat dengan benda logam dan menjauhkan dari sinar matahari langsung.
- Menjauhkan perangkat dari perangkat Wi-Fi 802.11g atau hanya 20 MHz, periferai komputer 2,4 GHz, perangkat Bluetooth, telepon nirkabel, trafo, mesin berat, cahaya neon, oven microwave, lemari es, dan peralatan industri lainnya untuk mencegah interferensi atau hilangnya sinyal.
- Untuk memastikan sinyal nirkabel terbaik, arahkan tiga antena yang dapat dilepas seperti yang ditunjukkan gambar di bawah.
- Untuk performa optimal, sesuaikan sistem pendinginan internal. Untuk informasi rinci, lihat panduan pengguna.
- Selalu memperbarui ke firmware terkini. Untuk mendapatkan pembaruan firmware terkini, kunjungi situs Web ASUS <http://www.asus.com>.

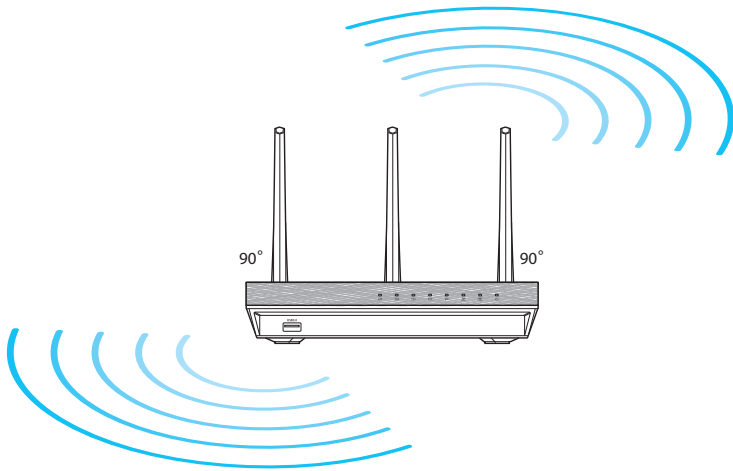

## Persiapan

1. Lepas kabel dari stopkontak dan modem yang ada, lalu hapus alamat IP sebelumnya di komputer.

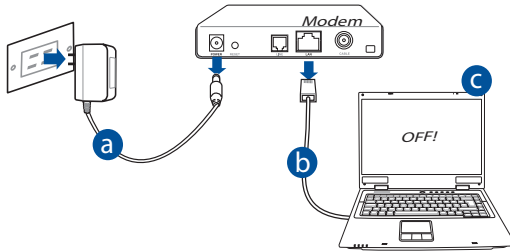

- a: Lepaskan adaptor AC dari stopkontak dan dari kabel/modem ADSL.
- b: Lepaskan kabel jaringan dari kabel/modem ADSL.
- c: Reboot komputer (disarankan).



**PERINGATAN!** Sebelum melepas kabel, pastikan modem kabel/ADSL telah dimatikan minimal selama dua menit. Jika modem dilengkapi baterai cadangan, lepas baterai.

## 2. Mengkonfigurasi lingkungan nirkabel.

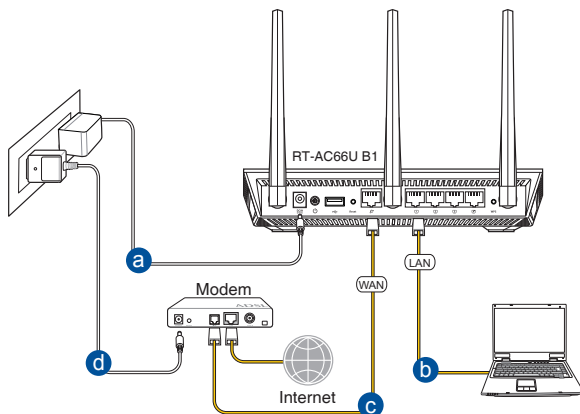

- a: Pasang adaptor AC router nirkabel ke port DC-IN, lalu sambungkan ke stopkontak.
- b: Sambungkan komputer ke port LAN router nirkabel menggunakan kabel jaringan.



**PENTING!** Pastikan LED WAN dan LAN berkedip.

- c: Sambungkan modem ke port WAN router nirkabel menggunakan kabel jaringan.
- d: Pasang adaptor AC modem ke port DC-IN, lalu sambungkan ke stopkontak.

## 3. Menonaktifkan beberapa pengaturan di komputer.

- A. Menonaktifkan server proxy, jika sedang diaktifkan.
- B. Menetapkan pengaturan TCP/IP untuk mengambil alamat IP secara otomatis.
- C. Menonaktifkan sambungan dial-up, jika sedang diaktifkan.



**CATATAN:** Untuk informasi lebih rinci tentang cara menonaktifkan pengaturan komputer, lihat **Tanya Jawab**.

## Persiapan

1. Konfigurasi pengaturan nirkabel melalui GUI Web (Web Graphics User Interface).

a: Buka browser Web seperti Internet Explorer, Firefox, Google Chrome, atau Safari.



a

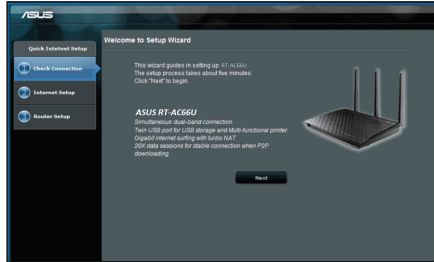

b



**CATATAN:** Jika QIS tidak berjalan secara otomatis, ikuti langkah-langkah berikut untuk menjalankan QIS secara manual:

- Di browser Web, masukkan <http://router.asus.com> dan jalankan kembali Quick Internet Setup (QIS) Wizard (Wizard Quick Internet Setup (QIS)).
- Nonaktifkan pengaturan proxy dan sambungan dial-up, serta tetapkan pengaturan TCP/IP untuk mengambil alamat IP secara otomatis. Untuk selengkapnya, lihat bagian **Tanya Jawab** untuk diagnosis otomatis.

- b:** Fitur Quick Internet Setup (QIS) router nirkabel akan secara otomatis mendeteksi jika jenis sambungan ISP adalah **Dynamic IP (IP Dinamis)**, **PPPoE**, **PPTP**, **L2TP**, dan **Static IP (IP Statis)**. Masukkan informasi penting untuk jenis sambungan Anda.



**CATATAN:** Deteksi otomatis jenis sambungan ISP akan berfungsi saat Anda mengkonfigurasi router nirkabel untuk pertama kalinya atau bila router nirkabel diatur ulang ke pengaturan default.



**PENTING!** Dapatkan informasi penting tentang jenis sambungan Internet dari ISP (Penyedia Layanan Internet) Anda.

- c:** Tetapkan nama jaringan (SSID) dan kode keamanan untuk sambungan nirkabel 2,4 GHz dan 5 GHz. Klik **Apply (Terapkan)** ketika selesai.
- d:** Pengaturan Internet dan nirkabel akan ditampilkan. Klik **Next (Selanjutnya)** untuk melanjutkan.
- e:** Baca petunjuk sambungan jaringan nirkabel. Setelah selesai, klik **Finish (Selesai)**.

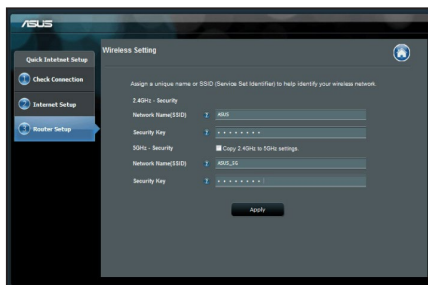

**CATATAN:** Anda dapat menetapkan nama jaringan dengan maksimal 32 karakter.



## Tanya Jawab

Setelah mengikuti langkah-langkah tersebut, saya masih tidak dapat mengakses GUI Web (antarmuka pengguna grafis Web) router nirkabel untuk mengkonfigurasi pengaturan router nirkabel.

### A. Disable the proxy server, if enabled.

#### Windows® 7

1. Klik **Start (Mulai) > Internet Explorer** untuk membuka browser Web.
2. Klik tab **Tools (Alat) > Internet options (Opsis internet) > Connections (Sambungan) > LAN settings (Pengaturan LAN)**.
3. Dari layar Local Area Network (LAN) Settings, hapus tanda centang pada **Use a proxy server for your LAN (Gunakan server proxy untuk LAN)**.
4. Klik **OK** setelah selesai.

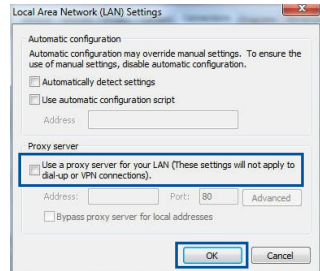
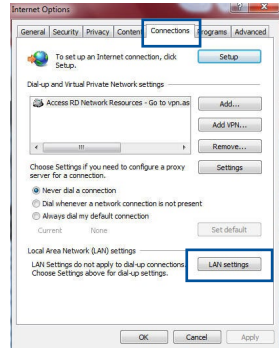

## MAC OS

1. Dari panel menu, klik tab **Safari > Preferences... (Preferensi...) > Advanced (Lanjutan) > Change Settings... (Ubah Pengaturan...)**.
2. Dari daftar protokol, hapus tanda centang pada **FTP Proxy (Proxy FTP)** dan **Web Proxy (HTTP) (Proxy Web (HTTP))**.
3. Klik **Apply Now (Terapkan Sekarang)** setelah selesai.

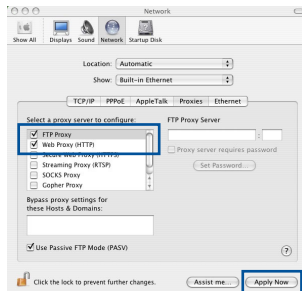

**CATATAN:** Untuk informasi rinci tentang cara menonaktifkan server proxy, lihat fitur bantuan browser Anda.

## B. Menetapkan pengaturan TCP/IP untuk mengambil alamat IP secara otomatis.

### Windows® 7

1. Klik **Start (Mulai) > Control Panel (Panel Kontrol) > Network and Internet (Jaringan dan Internet) > Network and Sharing Center (Pusat Jaringan dan Berbagi) > Manage network connections (Kelola sambungan jaringan)**.
2. Pilih **Internet Protocol Version 4 (TCP/IPv4) (Protokol Internet Versi 4 (TCP/IPv4))**, lalu klik **Properties (Properti)**.

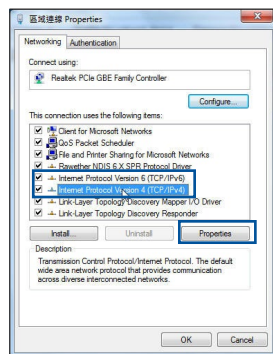

- Untuk mendapatkan pengaturan IP IPv4 secara otomatis, centang **Obtain an IP address automatically (Dapatkan alamat IP secara otomatis)**.
- Klik **OK** setelah selesai.

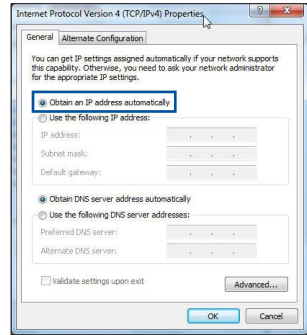

## MAC OS

- Klik ikon Apple  yang berada di kiri atas layar.
- Klik **System Preferences (Preferensi Sistem) > Network (Jaringan) > Configure... (Konfigurasi...)**
- Dari tab **TCP/IP**, pilih **Using DHCP (Menggunakan DHCP)** di daftar drop-down **Configure IPv4 (Konfigurasi IPv4)**.
- Klik **Apply Now (Terapkan Sekarang)** setelah selesai.

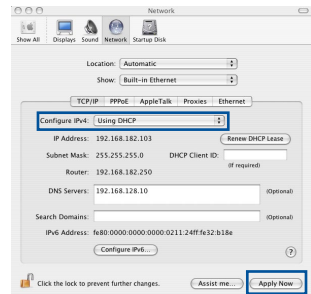

**CATATAN:** Untuk informasi rinci tentang cara mengkonfigurasi pengaturan TCP/IP komputer, lihat fitur bantuan dan dukungan sistem operasi Anda.

## C. Menonaktifkan sambungan dial-up, jika sedang diaktifkan.

### Windows® 7

1. Klik **Start (Mulai)** > **Internet Explorer** untuk membuka browser Web.
2. Klik tab **Tools (Alat)** > **Internet options (Opsi internet)** > **Connections (Sambungan)**.
3. Centang **Never dial a connection (Jangan aktifkan sambungan)**.
4. Klik **OK** setelah selesai.

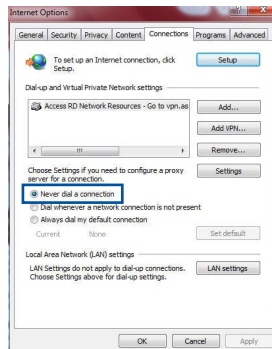

**CATATAN:** Untuk informasi rinci tentang cara menonaktifkan pengaturan sambungan dial-up, lihat fitur bantuan browser Anda.

## D. Tutup semua browser Web yang berjalan.

### Sambungan nirkabel antara klien dan router tidak dapat dibuat.

#### Di Luar Jangkauan:

- Dekatkan posisi router dengan klien nirkabel.
- Coba ubah pengaturan kanal.

#### Otentikasi:

- Gunakan sambungan berkabel untuk menyambung ke router.
- Periksa pengaturan keamanan nirkabel.
- Tekan tombol Reset (Atur Ulang) pada panel belakang selama lebih dari 5 detik.

### Router tidak dapat ditemukan:

- Tekan tombol Reset (Atur Ulang) pada panel belakang selama lebih dari 5 detik.
- Periksa pengaturan pada adapter nirkabel, misalnya pengaturan SSID dan enkripsi.

### Tidak dapat mengakses Internet melalui adapter LAN nirkabel.

- Dekatkan posisi router dengan klien nirkabel.
- Pastikan adapter nirkabel telah tersambung ke router nirkabel yang benar.
- Pastikan kanal nirkabel yang digunakan telah sesuai dengan kanal yang tersedia di negara/wilayah Anda.
- Periksa pengaturan enkripsi.
- Pastikan sambungan ADSL atau Kabel sudah benar.
- Coba kembali menggunakan kabel Ethernet.

### Jika lampu "LINK" ADSL terus berkedip atau tidak menyala, Internet tidak dapat diakses - Router tidak dapat membuat sambungan dengan jaringan ADSL.

- Pastikan semua kabel tersambung dengan benar.
- Lepaskan kabel daya dari modem ADSL atau kabel, tunggu beberapa menit, kemudian sambungkan kabel kembali.
- Jika lampu ADSL terus berkedip atau tidak menyala, hubungi penyedia layanan ADSL Anda

### Saya lupa nama jaringan atau kunci keamanan.

- Coba konfigurasi sambungan berkabel, kemudian konfigurasi kembali pengaturan enkripsi.
- Tekan tombol Atur ulang selama lebih dari lima detik untuk mengatur ulang atau mengembalikan sistem ke pengaturan default pabrik.
- Pengaturan default pabrik:

<b>Nama pengguna / Sandi:</b> admin / admin	<b>Alamat IP:</b> http://router.asus.com	<b>SSID:</b> Periksa label arus di bagian belakang router
------------------------------------------------	---------------------------------------------	--------------------------------------------------------------

### Di mana saya dapat memperoleh informasi lengkap tentang router nirkabel?

- Situs tanya jawab online: <http://support.asus.com/faq>
- Situs Dukungan Teknis: <https://www.asus.com/support/>
- Hotline Pelanggan: Lihat Hotline Dukungan dalam Panduan Tambahan.

## Kandungan pembungkusan

- ☑ RT-AC66U B1
- ☑ Kabel RJ-45
- ☑ Kad waranti
- ☑ Penyesuai AU
- ☑ Panduan Mula Ringkas



**NOTA:** Jika mana-mana daripada item ini rosak atau hilang, hubungi penjual anda.

## Melihat sepintas Lalu RT-AC66U B1 anda

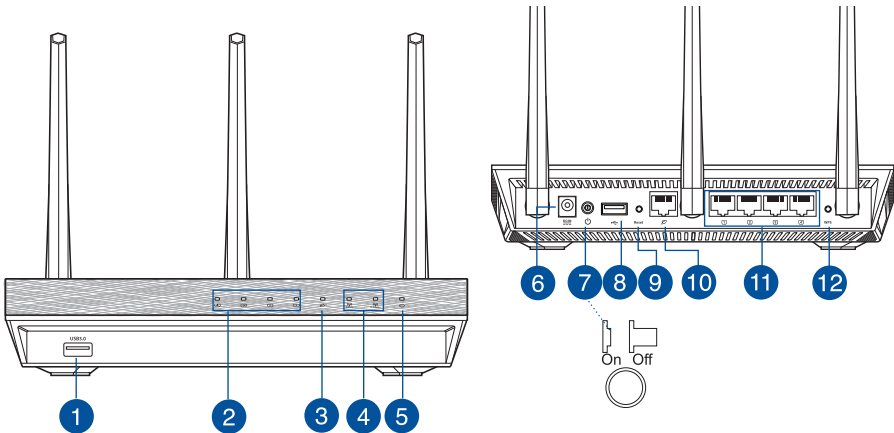

1) Port USB 3.0	5) Power LED	9) Reset button
2) LAN LED	6) Power (DC-IN) port	10) WAN port
3) WAN LED	7) Suis kuasa	11) LAN ports
4) 2.4GHz/5GHz LED	8) USB 2.0 port	12) WPS button



---

**NOTA:****• USB HDD Luaran/Cakera kilat:**

- Penghala wayarles berfungsi dengan kebanyakan USB HDD/Cakera kilat sehingga 2TB dan menyokong akses baca-tulis untuk FAT16, FAT32, EXT2, EXT3, dan NTFS.
  - Untuk mengeluarkan cakera USB dengan selamat, lancarkan GUI web (<http://router.asus.com>), kemudian di sudut atas sebelah kanan halaman **Network Map (Peta Rangkaian)**, klik ikon USB dan klik **Eject USB 1**.
  - Pengeluaran tidak betul cakera USB boleh menyebabkan kerosakan data.
  - Untuk senarai sistem fail dan sekatan cakera keras yang penghala wayarles ini sokong, lawati <http://event.asus.com/networks/disksupport>
  - Untuk senarai pencetak yang penghala wayarles ini sokong, lawati <http://event.asus.com/networks/printersupport>
-



## Meletakkan penghala wayarles anda

Untuk penghantaran wayarles optimum antara penghala wayarles dan peranti wayarles yang bersambung, pastikan anda:

- Letakkan penghala wayarles dalam kawasan terpusat untuk liputan wayarles maksimum untuk peranti rangkaian.
- Pastikan penghala wayarles jauh daripada penghalang logam dan jauh daripada cahaya matahari langsung.
- Pastikan penghala wayarles jauh daripada peranti Wi-Fi 802.11g atau 20MHz sahaja, 2.4GHZ persisian komputer, peranti Bluetooth, telefon kordles, pengubah, motor tugas berat, lampu kalimantang, ketuahr gelombang mikro, peti sejuk, dan peralatan industri lain untuk mengelakkan gangguan atau kehilangan isyarat.
- Untuk memastikan isyarat wayarles terbaik, sesuaikan 3 antena boleh tanggal seperti yang ditunjukkan dalam rajah di bawah.
- Untuk prestasi optimum, laraskan sistem penyejukan dalaman. Rujuk manual pengguna untuk mendapatkan butiran.
- Sentiasa kemas kini perisian tegar terkini. Lawati tapak web ASUS di <http://www.asus.com> untuk mendapatkan kemas kini perisian tegar terkini.

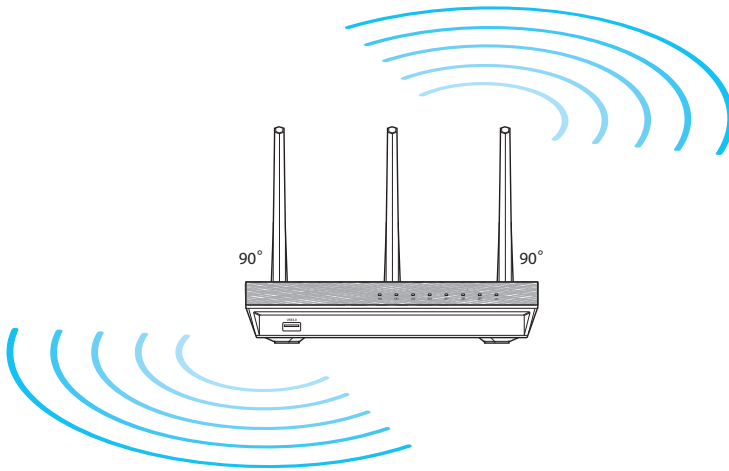

## Sebelum anda meneruskan

1. Tanggalkan dan lepaskan wayar/kabel dari persediaan modem sedia ada anda dan lepaskan alamat IP lapuk komputer anda.

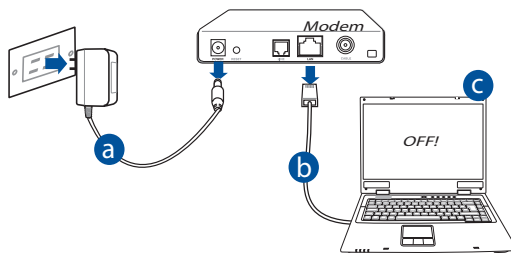

- a: Cabut keluar palam adapter AC daripada outlet kuasa dan putuskan sambungan daripada kabel/modem ADSL anda.
- b. Putuskan sambungan kabel rangkaian daripada kabel/modem ADSL.
- c. But semula komputer anda (dicadangkan).



**AMARAN!** Sebelum memutuskan sambungan wayar/kabel, pastikan kabel/modem ADSL telah dimatikan selama sekurang-kurangnya dua minit. Jika modem anda mempunyai bateri sandaran, keluarkanannya sekali.

## 2. Sediakan persekitaran wayarles anda.

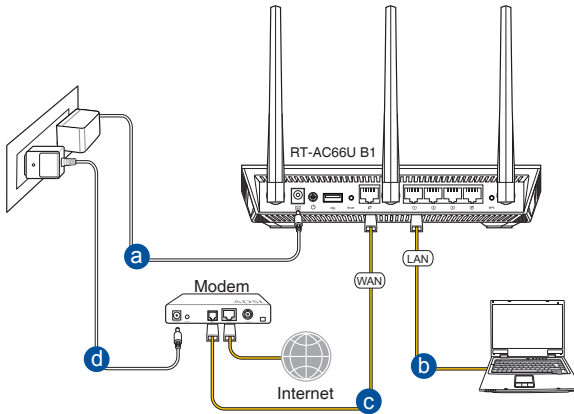

- a. Masukkan penyesuai AC EA-N66 ke port DC-In (AT-Masuk) dan pasang alur keluar kuasa.
- b. Sambungkan computer anda ke port LAN penghala wayarles anda menggunakan kabel rangkaian terganggu.



**PENTING!** Pastikan bahawa LED WAN dan LAN berkelip.

- c: Menggunakan kabel rangkaian lain, sambungkan modem anda ke port WAN penghala wayarles anda.
- d: Masukkan adapter AC modem anda ke port DC-IN dan palamkan pada outlet kuasa.

## 3. Nyahdaya beberapa tetapan pada komputer anda.

- A. Nyahdayakan pelayan proksi, jika didayakan.
- B. Tetapkan tetapan TCP/IP untuk mendapatkan alamat IP secara automatik.
- C. Nyahdaya sambungan dailan, jika didayakan.



**NOTA:** Untuk butiran lanjut mengenai menyahdayakan tetapan komputer anda, rujuk **Frequently Asked Questions (Soalan Lazim) (FAQ)**.

## Bermula

1. Konfigurasi tetapan wayarles anda melalui antara muka pengguna grafik web penghalang wayarles (web GUI).

a: Lancarkan pelayar web anda seperti Internet Explorer, Firefox, Google Chrome atau Safari.



a

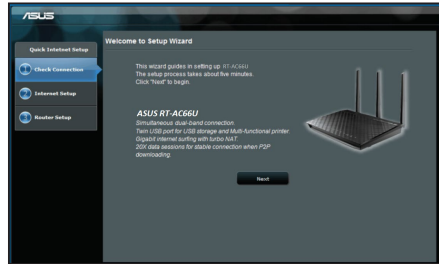

b



**NOTA:** Jika QIS tidak dilancarkan secara automatik, ikuti langkah-langkah ini untuk melancarkan QIS secara manual:

- Pada penyemak imbas web anda, masukkan <http://router.asus.com> dan jalankan Wizard Persediaan Internet Pantas (QIS) sekali lagi.
- Nyahdayakan tetapan proksi, sambungan dailan dan tetapkan tetapan TCP/IP anda untuk mendapatkan alamat IP secara automatik. Untuk mendapatkan butiran lanjut, rujuk seksyen **FAQ (Soalan Lazim)** sokongan untuk diagnosis auto.

- b:** Ciri Persediaan Internet Pantas (QIS) bagi penghala wayarles mengesan secara automatik sama ada jenis sambungan ISP anda ialah **IP Dinamik**, **PPPoE**, **PPTP**, **L2TP**, dan **IP Statik**. Masukkan maklumat yang diperlukan untuk jenis sambungan anda.



**NOTA:** Pengesanan auto bagi jenis sambungan ISP anda akan berjalan apabila anda mengkonfigurasi penghala wayarles buat pertama kali atau apabila penghala wayarles anda ditetapkan semula kepada tetapan lalainya.



**PENTING!** Dapatkan maklumat yang diperlukan mengenai jenis sambungan Internet anda daripada Pembekal Khidmat Internet (ISP) anda.

- c:** Berikan nama rangkaian (SSID) dan kunci keselamatan untuk sambungan wayarles 2.4GHz dan 5GHz anda. Klik **Apply (Guna)** apabila selesai.
- d:** Tetapan Internet dan wayarles anda dipaparkan. Klik **Next (Seterusnya)** untuk teruskan.
- e:** Baca tutorial sambungan rangkaian wayarles. Apabila selesai, klik **Finish (Selesai)**.

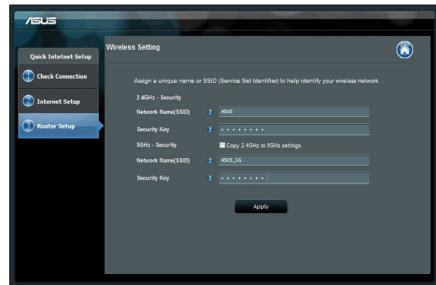

**NOTA:** Anda boleh memberikan nama rangkaian sehingga 32 aksara.

## Soalan Lazim (FAQ)

Selepas mengikuti langkah tersebut, saya masih tidak boleh mengakses antara muka pengguna grafik web penghala wayarles (web GUI) untuk mengkonfigurasi tetapan penghala wayarles.

### A. Nyahdayakan sebarang pelayan proksi yang dikonfigurasi.

#### Windows® 7

1. Klik **Start (Mula)** > **Internet Explorer** untuk melancarkan penyemak imbas.
2. Klik **Tools (Alatan)** > **Internet options (Pilihan Internet)** > **Connections tab (tab Sambungan)** > **LAN settings (Tetapan LAN)**.

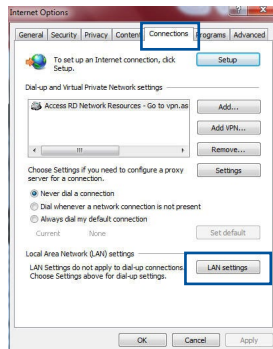

3. Dari tettingkap Local Area Network (LAN) Settings, buang tanda **Use a proxy server for your LAN**.
4. Klik **OK** setelah selesai.

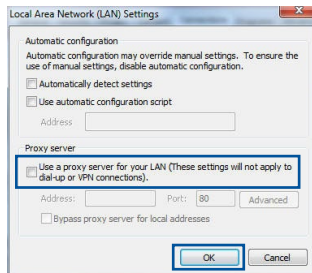

## MAC OS

1. Dari penyemak imbas Safari anda, klik **Safari (Safari) > Preferences (Keutamaan) > Advanced (Lanjutan) > Change Settings... (Tukar Tetapan...)**
2. Dari skrin Network (Rangkaian), buang tanda **FTP Proxy (FTP Proksi)** dan **Web Proxy (HTTP (Proksi Web))**.
3. Klik **Apply Now (Guna Sekarang)** apabila selesai.

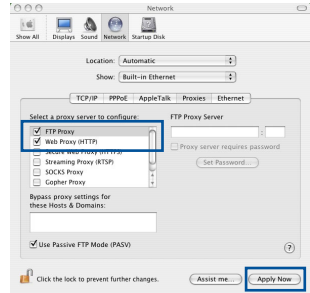

**NOTA:** Rujuk ciri bantuan penyemak imbas anda untuk mendapatkan butiran mengenai menyahdayakan pelayan proksi.

## B. Menetapkan tetapan TCP/IP untuk dapatkan alamat IP secara automatik.

### Windows® 7

1. Klik **Start (Mula) > Control Panel (Panel Kawalan) > Network and Internet (Rangkaian dan Internet) > Network and Sharing Center (Rangkaian dan Pusat Perkongsian) > Manage network connections (Urus sambungan rangkaian)**.
2. Pilih **Internet Protocol Version 4 (TCP/IPv4)**, kemudian klik **Properties (Ciri-ciri)**.

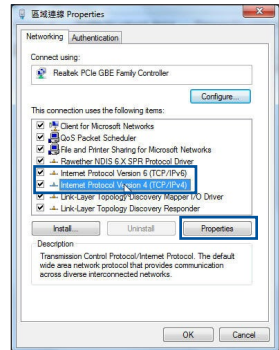

- Untuk mendapatkan tetapan IP IPv4 secara automatik, tandakan **Obtain an IP address automatically (Dapatkan alamat IP secara automatik)**.
- Klik **OK** setelah selesai.

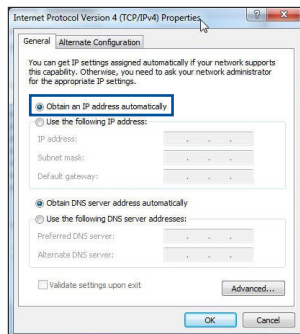

## MAC OS

- Klik ikon Epal  yang terdapat di bahagian atas kiri skrin anda.
- Klik **System Preferences (Keutamaan Sistem) > Network (Rangkaian) > Configure (Konfigurasi)...**
- Dari tab **TCP/IP**, pilih **Using DHCP (Menggunakan DHCP)** dalam senarai jatuh turun **Configure IPv4 (Konfigurasi IPv4)**.
- Klik **Apply Now (Guna Sekarang)** setelah selesai.

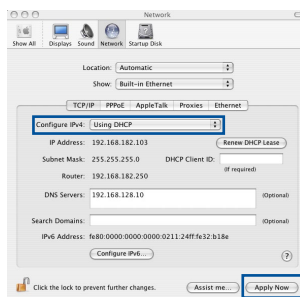

**NOTA:** Rujuk ciri bantuan dan sokongan sistem pengendalian anda untuk mendapatkan butiran mengenai mengkonfigurasi tetapan TCP/IP komputer anda.



### C. Nyahdayakan sambungan dailan, jika didayakan.

#### Windows® 7

1. Klik **Start (Mula) > Internet Explorer** untuk melancarkan penyemak imbas.
2. Klik tab **Tools (Alatan) > Internet options (Pilihan Internet) > Connections tab (Tab Sambungan)**.
3. Tandakan **Never dial a connection (Jangan sekali-kali dail sambungan)**.
4. Klik **OK** setelah selesai.

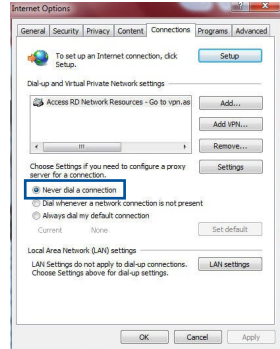

**NOTA:** Rujuk ciri bantuan penyemak imbas anda untuk mendapatkan butiran mengenai menyahdayakan tetapan sambungan dailan.

### D. Tutup semua penyemak imbas web yang sedang berjalan.

#### Klien tidak dapat membentuk sambungan wayarles dengan penghala.

##### Luar Julat:

- Letakkan penghala berdekatan dengan klien wayarles.
- Cuba menukar tetapan saluran.

##### Pengesahan:

- Gunakan sambungan berwayar untuk menyambung ke penghala.
- Periksa tetapan keselamatan wayales.
- Tekan butang Tetap Semula di belakang panel selama lebih daripada lima saat.

**Tidak dapat mencari penghala:**

- Tekan butang Tetap Semula di belakang panel selama lebih daripada lima saat.
- Periksa tetapan dalam adapter tanpa wayar seperti tetapan SSID dan penyulitan.

**Tidak dapat mengakses Internet melalui adapter wayarles LAN.**

- Alihkan penghala berdekatan dengan klien wayarles.
- Periksa sama ada adapter wayarles disambung ke penghala wayarles yang betul.
- Periksa sama ada saluran wayarles yang digunakan mengikut saluran tersedia di negara/kawasan anda.
- Periksa tetapan penyulitan.
- Periksa jika sambungan ADSL atau Kabel betul.
- Cuba semula menggunakan sama ada kabel Ethernet.

**Jika lampu ADSL "LINK" berterusan berkelip atau kekal mati, tiada akses Internet - Penghala tidak dapat membentuk sambungan dengan rangkaian ADSL.**

- Pastikan bahawa semua kabel anda disambungkan dengan betul.
- Putuskan sambungan kod kuasa dari modem ADSL atau kabel, tunggu beberapa mini, kemudian sambung semula kod.
- Jika lampu ADSL terus berkelip atau kekal MATI, hubungi pembekal perkhidmatan ADSL anda.

**Terlupa nama atau kunci penyulitan rangkaian.**

- Cuba menyediakan sambungan berwayar dan mengkonfigurasikan penyulitan wayarles sekali lagi.
- Tekan butang Tetap Semula penghala tanpa wayar selama lebih daripada lima saat.
- Tetapan lalai kilang:

<b>Nama pengguna / kata laluan:</b> admin / admin	<b>Alamat IP:</b> http://router.asus.com	<b>SSID:</b> Periksa label perkadaran di bahagian belakang penghala anda
---------------------------------------------------	------------------------------------------	-----------------------------------------------------------------------------

### Di manakah saya boleh mendapatkan maklumat lanjut mengenai penghala tanpa wayar?

- Tapak FAQ dalam talian: <http://support.asus.com/faq>
- Tapak Sokongan Teknikal: <https://www.asus.com/support/>
- Hotline Pelanggan: Rujuk Hotline Sokongan dalam Panduan Mula Pantas ini

## สิ่งต่างๆ ในกล่องบรรจุ

- ☑ RT-AC66U B1
- ☑ RJ-45 เคเบิล
- ☑ ไขควงปรับประกัน
- ☑ อะแดปเตอร์ AC
- ☑ คู่มือเริ่มต้นฉบับย่อ



**หมายเหตุ:** กรุณาตรวจสอบรายการใดๆ เสียหายหรือหายไป  
ให้ติดต่อร้านค้าของคุณ

## ภาพรวม

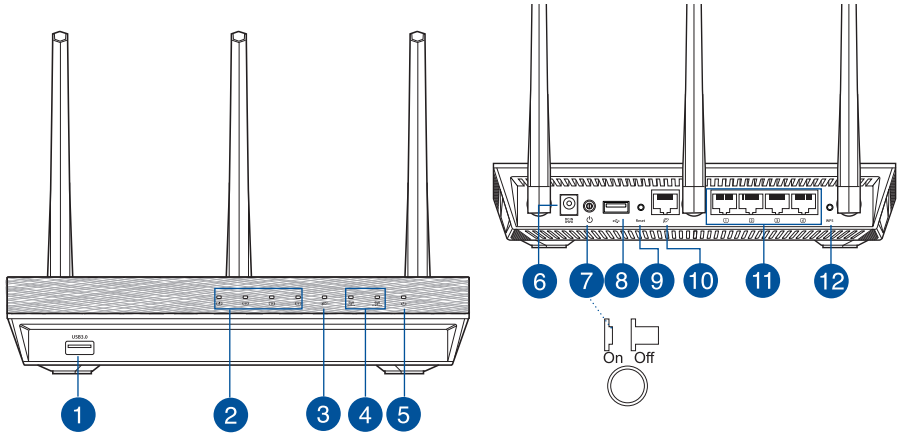

1) พอร์ต USB 3.0	5) LED เพาเวอร์	9) ปุ่มรีเซ็ต
2) LED LAN	6) พอร์ตเพาเวอร์ (DC-เขา)	10) พอร์ต WAN
3) LED WAN	7) สวิตช์ไฟ	11) พอร์ต LAN
4) LED 2.4GHZ/5GHZ	8) พอร์ต USB 2.0	12) ปุ่ม WPS



---

หมายเหตุ:

- **USB HDD ภายนอก/แฟลชดีสก์:**

- ไวลเลสเราเตอร์ทำงานกับ USB HDD/แฟลชดีสก์ขนาดใหญ่ถึง 2TB และสนับสนุนการอ่าน-เขียนสำหรับระบบ FAT16, FAT32, EXT2, EXT3 และ NTFS
  - ในการถอด USB ดีสก์อย่างปลอดภัย, เปิดเว็บ GUI (<http://www.asus.com>), จากหน้าที่มุมขวาบนของหน้า **Network Map (แผนที่เครือข่าย)**, คลิกไอคอน USB และคลิก **Eject USB 1 (นำ USB 1 ออก)**
  - การถอด USB ดีสก์อย่างไม่ถูกต้อง อาจทำให้ข้อมูลเสียหายได้
  - สำหรับรายการของระบบไฟล์ และฮาร์ดดีสก์พาร์ติชันที่ไวเลสเราเตอร์สนับสนุน ให้เยี่ยมชมที่ <http://event.asus.com/networks/disksupport>
  - สำหรับรายการของเครื่องพิมพ์ที่ไวเลสเราเตอร์สนับสนุน ให้เยี่ยมชมที่ <http://event.asus.com/networks/printersupport>
-

## การวางตำแหน่งไวร์เลส เราเตอร์ของคุณ

เพื่อให้การรับส่งสัญญาณไร้สายระหว่างไวร์เลสเราเตอร์ และอุปกรณ์เครือข่ายที่เชื่อมต่ออยู่มีคุณภาพดีที่สุด ให้แน่ใจว่าคุณ:

- วางไวร์เลสเราเตอร์ในบริเวณศูนย์กลาง เพื่อให้ครอบคลุมพื้นที่ไร้สายมากที่สุดสำหรับอุปกรณ์เครือข่าย
- วางอุปกรณ์ให้ห่างจากวัตถุวางกันที่เป็นโลหะ และไม่ให้อุปกรณ์ถูกแสงแดดโดยตรง
- วางอุปกรณ์ให้ห่างจากอุปกรณ์ Wi-Fi 802.11g หรือ 20MHz, อุปกรณ์ต่อพ่วงคอมพิวเตอร์ 2.4GHz, อุปกรณ์บลูทูธ, โทรศัพท์ไร้สาย, หมอแปลง, มอเตอร์พลังงานสูง, แสงฟลูออเรสเซนต์, เต้าไมโครเวฟ, ตู้เย็น และอุปกรณ์อุตสาหกรรมอื่นๆ เพื่อป้องกันสัญญาณรบกวน หรือสัญญาณสูญหาย
- เพื่อให้มั่นใจถึงสัญญาณไร้สายที่ดีที่สุด ให้ปรับทิศทางเสาอากาศที่สามารถถอดได้ 3 อัน ในลักษณะที่แสดงในภาพด้านล่าง
- เพื่อให้ได้สมรรถนะที่ดีที่สุด ให้ปรับระบบทำความเย็นภายใน ให้ดูคู่มือผู้ใช้สำหรับรายละเอียด
- อัปเดตไปเป็นเฟิร์มแวร์ล่าสุดเสมอ เยี่ยมชมเว็บไซต์ ASUS ที่ <http://www.asus.com> เพื่อรับอัปเดตเฟิร์มแวร์ล่าสุด

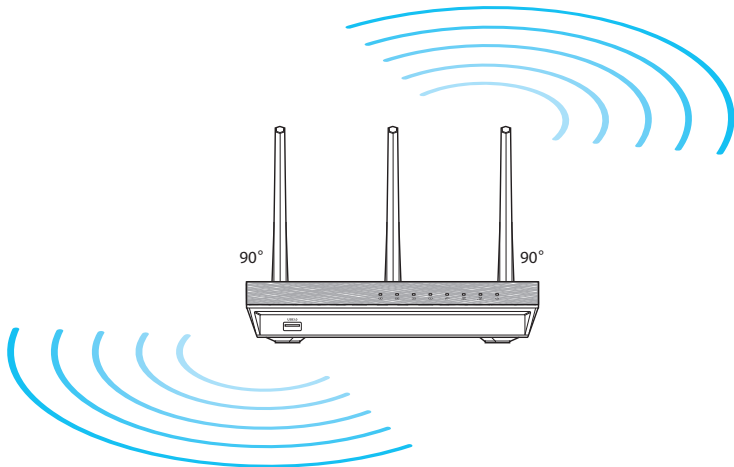

## ก่อนที่จะดำเนินการ

1. ถอดปลั๊ก และตัดการเชื่อมต่อสายไฟ/สายเคเบิลจากโมเด็มที่มีอยู่ และปล่อย IP แอดเดรสที่ลาสี่มยของคอมพิวเตอร์

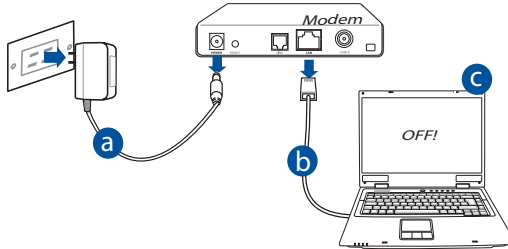

- a: ถอดปลั๊กอะแดปเตอร์ AC จากเต้าเสียบไฟฟ้ และตัดการเชื่อมต่อจากเคเบิล /ADSL โมเด็มของคุณ
- b: ตัดการเชื่อมต่อสายเคเบิลเครือข่ายจากเคเบิล/ADSL โมเด็มของคุณ
- c: บูตคอมพิวเตอร์ใหม่ (แนะนำ)



**คำเตือน!** ก่อนที่จะตัดการเชื่อมต่อสายไฟ/สายเคเบิล, ให้นำในจาวาเคเบิล/ADSL โมเด็มของคุณปิดเครื่องแล้วเป็นเวลาอย่างน้อย 2 นาที ถ้าโมเด็มของคุณมีแบตเตอรี่สำรอง ให้ถอดออกด้วย

## 2. ตั้งค่าสภาพแวดล้อมไร้สายของคุณ

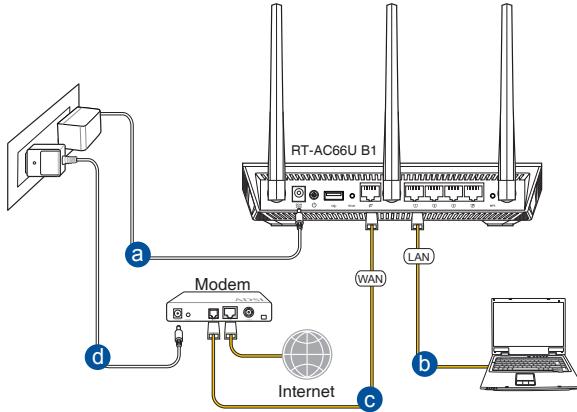

- a: เสียบอะแดปเตอร์ AC ของไวร์เลสเราเตอร์ของคุณเข้ากับพอร์ต DC เข้า และเสียบเข้ากับเตาเสียบไฟฟ้าที่ผนัง
- b: ใช้สายเคเบิลเครือข่าย เชื่อมต่อคอมพิวเตอร์ของคุณเข้ากับพอร์ต LAN ของไวร์เลสเราเตอร์ของคุณ



**สำคัญ!** ตรวจสอบให้แน่ใจว่า LED WAN และ LAN กะพริบ

- c: ใช้สายเคเบิลเครือข่ายอีกเส้นหนึ่ง เชื่อมต่อโมเด็มของคุณเข้ากับพอร์ต WAN ของไวร์เลสเราเตอร์ของคุณ
- d: เสียบอะแดปเตอร์ AC ของโมเด็มของคุณเข้ากับพอร์ต DC เข้า และเสียบเข้ากับ เต้าเสียบไฟฟ้าที่ผนัง

## 3. ปิดการทำงานการตั้งค่าบางอย่างบนคอมพิวเตอร์ของคุณ

- A. ปิดทำงานพร็อกซีเซิร์ฟเวอร์ ถ้าเปิดทำงานอยู่
- B. ตั้งค่าการตั้งค่า TCP/IP เป็น Automatically obtain an IP address (รับที่อยู่ IP โดยอัตโนมัติ)
- C. ปิดการทำงานการเชื่อมต่อแบบโทรเข้า ถ้าเปิดทำงานอยู่



**หมายเหตุ:** สำหรับรายละเอียดเพิ่มเติมเกี่ยวกับการปิดการทำงานการตั้งค่าของคอมพิวเตอร์ ให้ดู *คำถามที่พบบ่อย (FAQ)*



# เริ่มต้นการใช้งาน

1. กำหนดค่าของการตั้งค่าไร้สายของคุณผ่านระบบติดตั้งผู้ใช้แบบกราฟฟิคบนเว็บ (เว็บ GUI)

a: เปิดเว็บเบราว์เซอร์ของคุณ เช่น Internet Explorer, Firefox, Google Chrome, หรือ Safari.



a



b



**หมายเหตุ:** ถ้า QIS ไม่เปิดโดยอัตโนมัติ, ให้ปฏิบัติตามขั้นตอนเหล่านี้เพื่อเปิด QIS:

- บนเว็บเบราว์เซอร์ของคุณ, ป้อน <http://www.asus.com> และรันตัวช่วยสร้างการตั้งค่าอินเทอร์เน็ตอย่างรวดเร็ว (QIS) อีกครั้ง
- ปิดทำงานการตั้งค่าพร็อกซี, การเชื่อมต่อแบบโทรเข้า และตั้งค่าการตั้งค่า TCP/IP ของคุณให้รับที่อยู่ IP โดยอัตโนมัติ สำหรับรายละเอียดเพิ่มเติมให้ดูส่วน *คำถามที่พบบ่อยๆ* สนับสนุนสำหรับการวินิจฉัยโดยอัตโนมัติ

- b:** คุณสมบัติ การตั้งค่าอินเทอร์เน็ตอย่างรวดเร็ว (QIS) ของเราเตอร์ของเราจะตรวจพบโดยอัตโนมัติว่าชนิดการเชื่อมต่อ ISP ของคุณเป็น **Dynamic IP (ไดนามิก IP), PPPoE, PPTP, L2TP และ Static IP (สแตติก IP)** พิมพ์ข้อมูลที่จำเป็นสำหรับชนิดการเชื่อมต่อของคุณเข้าไป



**หมายเหตุ:** การตรวจจับชนิดการเชื่อมต่อ ISP ของคุณโดยอัตโนมัติจะเกิดขึ้นเมื่อคุณกำหนดค่าเราเตอร์เป็นครั้งแรก หรือเมื่อเราเตอร์ของคุณถูกรีเซ็ตกลับเป็นการตั้งค่าเริ่มต้น



**สำคัญ!** ขอรับข้อมูลที่จำเป็นเกี่ยวกับชนิดการเชื่อมต่ออินเทอร์เน็ตของคุณจากผู้ให้บริการอินเทอร์เน็ต (ISP)

- c:** กำหนดชื่อเครือข่าย (SSID) และคีย์การป้องกันสำหรับการเชื่อมต่อไร้สาย 2.4GHz และ 5GHz ของคุณ คลิก **Apply (นำไปใช้)** เมื่อเสร็จ
- d:** การตั้งค่าอินเทอร์เน็ตและการตั้งค่าไร้สายของคุณจะแสดงขึ้น คลิก **Next (ถัดไป)** เพื่อทำต่อ
- e:** อ่านข้อมูลการสอนเกี่ยวกับการเชื่อมต่อไร้สาย เมื่อทำเสร็จ, คลิก **Finish (เสร็จ)**

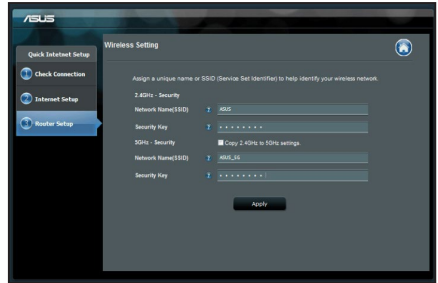

**หมายเหตุ:** คุณสามารถกำหนดชื่อเครือข่ายโดยใช้ตัวอักษรได้มากถึง 32 ตัว

## คำถามที่พบบ่อยๆ (FAQ)

หลังจากที่ทำตามขั้นตอนต่างๆ แล้ว ยังคงไม่สามารถเข้าถึงระบบติดต่อผู้ใช้แบบกราฟฟิกบนเว็บของไอร์เลสเราเตอร์ (เว็บ GUI) เพื่อกำหนดค่าการตั้งค่าไอร์เลสเราเตอร์ได้

### A. ปิดทำงานพร็อกซีเซิร์ฟเวอร์ ถ้าเปิดทำงานอยู่

#### Windows® 7

1. คลิก **Start (เริ่ม) > Internet Explorer (อินเทอร์เน็ต เอ็กซ์พลอเรอร์)** เพื่อเปิดเว็บเบราว์เซอร์
2. คลิก **Tools (เครื่องมือ) > Internet options (ตัวเลือกอินเทอร์เน็ต) > แท็บ Connections (การเชื่อมต่อ) > LAN settings (การตั้งค่า LAN)**
3. จากหน้าจอ **Local Area Network (LAN) Settings (การตั้งค่าเครือข่ายท้องถิ่น (LAN))**, ลบเครื่องหมายจาก **Use a proxy server for your LAN (ใช้พร็อกซีเซิร์ฟเวอร์สำหรับ LAN ของคุณ)**
4. คลิก **OK (ตกลง)** เมื่อทำเสร็จ

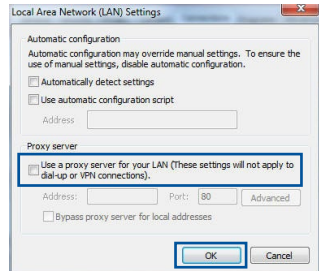
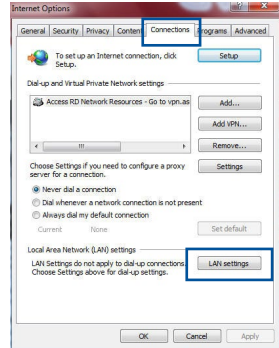

## MAC OS

1. จากแถบเมนู, คลิก **Safari (ซาฟารี) > Preferences ... (การกำหนดลักษณะ...) > แท็บ Advanced (ขั้นสูง > Change Settings... (เปลี่ยนแปลงการตั้งค่า...).**
2. จากรายการของโพรโทคอล, ยกเลิกการเลือก **FTP Proxy (FTP พร็อกซี) และ Web Proxy (HTTPS) (เว็บพร็อกซี (HTTPS))**
3. คลิก **Apply Now (นำไปใช้เดี๋ยวนี้)** เมื่อทำเสร็จ

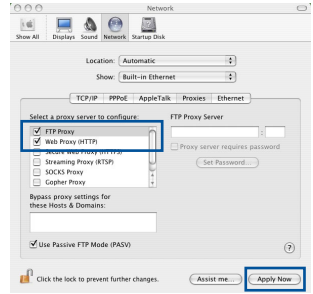

**หมายเหตุ:** คุณควรสมัครตัววิธีใช้ของเราเซอร์ของคุณ สำหรับ รายละเอียดเกี่ยวกับการปิดทำงานพร็อกซีเซิร์ฟเวอร์

## B. ตั้งค่าการตั้งค่า TCP/IP เป็น Automatically obtain an IP address (รับที่อยู่ IP โดยอัตโนมัติ)

### Windows® 7

1. คลิก **Start (เริ่ม) > Control Panel (แผงควบคุม) > Network and Internet (เครือข่ายและอินเทอร์เน็ต) > Network and Sharing Center (ศูนย์เครือข่ายและการใช้ร่วมกัน) > Manage network connections (จัดการการเชื่อมต่อเครือข่าย)**
2. เลือก **Internet Protocol Version 4 (TCP/IPv4) (อินเทอร์เน็ตโพรโทคอลรุ่น 4 (TCP/IPv4))**, จากนั้นคลิก **Properties (คุณสมบัติ)**

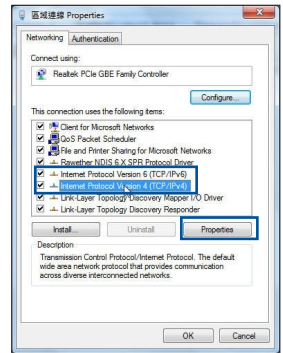

3. เพื่อรับการตั้งค่า IPv4 IP อัตโนมัติ, ทำเครื่องหมายที่ **Obtain an IP address automatically (รับ IP แอดเดรสโดยอัตโนมัติ)**
4. คลิก **OK (ตกลง)** เมื่อทำเสร็จ

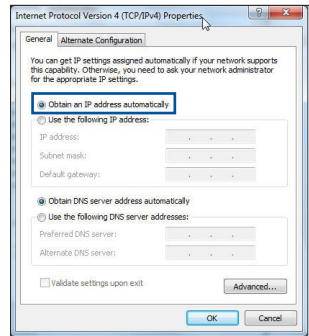

## MAC OS

1. คลิกไอคอนแอปเปิล  ที่อยู่บริเวณมุมซ้าย บนของหน้าจอ
2. คลิก **System Preferences (การกำหนดลักษณะระบบ) > Network (เครือข่าย) > Configure...** (กำหนดค่า...)
3. จากแท็บ **TCP/IP (TCP/IP)**, เลือก **Using DHCP (ใช้ DHCP)** ในรายการ **Configure IPv4 (กำหนดค่า IPv4)**
4. คลิก **Apply Now (นำไปใช้เดี๋ยวนี้)** เมื่อทำเสร็จ.

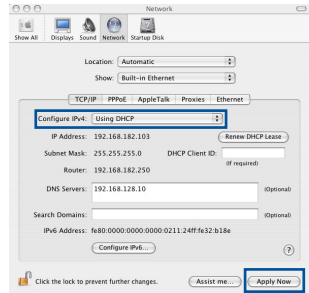

**หมายเหตุ:** คู่มือใช้ของระบบปฏิบัติการของคุณ และคุณสมบัตินี้สนับสนุน สำหรับรายละเอียดเกี่ยวกับการกำหนดค่า TCP/IP ของคอมพิวเตอร์ของคุณ

### C. ปิดทำงานการเชื่อมต่อแบบโทรเข้า ถ้าเปิดทำงานอยู่

#### Windows® 7

1. คลิก **Start (เริ่ม) > Internet Explorer (อินเทอร์เน็ต เอ็กซ์พลอเรอร์)** เพื่อเปิดเว็บเบราว์เซอร์
2. คลิก **Tools (เครื่องมือ) > Internet options (ตัวเลือกอินเทอร์เน็ต) > แท็บ Connections (การเชื่อมต่อ)**
3. ทำเครื่องหมายที่ **Never dial a connection (ไม่ตองเรียกเลขหมายเพื่อเชื่อมต่อ)**
4. คลิก **OK (ตกลง)** เมื่อทำเสร็จ

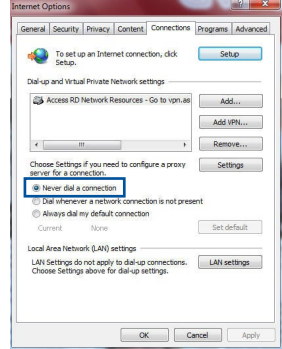

**หมายเหตุ:** คุณสมบัตินี้ใช้ของเบราว์เซอร์ของคุณ สำหรับรายละเอียดเกี่ยวกับการปิดทำงานการตั้งค่าการเชื่อมต่อแบบโทรเข้า

### D. ปิดเว็บเบราว์เซอร์ที่กำลังรันอยู่ทั้งหมด

#### ไคลเอนต์ไม่สามารถสร้างการเชื่อมต่อไร้สายกับเราเตอร์ได้

##### อยู่นอกพื้นที่ทำงาน:

- ย้ายเราเตอร์ให้เข้าใกล้ไวร์เลส ไคลเอนต์มากขึ้น
- ลองเปลี่ยนการตั้งค่าแชนเนล

##### การยืนยันตัวตนบุคคล:

- ใช้การเชื่อมต่อแบบมีสายเพื่อเชื่อมต่อไปยังเราเตอร์
- ตรวจสอบการตั้งค่าระบบป้องกันแบบไร้สาย
- กดปุ่ม รีเซ็ต ที่แผงด้านหลังเป็นเวลานานกว่า 5 วินาที

## ไม่สามารถพบเราเตอร์:

- กดยุ่ม รีเซ็ต ที่แผงด้านหลังเป็นเวลานานกว่า 5 วินาที
- ตรวจสอบการตั้งค่าในไวร์เลส อะแดปเตอร์ เช่น SSID และการตั้งค่าการเข้ารหัส

## ไม่สามารถเข้าถึงอินเทอร์เน็ตผ่านไวร์เลส LAN อะแดปเตอร์

- ย้ายเราเตอร์ให้เข้าใกล้ไวร์เลส ใกล้เคียงมากที่สุด
- ตรวจสอบว่าไวร์เลสอะแดปเตอร์เชื่อมต่อกับไวร์เลส เราเตอร์ที่ถูกต้องหรือไม่
- ตรวจสอบว่าไวร์เลส แชนเนลที่ใช้สอดคล้องกับแชนเนลที่ใช้ได้ในประเทศ / พื้นที่ของคุณหรือไม่
- ตรวจสอบการตั้งค่าการเข้ารหัส
- ตรวจสอบว่าการเชื่อมต่อ ADSL หรือสายเคเบิลถูกต้องหรือไม่
- ลองใช้สายเคเบิลอีเธอร์เน็ตเส้นอื่น

## ถ้าไฟ "LINK" ADSL กะพริบอย่างต่อเนื่อง หรือดับ, จะไม่สามารถเข้าถึงอินเทอร์เน็ต - เราเตอร์ไม่สามารถสร้างการเชื่อมต่อกับเน็ตเวิร์ก ADSL ได้

- ตรวจสอบให้แน่ใจว่าสายเคเบิลทั้งหมดเชื่อมต่ออย่างถูกต้อง
- ตัดการเชื่อมต่อสายไฟจาก ADSL หรือเคเบิลโมเด็มเดิม, รอสองสามนาที จากนั้นเชื่อมต่อสายใหม่
- ถ้าไฟ ADSL ยังคงกะพริบต่อเนื่อง หรือดับ, ให้ติดต่อผู้ให้บริการ ADSL ของคุณ

## ลิ้มซื้อเครือข่าย หรือคีย์ระบบป้องกัน

- ลื้องตั้งค่าการเชื่อมต่อแบบมีสาย และกำหนดค่าของการตั้งค่าการเข้ารหัสอีกครั้ง
- กดยุ่มรีเซ็ต เป็นเวลานานกว่า 5 นาที เพื่อรีเซ็ตหรือกู้คืนระบบกลับเป็นการตั้งค่าเริ่มต้นจากโรงงาน
- การตั้งค่าเริ่มต้นจากโรงงาน:

ชื่อผู้ใช้ / รหัสผ่าน: admin / admin	ที่อยู่ IP: <a href="http://www.asus.com">http://www.asus.com</a>	SSID: ตรวจสอบป้ายฉลาก การกำหนดต่อตราที่ด้านหลัง เราเตอร์ของคุณ
-----------------------------------------	----------------------------------------------------------------------	----------------------------------------------------------------

สามารถหาข้อมูลเพิ่มเติมเกี่ยวกับไวร์เลสเรเตอร์ได้จากที่ไหน?

- ไซต์ FAQ ออนไลน์: <http://support.asus.com/faq>
- ไซต์สนับสนุนด้านเทคนิค: <https://www.asus.com/support/>
- สายด่วนลูกค้า: ดูสายด่วนสนับสนุนใน คู่มือเสริม



## Hàng hóa đóng gói

- ☑ RT-AC66U B1
- ☑ Adapter AC (điện xoay chiều)
- ☑ RJ-45 Cáp mạng
- ☑ Hướng dẫn khởi động nhanh
- ☑ Thẻ bảo hành



**LƯU Ý:** Nếu có bất kỳ món hàng nào bị hỏng hay bị thiếu, hãy liên hệ với đại lý bán hàng.

## Xem nhanh

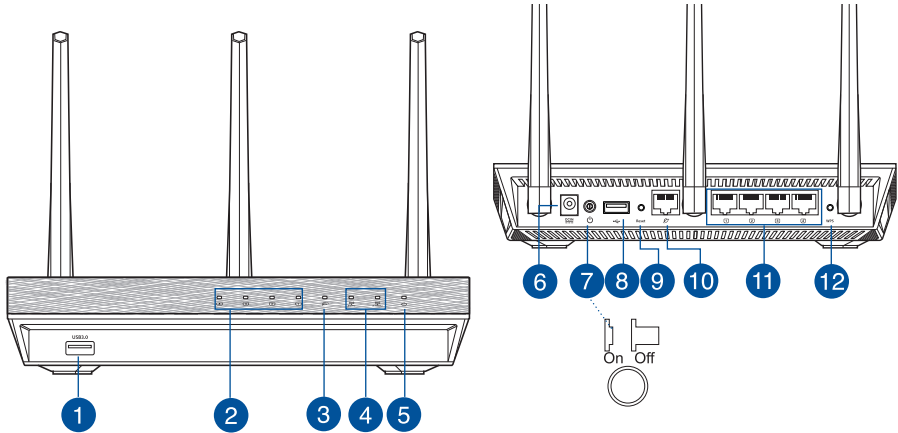

1) Cổng USB 3.0	5) Đèn LED nguồn	9) Nút khởi động lại
2) Đèn LED LAN	6) Cổng nguồn (DC-IN)	10) Cổng WAN
3) Đèn LED WAN	7) Nút nguồn	11) Cổng LAN
4) Đèn LED 2.4GHz/5GHz	8) Cổng USB 2.0	12) Nút WPS



---

## GHI CHÚ:

- **Ổ đĩa cứng ngoài/ổ đĩa flash USB:**
    - Router không dây hoạt động với hầu hết các loại ổ đĩa cứng/ổ đĩa flash USB với dung lượng lên đến 2TB và hỗ trợ truy cập đọc-ghi đối với định dạng FAT16, FAT32 và NTFS.
    - Để tháo an toàn ổ đĩa USB, hãy bật web GUI (<http://router.asus.com>), sau đó nhấp biểu tượng USB và **Eject USB 1** ở góc phải phía trên trang **Network Map (Bản đồ mạng)**.
    - Tháo ổ đĩa USB không đúng cách có thể làm hỏng dữ liệu.
    - Để có danh sách phân khu hệ thống và ổ đĩa cứng mà router không dây hỗ trợ, hãy truy cập <http://event.asus.com/networks/disksupport>.
    - Để có danh sách máy in mà router không dây hỗ trợ, hãy truy cập <http://event.asus.com/networks/printersupport>.
-

## Bố trí router không dây

Để truyền tín hiệu không dây tối ưu giữa router không dây và các thiết bị mạng vừa kết nối, đảm bảo bạn:

- Đặt router không dây ở khu vực trung tâm có phạm vi phủ sóng không dây tối đa dành cho các thiết bị mạng.
- Đặt thiết bị cách xa các vật cản kim loại và ánh sáng mặt trời trực tiếp.
- Đặt thiết bị cách xa các thiết bị Wi-Fi 802.11g hoặc 20MHz, thiết bị ngoại vi máy tính 2,4GHz, thiết bị Bluetooth, điện thoại di động, máy biến áp, động cơ công suất cao, ánh sáng huỳnh quang, lò vi sóng, tủ lạnh và các thiết bị công nghiệp khác để phòng tránh nhiễu hoặc mất tín hiệu.
- Để đảm bảo tín hiệu không dây tối ưu, hãy định hướng 3 ăngten có thể tháo rời như minh họa trong bảng vẽ dưới đây.
- Để đạt hiệu suất tối ưu, hãy điều chỉnh hệ thống làm mát bên trong. Tham khảo sổ hướng dẫn sử dụng để biết thêm chi tiết.
- Luôn cập nhật bằng firmware mới nhất. Truy cập trang web ASUS tại <http://www.asus.com> để tải các cập nhật firmware mới nhất.

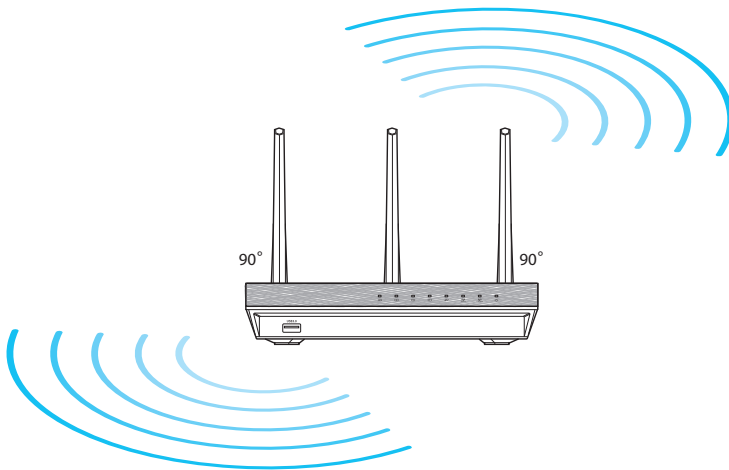

## Trước khi bạn tiến hành

1. Rút phích cắm và ngắt kết nối dây/cáp điện khỏi tiến trình thiết lập modem hiện tại của bạn và thoát địa chỉ IP hết hạn trên máy tính.

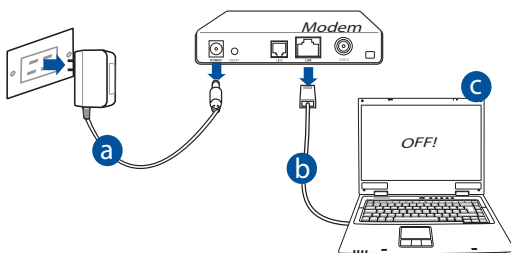

- a. Rút adapter AC ra khỏi ổ cắm điện và ngắt kết nối nó khỏi modem có dây/ADSL.
- b. Rút cáp mạng khỏi modem có dây/ADSL.
- c. Khởi động lại máy tính (khuyến dùng).



**CẢNH BÁO!** Trước khi ngắt kết nối dây điện/cáp, đảm bảo đã tắt modem có dây/ADSL ít nhất khoảng 2 phút. Nếu modem của bạn có dùng pin dự phòng thì hãy tháo ra.

## 2. Thiết lập môi trường không dây.

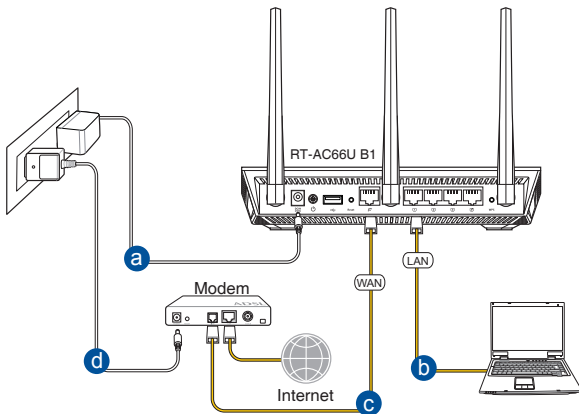

- a.** Cắm adapter AC của router không dây vào cổng DC-In rồi cắm nó vào ổ cắm điện.
- b:** Sử dụng cáp mạng kèm theo, kết nối máy tính với cổng LAN trên router không dây.



**QUAN TRỌNG!** Đảm bảo các đèn LED WAN và LAN đang nhấp nháy.

- c:** Sử dụng một cáp mạng khác, kết nối modem với cổng WAN trên router không dây.
- d:** Cắm adapter AC của modem vào cổng DC-IN rồi cắm nó vào ổ cắm điện.

## 3. Tắt một số cài đặt trên máy tính của bạn.

- a.** Tắt proxy server (máy chủ ủy nhiệm), nếu đã bật.
- b.** Thiết lập cài đặt TCP/IP để tự động nhận địa chỉ IP.
- c.** Tắt kết nối qua điện thoại, nếu đã bật.



**LƯU Ý:** Để biết thêm chi tiết về cách tắt máy tính của bạn, tham khảo *Các câu hỏi thường gặp (FAQs)*.

## Bắt đầu sử dụng

1. Thiết lập các cài đặt không dây qua giao diện người dùng đồ họa web (web GUI) trên router không dây.

a: Bật trình duyệt web như Internet Explorer, Firefox, Google Chrome hoặc Safari.



a

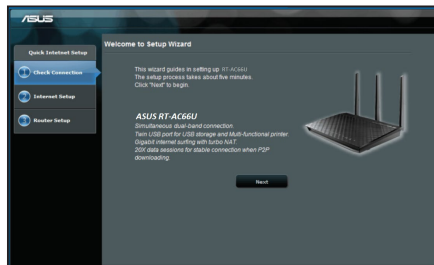

b



**LƯU Ý:** Nếu QIS không tự khởi động, hãy thực hiện theo các bước sau để bật QIS bằng thủ công:

- Trên trình duyệt web, nhập **<http://router.asus.com>** và chạy lại Quick Internet Setup (QIS) Wizard (Thuật sĩ thiết lập internet nhanh (QIS)).
- Tắt proxy settings (cài đặt proxy), dial-up connection (kết nối qua điện thoại), và thực hiện các cài đặt TCP/IP để tự động nhận địa chỉ IP. Để biết thêm chi tiết, tham khảo phần **FAQs (Câu hỏi thường gặp)** để chẩn đoán tự động.

**b:** Tính năng Thiết lập internet nhanh (QIS) của router không dây tự động dò tìm nếu loại kết nối ISP (nhà cung cấp dịch vụ internet) của bạn là **Dynamic IP (IP động)**, **PPPoE**, **PPTP**, **L2TP** và **Static IP (IP tĩnh)**. Nhập các thông tin cần thiết cho loại kết nối của bạn.



**LƯU Ý:** Khả năng tự phát hiện loại kết nối ISP sẽ xảy ra khi bạn định cấu hình router không dây lần đầu hoặc khi router không dây được thiết lập về cài đặt mặc định gốc.



**QUAN TRỌNG!** ! Hãy nhận các thông tin cần thiết về loại kết nối internet từ Nhà cung cấp dịch vụ internet (ISP) của bạn.

- c:** Gán tên mạng (SSID) và mã bảo mật cho kết nối không dây 2.4GHz và 5GHz của bạn. Nhấp **Apply (Áp dụng)** khi hoàn tất.
- d:** Cài đặt internet và không dây hiển thị. Nhấp **Next (Kế tiếp)** để tiếp tục.
- e:** Đọc hướng dẫn kết nối mạng không dây. Khi hoàn tất, nhấp **Finish (Hoàn tất)**.

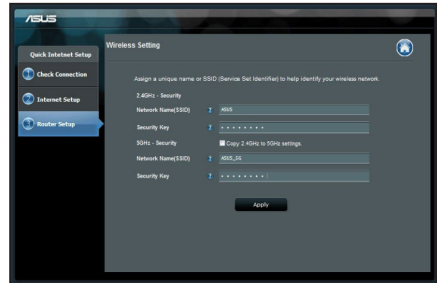

**LƯU Ý:** Bạn có thể gán tên mạng lên đến 32 ký tự.

## Các câu hỏi thường gặp (FAQs)

Sau khi thực hiện theo các bước, tôi vẫn không thể truy cập giao diện người dùng đồ họa web (web GUI) của router không dây để định cấu hình các cài đặt router không dây.

### A. Tắt máy chủ ủy nhiệm, nếu đã bật.

#### Windows® 7

1. Nhấp **Start (Bắt đầu)** > **Internet Explorer** để bật trình duyệt này.
2. Nhấp thẻ **Tools (Công cụ)** > **Internet options (Tùy chọn internet)** > **Connections (Kết nối)** > **LAN settings (Cài đặt LAN)**.

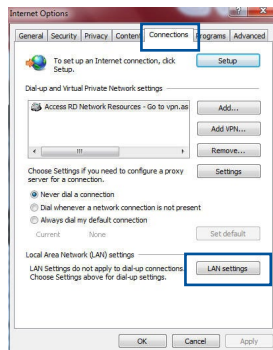

3. Từ màn hình Local Area Network (LAN) Settings (Cài đặt mạng cục bộ (LAN)), bỏ chọn **Use a proxy server for your LAN (Dùng máy chủ ủy nhiệm cho LAN)**.
4. Nhấp **OK** khi hoàn tất.

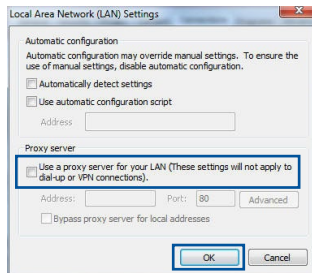



## HỆ THỨC MAC

1. Từ trình duyệt Safari, nhấn **Safari > Preferences (Ưu tiên) > Advanced (Nâng cao) > Change Settings (Thay đổi cài đặt)...**
2. Từ màn hình Network (Mạng), bỏ chọn **FTP Proxy** và **Web Proxy (HTTP)**.
3. Nhấn **Apply Now (Áp dụng ngay)** khi hoàn tất.

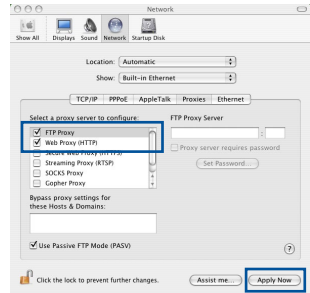

**LƯU Ý:** Tham khảo tính năng trợ giúp trên trình duyệt để biết chi tiết về cách tắt máy chủ ủy nhiệm.

## B. Thực hiện cài đặt TCP/IP để tự động nhận địa chỉ IP.

### Windows® 7

1. Nhấn **Start (Bắt đầu) > Control Panel (Bảng điều khiển) > Network and Internet (Mạng và internet) > Network and Sharing Center (Trung tâm mạng và chia sẻ) > Manage network connections (Quản lý các kết nối mạng)**.
2. Chọn **Internet Protocol Version 4 (TCP/IPv4)**, sau đó nhấn **Properties (Thuộc tính)**.

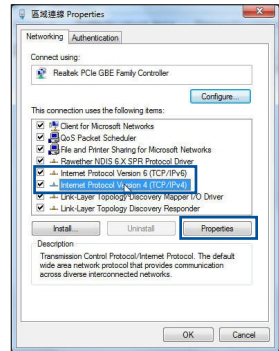

- Để nhận các cài đặt IP IPv4 tự động, chọn **Obtain an IP address automatically (Nhận địa chỉ IP tự động)**.
- Nhấp **OK** khi hoàn tất.

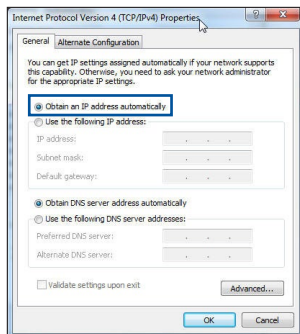

## HỆ THỨC MAC

- Nhấp biểu tượng Apple 🍏 nằm ở góc trái phía trên màn hình của bạn.
- Nhấp **System Preferences (Ưu tiên hệ thống) > Network (Mạng) > Configure (Định cấu hình)...**
- Từ thẻ **TCP/IP**, chọn **Using DHCP (Sử dụng DHCP)** trong danh sách sổ xuống **Configure IPv4 (Định cấu hình IPv4)**.
- Nhấp **Apply Now (Áp dụng ngay)** khi hoàn tất.

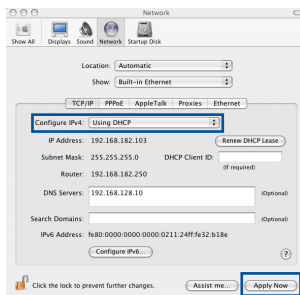

**LƯU Ý:** Tham khảo tính năng trợ giúp và hỗ trợ trên hệ điều hành để biết chi tiết về cách định cấu hình các cài đặt TCP/IP của máy tính.

## C. Tắt kết nối qua điện thoại, nếu đã bật.

### Windows® 7

1. Nhấp **Start (Bắt đầu)** > **Internet Explorer** để bắt trình duyệt này.
2. Nhấp thẻ **Tools (Công cụ)** > **Internet options (Tùy chọn internet)** > **Connections (Kết nối)**.
3. Đánh chọn **Never dial a connection (Không bao giờ quay số kết nối)**.
4. Nhấp **OK** khi hoàn tất.

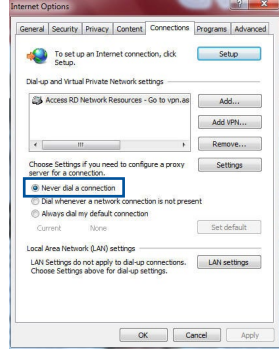

**LƯU Ý:** Tham khảo tính năng trợ giúp trên trình duyệt để biết chi tiết về cách tắt cài đặt kết nối mạng qua điện thoại.

## D. Đóng mọi trình duyệt web đang chạy.

### Thiết bị khách không thể thiết lập kết nối không dây với router.

#### Ngoài vùng phủ sóng:

- Đặt router gần hơn với thiết bị khách không dây.
- Thử đổi cài đặt kênh.

#### Xác nhận:

- Dùng kết nối có dây để kết nối với router.
- Kiểm tra cài đặt bảo mật không dây.
- Nhấn nút Reset (Cài lại) ở mặt sau khoảng hơn 5 giây.

**Không tìm thấy router:**

- Nhấn nút Reset (Cài lại) ở mặt sau khoảng hơn 5 giây.
- Kiểm tra cài đặt trong adapter không dây như cài đặt SSID và mã hóa.

**Không thể truy cập internet qua adapter LAN không dây.**

- Di chuyển router gần hơn với ứng dụng khách không dây.
- Kiểm tra xem adapter không dây đã được kết nối đúng với router không dây hay chưa.
- Kiểm tra xem kênh không dây đang sử dụng có phù hợp với các kênh có sẵn trong nước/khu vực của bạn hay không.
- Kiểm tra cài đặt mã hóa.
- Kiểm tra xem kết nối ADSL hoặc Cáp có đúng không.
- Thử dùng cáp ethernet khác.

**Nếu đèn “LINK” ADSL nhấp nháy liên tục hoặc vẫn tắt thì bạn không thể truy cập internet - Router không thể thiết lập kết nối với mạng ADSL.**

- Đảm bảo mọi loại cáp được kết nối thích hợp.
- Rút dây điện ra khỏi modem ADSL hoặc có dây, đợi vài phút rồi cắm lại dây điện.
- Nếu đèn ADSL tiếp tục nhấp nháy hoặc vẫn OFF (TẮT), hãy liên hệ với nhà cung cấp dịch vụ ADSL của bạn.

**Đã quên tên mạng hoặc các khóa mã hóa.**

- Thử thiết lập kết nối có dây và định lại cấu hình kiểu mã hóa không dây.
- Nhấn nút Reset (Cài lại) trên router không dây khoảng hơn 5 giây.
- Cài đặt mặc định gốc:

<b>Tên đăng nhập/mật khẩu:</b> admin/admin	<b>Địa chỉ IP:</b> http://router.asus.com	<b>SSID:</b> Kiểm tra nhãn thông số ở mặt sau router của bạn
--------------------------------------------	----------------------------------------------	-----------------------------------------------------------------

## Tôi có thể tìm thêm thông tin về router không dây ở đâu?

- Trang FAQ trực tuyến: <http://support.asus.com/faq>
- Trang Hỗ trợ kỹ thuật: <https://www.asus.com/support/>
- Đường dây nóng khách hàng: Tham khảo Đường dây nóng hỗ trợ trong Tài liệu hướng dẫn khởi động nhanh này

## ASUS Recycling/Takeback Services

ASUS recycling and takeback programs come from our commitment to the highest standards for protecting our environment. We believe in providing solutions for you to be able to responsibly recycle our products, batteries, other components, as well as the packaging materials. Please go to <http://csr.asus.com/english/Takeback.htm> for the detailed recycling information in different regions.

## REACH

Complying with the REACH (Registration, Evaluation, Authorisation, and Restriction of Chemicals) regulatory framework, we published the chemical substances in our products at ASUS REACH website at <http://csr.asus.com/english/REACH.htm>

## Federal Communications Commission Statement

This device complies with Part 15 of the FCC Rules. Operation is subject to the following two conditions:

- This device may not cause harmful interference.
- This device must accept any interference received, including interference that may cause undesired operation.

This equipment has been tested and found to comply with the limits for a class B digital device, pursuant to part 15 of the FCC Rules. These limits are designed to provide reasonable protection against harmful interference in a residential installation. This equipment generates, uses and can radiate radio frequency energy and, if not installed and used in accordance with the instructions, may cause harmful interference to radio communications. However, there is no guarantee that interference will not occur in a particular installation. If this equipment does cause harmful interference to radio or television reception, which can be determined by turning the equipment off and on, the user is encouraged to try to correct the interference by one or more of the following measures:

- Reorient or relocate the receiving antenna.
- Increase the separation between the equipment and receiver.
- Connect the equipment into an outlet on a circuit different from that to which the receiver is connected.
- Consult the dealer or an experienced radio/TV technician for help.



---

**WARNING!** Any changes or modifications not expressly approved by the party responsible for compliance could void the user's authority to operate the equipment.

---

## Prohibition of Co-location

This device and its antenna(s) must not be co-located or operating in conjunction with any other antenna or transmitter.

### IMPORTANT NOTE:

**Radiation Exposure Statement:** This equipment complies with FCC radiation exposure limits set forth for an uncontrolled environment. End users must follow the specific operating instructions for satisfying RF exposure compliance. To maintain compliance with FCC exposure compliance requirement, please follow operation instruction as documented in this manual.



---

**WARNING!** This equipment must be installed and operated in accordance with provided instructions and the antenna(s) used for this transmitter must be installed to provide a separation distance of at least 20 cm from all persons and must not be co-located or operating in conjunction with any other antenna or transmitter.

---

## Compliance Statement of Innovation, Science and Economic Development Canada (ISED)

This device complies with Innovation, Science and Economic Development Canada licence exempt RSS standard(s). Operation is subject to the following two conditions: (1) this device may not cause interference, and (2) this device must accept any interference, including interference that may cause undesired operation of the device.

Operation in the band 5150–5250 MHz is only for indoor use to reduce the potential for harmful interference to co-channel mobile satellite systems.

CAN ICES-3(B)/NMB-3(B)

## Radio Frequency (RF) Exposure Information

The radiated output power of the ASUS Wireless Device is below the Innovation, Science and Economic Development Canada radio frequency exposure limits. The ASUS Wireless Device should be used in such a manner such that the potential for human contact during normal operation is minimized.

This equipment should be installed and operated with a minimum distance of 20 cm between the radiator any part of your body.

This device has been certified for use in Canada. Status of the listing in the Innovation, Science and Economic Development Canada's REL (Radio Equipment List) can be found at the following web address:

[http://www.ic.gc.ca/eic/site/ceb-bhst.nsf/eng/h\\_tt00020.html](http://www.ic.gc.ca/eic/site/ceb-bhst.nsf/eng/h_tt00020.html)

Additional Canadian information on RF exposure also can be found at the following web:

<https://www.ic.gc.ca/eic/site/smt-gst.nsf/eng/sf08792.html>

## **Déclaration de conformité de Innovation, Sciences et Développement économique Canada (ISED)**

Le présent appareil est conforme aux CNR d'Innovation, Sciences et Développement économique Canada applicables aux appareils radio exempts de licence. L'exploitation est autorisée aux deux conditions suivantes : (1) l'appareil ne doit pas produire de brouillage, et (2) l'utilisateur de l'appareil doit accepter tout brouillage radioélectrique subi, même si le brouillage est susceptible d'en compromettre le fonctionnement.

La bande 5150 – 5250 MHz est réservée uniquement pour une utilisation à l'intérieur afin de réduire les risques de brouillage préjudiciable aux systèmes de satellites mobiles utilisant les mêmes canaux.

CAN ICES-3(B)/NMB-3(B)

### **Informations concernant l'exposition aux fréquences radio (RF)**

La puissance de sortie émise par cet appareil sans fil est inférieure à la limite d'exposition aux fréquences radio d'Innovation, Sciences et Développement économique du Canada (ISED). Utilisez l'appareil sans fil de façon à minimiser les contacts humains lors d'un fonctionnement normal.

Cet équipement doit être installé et utilisé avec un minimum de 20 cm de distance entre la source de rayonnement et votre corps.

L'utilisation de cet appareil est autorisée au Canada. Pour consulter l'entrée correspondant à l'appareil dans la liste d'équipement radio (REL - Radio Equipment List) d'Innovation, Sciences et Développement économique du Canada, rendez-vous sur :

[http://www.ic.gc.ca/eic/site/ceb-bhst.nsf/eng/h\\_tt00020.html](http://www.ic.gc.ca/eic/site/ceb-bhst.nsf/eng/h_tt00020.html)

Pour des informations supplémentaires concernant l'exposition aux fréquences radio au Canada, rendez-vous sur : <https://www.ic.gc.ca/eic/site/smt-gst.nsf/eng/sf08792.html>

### **India RoHS**

This product complies with the "India E-Waste (Management) Rules, 2016" and prohibits use of lead, mercury, hexavalent chromium, polybrominated biphenyls (PBBs) and polybrominated diphenyl ethers (PBDEs) in concentrations exceeding 0.1 % by weight in homogenous materials and 0.01 % by weight in homogenous materials for cadmium, except for the exemptions listed in Schedule II of the Rule.



## NCC 警語

經型式認證合格之低功率射頻電機，非經許可，公司、商號或使用者均不得擅自變更頻率、加大功率或變更原設計之特性及功能。

低功率射頻電機之使用不得影響飛航安全及干擾合法通信；經發現有干擾現象時，應立即停用，並改善至無干擾時方得繼續使用。

前項合法通信，指依電信法規定作業之無線電通信。

低功率射頻電機須忍受合法通信或工業、科學及醫療用電波輻射性電機設備之干擾。

「產品之限用物質含有情況」之相關資訊，請參考下表：

單元	限用物質及其化學符號					
	鉛 (Pb)	汞 (Hg)	鎘 (Cd)	六價鉻 (Cr <sup>6+</sup> )	多溴聯苯 (PBB)	多溴二苯醚 (PBDE)
印刷電路板及電子組件	-	○	○	○	○	○
結構組件（金屬 / 塑膠）	○	○	○	○	○	○
其他組件（如天線/ 指示燈/ 連接線）	○	○	○	○	○	○
其他及其配件（如電源供應器）	-	○	○	○	○	○

備考1. “○” 係指該項限用物質之百分比含量未超出百分比含量基準值。  
備考2. “-” 係指該項限用物質為排除項目。

## DFS 警語

操作在 5.15-5.35/5.47-5.85GHz 之無線資訊傳輸設備 (802.11a/ac 產品)，應避免影響附近雷達系統之操作。

## MPE

本產品電磁波曝露量 (MPE) 標準值  $1\text{mW}/\text{cm}^2$ ，送測產品實測值為  $\text{XX}\text{mW}/\text{cm}^2$ ，建議使用時至少距離人體  $\text{XX}\text{cm}$ 。

## 安全說明：

- 請在溫度為  $0^{\circ}\text{C}$  ( $32^{\circ}\text{F}$ ) 至  $40^{\circ}\text{C}$  ( $104^{\circ}\text{F}$ ) 之間的環境中使用本產品。
- 請依照產品上的電源功率貼紙說明使用正確的電源變壓器，如果使用錯誤規格的電源變壓器有可能會造成內部零件的損毀。
- 請勿將產品放置於不平坦或不穩定的表面，若產品的機殼毀損，請聯絡維修服務人員。
- 請勿在產品上放置其他物品，請勿將任何物品塞入產品內，以避免引起元件短路或電路損毀。
- 請保持機器在乾燥的環境下使用，雨水、溼氣、液體等含有礦物質將會腐蝕電子線路，請勿在雷電天氣下使用數據機。
- 請勿堵塞產品的通風孔，以避免因散熱不良而導致系統過熱。
- 請勿使用破損的電源線、附件或其他周邊產品。
- 如果電源已毀損，請不要嘗試自行修復，請將其交給專業技術服務人員或經銷商來處理。
- 為了防止電擊風險，在搬動主機之前，請先將電源線插頭暫時從電源插座上拔除。



电子电气产品有害物质限制使用标识要求：图中之数字为产品之环保使用期限。仅指电子电气产品中含有的有害物质不致发生外泄或突变从而对环境造成污染或对人体、财产造成严重损害的期限。

### 产品中有害物质的名称及含量

部件名称	有害物质					
	铅(Pb)	汞(Hg)	镉(Cd)	六价铬 (Cr(VI))	多溴联苯 (PBB)	多溴二苯醚 (PBDE)
印刷电路板及其电子组件	×	○	○	○	○	○
外壳	○	○	○	○	○	○
电源适配器	×	○	○	○	○	○
外部信号连接头及线材	×	○	○	○	○	○
中央处理器与内存	×	○	○	○	○	○

本表格依据 SJ/T 11364 的规定编制。  
○：表示该有害物质在该部件所有均质材料中的含量均在 GB/T 26572 规定的限量要求以下。  
×：表示该有害物质至少在该部件的某一均质材料中的含量超出 GB/T 26572 规定的限量要求，然该部件仍符合欧盟指令 2011/65/EU 的规范。  
备注：此产品所标示之环保使用期限，系指在一般正常使用状况下。

### 安全说明：

- 请在温度为 0° C (32° F) 至 40° C (104° F) 之间的环境中使用本产品。
- 请依照产品上的电源功率贴纸说明使用正确的电源适配器，如果试用错误规格的电源适配器可能会造成内部零件的损坏。
- 请勿将产品放置于不平坦或不稳定的表面，若产品的外壳损坏，请联系维修服务人员。
- 请勿在产品上放置其他物品，请勿将任何物品塞入产品内，以避免引起组件短路或电路损坏。
- 请保持机器在干燥的环境下使用，雨水、湿气、液体等含有矿物质会腐蚀电子线路，请勿在雷电天气下使用调制解调器。
- 请勿堵塞产品的通风孔，以避免因散热不良而导致系统过热。
- 请勿使用破损的电源线、附件或其他周边产品。
- 如果电源已损坏，请不要尝试自行修复，请将其交给专业技术服务人员或经销商来处理。
- 为了防止电击风险，在搬动主机前，请先将电源线插头暂时从电源插座上拔除。

## AEEE Yönetmeliğine Uygundur. IEEE Yönetmeliğine Uygundur.



- Bu Cihaz Türkiye analog şebekelerde çalışabilecek şekilde tasarlanmıştır.
- Cihazın ayrıntılı kurulum rehberi kutu içeriğinden çıkan CD içerisinde. Cihazın kullanıcı arayüzü Türkçe'dir.
- Cihazın kullanılması planlanan ülkelerde herhangi bir kısıtlaması yoktur. Ülkeler simgeler halinde kutu üzerinde belirtilmiştir.

<b>Manufacturer</b>	<b>ASUSTeK Computer Inc.</b> Tel: +886-2-2894-3447 Address: 4F, No. 150, LI-TE RD., PEITOU, TAIPEI 112, TAIWAN
<b>Authorised representative in Europe</b>	<b>ASUS Computer GmbH</b> Address: HARKORT STR. 21-23, 40880 RATINGEN, GERMANY
<b>Authorised distributors in Turkey</b>	<b>BOGAZICI BILGISAYAR TICARET VE SANAYI A.S.</b> <b>Tel./FAX No.:</b> +90 212 331 10 00 / +90 212 332 28 90 <b>Address:</b> ESENTEPE MAH. BUYUKDERE CAD. ERCAN HAN B BLOK NO.121 SISLI, ISTANBUL 34394
	<b>CIZGI Elektronik San. Tic. Ltd. Sti.</b> <b>Tel./FAX No.:</b> +90 212 356 70 70 / +90 212 356 70 69 <b>Address:</b> GURSEL MAH. AKMAN SK.47B 1 KAGITHANE/ISTANBUL
	<b>KOYUNCU ELEKTRONİK BİLGİ İŞLEM SİST. SAN. VE DİŞ TIC. A.S.</b> <b>Tel. No.:</b> +90 216 5288888 <b>Address:</b> EMEK MAH.ORDU CAD. NO:18, SARIGAZI, SANCAK-TEPE ISTANBUL
	<b>ENDEKS BİLİŞİM SAN VE DİŞ TIC LTD ŞTİ</b> <b>Tel./FAX No.:</b> +90 216 523 35 70 / +90 216 523 35 71 <b>Address:</b> NECİP FAZİL BULVARI, KEYAP CARSI SITESİ, G1 BLOK, NO:115 Y.DUDULLU, UMRANIYE, ISTANBUL
	<b>PENTA TEKNOLOJİ URUNLERİ DAGITIM TICARET A.S</b> <b>Tel./FAX No.:</b> +90 216 528 0000 <b>Address:</b> ORGANİZE SANAYİ BOLGESİ NATO YOLU 4.CADDE NO:1 UMRANIYE, ISTANBUL 34775

## Networks Global Hotline Information

Area	Country/ Region	Hotline Number	Service Hours	
Europe	Cyprus	800-92491	09:00-13:00 ; 14:00-18:00 Mon-Fri	
	France	0033-170949400	09:00-18:00 Mon-Fri	
	Germany	0049-1805010920		
		0049-1805010923 (component support)		09:00-18:00 Mon-Fri 10:00-17:00 Mon-Fri
		0049-2102959911 (Fax)		
	Hungary	0036-15054561	09:00-17:30 Mon-Fri	
	Italy	199-400089	09:00-13:00 ; 14:00-18:00 Mon-Fri	
	Greece	00800-44142044	09:00-13:00 ; 14:00-18:00 Mon-Fri	
	Austria	0043-820240513	09:00-18:00 Mon-Fri	
	Netherlands/ Luxembourg	0031-591570290	09:00-17:00 Mon-Fri	
	Belgium	0032-78150231	09:00-17:00 Mon-Fri	
	Norway	0047-2316-2682	09:00-18:00 Mon-Fri	
	Sweden	0046-858769407	09:00-18:00 Mon-Fri	
	Finland	00358-969379690	10:00-19:00 Mon-Fri	
	Denmark	0045-38322943	09:00-18:00 Mon-Fri	
	Poland	0048-225718040	08:30-17:30 Mon-Fri	
	Spain	0034-902889688	09:00-18:00 Mon-Fri	
	Portugal	00351-707500310	09:00-18:00 Mon-Fri	
	Slovak Republic	00421-232162621	08:00-17:00 Mon-Fri	
	Czech Republic	00420-596766888	08:00-17:00 Mon-Fri	
	Switzerland-German	0041-848111010	09:00-18:00 Mon-Fri	
	Switzerland-French	0041-848111014	09:00-18:00 Mon-Fri	
	Switzerland-Italian	0041-848111012	09:00-18:00 Mon-Fri	
United Kingdom	0044-1442265548	09:00-17:00 Mon-Fri		
Ireland	0035-31890719918	09:00-17:00 Mon-Fri		
Russia and CIS	008-800-100-ASUS	09:00-18:00 Mon-Fri		
Ukraine	0038-0445457727	09:00-18:00 Mon-Fri		

## Networks Global Hotline Information

Area	Country/ Region	Hotline Numbers	Service Hours
Asia-Pacific	Australia	1300-278788	09:00-18:00 Mon-Fri
	New Zealand	0800-278788	09:00-18:00 Mon-Fri
	Japan	0800-1232787  0081-570783886 ( Non-Toll Free )	09:00-18:00 Mon-Fri
			09:00-17:00 Sat-Sun  09:00-18:00 Mon-Fri 09:00-17:00 Sat-Sun
	Korea	0082-215666868	09:30-17:00 Mon-Fri
	Thailand	0066-24011717 1800-8525201	09:00-18:00 Mon-Fri
	Singapore	0065-64157917 0065-67203835 ( Repair Status Only )	11:00-19:00 Mon-Fri
			11:00-19:00 Mon-Fri 11:00-13:00 Sat
	Malaysia	1300-88-3495	9:00-18:00 Mon-Fri
	Philippine	1800-18550163	09:00-18:00 Mon-Fri
	India	1800-2090365	09:00-18:00 Mon-Sat
			09:00-21:00 Mon-Sun
	Indonesia	0062-2129495000 500128 (Local Only)	09:30-17:00 Mon-Fri
			9:30 – 12:00 Sat
Vietnam	1900-555581	08:00-12:00 13:30-17:30 Mon-Sat	
Hong Kong	00852-35824770	10:00-19:00 Mon-Sat	
Taiwan	0800-093-456; 02-81439000	9:00-12:00 Mon-Fri; 13:30-18:00 Mon-Fri	
Americas	USA		8:30-12:00 EST Mon-Fri
	Canada	1-812-282-2787	9:00-18:00 EST Sat-Sun
	Mexico	001-8008367847	08:00-20:00 CST Mon-Fri
			08:00-15:00 CST Sat
Brazil	4003 0988 (Capital) 0800 880 0988 (demais localidades)	9:00am-18:00 Mon-Fri	

## Networks Global Hotline Information

Area	Country/ Region	Hotline Numbers	Service Hours
<b>Middle East + Africa</b>	Egypt	800-2787349	09:00-18:00 Sun-Thu
	Saudi Arabia	800-1212787	09:00-18:00 Sat-Wed
	UAE	00971-42958941	09:00-18:00 Sun-Thu
	Turkey	0090-2165243000	09:00-18:00 Mon-Fri
	South Africa	0861-278772	08:00-17:00 Mon-Fri
	Israel	*6557/00972-39142800 *9770/00972-35598555	08:00-17:00 Sun-Thu 08:30-17:30 Sun-Thu
<b>Balkan Countries</b>	Romania	0040-213301786	09:00-18:30 Mon-Fri
	Bosnia Herzegovina	00387-33773163	09:00-17:00 Mon-Fri
	Bulgaria	00359-70014411	09:30-18:30 Mon-Fri
		00359-29889170	09:30-18:00 Mon-Fri
	Croatia	00385-16401111	09:00-17:00 Mon-Fri
	Montenegro	00382-20608251	09:00-17:00 Mon-Fri
	Serbia	00381-112070677	09:00-17:00 Mon-Fri
		00368-59045400 00368-59045401	08:00-16:00 Mon-Fri
<b>Baltic Countries</b>	Estonia	00372-6671796	09:00-18:00 Mon-Fri
	Latvia	00371-67408838	09:00-18:00 Mon-Fri
	Lithuania-Kaunas	00370-37329000	09:00-18:00 Mon-Fri
	Lithuania-Vilnius	00370-522101160	09:00-18:00 Mon-Fri



### NOTES:

- UK support e-mail: [network\\_support\\_uk@asus.com](mailto:network_support_uk@asus.com)
- For more information, visit the ASUS support site at: <https://www.asus.com/support/>



