

# 使用手冊

## RT-N16

多功能 Gigabit Wireless N 路由器

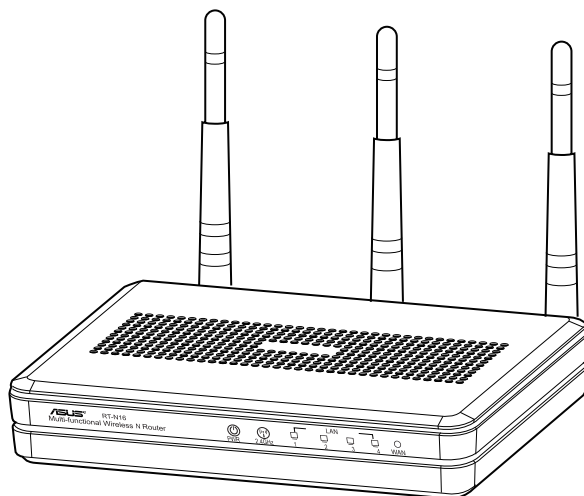

優雅美觀的灰白色 RT-N16 路由器擁有 2.4GHz 頻寬，配合高效能的處理器，它能夠支援 300,000 連線數供 P2P 下載；同時支援 USB 2.0 連接埠 - 可連接多合一印表機、伺服器並與 FTP 檔案分享；革命性的 Download Master 提供超高速便利的檔案下載功能。

**ASUS**<sup>®</sup>  
Inspiring Innovation • Persistent Perfection

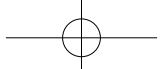

T7709

第 3 版

2012 年 9 月

#### 版權說明

©ASUSTeK Computer Inc. All rights reserved. 華碩電腦股份有限公司保留所有權利

本使用手冊包括但不限於其所包含的所有資訊皆受到著作權法之保護，未經華碩電腦股份有限公司（以下簡稱「華碩」）許可，不得任意地仿製、拷貝、謄抄、轉譯或為其他利用。

#### 免責聲明

本使用手冊是以「現況」及「以目前明示的條件下」的狀態提供給您。在法律允許的範圍內，華碩就本使用手冊，不提供任何明示或默示的擔保及保證，包括但不限於商業適銷性、特定目的之適用性、未侵害任何他人權利及任何得使用本使用手冊或無法使用本使用手冊的保證，且華碩對因使用本使用手冊而獲取的結果或透過本使用手冊所獲得任何資訊之準確性或可靠性不提供擔保。

台端應自行承擔使用本使用手冊的所有風險。台端明確了解並同意，華碩、華碩之授權人及其各該主管、董事、員工、代理人或關係企業皆無須為您因本使用手冊、或因使用本使用手冊、或因不可歸責於華碩的原因而無法使用本使用手冊或其任何部份而可能產生的衍生、附隨、直接、間接、特別、懲罰或任何其他損失（包括但不限於利益損失、業務中斷、資料遺失或其他金錢損失）負責，不論華碩是否被告知發生上開損失之可能性。

由於部份國家或地區可能不允許責任的全部免除或對前述損失的責任限制，所以前述限制或排除條款可能對您不適用。

台端知悉華碩有權隨時修改本使用手冊。本產品規格或驅動程式一經改變，本使用手冊將會隨之更新。本使用手冊更新的詳細說明請您造訪華碩的客戶服務網 <http://support.asus.com>，或是直接與華碩資訊產品技術支援專線 0800-093-456 聯絡。

於本使用手冊中提及之第三人產品名稱或內容，其所有權及智慧財產權皆為各別產品或內容所有人所有且受現行智慧財產權相關法令及國際條約之保護。

當下列兩種情況發生時，本產品將不再受到華碩之保固及服務：

- (1) 本產品曾經過非華碩授權之維修、規格更改、零件替換或其他未經過華碩授權的行為。
- (2) 本產品序號模糊不清或喪失。

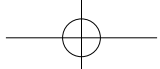

# 目錄內容

## 第一章：認識您的無線路由器

包裝內容物 .....	5
無線路由器概觀 .....	5
安裝路由器 .....	8

## 第二章：建立您的網路

放置您的路由器 .....	9
系統需求 .....	10
設定您的無線路由器 .....	11
有線連接 .....	11
無線連接 .....	12
開始設定之前 .....	13
A. 關閉代理伺服器 .....	13
B. 設定 TCP/IP 自動取得 IP 位址 .....	15
C. 關閉撥號連線 .....	16

## 第三章：使用網頁圖形介面進行設定

登入網頁圖形介面 .....	17
設定網路連接 .....	18
網路設定精靈 (QIS) (含自動偵測功能) .....	18
無線網路安全設定 .....	22
管理您的網路用戶端 .....	23
監控您的 USB 裝置 .....	24
建立您的客戶網路 .....	26
使用流量管理 (Traffic Manager) .....	27
使用服務質量 (QoS) 管理頻寬 .....	27
監控流量 .....	28
使用 USB 擴充 .....	28
使用 AiDisk 分享檔案 .....	29
使用 UPnP 媒體伺服器 .....	32
使用網路芳鄰共享 (Samba) 服務 .....	33
建立 FTP 檔案分享區 .....	34
使用其它設定 .....	36

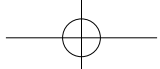

## 目錄內容

進階設定 .....	37
設定 DHCP 伺服器.....	37
韌體更新 .....	39
還原 / 匯出 / 上傳設定 .....	40
網路印表機設定 .....	41
<b>第四章：使用華碩應用程式</b>	
偵測裝置 (Device Discovery) .....	44
韌體回復 (Firmware Restoration) .....	45
<b>第五章：疑難排解</b>	
疑難排解 .....	47
華碩 DDNS 服務.....	50
常見問題解答 (FAQs) .....	50
<b>附錄</b>	
Notices.....	52
華碩的連絡資訊 .....	65
全球網路熱線資訊 .....	66

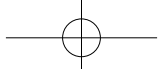

# 第一章：認識您的無線路由器

## 包裝內容物

請檢查以下配件是否齊全：

- RT-N16 無線路由器
- 電源變壓器
- 驅動程式與應用程式光碟（使用手冊、應用程式）
- 保固卡
- RJ45 網路線
- 快速使用指南



注意：

- 若以上列出的任何一項配件有損壞或是短缺的情形，請儘速聯絡華碩技術支援。您可以參考使用手冊後部的華碩技術支援熱線。
- 請保留原來的包裝以便將來維修或更換等保固所需。

## 無線路由器概觀

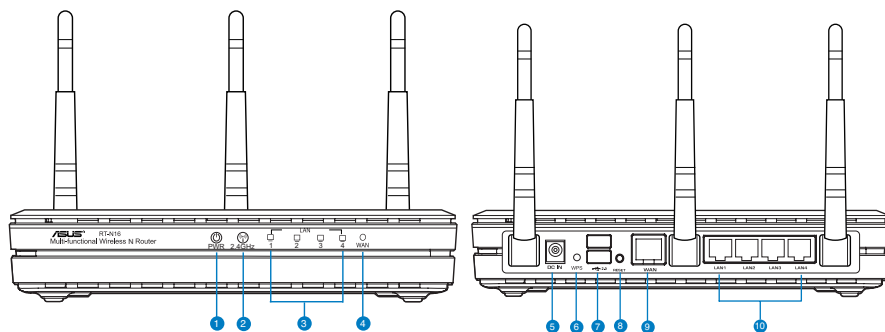

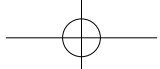

---

## 1 電源指示燈

熄滅：無電源。

燈亮：裝置就緒。

緩慢閃爍：救援模式。

快速閃爍：WPS 執行中。

---

## 2 2.4GHz 指示燈

熄滅：無 2.4GHz 訊號。

燈亮：無線系統就緒。

閃爍：透過無線連接傳送或接收資料。

---

## 3 LAN 指示燈

熄滅：無電源或無實體連接。

燈亮：有實體連接至區域網路 (LAN)。

閃爍：透過乙太網路線傳送或接收資料。

---

## 4 WAN 指示燈

熄滅：無電源或無實體連接。

燈亮：有實體連接至廣域網路 (WAN)。

閃爍：透過乙太網路線傳送或接收資料。

---

## 5 電源 (DC-In) 連接埠

插入附贈的 AC 變壓器並將您的路由器連接至電源。

---

## 6 WPS 按鈕

此按鈕可啟動 WPS 設定精靈。

---

## 7 USB 2.0 連接埠

將 USB 2.0 裝置，如 USB 硬碟或 USB 隨身碟插入此連接埠。

---

## 8 重置按鈕

此按鈕重置或回復系統至其初始設定。

---

## 9 WAN (網際網路) 連接埠

插入網路線建立廣域網路連線。

閃爍：透過有線連接傳送或接收資料。

---

## 10 LAN 1 - 4 網路連接埠

插入網路線建立網路連線。

---

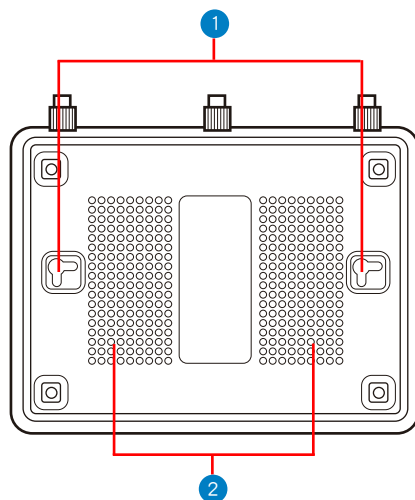
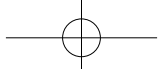

項目	描述
1	<b>安裝掛鉤</b> 用兩顆圓頭螺絲可將路由器安裝於混凝土或木質平面上。
2	<b>通風孔</b> 這些通風孔用於路由器的通風散熱。



**注意：**關於如何將您的無線路由器安裝在牆上或混凝土上，請參考本手冊下一頁“安裝路由器”。

為避免三根天線間的訊號干擾，建議您將天線調整為下圖所示的方向。

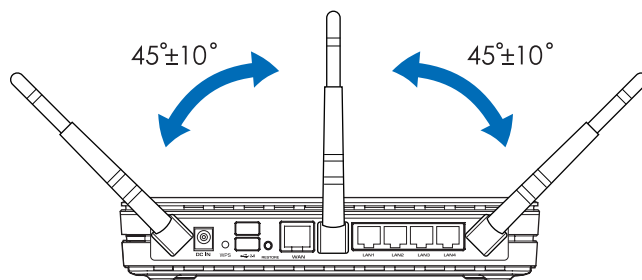

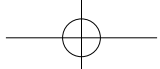

## 安裝路由器

華碩無線路由器可安裝在高處的平面上，如衣櫥或書架上，也可以固定於牆上或天花板。

請依照以下步驟安裝華碩無線路由器：

1. 找到路由器底部的兩個安裝掛鉤。
2. 在平面上標注兩個孔位。
3. 將兩顆螺絲擰緊直到只露出 1/4”。
4. 將無線路由器掛到牆上的螺絲上。

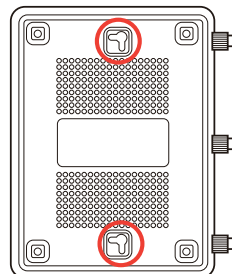

注意：

- 若螺絲太鬆或無法將華碩路由器掛到螺絲上，請調整螺絲位置。
- 僅使用包裝物中的變壓器。使用其它變壓器可能會對您的裝置造成損壞。
- 規格：

DC 電源變壓器	DC 輸出：+12V 電壓，支援最大 1.25A 電流		
運作溫度	0-40°C	存儲溫度	0-70°C
運作濕度	50-90%	存儲溫度	20-90%



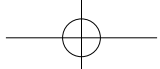

## 第二章：建立您的網路

### 放置您的路由器

為獲取無線路由器與所連接的網路裝置之間的最佳無線傳送訊號，請確認以下幾點：

- 建議將路由器放置在中心區域，以覆蓋所有無線行動裝置。
- 請勿將裝置放在靠近金屬物品與陽光直射的地方。
- 請遠離其它 802.11g 或 20MHz 的 Wi-Fi 裝置、2.4GHz 電腦周邊裝置、藍芽裝置、無線室內電話、傳送器、重型發動機、日光燈、微波爐、電冰箱與其他工業裝置，以防止訊號干擾或丟失。
- 請垂直放置無線路由器以獲取最佳前後訊號覆蓋。
- 請平躺放置無線路由器以獲取最佳上下訊號覆蓋。
- 請經常更新至最新版本韌體。您可以登入華碩官網 <http://tw.asus.com> 獲取最新韌體。

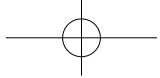

## 系統需求

設定您的網路之前，您需要一台或二台電腦符合以下系統需求：

- 一個乙太網路 RJ-45 (LAN) 連接埠 (10Base-T / 100Base-TX / 1000BaseTX)
- 支援 IEEE 802.11a/b/g/n 無線功能
- 已安裝 TCP/IP 服務
- 網路瀏覽器，如 Internet Explorer、Firefox、Safari 或 Google Chrome



注意：

- 若您的電腦沒有內建無線功能，您可以在您的電腦上安裝一個 IEEE 802.11a/b/g/n 無線網路卡來連線網路。
- 用來連接網路裝置的 RJ-45 乙太網路線長度不可超過 100 公尺。

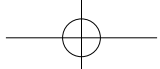

## 設定您的無線路由器



### 重要！

- 請使用有線連接設定您的無線路由器，避免無線訊號不穩定可能造成的設定問題。
- 在設定您的華碩無線路由器之前，請按照以下執行：
  - 若您想要替換一個現有的路由器，請將其從網路中斷開。
  - 拔掉現有數據機設定中的纜線。若現有的數據機有備用電池，也請移除之。
  - 重新啟動您的電腦（建議）。

## 有線連接



注意：華碩無線路由器本身具備自動偵測跳線（auto-crossover）功能，因此您可以使用已跳線或未跳線的網路線來連接路由器。

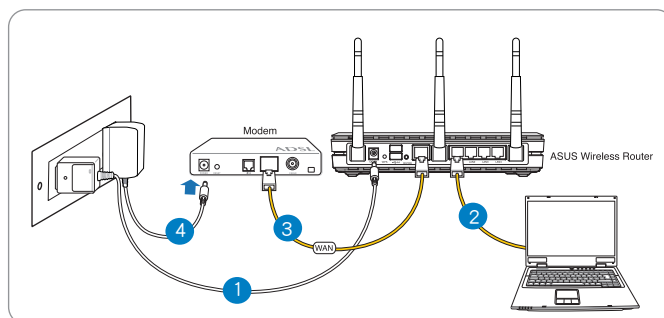

請依照以下步驟設定有線連接：

1. 將無線路由器的 AC 變壓器插入 DC-in 電源輸入埠並插上電源。
2. 使用附贈的網路線將您的電腦連接至您的無線路由器的 LAN 連接埠。



重要！請確認 LAN 指示燈在閃爍。

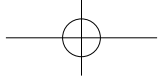

- 3 用另一條網路線將您的數據機連接至無線路由器的 WAN 連接埠。
- 4 將數據機的 AC 變壓器插入 DC-in 輸入埠並插上電源。

## 無線連接

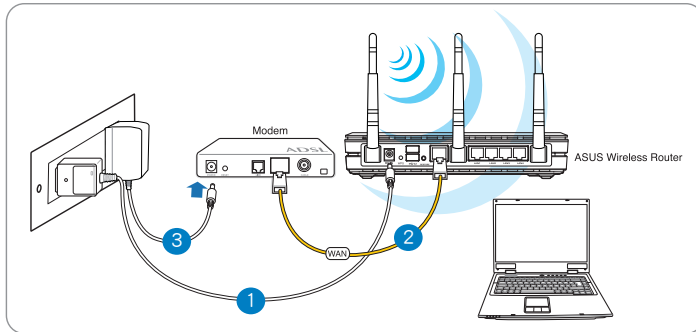

請依照以下步驟設定無線連接：

- 1 將無線路由器的 AC 變壓器插入 DC-in 電源輸入埠並插上電源。
- 2 用附贈的網路線將您的數據機連接至無線路由器的 WAN 連接埠。
- 3 將數據機的 AC 變壓器插入 DC-in 電源輸入埠並插上電源。
- 4 在您的電腦上安裝一張 IEEE 802.11a/b/g/n 標準的無線網路卡。



注意：

- 更多無線連接相關資訊請參考無線網路卡的使用手冊。
- 為你的網路進行安全設定，請參考「無線網路安全設定」部份的說明。

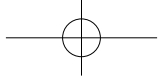

## 開始設定之前



注意：在您開始設定無線路由器之前，請按照本章節的步驟設定您的主機與網路用戶端。

### A. 關閉代理伺服器

#### Windows® 7

1. 點選 **開始** > **Internet Explorer** 開啟瀏覽器。
2. 點選 **工具** > **網際網路選項** > **連線** 標籤 > **區域網路設定**。

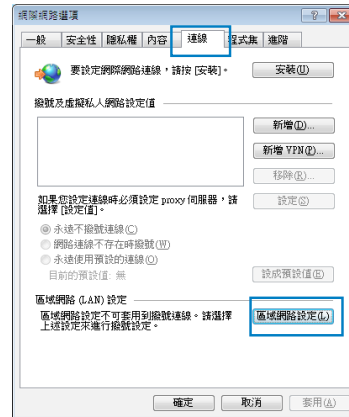

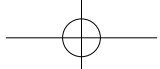

3. 在區域網路 (LAN) 設定畫面中取消勾選 **在您的區域網路使用 proxy 伺服器**。
4. 完成後點選 **確定**。

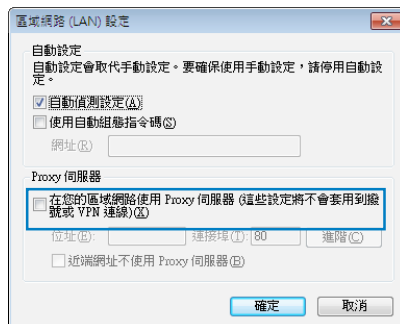

## MAC OS

1. 在您的 Safari 瀏覽器中點選 **Safari > Preferences > 進階 > 更改設定...**
2. 在網路畫面中取消勾選 **FTP 代理伺服器** 與 **網頁代理伺服器 (HTTP)**。
3. 完成後點選 **立即套用**。

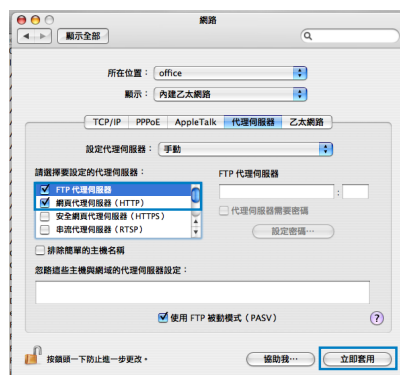

注意：請參考瀏覽器中的幫助選單進行代理伺服器的關閉設定。

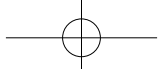

## B. 設定 TCP/IP 自動取得 IP 位址

### Windows® 7

1. 點選 **開始** > **控制台** > **網路與網際網路** > **網路和共用中心** > **管理網路連線**。
2. 點選 **網際網路通訊協定第 4 版 (TCP/IPv4)** 或 **網際網路通訊協定第 6 版(TCP/IPv6)**，然後點選 **內容**。

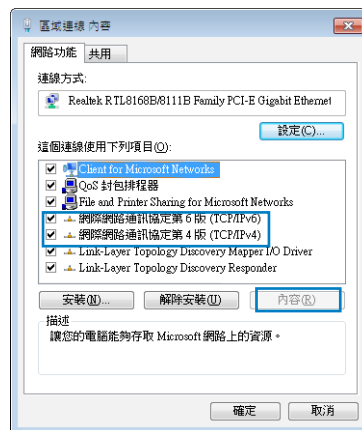

3. 欲自動獲取 IPv4 IP 設定，勾選 **自動取得 IP 位址**。  
欲自動獲取 IPv6 IP 設定，勾選 **自動取得 IPv6 位址**。
4. 完成後點選 **確定**。

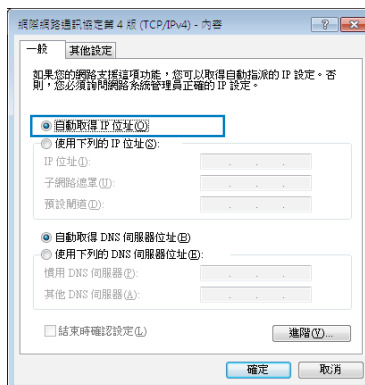

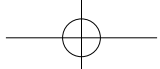

## MAC OS

1. 點選左上角的蘋果圖示 。
2. 點選 System Preferences > 網路 > 設定...
3. 點選 TCP/IP 標籤，在 設定 IPv4 下拉式選單中選擇 使用 DHCP。
4. 完成後點選 立即套用。

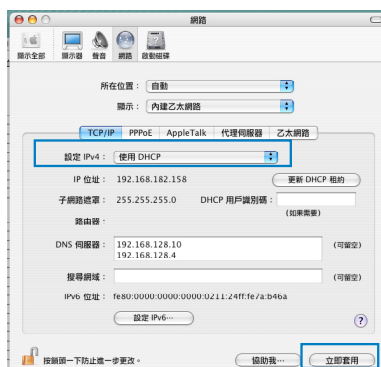

注意：請參考您的作業系統中幫助與支援功能，獲取更多設定 TCP/IP 相關資訊。

## C. 關閉撥號連線

### Windows® 7

1. 點選 開始 > Internet Explorer 開啟瀏覽器。
2. 點選 工具 > 網際網路選項 > 連線標籤。
3. 勾選 永遠不撥號連線。
4. 完成後點選 確定。

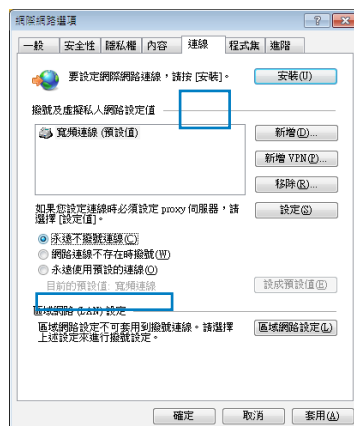

注意：請參考瀏覽器的幫助選單進行關閉撥號連接。



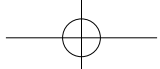

## 第三章：使用網頁圖形介面進行設定

### 登入網頁圖形介面

您的華碩路由器配備一個智慧型網頁圖形使用介面（GUI），允許您透過網頁瀏覽器，如 Internet Explorer、Firefox、Safari 或 Google Chrome，便捷設定其各種功能。

請依照以下步驟登入網頁圖形介面：

1. 在您的網頁瀏覽器上手動輸入無線路由器預設 IP 位址：192.168.1.1，如 Internet Explorer、Firefox、Safari 或 Google Chrome。
2. 在登入頁面中，輸入預設使用者名稱（admin）與密碼（admin）。

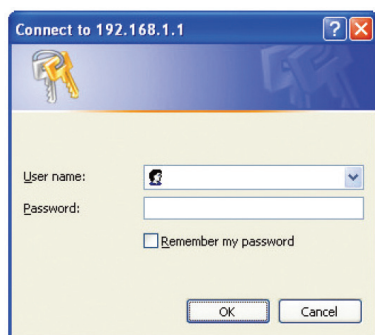

#### 注意：

- 為使用您的網路用戶端，請確認您已設定 TCP/IP 自動取得 IP 位址、關閉代理伺服器、關閉撥號設定並已取消撥號連線。
- 更多資訊請參考「開始設定之前」章節的內容。

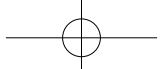

3. 開啟無線路由器的網頁圖形介面，並進行各種無線設定。



## 設定網路連接



注意：第一次設定網路連接時，請按下路由器上的重置按鈕將其還原為初始設定。

## 網路設定精靈 (QIS) (含自動偵測功能)

網路設定精靈 (QIS) 功能引導您快速設定您的網路連線。

請依照以下步驟使用擁有自動偵測功能的網路設定精靈：

1. 開啟一個網路瀏覽器，如 Internet Explorer、Firefox、Safari 或 Google Chrome。

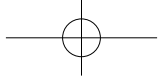

2. 此路由器可自動偵測 5 種 ISP 連線類型：自動取得 IP、PPPoE、固定 IP、PPTP 與 L2TP。為您的 ISP 連線類型輸入所需資訊。

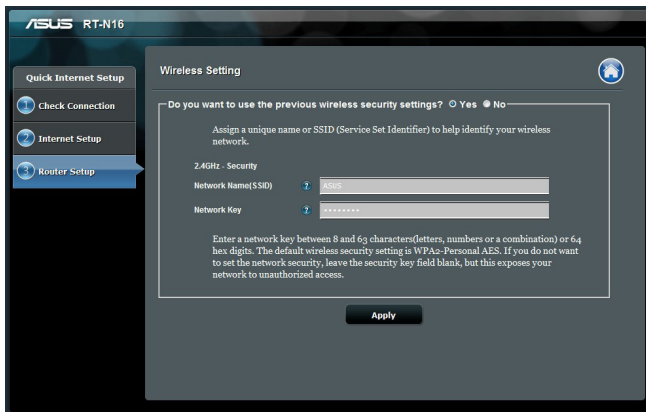

重要！請從您的 ISP 獲取網路連接類型的相關資訊。

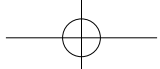

**注意：**

- 當您第一次設定無線路由器或當您的無線路由器重置為預設設定時，路由器才會自動偵測您的 ISP 連線類型。
- 若網路設定精靈 (QIS) 未能偵測您的網路連線類型，點選 **略過並手動設定**，手動設定您的連線類型。
- 若網路設定精靈 (QIS) 未能自動啟動，請手動登入網路圖形介面以開啟網路設定精靈頁面。請依照以下步驟執行：
  - 在您的網路瀏覽器中輸入 <http://192.168.1.1>。
  - 在登入介面輸入預設的使用者名稱 **admin** 與密碼 **admin**。
  - 在 **網路地圖** 頁面中選擇 **網路狀態**，在 **網路設定精靈** 下點選 **前往設定**。

3. 為您的 2.4GHz 無線連線分配網路名稱 (SSID) 與金鑰。點選 **套用本頁面設定** 後完成。

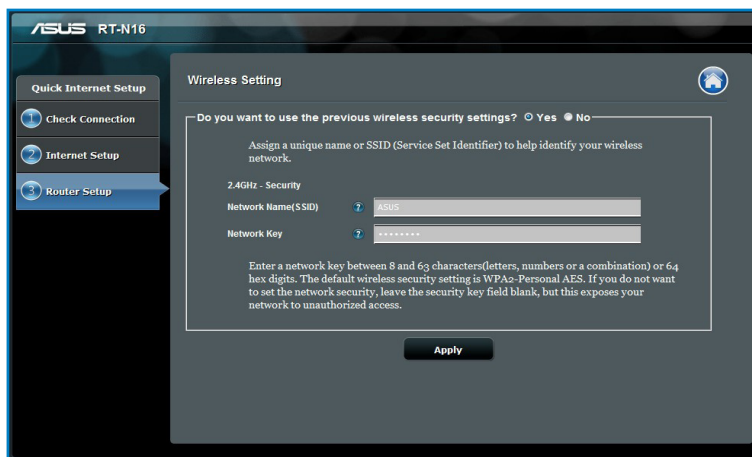

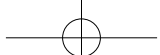

4. 螢幕上顯示網路與無線設定。點選 **下一步** 繼續。

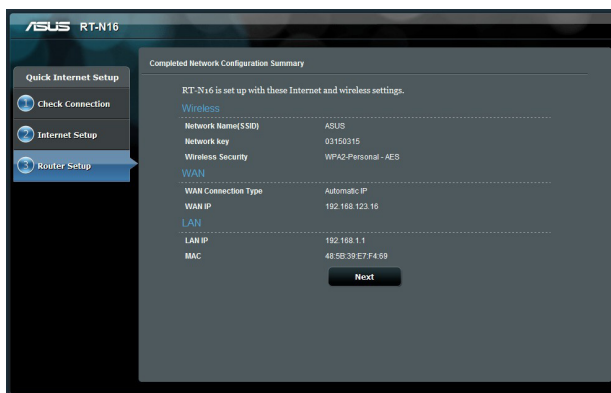

5. 瀏覽無線網路連接教程。完成後點選 **完成**。

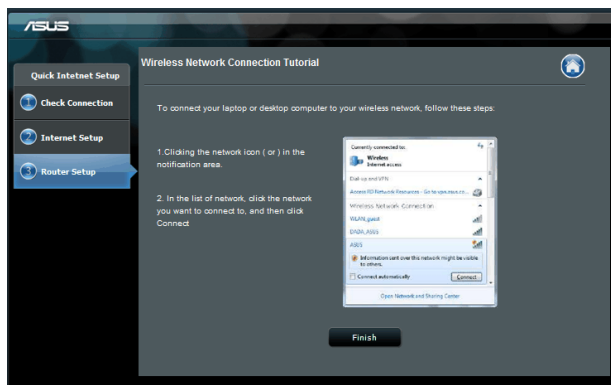

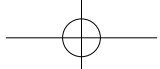

## 無線網路安全設定

為了保護您的無線網路以免非授權使用者侵入，您需要進行無線網路安全設定。

請依照以下步驟進行無線網路安全設定：

1. 在您的網頁瀏覽器中輸入 192.168.1.1。
2. 在登入頁面中，輸入預設使用者名稱 (admin) 與密碼 (admin)，然後點選 **確定**。無線路由器的網頁圖形介面開啟。
3. 在 **網路地圖** 畫面中，選擇 **系統狀態** 圖示以顯示無線安全設定，如 SSID、安全級別與加密設定。
4. 在 **無線名稱** (SSID) 畫面中，為您的無線網路輸入一個獨有的名稱。
5. 在 **安全級別** 下拉式選單中，為您的無線網路選擇加密模式。



**重要！** IEEE 802.11n 標準禁止使用帶有 WEP 或 WPA-TKP 的高通量作為單播密碼。若您使用這些加密方式，您的資料傳送率將會下降至 IEEE 802.11g 的 54Mbps。

6. 輸入您的安全金鑰。
7. 完成後點選 **套用**。

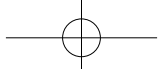

## 管理您的網路用戶端

請依照以下步驟管理您的網路用戶端：

1. 開啟無線路由器的網頁圖形介面。
2. 在 **網路地圖** 畫面中，選擇 **用戶端狀態** 圖示以顯示您的網路用戶端的相關資訊。



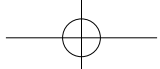

## 監控您的 USB 裝置

華碩無線路由器提供二個 USB 3.0 連接埠，用於連接 USB 裝置，如 USB 儲存裝置或 USB 印表機，您可與網路內的用戶端一起監控工作環境、分享檔案與印表機。



**注意：**要使用這一功能，您需要在無線路由器後面板的 USB2.0 連接埠上插入一個 USB 儲存裝置，如 USB 硬碟或 USB 隨身碟。請確認 USB 儲存裝置被格式化並適當分割磁區。請造訪華碩網站 <http://event.asus.com/networks/disksupport> 獲取硬碟檔案支援清單。



**重要！**首先您需要建立一個使用者帳戶，以允許其他網路用戶端獲取所連接的 USB 裝置。更多資訊請參考「分享 USB 儲存裝置中的檔案」章節的說明。

請依照以下步驟監控您的 USB 裝置：

1. 開啟無線路由器的網頁圖形介面。
2. 在 **網路地圖** 畫面中，選擇 **外接 USB 磁碟狀態** 圖示以顯示您的 USB 裝置相關資訊。





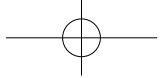

3. 在 **AiDisk 精靈** 欄位中，點選 **前往設定** 以設定一個 FTP 伺服器進行網路檔案分享。



注意：

- 更多相關資訊請參閱「使用 AiDisk 設定一個 FTP 伺服器與網路芳鄰」章節的說明。
- 在 **USB 外接硬碟 / 隨身碟** 上：
  - 無線路由器可支援大多數 USB 硬碟/隨身碟（最大 2TB），並支援 FAT16、FAT32、EXT2、EXT3 與 NTFS 的存取。
  - 為安全移除 USB 隨身碟，登入網頁圖形介面（<http://192.168.1.1>），點選 **網路地圖 > 外接 USB 磁碟狀態 > 安全地移除磁碟**，然後點選 **移除**。
  - 錯誤移除 USB 隨身碟可能造成資料遺失。



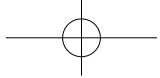

## 建立您的客戶網路

客戶網路為臨時訪客提供網路連接，無需連接至您的私人網路。

請按照以下步驟建立您的客戶網路：

1. 打開無線路由器的網頁圖形使用介面。
2. 在 **客戶網路** 畫面中，點選 **建立** 建立一個可供訪客使用的網路。

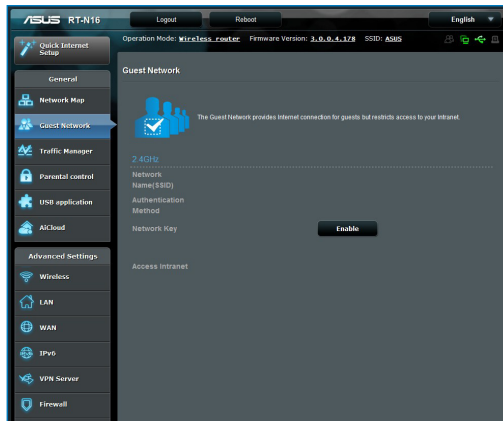

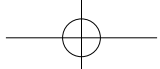

## 使用流量管理（Traffic Manager） 使用服務質量（QoS）管理頻寬

服務質量（QoS）允許您設定頻寬優先權並管理網路流量。

請按照以下步驟設定頻寬優先權：

1. 打開無線路由器的網頁圖形使用介面。
2. 在 流量管理 畫面中選擇 QoS 欄。
3. 點選 ON 開啟預設規則，並填寫上傳與下載頻寬欄中的內容。



注意：

- 從您的網際網路服務提供商（ISP）獲取頻寬資訊。
- 若您想要優先特定的網路程式與網路裝置，請從使用者自訂 QoS 規則中選擇您想要的優先權。

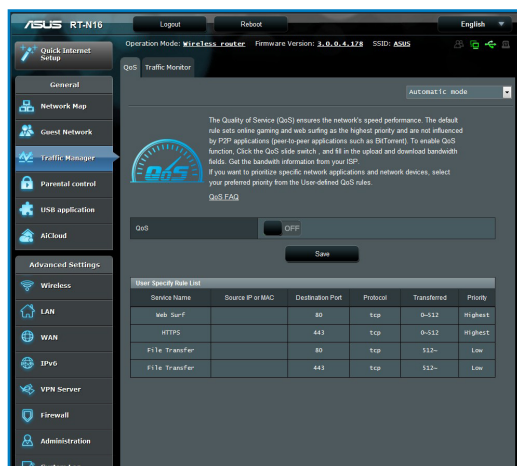

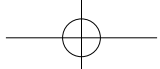

## 監控流量

監控流量功能允許您獲取頻寬用法與您的網路、LAN、有線、WLAN 連線的速度。

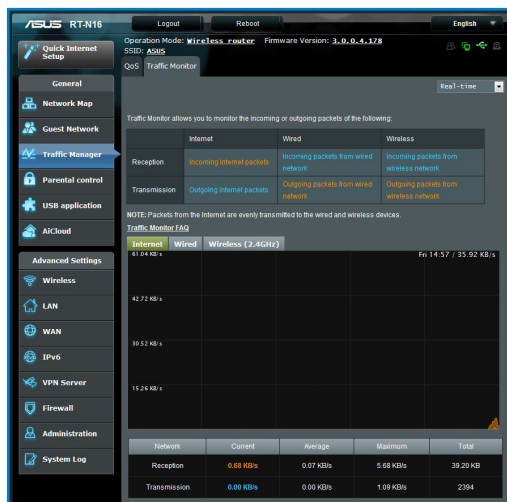

## 使用 USB 擴充

USB 擴充功能可提供 AiDisk、伺服器中心、網路印表機伺服器與 Download Master 子選單。

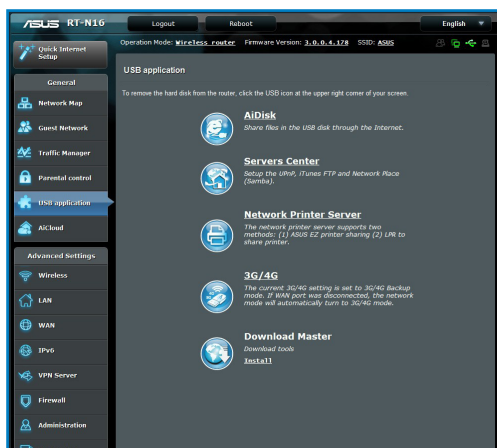

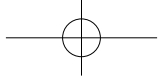

## 使用 AiDisk 分享檔案

AiDisk 允許您透過網際網路在 USB 隨身碟中分享檔案。



在使用 AiDisk 前，請確認您已將一個 USB 隨身碟插入您的無線路由器的 USB 連接埠中。

請按照以下步驟使用 AiDisk：

1. 點選 USB Extension 中的 AiDisk 圖示。
2. 在 歡迎使用 AiDisk 精靈 中點選 前往設定。

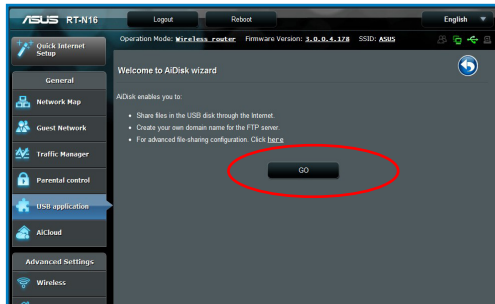

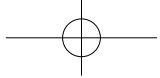

3. 為網路中的用戶端選擇存取權限。

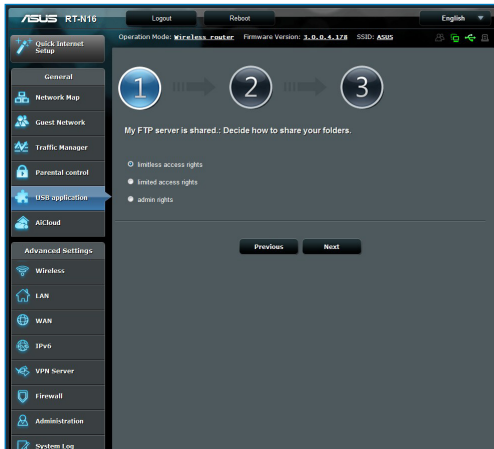

4. 若您想要透過華碩 DDNS 建立自己的 FTP 網域名稱，選擇 **我願意使用此服務**，並同意使用條款，然後輸入您的網域名稱。完成後點選 **下一步**。

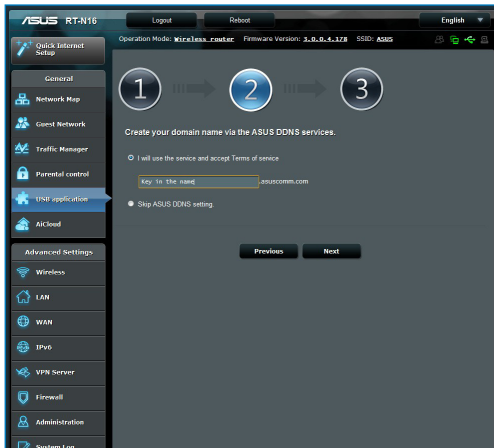

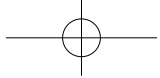

5. 完成後，點選 **保存**。

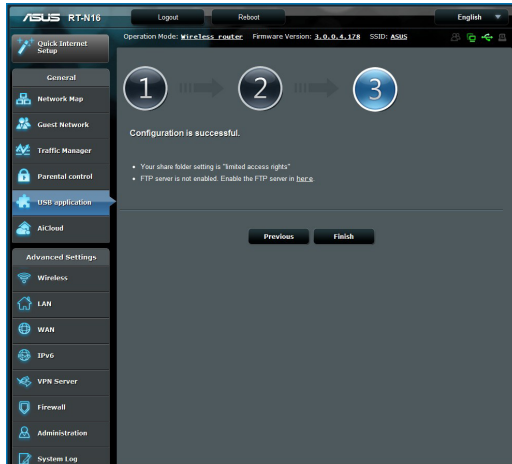

6. 欲存取您建立的 FTP，開啟一個網路瀏覽器或一個第三方 FTP 用戶端應用程式，並輸入 FTP 鏈接（ftp://<網域名稱>）。

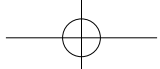

## 使用 UPnP 媒體伺服器

您的無線路由器允許 UPnP 媒體裝置，如 PS3 與 XBox 360，從連接至路由器的 USB 隨身碟中獲取多媒體檔案。



在使用 UPnP 媒體伺服器功能前，請先在您的 UPnP 裝置上安裝一個無線網路卡。

請按照以下步驟將您的路由器作為一個伺服器中心：

1. 在導航選單中點選 **USB Extention**。
2. 選擇 **UPnP 媒體伺服器**。您的無線路由器即可從 USB 隨身碟中分享多媒體檔案。





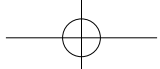

## 使用網路芳鄰共享 (Samba) 服務

網路芳鄰共享 (Samba) 允許您為 Samba 服務設定帳號與許可權。

請按照以下步驟使用 Samba 共享：

1. 點選 UPnP 媒體伺服器 的 網路芳鄰共享 (Samba) 按鈕。
2. 點選 **新增**、**移除** 或 **修改** 以新增、移除或修改帳號。完成後點選 **套用** 本頁面設定。

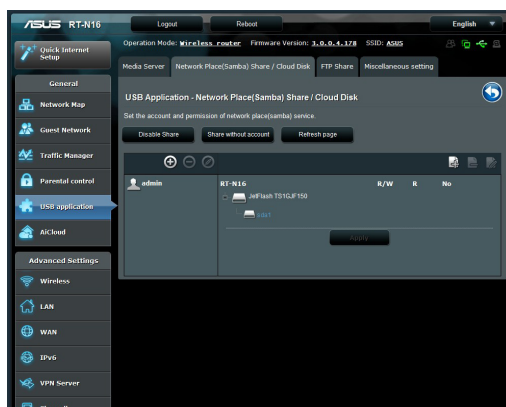

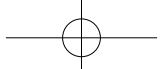

## 建立 FTP 檔案分享區

### 透過 FTP 伺服器分享檔案

您可以使用華碩無線路由器透過網際網路與 LAN 中的電腦分享 USB 儲存裝置中的檔案。



**重要：**要使用這一功能，您需要在無線路由器後面板的 USB2.0 連接埠上插入一個 USB 儲存裝置，如 USB 硬碟或 USB 隨身碟。請確認 USB 儲存裝置被格式化並適當分割磁區。請造訪華碩網站 <http://event.asus.com/networks/>



**注意：**請確認您已安全移除 USB 隨身碟。錯誤的移除方式可能會造成資料毀損或遺失。

請依照以下步驟透過 FTP 伺服器分享檔案：

1. 請確認您已經透過 AiDisk 設定了 FTP 伺服器。
2. 開啟 DDNS 服務進行 FTP 伺服器存取。請依照以下步驟操作：
  - a. 在導航選單中，點選 **進階** > **外部網路** > **DDNS**。
  - b. 在 **開啟 DDNS Client?** 欄位中勾選 **Yes**。
  - c. 輸入您的 **用戶名稱或 E-mail 帳號** 與 **密碼**或 **DDNS 金鑰**。
  - d. 輸入您的 **主機位置**，格式應為 **xxx.asuscomm.com**，xxx 表示您的 FTP 主機名稱。
  - e. 完成後點選 **套用本頁面設定**。
3. 點選導航選單中的 **進階設定** > **USB 應用程式** > **FTP 分享磁碟**，選擇您欲設定存取權限的帳號。

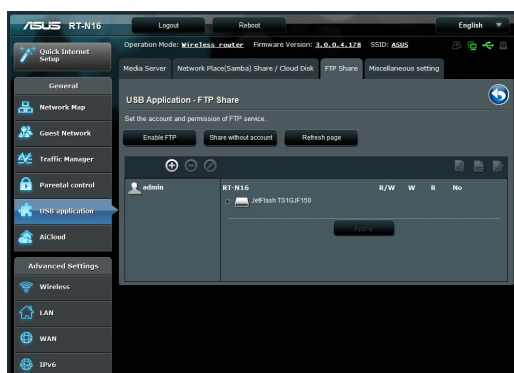

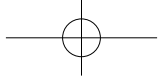

4. 在檔案/資料夾清單中，選擇您欲設定的存取權限：
  - R/W：對檔案/資料夾有讀取 / 寫入的權限。
  - W：對檔案/資料夾僅有寫入的權限。
  - R：對檔案/資料夾僅有讀取的權限。
  - No：無法分享此檔案/資料夾。
5. 點選 **套用本頁面設定** 套用所有設定。
6. 欲進入 FTP 伺服器，輸入 ftp 鏈接 `ftp://<hostname>.asuscomm.com` 並在一個網頁瀏覽器上輸入您的使用者名稱與密碼或第三方 FTP 應用程式。

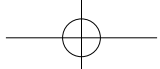

## 使用其它設定

其它設定允許您進行其他 USB 碟相關設定，包括最多登入使用者、裝置名稱、工作組與 FTP 伺服器上的語言。

請按照以下步驟進行其它設定：

1. 在 **UPnP 媒體伺服器** 點選 **其他設定**。
2. 按照指示輸入所需資訊。
3. 完成後點選 **套用本頁面設定**。

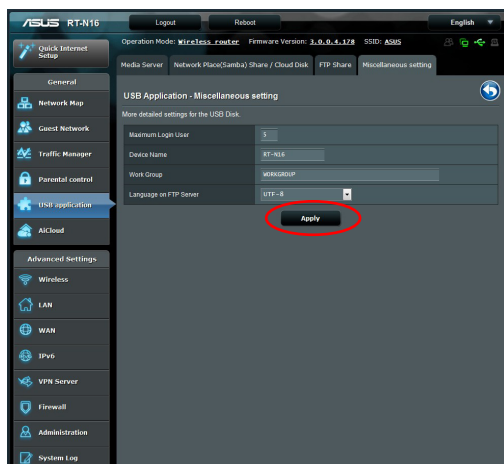

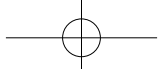

## 進階設定

進階設定允許您設定您的無線路由器的進階功能。

### 設定 DHCP 伺服器

華碩路由器內建 DHCP 伺服器功能，當系統開啟時，它將自動指定 IP 位址到網路中的用戶端。



注意：華碩無線路由器可為您的網路支援多達 253 個 IP 位址。

請依照以下步驟設定 DHCP 伺服器：

1. 在畫面左邊的導航選單裡點選 **進階設定**。
2. 在 **內部網路** 選單中點選 **DHCP 伺服器**。

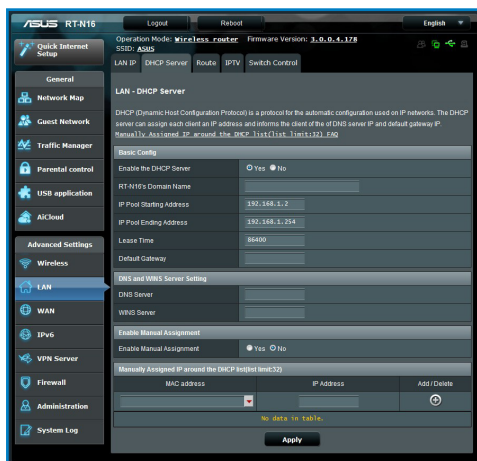

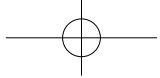

3. 在 **啟用 DHCP 伺服器？** 項目中勾選 **是**。
4. 在 **IP Pool 起始位置** 項目中輸入起始 IP 位址。
5. 在 **IP Pool 結束位置** 項目中輸入結束 IP 位址。
6. 在 **租約時間** 項目中輸入 IP 位址租約時間，無線路由器將會自動為網路用戶端指定一個新的 IP 位址。



**重要！**

- 若您想設定 IP Pool 啟始與結束 IP 位址，建議您使用如下設定：
  - **IP 位址：** 192.168.1.xxx (xxx 可為 2 至 254 之間的數字)。
- IP Pool 啟始位址不可大於 IP Pool 結束位址。

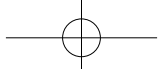

## 韌體更新



注意：請造訪華碩網站 (<http://tw.asus.com>) 下載最新韌體。

請依照以下步驟進行韌體更新：

1. 點選螢幕左邊導航選單中的 **進階設定**。
2. 點選 **系統管理** 選單下的 **韌體更新**。
3. 在 **新韌體更新** 中點選 **瀏覽**，開啟您要更新的韌體檔案。
4. 點選 **上傳**，過程將需要大約三分鐘。

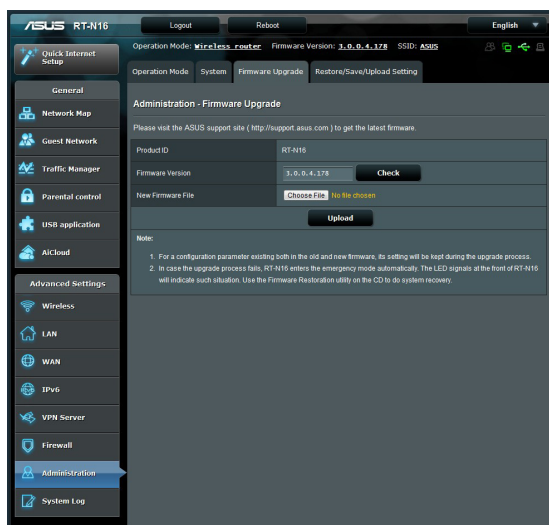

注意：如果更新程式失敗，無線路由器將自動進入救援模式，並且前面板上的電源 LED 指示燈緩慢閃爍。請使用 **Firmware Restoration** 應用程式還原系統。

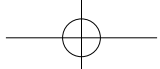

## 還原 / 匯出 / 上傳設定

請依照以下步驟進行 還原 / 匯出 / 上傳設定：

1. 點選螢幕左邊導航選單中的 進階設定。

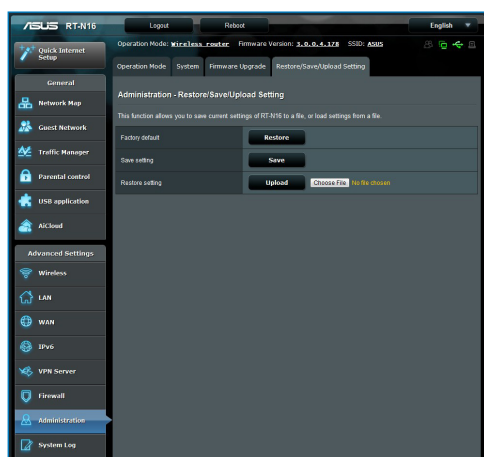

2. 點選 系統管理 選單下的 還原 / 匯出 / 上傳設定。
3. 選擇您想要進行的操作：
  - 想還原為原廠預設設定，點選 **還原**，然後按下確認訊息中的 **確定**。
  - 想匯出現有系統設定，點選 **儲存**，然後點選檔案下載視窗中的 **儲存** 將您的系統檔案儲存在您想要儲存的位置下。
  - 想還原系統設定，點選 **瀏覽** 開啟您欲還原的系統檔案，然後按下 **上傳**。



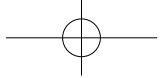

## 網路印表機設定

網路印表機設定程式允許您設定連接在無線路由器上的 USB 印表機，並允許您網路內的用戶端使用 USB 印表機。



### 注意：

- 請檢查您的 USB 印表機是否相容於您的路由器，請造訪 <http://event.asus.com/networks/printersupport> 獲取Plug-n-Share 磁碟支援列表。
- Windows® 2000 不支援無線路由器印表機功能。

請依照以下步驟設定 USB 印表機：

1. 執行驅動程式與應用程式光碟中的 **ASUS Wireless Utilities**，點選 **執行網路印表機設定程式**。
2. 在 **ASUS EZ 印表機分享模式**中點選 **Download Now!**，下載網路印表機程式。

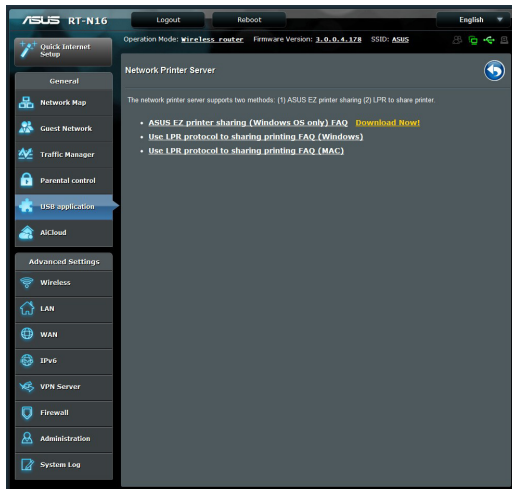

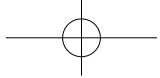

3. 解壓縮下載的檔案，並點選印表機圖示以運作網路印表機設定程式。
4. 請依照螢幕上的指示設定硬體裝置，接著點選 下一步。

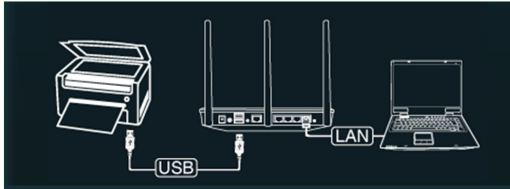

5. 等待初始設定完成。按 下一步。



6. 按下 **完成** 完成安裝。



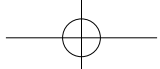

7. 請依照 Windows® 作業系統的指示安裝印表機。



8. 硬體設定完成後，網路用戶端就可以使用印表機。

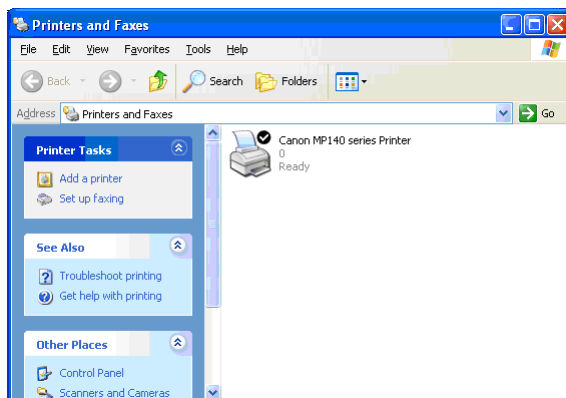

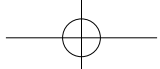

## 第四章：使用華碩應用程式



注意：

- 使用附贈的驅動程式與公用程式光碟安裝華碩無線路由器的應用程式。
- 若未開啟自動播放功能，請執行驅動程式與公用程式光碟根目錄中的 `setup.exe`。

### 偵測裝置 ( Device Discovery )

Device Discovery 是一款華碩 WLAN 應用程式，可以偵測到一個華碩無線路由器裝置，並且允許您設定該裝置。

請依照以下步驟開啟 Device Discovery 應用程式：

- 在您的電腦桌面上選擇 **開始** > 程式集 > ASUS Utility > RT-N16 Wireless Router > Device Discovery。



注意：當您將路由器設定為無線基地台模式 ( AP mode ) 時，您需要使用 Device Discovery 來獲取 IP 位址。

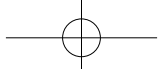

## 韌體回復 (Firmware Restoration)

Firmware Restoration 應用程式用於在韌體更新失敗時，還原或上傳您指定的韌體。此過程需要 3 至 4 分鐘。



**重要：** 在使用 Firmware Restoration 之前，請啟動救援模式。

請依照以下步驟開啟救援模式並使用 Firmware Restoration 應用程式：

1. 拔掉無線路由器上的電源。
2. 持續按住後面板上的 Restore 按鈕，同時把路由器重新接上電源。當前面板上的電源指示燈開始慢閃時，放開按鈕。此時，路由器已進入救援模式。
3. 使用以下方式設定您的 TCP/IP：  
IP 位址：192.168.1.x  
子網路遮罩：255.255.255.0
4. 在您的電腦桌面上選擇 **開始 > 程式集 > ASUS Utility > RT-N16 Wireless Router > Firmware Restoration**。

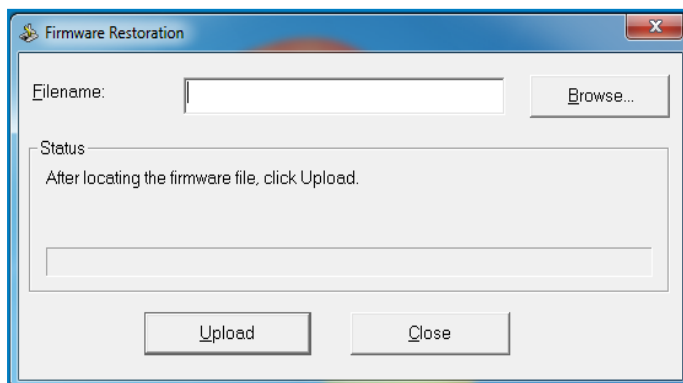

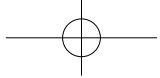

5. 選擇韌體檔案，然後點選 **上載**。



**注意：** Firmware Restoration 不是韌體更新應用程式，並且不能用於正在運作的華碩無線路由器上。正常韌體更新應該在網頁圖形介面中完成，詳細訊息請參考「第三章：使用網頁圖形介面進行設定」。

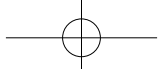

## 第五章：疑難排解



注意：若有無法自行解決的疑難或本章節未提及問題，請聯絡華碩技術支援。

### 疑難排解

#### 無法存取網路瀏覽器進行路由器設定。

- 移除網頁瀏覽器中的 cookies 與檔案。請按照以下步驟執行：
1. 開啟網路瀏覽器，然後點選 **工具** > **網際網路選項**。
  2. 在臨時檔案中點選 **刪除 Cookies**。



依網路瀏覽器不同，刪除 Cookies 與檔案的指令也會不同。

- 關閉代理伺服器設定，取消撥號連接，並設定 TCP/IP 自動獲取 IP 位址。更多資訊請參考「**開始設定之前**」部份的內容。

#### 無法建立無線網路連線。

##### 1. 超出有效範圍：

- 請將路由器放置於較靠近用戶端裝置之處。
- 嘗試進行頻道設定的變更。

##### 2. 認證問題：

- 請使用採用有線連線的電腦來連接路由器。
- 檢查網路安全設定。
- 您可以嘗試按路由器後方的重置 (Restore) 按鈕超過 5 秒鐘後，進行硬體重置 (hard reset) 的動作。

##### 3. 無法搜尋到路由器：

- 您可以嘗試按路由器後方的重置 (Restore) 按鈕超過 5 秒鐘後，進行硬體重置 (hard reset) 的動作。
- 檢查無線網路卡上的 SSID 與加密等設定。

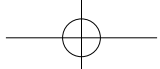

### 無法透過無線網路卡來連線至網際網路。

- 請將路由器更換至用戶端可以連線到的範圍內。
- 檢查您所使用的無線網路卡是否有連線到正確的路由器。
- 檢查所使用的無線網路頻道是符合您的所在地區/國家所規範的頻道。
- 檢查加密設定。
- 檢查您所使用的 ADSL 或 Cable Modem 是否有連接至正確的網路埠。
- 重新更換另一條乙太網路線來連接。

### 無法進入網際網路。

- 請檢查 ADSL 數據機與無線路由器上的 LED 燈所顯示的訊號是否正確。
- 請檢查 WAN 燈號在路由器上是否有亮。若燈號沒有顯示亮著 (on) 的狀態，請檢查連接兩者的網路線，並再重新測試一遍。

### 當 ADSL 數據機「Link」(連線)的燈號亮著(不是閃爍)，這表示已經可以連線至網際網路。

- 重新啟動您的電腦。
- 重新設定華碩路由器，請參考快速使用指南。
- 檢查 WAN LED 訊號燈是否亮著。
- 檢查無線網路加密的設定。
- 檢查欲與路由器連線的電腦是否能取得 IP 位址(經由有線網路與無線網路兩者是否皆可)。
- 檢查您的網路瀏覽器(如 IE)是否設定為採用區域網路，並且不採用代理伺服器(Proxy)。



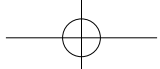

當 ADSL 數據機「Link」（連線）的燈號持續閃爍或熄滅，這表示無法存取至網際網路 - 路由器無法與 ADSL 網路建立連線。

- 請確認網路線已有正確連接。
- 請將 ADSL 或 cable modem 的電源線拔除，並等待幾分鐘後，再重新接上電源。
- 若 ADSL 數據機燈號持續閃爍或為熄滅（顯示OFF）的狀態，請與您的網路電信業者聯絡。

忘記網路名稱或金鑰密碼。

- 試著再次透過有線連接來設定無線的加密動作。
- 按下位於路由器後方的重置（Restore）按鈕超過5秒鐘後，進行硬體重置（hard reset）的動作。

如何回復到預設值？

- 按住在路由器上的 Restore（重置）鈕超過 5秒鐘。
- 請參考第三章中的 還原/匯出/上傳設定 部份的說明。

以下為原廠預設值：

使用者名稱：admin

密碼：admin

啟用 DHCP：Yes（如果已連接 WAN 網路線）

IP 位址：192.168.1.1

網域名稱：（空白）

子網路遮罩：255.255.255.0

DNS 伺服器 1：192.168.1.1

DNS 伺服器 2：（空白）

SSID：ASUS

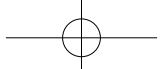

## 華碩 DDNS 服務

RT-N65R 是第一款支援華碩 DDNS 服務的產品。當您在服務中心更換裝置時，若您已註冊華碩 DDNS 服務，並想要保留網域名稱，就必須進行資料傳輸。請諮詢當地服務中心了解詳細資訊。



### 注意：

若在網域中沒有活動 ---- 如重新設定路由器或存取註冊的網域名稱 ---- 90 天內，系統自動刪除註冊資料。

在使用過程中若您碰到任何問題，請連絡服務中心。

## 常見問題解答 (FAQs)

### 1. 註冊資料會丟失或被其它人使用嗎？

若您 90 天內沒有更新註冊資料，系統自動刪除註冊資料，網域名稱可能會被其它人使用。

### 2. 6 個月前我購買了路由器，但沒有註冊華碩 DDNS 服務。現在我還可以註冊嗎？

您仍可以註冊華碩 DDNS 服務。DDNS 服務內建在您的路由器中，所以您可以隨時註冊。在註冊前，點選 **Query** 查詢主機名稱是否已被註冊。若沒有，系統會自動進行註冊。

### 3. 我以前註冊過一個網域名稱，並且能正常使用，後來我的朋友說無法存取我的網域名稱了，為什麼？

請確認：

1. 網際網路連線正常。
2. DNS 伺服器工作正常。
3. 最近 90 天內更新過網域名稱。

若仍不能存取您的網域名稱，請連絡服務中心。

### 4. 我是否可以註冊二個網域名稱，分開存取 http 與 ftp 伺服器？

不可以。一台路由器只可註冊一個網域名稱。您可使用連接埠映射 (Port Mapping) 進行網路安全設定。

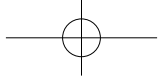

5. 重新啟動路由器後，為什麼在路由器設定畫面與 MS DOS 中會看到不同的 WAN IP？

這是正常的。ISP DNS 伺服器與華碩 DDNS 的更新間隔時間不同導致在路由器設定畫面與 MS DOS 中出現不同的 WAN IP。不同的 ISP 會有不同的 IP 更新間隔時間。

6. 華碩 DDNS 服務是免費的嗎？它只是個試用版本嗎？

華碩 DDNS 服務是免費的，一些華碩路由器中內建 DDNS 服務。請確認您的華碩路由器是否支援 DDNS 服務。

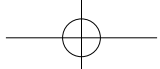

## 附錄

### Notices

#### ASUS Recycling/Takeback Services

ASUS recycling and takeback programs come from our commitment to the highest standards for protecting our environment. We believe in providing solutions for you to be able to responsibly recycle our products, batteries, other components, as well as the packaging materials. Please go to <http://csr.asus.com/english/Takeback.htm> for the detailed recycling information in different regions.

#### REACH

注意：謹遵守REACH(Registration, Evaluation, Authorisation, and Restriction of Chemicals)管理規範，我們會將產品中的化學物質公告在華碩 REACH 網站，詳細請參考 <http://green.asus.com/english/REACH.htm>

#### Federal Communications Commission Statement

This device complies with Part 15 of the FCC Rules. Operation is subject to the following two conditions:

- This device may not cause harmful interference.
- This device must accept any interference received, including interference that may cause undesired operation.

This equipment has been tested and found to comply with the limits for a class B digital device, pursuant to part 15 of the FCC Rules. These limits are designed to provide reasonable protection

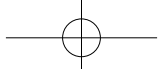

against harmful interference in a residential installation.

This equipment generates, uses and can radiate radio frequency energy and, if not installed and used in accordance with the instructions, may cause harmful interference to radio communications. However, there is no guarantee that interference will not occur in a particular installation. If this equipment does cause harmful interference to radio or television reception, which can be determined by turning the equipment off and on, the user is encouraged to try to correct the interference by one or more of the following measures:

- Reorient or relocate the receiving antenna.
- Increase the separation between the equipment and receiver.
- Connect the equipment into an outlet on a circuit different from that to which the receiver is connected.
- Consult the dealer or an experienced radio/TV technician for help.



---

**IMPORTANT!** This device within the 5.15 ~ 5.25 GHz is restricted to indoor operations to reduce any potential for harmful interference to co-channel MSS operations.

---



---

**Caution:** Any changes or modifications not expressly approved by the party responsible for compliance could void the user's authority to operate the equipment.

---

### Prohibition of Co-location

This device and its antenna(s) must not be co-located or operating in conjunction with any other antenna or transmitter

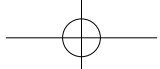

## Safety Information

To maintain compliance with FCC's RF exposure guidelines, this equipment should be installed and operated with minimum distance 20cm between the radiator and your body. Use on the supplied antenna.

## Declaration of Conformity for R&TTE directive 1999/5/EC

Essential requirements – Article 3

Protection requirements for health and safety – Article 3.1a

Testing for electric safety according to EN 60950-1 has been conducted. These are considered relevant and sufficient.

Protection requirements for electromagnetic compatibility – Article 3.1b

Testing for electromagnetic compatibility according to EN 301 489-1 and EN 301 489-17 has been conducted. These are considered relevant and sufficient.

Effective use of the radio spectrum – Article 3.2

Testing for radio test suites according to EN 300 328- 2 has been conducted. These are considered relevant and sufficient.

## CE Mark Warning

This is a Class B product, in a domestic environment, this product may cause radio interference, in which case the user may be required to take adequate measures.

## Canada, Industry Canada (IC) Notices

This Class B digital apparatus complies with Canadian ICES-003

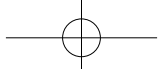

and RSS-210.

Operation is subject to the following two conditions: (1) this device may not cause interference, and (2) this device must accept any interference, including interference that may cause undesired operation of the device.

## Radio Frequency (RF) Exposure Information

The radiated output power of the ASUS Wireless Device is below the Industry Canada (IC) radio frequency exposure limits. The Dell Wireless Device should be used in such a manner such that the potential for human contact during normal operation is minimized.

This device has been evaluated for and shown compliant with the IC Specific Absorption Rate ("SAR") limits when installed in specific host products operated in portable exposure conditions (antennas are less than 20 centimeters of a person's body).

This device has been certified for use in Canada. Status of the listing in the Industry Canada's REL (Radio Equipment List) can be found at the following web address: <http://www.ic.gc.ca/app/sitt/relet/srch/nwRdSrch.do?lang=eng>

Additional Canadian information on RF exposure also can be found at the following web: <http://www.ic.gc.ca/eic/site/smt-gst.nsf/eng/sf08792.html>

## Canada, avis d'Industry Canada (IC)

Cet appareil numérique de classe B est conforme aux normes canadiennes ICES-003 et RSS-210.

Son fonctionnement est soumis aux deux conditions suivantes: (1) cet appareil ne doit pas causer d'interférence et (2) cet appareil

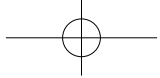

doit accepter toute interférence, notamment les interférences qui peuvent affecter son fonctionnement.

## GNU General Public License

### Licensing information

This product includes copyrighted third-party software licensed under the terms of the GNU General Public License. Please see The GNU General Public License for the exact terms and conditions of this license. We include a copy of the GPL with every CD shipped with our product. All future firmware updates will also be accompanied with their respective source code. Please visit our web site for updated information. Note that we do not offer direct support for the distribution.

## GNU GENERAL PUBLIC LICENSE

Version 2, June 1991

Copyright (C) 1989, 1991 Free Software Foundation, Inc.

59 Temple Place, Suite 330, Boston, MA 02111-1307 USA

Everyone is permitted to copy and distribute verbatim copies of this license document, but changing it is not allowed.



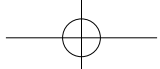

## Preamble

The licenses for most software are designed to take away your freedom to share and change it. By contrast, the GNU General Public License is intended to guarantee your freedom to share and change free software--to make sure the software is free for all its users. This General Public License applies to most of the Free Software Foundation's software and to any other program whose authors commit to using it. (Some other Free Software Foundation software is covered by the GNU Library General Public License instead.) You can apply it to your programs, too.

When we speak of free software, we are referring to freedom, not price. Our General Public Licenses are designed to make sure that you have the freedom to distribute copies of free software (and charge for this service if you wish), that you receive source code or can get it if you want it, that you can change the software or use pieces of it in new free programs; and that you know you can do these things.

To protect your rights, we need to make restrictions that forbid anyone to deny you these rights or to ask you to surrender the rights. These restrictions translate to certain responsibilities for you if you distribute copies of the software, or if you modify it.

For example, if you distribute copies of such a program, whether gratis or for a fee, you must give the recipients all the rights that you have. You must make sure that they, too, receive or can get the source code. And you must show them these terms so they know their rights.

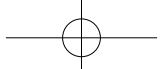

We protect your rights with two steps: (1) copyright the software, and (2) offer you this license which gives you legal permission to copy, distribute and/or modify the software.

Also, for each author's protection and ours, we want to make certain that everyone understands that there is no warranty for this free software. If the software is modified by someone else and passed on, we want its recipients to know that what they have is not the original, so that any problems introduced by others will not reflect on the original authors' reputations.

Finally, any free program is threatened constantly by software patents. We wish to avoid the danger that redistributors of a free program will individually obtain patent licenses, in effect making the program proprietary. To prevent this, we have made it clear that any patent must be licensed for everyone's free use or not licensed at all.

The precise terms and conditions for copying, distribution and modification follow.

### Terms & conditions for copying, distribution, & modification

0. This License applies to any program or other work which contains a notice placed by the copyright holder saying it may be distributed under the terms of this General Public License. The "Program", below, refers to any such program or work, and a "work based on the Program" means either the Program or any derivative work under copyright law: that is to say, a work containing the Program or a portion of it, either verbatim or with modifications and/or translated into another language. (Hereinafter, translation is included without limitation in the term "modification".) Each licensee is addressed as "you".

Activities other than copying, distribution and modification are not covered by this License; they are outside its scope. The act of running the Program is not restricted, and the output from the Program is covered only if its contents constitute a work based on the Program (independent of having been made by running the Program). Whether that is true depends on what the Program does.

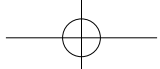

1. You may copy and distribute verbatim copies of the Program's source code as you receive it, in any medium, provided that you conspicuously and appropriately publish on each copy an appropriate copyright notice and disclaimer of warranty; keep intact all the notices that refer to this License and to the absence of any warranty; and give any other recipients of the Program a copy of this License along with the Program.

You may charge a fee for the physical act of transferring a copy, and you may at your option offer warranty protection in exchange for a fee.

2. You may modify your copy or copies of the Program or any portion of it, thus forming a work based on the Program, and copy and distribute such modifications or work under the terms of Section 1 above, provided that you also meet all of these conditions:

- a) You must cause the modified files to carry prominent notices stating that you changed the files and the date of any change.
- b) You must cause any work that you distribute or publish, that in whole or in part contains or is derived from the Program or any part thereof, to be licensed as a whole at no charge to all third parties under the terms of this License.
- c) If the modified program normally reads commands interactively when run, you must cause it, when started running for such interactive use in the most ordinary way, to print or display an announcement including an appropriate copyright notice and a notice that there is no warranty (or else, saying that you provide a warranty) and that users may redistribute the program under these conditions, and telling the user how to view a copy of this License. (Exception: if the Program itself is interactive but does not normally print such an announcement, your work based on the Program is not required to print an announcement.)

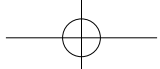

These requirements apply to the modified work as a whole. If identifiable sections of that work are not derived from the Program, and can be reasonably considered independent and separate works in themselves, then this License, and its terms, do not apply to those sections when you distribute them as separate works. But when you distribute the same sections as part of a whole which is a work based on the Program, the distribution of the whole must be on the terms of this License, whose permissions for other licensees extend to the entire whole, and thus to each and every part regardless of who wrote it.

Thus, it is not the intent of this section to claim rights or contest your rights to work written entirely by you; rather, the intent is to exercise the right to control the distribution of derivative or collective works based on the Program.

In addition, mere aggregation of another work not based on the Program with the Program (or with a work based on the Program) on a volume of a storage or distribution medium does not bring the other work under the scope of this License.

3. You may copy and distribute the Program (or a work based on it, under Section 2) in object code or executable form under the terms of Sections 1 and 2 above provided that you also do one of the following:
  - a) Accompany it with the complete corresponding machine-readable source code, which must be distributed under the terms of Sections 1 and 2 above on a medium customarily used for software interchange; or,
  - b) Accompany it with a written offer, valid for at least three years, to give any third party, for a charge no more than your cost of physically performing source distribution, a complete machine-readable copy of the corresponding source code, to be distributed under the terms of Sections 1 and 2 above on a medium customarily used for software interchange; or,

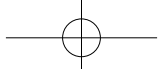

- c) Accompany it with the information you received as to the offer to distribute corresponding source code. (This alternative is allowed only for noncommercial distribution and only if you received the program in object code or executable form with such an offer, in accord with Subsection b above.)

The source code for a work means the preferred form of the work for making modifications to it. For an executable work, complete source code means all the source code for all modules it contains, plus any associated interface definition files, plus the scripts used to control compilation and installation of the executable. However, as a special exception, the source code distributed need not include anything that is normally distributed (in either source or binary form) with the major components (compiler, kernel, and so on) of the operating system on which the executable runs, unless that component itself accompanies the executable.

If distribution of executable or object code is made by offering access to copy from a designated place, then offering equivalent access to copy the source code from the same place counts as distribution of the source code, even though third parties are not compelled to copy the source along with the object code.

4. You may not copy, modify, sublicense, or distribute the Program except as expressly provided under this License. Any attempt otherwise to copy, modify, sublicense or distribute the Program is void, and will automatically terminate your rights under this License. However, parties who have received copies, or rights, from you under this License will not have their licenses terminated so long as such parties remain in full compliance.
5. You are not required to accept this License, since you have not signed it. However, nothing else grants you permission to modify or distribute the Program or its derivative works. These actions are prohibited by law if you do not accept this License. Therefore, by modifying or distributing the Program (or any work based on the Program), you indicate your acceptance of this License to do so, and all its terms and conditions for copying, distributing or modifying the Program or works based on it.

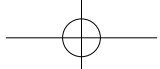

6. Each time you redistribute the Program (or any work based on the Program), the recipient automatically receives a license from the original licensor to copy, distribute or modify the Program subject to these terms and conditions. You may not impose any further restrictions on the recipients' exercise of the rights granted herein. You are not responsible for enforcing compliance by third parties to this License.
  
7. If, as a consequence of a court judgment or allegation of patent infringement or for any other reason (not limited to patent issues), conditions are imposed on you (whether by court order, agreement or otherwise) that contradict the conditions of this License, they do not excuse you from the conditions of this License. If you cannot distribute so as to satisfy simultaneously your obligations under this License and any other pertinent obligations, then as a consequence you may not distribute the Program at all. For example, if a patent license would not permit royalty-free redistribution of the Program by all those who receive copies directly or indirectly through you, then the only way you could satisfy both it and this License would be to refrain entirely from distribution of the Program.

If any portion of this section is held invalid or unenforceable under any particular circumstance, the balance of the section is intended to apply and the section as a whole is intended to apply in other circumstances.

It is not the purpose of this section to induce you to infringe any patents or other property right claims or to contest validity of any such claims; this section has the sole purpose of protecting the integrity of the free software distribution system, which is implemented by public license practices. Many people have made generous contributions to the wide range of software distributed through that system in reliance on consistent application of that system; it is up to the author/donor to decide if he or she is willing to distribute software through any other system and a licensee cannot impose that choice.

This section is intended to make thoroughly clear what is believed to be a consequence of the rest of this License.

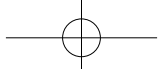

8. If the distribution and/or use of the Program is restricted in certain countries either by patents or by copyrighted interfaces, the original copyright holder who places the Program under this License may add an explicit geographical distribution limitation excluding those countries, so that distribution is permitted only in or among countries not thus excluded. In such case, this License incorporates the limitation as if written in the body of this License.

9. The Free Software Foundation may publish revised and/or new versions of the General Public License from time to time. Such new versions will be similar in spirit to the present version, but may differ in detail to address new problems or concerns.

Each version is given a distinguishing version number. If the Program specifies a version number of this License which applies to it and “any later version”, you have the option of following the terms and conditions either of that version or of any later version published by the Free Software Foundation. If the Program does not specify a version number of this License, you may choose any version ever published by the Free Software Foundation.

10. If you wish to incorporate parts of the Program into other free programs whose distribution conditions are different, write to the author to ask for permission.

For software which is copyrighted by the Free Software Foundation, write to the Free Software Foundation; we sometimes make exceptions for this. Our decision will be guided by the two goals of preserving the free status of all derivatives of our free software and of promoting the sharing and reuse of software generally.

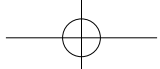

## NO WARRANTY

11 BECAUSE THE PROGRAM IS LICENSED FREE OF CHARGE, THERE IS NO WARRANTY FOR THE PROGRAM, TO THE EXTENT PERMITTED BY APPLICABLE LAW. EXCEPT WHEN OTHERWISE STATED IN WRITING THE COPYRIGHT HOLDERS AND/OR OTHER PARTIES PROVIDE THE PROGRAM "AS IS" WITHOUT WARRANTY OF ANY KIND, EITHER EXPRESSED OR IMPLIED, INCLUDING, BUT NOT LIMITED TO, THE IMPLIED WARRANTIES OF MERCHANTABILITY AND FITNESS FOR A PARTICULAR PURPOSE. THE ENTIRE RISK AS TO THE QUALITY AND PERFORMANCE OF THE PROGRAM IS WITH YOU. SHOULD THE PROGRAM PROVE DEFECTIVE, YOU ASSUME THE COST OF ALL NECESSARY SERVICING, REPAIR OR CORRECTION.

12 IN NO EVENT UNLESS REQUIRED BY APPLICABLE LAW OR AGREED TO IN WRITING WILL ANY COPYRIGHT HOLDER, OR ANY OTHER PARTY WHO MAY MODIFY AND/OR REDISTRIBUTE THE PROGRAM AS PERMITTED ABOVE, BE LIABLE TO YOU FOR DAMAGES, INCLUDING ANY GENERAL, SPECIAL, INCIDENTAL OR CONSEQUENTIAL DAMAGES ARISING OUT OF THE USE OR INABILITY TO USE THE PROGRAM (INCLUDING BUT NOT LIMITED TO LOSS OF DATA OR DATA BEING RENDERED INACCURATE OR LOSSES SUSTAINED BY YOU OR THIRD PARTIES OR A FAILURE OF THE PROGRAM TO OPERATE WITH ANY OTHER PROGRAMS), EVEN IF SUCH HOLDER OR OTHER PARTY HAS BEEN ADVISED OF THE POSSIBILITY OF SUCH DAMAGES.

END OF TERMS AND CONDITIONS



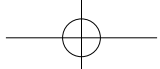

## 華碩的連絡資訊

### 華碩電腦公司 ASUSTeK COMPUTER INC. (台灣)

#### 市場訊息

地址：台灣台北市北投區立德路15號

電話：+886-2-2894-3447

傳真：+886-2-2890-7798

電子郵件：info@asus.com.tw

全球資訊網：http://tw.asus.com

#### 技術支援

電話：+886-2-2894-3447

(0800-093-456)

線上支援：<http://support.asus.com/techserv/techserv.aspx>

### 華碩電腦公司 ASUSTeK COMPUTER INC. (亞太地區)

#### 市場訊息

地址：台灣台北市北投區立德路15號

網址：<http://www.asus.com,tw>

#### 技術支援

電話：+886228943447

傳真：+886228907689

軟體下載：[support.asus.com\\*](http://support.asus.com)

### ASUS COMPUTER INTERNATIONAL (美國)

#### 市場訊息

地址：800 Corporate Way, Fremont,  
California 94539, USA

電話：+15029550883

傳真：+15029338713

網址：<http://usa.asus.com>

軟體下載：[support.asus.com](http://support.asus.com)

### ASUS COMPUTER GmbH (德國/奧地利)

#### 市場訊息

地址：Harkort Str. 25, D-40880  
Ratingen, Germany

電話：+49-2102-95990

傳真：+49-2102-959911

線上連絡：<http://www.asus.com.de/sales>

#### 技術支援

電話：+49-2102-95990

傳真：+49-2102-959911

線上支援：<http://www.asus.com.de/support>

網址：<http://www.asus.com.de/news>

\* 您可填寫線上技術支援表取得線上技術支援。

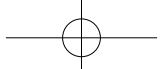

## 全球網路熱線資訊

Area	Hotline Number	Support Languages	Working Hour	Working Day
Australia	1300-2787-88	English	9:00-18:00	Mon. to Fri.
Austria	0043-820240513	German	9:00-18:00	Mon. to Fri.
Belgium	0032-78150231	Dutch /French	9:00-17:00	Mon. to Fri.
China	400-620-6655; 020-28047506	Simplified Chinese	9:00-18:00	Mon. to Sun.
Denmark	0045-3832-2943	Denish/English	9:00-17:00	Mon. to Fri.
Finland	00358-9693-7969	Finnish/ English/ Swedish	10:00-18:00	Mon. to Fri.
France	0033-170949400	France	9:00-17:45	Mon. to Fri.
Greece	00800-44-14-20-44	Greek	9:00-13:00; 14:00-18:00	Mon. to Fri.
Hong Kong	3582-4770	Cantonese/ Chinese/ English	10:00-20:00	Mon. to Fri.
			10:00-17:00	Sat.
Ireland	0035-31890719918	English	9:00-17:00	Mon. to Fri.
Japan	0800-123-2787	Japanese	9:00-18:00	Mon. to Fri.
			9:00-17:00	Sat. to Sun.
Malaysia	+603 2148 0827 (Check Repair Detail Status Only) +603-6279-5077	Bahasa Melayu/ English	10:00-19:00	Mon. to Fri.
Netherlands / Luxembourg	0031-591-570290	Dutch / English	9:00-17:00	Mon. to Fri.
New Zealand	0800-278-788 / 0800-278-778	English	9:00-17:00	Mon. to Fri.
Norway	0047-2316-2682	Norwegian /English	9:00-17:00	Mon. to Fri.
Philippine	+632-636 8504; 180014410573	English	9:00-18:00	Mon. to Fri.
Poland	00225-718-033	Polish	9:00-17:00	Mon. to Fri.
	00225-718-040		8:30-17:30	
Portugal	707-500-310	Portuguese	9:00-17:00	Mon. to Fri.

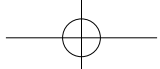

## 全球網路熱線資訊

Area	Hotline Number	Support Languages	Working Hour	Working Day
Russia	+8-800-100-ASUS; +7-495-231-1999	Russian/ English	9:00-18:00	Mon. to Fri.
Singapore	+65-6720-3835 (Check Repair Detail Status Only) -66221701	English	11:00-19:00	Mon. to Fri.
Slovak	00421-232-162-621	Czech	8:00-17:00	Mon. to Fri.
Spain	902-88-96-88	Spanish	9:00-18:00	Mon. to Fri.
Sweden	0046-8587-6940	Swedish/ English	9:00-17:00	Mon. to Fri.
Switzerland	0041-848111010	German/ French	9:00-18:00	Mon. to Fri.
	0041-848111014	French	9:00-17:45	Mon. to Fri.
	0041-848111012	Italian	9:00-17:00	Mon. to Fri.
Taiwan	0800-093-456; 02-81439000	Traditional Chinese	9:00-12:00; 13:30-18:00	Mon. to Fri.
Thailand	+662-679-8367 -70; 001 800 852 5201	Thai/English	9:00-18:00	Mon. to Fri.
Turkey	+90-216-524-3000	Turkish	09:00-18:00	Mon. to Fri.
United Kingdom	0044-870-1208340; 0035-31890719918	English	9:00-17:00	Mon. to Fri.
USA/Canada	1-812-282-2787	English	8:30-12:00am EST	Mon. to Fri.
			(5:30am- 9:00pm PST)	
			9:00am-6:00pm EST	Sat. to Sun.
			(6:00am- 3:00pm PST)	



注意：更多資訊請登入華碩技術支援網站 <http://support.asus.com>。

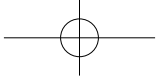

<b>Manufacturer:</b>	<b>ASUSTeK Computer Inc.</b> Tel: +886-2-2894-3447 Address: No. 150, LI-TE RD., PEITOU, TAIPEI 112, TAIWAN
<b>Authorised representative in Europe:</b>	<b>ASUS Computer GmbH</b> Address: HARKORT STR. 21-23, 40880 RATINGEN, GERMANY
<b>Authorised distributors in Turkey:</b>	<b>BOGAZICI BIL GISAYAR SAN. VE TIC. A.S.</b> Tel: +90 212 3311000 Address: AYAZAGA MAH. KEMERBURGAZ CAD. NO.10 AYAZAGA/ISTANBUL
	<b>CIZGI Elektronik San. Tic. Ltd. Sti.</b> Tel: +90 212 3567070 Address: CEMAL SURURI CD. HALIM MERIC IS MERKEZI No: 15/C D:5-6 34394 MECIDIYEKOY/ ISTANBUL

EEE Yönetmeliğine Uygundur.